

**PM I I-EC/RAMA
PM I I-EL/RAMA
PM I I-UL/RAMA**

**Rev. A+
Mainboard
User's Manual**

Copyright

This publication contains information that is protected by copyright. No part of it may be reproduced in any form or by any means or used to make any transformation/adaptation without the prior written permission from the copyright holders.

This publication is provided for informational purposes only. The manufacturer makes no representations or warranties with respect to the contents or use of this manual and specifically disclaims any express or implied warranties of merchantability or fitness for any particular purpose. The user will assume the entire risk of the use or the results of the use of this document. Further, the manufacturer reserves the right to revise this publication and make changes to its contents at any time, without obligation to notify any person or entity of such revisions or changes.

© 2002. All Rights Reserved.

Trademarks

Windows® 98, Windows® 98 SE, Windows® ME, Windows® 2000, Windows NT® 4.0 and Windows® XP are registered trademarks of Microsoft Corporation. Intel® and Pentium® 4 are registered trademarks of Intel Corporation. VIA is a registered trademark of VIA Technologies, Inc. Award is a registered trademark of Award Software, Inc. Other trademarks and registered trademarks of products appearing in this manual are the properties of their respective holders.

Caution

To avoid damage to the system:

- Use the correct AC input voltage range.

To reduce the risk of electric shock:

- Unplug the power cord before removing the system chassis cover for installation or servicing. After installation or servicing, cover the system chassis before plugging the power cord.

Battery:

- Danger of explosion if battery incorrectly replaced.
- Replace only with the same or equivalent type recommend by the manufacturer.
- Dispose of used batteries according to the battery manufacturer's instructions.

Joystick or MIDI port:

- Do not use any joystick or MIDI device that requires more than 10A current at 5V DC. There is a risk of fire for devices that exceed this limit.

FCC and DOC Statement on Class B

This equipment has been tested and found to comply with the limits for a Class B digital device, pursuant to Part 15 of the FCC rules. These limits are designed to provide reasonable protection against harmful interference when the equipment is operated in a residential installation. This equipment generates, uses and can radiate radio frequency energy and, if not installed and used in accordance with the instruction manual, may cause harmful interference to radio communications. However, there is no guarantee that interference will not occur in a particular installation. If this equipment does cause harmful interference to radio or television reception, which can be determined by turning the equipment off and on, the user is encouraged to try to correct the interference by one or more of the following measures:

- Reorient or relocate the receiving antenna.
- Increase the separation between the equipment and the receiver.
- Connect the equipment into an outlet on a circuit different from that to which the receiver is connected.
- Consult the dealer or an experienced radio TV technician for help.

Notice:

1. The changes or modifications not expressly approved by the party responsible for compliance could void the user's authority to operate the equipment.
2. Shielded interface cables must be used in order to comply with the emission limits.

Notice

This user's manual contains detailed information about the mainboard. If, in some cases, some information doesn't match those shown in the multilingual manual, the multilingual manual should always be regarded as the most updated version. The multilingual manual is included in the mainboard package.

To view the user's manual, insert the CD into a CD-ROM drive. The autorun screen (Main Board Utility CD) will appear. Click "User's Manual".

Mainboard

This user's manual is for the PM11-EC/RAMA, PM11-EL/RAMA and PM11-UL/RAMA mainboards. The differences between these boards are shown below.

	PM11-EC/RAMA	PM11-EL/RAMA	PM11-UL/RAMA
Onboard Audio (AC'97)	✓	✓	✓
Onboard LAN	✗	✓	✓
USB 2.0	✗	✗	✓
Smart I/O	✗	✗	✓

Table of Contents

Chapter 1 - Introduction

1.1 Features and Specifications.....	7
1.2 Package Checklist.....	14

Chapter 2 - Hardware Installation

2.1 Mainboard Layout	15
2.2 System Memory.....	18
2.3 Jumper Settings for Clearing CMOS Data.....	20
2.4 Jumper Settings for Wake-On-PS/2 Keyboard/Mouse.....	22
2.5 Jumper Settings for Wake-On-USB 2.0 Keyboard/Mouse..	23
2.6 Ports and Connectors.....	24

Chapter 3 - Award BIOS Setup Utility

3.1 The Basic Input/Output System.....	56
3.1.1 Standard CMOS Features.....	56
3.1.2 Advanced BIOS Features.....	60
3.1.3 Advanced Chipset Features	64
3.1.4 Integrated Peripherals.....	69
3.1.5 Power Management Setup.....	75
3.1.6 PnP/PCI Configurations.....	81
3.1.7 PC Health Status.....	84
3.1.8 Frequency/Voltage Control.....	86
3.1.9 Load Fail-Safe Defaults.....	88
3.1.10 Load Optimized Defaults.....	88
3.1.11 Set Supervisor Password.....	89
3.1.12 Set User Password.....	89
3.1.13 Save & Exit Setup.....	90
3.1.14 Exit Without Saving.....	90
3.2 Updating the BIOS.....	90

Chapter 4 - Supported Softwares

4.1 Desktop Management Interface.....	91
4.2 Hardware Monitor.....	94
4.3 VIA Service Pack.....	94
4.4 Audio Drivers and Software Applications.....	96
4.5 Onboard LAN Drivers for Windows.....	96
4.6 Graphics Drivers.....	97
4.7 VIA USB 2.0 Driver.....	97
4.8 Winbond Smart I/O Drivers.....	97
4.9 Winbond SmartCard Application.....	97
4.10 Microsoft DirectX 8.1 Driver.....	98
4.11 Drivers and Utilities Installation Notes.....	98

Appendix A - Using the Suspend to RAM Function

	99
A.1 Using the Suspend to RAM Function.....	

Appendix B - System Error Messages

	103
B.1 POST Beep.....	103
B.2 Error Messages.....	

Appendix C - Troubleshooting

	105
C.1 Troubleshooting Checklist.....	

Chapter I - Introduction

I.1 Features and Specifications

I.1.1 Features

Chipset

- VIA® P4M266/VT8233ACD

Processor

The mainboard is equipped with Socket 478 for installing a Pentium® 4 processor:

- Intel® Pentium® 4 processor (478-pin)
- Supports up to 2.2GHz CPU speed
- 400MHz system data bus

System Memory

- Two 184-pin DDR DIMM sockets
- Supports up to 2GB using PC1600 (DDR200) / PC2100 (DDR266) unbuffered DDR SDRAM DIMM, 2.5V type
- Uses x8/x16 512MB technology

DIMMs	Memory Size	DIMMs	Memory Size
2MBx64	16MB	16MBx64	128MB
4MBx64	32MB	32MBx64	256MB
8MBx64	64MB	64MBx64	512MB

Expansion Slots

The mainboard is equipped with 1 universal AGP slot and 3 PCI slots.

AGP is an interface designed to support high performance 3D graphics cards. It utilizes a dedicated pipeline to access system memory for texturing, z-buffering and alpha blending. The universal AGP slot supports AGP 2x with up to 533MB/sec. bandwidth and AGP 4x with up to 1066MB/sec. bandwidth for 3D graphics applications. AGP in this mainboard will deliver faster and better graphics to your PC.

Onboard Audio Features

- Supports Microsoft® DirectSound/DirectSound 3D
- AC'97 supported with full duplex, independent sample rate converter for audio recording and playback
- S/PDIF compressed digital output

Onboard LAN Features (PMII-EL/RAMA and PMII-UL/RAMA only)

- Uses Realtek RTL8100 fast ethernet controller
- Integrated IEEE 802.3 10BASE-T and 100BASE-TX compatible PHY
- 32-bit PCI master interface
- Integrated power management functions
- Full duplex support at both 10 and 100 Mbps
- Supports IEEE 802.3u auto-negotiation
- Supports wire for management

Onboard Graphics Features

- Full featured Accelerated Graphics Port (AGP) controller
 - AGP specification v2.0 compliant
 - Graphics Address Relocation Table (GART)
- High resolution CRT RGB interface
 - 250MHz RAMDAC on chip with Gamma correction
 - Horizontal/vertical sync outputs compliant with Monitor Power Management protocols

- Integrated Savage4 2D/3D graphics controller and video accelerator
 - Optimized Shared Memory Architecture (SMA)
 - 8/16/32MB frame buffer using system memory
 - Single cycle 128-bit 3D architecture
 - 8M triangles/second setup engine
 - 140M pixels/second tri-linear fill rate
 - Next generation 128-bit 2D graphics engine
 - High quality DVD video playback
 - 2D/3D resolutions up to 1920x1440
- 3D rendering features
 - MPEG-2 video textures
- 2D hardware acceleration features
- Motion video architecture
- Full software support

Onboard Integrated Media Reader - Smart I/O (PM11-UL/RAMA only)

- Supports Security Application Smart Card interface
- Supports two most promising compact storage - Memory Stick interface and Secure Digital Memory Card interface

ATX Double Deck Ports (PC 99 color-coded connectors)

- Two USB 2.0 ports (PM11-UL/RAMA only)
- Two USB 1.1 ports
- One RJ45 LAN port (PM11-EL/RAMA and PM11-UL/RAMA only)
- One DB-9 serial port
- One DB-15 VGA port
- One DB-25 parallel port
- One mini-DIN-6 PS/2 mouse port
- One mini-DIN-6 PS/2 keyboard port
- Three audio jacks: line-out, line-in and mic-in

Connectors

- One connector for 2 additional external USB 2.0 ports (PM11-UL/RAMA only)
- One connector for 2 additional external USB 1.1 ports
- One connector for 1 external serial port

- One connector for an external game/MIDI port
- One connector for external line-out and mic-in jacks
- Two internal audio connectors (AUX-in and CD-in)
- One S/PDIF-out connector
- One connector for IrDA interface
- Two IDE connectors
- One floppy drive interface supports up to two 2.88MB floppy drives
- Two ATX power supply connectors
- One Wake-On-LAN connector
- One Wake-On-Ring connector
- CPU fan, chassis fan and chip fan connectors
- 1 Smart Card interface (PM1 I-UL/RAMA only)
- 1 Memory Stick interface (PM1 I-UL/RAMA only)
- 1 Secure Digital Memory Card interface (PM1 I-UL/RAMA only)

PCI Bus Master IDE Controller

- Two PCI IDE interfaces support up to four IDE devices
- Supports ATA/33, ATA/66, ATA/100 and ATA/133 hard drives
- UDMA Modes 3, 4, 5 and 6 Enhanced IDE (data transfer rate up to 133MB/sec.)
- Bus mastering reduces CPU utilization during disk transfer
- Supports ATAPI CD-ROM, LS-120 and ZIP

IrDA Interface

The mainboard is equipped with an IrDA connector for wireless connectivity between your computer and peripheral devices.

USB Ports

The mainboard supports USB 2.0 (PM1 I-UL/RAMA only) and USB 1.1 ports. USB allows data exchange between your computer and a wide range of simultaneously accessible external Plug and Play peripherals.

BIOS

- Award BIOS, Windows® 98/2000/ME/XP Plug and Play compatible
- Supports SCSI sequential boot-up
- Flash EPROM for easy BIOS upgrades

- Supports DMI 2.0 function
- 2Mbit flash memory

Desktop Management Interface (DMI)

The mainboard comes with a DMI 2.0 built into the BIOS. The DMI utility in the BIOS automatically records various information about your system configuration and stores these information in the DMI pool, which is a part of the system board's Plug and Play BIOS. DMI, along with the appropriately networked software, is designed to make inventory, maintenance and troubleshooting of computer systems easier. Refer to chapter 4 for instructions on using the DMI utility.

1.1.2 System Health Monitor Functions

The mainboard is capable of monitoring the following “system health” conditions.

- Monitors the temperature of the CPU and system; and overheat alarm
- Monitors CPU/3.3V/±5V/±12V/VBAT/5VSB voltages and failure alarm
- Monitors the fan speed of the CPU fan and chassis fan; and failure alarm
- Automatic chassis fan on/off control
- Read back capability that displays temperature, voltage and fan speed

Refer to the “PC Health Status” section in chapter 3 and the “Hardware Monitor” section in chapter 4 for more information.

1.1.3 Intelligence

Automatic Chassis Fan Off

The chassis fan will automatically turn off once the system enters the Suspend mode.

Dual Function Power Button

Depending on the setting in the “Soft-Off By PWRBTN” field of the Power Management Setup, this switch will allow the system to enter the Soft-Off or Suspend mode.

Wake-On-Ring

This feature allows the system that is in the Suspend mode or Soft Power Off mode to wake-up/power-on to respond to calls coming through an internal or external modem. Refer to “Wake-On-Ring Connector” in chapter 2 and “Resume On LAN/Ring” (“IRQ/Event Activity Detect” field) in the Power Management Setup section in chapter 3 for more information.

**Important:**

If you are using a modem add-in card, the 5VSB power source of your power supply must support $\geq 720\text{mA}$.

Wake-On-LAN

The Wake-On-LAN function allows the network to remotely wake up a Soft Power Down (Soft-Off) PC. Your LAN card must support the remote wakeup function. Refer to “Wake-On-LAN Connector” in chapter 2 and “Resume On LAN/Ring” (“IRQ/Event Activity Detect” field) in the Power Management Setup section in chapter 3 for more information.

**Important:**

The 5VSB power source of your power supply must support $\geq 720\text{mA}$.

Wake-On-PS/2 Keyboard/Mouse

This function allows you to use the PS/2 keyboard or PS/2 mouse to wake up the system from the S5 state. Refer to “Jumper Settings for Wake-On-PS/2 Keyboard/Mouse” in chapter 2 and “PS2KB Wakeup Select” (“IRQ/Event Activity Detect” field) in the Power Management section in chapter 3 for more information.

**Important:**

- If you forgot the password, you must power-off the system, unplug the power cord and clear the CMOS data. Follow the steps in the “Jumper Settings for Clearing CMOS Data” section in chapter 2.*
- The 5VSB power source of your power supply must support $\geq 720\text{mA}$.*

Wake-On-USB Keyboard/Mouse

The Wake-On-USB Keyboard/Mouse function allows you to use a USB keyboard or USB mouse to wake up a system that is in the S3 (STR - Suspend To RAM) state.

If you are using this function with a device that is connected to the USB 2.0 port, you need to configure 2 jumpers. Refer to “Jumper Settings for Wake-On-USB 2.0 Keyboard/Mouse” in chapter 2. You also need to enable “Resume on PCI Event” (“IRQ/Event Activity Detect” field) in the Power Management Setup submenu of the BIOS.

If you are using this function with a device that is connected to the USB 1.1 port, you do not need to configure any jumpers. You only need to enable “USB Resume from S3” (“IRQ/Event Activity Detect” field) in the Power Management Setup submenu of the BIOS. Refer to chapter 3 for more information.



Important:

- *If you are using the Wake-On-USB Keyboard/Mouse function for 2 USB ports, the 5VSB power source of your power supply must support $\geq 1.5A$.*
- *If you are using the Wake-On-USB Keyboard/Mouse function for 3 or more USB ports, the 5VSB power source of your power supply must support $\geq 2A$.*

RTC Timer to Power-on the System

The RTC installed on the mainboard allows your system to automatically power-on on the set date and time. Refer to “Resume On Alarm” (“IRQ/Event Activity Detect” field) in the Power Management Setup section in chapter 3 for more information.

ACPI STR

The mainboard is designed to meet the ACPI (Advanced Configuration and Power Interface) specification. ACPI has energy saving features that enables PCs to implement Power Management and Plug-and-Play with operating systems that support OS Direct Power Management. Currently, only Windows® 98/2000/ME/XP supports the ACPI function. ACPI when enabled in the Power Management Setup will allow you to use the Suspend to RAM function.

With the Suspend to RAM function enabled, you can power-off the system at once by pressing the power button or selecting “Standby” when you shut down Windows® 98/2000/ME/XP without having to go through the sometimes tiresome process of closing files, applications and operating system. This is because the system is capable of storing all programs and data files during the entire operating session into RAM (Random Access Memory) when it powers-off. The operating session will resume exactly where you left off the next time you power-on the system. Refer to “Using the Suspend to RAM Function” in appendix A for more information.

**Important:**

The 5VSB power source of your power supply must support $\geq 1A$.

AC Power Failure Recovery

When power returns after an AC power failure, you may choose to either power-on the system manually, let the system power-on automatically or return to the state where you left off before power failure occurs. Refer to “PWR Lost Resume State” in the Power Management Setup section in chapter 3 for more information.

Virus Protection

Most viruses today destroy data stored in hard drives. The mainboard is designed to protect the boot sector and partition table of your hard disk drive.

1.2 Package Checklist

The mainboard package contains the following items:

- The mainboard
- A user's manual
- One card-edge bracket mounted with a serial port and game/MIDI port
- One IDE cable for ATA/33, ATA/66, ATA/100 or ATA/133 IDE drives
- One 34-pin floppy disk drive cable
- One “Main Board Utility” CD

If any of these items are missing or damaged, please contact your dealer or sales representative for assistance.

Chapter 2 - Hardware Installation

2.1 Mainboard Layout

PM11-EC/RAMA (Supports onboard audio)

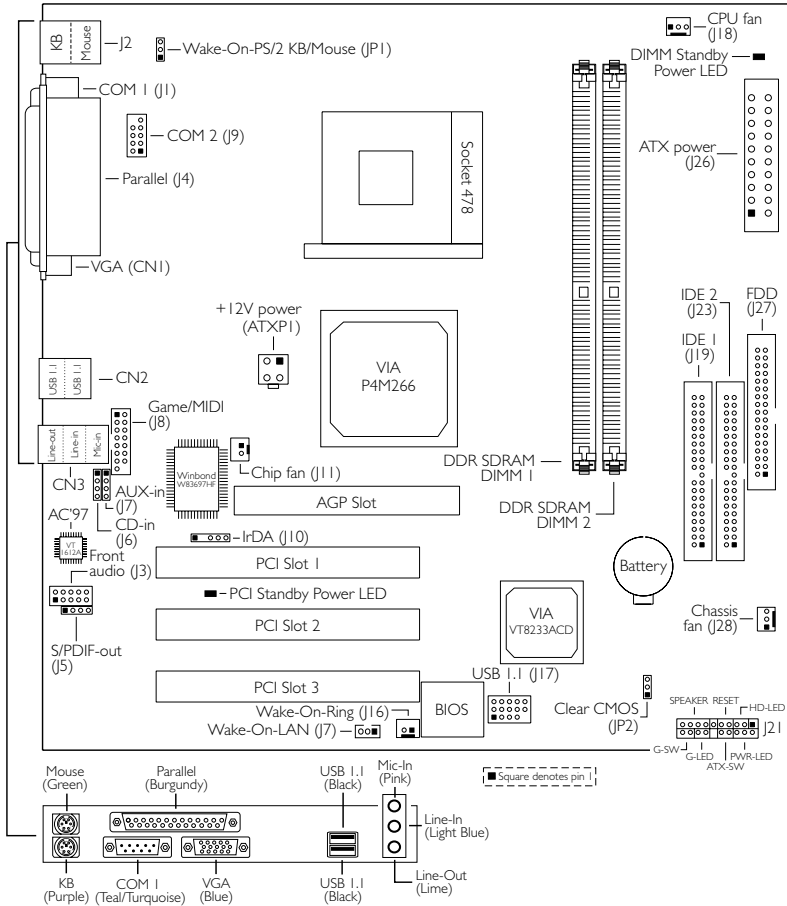

PM11-EL/RAMA

(Supports onboard audio and onboard LAN)

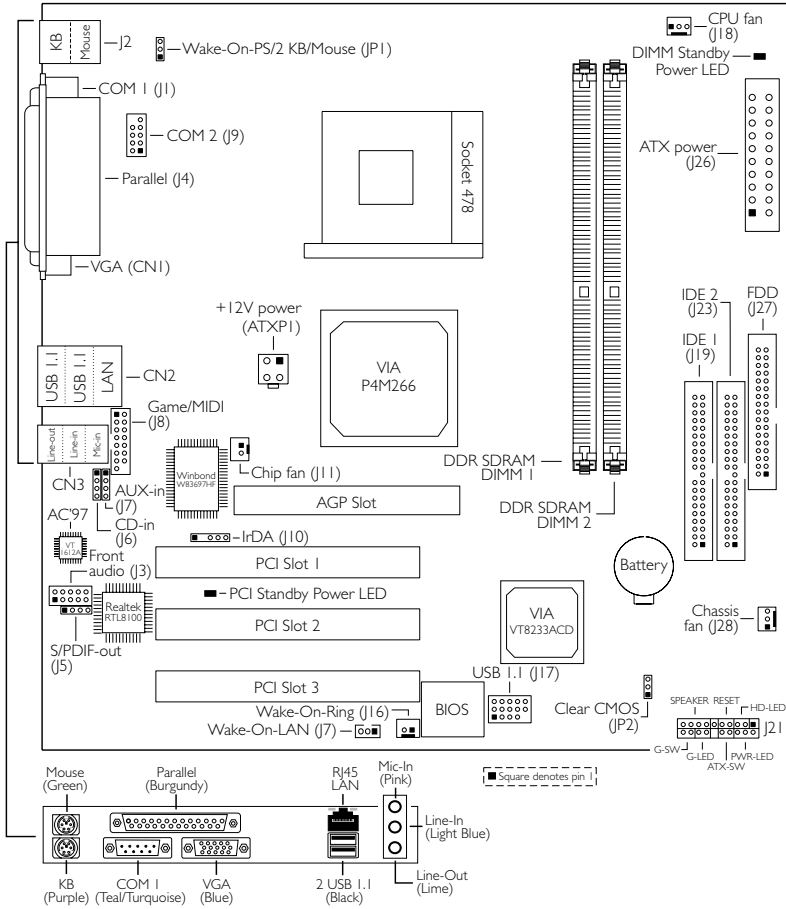

PMI I-UL/RAMA

(Supports onboard audio, onboard LAN, USB 2.0 and Smart I/O)

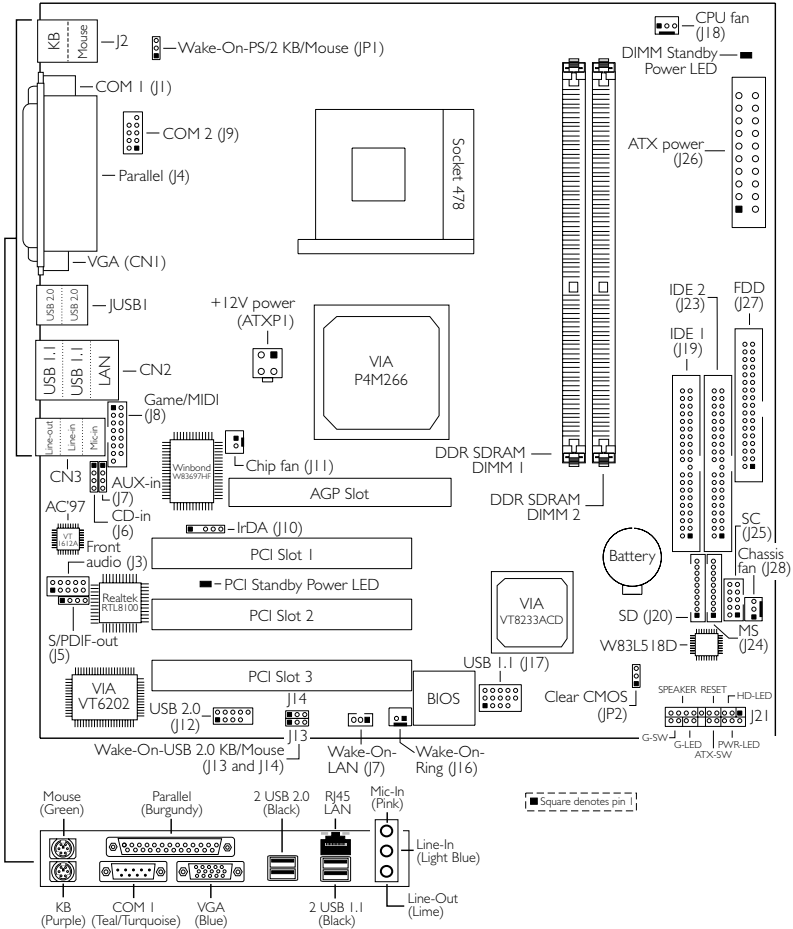

Note:

The illustrations on the following pages are based on the PMI I-UL/RAMA mainboard, which is the board that supports onboard audio, onboard LAN, USB 2.0 and Smart I/O.

**Warning:**

Electrostatic discharge (ESD) can damage your mainboard, processor, disk drives, add-in boards, and other components. Perform the upgrade instruction procedures described at an ESD workstation only. If such a station is not available, you can provide some ESD protection by wearing an antistatic wrist strap and attaching it to a metal part of the system chassis. If a wrist strap is unavailable, establish and maintain contact with the system chassis throughout any procedures requiring ESD protection.

2.2 System Memory

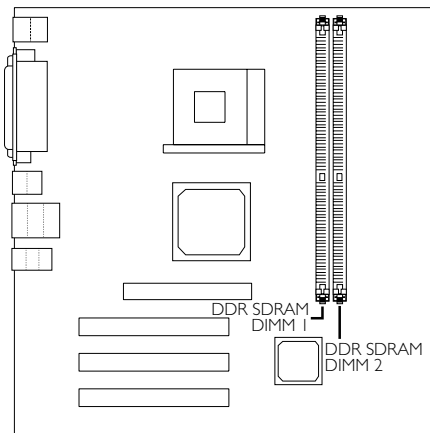

The mainboard is equipped with two 184-pin DDR SDRAM DIMM (Dual In-line Memory Module) sockets that support 2.5V DDR SDRAM DIMM. Double Data Rate SDRAM (DDR SDRAM) is a type of SDRAM that doubles the data rate through reading and writing at both the rising and falling edge of each clock. This effectively doubles the speed of operation therefore doubling the speed of data transfer.

Refer to chapter 1 (System Memory section) for detailed specification of the memory supported by the mainboard.

2.2.1 Installing the DIM Module

A DIM module simply snaps into a DIMM socket on the mainboard. Pin 1 of the DIM module must correspond with pin 1 of the socket.

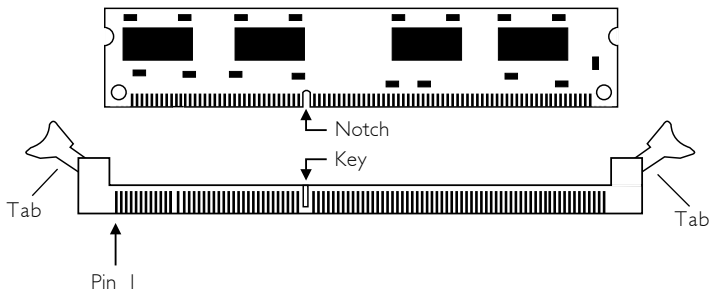

1. Pull the “tabs” which are at the ends of the socket to the side.
2. Position the DIMM above the socket with the “notch” in the module aligned with the “key” on the socket.
3. Seat the module vertically into the socket. Make sure it is completely seated. The tabs will hold the DIMM in place.

2.3 Jumper Settings for Clearing CMOS Data

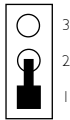
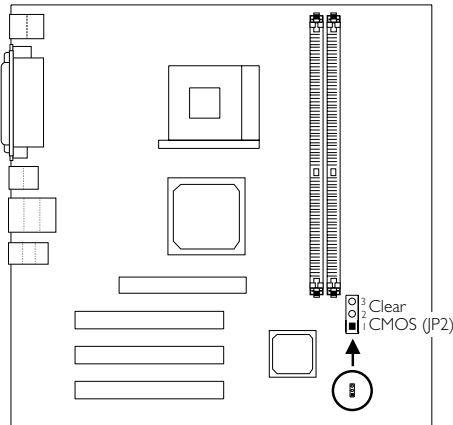

1-2 On: Normal
(default)

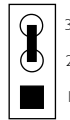

2-3 On:
Clear CMOS Data

Clear CMOS Data - Jumper JP2

If you encounter the following,

- CMOS data becomes corrupted.*
- You forgot the keyboard, supervisor or user password.*
- You are unable to boot-up the computer system because the processor's ratio/clock was incorrectly set in the BIOS.*

you can reconfigure the system with the default values stored in the ROM BIOS.

To load the default values stored in the ROM BIOS, please follow the steps below.

- Power-off the system and unplug the power cord.
- Set JP2 pins 2 and 3 to On. Wait for a few seconds and set JP2 back to its default setting, pins 1 and 2 On.

3. Now power-on the system.

If your reason for clearing the CMOS data is due to incorrect setting of the processor's ratio/clock in the BIOS, please proceed to step 4.

4. After powering-on the system, press to enter the main menu of the BIOS.
5. Select the Frequency/Voltage Control submenu and press <Enter>.
6. Set the "CPU Clock Ratio" or "CPU Clock" field to its default setting or an appropriate frequency ratio or bus clock. Refer to the Frequency/Voltage Control section in chapter 3 for more information.
7. Press <Esc> to return to the main menu of the BIOS setup utility. Select "Save & Exit Setup" and press <Enter>.
8. Type <Y> and press <Enter>.

2.4 Jumper Settings for Wake-On-PS/2 Keyboard/Mouse

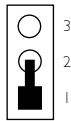
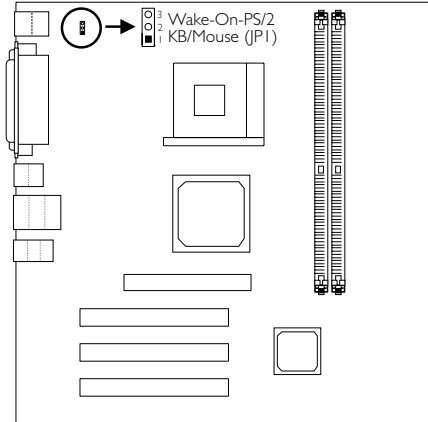

1-2 On: Disable - VCC power

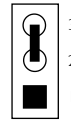

2-3 On: Enable - 5VSB power (default)

Wake-On-PS/2 Keyboard/Mouse - Jumper JP1

The Wake-On-PS/2 Keyboard/Mouse function allows you to use the PS/2 keyboard or PS/2 mouse to wake up the system from the S5 state. By default, JP1 is enabled. "PS2KB Wakeup Select" ("IRQ/Event Activity Detect" field) in the Power Management Setup submenu of the BIOS must be set accordingly. Refer to chapter 3 for details.



Warning:

1. If you forgot the password, you must power-off the system, unplug the power cord and clear the CMOS data. Follow the steps in the "Jumper Settings for Clearing CMOS Data" section.
2. The 5VSB power source of your power supply must support $\geq 720\text{mA}$.

2.5 Jumper Settings for Wake-On-USB 2.0 Keyboard/Mouse (PM11-UL/RAMA only)

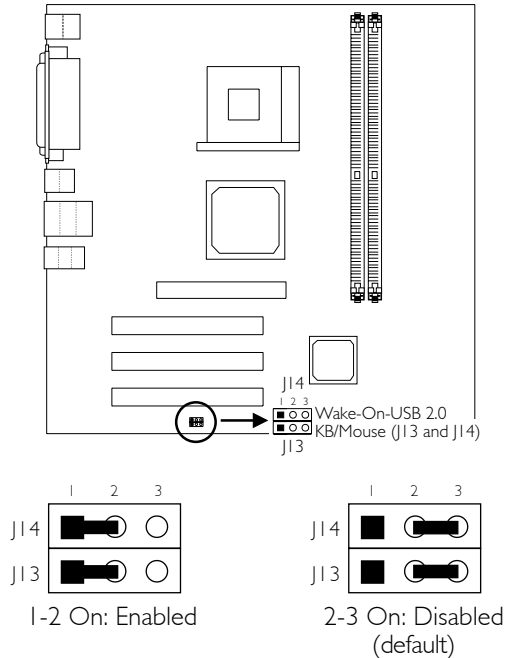

Wake-On-USB 2.0 Keyboard/Mouse - J13 and J14

The Wake-On-USB 2.0 Keyboard/Mouse function allows you to use a USB keyboard or USB mouse to wake up a system that is in the S3 (STR - Suspend To RAM) state. Set J13 and J14 to Enabled only if you are using this function with a device that is connected to the USB 2.0 port. Make sure "Resume on PCI Event" ("IRQ/Event Activity Detect" field) in the Power Management Setup submenu of the BIOS is also set to Enabled.



Important:

- If you are using the Wake-On-USB Keyboard/Mouse function for 2 USB ports, the 5VSB power source of your power supply must support $\geq 1.5A$.
- If you are using the Wake-On-USB Keyboard/Mouse function for 3 or more USB ports, the 5VSB power source of your power supply must support $\geq 2A$.

2.6 Ports and Connectors

2.6.1 Serial Ports

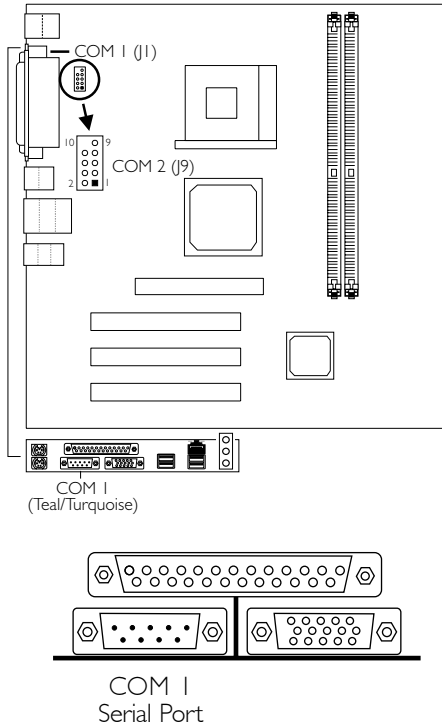

The built-in serial ports are RS-232C asynchronous communication ports with 16C550A-compatible UARTs that can be used with modems, serial printers, remote display terminals, and other serial devices. You can set the serial ports' I/O address in the Integrated Peripherals submenu ("Super IO Device" field) of the BIOS.

Connecting the Serial Ports

The system board is equipped with an onboard serial port (J1 - Teal/Turquoise) for COM 1 primary serial port located at the ATX double deck ports of the board. It is also equipped with a 9-pin connector at location J9 for COM 2 secondary serial port.

One card-edge bracket, mounted with a serial port cable and a game/MIDI port cable, is provided with the system board. If you want to use the secondary serial port, connect the serial port cable to connector J9. Make sure the colored stripe on the ribbon cable is aligned with pin 1 of connector J9. Mount the card-edge bracket to the system chassis.

2.6.2 PS/2 Mouse and PS/2 Keyboard Ports

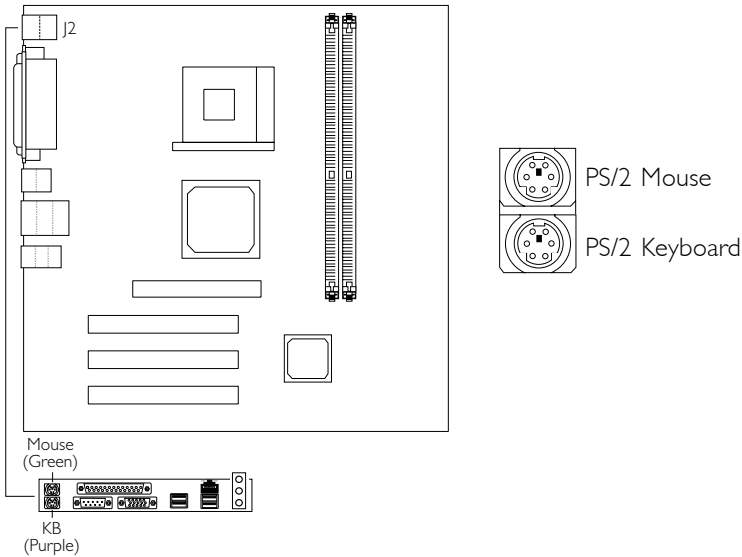

The mainboard is equipped with an onboard PS/2 mouse (Green) and PS/2 keyboard (Purple) ports - both at location J2 of the ATX double deck ports of the mainboard. The PS/2 mouse port uses IRQ12. If a mouse is not connected to this port, the system will reserve IRQ12 for other expansion cards.

The Wake-On-PS/2 Keyboard/Mouse function allows you to use a PS/2 keyboard or PS/2 mouse to wake up the system from the S5 state. Refer to "Jumper Settings for Wake-On-PS/2 Keyboard/Mouse" in this chapter and "PS2KB Wakeup Select" ("IRQ/Event Activity Detect" field) in the Power Management section in chapter 3 for more information.

**Warning:**

Make sure to turn off your computer prior to connecting or disconnecting a mouse or keyboard. Failure to do so may damage the mainboard.

2.6.3 Parallel Port

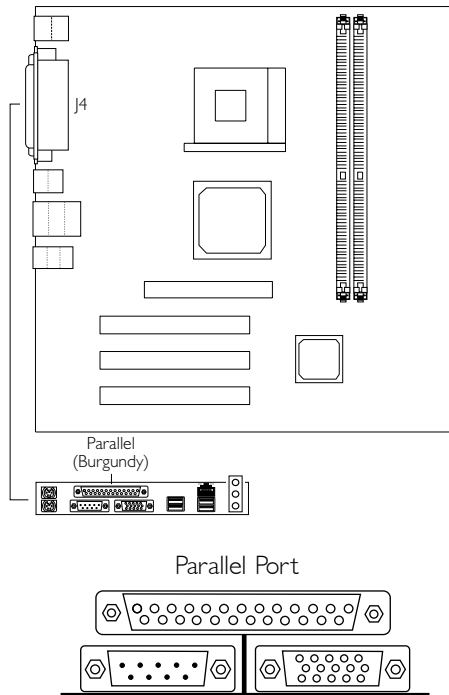

The mainboard has a standard parallel port (J4 - Burgundy) located at the ATX double deck ports of the board for interfacing your PC to a parallel printer. It supports SPP, ECP and EPP modes. You can select the port's mode in the Integrated Peripherals submenu ("Super IO Device" field) of the BIOS.

Setting	Function
SPP (Standard Parallel Port)	Allows normal speed operation but in one direction only.
ECP (Extended Capabilities Port)	Allows parallel port to operate in bidirectional mode and at a speed faster than the SPP's data transfer rate.
EPP (Enhanced Parallel Port)	Allows bidirectional parallel port operation at maximum speed.

2.6.4 Floppy Disk Drive Connector

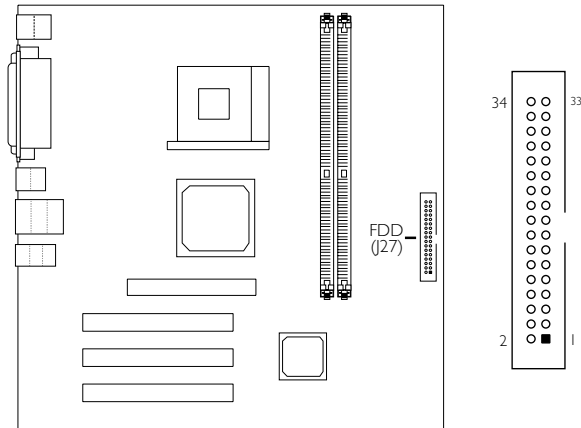

The mainboard is equipped with a shrouded floppy disk drive connector that supports two standard floppy disk drives. To prevent improper floppy cable installation, the shrouded floppy disk header has a keying mechanism. The 34-pin connector on the floppy cable can be placed into the header only if pin 1 of the connector is aligned with pin 1 of the header. You can enable or disable this function in the Integrated Peripherals submenu ("Super IO Device" field) of the BIOS.

Connecting the Floppy Disk Drive Cable

1. Install the 34-pin header connector of the floppy disk drive cable into the shrouded floppy disk header (J27) on the mainboard. The colored edge of the ribbon should be aligned with pin 1 of J27.
2. Install the other 34-pin header connector(s) into the disk drive(s). Align the colored edge of the daisy chained ribbon cable with pin 1 of the drive edge connector(s). The end-most connector should be attached to the drive you want to designate as Drive A.

2.6.5 IDE Disk Drive Connector

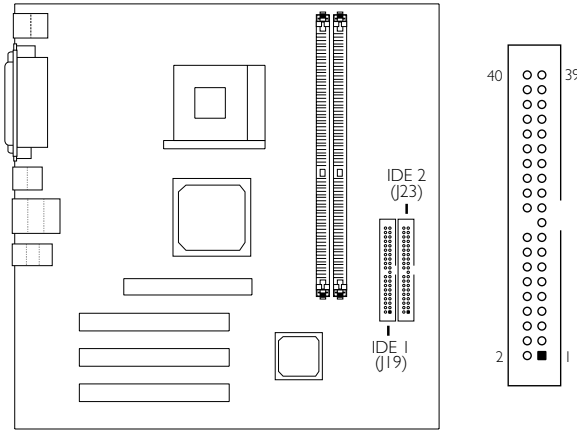

The mainboard is equipped with two shrouded PCI IDE headers that will interface four Enhanced IDE (Integrated Drive Electronics) disk drives. To prevent improper IDE cable installation, each shrouded PCI IDE header has a keying mechanism. The 40-pin connector on the IDE cable can be placed into the header only if pin 1 of the connector is aligned with pin 1 of the header. You can enable or disable the onboard primary or secondary IDE controller in the Integrated Peripherals submenu ("VIA OnChip IDE Device" field) of the BIOS.

Connecting the IDE Disk Drive Cable

1. If you are connecting two IDE drives, install the 40-pin connector of the IDE cable into the primary shrouded IDE header (J19). If you are adding a third or fourth IDE device, install the 40-pin connector of the other IDE cable into the secondary shrouded IDE header (J23).
2. Install the other 40-pin header connector(s) into the device with the colored edge of the ribbon cable aligned with pin 1 of the drive edge connector(s).



Note:

Refer to your disk drive user's manual for information about selecting proper drive switch settings.

Adding a Second IDE Disk Drive

When using two IDE drives, one must be set as the master and the other as the slave. Follow the instructions provided by the drive manufacturer for setting the jumpers and/or switches on the drives.

The mainboard supports Enhanced IDE or ATA-2, ATA/33, ATA/66, ATA/100 and ATA/133 hard drives. We recommend that you use hard drives from the same manufacturer. In a few cases, drives from two different manufacturers will not function properly when used together. The problem lies in the hard drives, not the mainboard.



Important:

If you encounter problems while using an ATAPI CD-ROM drive that is set in Master mode, please set the CD-ROM drive to Slave mode. Some ATAPI CD-ROMs may not be recognized and cannot be used if incorrectly set in Master mode.

2.6.6 Universal Serial Bus Ports

2.6.6.1 PM11-EC/RAMA and PM11-EL/RAMA

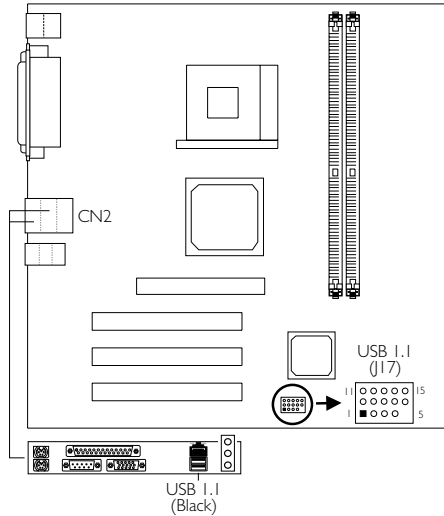

The PM11-EC/RAMA and PM11-EL/RAMA mainboards are each equipped with two onboard USB 1.1 ports (CN2 - Black) located at the ATX double deck ports of the board. Depending on the type of USB port cable that you are using, the J17 connector on the mainboard allows you to connect 2 more optional USB 1.1 ports. These optional USB 1.1 ports, which are mounted on a card-edge bracket, will be provided as an option. If you wish to use the optional USB 1.1 ports, install the card-edge bracket to the system chassis then insert the connector that is attached to the USB 1.1 port cables to J17.

Insert the USB port cable connector to pins 1-10 if:

- One of the holes on the cable connector is plugged, meaning the cable connector has a keying mechanism.

Insert the USB port cable connector to pins 6-15 if:

- None of the holes on the cable connector is plugged, meaning the cable connector has no keying mechanism.

You can enable or disable the USB 1.1 ports in the Integrated Peripherals submenu ("OnChip USB1.1 Controller" field) of the BIOS.

2.6.6.2 PM11-UL/RAMA

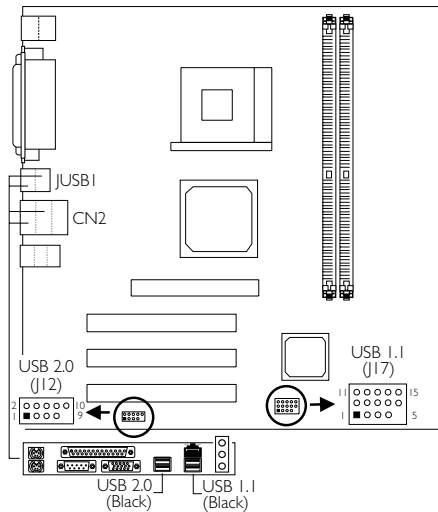

The PM11-UL/RAMA mainboard is equipped with two onboard USB 2.0 ports (JUSB1 - Black) and two onboard USB 1.1 ports (CN2 - Black) located at the ATX double deck ports of the board.

It is also equipped with a J12 connector for additional external USB 2.0 ports and a J17 connector for additional external USB 1.1 ports. Refer to the previous page for instructions on connecting the USB port cables.

You can enable or disable the USB 1.1 ports in the Integrated Peripherals submenu ("OnChip USB1.1 Controller" field) of the BIOS. The USB 2.0 ports are designed in that they are always enabled.

USB 1.1 (J17)

Pin	Function	Pin	Function	Pin	Function
1	VCC	6	VCC	11	Ground
2	UP2-	7	UP3-	12	Ground
3	UP2+	8	UP3+	13	UP2+
4	Ground	9	Ground	14	UP2-
5	Key	10	Ground	15	VCC

USB 2.0 (J12)

Pin	Function	Pin	Function
1	5V_Dul	6	Data+
2	5V_Dul	7	Ground
3	Data-	8	Ground
4	Data-	9	Key
5	Data+	10	Ground

Wake-On-USB Keyboard/Mouse

The Wake-On-USB Keyboard/Mouse function allows you to use a USB keyboard or USB mouse to wake up a system that is in the S3 (STR - Suspend To RAM) state.

If you are using this function with a device that is connected to the USB 2.0 port, you need to configure 2 jumpers. Refer to “Jumper Settings for Wake-On-USB 2.0 Keyboard/Mouse” in chapter 2. You also need to enable “Resume on PCI Event” (“IRQ/Event Activity Detect” field) in the Power Management Setup submenu of the BIOS.

If you are using this function with a device that is connected to the USB 1.1 port, you do not need to configure any jumpers. You only need to enable “USB Resume from S3” (“IRQ/Event Activity Detect” field) in the Power Management Setup submenu of the BIOS. Refer to chapter 3 for more information.

2.6.7 RJ45 Fast-Ethernet Port (PM11-EL/RAMA and PM11-UL/RAMA only)

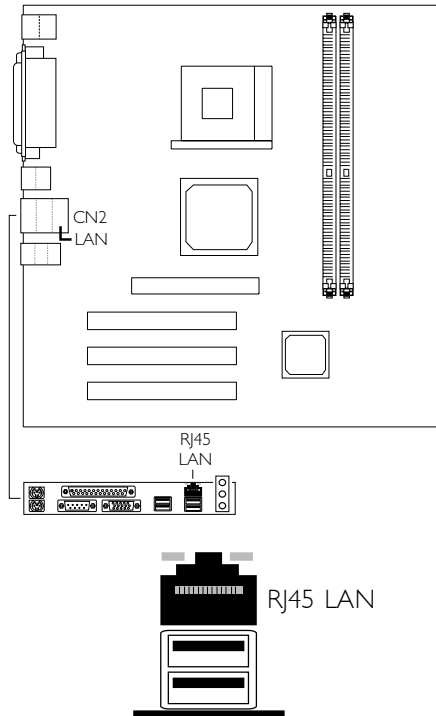

The PM11-EL/RAMA and PM11-UL/RAMA mainboards are each equipped with an onboard RJ45 fast-ethernet LAN port at location CN2 of the ATX double deck ports. It allows the mainboard to connect to a local area network by means of a network hub. You may enable or disable the onboard LAN in the Integrated Peripherals submenu ("VIA OnChip PCI Device" field) of the BIOS.

2.6.8 VGA Port

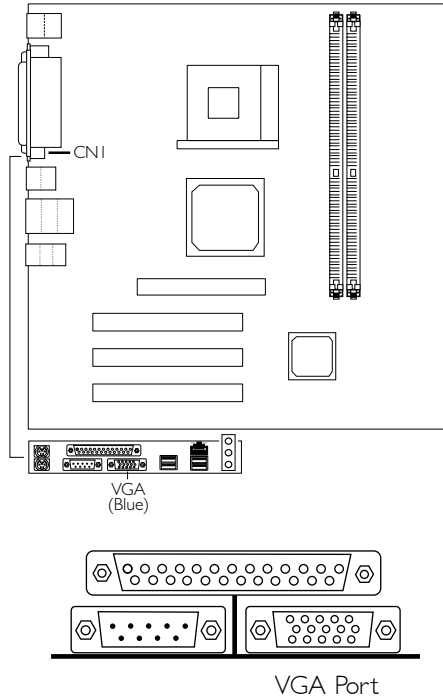

The system board can only be used with an analog video monitor. Connect the monitor's 15-pin D-shell cable connector to the VGA port (CNI - Blue) located at the ATX double deck ports of the board. If your monitor supports analog video but does not have a 15-pin D-shell connector, see your monitor dealer for the adapter or optional cable. After you plug the monitor cable into the VGA port, gently tighten the cable screws to hold the connector in place. Some monitors have a switch that chooses between analog and TTL (or digital) operation. If your monitor has such a switch, set it for analog.

2.6.9 IrDA Connector

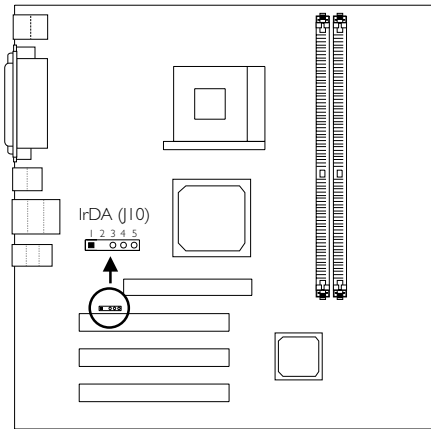

Pin	Function
1	VCC
2	N. C.
3	IRRX
4	Ground
5	IRTX

The mainboard is equipped with an IrDA connector for wireless connectivity between your computer and peripheral devices. The IRDA (Infrared Data Association) specification supports data transfers of 115K baud at a distance of 1 meter:

Connect your IrDA cable to connector J10 on the mainboard. Set "UART Mode Select" in the Integrated Peripherals submenu ("Super IO Device" field) of the BIOS to the type of IrDA standard supported by your device. You must have the proper drivers installed in your operating system to use this connector. Refer to your operating system's manual or documentation.



Note:

The sequence of the pin functions on some IrDA cable may be reversed from the pin function defined on the mainboard. Make sure to connect the cable to the IrDA connector according to their pin functions.

2.6.10 CPU Fan Connector

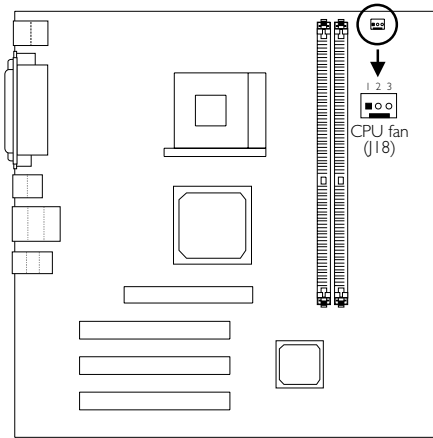

Pin	Function
1	Ground
2	Power
3	Sense

The processor must be kept cool by using a fan with heatsink. Connect the CPU fan to the 3-pin fan connector at location J18 on the mainboard. The system is capable of monitoring the speed of the CPU fan.

2.6.11 Chassis Fan Connector

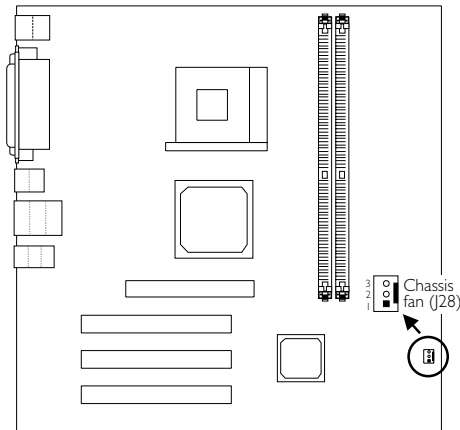

Pin	Function
1	On/Off
2	+12V
3	Sense

If you are installing a chassis fan in the system unit, connect the fan's connector to location J28 on the mainboard. The fan will provide adequate airflow throughout the chassis to prevent overheating the processor. The system is capable of monitoring and controlling the speed of the chassis fan. The chassis fan will automatically turn off once the system enters the Suspend mode.

2.6.12 Chip Fan Connector

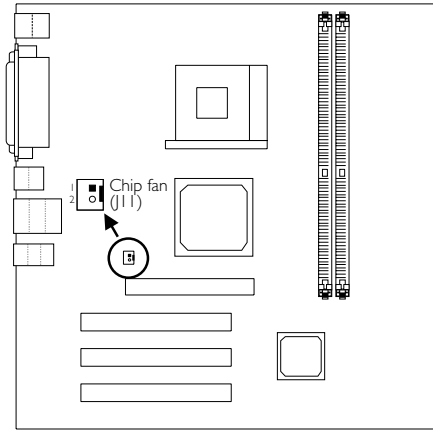

Pin	Function
1	+12V
2	Ground

The VIA P4M266 chip must be kept cool by using a fan with heatsink. Connect the fan's connector to location J11 on the system board.

2.6.13 Game/MIDI Port

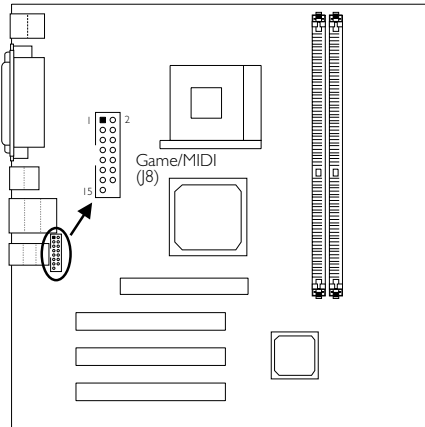

The system board is equipped with a 15-pin connector at location J8 for connecting an external game/MIDI port. One card-edge bracket, mounted with a serial port cable and a game/MIDI port cable, is provided with the system board. Install the card-edge bracket to the system chassis then connect the game/MIDI port cable to connector J8. Make sure the colored stripe on the ribbon cable is aligned with pin 1 of connector J8.

The Game/MIDI port is identical to that of a standard PC game adapter or game I/O port. This port works well with any application that is compatible with the standard PC joystick.

2.6.14 Audio Jacks

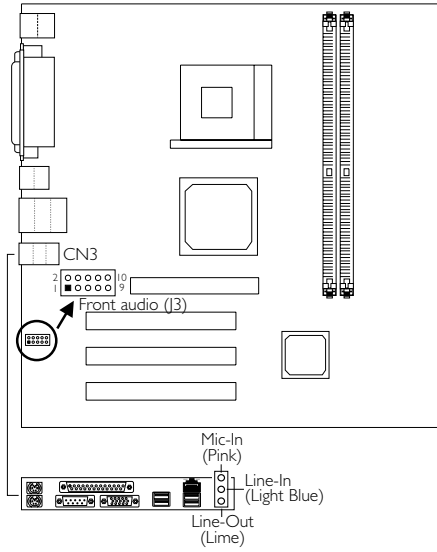

Front Audio (J3)

Pin	Function	Pin	Function
1	Mic+	2	Ground
3	Mic Power	4	AuD_Vcc (Avcc)
5	AuD_R_Out	6	AuD_R_Return (GND)
7	N. C.	8	Key
9	AuD_L_Out	10	AuD_L_Return (GND)

Onboard Audio Jacks (CN3)

The mainboard is equipped with 3 audio jacks. A jack is a one-hole connecting interface for inserting a plug.

Line-out Jack (Lime)

This jack is used to connect external speakers for audio output from the mainboard.

Line-in Jack (Light Blue)

This jack can be connected to the line-out jack of any external audio devices such as Hi-fi set, CD player, AM/FM radio tuner, synthesizer, etc. Connect a stereo cable from the line-out jack of your external device to this line-in jack.

Mic-in Jack (Pink)

Connect a microphone to the mic-in jack.

Front Audio (J3)

J3 provides you the option of connecting another line-out and mic-in jacks.

2.6.15 Internal Audio Connectors

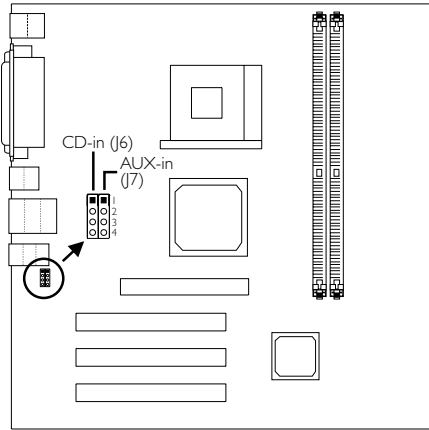

Pin	Function
1	Left audio channel
2	Ground
3	Ground
4	Right audio channel

AUX-in and CD-in

These connectors are used to receive audio from a CD-ROM drive, TV tuner or MPEG card.

2.6.16 S/PDIF-out Connector

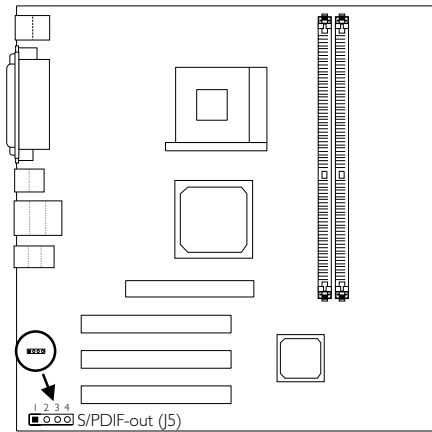

Pin	Function
1	AVDD5
2	N. C.
3	SPDIF
4	Ground

The mainboard is equipped with a digital audio interface - S/PDIF (Sony/Philips Digital Interface). S/PDIF is a standard audio file transfer format that transfers digital audio signals to a device without having to be converted first to an analog format. This prevents the quality of the audio signal from degrading whenever it is converted to analog.

Connect the S/PDIF audio cable to J5 for digital audio output to external speakers or a device that supports digital output.

2.6.17 Smart I/O Connectors (PM1 I-UL/RAMA only)

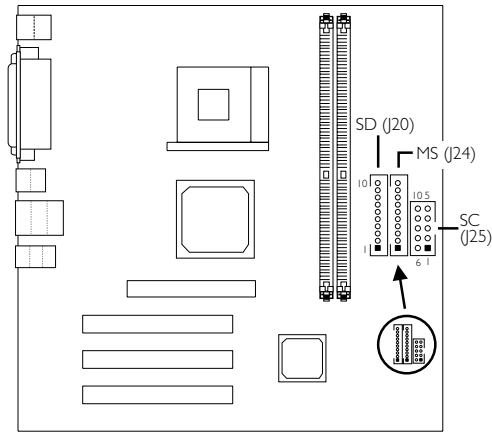

The PM1 I-UL/RAMA mainboard is equipped with a security interface - Smart Card (SC) interface and two compact storage interfaces - Memory Stick (MS) interface and Secure Digital Memory Card (SD) interface. An optional device will be provided allowing you to insert these cards.

The Smart Card is a small electronic device about the size of a credit card that provides security to files or computer. The extent and type of security will depend on the settings built into the card.

Memory Stick is an IC memory media that has a large storage capacity. It can store any format of digital data as well as transfer digital data and shares them among electronic devices that are compatible with Memory Stick.

Secure Digital Memory Card is a storage device about the size of a postage stamp that provides fast downloading of all types of digital files to your computer as well as easy transfer of files from your computer to the SD Memory Card.

You can select the SC, MS and SD's address/IRQ in the Integrated Peripherals submenu ("Super IO Device" field) of the BIOS.

The optional Smart I/O Drive

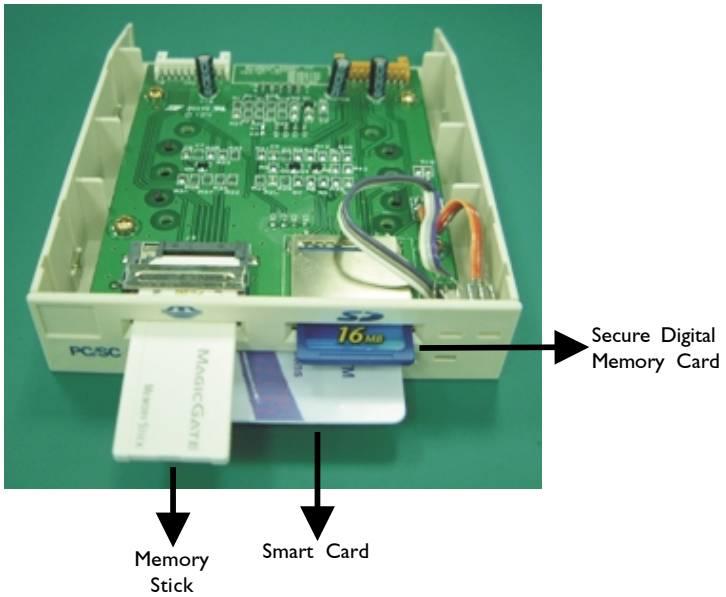

Smart Card Interface

Pin	Function	Pin	Function
1	VCC	6	Ground
2	SCAPWC-	7	SCARST-
3	SCAC4	8	SCALED
4	SCAIO	9	SCAC8
5	SCACLK	10	SCAPSNT

Memory Stick Interface

Pin	Function	Pin	Function
1	Ground	6	MSA4
2	MSA1	7	MSA5
3	VCC3	8	MSACLK
4	MSA2	9	MSAPWC-
5	MSA3	10	MSALED

Secure Digital Memory Card Interface

Pin	Function	Pin	Function
1	Ground	6	MSB4
2	MSB1	7	MSB5
3	VCC3	8	MSBCLK
4	MSB2	9	MSBPWC-
5	MSB3	10	MSBLED

2.6.18 Wake-On-LAN Connector

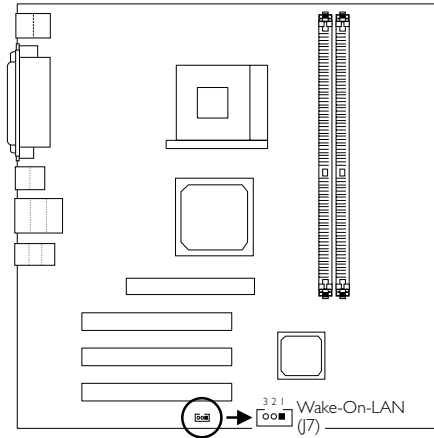

Pin	Function
1	WOL
2	Ground
3	+5VSB

The mainboard supports the Wake-On-LAN function. This function will allow the network to remotely power-on a Soft Power Down (Soft-Off) PC. However, if your system is in the Suspend mode, you can power-on the system only through an IRQ or DMA interrupt.

To use the Wake-On-LAN function, you must enable “Resume on LAN/Ring” in the Power Management Setup (“IRQ/Event Activity Detect” field) of the BIOS. Your LAN card package should include a cable. Connect one end of the cable to the wakeup header on the card and the other end to location J7 on the mainboard. The network will detect Magic Packet and assert a wakeup signal to power-up the system. Refer to the add-in card’s manual for details. Note: Your LAN card must support the remote wake up function.



Important:

The 5VSB power source of your power supply must support $\geq 720\text{mA}$.

2.6.19 Wake-On-Ring Connector

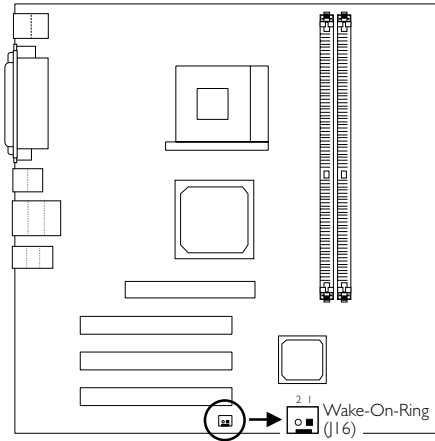

Pin	Function
1	Ground
2	RI#

The Wake-On-Ring connector is used to connect to an internal modem card that has the same connector. It will allow the system that is in the Suspend mode or Soft Power Off mode to wake-up/power-on to respond to calls coming through the internal modem card.

To use this function, connect one end of the cable (that came with the card) to the card's wake-on-ring connector and the other end to location J16 on the mainboard. You must also enable "Resume on LAN/Ring" in the Power Management Setup ("IRQ/Event Activity Detect" field) of the BIOS.

If you are using an external modem, the ring-on function will come through the serial port where the external modem is connected.

**Important:**

If you are using a modem add-in card, the 5VSB power source of your power supply must support $\geq 720\text{mA}$.

2.6.20 DIMM and PCI Standby Power LEDs

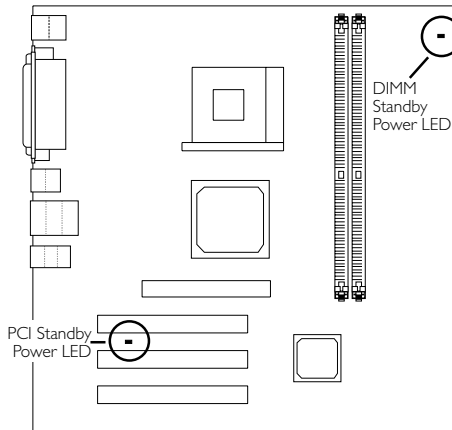

DIMM Standby Power LED

This LED will turn red when the system's power is on or when it is in the Suspend state (Power On Suspend or Suspend to RAM). It will not light when the system is in the Soft-Off state.

PCI Standby Power LED

This LED will turn red when the system is in the power-on, Soft-Off or Suspend (Power On Suspend or Suspend to RAM) state.



Important:

Lighted LEDs serve as a reminder that you must power-off the system then turn off the power supply's switch or unplug the power cord prior to installing any memory modules or add-in cards.

2.6.2.1 Power Connectors

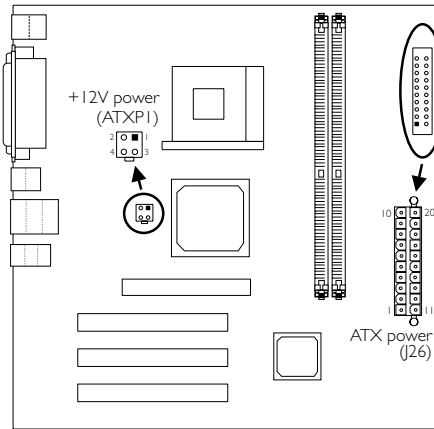

We recommend that you use a power supply that complies with the ATX12V Power Supply Design Guide Version 1.1. Connect the ATX12V power supply's 20-pin ATX main power connector and 4-pin +12V power connector to J26 and ATXP1 respectively.

The 4-pin +12V power connector enables the delivery of more +12VDC current to the processor's Voltage Regulator Module (VRM).

The mainboard requires a minimum of 250 Watt power supply to operate. Your system configuration (amount of memory, add-in cards, peripherals, etc.) may exceed the minimum power requirement. To ensure that adequate power is provided, use a 300 Watt (or greater) power supply.

ATX Main Power Connector

Pin	Function	Pin	Function
1	3.3V	11	3.3V
2	3.3V	12	-12V
3	Ground	13	Ground
4	+5V	14	PS-ON
5	Ground	15	Ground
6	+5V	16	Ground
7	Ground	17	Ground
8	PW-OK	18	-5V
9	5VSB	19	+5V
10	+12V	20	+5V

+12V Power Connector

Pin	Function
1	Ground
2	Ground
3	+12V
4	+12V

2.6.22 Front Panel Connectors

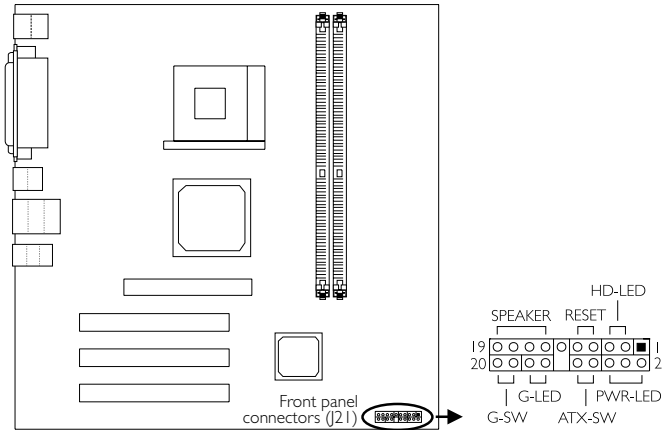

HD-LED: Primary/Secondary IDE LED

This LED will light when the hard drive is being accessed.

G-LED: Green LED

This LED will not light when the system's power is on or when the system is in the S3 (STR - Suspend To RAM) state. It will light when the system is in the S1 (POS - Power On Suspend) state.

ATX-SW: ATX Power Switch

Depending on the setting in the BIOS setup, this switch is a "dual function power button" that will allow your system to enter the Soft-Off or Suspend mode. Refer to "Soft-Off By PWRBTN" in the Power Management Setup (Chapter 3).

G-SW: Green Switch

This switch will allow your system to enter the Suspend mode.

RESET: Reset Switch

This switch allows you to reboot without having to power off the system thus prolonging the life of the power supply or system.

SPEAKER: Speaker Connector

This connects to the speaker installed in the system chassis.

PWR-LED: Power/Standby LED

When the system's power is on, this LED will light. When the system is in the S1 (POS - Power On Suspend) state, it will blink every second. When the system is in the S3 (STR - Suspend To RAM) state, it will blink every 4 seconds.

**Note:**

If your system did not boot-up and the Power/Standby LED did not light after it was powered-on, it may indicate that the CPU or memory module was not installed properly. Please make sure they are properly inserted into their corresponding socket.

	Pin	Pin Assignment
HD-LED (Primary/Secondary IDE LED)	3 5	HDD LED Power HDD
G-LED (Green LED)	14 16	Green LED Power Ground
ATX-SW (ATX power switch)	8 10	PWRBT+ PWRBT-
G-SW (Green switch)	18 20	Ground SMI
RESET (Reset switch)	7 9	Ground H/W Reset
SPEAKER (Speaker connector)	13 15 17 19	Speaker Data N. C. Ground Speaker Power
PWR-LED (Power/Standby LED)	2 4 6	LED Power (+) LED Power (+) LED Power (-) or Standby Signal

Chapter 3 - Award BIOS Setup Utility

3.1 The Basic Input/Output System

The Basic Input/Output System (BIOS) is a program that takes care of the basic level of communication between the processor and peripherals. In addition, the BIOS also contains codes for various advanced features found in this mainboard. This chapter explains the Setup Utility for the Award BIOS.

After you power up the system, the BIOS message appears on the screen and the memory count begins. After the memory test, the following message will appear on the screen:

Press DEL to enter setup

If the message disappears before you respond, restart the system or press the "Reset" button. You may also restart the system by pressing the <Ctrl> <Alt> and keys simultaneously.

When you press , the main menu screen will appear:

Phoenix - AwardBIOS CMOS Setup Utility

Standard CMOS Features	Frequency/Voltage Control
Advanced BIOS Features	Load Fail-Safe Defaults
Advanced Chipset Features	Load Optimized Defaults
Integrated Peripherals	Set Supervisor Password
Power Management Setup	Set User Password
PnP/PCI Configurations	Save & Exit Setup
PC Health Status	Exit Without Saving
Esc : Quit	↑↓←→ : Select Item
F10 : Save & Exit Setup	
Time, Date, Hard Disk Type...	

3.1.1 Standard CMOS Features

Use the arrow keys to highlight "Standard CMOS Features" and press <Enter>. A screen similar to the one on the next page will appear:

Phoenix - AwardBIOS CMOS Setup Utility
Standard CMOS Features

		Item Help
Date (mm:dd:yy)	Tue, Feb 5 2002	Menu Level Change the day, month, year and century
Time (hh:mm:ss)	4 : 35 : 5	
▶ IDE Primary Master	Press Enter None	
▶ IDE Primary Slave	Press Enter None	
▶ IDE Secondary Master	Press Enter None	
▶ IDE Secondary Slave	Press Enter None	
Drive A	1.44M, 3.5 in.	
Drive B	None	
Video	EGA/VGA	
Halt On	All, But Keyboard	
Base Memory	640K	
Extended Memory	129024K	
Total Memory	130048K	
↑↓→← : Move Enter: Select +/-/PU/PD: Value F10: Save ESC: Exit F1: General Help F5: Previous Values F6: Fail-Safe Defaults F7: Optimized Defaults		

The settings on the screen are for reference only. Your version may not be identical to this one.

Date

The date format is <day>, <month>, <date>, <year>. Day displays a day, from Sunday to Saturday. Month displays the month, from January to December. Date displays the date, from 1 to 31. Year displays the year, from 1990 to 2098.

Time

The time format is <hour>, <minute>, <second>. The time is based on the 24-hour military-time clock. For example, 1 p.m. is 13:00:00. Hour displays hours from 00 to 23. Minute displays minutes from 00 to 59. Second displays seconds from 00 to 59.

IDE Primary Master, IDE Primary Slave, IDE Secondary Master and IDE Secondary Slave

Move the cursor to the "IDE Primary Master", "IDE Primary Slave", "IDE Secondary Master" or "IDE Secondary Slave" field, then press <Enter>.

IDE HDD Auto Detection

Detects the parameters of the drive. The parameters will automatically be shown on the screen.

IDE Primary/Secondary Master/Slave

If you wish to define your own drive type manually, select "Manual". The drive type information should be included in the documentation from your hard disk vendor. If you select "Auto", the BIOS will auto-detect the HDD & CD-ROM drive at the POST stage and show the IDE for the HDD & CD-ROM drive. If a hard disk has not been installed, select "None".

Capacity

Displays the approximate capacity of the disk drive. Usually the size is slightly greater than the size of a formatted disk given by a disk checking program.

Access Mode

For hard drives larger than 528MB, you would typically select the LBA type. Certain operating systems require that you select Normal or Large. Please check your operating system's manual or Help desk on which one to select.

Drive A and Drive B

These fields identify the types of floppy disk drives installed.

<i>None</i>	No floppy drive is installed
<i>360K, 5.25 in.</i>	5-1/4 in. standard drive; 360KB capacity
<i>1.2M, 5.25 in.</i>	5-1/4 in. AT-type high-density drive; 1.2MB capacity
<i>720K, 3.5 in.</i>	3-1/2 in. double-sided drive; 720KB capacity
<i>1.44M, 3.5 in.</i>	3-1/2 in. double-sided drive; 1.44MB capacity
<i>2.88M, 3.5 in.</i>	3-1/2 in. double-sided drive; 2.88MB capacity

Video

This field selects the type of video adapter used for the primary system monitor. Although secondary monitors are supported, you do not have to select the type. The default setting is EGA/VGA.

<i>EGA/VGA</i>	Enhanced Graphics Adapter/Video Graphics Array. For EGA, VGA, SVGA and PGA monitor adapters.
<i>CGA 40</i>	Color Graphics Adapter. Power up in 40-column mode.
<i>CGA 80</i>	Color Graphics Adapter. Power up in 80-column mode.
<i>Mono</i>	Monochrome adapter. Includes high resolution monochrome adapters.

Halt On

This field determines whether the system will stop if an error is detected during power up. The default setting is All Errors.

- No Errors* The system boot will not stop for any errors detected.
- All Errors* The system boot will stop whenever the BIOS detects a non-fatal error.
- All, But Keyboard* The system boot will not stop for a keyboard error; it will stop for all other errors.
- All, But Diskette* The system boot will not stop for a disk error; it will stop for all other errors.
- All, But Disk/Key* The system boot will not stop for a disk or keyboard error; it will stop for all other errors.

Base Memory

Displays the amount of base (or conventional) memory installed in the system. The value of the base memory is typically 512K for systems with 512K memory installed on the motherboard or 640K for systems with 640K or more memory installed on the motherboard.

Extended Memory

Displays the amount of extended memory detected during boot-up.

Total Memory

Displays the total memory available in the system.

3.1.2 Advanced BIOS Features

The Advanced BIOS Features allows you to configure your system for basic operation. Some entries are defaults required by the mainboard, while others, if enabled, will improve the performance of your system or let you set some features according to your preference.

Phoenix - AwardBIOS CMOS Setup Utility
Advanced BIOS Features

		Item Help
Virus Warning	Disabled	Menu Level Allows you to choose the VIRUS warning feature for IDE Hard Disk boot sector protection. If this function is enabled and someone attempt to write data into this area, BIOS will show a warning message on screen and alarm beep
CPU L1 & L2 Cache	Enabled	
CPU L2 Cache ECC Checking	Enabled	
Quick Power On Self Test	Enabled	
First Boot Device	Floppy	
Second Boot Device	HDD-0	
Third Boot Device	LS120	
Boot Other Device	Enabled	
Swap Floppy Drive	Disabled	
Boot Up Floppy Seek	Disabled	
Boot Up NumLock Status	On	
Typeomatic Rate Setting	Disabled	
X Typeomatic Rate (Chars/Sec)	6	
X Typeomatic Delay (Msec)	250	
Security Option	Setup	
OS Select For DRAM > 64MB	Non-OS2	
Video BIOS Shadow	Enabled	
Small Logo(EPA) Show	Enabled	
↑↓→← Move Enter:Select +/-/PU/PD:Value F10:Save ESC:Exit F1:General Help F5:Previous Values F6:Fail-Safe Defaults F7:Optimized Defaults		

The settings on the screen are for reference only. Your version may not be identical to this one.

Virus Warning

This field protects the boot sector and partition table of your hard disk drive. When this field is enabled, the Award BIOS will monitor the boot sector and partition table of the hard disk drive. If an attempt is made to write to the boot sector or partition table of the hard disk drive, the BIOS will halt the system and an error message will appear.

After seeing the error message, if necessary, you will be able to run an anti-virus program to locate and remove the problem before any damage is done.

Many disk diagnostic programs which attempt to access the boot sector table will cause the warning message to appear. If you are running such a program, we recommend that you first disable this

field. Also, disable this field if you are installing or running certain operating systems like Windows® 98/2000/ME/XP or the operating system may not install nor work.

CPU L1 & L2 Cache

These fields speed up the memory access. The default value is enabled.

CPU L2 Cache ECC Checking

The processors supported by the mainboard come with built-in Level 2 cache. By default, ECC is enabled to check the Level 2 cache. If you are not using this function, set this field to Disabled.

Quick Power On Self Test

This field speeds up Power On SelfTest (POST) after you power on the system. When Enabled, the BIOS will shorten or skip some check items during POST.

First Boot Device, Second Boot Device, Third Boot Device and Boot Other Device

Select the drive to boot first, second and third in the "First Boot Device" "Second Boot Device" and "Third Boot Device" fields respectively. The BIOS will boot the operating system according to the sequence of the drive selected. Set "Boot Other Device" to Enabled if you wish to boot from another device.

Swap Floppy Drive

When this field is enabled and the system is booting from the floppy drive, the system will boot from drive B instead of drive A. When this option is disabled and the system is booting from the floppy drive, the system will boot from drive A. You must have two floppy drives to use this function.

Boot Up Floppy Seek

When enabled, the BIOS will check whether the floppy disk drive installed is 40 or 80 tracks. Note that the BIOS cannot distinguish between 720K, 1.2M, 1.44M and 2.88M drive types as they are all 80 tracks. When disabled, the BIOS will not search for the type of floppy disk drive by track number. Note that there will not be any warning message if the drive installed is 360KB.

Boot Up NumLock Status

This allows you to determine the default state of the numeric keypad. By default, the system boots up with NumLock on wherein the function of the numeric keypad is the number keys. When set to Off, the function of the numeric keypad is the arrow keys.

Typematic Rate Setting

Disabled Continually holding down a key on your keyboard will cause the BIOS to report that the key is down.

Enabled The BIOS will not only report that the key is down, but will first wait for a moment, and, if the key is still down, it will begin to report that the key has been depressed repeatedly. For example, you would use such a feature to accelerate cursor movements with the arrow keys. You can then select the typematic rate and typematic delay in the "Typematic Rate (Chars/Sec)" and "Typematic Delay (Msec)" fields below.

Typematic Rate (Chars/Sec)

This field allows you to select the rate at which the keys are accelerated.

Typematic Delay (Msec)

This field allows you to select the delay between when the key was first depressed and when the acceleration begins.

Security Option

This field determines when the system will prompt for the password - everytime the system boots or only when you enter the BIOS setup. Set the password in the Set Supervisor/User Password submenu.

- System* The system will not boot and access to Setup will be denied unless the correct password is entered at the prompt.
- Setup* The system will boot, but access to Setup will be denied unless the correct password is entered at the prompt.

OS Select for DRAM > 64MB

This field allows you to access the memory that is over 64MB in OS/2. The options are: Non-OS2 and OS2.

Video BIOS Shadow

Determines whether video BIOS will be copied to RAM. Video Shadow will increase the video speed. Note that some graphics boards require that this option be disabled. The default value is Enabled.

- Enabled* Video shadow is enabled.
- Disabled* Video shadow is disabled.

Small Logo(EPA) Show

- Enabled* The EPA logo will appear during system boot-up.
- Disabled* The EPA logo will not appear during system boot-up.

3.1.3 Advanced Chipset Features

Phoenix - AwardBIOS CMOS Setup Utility
Advanced Chipset Features

<ul style="list-style-type: none"> ▶ DRAM Clock/Drive Control ▶ AGP & P2P Bridge Control ▶ CPU & PCI Bus Control Memory Hole System BIOS Cacheable Video RAM Cacheable VGA Share Memory Size FB Address Conversion FB Page Close Prediction 	<ul style="list-style-type: none"> Press Enter Press Enter Press Enter Disabled Disabled Disabled 32M Disabled Disabled 	<p style="text-align: center;">Item Help</p> <hr/> <p style="text-align: center;">Menu Level</p>
<p>↑↓→← Move Enter:Select +/-/PU/PD:Value F10:Save ESC:Exit F1:General Help F5:Previous Values F6:Fail-Safe Defaults F7:Optimized Defaults</p>		

The settings on the screen are for reference only. Your version may not be identical to this one.

This section gives you functions to configure the system based on the specific features of the chipset. The chipset manages bus speeds and access to system memory resources. **These items should not be altered unless necessary.** The default settings have been chosen because they provide the best operating conditions for your system. The only time you might consider making any changes would be if you discovered some incompatibility or that data was being lost while using your system.

DRAM Clock/Drive Control

Move the cursor to this field and press <Enter>. The following fields will appear:

Current FSB Frequency

This field shows the detected FSB of the CPU.

Current DRAM Frequency

This field shows the detected frequency of the DRAM.

DRAM Clock

This field is used to select the clock speed of the DIMM.

- | | |
|----------------|--|
| <i>By SPD</i> | The EEPROM on a DIMM has SPD (Serial Presence Detect) data structure that stores information about the module such as the memory type, memory size, memory speed, etc. When this option is selected, the system will run according to the information in the EEPROM. |
| <i>100 MHz</i> | The memory clock speed will run at 200MHz. |
| <i>133 MHz</i> | The memory clock speed will run at 266MHz. |

DRAM Timing

This field is used to select the timing of the DRAM.

- | | |
|---------------|--|
| <i>By SPD</i> | The EEPROM on a DIMM has SPD (Serial Presence Detect) data structure that stores information about the module such as the memory type, memory size, memory speed, etc. When this option is selected, the system will run according to the information in the EEPROM. |
| <i>Manual</i> | It allows you to configure the fields that follow. The system will run according to the settings in these fields. |

SDRAM CAS Latency

The default setting is 3 which is 3 clock cycles for the CAS latency.

Bank Interleave

The options are 2 Bank, 4 Bank and Disabled.

Precharge to Active (Trp)

The options are 2T and 3T.

Active to Precharge (Tras)

The options are 5T and 6T.

Active to CMD (Trcd)

The options are 2T and 3T.

DRAM Burst Len

The options are 4 and 8.

DRAM Command Rate

The options are 1T Command and 2T Command.

AGP & P2P Bridge Control

Move the cursor to this field and press <Enter>. The following fields will appear:

AGP Aperture Size

This field is relevant to the memory-mapped graphics data of the AGP card installed in your system. Leave this in its default setting, which is 128M.

AGP Mode

This field is used to select the AGP mode of the AGP card installed on the mainboard. The default setting is "4X".

AGP Driving Control

Set this field to Manual only if there are compatibility problems with some AGP cards. When set to Manual, you must select a value in the "AGP Driving Value" field.

AGP Driving Value

This field is used to select a value for the AGP Driving control. We recommend that you leave this field in its default setting.

AGP Fast Write

Select Enabled to support the AGP Fast Write function.

AGP Master / WS Write

Set this field to Enabled to add one clock tick to AGP write operations.

AGP Master I WS Read

Set this field to Enabled to add one clock tick to AGP read operations.

CPU & PCI Bus Control

Move the cursor to this field and press <Enter>. The following fields will appear:

CPU to PCI Write Buffer

Enabled Writes from the CPU to the PCI bus are buffered to offset the speed difference between the CPU and PCI bus.

Disabled Writes are not buffered therefore the CPU must wait until the write cycle is complete before starting another write cycle.

PCI Master 0 WS Write

When enabled, writes to the PCI bus are executed with zero wait state.

PCI Delay Transaction

When enabled, this function frees up the PCI bus for other PCI masters during the PCI-to-ISA transactions. This allows PCI and ISA buses to be used more efficiently and prevents degradation of performance on the PCI bus when ISA accesses are made.

Memory Hole

This field is used to select the memory area that must not be addressed to the ISA bus.

System BIOS Cacheable

When this field is enabled, accesses to the system BIOS ROM addressed at F0000H-FFFFFH are cached, provided that the cache controller is enabled. The larger the range of the Cache RAM, the higher the efficiency of the system.

Video RAM Cacheable

When enabled, it allows the video RAM to be cacheable thus providing better video performance. If your graphics card does not support this function, leave this field in its default setting.

VGA Share Memory Size

This field is used to select the memory size that will be shared by the VGA.

FB Address Conversion

The options are Enabled and Disabled.

FB Page Close Prediction

The options are Enabled and Disabled.

3.1.4 Integrated Peripherals

Phoenix - AwardBIOS CMOS Setup Utility
Integrated Peripherals

		Item Help
▶ VIA OnChip IDE Device	Press Enter	Menu Level
▶ VIA OnChip PCI Device	Press Enter	
▶ Super IO Device	Press Enter	
Init Display First	PCI Slot	
OnChip USB1.1 Controller	All Enabled	
USB Keyboard Support	Disabled	
USB Mouse Support	Disabled	
IDE HDD Block Mode	Enabled	
Onboard LAN Boot ROM	Disabled	
↑↓←→ Move Enter:Select +/-/PU/PD:Value F10:Save ESC:Exit F1:General Help F5:Previous Values F6:Fail-Safe Defaults F7:Optimized Defaults		

The settings on the screen are for reference only. Your version may not be identical to this one.

VIA OnChip IDE Device

Move the cursor to this field and press <Enter>. The following fields will appear:

OnChip IDE Channel 0 and OnChip IDE Channel 1

These fields allow you to enable or disable the primary and secondary IDE controller. The default is Enabled. Select Disabled if you want to add a different hard drive controller:

IDE Prefetch Mode

This allows data and addresses to be stored in the internal buffer of the chip, thus reducing access time. Enable this field to achieve better performance.

IDE Primary Master/Slave PIO and IDE Secondary Master/Slave PIO

PIO means Programmed Input/Output. Rather than have the BIOS issue a series of commands to effect a transfer to or from the disk drive, PIO allows the BIOS to tell the controller what it wants and then let the controller and the CPU perform the

complete task by themselves. Your system supports five modes, 0 (default) to 4, which primarily differ in timing. When Auto is selected, the BIOS will select the best available mode after checking your drive.

- Auto* The BIOS will automatically set the system according to your hard disk drive's timing.
- Mode 0-4* You can select a mode that matches your hard disk drive's timing. Caution: Do not use the wrong setting or you will have drive errors.

IDE Primary Master/Slave UDMA and IDE Secondary Master/Slave UDMA

These fields allow you to set the Ultra DMA in use. When Auto is selected, the BIOS will select the best available option after checking your hard drive or CD-ROM.

- Auto* The BIOS will automatically detect the settings for you.
- Disabled* The BIOS will not detect these categories.

VIA OnChip PCI Device

Move the cursor to this field and press <Enter>. The following fields will appear:

VIA-3058 AC97 Audio

- Auto* Select this option when using the onboard audio codec.
- Disabled* Select this option when using a PCI sound card.

Onboard LAN (PMI I-EL/RAMA and PMI I-UL/RAMA only)

By default, the onboard LAN chip is enabled. If you are not using the onboard LAN, set this field to Disabled.

Super IO Device

Move the cursor to this field and press <Enter>. The following fields will appear:

Onboard FDC Controller

- Enabled* Enables the onboard floppy disk controller.
- Disabled* Disables the onboard floppy disk controller.

Onboard Serial Port 1 and Onboard Serial Port 2

- Auto* The system will automatically select an I/O address for the onboard serial port 1 and serial port 2.
- 3F8/IRQ4, 2F8/IRQ3, 3E8/IRQ4, 2E8/IRQ3* Allows you to manually select an I/O address for the onboard serial port 1 and serial port 2.
- Disabled* Disables the onboard serial port 1 and/or serial port 2.

SC Port Address/IRQ (PMI I-UL/RAMA only)

This field is used to select the SC port's address and IRQ. When selecting an address for the SC port, the IRQ will at the same time appear next to the address selected.

MS Port Address/IRQ (PMI I-UL/RAMA only)

This field is used to select the MS port's address and IRQ. When selecting an address for the MS port, the IRQ will at the same time appear next to the address selected.

SD Port Address/IRQ (PMI I-UL/RAMA only)

This field is used to select the SD port's address and IRQ. When selecting an address for the SD port, the IRQ will at the same time appear next to the address selected.



Important:

IRQs for Serial Port 1, Serial Port 2, Parallel Port, SC Port, MS Port and SD Port must be appropriately selected making sure each port uses a different IRQ. When selecting a port address for SC Port, MS Port and SD Port, the IRQ will at the same time appear next to the address selected. For example, if you selected "700/3" for the SC port, "700" is the port's address and "3" is its IRQ. Therefore you must not select IRQ 3 for the other ports.

UART Mode Select

The mainboard supports IrDA function for wireless connectivity between your computer and peripheral devices. You may not use IrDA (J10) and the COM 2 (J9) serial port at the same time. If you are using the COM 2 serial port, make sure this field is set to Normal.

To use the IrDA function, follow the steps below.

1. Connect your IrDA cable to connector J10 on the mainboard.
2. Set the "UART Mode Select" field to the type of IrDA standard supported by your IrDA peripheral/device (IrDA or ASKIR). For better transmission of data, your IrDA peripheral device must be within a 30° angle and within a distance of 1 meter.
3. Set the "Rx/D Tx/D Active", "IR Transmission Delay", "UR2 Duplex Mode" and "Use IR Pins" fields appropriately.

RxD, Tx/D Active

The options are Hi, Lo; Lo, Hi; Lo, Lo; and Hi, Hi.

IR Transmission Delay

If this option is Enabled, transmission of data will be slower. This is recommended when you encounter transmission problem with your device. The options are: Enabled and Disabled.

UR2 Duplex Mode

Half Data is completely transmitted before receiving data.

Full Transmits and receives data simultaneously.

Use IR Pins

The options are IR-Rx2Tx2 and Rx/D2, Tx/D2.

Onboard Parallel Port

378/IRQ7, 3BC/IRQ7, 278/IRQ5 Selects the I/O address and IRQ for the onboard parallel port.

Disabled Disables the onboard parallel port.

Parallel Port Mode

The options are SPP, EPP, ECP and ECP+EPP. These apply to standard specifications and will depend on the type and speed of your device. Refer to your peripheral's manual for the best option.

SPP

Allows normal speed operation but in one direction only.

“ECP (Extended Capabilities Port)”

Allows parallel port to operate in bidirectional mode and at a speed faster than the normal mode's data transfer rate.

“EPP (Enhanced Parallel Port)”

Allows bidirectional parallel port operation at maximum speed.

EPP Mode Select

This is used to select the EPP mode.

ECP Mode Use DMA

This is used to select the DMA channel used for the parallel port.

Game Port Address

This field is used to select the game port's address. The options are 201, 209 and Disabled.

Midi Port Address

This field is used to select the MIDI port's address. If you have selected the MIDI port's address, you may select its IRQ in the “Midi Port IRQ” field.

Midi Port IRQ

This field is used to select the MIDI port's IRQ.

Init Display First

This field is used to select whether to initialize AGP or PCI first when the system boots.

- AGP* When the system boots, it will first initialize AGP.
- PCI Slot* When the system boots, it will first initialize PCI.

OnChip USB I.I Controller

This field is used to select the USB I.I ports you want Enabled.

USB Keyboard Support

By default, USB Keyboard Support is Disabled. However, if you are using a USB keyboard under DOS, make sure to enable this function.

USB Mouse Support

This field is used to enable or disable the USB mouse.

IDE HDD Block Mode

Enabled The IDE HDD uses the block mode. The system BIOS will check the hard disk drive for the maximum block size the system can transfer. The block size will depend on the type of hard disk drive.

Disabled The IDE HDD uses the standard mode.

Onboard LAN Boot ROM (PMI I-EL/RAMA and PMI I-UL/RAMA only)

By default, this field is disabled. Enable this field if you wish to use the boot ROM (instead of a disk drive) to boot-up the system and access the local area network directly.

If you wish to change the boot ROM's settings, type the <Shift> and <F10> keys simultaneously when prompted during boot-up. Take note: you will be able to access the boot ROM's program (by typing <Shift> + <F10>) only when this field is enabled.

3.1.5 Power Management Setup

The Power Management Setup allows you to configure your system to most effectively save energy.

Phoenix - AwardBIOS CMOS Setup Utility
Power Management Setup

		Item Help
ACPI Function	Enabled	Menu Level
ACPI Suspend Type	S1(POS)	
Power Management Option	User Define	
HDD Power Down	Disabled	
Suspend Mode	Disabled	
Video Off Option	Suspend -> Off	
Video Off Method	V/H SYNC+Blank	
MODEM Use IRQ	3	
Soft-Off By PWRBTN	Instant-off	
Run VGABIOS if S3 Resume	Auto	
PWR Lost Resume State	Keep Off	
▶ IRQ/Event Activity Detect	Press Enter	
↑↓→← Move Enter:Select +/-/PU/PD:Váalue F10:Save ESC:Exit F1:General Help F5:Previous Values F6:Fail-Safe Defaults F7:Optimized Defaults		

The settings on the screen are for reference only. Your version may not be identical to this one.

ACPI Function

This function should be enabled only in operating systems that support ACPI. Currently, only Windows® 98/2000/ME/XP supports this function. If you want to use the Suspend to RAM function, make sure this field is enabled then select "S3(STR)" in the "ACPI Suspend Type" field.

ACPI Suspend Type

This field is used to select the type of Suspend mode.

- S1(POS) Enables the Power On Suspend function.
- S3(STR) Enables the Suspend to RAM function. If you are using the Windows® 98 operating system, refer to "Using the Suspend to RAM Function" in appendix A for more information.

Power Management Option

This field allows you to select the type (or degree) of power saving by changing the length of idle time that elapses before the "Suspend Mode" field is activated.

<i>Min Saving</i>	Minimum power saving time for Suspend mode = 1 hr.
<i>Max Saving</i>	Maximum power saving time for Suspend mode = 1 min.
<i>User Define</i>	Allows you to set the power saving time in the "Suspend Mode" field.

HDD Power Down

After the set time of system inactivity, the hard disk drive will be powered down while all other devices remain active.

Suspend Mode

This is selectable only when the Power Management field is set to User Define. When the system enters the Suspend mode according to the power saving time selected, the CPU and onboard peripherals will be shut off.

Video Off Option

<i>Always On</i>	The system BIOS will never turn off the screen.
<i>Suspend -> Off</i>	The screen is off when the system is in the Suspend mode.

Video Off Method

This determines the manner in which the monitor is blanked.

<i>VIH SYNC + Blank</i>	This will cause the system to turn off the vertical and horizontal synchronization ports and write blanks to the video buffer.
<i>Blank Screen</i>	This only writes blanks to the video buffer.
<i>DPMS Support</i>	Initializes display power management signaling. Select this if your video board supports it.

MODEM Use IRQ

This field is used to set an IRQ channel for the modem installed in your system.

Soft-Off by PWRBTN

This field allows you to select the method of powering off your system.

Delay 4 Sec Regardless of whether the Power Management field is enabled or disabled, if the power button is pushed and released in less than 4 sec, the system enters the Suspend mode. The purpose of this function is to prevent the system from powering off in case you accidentally “hit” or pushed the power button. Push and release again in less than 4 sec to restore. Pushing the power button for more than 4 seconds will power off the system.

Instant-Off Pressing and then releasing the power button at once will immediately power off your system.

Run VGABIOS if S3 Resume

When this field is set to Auto, the system will initialize the VGA BIOS from the S3 state.

PWR Lost Resume State

Keep Off When power returns after an AC power failure, the system's power is off. You must press the Power button to power-on the system.

Turn On When power returns after an AC power failure, the system will automatically power-on.

Last State When power returns after an AC power failure, the system will return to the state where you left off before power failure occurs. If the system's power is off when AC power failure occurs, it will remain off when power returns. If the system's power is on when AC power failure occurs, the system will power-on when power returns.

IRQ/Event Activity Detect

Move the cursor to this field and press <Enter>. The following fields will appear:

PS2KB Wakeup Select

Password To use a password to wake up the system, select this option then press <Enter>. Enter your password. You can enter up to 5 characters. Type in exactly the same password to confirm, then press <Enter>.



Important:

If you forgot the password, you must power-off the system, unplug the power cord and clear the CMOS data. Follow the steps in the "Jumper Settings for Clearing CMOS Data" section in chapter 2.

Ctrl+F1 Use the <Ctrl> and <F1> keys to wake up the system.

Disabled Disables the keyboard password function.

USB Resume from S3

If you are using the Wake-On-USB Keyboard/Mouse function with a device that is connected to the USB 1.1 port, set this field to Enabled. This function allows you to use a USB keyboard or USB mouse to wake up a system that is in the S3 (STR - Suspend To RAM) state.

VGA

When set to On, the system will respond and wake up to any VGA activity.

LPT & COM

Select the port you would like the system to respond and wake up when an event occurs on that port.

HDD & FDD

When set to On, the system will respond and wake up to any hard drive or floppy drive activity.

PCI Master

When set to On, the system will respond and wake up to any PCI or bus master activity.

Resume on PCI Event

If you are using the Wake-On-USB Keyboard/Mouse function with a device that is connected to the USB 2.0 port, set this field to Enabled. This function allows you to use a USB keyboard or USB mouse to wake up a system that is in the S3 (STR - Suspend To RAM) state.

You must also set this field to Enabled if your PCI card such as LAN card or modem card uses the PCI PME (Power Management Event) signal to remotely wake up the PC. Refer to the card's documentation for more information.

Resume On LAN/Ring

This field allows you to enable the Wake-On-LAN and Wake-On-Ring functions.

- If you are using a LAN card that supports the remote wake up function, set this field to Enabled. This will allow the network to remotely wake up a Soft Power Down (Soft-Off) PC. However, if your system is in the Suspend mode, you can wake up the system only through an IRQ or DMA interrupt. Your LAN card must support the remote wake up function. Refer to "Wake-On-LAN Connector" in chapter 2 for more information.
- When enabled, the system will power-on to respond to calls coming through an external or internal modem. Refer to "Wake-On-Ring Connector" in chapter 2 for more information.

Resume on Alarm

Enabled When Enabled, you can set the date and time you would like the Soft Power Down (Soft-Off) PC to power-on in the "Date (of Month)" and "Resume Time (hh:mm:ss)" fields. However, if the system is being accessed by incoming calls or the network prior to the date and time set in these fields, the system will give priority to the incoming calls or network.

Disabled Disables the automatic power-on function. (default)

Date (of Month)

- 0 The system will power-on everyday according to the time set in the "Resume Time (hh:mm:ss)" field.
- 1-31 Select a date you would like the system to power-on. The system will power-on on the set date, and time set in the "Resume Time (hh:mm:ss)" field.

Resume Time (hh:mm:ss)

This is used to set the time you would like the system to power-on. If you want the system to power-on everyday as set in the "Date (of Month)" field, the time set in this field must be later than the time of the RTC set in the Standard CMOS Features submenu.

IRQs Activity Monitoring

Move the cursor to this field and press <Enter>. The "Primary INTR", and "IRQ3" - "IRQ15" fields will appear. When enabled, access to the specified IRQ will cause the system to wake up completely from the power management mode. When disabled, the system will not wake up from the power management mode despite access to the specified IRQ.

3.1.6 PnP/PCI Configurations

This section shows how to configure the PCI bus system. It covers some very technical items and it is strongly recommended that only experienced users should make any changes to the default settings.

Phoenix - AwardBIOS CMOS Setup Utility
PnP/PCI Configurations

		Item Help
PNP OS Installed	No	Menu Level Default is Disabled. Select Enabled to reset Extended System Configuration Data (ESCD) when you exit Setup if you have installed a new add-on and the system reconfiguration has caused such a serious conflict that the OS cannot boot.
Reset Configuration Data	Disabled	
Resources Controlled By	Auto(ESCD)	
X IRQ Resources	Press Enter	
PCI/VGA Palette Snoop	Disabled	
Assign IRQ For VGA	Enabled	
Assign IRQ For USB	Enabled	
PCI Slot 1 Use IRQ	Auto	
PCI Slot 2 Use IRQ	Auto	
PCI Slot 3 Use IRQ	Auto	
↑↓→← Move Enter:Select +/-/PU/PD:Value F10:Save ESC:Exit F1:General Help F5:Previous Values F6:Fail-Safe Defaults F7:Optimized Defaults		

The settings on the screen are for reference only. Your version may not be identical to this one.

PNP OS Installed

The default setting is "No". The BIOS will detect the Plug and Play devices for some compatible resources.

Reset Configuration Data

Enabled The BIOS will reset the Extended System Configuration Data (ESCD) once automatically. It will then recreate a new set of configuration data.

Disabled The BIOS will not reset the configuration data.

Resources Controlled By

The Award Plug and Play BIOS has the capability to automatically configure all of the boot and Plug and Play compatible devices.

Auto(ESCD) The system will automatically detect the settings for you.

Manual Choose the specific IRQ resources in the "IRQ Resources" field.

IRQ Resources

Move the cursor to this field and press <Enter>. The “IRQ-3” to “IRQ-15” fields will appear. Set each system interrupt to either PCI Device or Reserved.

PCI/VGA Palette Snoop

This field determines whether the MPEG ISA/VESA VGA cards can work with PCI/VGA or not. The default value is Disabled.

- Enabled* MPEG ISA/VESA VGA cards work with PCI/VGA.
- Disabled* MPEG ISA/VESA VGA cards does not work with PCI/VGA.

Assign IRQ for VGA

When Enabled, the system automatically assigns an IRQ for the VGA card installed. Your VGA card will need an IRQ only when using the video capture function of the card. If you are not using this function and a new device requires an IRQ, you can set this field to Disabled. The IRQ (previously occupied by the VGA card) will be available for your new device.

Assign IRQ for USB

When Enabled, the system automatically assigns an IRQ for the USB device connected to your system. However, if you are not using USB devices and a new device requires an IRQ, set this field to Disabled. The IRQ previously occupied by the USB device will be available for the new device.

PCI Slot 1 Use IRQ to PCI Slot 3 Use IRQ

By default, an IRQ is automatically assigned to the PCI devices that are installed in the PCI slots.

If a PCI device has not been assigned an IRQ, you must manually assign an IRQ for the device. During system boot-up, you will see "NA" for the device that does not have an IRQ assigned.

3.1.7 PC Health Status

Phoenix - AwardBIOS CMOS Setup Utility
PC Health Status

CPU Warning Temperature	Disabled	Item Help
Current System Temp.	27C/80F	Menu Level
Current CPU Temperature	37C/98F	
Current CPU FAN Speed	0 RPM	
Current Chassis FAN Speed	0 RPM	
CPU(V)	1.75 V	
+3.3 V	3.35 V	
+5 V	4.90 V	
+12 V	11.85 V	
-12 V	-11.45 V	
-5 V	-5.14 V	
VBAT(V)	3.24 V	
5VSB(V)	5.37 V	
Warning_Beep	Enabled	
↑↓←→ Move Enter:Select +/-/PU/PD:Value F10:Save ESC:Exit F1:General Help F5:Previous Values F6:Fail-Safe Defaults F7:Optimized Defaults		

The settings on the screen are for reference only. Your version may not be identical to this one.

CPU Warning Temperature

This field is used to select the CPU's temperature limit. Once the system has detected that the CPU's temperature exceeded the limit set in this field, a warning alarm will beep if the "Warning_Beep" field is set to Enabled.

Current System Temp., Current CPU Temperature, Current CPU Fan Speed and Current Chassis Fan Speed

These fields show the internal temperature of the system, current temperature of the CPU, and the current fan speed of the CPU and chassis fans in RPM (Revolutions Per Minute).

CPU(V)

These fields show the voltage of the processor:

+3.3V, +5V, +12V, -12V, -5V, VBAT(V) and 5VSB(V)

These fields show the output voltage of the power supply.

Warning_Beep

Set this field to Enabled so that the warning alarm will beep when the CPU's temperature exceeded the limit set in the "CPU Warning Temperature" field.



Note:

The onboard hardware monitor function is capable of detecting "system health" conditions but if you want a warning message to pop-up or a warning alarm to sound when an abnormal condition occurs, you must install the Hardware Monitor utility. This utility is included in the CD that came with the mainboard. Refer to the Hardware Monitor section in chapter 4 for more information.

3.1.8 Frequency/Voltage Control

Phoenix - AwardBIOS CMOS Setup Utility
Frequency/Voltage Control

CPU Clock	100MHz	Item Help
Auto Detect PCI/DIMM Clk	Enabled	Menu Level
Spread Spectrum	Disabled	
CPU Clock Ratio	8 X	
↑↓←→ Move Enter:Select +/-/PU/PD:Value F10:Save ESC:Exit F1:General Help F5:Previous Values F6:Fail-Safe Defaults F7:Optimized Defaults		

The settings on the screen are for reference only. Your version may not be identical to this one.

CPU Clock

This field provides several options for selecting the external system bus clock of the CPU. The available options allow you to adjust the CPU's bus clock in 1MHz increment. The default setting is "100MHz".



Important:

Overclocking may result in the processor's or system's instability and is not guaranteed to provide better system performance.

Auto Detect PCI/DIMM Clk

When enabled, the system will automatically send clock signals to existing PCI or DIMM devices.

Spread Spectrum

Leave this field in its default setting. Do not alter this setting unless advised by an engineer or technician.

CPU Clock Ratio

This field is used to select the CPU's frequency ratio.



Important:

The frequency ratio of some processors may have been locked by the manufacturer. If you are using this kind of processor, setting an extended ratio for the processor will have no effect. The system will instead use its factory default ratio.

If, in the "CPU Clock" or "CPU Clock Ratio" field, you selected an option other than the default setting and is unable to boot up the system, there are 2 methods of booting up the system and going back to its default setting.

Method 1:

Clear the CMOS data by setting JP2 to 2-3 On. All fields in the BIOS Setup will automatically be set to their default settings.

Method 2:

Press the <Insert> key and power button simultaneously, then release the power button first. Keep-on pressing the <Insert> key until the power-on screen appears. This will allow the system to boot according to the FSB of the processor. Now press the key to enter the main menu of the BIOS. Select "Frequency/Voltage Control" and set the "CPU Clock" or "CPU Clock Ratio" field to its default setting or an appropriate bus clock.



Note:

Use a PS/2 or AT (requires a DIN to mini DIN adapter) keyboard for method 2.

3.1.9 Load Fail-Safe Defaults

The “Load Fail-Safe Defaults” option loads the troubleshooting default values permanently stored in the ROM chips. These settings are not optimal and turn off all high performance features. You should use these values only if you have hardware problems. Highlight this option in the main menu and press <Enter>. The message below will appear:

Load Fail-Safe Defaults (Y/N)? N

If you want to proceed, type <Y> and press <Enter>. The default settings will be loaded.

3.1.10 Load Optimized Defaults

The “Load Optimized Defaults” option loads optimized settings from the BIOS ROM. Use the default values as standard values for your system. Highlight this option in the main menu and press <Enter>. The message below will appear:

Load Optimized Defaults (Y/N)? N

Type <Y> and press <Enter> to load the Setup default values.

3.1.11 Set Supervisor Password

If you want to protect your system and setup from unauthorized entry, set a supervisor's password with the "System" option selected in the Advanced BIOS Features. If you want to protect access to setup only, but not your system, set a supervisor's password with the "Setup" option selected in the Advanced BIOS Features. You will not be prompted for a password when you cold boot the system.

Use the arrow keys to highlight "Set Supervisor Password" and press <Enter>. The message below will appear:

Enter Password:

Type in the password. You are limited to eight characters. When done, the message below will appear:

Confirm Password:

You are asked to verify the password. Type in exactly the same password. If you type in a wrong password, you will be prompted to enter the correct password again. To delete or disable the password function, highlight "Set Supervisor Password" and press <Enter>, instead of typing in a new password. Press the <Esc> key to return to the main menu.

3.1.12 Set User Password

If you want another user to have access only to your system but not to setup, set a user's password with the "System" option selected in the Advanced BIOS Features. If you want a user to enter a password when trying to access setup, set a user's password with the "Setup" option selected in the Advanced BIOS Features.

Using user's password to enter Setup allows a user to access only "Set User Password" that appears in the main menu screen. Access to all other options is denied. To set, confirm, verify, disable or delete a user's password, follow the procedures described in the section "Set Supervisor Password".

3.1.13 Save & Exit Setup

When all the changes have been made, highlight “Save & Exit Setup” and press <Enter>. The message below will appear:

Save to CMOS and Exit (Y/N)? N

Type “Y” and press <Enter>. The modifications you have made will be written into the CMOS memory, and the system will reboot. You will once again see the initial diagnostics on the screen. If you wish to make additional changes to the setup, press <Ctrl> <Alt> <Esc> simultaneously or after memory testing is done.

3.1.14 Exit Without Saving

When you do not want to save the changes you have made, highlight “Exit Without Saving” and press <Enter>. The message below will appear:

Quit Without Saving (Y/N)? N

Type “Y” and press <Enter>. The system will reboot and you will once again see the initial diagnostics on the screen. If you wish to make any changes to the setup, press <Ctrl> <Alt> <Esc> simultaneously or after memory testing is done.

3.2 Updating the BIOS

To update the BIOS, you will need the new BIOS file and a flash utility, AWDFLASH.EXE. Please contact technical support or your sales representative for these files.

1. Save the BIOS along with the flash utility AWDFLASH.EXE to a floppy disk.
2. Insert the floppy disk into a floppy drive and power-on the system. Press the <Alt> and <F2> keys simultaneously. The utility, which works only in DOS mode, will update the new BIOS file to the programmable flash EEPROM that is on the mainboard. The new BIOS will permanently replace the original BIOS content after flashing.

Chapter 4 - Supported Software

4.1 Desktop Management Interface (DMI)

The mainboard comes with a DMI built into the BIOS. DMI, along with the appropriately networked software, is designed to make inventory, maintenance and troubleshooting of computer systems easier. With DMI, a network administrator or MIS engineer can remotely access some information about a particular computer system without physically going to it. Quite often a service call may be unnecessary as the problem can be solved remotely.

The DMI utility in the BIOS automatically records various information about your system configuration. Information about the type and speed of CPU, type and amount of memory for each memory slot, BIOS revision level, types of add-in PCI boards and components, certain revision numbers of hardware installed, etc. are automatically detected and stored in the DMI pool, which is a part of the mainboard's Plug and Play BIOS. Additional information, such as ISA based peripherals, which may not be automatically detected, can be manually recorded in the DMI pool by using the Add DMI menu. The DMI pool data is then verified or updated whenever the system hardware or setup is altered.

4.1.1 Running the DMI Utility

To run the DMI utility, type: DMICFG.EXE.

The DMI utility must run in real mode with at least 180K of base memory. Memory managers like HIMEM.SYS (required by Windows) must not be installed. You may do this by using one of the 3 methods listed below.

1. Boot up from a system diskette without the AUTOEXEC.BAT and CONFIG.SYS files,
2. "REM" HIMEM.SYS in the CONFIG.SYS, or
3. Press <F5> during bootup to bypass your AUTOEXEC.BAT and CONFIG.SYS files.

4.1.2 Using the DMI Utility

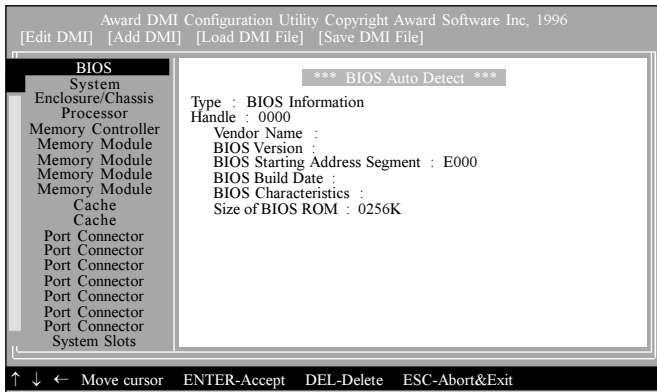

The four menus located on top of the DMI Configuration Utility screen are Edit DMI, Add DMI, Load DMI File and Save DMI File. Use the ← or → (left or right) arrow keys to select a menu from the Menu bar.

On the left side of the screen is a list of the system configuration items. Use the ↑ or ↓ (up or down) arrow keys to select an item.

The commands at the bottom of the screen will allow you to navigate through the various setup menus.

Edit DMI

1. Use the ← or → arrow keys to select the Edit DMI menu.
2. Highlight the item on the left screen that you would like to edit by using the ↑ or ↓ arrow keys, then press <Enter>.
3. The cursor will move to the screen you select allowing you to edit information. The screen will also display the auto-detected information.
4. Press <F10> to update the edited information into the flash ROM.

Add DMI

1. Use the ← or → arrow keys to select the Add DMI menu.
2. Highlight the item on the left screen that you would like to add by using the ↑ or ↓ arrow keys, then press <Enter>.
3. The cursor will move to the screen you select allowing you to enter information about the added item.
4. Press <F10> to save information into the flash ROM.

To view information about the added items, go to the Edit DMI menu.

Load DMI File

1. Use the ← or → arrow keys to select the Load DMI File menu.
2. The following message will appear:

Press [Enter] to select DMI file for load

Press <Enter>.

3. The DMI files will appear on the screen. Select the file you would like to load and press <Enter>.
4. The following message will appear:

Do you want to execute? (Y/N)

Type <Y>. All previous DMI structures will be destroyed and the new file will be saved into the flash ROM.

Save DMI File

1. Use the ← or → arrow keys to select the Save DMI File menu.
2. The following message will appear:

Press [Enter] to select DMI file for save

Press <Enter>.

3. Enter the directory and filename under which you would like the DMI file saved.

4.2 Hardware Monitor

The mainboard comes with the Hardware Monitor utility contained in the provided CD. It is capable of monitoring the system's hardware conditions such as the temperature of the CPU and system, voltage, and speed of the CPU and chassis fans. It also allows you to manually set a range to the items being monitored. If the values are over or under the set range, a warning message will pop-up. The utility can also be configured so that a beeping alarm will sound whenever an error occurs. We recommend that you use the "Default Setting" which is the ideal setting that would keep the system in good working condition.



Note:

Use this utility only in Windows® 98, Windows® 98 SE, Windows® ME, Windows® 2000, Windows NT® 4.0 or Windows® XP operating system.

To install the utility, insert the CD into a CD-ROM drive. The autorun screen (Main Board Utility CD) will appear. Click the "Hardware Monitor" button to install the utility. Refer to its "readme" file for instructions on using the utility.

4.3 VIA Service Pack

The CD in the mainboard package also comes with the VIA Service Pack. The service pack includes the following drivers.

- VIA ATAPI Vendor Support Driver
- AGP VxD Driver
- IRQ Routing Miniport Driver
- VIA INF Driver

To install the drivers, insert the CD into a CD-ROM drive. The autorun screen (Main Board Utility CD) will appear. Click the "VIA Service Pack" button. For installation instructions or information, click the "Read Me" button in the autorun screen.

VIA Service Pack Installation Notes

The “AGP VxD Driver” and “VIA INF Driver” drivers in the “VIA Service Pack” are supported in Windows® 98, Windows® 98 SE, Windows® ME and Windows® 2000.

You must first install the VIA Service Pack prior to installing any other drivers. However, this may not be the case for some AGP cards. Please read carefully the following information.



Important:

The VGA driver that came with some AGP cards is already bundled with the AGP VxD driver. Since the version of the bundled VxD driver may be older than the one provided in the CD, installing the bundled VxD driver may cause problems. If you are using this type of card, we recommend that you install first the AGP card's VGA driver before installing the VIA Service Pack.

To install the VIA Service pack, please follow the steps below.

1. Insert the CD that came with the mainboard package into a CD-ROM drive. The autorun screen (Main Board Utility CD) will appear.
2. Click “VIA Service Pack”.
3. The “Welcome” screen will appear. Click “Next”. Please read the “VIA Service Pack readme” carefully before proceeding to step 4.
4. Follow the prompts on the screen to complete the installation.
5. Reboot the system for the drivers to take effect.

4.4 Audio Drivers and Software Applications

The CD in the mainboard package also includes audio drivers and audio playback software for Windows® 98, Windows® 98 SE, Windows® ME, Windows NT® 4.0 and Windows® 2000 operating systems. For installation instructions or information about their corresponding “readme”, click the “Read Me” button in the autorun screen. The autorun screen normally appears after the CD is inserted into a CD-ROM drive.

1. Insert the CD that came with the mainboard package into a CD-ROM drive. The autorun screen (Main Board Utility CD) will appear.
2. Click “Audio Driver”.
3. Follow the prompts on the screen to complete installation.
4. Restart the system.

4.5 Onboard LAN Drivers for Windows (PMI I-EL/RAMA and PMI I-UL/RAMA only)

The LAN driver for Windows NT® 4.0 does not support “Autorun”. Once the system has detected the Realtek RTL8100 fast ethernet controller, it will prompt you to install the driver for the operating system you are using. The driver is in the “RTL8100” root directory of the CD.

The LAN drivers for Windows® 98, Windows® 98 SE, Windows® ME, Windows® 2000 and Windows® XP support “Autorun”. When you insert the CD into a CD-ROM drive, the “Autorun” screen will appear. Click “Realtek LAN Drivers”, then follow the prompts on the screen to complete installation.

4.6 Graphics Drivers

1. Insert the CD that came with the system board package into a CD-ROM drive. The autorun screen (Main Board Utility CD) will appear.
2. Click "VIA VGA Driver".
3. Follow the prompts on the screen to complete installation.
4. Restart the system.

4.7 VIA USB 2.0 Driver (PMII-UL/RAMA only)

If you are using a USB device that is connected to the USB 2.0 port, you must install the VIA USB 2.0 Driver so that the device can be recognized and configured properly in the system.

To install the driver, insert the CD into a CD-ROM drive. The autorun screen (Main Board Utility CD) will appear. Click the "VIA USB 2.0 Driver" button to install the driver. Refer to its "readme" file for instructions on using the driver.

4.8 Winbond Smart I/O Drivers (PMII-UL/RAMA only)

Install the Winbond Smart I/O Drivers if you are using a Smart Card, Memory Stick or Secure Digital Memory Card.

To install the driver, insert the CD into a CD-ROM drive. The autorun screen (Main Board Utility CD) will appear. Click the "Winbond Smart I/O Drivers" button to install the driver. Refer to its "readme" file for instructions on using the driver.

4.9 Winbond SmartCard Application (PMII-UL/RAMA only)

If you are using a Smart Card, install the Winbond SmartCard Application to configure the the card for system security.

To install the application, insert the CD into a CD-ROM drive. The autorun screen (Main Board Utility CD) will appear. Click the

"Winbond SmartCard Application" button to install the application. Refer to its "readme" file for instructions on using the application.

4.10 Microsoft DirectX 8.1 Driver

1. Insert the CD that came with the mainboard package into a CD-ROM drive. The autorun screen (Main Board Utility CD) will appear.
2. Click "Microsoft DirectX 8.1 Driver".
3. Click "Yes" to continue.
4. Follow the prompts on the screen to complete installation.
5. Restart the system.

4.11 Drivers and Utilities Installation Notes

1. "Autorun" ONLY supports the Windows® 98, Windows® 98 SE, Windows® ME, Windows® 2000, Windows NT® 4.0 and Windows® XP operating systems. If after inserting the CD, "Autorun" did not automatically start (which is, the Main Board Utility CD screen did not appear), please go directly to the root directory of the CD and double-click "Setup".
2. All steps or procedures to install software drivers are subject to change without notice as the softwares are occasionally updated. Please refer to the readme files, if available, for the latest information.

Appendix A - Using the Suspend to RAM Function

A.1 Using the Suspend to RAM Function

If you are using the Windows® 98 operating system, please follow the steps below.

1. Select "Power Management Setup" in the main menu screen and press <Enter>.
2. In the "ACPI Function" field, select "Enabled".
3. In the "ACPI Suspend Type" field, select "S3(STR)".

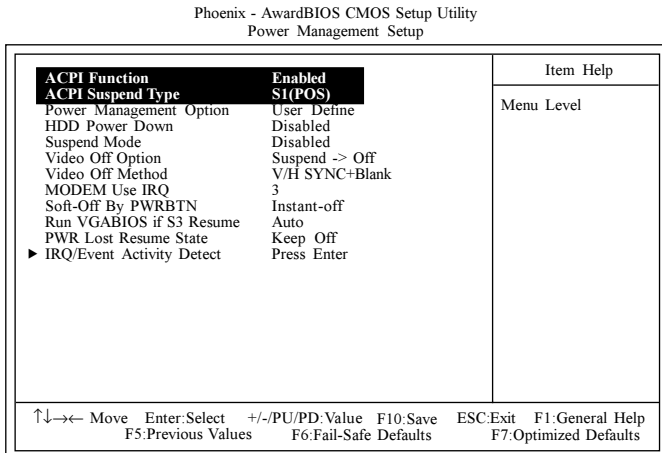

The settings on the screen are for reference only. Your version may not be identical to this one.

4. Press <Esc> to return to the main menu.
5. Select "Save & Exit Setup" and press <Enter>. Type <Y> and press <Enter>.
6. Install Windows® 98 by typing the following parameter. This is to ensure that the ACPI function is supported.

[drive]:>setup /p j

If you have previously installed Windows® 98, you need to upgrade the system in order to support ACPI. Please contact Microsoft for upgrade information.

Using the Suspend to RAM Function

7. Boot Windows® 98. In the Windows® 98 desktop, click the Start button. Move the cursor to Settings, then click Control Panel.

To check whether ACPI was properly installed, double-click the System icon. In the System Properties dialog box, click the “Device Manager” tab. In “View devices by type”, click “System devices”.

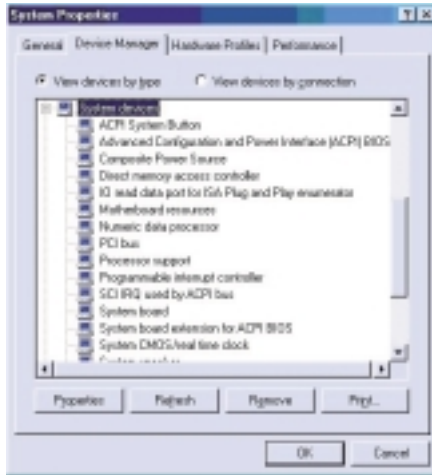

8. Double-click the System icon. In the System Properties dialog box, click the Performance tab.



Using the Suspend to RAM Function

9. Click File System. In the “Typical role of this computer” field, select “Mobile or docking system”. Click Apply, then click OK. Restart the computer.

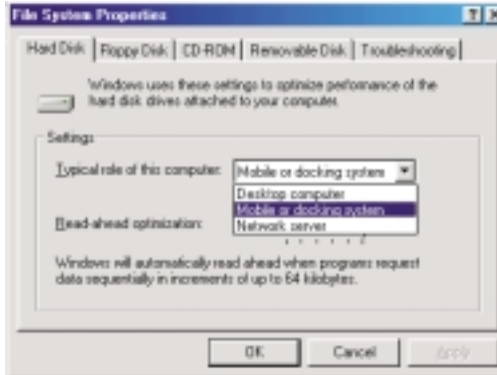

10. Repeat step 7 to open the Control Panel dialog box. Double-click the Power Management icon.
11. Click the Advanced tab. In the “When I press the power button on my computer” field, select “Standby”.

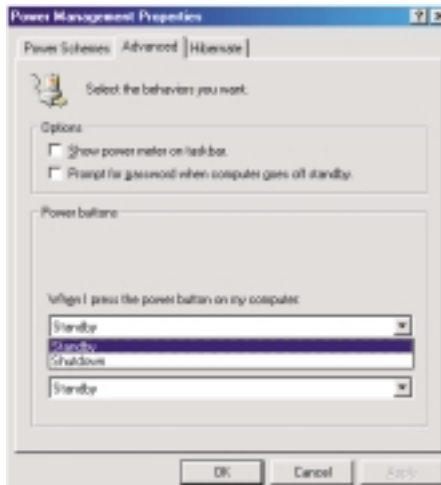

12. After completing the steps above and you want to power-off the computer; you do not need to go through the process of closing files, applications and operating system. You can power-off the computer at once by pressing the power button or selecting "Standby" when you shut down Windows® 98.

To power-on the computer; just press the power button. The operating session where you left off when you power-off the computer will resume in not more than 8 seconds.

If you have changed the color or resolution (in the Display Properties dialog box), do not apply the settings without restarting. You must restart the computer.

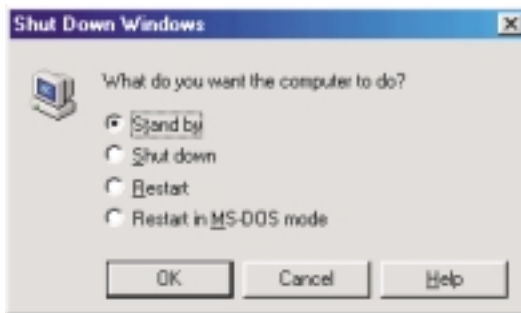

Important:

If you are unable to use the Suspend to RAM function (after performing the steps above in Windows® 98 or when you are in Windows® 2000/ME/XP), please check whether your add-in cards or devices support this function. If this function is not supported, you need to download the appropriate driver from their respective website.

Appendix B - System Error Message

When the BIOS encounters an error that requires the user to correct something, either a beep code will sound or a message will be displayed in a box in the middle of the screen and the message, PRESS F1 TO CONTINUE, CTRL-ALT-ESC or DEL TO ENTER SETUP, will be shown in the information box at the bottom. Enter Setup to correct the error.

B.1 POST Beep

There are two kinds of beep codes in the BIOS. One code indicates that a video error has occurred and the BIOS cannot initialize the video screen to display any additional information. This beep code consists of a single long beep followed by three short beeps. The other code indicates that a DRAM error has occurred. This beep code consists of a single long beep.

B.2 Error Messages

One or more of the following messages may be displayed if the BIOS detects an error during the POST. This list indicates the error messages for all Awards BIOSes:

CMOS BATTERY HAS FAILED

The CMOS battery is no longer functional. It should be replaced.



Caution:

Danger of explosion if battery incorrectly replaced. Replace only with the same or equivalent type recommended by the manufacturer. Dispose of used batteries according to the battery manufacturer's instructions.

CMOS CHECKSUM ERROR

Checksum of CMOS is incorrect. This can indicate that CMOS has become corrupt. This error may have been caused by a weak battery. Check the battery and replace if necessary.

DISPLAY SWITCH IS SET INCORRECTLY

The display switch on the mainboard can be set to either monochrome or color. This indicates the switch is set to a different

setting than indicated in Setup. Determine which setting is correct, either turn off the system and change the jumper or enter Setup and change the VIDEO selection.

FLOPPY DISK(S) fail (80)

Unable to reset floppy subsystem.

FLOPPY DISK(S) fail (40)

Floppy type mismatch.

Hard Disk(s) fail (80)

HDD reset failed.

Hard Disk(s) fail (40)

HDD controller diagnostics failed.

Hard Disk(s) fail (20)

HDD initialization error.

Hard Disk(s) fail (10)

Unable to recalibrate fixed disk.

Hard Disk(s) fail (08)

SectorVerify failed.

Keyboard is locked out - Unlock the key

The BIOS detects that the keyboard is locked. Keyboard controller is pulled low.

Keyboard error or no keyboard present

Cannot initialize the keyboard. Make sure the keyboard is attached correctly and no keys are being pressed during the boot.

Manufacturing POST loop

System will repeat POST procedure infinitely while the keyboard controller is pull low. This is also used for the M/B burn in test at the factory.

BIOS ROM checksum error - System halted

The checksum of ROM address F0000H-FFFFFFH is bad.

Memory test fail

The BIOS reports memory test fail if the memory has error(s).

Appendix C - Troubleshooting

C.1 Troubleshooting Checklist

This chapter of the manual is designed to help you with problems that you may encounter with your personal computer. To efficiently troubleshoot your system, treat each problem individually. This is to ensure an accurate diagnosis of the problem in case a problem has multiple causes.

Some of the most common things to check when you encounter problems while using your system are listed below.

1. The power switch of each peripheral device is turned on.
2. All cables and power cords are tightly connected.
3. The electrical outlet to which your peripheral devices are connected is working. Test the outlet by plugging in a lamp or other electrical device.
4. The monitor is turned on.
5. The display's brightness and contrast controls are adjusted properly.
6. All add-in boards in the expansion slots are seated securely.
7. Any add-in board you have installed is designed for your system and is set up correctly.
8. For further technical support, please visit the VIARAMA website at www.viarama.com.

Monitor/Display

If the display screen remains dark after the system is turned on:

1. Make sure that the monitor's power switch is on.
2. Check that one end of the monitor's power cord is properly attached to the monitor and the other end is plugged into a working AC outlet. If necessary, try another outlet.
3. Check that the video input cable is properly attached to the monitor and the system's display adapter.
4. Adjust the brightness of the display by turning the monitor's brightness control knob.

The picture seems to be constantly moving.

1. The monitor has lost its vertical sync. Adjust the monitor's vertical sync.
2. Move away any objects, such as another monitor or fan, that may be creating a magnetic field around the display.
3. Make sure your video card's output frequencies are supported by this monitor.

The screen seems to be constantly wavering.

1. If the monitor is close to another monitor, the adjacent monitor may need to be turned off. Fluorescent lights adjacent to the monitor may also cause screen wavering.

Power Supply

When the computer is turned on, nothing happens.

1. Check that one end of the AC power cord is plugged into a live outlet and the other end properly plugged into the back of the system.
2. Make sure that the voltage selection switch on the back panel is set for the correct type of voltage you are using.
3. The power cord may have a "short" or "open". Inspect the cord and install a new one if necessary.

Floppy Drive

The computer cannot access the floppy drive.

1. The floppy diskette may not be formatted. Format the diskette and try again.
2. The diskette may be write-protected. Use a diskette that is not write-protected.
3. You may be writing to the wrong drive. Check the path statement to make sure you are writing to the targeted drive.
4. There is not enough space left on the diskette. Use another diskette with adequate storage space.

Hard Drive

Hard disk failure.

1. Make sure the correct drive type for the hard disk drive has been entered in the BIOS.
2. If the system is configured with two hard drives, make sure the bootable (first) hard drive is configured as Master and the second hard drive is configured as Slave. The master hard drive must have an active/bootable partition.

Excessively long formatting period.

1. If your hard drive takes an excessively long period of time to format, it is likely a cable connection problem. However, if your hard drive has a large capacity, it will take a longer time to format.

Parallel Port

The parallel printer doesn't respond when you try to print.

1. Make sure that your printer is turned on and that the printer is on-line.
2. Make sure your software is configured for the right type of printer attached.
3. Verify that the onboard LPT port's I/O address and IRQ settings are configured correctly.
4. Verify that the attached device works by attaching it to a parallel port that is working and configured correctly. If it works, the printer can be assumed to be in good condition. If the printer remains inoperative, replace the printer cable and try again.

Serial Port

The serial device (modem, printer) doesn't output anything or is outputting garbled characters.

1. Make sure that the serial device's power is turned on and that the device is on-line.
2. Verify that the device is plugged into the correct serial port on the rear of the computer:
3. Verify that the attached serial device works by attaching it to a serial port that is working and configured correctly. If the serial device does not work, either the cable or the serial device has a problem. If the serial device works, the problem may be due to the onboard I/O or the address setting.
4. Make sure the COM settings and I/O address are configured correctly.

Keyboard

Nothing happens when a key on the keyboard was pressed.

1. Make sure the keyboard is properly connected.
2. Make sure there are no objects resting on the keyboard and that no keys are pressed during the booting process.

Mainboard

1. Make sure the add-in card is seated securely in the expansion slot. If the add-in card is loose, power off the system, re-install the card and power up the system.
2. Check the jumper settings to ensure that the jumpers are properly set.
3. Verify that all memory modules are seated securely into the memory sockets.
4. Make sure the memory modules are in the correct locations.
5. If the board fails to function, place the board on a flat surface and seat all socketed components. Gently press each component into the socket.
6. If you made changes to the BIOS settings, re-enter setup and load the BIOS defaults.

Free Manuals Download Website

<http://myh66.com>

<http://usermanuals.us>

<http://www.somanuals.com>

<http://www.4manuals.cc>

<http://www.manual-lib.com>

<http://www.404manual.com>

<http://www.luxmanual.com>

<http://aubethermostatmanual.com>

Golf course search by state

<http://golfingnear.com>

Email search by domain

<http://emailbydomain.com>

Auto manuals search

<http://auto.somanuals.com>

TV manuals search

<http://tv.somanuals.com>