

**PC 8172**  
**17" TFT Expandable Intel<sup>®</sup> Core<sup>™</sup> 2 Duo**  
**Industrial Panel PC with 2 PCI**  
**User's Manual**



## **Disclaimers**

This manual has been carefully checked and believed to contain accurate information. Acnodes Corp. assumes no responsibility for any infringements of patents or any third party's rights, and any liability arising from such use.

ACNODES does not warrant or assume any legal liability or responsibility for the accuracy, completeness or usefulness of any information in this document. ACNODES does not make any commitment to update the information in this manual.

ACNODES reserves the right to change or revise this document and/or product at any time without notice.

No part of this document may be reproduced, stored in a retrieval system, or transmitted, in any form or by any means, electronic, mechanical, photocopying, recording, or otherwise, without the prior written permission of Acnodes Corp.

**♥ Copyright 2008 Acnodes Corp. All  
Rights Reserved  
August 2008, Version A1**

## Safety Approvals

← 格式化: 項目符號及編號

🗨️ CE Marking

🗨️ FCC Class A

### 🗨️ FCC Compliance

This equipment has been tested in compliance with the limits for a Class A digital device, pursuant to Part 15 of the FCC Rules. These limits are meant to provide reasonable protection against harmful interference in a residential installation. If not installed and used in accordance with proper instructions, this equipment might generate or radiate radio frequency energy and cause harmful interference to radio communications. However, there is no guarantee that interference will not occur in a particular installation. If this equipment does cause harmful interference to radio or television reception, which can be determined by turning the equipment off and on, the user is encouraged to try to correct the interference by one or more of the following methods:

1. Reorient or relocate the receiving antenna.
2. Increase the separation between the equipment and receiver.
3. Connect the equipment to another outlet of a circuit that doesn't connect with the receiver.
4. Consult the dealer or an experienced radio/TV technician for help.

Shielded interface cables must be used in order to comply with the emission limits.

## Safety Precautions

Before getting started, please read the following important safety precautions.

1. The **PC 8172 Series** does not come equipped with an operating system. An operating system must be loaded first before installing any software into the computer.
2. Be sure to ground yourself to prevent static charge when installing the internal components. Use a grounding wrist strap and place all electronic components in any static-shielded devices. Most electronic components are sensitive to static electrical charge.
3. Disconnect the power cord from the **PC 8172 Series** before any installation. Be sure both the system and external devices are turned OFF. A sudden surge of power could ruin sensitive components that the **PC 8172 Series** must be properly grounded.
4. The brightness of the flat panel display will be getting weaker as a result of frequent usage. However, the operating period varies depending on the application environment.
5. Turn OFF the system power before cleaning. Clean the system using a cloth only. Do not spray any liquid cleaner directly onto the screen. The **PC 8172 Series** may come with or w/o a touch screen. Although the touch screen is chemical resistant, it is recommended that you spray the liquid cleaner on a cloth first before wiping the screen. In case your system comes without the touch screen, you must follow the same procedure and not spray any cleaner on the flat panel directly.
6. Avoid using sharp objects to operate the touch screen. Scratches on the touch screen may cause malfunction or internal failure to the touch screen.
7. The flat panel display is not susceptible to shock or vibration. When assembling the **PC 8172 Series**, make sure it is securely installed.
8. Do not open the system's back cover. If opening the cover for maintenance is a must, only a trained technician is allowed to do so. Integrated circuits on computer boards are sensitive to static electricity. To avoid damaging chips from electrostatic discharge, observe the following precautions:

- ⌘ Before handling a board or integrated circuit, touch an unpainted portion of the system unit chassis for a few seconds. This will help to discharge any static electricity on your body.
- ⌘ When handling boards and components, wear a wrist-grounding strap, available from most electronic component stores.

## **Trademarks Acknowledgments**

ACNODES is a trademark of Acnodes Corp.

IBM, PC/AT, PS/2, VGA are trademarks of International Business Machines Corporation.

Intel<sup>®</sup> and Pentium<sup>®</sup> are registered trademarks of Intel Corporation.  
MS-DOS, Microsoft C and QuickBASIC are trademarks of Microsoft Corporation.

VIA is a trademark of VIA Technologies, Inc.

SST is a trademark of Silicon Storage Technology, Inc.

UMC is a trademark of United Microelectronics Corporation.

Other brand names and trademarks are the properties and registered brands of their respective owners.

## Table of Contents

<b>Disclaimers</b> .....	<b>ii</b>
<b>Safety Approvals</b> .....	<b>iii</b>
<b>Safety Precautions</b> .....	<b>iv</b>
<b>Chapter 1</b> .....	<b>1</b>
1.1 General Description .....	2
1.2 System Specifications .....	3
1.2.1 Main CPU Board .....	3
1.2.2 I/O System .....	3
1.2.3 System Specification .....	4
1.3 Dimensions .....	6
1.4 Front View and I/O Outlets .....	7
1.4.1 Front View .....	7
1.4.2 I/O Outlets .....	8
1.5 Package List .....	9
<b>Chapter 2</b> .....	<b>11</b>
2.1 Installing the CPU and DRAM .....	11
2.2 Installing the the Hard Disk Drive .....	14
2.3 CD-ROM Installation .....	21
2.4 Add-on Card Installation .....	22
2.5 Serial Port Interface .....	24
2.6 DVI-I .....	24
2.7 Ethernet .....	26
2.8 Mountings Way – Panel/ Rack .....	27
2.8.1 Panel Mounting .....	27
2.8.2 Rack Mounting .....	28
<b>Chapter 3</b> .....	<b>29</b>
3.1 Entering Setup .....	29
3.2 Control Keys .....	30
3.3 Getting Help .....	30
3.4 The Main Menu .....	31
3.5 Standard CMOS Setup Menu .....	32
3.6 Advanced BIOS Features .....	34
3.7 Advanced Chipset Features .....	40
3.8 Integrated Peripherals .....	42
3.9 Power Management Setup .....	47
3.10 PnP/PCI Configuration Setup .....	52
3.11 PC Health Status .....	54
3.12 Frequency/Voltage Control .....	55
3.13 Load Optimized Defaults .....	56
3.14 Set Supervisor/User Password .....	57
3.15 Save & Exit Setup .....	58
3.16 Exit Without Saving .....	59

<b>Chapter 4</b> .....	<b>61</b>
4.1 System .....	61
4.2 Touch Screen .....	62
4.2.1 Specification .....	62
4.2.2 Driver Installation – Windows 2000/XP/Vista .....	63
4.2.3 Driver Installation - DOS .....	66
<b>Appendix Power Supply Specification</b> .....	<b>69</b>



## ***MEMO***



## Chapter 1

### Introduction



This chapter contains general information and detailed specifications of the **PC 8172**. Chapter 1 includes the following sections:

- ④ **General Description**
- ④ **System Specification**
- ④ **Dimensions**
- ④ **Front View & I/O Outlets**
- ④ **Package List**

## 1.1 General Description

The **PC 8172** is a 17" Industrial panel PC which features Intel® Core™ 2 Duo processor and Intel® Q965 chipset to provide powerful computing performance. This panel PC also offers the expansion ability with two PCI slots. It adopts built-in speaker and WLAN module for wireless connectivity. Further, the **PC 8172** fits in with Aluminum IP65/NEMA4 compliant front bezel.

### **Powerful computing: Intel® Core™2 Duo processor**

The **PC 8172** features Intel® Core™ 2 Duo with a maximum of FSB 1066 MHz and Intel® Q965+ICH8 chipset. It features two 1394a ports, two gigabit Ethernet ports and up to 4GB of dual-channel DDR2 system memory which deliver high computing capability for high performance-demanding applications.

### **Expandable for 2 PCI slots**

The **PC 8172** has two PCI slots for expansion purpose. User can easily plug in standard half-size PCI cards such as motion card, communication card and so on.

### **Speaker & WLAN antenna supported**

The **PC 8172** features built-in speaker, optional WLAN module and antenna for wireless network connectivity.

This ideal industrial-grade panel computer **PC 8172** can be applied to the several of industrial or commercial projects, such as transportation, factory automation, HMI machine controller, Point Of Sales, KIOSK and more. Moreover, **PC 8172** provides highly reliable and highly flexible industrial-grade products in all-in-one solutions.

## 1.2 System Specifications

### 1.2.1 Main CPU Board

#### ⌘ CPU

- ④ Socket LGA775 for Intel<sup>®</sup> Core<sup>™</sup> 2 Duo/Core<sup>™</sup> Solo Processor with FSB 533/800/1066 MHz, max up to E6400.



**NOTE** It doesn't support the processor with FSB 1333 MHz, and it is not recommended to use Quad-Core CPU.

#### ⌘ System Chipset

- ④ Intel<sup>®</sup> Q965 + ICH8

#### ⌘ BIOS

- ④ Phoenix-Award BIOS, 16Mbit with RPL/PXE LAN Boot ROM, SmartView and Customer CMOS Backup

#### ⌘ System Memory

- ④ Two 240-pin DDR2 DIMM maximum up to 4GB

#### ⌘ L2 Cache

- ④ Integrated in CPU

#### ⌘ Bus Clock

- ④ 533/800/1066 MHz

#### ⌘ Watchdog Timer

- ④ Up to 255 levels as Reset feature

### 1.2.2 I/O System

#### ⌘ Standard I/O

- ④ Three serial ports with power, two RS-232 and one RS-232/422/485
- ④ One PS/2 for Keyboard and Mouse Interface
- ④ Four USB Ports 2.0 compliant
- ④ Two IEEE1394a Ports

- ④ One DVI-I Output

⌘ **Ethernet**

- ④ First port with i82566DM Gigabit Ethernet PHY, Second port with RTL8111B for Gigabit/Fast Ethernet

⌘ **Audio**

- ④ HD Audio for two channels output
- ④ MIC-In, Line-Out

⌘ **Storage**

- ④ Four SATA-300 interface

⌘ **Box-Header**

- ④ One 26-pin for shared LPT/FDD(optional)

⌘ **Expansion Slot**

- ④ Two 32-bit PCI Master slots

### 1.2.3 System Specification

⌘ **17" TFT LCD**

⌘ **Disk Drive Housing**

- ④ One built-in slim type CD-ROM drive,
- ④ One internal 3.5" drive (Optional 2 X 3.5" or 2 X 2.5" HDD)

⌘ **AC Power Supply (100V ~ 240V)**

- ⌘ **Heat Dispensing Design**
- ⌘ **Two slots for PCI expansion**
- ⌘ **Net Weight**
  - ④ 15 Kgs
- ⌘ **Dimension (Main Body Size)**
  - ④ 450mm (17.71")(W) x 150mm (5.90")(D) x 370mm (14.56")(H)
- ⌘ **Operation Temperature**
  - ④ 0°C to 40°C; Relative Humidity 50%
- ⌘ **Relative Humidity**
  - ④ 10% to 85% @ 40°C, Non-Condensing
- ⌘ **Altitude**
  - ④ 10,000 ft. (3,000 meters)
- ⌘ **Vibration (Operating)**
  - ④ 5 to 500 Hz, 1 G random
- ⌘ **Shock (Operating)**
  - ④ 10 G peak acceleration (11 msec. duration)



**NOTE** All specifications and images are subject to change without notice.

### 1.3 Dimensions

This diagram shows you dimensions and outlines of the **PC 8172**.

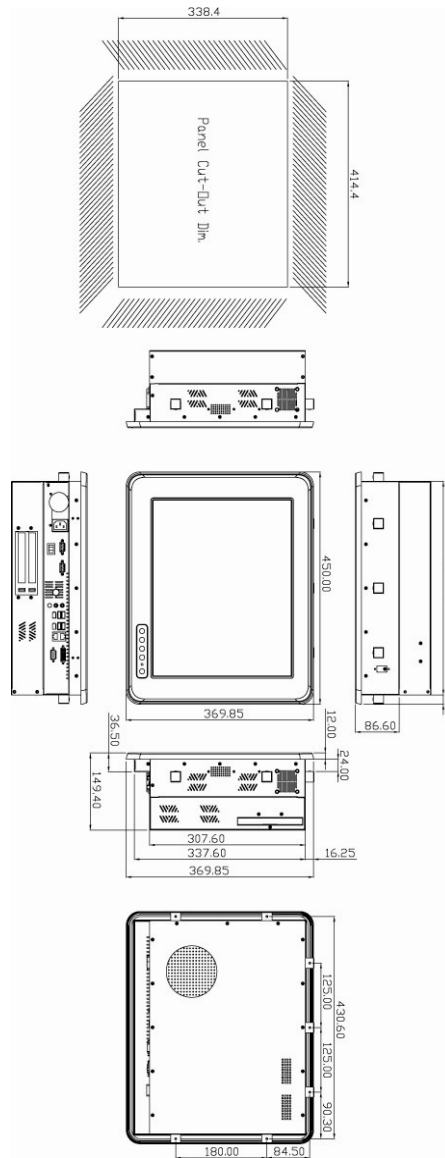



## 1.4 Front View and I/O Outlets

### 1.4.1 Front View

Please refer to the following illustration for features and controls of the PC 8172 front bezel.



No	Function
1	SEL+
2	SEL-
3	Backlight ON/OFF

### 1.4.2 I/O Outlets

The following figure shows the I/O locations of the **PC 8172**.

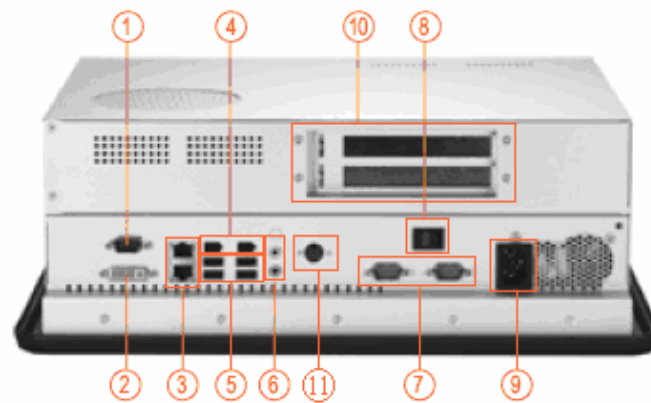

No	Connector	No	Connector
1	COM1 (RS-232/422/485)	7	COM 2 & COM 3 (RS-232)
2	DVI-I	8	Power Switch
3	Giga LAN x 2	9	AC power
4	IEEE 1394a x 2	10	PCI slots x 2
5	USB v2.0 x 4	11	P/S2
6	Mic-in, Line-Out		

## 1.5 Package List

The package bundled with your **PC 8172** should contain the following items:

- ⌘ PC 8172 x 1
- ⌘ AC power cord x 1
- ⌘ Panel mount kit x 7
- ⌘ Driver CD x1
- ⌘ LGA 775 CPU Cooler x 1
- ⌘ DVI TO VGA Adaptor x 1 ⌘  
PS/2 Splitter – Y Cable x 1
- ⌘ SATA Cable x 1
- ⌘ Dual 3.5" HDD bracket kit with fan x 1 (Optional)
- ⌘ Small HDD Kit for 2.5" HDD (Optional)
- ⌘ VIA WLAN Kit (Optional)
- ⌘ Rack Mount Bracket Kit x 1 (Optional)

If you can not find this package or any items are missing, please contact ACNODES distributors immediately.

**MEMO**



## Chapter 2 Hardware Installation

The **PC 8172** is convenient for your various hardware configurations in flexible ways, such as CPU (Central Processing Unit), HDD (Hard Disk Drive), Memory Module (DRAM), CD-ROM, Add-On card, and more. The chapter 2 will show you how to install the hardware. It includes:

- ④ **CPU**
- ④ **DRAM**
- ④ **Hard Disk**
- ④ **CD-ROM**
- ④ **Add-On Card**
- ④ **Serial Port**
- ④ **VGA**
- ④ **Ethernet**
- ④ **Mounting Ways**

### 2.1 Installing the CPU and DRAM

The standard PC8172 system is designed for Intel Core 2 Duo processors. The built-in CPU board provides two 240-pin DDR2 DIMM sockets that support system memory up to 4GB.

Please refer to the instructions below, illustrated with concise images, to upgrade the CPU, DRAM, PCI step by step:

**Step 1** Unscrew screws to remove the rear chassis.

**Step 2** Remove the riser card fix kit.

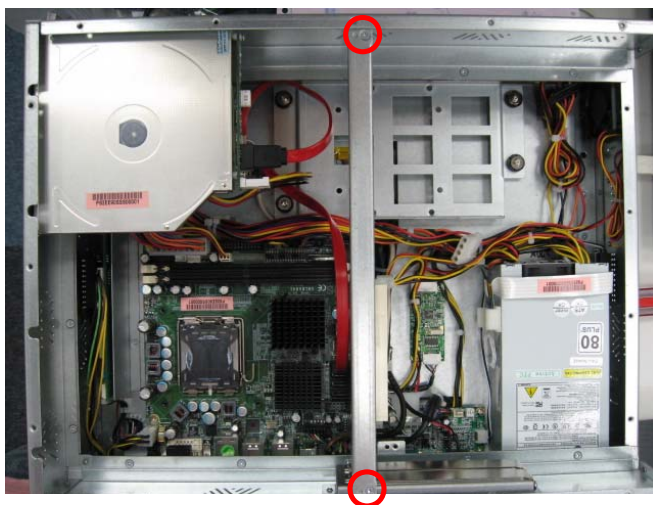

**Step 3** Install the CPU and DDR DRAM in the PC 8172.

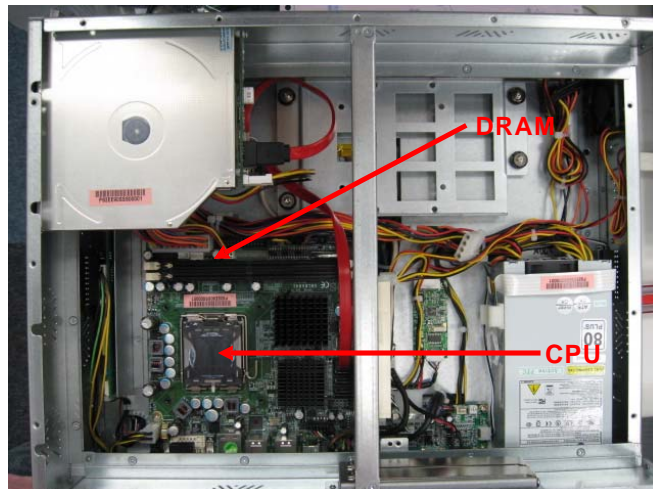



## 2.2 Installing the Hard Disk Drive

The **PC 8172** offers a convenient drive bay module for users to install HDD. The system offers users one 3.5" Hard Disk Drives for installation. If you want to install dual 3.5" HDD, or 2.5" HDD, the **PC 8172** also provides the dual 3.5" and dual 2.5" drive holder to meet your requirement. Please follow the steps:



**Note** *The hardware limitation is that the 2.5" HDD and 3.5" HDD CAN NOT exist simultaneously.*

- Step 1** Unscrew screws to remove the rear chassis.
- Step 2** Remove the riser card fix kit.
- Step 3** Unscrew 4 screws from the HDD drive bracket, and take out HDD bracket kit to install 3.5" HDD.

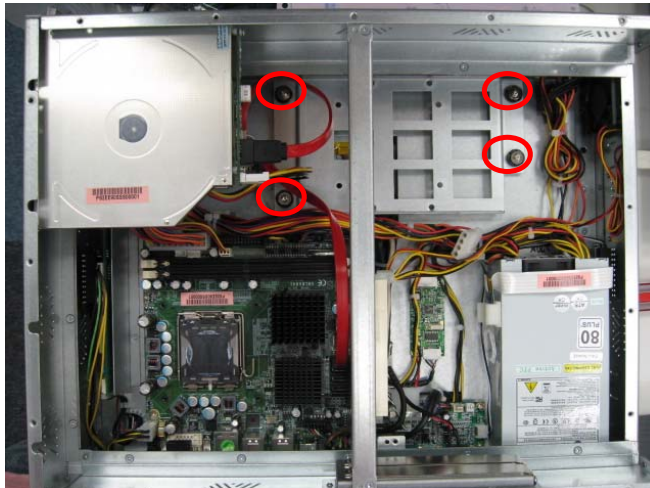

**Step 4** Fix the Hard Disk to the HDD bracket and connect the cable to complete the installation.



(4-1)



(4-2)

🕒 **Installing Dual 3.5" HDD**

If installing the dual 3.5" HDD, please follow the steps:

**Step 1** Change HDD bracket from 3.5" to dual 3.5".

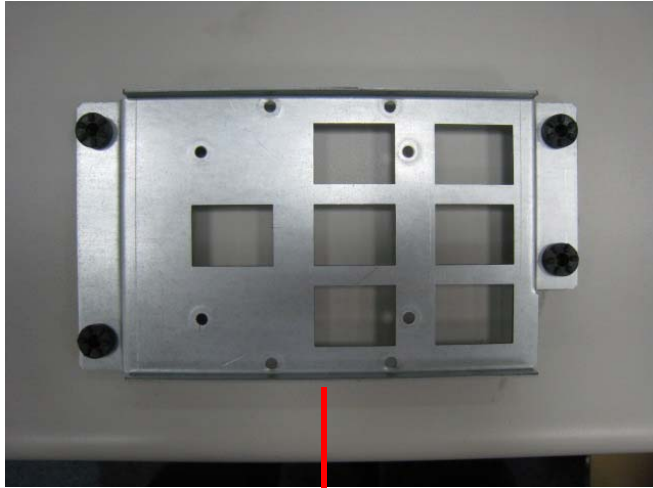

**Step 2** Fix the Hard Disk to the HDD bracket to complete the installation.



 **Note** When installing Dual 3.5" HDD, users must install a fan to decrease system heat. Installation step as following:

🕒 **Installing fan when using dual 3.5" HDD**

**Step 1** Screw the fan to the right side of cover.



(1-1)

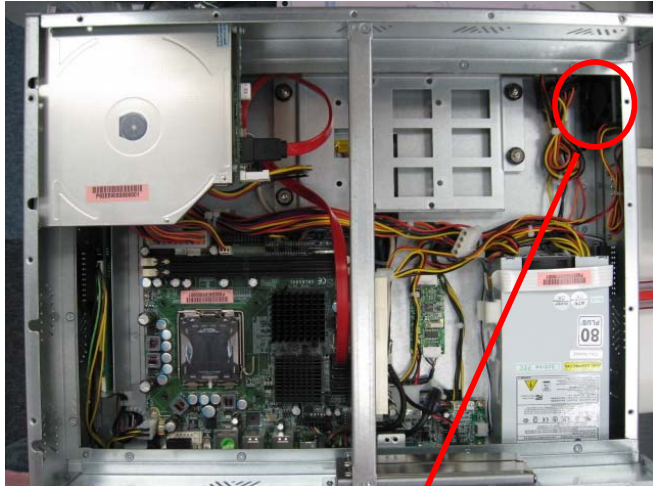

(1-2)

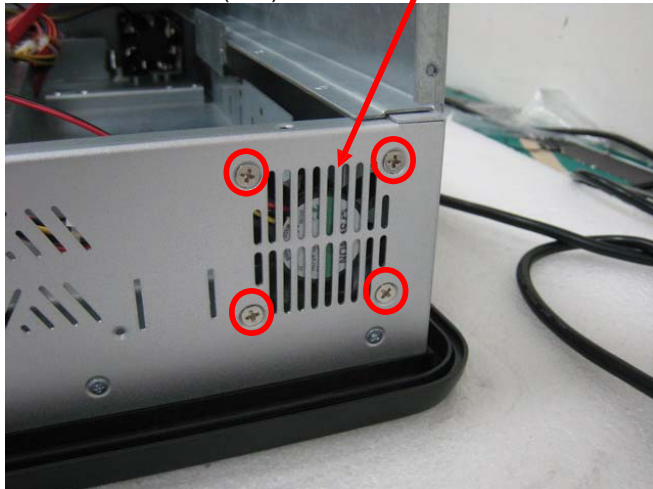

(1-3)

**Step 2** Connect power cable of fan to 3 pin fan connector (CN3) in motherboard.

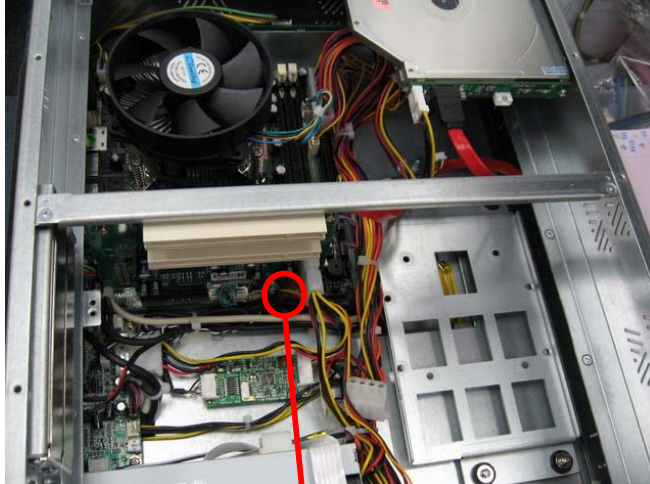

(2-1)

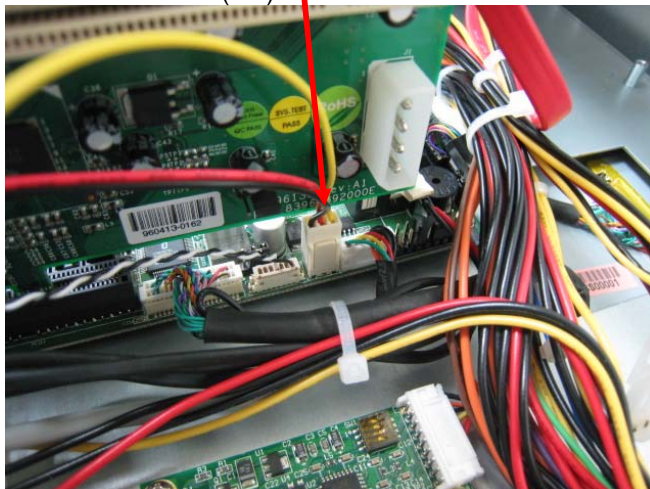

(2-2)

⌚ **Installing 2.5" HDD**

If installing the 2.5" HDD, please follow the steps:

**Step 1** Change HDD rubber of HDD bracket from 3.5" to 2.5".



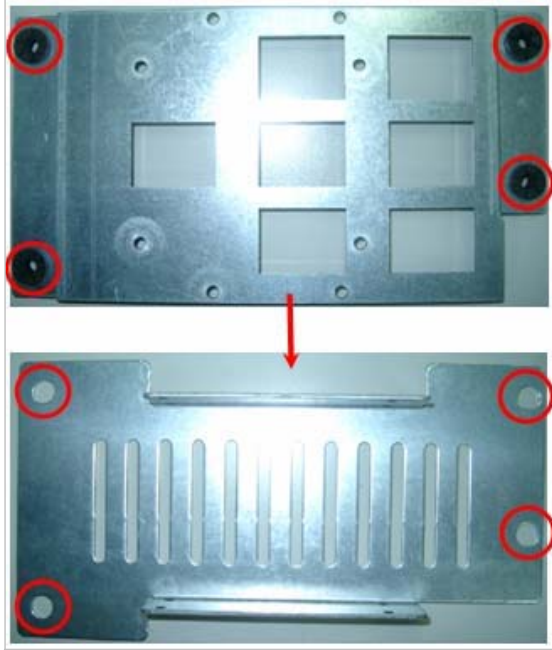

**Step 2** Fix the Hard Disk to the HDD bracket to complete the installation.



## 2.3 CD-ROM Installation

The **PC 8172** offers a convenient drive bay module for users to install CD-ROM. When installing the CD-ROM, refer to the following instructions and illustration:

- Step 1 Unscrew screws to remove the rear chassis.
- Step 2 Remove the riser card fix kit.
- Step 3 Unscrew 4 screws which are around the chassis.



- Step 4 The CD-ROM can be taken out.



## 2.4 Add-on Card Installation

The **PC 8172** provides a riser card for PCI slots expansion. The riser card assembly can accommodate both half-size expansion cards. To install the riser card, refer to the following figure and instructions below:

- Step 1** Remove the rear chassis.
- Step 2** Remove the riser card fix kit.
- Step 3** Remove plates.



**Step 4** Insert the add-on card in the socket firmly until it is completely seated.



## 2.5 Serial Port Interface

The **PC 8172** has four onboard serial ports, COM1, COM2, COM3, COM4 are RS-232 Port Connector.

The connector, COM1, COM2, COM3 are DB-9 connector, and the following table shows the pin assignments of this connector.

Pin	Signal	Pin	Signal
1	DCD, Data Carrier Detect	6	DSR, Data Set Ready
2	RXD, Receive Data	7	RTS, Request To Send
3	TXD, Transmit Data	8	CTS, Clear To Send
4	DTR, Data Terminal Ready	9	RI/+5V/+12V Ring Indicator
5	GND, Ground		

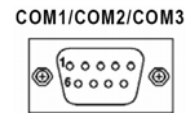



## 2.6 DVI-I

The **PC 8172** has a DVI-I  interface connector. It is able to connect to an expansion CRT monitor, and the system can display on both the flat panel and the CRT simultaneously.

Pin	Signal	Pin	Signal
1	TX2-	2	TX2+
3	Ground	4	CRT_SPD_CLK
5	CRT_SPD DATA	6	DVI_SPD_CLK
7	DVI_SPD DATA	8	CRT-VSYNC
9	TX1-	10	TX1+
11	Ground	12	NC
13	NC	14	VGAVCC
15	Ground	16	FPDETECT
17	TX0-	18	TX0+
19	Ground	20	NC

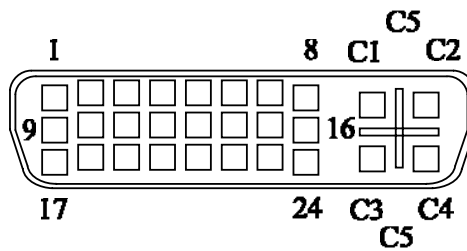
Pin	Signal	Pin	Signal
21	NC	22	Ground
23	TXC+	24	TXC-
C1	CRT-RED	C2	CRT-GREEN
C3	CRT-BLUE	C4	CRT-HSYNC
C5	VGAGND		



 **NOTE** It doesn't support display in LCD and DVI-D simultaneously. DVI-D is only available after booting up in Windows XP.

## 2.7 Ethernet

The **PC 8172** provides a NE2000 compatible Ethernet (RJ-45) interfaces. For network connection, just plug in one cable end of the system's 10/100/1000-Base-T Hub into a standard RJ-45 connector.

Please refer to detailed pin assignment list below:

Pin	Signal
1	TX+ (Data transmission positive)
2	TX- (Data transmission negative)
3	Rx+(Data reception positive)
4	RJ45 termination
5	RJ45 termination
6	Rx- (Data reception negative)
7	RJ45 termination
8	RJ45 termination

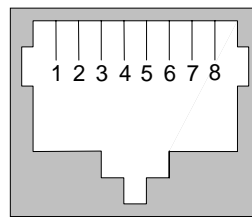

RJ-45

## 2.8 Mountings Way – Panel/ Rack

There are two mounting ways available for the **PC 8172** system: Panel and Rack mounting.

### 2.8.1 Panel Mounting

The **PC 8172** is designed for panel mount application. To mount the **PC 8172**, the standard set of mounting kit (included in the system packaging) is needed.

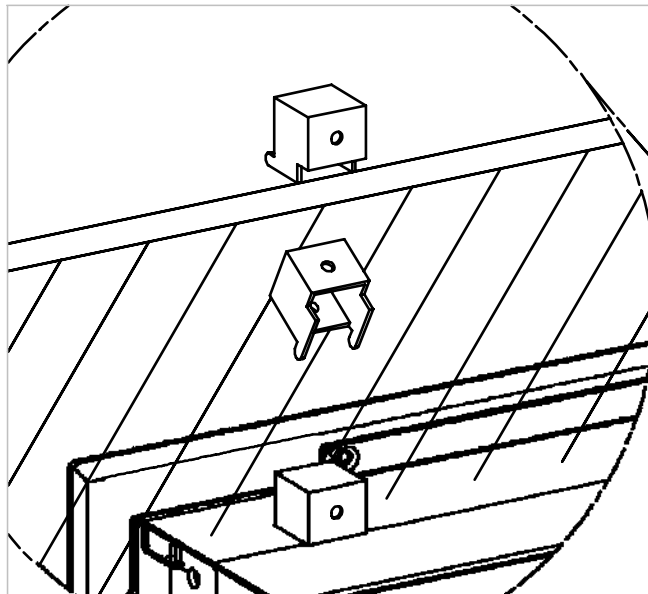

## 2.8.2 Rack Mounting

The **PC 8172** also support rack mounting. The rack mounting kit is optional. Please refer to the following procedure.

1. Fix five screws each side.



2. Complete the rack mounting.

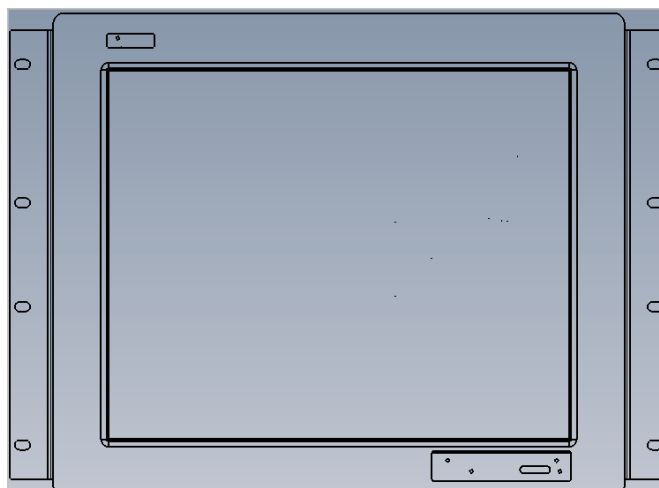

## Chapter 3

# Phoenix-Award BIOS Utility

The Phoenix-Award BIOS provides users with a built-in Setup program to modify basic system configuration. All configured parameters are stored in a battery-backed-up RAM (CMOS RAM) to save the Setup information whenever the power is turned off.

### 3.1 Entering Setup

There are two ways to enter the Setup program. You may either turn ON the computer and press <Del> immediately, or press the <Del> and/or <Ctrl>, <Alt>, and <Esc> keys simultaneously when the following message appears at the bottom of the screen during POST (Power on Self Test).

TO ENTER SETUP PRESS DEL KEY

If the message disappears before you respond and you still want to enter Setup, please restart the system to try it again. Turning the system power OFF and ON, pressing the "RESET" button on the system case or simultaneously pressing <Ctrl>, <Alt>, and <Del> keys can restart the system. If you do not press keys at the right time and the system doesn't boot, an error message will pop out to prompt you the following information:

PRESS <F1> TO CONTINUE, <CTRL-ALT-ESC> OR <DEL> TO ENTER SETUP



## 3.2 Control Keys

Up arrow	Move cursor to the previous item
Down arrow	Move cursor to the next item
Left arrow	Move cursor to the item on the left hand
Right arrow	Move to the item in the right hand
Esc key	Main Menu -- Quit and delete changes into CMOS Status Page Setup Menu and Option Page Setup Menu -- Exit current page and return to Main Menu
PgUp/“+” key	Increase the numeric value or make changes
PgDn/“-“ key	Decrease the numeric value or make changes
F1 key	General help, only for Status Page Setup Menu and Option Page Setup Menu
(Shift) F2 key	Change color from total 16 colors. F2 to select color forward, (Shift) F2 to select color backward
F3 key	Reserved
F4 key	Reserved
F5 key	Restore the previous CMOS value from CMOS, only for Option Page Setup Menu
F6 key	Load the default CMOS value from BIOS default table, only for Option Page Setup Menu
F7 key	Load the Setup default, only for Option Page Setup Menu
F8 key	Reserved
F9 key	Reserved
F10 key	Save all the CMOS changes, only for Main Menu

## 3.3 Getting Help

### ⌘ Main Menu

The online description of the highlighted setup function is displayed at the bottom of the screen.

### ⌘ Status Page Setup Menu/Option Page Setup Menu

Press <F1> to pop out a small Help window that provides the description of using appropriate keys and possible selections for highlighted items. Press <F1> or <Esc> to exit the Help Window.

### 3.4 The Main Menu

Once you enter the Award BIOS CMOS Setup Utility, the Main Menu appears on the screen. In the Main Menu, there are several Setup functions and a couple of Exit options for your selection. Use arrow keys to select the Setup Page you intend to configure then press <Enter> to accept or enter its sub-menu.

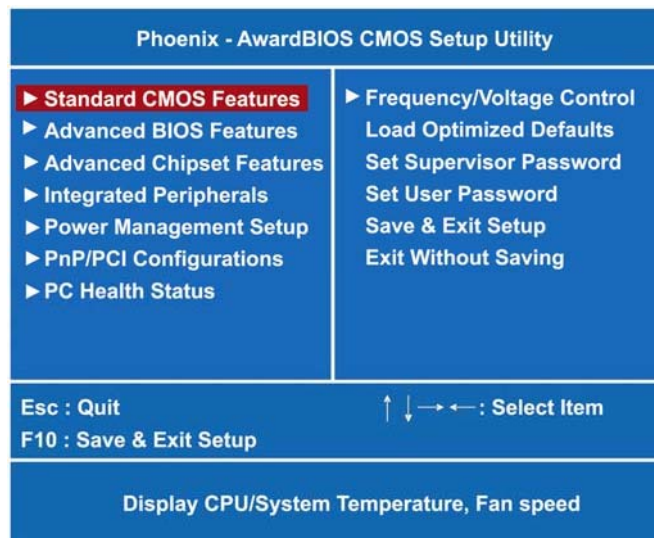

 **NOTE** If your computer can not boot after making and saving system changes with Setup, the Award BIOS will reset your system to the CMOS default settings via its built-in override feature.

It is strongly recommended that you should avoid changing the chipset's defaults. Both Award and your system manufacturer have carefully set up these defaults that provide the best performance and reliability.

### 3.5 Standard CMOS Setup Menu

The Standard CMOS Setup Menu displays basic information about your system. Use arrow keys to highlight each item, and use <PgUp> or <PgDn> key to select the value you want in each item.

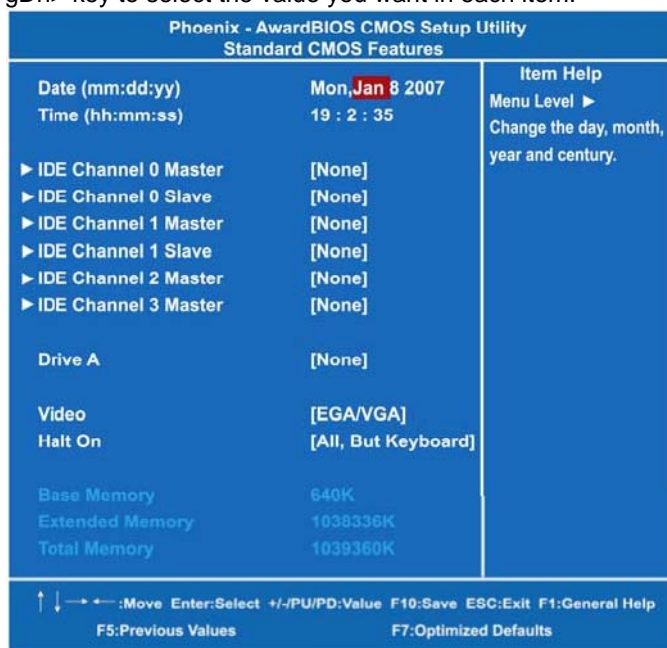

#### ☞ Date

The date format is <day>, <date> <month> <year>. Press <F3> to show the calendar.

<b>day</b>	It is determined by the BIOS and read only, from Sunday to Saturday.
<b>date</b>	It can be keyed with the numerical/ function key, from 1 to 31.
<b>month</b>	It is from January to December.
<b>year</b>	It shows the current year of BIOS.

#### ☞ Time

This item shows current time of your system with the format <hour> <minute> <second>. The time is calculated based on the 24-hour military-time clock. For example, 1 p.m. is 13:00:00.

⌘ **IDE Primary Master/Primary Slave**

These items identify the types of each IDE channel installed in the computer. There are 45 predefined types (Type 1 to Type 45) and 2 user's definable types (Type User) for Enhanced IDE BIOS. Press <PgUp>/<+> or <PgDn>/<-> to select a numbered hard disk type, or directly type the number and press <Enter>. Please be noted your drive's specifications must match the drive table. The hard disk will not work properly if you enter improper information. If your hard disk drive type does not match or is not listed, you can use Type User to manually define your own drive type. If selecting Type User, you will be asked to enter related information in the following items. Directly key in the information and press <Enter>. This information should be provided in the documentation from your hard disk vendor or the system manufacturer.

If the HDD interface controller supports ESDI, select "Type 1".  
 If the HDD interface controller supports SCSI, select "None".  
 If the HDD interface controller supports CD-ROM, select "None".

<b>CYLS.</b>	number of cylinders	<b>LANDZONE</b>	landing zone
<b>HEADS</b>	number of heads	<b>SECTORS</b>	number of sectors
<b>PRECOMP</b>	write precom	<b>MODE</b>	HDD access mode

If there is no hard disk drive installed, select NONE and press <Enter>.

⌘ **Video**

Select the display adapter type for your system.

⌘ **Halt On**

This item determines whether the system will halt or not, if an error is detected while powering up.

<b>No errors</b>	The system booting will halt on any errors detected. (default)
<b>All errors</b>	Whenever BIOS detects a non-fatal error, the system will stop and you will be prompted.
<b>All, But Keyboard</b>	The system booting will not stop for a keyboard error; it will stop for other errors.
<b>All, But Diskette</b>	The system booting will not stop for a disk error; it will stop for other errors.
<b>All, But Disk/Key</b>	The system booting will not stop for a keyboard or disk error; it will stop for other errors.

Press <Esc> to return to the Main Menu page.

### 3.6 Advanced BIOS Features

This section allows you to configure and improve your system, to set up some system features according to your preference.

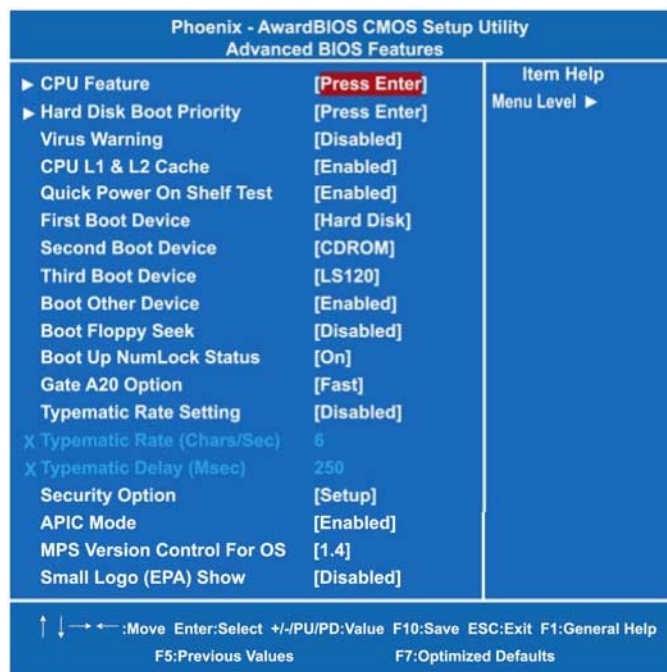

⌘ **CPU Feature**

Scroll to this item and press <Enter> to view the CPU Feature sub menu.

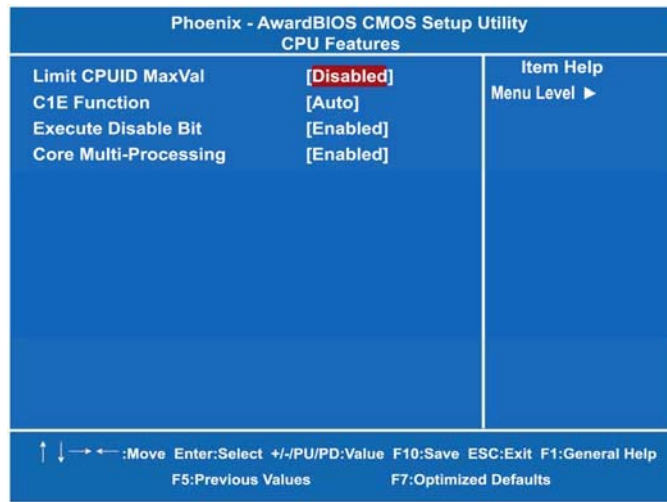

⌘ **Hard Disk Boot Priority**

Scroll to this item and press <Enter> to view the sub menu to decide the disk boot priority.

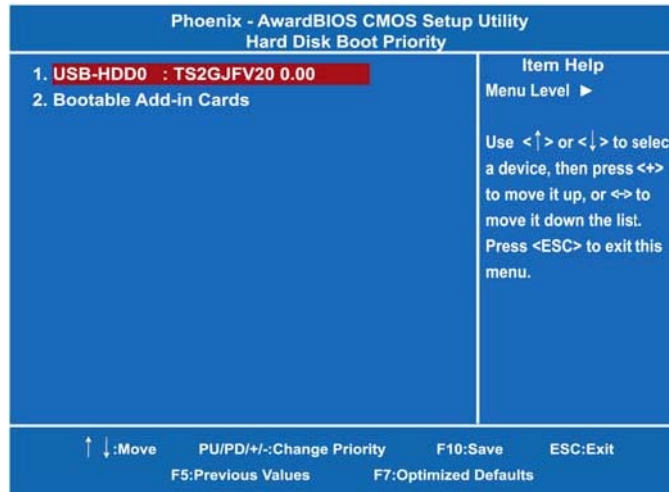

⌘ **Virus Warning**

This option flashes on the screen. During and after the system boot up, any attempt to write to the boot sector or partition table of the hard disk drive will halt the system with the following message. You can run an anti-virus program to locate the problem. The default setting is "Disabled".

<p><b>! WARNING !</b></p> <p><i>Disk boot sector is to be modified</i></p> <p><i>Type "Y" to accept write or "N" to abort write</i></p> <p><i>Award Software, Inc.</i></p>
--

<b>Enabled</b>	It automatically activates while the system boots up and a warning message appears for an attempt to access the boot sector or hard disk partition table.
<b>Disabled</b>	No warning message will appear for attempts to access the boot sector or hard disk partition table.



**NOTE** This function is only available with DOS and other operating systems that do not trap INT13.

⌘ **CPU L1 & L2 Cache**

These two options speed up memory access. However, it depends on the CPU/chipset design. The default setting is "Enabled". CPUs with no built-in internal cache will not provide the "CPU Internal Cache" item on the menu.

<b>Enabled</b>	Enable cache
<b>Disabled</b>	Disable cache

⌘ **Quick Power On Self Test**

This option speeds up Power on Self Test (POST) after you turn on the system power. If set as Enabled, BIOS will shorten or skip some check items during POST. The default setting is "Enabled".

<b>Enabled</b>	Enable Quick POST
<b>Disabled</b>	Normal POST

⌘ **First/Second/Third Boot Device**

These items let you select the 1st, 2nd, and 3rd devices that the system will search for during its boot-up sequence. The wide range of selection includes Floppy, LS120, ZIP100, HDD0~3, SCSI, and CDROM.

⌘ **Boot Other Device**

This item allows the user to enable/disable the boot device not listed on the First/Second/Third boot devices option above. The default setting is "Enabled".

⌘ **Boot Up Floppy Seek**

During POST, BIOS will determine the floppy disk drive type, 40 or 80 tracks. 360Kb type is 40 tracks while 720Kb, 1.2MB and 1.44MB are all 80 tracks. The default value is "Enabled".

<b>Enabled</b>	BIOS searches for floppy disk drive to determine if it is 40 or 80 tracks. Note that BIOS can not tell from 720K, 1.2M or 1.44M drive type as they are all 80 tracks.
<b>Disabled</b>	BIOS will not search for the type of floppy disk drive by track number. There will be no warning message displayed if the drive installed is 360K.

⌘ **Boot Up NumLock Status**

Set the the Num Lock status when the system is powered on. The default value is "On".

⌘ **Gate A20 Option**

The default value is "Fast".

<b>Normal</b>	The A20 signal is controlled by keyboard controller or chipset hardware.
<b>Fast</b>	Default: Fast. The A20 signal is controlled by Port 92 or chipset specific method.

⌘ **Typematic Rate Setting**

This item determines the typematic rate of the keyboard. The default value is "Disabled".

<b>Enabled</b>	Enable typematic rate and typematic delay programming.
<b>Disabled</b>	Disable typematic rate and typematic delay programming. The system BIOS will use default value of these 2 items, controlled by keyboard.



⌘ **Typematic Rate (Chars/Sec)**

This option refers to character numbers typed per second by the keyboard. The default value is "6".

<b>6</b>	6 characters per second
<b>8</b>	8 characters per second
<b>10</b>	10 characters per second
<b>12</b>	12 characters per second
<b>15</b>	15 characters per second
<b>20</b>	20 characters per second
<b>24</b>	24 characters per second
<b>30</b>	30 characters per second

⌘ **Typematic Delay (Msec)**

This option defines how many milliseconds must elapse before a held-down key begins generating repeat characters. The default value is "250".

<b>250</b>	250 msec
<b>500</b>	500 msec
<b>750</b>	750 msec
<b>1000</b>	1000 msec

⌘ **Security Option**

This item allows you to limit access to the system and Setup, or just to Setup. The default value is "Setup".

<b>System</b>	If a wrong password is entered at the prompt, the system will not boot, the access to Setup will be denied, either.
<b>Setup</b>	If a wrong password is entered at the prompt, the system will boot, but the access to Setup will be denied.



**NOTE** To disable the security, select **PASSWORD SETTING** at Main Menu and then you will be asked to enter a password. Do not type anything, just press <Enter> and it will disable the security. Once the security is disabled, the system will boot and you can enter Setup freely.

⌘ **APIC Mode**

Use this item to enable or disable APIC (Advanced Programmable Interrupt Controller) mode that provides symmetric multi-processing (SMP) for systems.

⌘ **MPS Version Control For OS**

This item specifies the version of the Multiprocessor Specification (MPS). Version 1.4 has extended configuration tables to improve support for multiple PCI bus configurations and provide future expandability.

⌘ **Small Logo (EPA) Show**

If enabled, the EPA logo will appear during system booting up; if disabled, the EPA logo will not appear.

Press <Esc> to return to the Main Menu page.

### 3.7 Advanced Chipset Features

This section contains completely optimized chipset's features on the board that you are strongly recommended to leave all items on this page at their default values unless you are very familiar with the technical specifications of your system hardware.

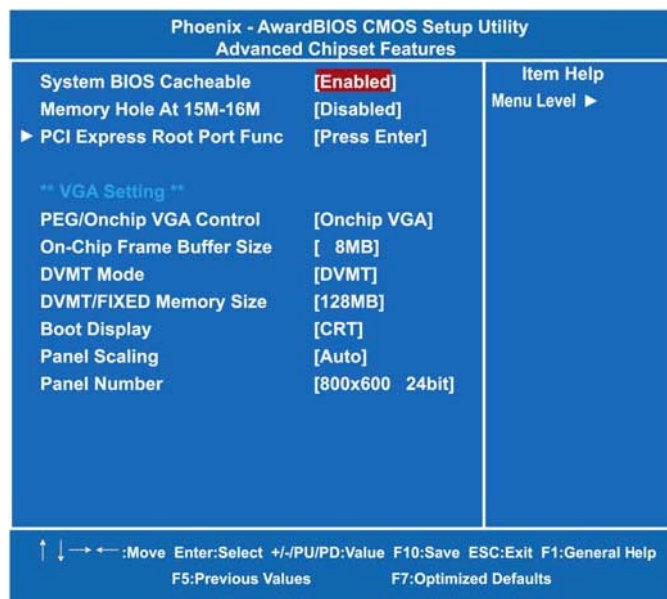

⌘ **System BIOS Cacheable**

Selecting Enabled allows caching of the system BIOS ROM at F0000h-FFFFFFh, resulting in better system performance. However, if any program writes to this memory area, a system error may result. The default value is "Disabled".

⌘ **Memory Hole At 15M-16M**

You can reserve this area of system memory for ISA adapter ROM. When this area is reserved, it cannot be cached. The user information of peripherals that need to use this area of system memory usually discusses their memory requirements.

⌘ **PCI Express Root Port Func**

Scroll to this item and press <Enter> to view the sub menu to decide the PCI Express Port.

Phoenix - AwardBIOS CMOS Setup Utility		
PCI Express Port Func		
PCI Express Port 1	[Auto]	Item Help
PCI Express Port 2	[Auto]	Menu Level ▶
PCI Express Port 3	[Auto]	
PCI Express Port 4	[Auto]	
PCI Express Port 5	[Auto]	
PCI Express Port 6	[Auto]	
PCI-E Compliancy Mode	[ v1.0a]	

↑ ↓ → ← :Move Enter:Select +/-/PU/PD:Value F10:Save ESC:Exit F1:General Help  
F5:Previous Values F7:Optimized Defaults

Press <Esc> to return to the Advanced Chipset Featur's page.

\*\*\* **VGA Setting** \*\*\*

⌘ **PEG/Onchip VGA Control**

Use this item to choose the primary display card.

⌘ **On-Chip Frame Buffer Size**

Use this item to set the VGA frame buffer size.

⌘ **DVMT Mode**

DVMT (Dynamic Video Memory Technology) helps you select the video mode.

⌘ **DVMT/Fixe Memory Size**

DVMT (Dynamic Video Memory Technology) allows you to select a maximum size of dynamic amount usage of the video memory. The system would configure the video memory dependent on your application.

⌘ **Boot Display**

This item is for Intel define ADD card only.

Press <Esc> to return to the Main Menu page.

### 3.8 Integrated Peripherals

This section allows you to configure your SuperIO Device, IDE Function and Onboard Device.

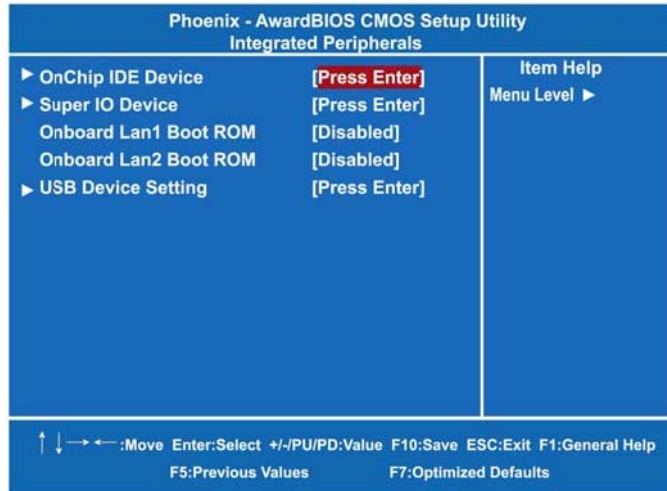

☼ **OnChip IDE Device**

Scroll to this item and press <Enter> to view the sub menu OnChip IDE Device.

Phoenix - AwardBIOS CMOS Setup Utility		
OnChip IDE Device		
IDE HDD Block Mode	[Enabled]	Item Help Menu Level ▶  If your IDE hard drive supports block mode select Enabled for automatic detection of the optimal number of block read/writes per sector the drive can support.
IDE DMA transfer access	[Enabled]	
On-Chip Primary PCI IDE [Enabled]		
IDE Primary Master PIO	[Auto]	
IDE Primary Slave PIO	[Auto]	
IDE Primary Master UMDA	[Auto]	
IDE Primary Slave UMDA	[Auto]	
On-Chip Secondary PCI IDE	[Enabled]	
IDE Secondary Master PIO	[Auto]	
IDE Secondary Slave PIO	[Auto]	
IDE Secondary Master UMDA	[Auto]	
IDE Secondary Slave UMDA	[Auto]	
SATA Mode	[IDE]	
LEGACY Mode Support	[Disabled]	

↑ ↓ → ← :Move Enter:Select +/-PU/PD:Value F10:Save ESC:Exit F1:General Help  
F5:Previous Values F7:Optimized Defaults

① **IDE HDD Block Mode**

Block mode is also called block transfer, multiple commands, or multiple sector read/write. If your IDE hard drive supports block mode (most new drives do), select Enabled for automatic detection of the optimal number of block read/writes per sector the drive can support.

② **IDE DMA transfer access**

Automatic data transfer between system memory and IDE device with minimum CPU intervention. This improves data throughput and frees CPU to perform other tasks.

③ **On-Chip Primary/Secondary PCI IDE**

The integrated peripheral controller contains an IDE interface with support for two IDE channels. Select Enabled to activate each channel separately. The default value is "Enabled".



**NOTE** Choosing Disabled for these options will automatically remove the IDE Primary Master/Slave PIO and/or IDE Secondary

*Master/Slave PIO items on the menu.*

- ① **IDE Master/Slave PIO**  
The four IDE PIO (Programmed Input/Output) fields let you set a PIO mode (0-4) for each of the four IDE devices that the onboard IDE interface supports. Modes 0 to 4 provide successively increased performance. In Auto mode, the system automatically determines the best mode for each device.
- ② **IDE Master/Slave UDMA**  
Select the mode of operation for the IDE drive. Ultra DMA-33/66/100/133 implementation is possible only if your IDE hard drive supports it and the operating environment includes a DMA driver. If your hard drive and your system software both support Ultra DMA-33/66/100/133, select Auto to enable UDMA mode by BIOS.
- ③ **SATA Mode**  
There are these options for you to set up SATA mode: IDE, RAID or AHCI.  
 **NOTE** ICH8DO supports AHCI under Microsoft Windows VISTA and Microsoft Windows XP. ICH8 only supports AHCI under Microsoft Windows VISTA.
- ④ **LEGACY Mode Support**  
Legacy mode support allows devices to function in an operating environment that is not USB-aware.

Press <Esc> to return to the Integrated Peripherals page.

⌘ **Super IO Device**

Scroll to this item and press <Enter> to view the sub menu Super IO Device.

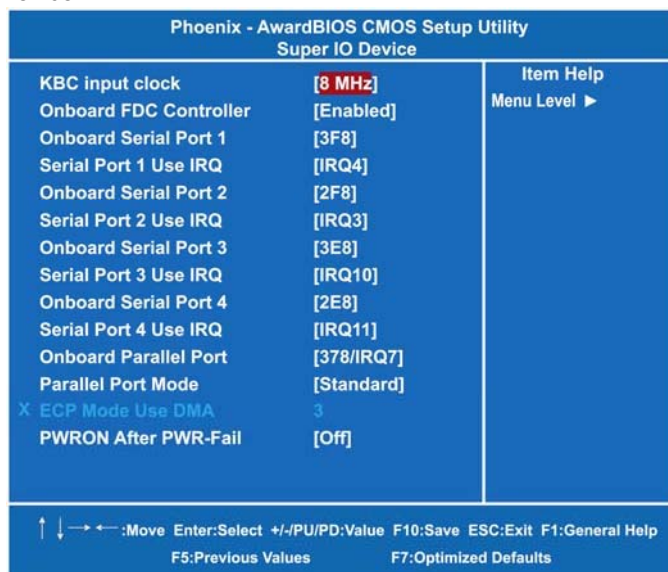

- ⌚ **Onboard FDC Controller**  
Select Enabled if your system has a floppy disk controller (FDC) installed on the system board and you wish to use it. If you install and-in FDC or the system has no floppy drive, select Disabled in this field. The options available are Enabled, Disabled.
- ⌚ **Onboard Serial Port 1/2/3/4**  
Select an address and corresponding interrupt for the serial port. Options: 3F8/IRQ4, 2E8/IRQ3, 3E8/IRQ4, 2F8/IRQ3, Disabled, Auto.
- ⌚ **Serial Port 1/2/3/4 Use IRQ**  
These items assign which I/O address to access onboard serial port 1/2/3/4.
- ⌚ **Onboard Paralel Port**  
This item allows you to determine access onboard parallel port controller with which I/O address. The options available are 378H/IRQ7, 278H/IRQ5, 3BC/IRQ7, Disabled. *The 3BC option does not support any EPP modes.*



- ② **Parallel Port Mode**  
Select an operating mode for the onboard parallel (printer) port. Select Normal unless your hardware and software require one of the other modes offered in this field. The options available are EPP1.9, ECP, SPP, ECPEPP1.7, EPP1.7.
- ② **ECP Mode Use DMA**  
Select a DMA channel for the parallel port for use during ECP mode.
- ② **PWRON After PWR-Fail**  
This item enables your computer to automatically restart or return to its operating status.

Press <Esc> to return to the Integrated Peripherals page.

- ⌘ **Onboard Lan1/Lan2 Boot ROM**  
Use this item to enable or disable the Boot ROM function of the onboard LAN1/LAN2 chips when the system boots up.

- ⌘ **USB Device Setting**  
Scroll to this item and press <Enter> to view the sub menu USB Device Setting. USB (CN16) is not working when USB2.0 Controller is disabled.

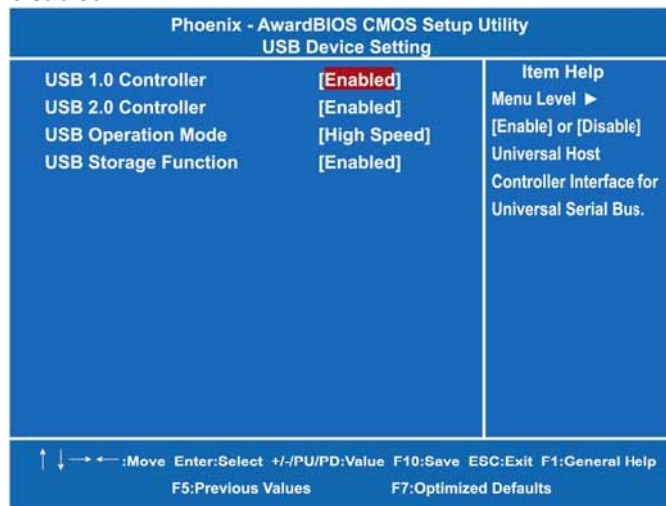

Press <Esc> twice to return to the Main Menu page.

### 3.9 Power Management Setup

The Power Management Setup allows you to save energy of your system effectively. It will shut down the hard disk and turn OFF video display after a period of inactivity.

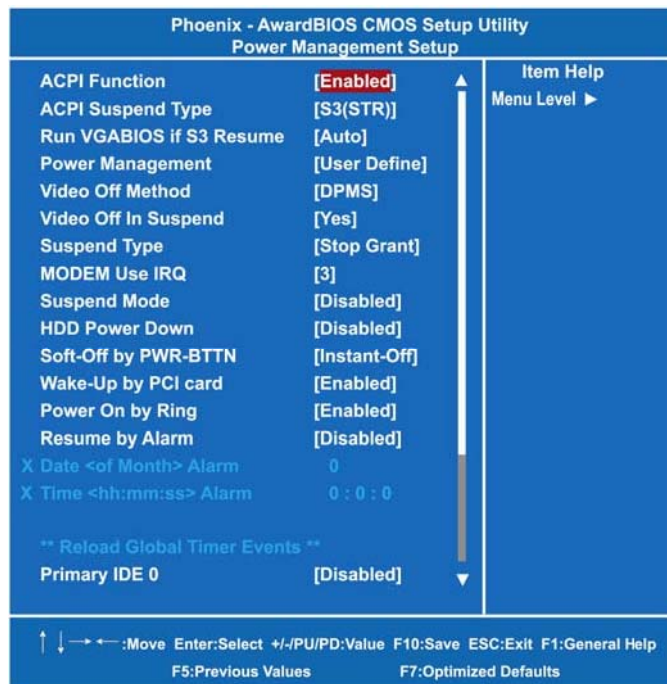

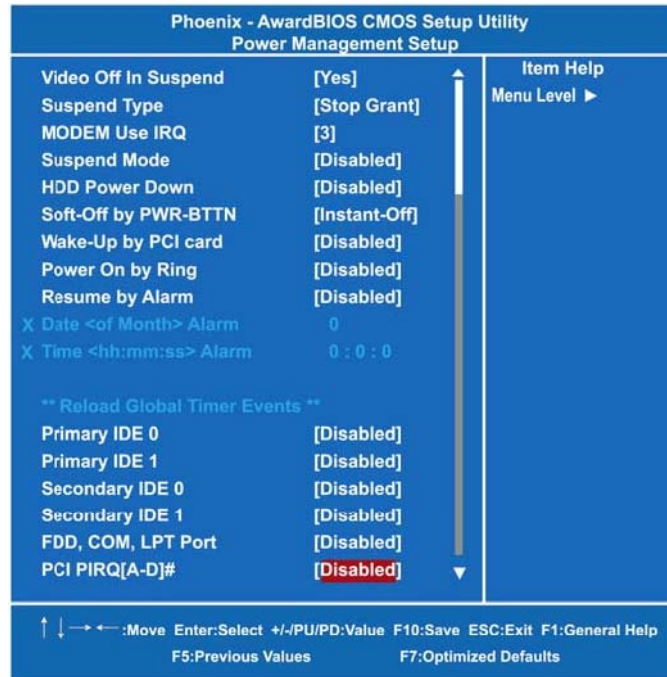

⌘ **ACPI Function**

This item allows you to enable/disable the Advanced Configuration and Power Management (ACPI). The function is always "Enabled".

⌘ **ACPI Suspend Type**

This item specifies the power saving modes for ACPI function. If your operating system supports ACPI, such as Windows 98SE, Windows ME and Windows 2000, you can choose to enter the Standby mode in S1 (POS) or S3 (STR) fashion through the setting of this field. Options are:

[S1(POS)] The S1 sleep mode is a low power state. In this state, no system context is lost (CPU or chipset) and hardware maintains all system context.

[S3(STR)] The S3 sleep mode is a lower power state where the information of system configuration and open applications/files is saved to main memory that remains powered while most other hardware components turn off to save energy. The information stored in memory will be used

to restore the system when a "wake up" event occurs.

⌘ **Run VGABIOS if S3 Resume**

When this item is set Auto, the system will run VGA BIOS if it is reamed from the S3 state.

⌘ **Power Management**

This option allows you to select the type (or degree) of power saving for Doze, Standby, and Suspend modes. The table below describes each power management mode:

<b>Max Saving</b>	It is maximum power savings, only available for SL CPUs. The inactivity period is 1 minute in each mode.
<b>User Define</b>	It sets each mode. Select time-out periods in the PM Timers section.
<b>Min Saving</b>	It is minimum power savings. The inactivity period is 1 hour in each mode (except the hard drive).
<b>Disabled</b>	Default value

⌘ **Video Off Method**

This setting determines the manner in which the monitor is blanked.

<b>V/H SYNC+Blank</b>	Turns OFF vertical and horizontal synchronization ports and writes blanks to the video buffer
<b>DPMS</b>	Select this option if your monitor supports the Display Power Management Signaling (DPMS) standard of the Video Electronics Standards Association (VESA). Use the software supplied for your video subsystem to select video power management values.
<b>Blank Screen</b>	System only writes blanks to the video buffer.

⌘ **Video Off In Suspend**

This item defines if the video is powered down when the system is put into suspend mode.

⌘ **Suspend Type**

If this item is set to the default Stop Grant, the CPU will go into Idle Mode during power saving mode.

⌘ **Modem Use IRQ**

If you want an incoming call on a modem to automatically resume the system from a powersaving mode, use this item to specify the interrupt request line (IRQ) used by the modem. You might have to

connect the fax/modem to the board Wake On Modem connector for working this feature.

⌘ **Suspend Mode**

After the selected period of system inactivity (1 minute to 1 hour), all devices except the CPU shut off. The default value is "Disabled".

<b>Disabled</b>	System will never enter SUSPEND mode
<b>1/2/4/6/8/10/20/30/40 Min/1 Hr</b>	Defines the continuous idle time before the system entering SUSPEND mode. If any item defined in (J) is enabled & active, SUSPEND timer will be reloaded

⌘ **HDD Power Down**

If HDD activity is not detected for the length of time specified in this field, the hard disk drive will be powered down while all other devices remain active.

⌘ **Soft-Off by PWR-BTTN**

This option only works with systems using an ATX power supply. It also allows the user to define which type of soft power OFF sequence the system will follow. The default value is "Instant-Off".

<b>Instant-Off</b>	This option follows the conventional manner systems perform when power is turned OFF. Instant-Off is a soft power OFF sequence requiring only the switching of the power supply button to OFF
<b>Delay 4 Sec.</b>	Upon turning OFF system from the power switch, this option will delay the complete system power OFF sequence by approximately 4 seconds. Within this delay period, system will temporarily enter into Suspend Mode enabling you to restart the system at once.

⌘ **Wake-Up by PCI card**

If enable this item, the system can automatically resume when the PCI Modem or PCI LAN card receives an incoming call.

⌘ **Power On by Ring**

This option allows the system to resume or wake up upon detecting any ring signals coming from an installed modem. The default value is "Enabled".

⌘ **Resume by Alarm**

If enable this item, the system can automatically resume after a fixed time in accordance with the system's RTC (realtime clock).

**\*\* Reload Global Timer Events \*\***

Global Timer (power management) events can prevent the system from entering a power saving mode or can awaken the system from such a mode.

⌘ **Primary/Secondary IDE 0/1**

Use this item to configure the IDE devices monitored by the system.

⌘ **FDD, COM, LPT Port**

Use this item to configure the FDD, COM and LPT ports monitored by the system.

⌘ **PCI PIRQ[A-D]#**

This item can be used to detect PCI device activities; if no activity, the system will enter the sleep mode.

Press <Esc> to return to the Main Menu page.

### 3.10 PnP/PCI Configuration Setup

This section describes configuring the PCI bus system. PCI, or Personal Computer Interconnect, is a system which allows I/O devices to operate at speeds nearing the speed the CPU itself uses when communicating with its own special components. This section covers some very technical items and it is strongly recommended that only experienced users should make any changes to the default settings.

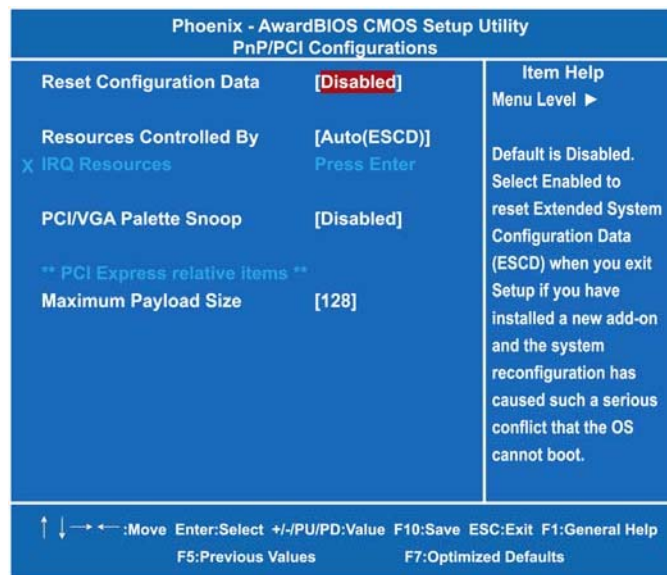

⌘ **Reset Configuration Data**

Normally, you leave this item Disabled. Select Enabled to reset Extended System Configuration Data (ESCD) when you exit Setup or if installing a new add-on cause the system reconfiguration a serious conflict that the operating system can not boot. Options: Enabled, Disabled.

⌘ **Resources Controlled By**

The Award Plug and Play BIOS can automatically configure all boot and Plug and Play-compatible devices. If you select Auto, all interrupt request (IRQ), DMA assignment, and Used DMA fields disappear, as the BIOS automatically assigns them. The default value is "Manual".

⌘ **IRQ Resources**

When resources are controlled manually, assign each system

interrupt to one of the following types in accordance with the type of devices using the interrupt:

1. Legacy ISA Devices compliant with the original PC AT bus specification, requiring a specific interrupt (such as IRQ4 for serial port 1).
2. PCI/ISA PnP Devices compliant with the Plug and Play standard, whether designed for PCI or ISA bus architecture.  
The default value is "PCI/ISA PnP".

⌘ **PCI/VGA Palette Snoop**

Some non-standard VGA display cards may not show colors properly. This item allows you to set whether MPEG ISA/VESA VGA Cards can work with PCI/VGA or not. When enabled, a PCI/VGA can work with a MPEG ISA/VESA VGA card; when disabled, a PCI/VGA cannot work with a MPEG ISA/VESA Card.

**\*\* PCI Express relative items \*\***

⌘ **Maximum Payload Size**

When using DDR SDRAM and Buffer size selection, another consideration in designing a payload memory is the size of the buffer for data storage. Maximum Payload Size defines the maximum TLP (Transaction Layer Packet) data payload size for the device.

Press <Esc> to return to the Main Menu page.



### 3.11 PC Health Status

This section supports hardware monitoring that lets you monitor those parameters for critical voltages, temperatures and fan speed of the board.

Phoenix - AwardBIOS CMOS Setup Utility		Item Help
PC Health Status		Menu Level ▶
Shutdown Temperature	Disabled	
Current System Temp	33°C/91°F	
Current CPU Temperature	84°C/183°F	
GMCH Speed	0 RPM	
CPU Speed	2518 RPM	
Vcore	1.26 V	
VDIMM	1.02 V	
+ 3.3 (V)	3.26 V	
+ 12.0 (V)	11.90 V	
VCC (V)	2.94 V	
5VSB(V)	5.13 V	

↑ ↓ ← → :Move Enter:Select +/-PU/PD:Value F10:Save ESC:Exit F1:General Help  
F5:Previous Values F7:Optimized Defaults

⌘ **Shutdown Temperature**

It helps you set the maximum temperature they system can reach before powering down.

⌘ **Current SYSTEM Temperature**

Show you the current system temperature.

⌘ **Current CPU Temperature**

These read-only fields show the functions of the hardware thermal sensor by CPU thermal diode that monitors the chip blocks to ensure a stable system.

⌘ **Vcore +3.3V/+5V/+12V/VBAT(V)/5VSB**

Show you the voltage of +3.3V/+5V/+12V.

Press <Esc> to return to the Main Menu page.

### 3.12 Frequency/Voltage Control

This section is to control the CPU frequency and Supply Voltage, DIMM OverVoltage and AGP voltage.

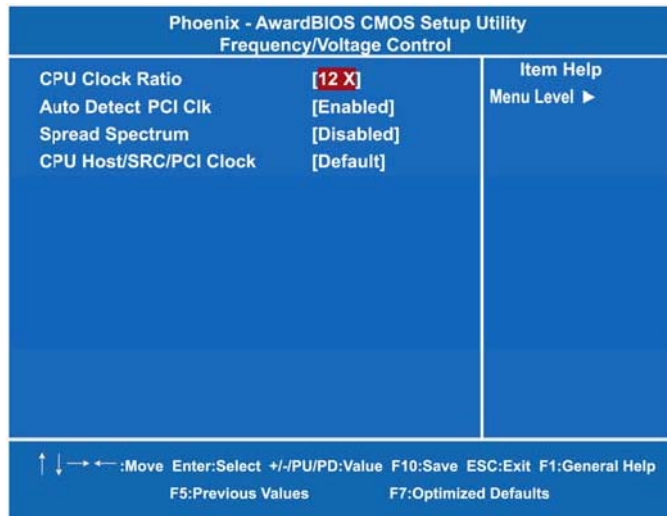

- ⌘ **CPU Clock Ratio**  
Use this item to select the CPU's frequency.
- ⌘ **Auto Detect PCI Clk**  
The enabled item can automatically disable the clock source for a PCI slot without a module, to reduce EMI (ElectroMagnetic Interference).
- ⌘ **Spread Spectrum**  
If spread spectrum is enabled, EMI (ElectroMagnetic Interference) generated by the system can be significantly reduced.

Press <Esc> to return to the Main Menu page.

### 3.13 Load Optimized Defaults

This option allows you to load the default values to your system configuration. These default settings are optimal and enable all high performance features.

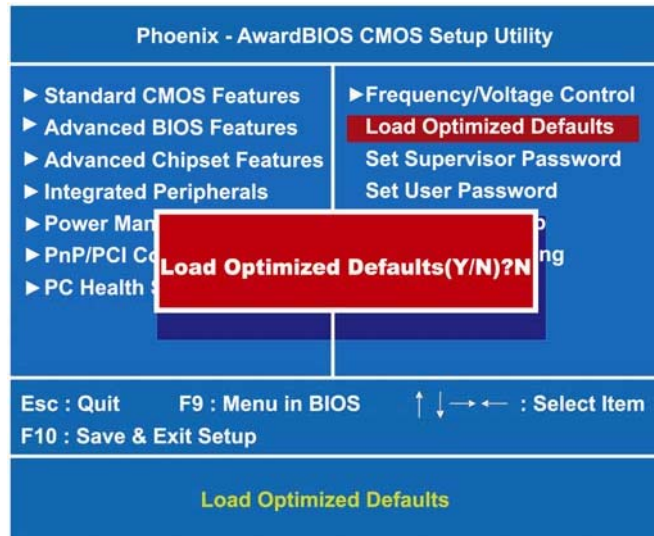

To load SETUP defaults value to CMOS SRAM, enter "Y". If not, enter "N".

### 3.14 Set Supervisor/User Password

You can set either supervisor or user password, or both of them. The differences between are:

1. **Supervisor password:** can enter and change the options of the setup menus.
2. **User password:** just can enter but do not have the right to change the options of the setup menus.

When you select this function, the following message will appear at the center of the screen to assist you in creating a password.

**ENTER PASSWORD:**

Type the password with eight characters at most, and press <Enter>. The password typed will now clear any previously entered password from CMOS memory. You will be asked to confirm the password. Type the password again and press <Enter>. You may also press <Esc> to abort the selection and not enter a password.

To disable password, just press <Enter> when you are prompted to enter password. A message will confirm the password being disabled. Once the password is disabled, the system will boot and you can enter Setup freely.

**PASSWORD DISABLED.**

When a password is enabled, you have to type it every time you enter Setup. This prevents any unauthorized person from changing your system configuration.

Additionally when a password is enabled, you can also require the BIOS to request a password every time the system reboots. This would prevent unauthorized use of your computer.

You determine when the password is required within the BIOS Features Setup Menu and its Security option. If the Security option is set to "System", the password is required during boot up and entry into Setup. If set as "Setup", prompting will only occur prior to entering Setup.

### 3.15 Save & Exit Setup

This allows you to determine whether or not to accept the modifications. Typing "Y" quits the setup utility and saves all changes into the CMOS memory. Typing "N" brings you back to Setup utility.

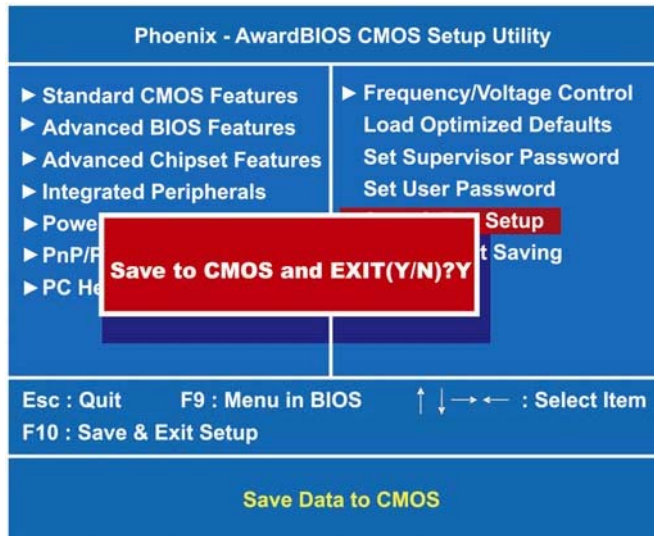

### 3.16 Exit Without Saving

Select this option to exit the Setup utility without saving the changes you have made in this session. Typing "Y" will quit the Setup utility without saving the modifications. Typing "N" will return you to Setup utility.

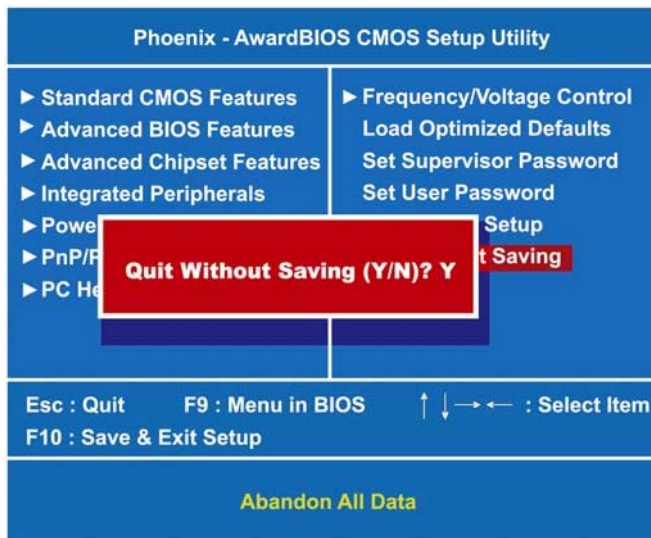

***MEMO***

## Chapter 4 Driver Installation

### 4.1 System

PC 8172 supports Windows 2000/XP/Vista. To facilitate the installation of the system driver, please carefully read the instructions in this chapter before start installing.

1. Here is the path for the system driver:

Panel series\PC 8172\Driver

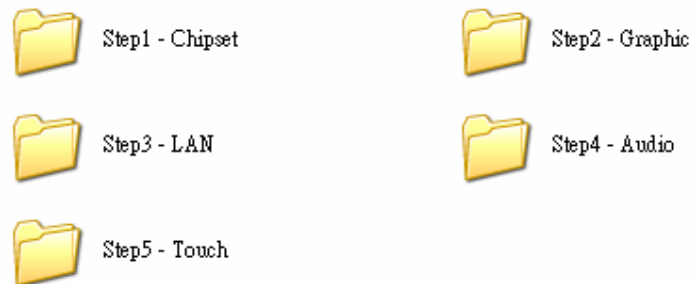

2. Select all files, follow the installing procedure, and finally press OK.



## 4.2 Touch Screen

### 4.2.1 Specification

<b>Touch Screen</b>	5-wire Analog Resistive type
<b>Touch Screen Controller</b>	DMC9000 (10-bit A/D converter inside)
<b>Communications</b>	RS-232
<b>Baud Rate</b>	19200 and 9600 baud selection
<b>Resolution</b>	2048 x 2048
<b>Mode Selection</b>	PnP or non-PnP
<b>Power Input</b>	5V DC
<b>Power Consumption</b>	12V: 23mA+ i where (i = v/touch screen sheet R) 5V: 20mA+ i where (i = v/touch screen sheet R)
<b>Mechanical Size</b>	60(L) x 26(W) x 8.3(H)mm
<b>Portrait</b>	Support 90o to 270o screen rotation
<b>Others</b>	Touch activate indication LED on board

#### 4.2.2 Driver Installation – Windows 2000/XP/Vista

The **PC 8172** provides a driver of the touch screen that users can install it under operating system Windows 2000/XP/Vista. To facilitate this touch screen driver installation, users should read the instructions in this chapter carefully before start the installation.

1. Insert Driver CD and follow the path to select the “Panel series\PC 8172\Driver \Step5 - Touch\Driver\Windows 2000\_XP\_Vista Universal Driver\Setup.exe”.
2. Follow the installing procedure and press OK.
3. Click Start menu and select “PenMount Utilities”, and then a “PenMount Control Panel” pops out.



**Note** Please choose COM4 for touch screen installation.

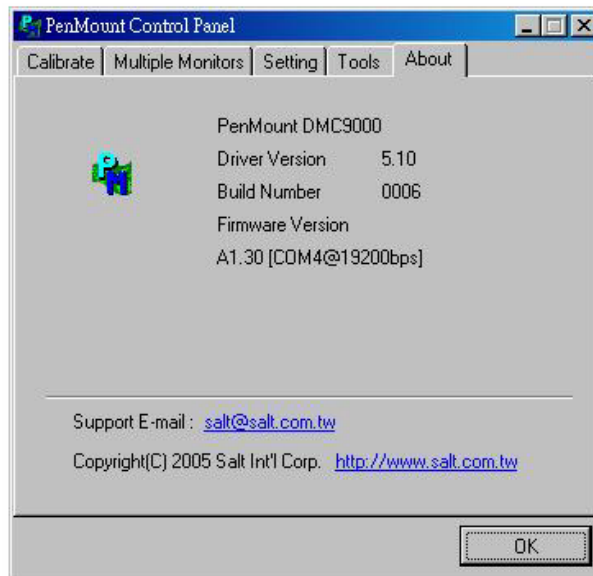

4. Select the "Standard Calibrate" tab.

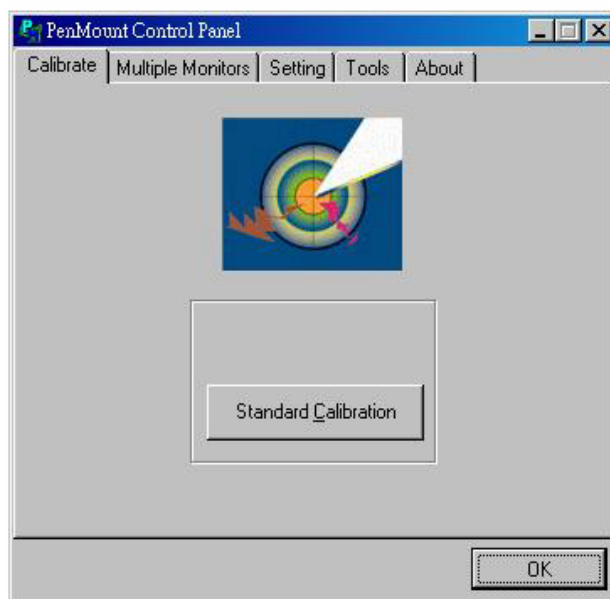

5. Calibration:

To adjust the display with touch panel, click "Calibration" and follow the calibrate point to do calibration; there are five points on screen for calibration.

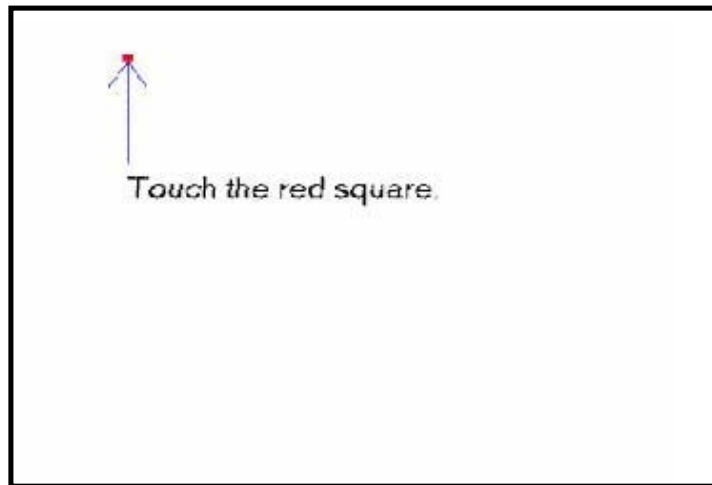

6. Press OK.

### 4.2.3 Driver Installation - DOS

#### ④ Using "INSTALL.EXE" Utility to Install PenMount Software Driver

1. Insert Driver CD and select the Panel series\P1173-841\Driver\Step5 - Touch\Driver\DOS\Install.exe
2. Press ENTER key to install the drivers to drive C or use keyboard to key-in the hard disc drive that you plan to install the driver.
3. The driver will ask "Do you want to modify your Autoexec.bat to initialize PenMount? (Y/N)" Suggest you choose "YES" for generating the initialization instructions in AUTOEXEC.BAT files. Then follow up the instructions to complete the installation.

#### ④ Identify the Communication Port and IRQ Number

1. For the first time installation, or changing PenMount Touch Screen's COM port, use PMDETECT (e.g. C:\PENMOUNT\PMDETECT) to check the COM port and IRQ number. PMDETECT will save the correct data to PMOUSE.CFG file for further use.
2. The driver detects your communication COM port and IRQ number from COM1 IRQ4, COM2 IRQ3, COM3.... to COM4 IRQ15. PenMount driver can find the COM port and IRQ number automatically. The screen will then show:

**PenMount is initialized successfully!!!**

**Create file "pmouse.cfg". Success.**

**PenMount internal settings:**

**Comm. Port: COM<n> IRQ<n>**

.....

3. PMDETECT program is able to skip the IRQ number detecting if the Touch screen Driver Installation **13** does not need to detect the specified IRQ number. For example, you do not need to detect IRQ5, and the command is:

C:\PENMOUNT\PMDETECT -N5

4. If you do not need to detect IRQ5 and IRQ9, the command is:

C:\PENMOUNT\PMDETECT -N5 -N9

② **Do Calibration**

1. To adjust the touch screen mapping properly to display screen, use PM.BAT (C:\PENMOUNT\PM) to do calibration. Choose "1" DO CALIBRATION (adjust screen mapping).
2. The message pops out to ask if you select the video mode number. Use keyboard to select starting the calibration, touch the upper-center point, then right-center point, bottom-center point and left-center point in sequence. After the calibration is done, the data will be shown on the screen, then press any key to continue the progress.
3. After the calibration, you are suggested to test the touch screen and display mapped results by choosing "3" DRAWING TEST under PM.BAT

② **Initializing the PenMount Driver**

If you don't have the initialization commands in AUTOEXEC.BAT, initialize PenMount C:\PENMOUNT\PMINIT) controller before you use the PenMount Touch Screen. The display will show the initialization message:

**PenMount V7.06 Copyright(c) SALT International Corp.**

**Test:COM<n> IRQ<n> (<n> is the number after PMDETECT done)**

**PenMount communication settings: COM<N> IRQ<n> Baud Rate: <xxxx>**

.....

② **Demonstration**

To demonstrate or test touch screen operation, please select "3" DRAWING TEST in PM.BAT file of the Utility Directory. Drawing will be shown on the screen. The demonstration program "ICECREAM.EXE" in the "PENMOUNT" directory can be applied, too.

**MEMO**

## Appendix Power Supply Specification

### Power Supply FSP250-50GUB (250W, AC100~240V Input)

#### 1. Electrical Requirements

##### OUTPUT ELECTRICAL REQUIREMENTS

The subject power supply will meet all electrical specifications below, over the full operation temperature range and dynamic load regulation.

##### OUTPUT RATING

Output	Nominal	Regulation	Ripple/Noise	Min	Max
1	+3.3V	±5%	50mV	0.3A	16.8A
2	+5V	±5%	50mV	0.3A	12.0 A
3	+12V	±5%	120mV	1.5A	10.0 A
4	-12V	±10%	120mV	0.0 A	0.8A
5	+5VSB	±5%	50mV	0.0 A	2.0A



**Note** -12V,+3.3V, +5V,+12V will have the regulation to ±10% when all load take off.

The +3.3V and +5V total output shall not exceed 105 watts. The +3.3.V, +5V, and +12V total output shall not exceed 230 watts and the total output for this subject power supply is 250 watts.



**LOAD CAPACITY SPECIFICATIONS**

The cross regulation defined as follows, the voltage regulation limits DC include DC Output ripple & noise.

LOAD	+3.3V	+5V	+12V	-12V	+5VSB
Condition_1	X	X	X	X	2A
Condition_2	0.5A	0.3A	1A	0A	0.1A
Condition_3	0.5A	2A	2A	0.8A	0.1A
Condition_4	1A	2A	17A	0.1A	0.1A
Condition_5	1A	10A	4A	0.1A	0.1A
Condition_6	4.5A	18A	12A	0.1A	0.1A
Condition_7	12A	2A	2A	0A	0.1A
Condition_8	17A	9.7A	10.5A	0.8A	2A

**HOLD-UP TIME (@FULL LOAD)**

115V / 60Hz : 17 mSec. Minimum.

230V / 50Hz : 17 mSec. Minimum.

**OUTPUT RISE TIME**

(10% TO 95% OF FINAL OUTPUT VALUE, @FULL LOAD)

115V-rms or 230V-rms	+3.3Vdc	20ms Maximum
	+ 5Vdc	20ms Maximum
	+ 12Vdc	20ms Maximum
	+ 5Vsb	20ms Maximum
	- 12Vdc	20ms Maximum

**OVER VOLTAGE PROTECTION**

Voltage Source	Protection Point
+3.3V	3.76V – 4.8V
+5V	5.6V – 7.0V
+12V	13.0V – 16.5V

### SHORT CIRCUIT PROTECTION

Output short circuit is defined to be a short circuit load of less than 0.1 ohm.

In the event of an output short circuit condition on +3.3V, +5V or +12V output, the power supply will shutdown and latch off. The power supply shall return to normal operation after the short circuit has been removed and the power switch has been turned off for no more than 2 seconds.

### OVERLOAD PROTECTION

Overload currents defined as a 10 amp/sec fault current ramp starting from full load, applied to the +3.3V, +5V output, shall not cause that output to exceed 32 amps before the output voltage drops below 0.5 volts and is latched off. The +12V output shall not exceed 20 amps under the same ramp conditions starting at full load before it is latched off.

### POWER SIGNAL

POWER GOOD @ 115/230V, FULL LOAD	100 –500mSec.
POWER FAIL @115/230V, FULL LOAD	1 mSec. minimum

## 2. Efficiency

Loading	Voltage	Full load	Typical load	Light load
Required Minimum Efficiency	115V	80%	81%	80%
Required Minimum Efficiency	230V	81%	82%	80%

## 3. Environmental Requirements

- ④ **Operating temperature range:** 10°C to 50°C
- ④ **Storage temperature range:** -20°C to +80°C
- ④ **Humidity, non-condensing:** 5% ~ 95%RH, Non-Condensing

- ④ **Vibration:** 0.25G, 10~250Hz
- ④ **Shock:** -40G, 11mSec for Storage, -10G, 11mSec for operating

**4. Reliability**

The power supply reliability, when calculated by MIL-HDBK;latest revision, are exceed 100,000 hours with all output at maximum load and an ambient temperature of 25°C.

**5. Safety**

NEMKO EN 60950  
TUV EN60950 OR VDE EN60950  
UL 60950  
CSA 22.2 NO. 60950  
IEC 60950  
CE

## Free Manuals Download Website

<http://myh66.com>

<http://usermanuals.us>

<http://www.somanuals.com>

<http://www.4manuals.cc>

<http://www.manual-lib.com>

<http://www.404manual.com>

<http://www.luxmanual.com>

<http://aubethermostatmanual.com>

Golf course search by state

<http://golfingnear.com>

Email search by domain

<http://emailbydomain.com>

Auto manuals search

<http://auto.somanuals.com>

TV manuals search

<http://tv.somanuals.com>