

ARS28i

Made for



iPod



iPhone



iPad

Conçu pour



iPod



iPhone



iPad

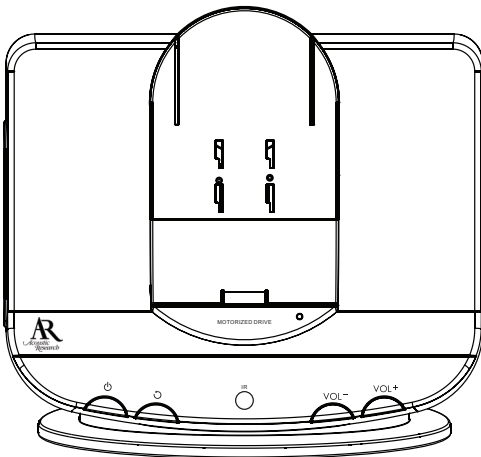

EN/F/E

It is important to read this user manual prior to using your new product for the first time.

Nous vous recommandons de lire ce manuel d'instructions avant d'utiliser votre nouveau produit pour la première fois.

Es importante leer este manual antes de usar por vez primera su equipo.

IMPORTANT SAFETY INSTRUCTIONS

PLEASE READ AND SAVE FOR FUTURE REFERENCE

EN

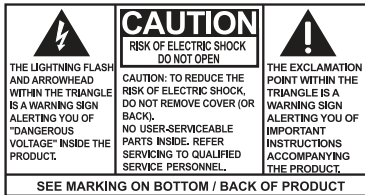

WARNING: TO PREVENT FIRE OR ELECTRICAL SHOCK HAZARD, DO NOT EXPOSE THIS PRODUCT TO RAIN OR MOISTURE.

Some of the following information may not apply to your particular product; however, as with any electronic product, precautions should be observed during handling and use.

- Read these instructions.
- Keep these instructions.
- Heed all warnings.
- Follow all instructions.
- Do not use this apparatus near water.
- Clean only with dry cloth.
- Do not block any ventilation openings. Install in accordance with the manufacturer's instructions.
- Do not install near any heat sources such as radiators, heat registers, stoves, or other apparatus (including amplifiers) that produce heat.
- Protect the power cord from being walked on or pinched particularly at plugs, convenience receptacles, and the point where they exit from the apparatus.
- Only use attachments/accessories specified by the manufacturer.
- Use only with the cart, stand, tripod, bracket, or table specified by the manufacturer, or sold with the apparatus. When a cart is used, use caution when moving the cart/apparatus combination to avoid injury from tip-over.
- Unplug this apparatus during lightning storms or when unused for long periods of time.
- Refer all servicing to qualified service personnel. Servicing is required when the apparatus has been damaged in any way, such as power-supply cord or plug is damaged, liquid has been spilled or objects have fallen into the apparatus, the apparatus has been exposed to rain or moisture, does not operate normally, or has been dropped.



Portable Cart Warning

ADDITIONAL SAFETY INFORMATION

- The AC adapter supplied with this product is intended to be correctly oriented in a vertical or floor mount position.
- Do not use unauthorized chargers or power adapters. Use only chargers that came with your product or that is listed in the user's guide.
- Apparatus shall not be exposed to dripping or splashing and no objects filled with liquids, such as vases, shall be placed on the apparatus.
- Always leave sufficient space around the product for ventilation. Do not place product in or on a bed, rug, in a bookcase or cabinet that may prevent air flow through vent openings.

- Do not place lighted candles, cigarettes, cigars, etc. on the product.
- Care should be taken so that objects do not fall into the product.
- Do not attempt to disassemble the cabinet. This product does not contain customer serviceable components.
- The marking information is located at the bottom of apparatus.
- To be completely disconnect the power input, the AC adaptor of apparatus shall be disconnected from the mains.
- AC adaptor is a disconnect device. The AC adaptor should not be obstructed OR should be easily accessed during intended use.
- The ventilation should not be impeded by covering the ventilation openings with items such as newspaper, table-cloths, curtains etc.
- No naked flame sources such as lighted candle should be placed on the apparatus.
- Attention should be drawn to the environmental aspects of battery disposal.
- The use of apparatus in moderate climates.

Important battery precautions

- Any battery may present a risk of fire, explosion, or chemical burn if abused. Do not try to charge a battery that is not intended to be recharged, do not incinerate, and do not puncture.
- Non-rechargeable batteries, such as alkaline batteries, may leak if left in your product for a long period of time. Remove the batteries from the product if you are not going to use it for a month or more.
- If your product uses more than one battery, do not mix types and make sure they are inserted correctly. Mixing types or inserting incorrectly may cause them to leak.
- Discard any leaky or deformed battery immediately. They may cause skin burns or other personal injury.
- Please help to protect the environment by recycling or disposing of batteries according to federal, state, and local regulations.

WARNING: The battery (battery or batteries or battery pack) shall not be exposed to excessive heat such as sunshine, fire or the like.

Ecology

Help protect the environment - we recommend that you dispose of used batteries by putting them into specially designed receptacles.

CAUTION

Danger of explosion if battery is incorrectly replaced. Replace only with the same or equivalent type.

Electrical power information

AC power adapter:

Input: 110 - 240 V AC, 50/60 Hz

Output: 8.5 V DC, 2.9 A

Power consumption: 24.65 W

FCC Information

Note: This equipment has been tested and found to comply with the limits for a Class B digital device, pursuant to Part 15 of FCC Rules. These limits are designed to provide reasonable protection against harmful interference in a residential installation. This equipment generates, uses, and can radiate radio frequency energy and, if not installed and used in accordance with the instructions, may cause harmful interference to radio communications.

However, there is no guarantee that interference will not occur in a particular installation. If this equipment does cause harmful interference to radio or television reception, which can be determined by turning the equipment off and on, the user is encouraged to try to correct the interference by one or more of the following measures:

- Reorient or relocate the receiving antenna.
- Increase the separation between the equipment and receiver.
- Connect the equipment into an outlet on a circuit different from that to which the receiver is connected.
- Consult the dealer or an experienced radio/TV technician for help.

Changes or modifications not expressly approved by Audiovox could void the user's authority to operate the equipment.

This Class B digital apparatus complies with Canadian ICES-003.

Cet appareil numérique de la classe B est conforme à la norme NMB-003 du Canada.

"Made for iPod", "Made for iPhone" and "Made for iPad" mean that an electronic accessory has been designed to connect specifically to iPod, iPhone or iPad, respectively, and has been certified by the developer to meet Apple performance standards. Apple is not responsible for the operation of this device or its compliance with safety and regulatory standards.

iPad, iPhone, iPod, iPod classic, iPod nano and iPod touch are trademarks of Apple Inc., registered in the U.S. and other countries.

Please note that the use of this accessory with iPod, iPhone or iPad may affect wireless performance.

Contents

Important safety instructions

IMPORTANT SAFETY INSTRUCTIONS.....	1
Important battery precautions	2
Ecology.....	2
Electrical power information	2

FCC Information..... 3

Contents 4

Before you begin

Content of the box.....	6
Using the AC power adapter.....	6
Before using the Remote Control.....	7
Battery Replacement	7

Connecting external devices 9

General controls

Front view	9
Back view.....	9

General controls

Remote control	10
----------------------	----

Docking your iPad/iPhone/iPod

Choosing the correct adaptor	10
To place a dock adaptor	10
Docking your iPad/iPhone/iPod	11
Charging your iPad/iPhone/iPod.....	11

Function Controls

Function Controls.....	12
------------------------	----

Operation 13

Operation with Acoustic Research Dock Plus App

Acoustic Research Dock Plus App General Controls..... 14
Alarm..... 14
Settings 15
FM Tuner..... 16

Video operation

Connecting the Video Cord to View a Video/Picture from iPad/iPhone/iPod 17
Play videos on TV 17

Dock adaptor and iPad/iPhone/iPod compatibility 19

Warranty information

12 Month Limited Warranty 21

Before you begin

The first time you dock your iPad/iPhone/iPod, you'll be prompted to download the free Acoustic Research Dock Plus App from the iTunes store. You are encouraged to download and install this app (right on your iPad/iPhone/iPod) in order to enjoy the wide variety of features which are available with the app.

- App is for iPad/iPhone/iPod touch only (iOS 3.0 or higher).
- Note the Acoustic Research Dock Plus App must be running and visible while your iPad/iPhone/iPod is docked in order for many of the additional features such as alarms and FM radio to properly operate. Launch the app by touching the app icon on your iPad/iPhone/iPod either just before or just after docking.



Content of the box

- Main Unit
- Remote control
- User manual
- Quick start guide
- AC power adapter
- Six iPad/iPhone/iPod adaptors

Using the AC power adapter

Connect the single plug into the "DC IN" jack on the unit's back panel. Then, connect the AC power adapter into the 120 V AC outlet.

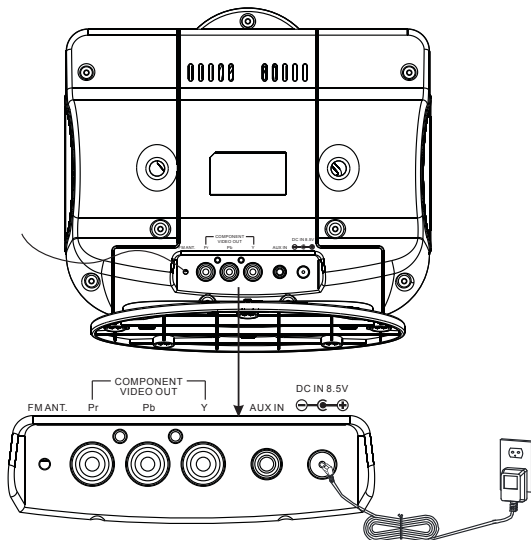

Before using the Remote Control

The CR2032 lithium battery is already installed in the remote control. Pull out the small mylar insulation tab as shown in the illustration to begin using the remote control.

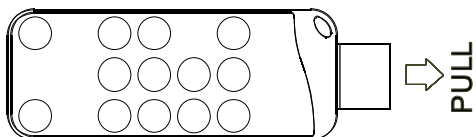

Make sure that you have removed the mylar insulation tab from the remote control.



Battery Replacement

When the remote operation becomes weak or intermittent, it is time to replace the remote control battery. Pull out the battery holder, remove the old battery and install a new CR2032 battery in the holder as shown in the illustration. Slide the holder back into the remote control.

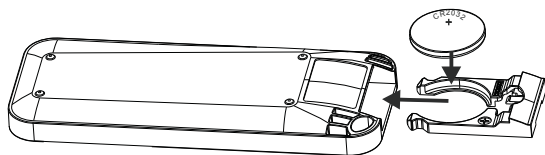

Connecting external devices

Complete the connections as shown below:

- **VIDEO** connection requires a VIDEO cable (not supplied). See "Video Operation" for details.
- **AUX** connection requires a 3.5mm audio cable (not supplied) to connect your external audio source to the **AUX** input on the back of the main unit.

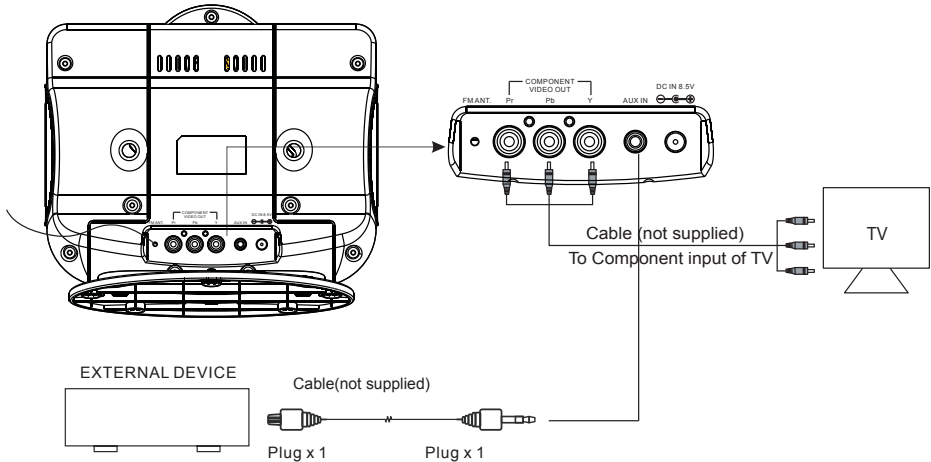

The Aux Input is not available when an iPad/iPhone/iPod is docked AND the Dock Plus App is not running. To access Aux In, either remove the iPad/iPhone/iPod or launch the Dock Plus App which will then allow the selection of the desired source such as FM Radio or Aux In.



General controls

Front view

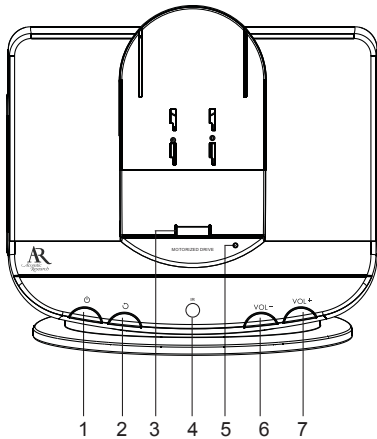

Back view

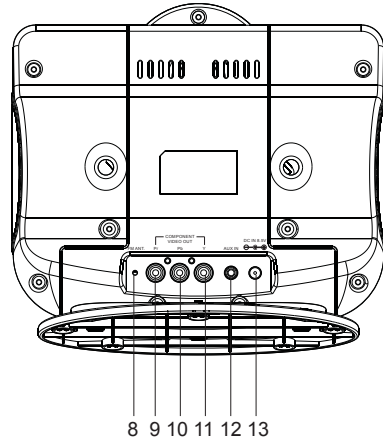

EN

1. POWER ON/OFF Button
2. ROTATE Button
3. Universal Dock for iPad/iPhone/iPod*
4. Remote sensor
5. Power Indicator
6. VOLUME(-) Button
7. VOLUME(+) Button
8. FM antenna
9. COMPONENT VIDEO OUT Pr Jack
10. COMPONENT VIDEO OUT Pb Jack
11. COMPONENT VIDEO OUT Y Jack
12. AUX IN Jack
13. DC IN Jack (8.5 V DC, 2900 mA)

*DO NOT manually force the rotating mechanism for the universal dock. Instead, ONLY use the **ROTATE** button on either the main unit or the remote control.



General controls

Remote control

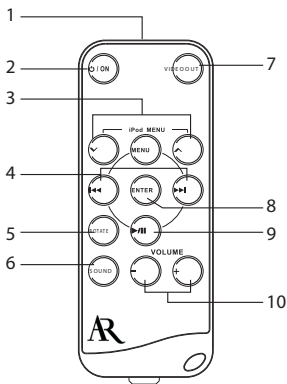

1. Remote Control Transmitter
2. STANDBY / ON Button
3. iPod MENU* and Buttons
4. SKIP Buttons
5. ROTATE Button
6. SOUND Button
7. VIDEO OUT Button
8. ENTER Button
9. PLAY/PAUSE Button
10. VOLUME + / - Buttons

***PLEASE NOTE :** The Aux Input is not available when an iPad/iPhone/iPod is docked AND the Dock Plus App is not running. To access Aux In, either remove the iPad/iPhone/iPod or launch the Dock Plus App which will then allow the selection of the desired source such as FM Radio or Aux In.

Docking your iPad/iPhone/iPod

This system is equipped with a docking station, so that you can play and charge iPad/iPhone/iPod.

Choosing the correct adaptor

When connecting an iPad/iPhone/iPod to this iPod Dock, please ensure that the correct adaptor plate is used. FAILURE TO DO SO MAY RESULT IN DAMAGE TO THE iPad/iPhone/iPod.



To place a dock adaptor

1. The iPod dock comes with several removable dock adaptors. Refer to the Dock adapter compatibility chart shown later in this user manual to select the correct dock adaptor for the iPad/iPhone/iPod.
2. Place the proper adaptor from your iPad/iPhone/iPod accessories into the dock and press it into position.
3. Carefully align and then gently insert the iPad/iPhone/iPod into the dock. (The iPad/iPhone/iPod must not be in a case or "SKIN")
4. To remove or replace a dock adaptor, first remove the iPad/iPhone/iPod, then grip the adaptor and pull gently upwards.

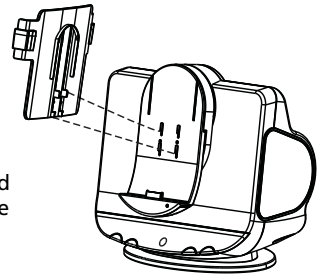

Docking your iPad/iPhone/iPod

Gently dock your iPad/iPhone/iPod to the 30 pin connector on the front of the unit. Do not force. If you have not already downloaded the free Acoustic Research Dock Plus App from the iTunes App Store, you will see the following message on your iPad/iPhone/iPod display: "This accessory requires an application that you do not have installed." The purpose of this message is to advise you that you must download the Acoustic Research Dock Plus App to enjoy the enhanced features of the unit. However, your iPad/iPhone/iPod will work properly with some reduced functionality with the unit even without the app installed.

IMPORTANT NOTES: When you dock your iPad/iPhone/iPod in the dock there may be a slight delay before the system recognizes the device and the main menu is displayed. This is because the system and the docked device must go through an 'Authentication Process' before the docked device can accept any commands. **THIS IS NORMAL AND IS NOT AN INDICATION OF ANY PROBLEM WITH YOUR SYSTEM.**



Charging your iPad/iPhone/iPod

Dock the iPad/iPhone/iPod to the universal dock for iPad/iPhone/iPod to charge the battery. Please make sure you are using the correct adaptor and that it is properly docked into this unit. **FAILURE TO DO SO MAY DAMAGE THE iPad/iPhone/iPod.**

PLEASE NOTE:

iPod Classic models can not be charged with this docking station.



Function Controls

Function Controls

Volume Controls

To increase or decrease the system volume, press the **VOLUME + / -** buttons on the on the unit or the **VOLUME + / -** buttons remote control.

SOUND Button (On Remote Control Only)

This button allows you to switch on/off 3D surround effect.

▶/⏸ (Play/Pause) (On Remote Control Only) – Press this button on the remote control to begin playback on your iPad/iPhone/iPod. Press again to Pause playback.

⏮/⏭ Skip Forward/Back buttons (On Remote Control Only) - During playback press to skip forward or backward to the next or previous track.

MENU button (On Remote Control Only)- If an iPod is docked and the Acoustic Research Dock Plus App is not running, this button operates exactly like the MENU button on the iPod itself.

PLEASE NOTE : The Aux Input is not available when an iPad/iPhone/iPod is docked AND the Dock Plus App is not running. To access Aux In, either remove the iPad/iPhone/iPod or launch the Dock Plus App which will then allow the selection of the desired source such as FM Radio or Aux

Menu Navigation by remote control does not work on touch screen products like iPad, iPhone.



▼/▲ buttons (On Remote Control Only) - Press the ▼/▲ buttons to move up (▲) or down (▼) within the Menu display.

ENTER button (On Remote Control Only) - After selecting the desired Genre, Album, Song, etc in the Menu display with the ▼/▲ buttons, press the **ENTER** button to Enter (Open) that Genre, Album, or begin playback of the selected song.

🔄 **ROTATE** button - When iPad/iPhone/iPod is docked, press the button to rotate the display orientation. Note that the landscape view is not available for all functions.

Operation

EN

1. If necessary, press the **⏻ POWER ON/OFF** button on the dock or press **⏻ / ON** button on the remote control to turn the system 'On'. The blue dock power LED will light up indicating that the power is on.
2. Make sure that you have inserted the correct adaptor into the dock. Then, insert your iPad/iPhone/iPod into the adaptor. If connection is successful, "Connected!" will be shown.

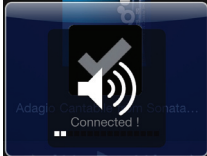

Your iPad/iPhone/iPod display will be on.

If you are playing music on your iPad/iPhone/iPod before docking, your iPad/iPhone/iPod may change to pause mode. It may take several seconds for your iPad/iPhone/iPod to go through the authentication process.

If your iPad/iPhone/iPod is paused when docking, it may remain in the pause mode. Press the **⏻ POWER ON/OFF** button on the dock or **▶/||** button on the remote control to resume playback.

3. To skip forward or backward to different tracks, press the **⏮/⏭** button on the remote control.
4. If an iPod is docked and the Acoustic Research Dock Plus App is not running:
 - The **MENU** button on the remote control works the same way as the **MENU** button on your iPad/iPhone/iPod. Press the **▼/▲** buttons on the remote control to navigate Up or Down through the displayed Menu list.
 - When the desired Genre, Artist, Album, or Song is 'highlighted' on your iPod Menu display, press the **ENTER** button on the remote control to 'Enter' or 'Select' the highlighted item. If the highlighted item is a specific song, pressing the **ENTER** button will begin playback of the song.
5. To pause iPod playback press the **⏻ POWER ON/OFF** button on the dock or **▶/||** button on the remote control. Press again to release pause and resume iPod playback.
6. To stop iPod playback press and hold **▶/||** button on the remote control until your iPod shuts off and enters the 'Charging' mode. However please note that the system power remains 'On'.
7. To shut the system 'Off' completely, press the **⏻ POWER ON/OFF** button on the dock or **⏻** button on the remote control for 3 seconds. The dock power LED turns "off".

Operation with Acoustic Research Dock Plus App

The first time the iPad/iPhone/iPod is docked, you will be prompted to download the Acoustic Research Dock Plus App from the Apple App Store. The Acoustic Research Dock Plus App is what provides additional functionality to your product. See the section "Before You Begin" for more details.

To launch the Acoustic Research Dock Plus App, simply select the Acoustic Research Dock Plus application on your iPad/iPhone/iPod.

Acoustic Research Dock Plus App General Controls



Alarm

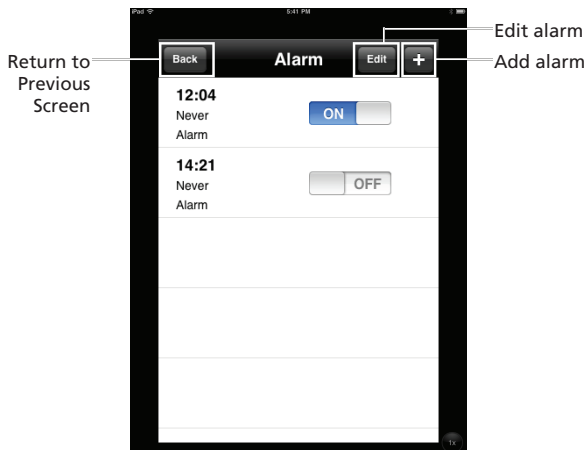

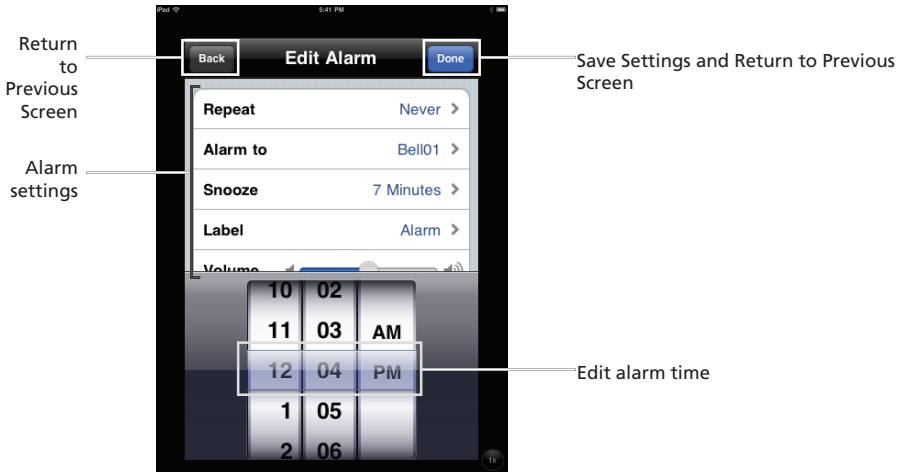

Settings

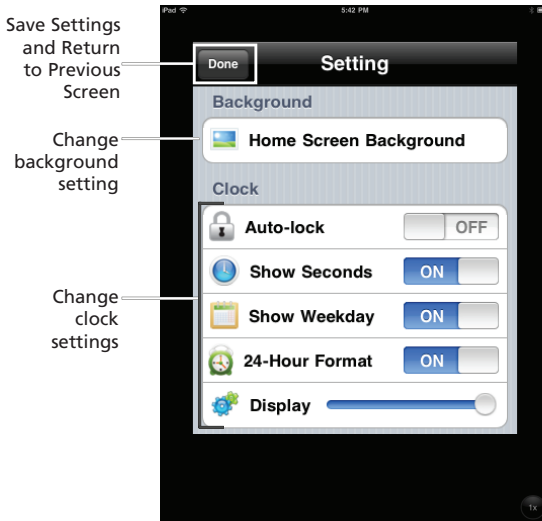

Note: for those menus which do not have EXIT buttons, you can simply touch elsewhere on the screen to exit









FM Tuner

FM antenna

This unit is equipped with an FM antenna at the back. Uncoil the antenna to its full length for best reception. Tape the end of the antenna onto the wall if possible to improve reception.

Accessing FM Radio

1. When the Acoustic Research Dock Plus App is running, press  or press MENU on the remote repeatedly until listen to the radio.
2. Press /  to adjust the frequency or press and hold /  to search through the frequency range. The radio stops searching when it detects the next station.
3. Touch  to add the current station to Favorites.
4. To listen to your Favorites stations, touch  to select your desired station.

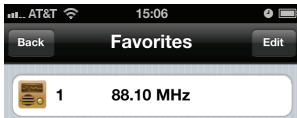

5. Touch  to set your region and to switch stereo on/off. Stereo is indicated by the  symbol.

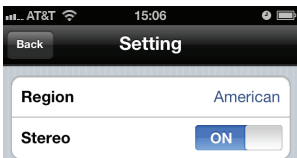

6. Press the **VOLUME** button to adjust the volume.

Radio listening can only be achieved via the Acoustic Research Dock Plus App.



Video operation

Connecting the Video Cord to View a Video/Picture from iPad/iPhone/iPod

When viewing a video/picture from iPad/iPhone/iPod on your TV, use a component video cord (not supplied) to connect the COMPONENT VIDEO OUT jack on the unit and the component video input on your TV.

EN

- After you have connected the unit, change the video input mode on your TV. For details, also refer to the instruction manual for your TV.

The below diagram shows the connection options available.

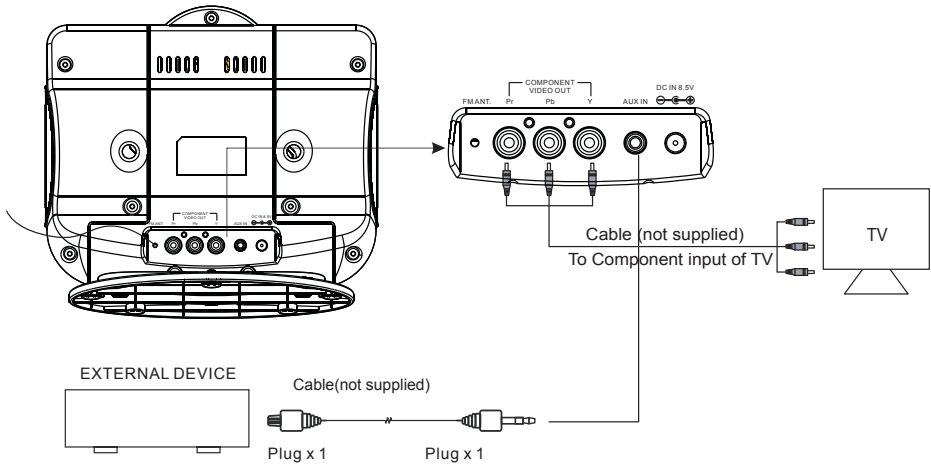

Consult your iPod documentation for details on how to enable video output on your model of iPad/iPhone/iPod.



Play videos on TV







1. Click the Videos icon in the iPod menu.
2. Select a video file and start playback.
3. Press VIDEO OUT button on the remote control to switch video output to your TV.

Remarks:

- If you are using iPod classic, iPod nano 3G/4G/5G, press **MENU** to change the video setting to TV output on your iPod before you switch the video output to your TV.
- Component video output to television at 480i or 576i resolution is supported by
 - iPhone
 - iPod touch
- Component video output to television at 480p or 576p resolution is supported by
 - iPad, iPad 2
 - iPhone 4
 - iPhone 3GS
 - iPhone 3G
 - iPod touch 2nd ,3rd and 4th generation
 - iPod nano 3rd, 4th ,5th and 6th generation
 - iPod classic

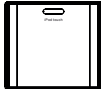
Dock adaptor and iPad/iPhone/iPod compatibility

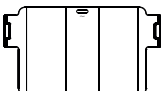
EN

Dock adaptor compatibility chart	
<p>Adaptor A: iPhone</p> 	<ul style="list-style-type: none"> • iPhone • iPhone 3G • iPhone 3GS • iPod classic (1st / 2nd generation)
<p>Adaptor B: iPhone 4</p> 	<ul style="list-style-type: none"> • iPhone 4
<p>Adaptor C: iPod Touch</p> 	<ul style="list-style-type: none"> • iPod Touch (1st / 2nd / 3rd / 4th generation) • iPod nano (1st / 2nd / 3rd / 6th generation)
<p>Adaptor D: 4G nano/ 5G nano</p> 	<ul style="list-style-type: none"> • iPod nano (4th / 5th generation)
<p>iPad</p> 	<ul style="list-style-type: none"> • iPad
<p>iPad 2</p> 	<ul style="list-style-type: none"> • iPad 2



Made for:

- iPad 2 16GB, 32GB, 64GB
- iPad 16GB, 32GB, 64GB
- iPhone 4 16GB, 32GB
- iPhone 3GS 8GB, 16GB, 32GB
- iPhone 3G 8GB, 16GB
- iPhone 4GB, 8GB, 16GB
- iPod touch 4th generation 8GB, 32GB, 64GB
- iPod touch 3rd generation 32GB, 64GB
- iPod touch 2nd generation 8GB, 16GB, 32GB
- iPod touch 1st generation 8GB, 16GB, 32GB
- iPod nano 6th generation 8GB, 16GB
- iPod nano 5th generation 8GB or 16GB
- iPod nano 4th generation (video) 8GB, 16GB
- iPod nano 3rd generation (video) 4GB, 8GB
- iPod nano 2nd generation (aluminum) 2GB, 4GB, 8GB
- iPod nano 1GB, 2GB or 4GB
- iPod classic 2nd generation 120GB
- iPod classic 80GB, 160GB

12 Month Limited Warranty Applies to AR Dock Products

EN

AUDIOVOX ACCESSORIES CORP. (the Company) warrants to the original retail purchaser of this product that should this product or any part thereof, under normal use and conditions, be proven defective in material or workmanship within 12 months from the date of original purchase, such defect(s) will be repaired or replaced with reconditioned product (at the Company's option) without charge for parts and repair labor.

To obtain repair or replacement within the terms of this Warranty, the product is to be delivered with proof of warranty coverage (e.g. dated bill of sale), specification of defect(s), transportation prepaid, to the Company at the address shown below.

This Warranty does not extend to the elimination of externally generated static or noise, to correction of antenna problems, loss/interruptions of broadcast or internet service, to costs incurred for installation, removal or reinstallation of product, to corruptions caused by computer viruses, spyware or other malware, to loss of media, files, data or content, or to damage to tapes, discs, removable memory devices or cards, speakers, accessories, computers, computer peripherals, other media players, home networks or vehicle electrical systems.

This Warranty does not apply to any product or part thereof which, in the opinion of the Company, has suffered or been damaged through alteration, improper installation, mishandling, misuse, neglect, accident, or by removal or defacement of the factory serial number/bar code label(s). THE EXTENT OF THE COMPANY'S LIABILITY UNDER THIS WARRANTY IS LIMITED TO THE REPAIR OR REPLACEMENT PROVIDED ABOVE AND, IN NO EVENT, SHALL THE COMPANY'S LIABILITY EXCEED THE PURCHASE PRICE PAID BY PURCHASER FOR THE PRODUCT.

This Warranty is in lieu of all other express warranties or liabilities. ANY IMPLIED WARRANTIES, INCLUDING ANY IMPLIED WARRANTY OF MERCHANTABILITY, SHALL BE LIMITED TO THE DURATION OF THIS WRITTEN WARRANTY. ANY ACTION FOR BREACH OF ANY WARRANTY HEREUNDER INCLUDING ANY IMPLIED WARRANTY OF MERCHANTABILITY MUST BE BROUGHT WITHIN A PERIOD OF 24 MONTHS FROM DATE OF ORIGINAL PURCHASE. IN NO CASE SHALL THE COMPANY BE LIABLE FOR ANY CONSEQUENTIAL OR INCIDENTAL DAMAGES FOR BREACH OF THIS OR ANY OTHER WARRANTY. No person or representative is authorized to assume for the Company any liability other than expressed herein in connection with the sale of this product.

Some states do not allow limitations on how long an implied warranty lasts or the exclusion or limitation of incidental or consequential damage so the above limitations or exclusions may not apply to you. This Warranty gives you specific legal rights and you may also have other rights which vary from state to state.

Recommendations before returning your product for a warranty claim:

- Properly pack your unit. Include any remotes, memory cards, cables, etc. which were originally provided with the product. However DO NOT return any removable batteries, even if batteries were included with the original purchase. We recommend using the original carton and packing materials. Ship to the address shown below.
- Note that product will be returned with factory default settings. Consumer will be responsible to restore any personal preference settings.

Audiovox Electronics Corp.
Attn: Service Department.
150 Marcus Blvd.
Hauppauge N.Y. 11788

1-800-645-4994

For Canada Customers, please ship to:
Audiovox Return Centre
c/o Genco
6685 Kennedy Road,
Unit#3, Door 16,
Mississauga, Ontario
L5T 3A5

Free Manuals Download Website

<http://myh66.com>

<http://usermanuals.us>

<http://www.somanuals.com>

<http://www.4manuals.cc>

<http://www.manual-lib.com>

<http://www.404manual.com>

<http://www.luxmanual.com>

<http://aubethermostatmanual.com>

Golf course search by state

<http://golfingnear.com>

Email search by domain

<http://emailbydomain.com>

Auto manuals search

<http://auto.somanuals.com>

TV manuals search

<http://tv.somanuals.com>