

# AEG

 Electrolux

## OPERATION MANUAL

### Gas Cooktop

**CGA 60 WOK, CGA 75 WOK, CGA 90 WOK**

Congratulations on the purchase of your **AEG** appliance.

We are sure it will provide many years of great cooking experience.

You may find that it has different features and characteristics to your last appliance.

It is essential you read this operation manual thoroughly to fully understand all of the various functions and operations. Experiment with your cooking and take advantage of the features your new appliance offers.

This manual should be retained for future reference. Should ownership of the appliance be transferred, please ensure that the manual is also passed onto the new owner.

## Contents

<b>A -</b>	<b>Installation check and warnings</b>	<b>Page 3</b>
<b>B -</b>	<b>Cooking Instructions</b>	<b>Page 4</b>
<b>C -</b>	<b>Cleaning</b>	<b>Page 5</b>
<b>D-</b>	<b>Installation &amp; Warnings</b>	<b>Page 6</b>
<b>E-</b>	<b>Technical Diagrams</b>	<b>Page 9 - 10</b>
<b>F-</b>	<b>Technical Characteristics Table</b>	<b>Page 9</b>
<b>G-</b>	<b>Warranty</b>	<b>Page 11</b>

# A -

# Installation check and warnings

We invite you to read this instruction booklet carefully, before installing and using the equipment.

If this equipment should be sold or transferred to another person, please ensure that the new user receives this booklet.

This appliance complies with the following Directives:

EEC 90/396 (Gas)

EEC 73/23 e 93/68 (Low Voltage)

EEC 89/336 (Electromagnetic Compatibility)

EEC 89/109 (Contact with foods)

## NOTE:

- The installation must be carried out by experienced and qualified personnel, in conformity with the regulations in force.
- The equipment has been designed to be used by adults only. Please monitor children closely when they're near the appliance to ensure their safety.
- Before powering the equipment, check that it is properly adjusted for the type of gas at disposal.
- Before carrying out the maintenance or cleaning the equipment, cut power supply off and make it cool down.
- Make sure that air circulates around the gas equipment. Insufficient ventilation produces a lack of oxygen resulting in possible malfunctions.
- In case of an intense or prolonged use of the equipment, it may be necessary to improve aeration.
- The products of combustion must be discharged outside through a suction hood or an electric fan.
- For any possible modification, apply to an authorized Technical Assistance Centre and demand original spare parts.

## WARNING:

If the appliance is equipped with a glass cover turn off all the burners and wait a few minutes before closing the cover.

***The manufacturer refuses all responsibility for possible damages to things or people, resulting from incorrect installation or from an incorrect, improper or unreasonable use of the appliance.***

**Automatic start-up without valves**

Turn the corresponding knob anti-clockwise up to the maximum position (large flame, Fig. 1) and press start-up button P(fig. 1).

**Automatic start-up with valves**

Turn the corresponding knob anticlockwise up to the maximum position (large flame, fig. 1) and press the knob.

Once the burner has been started up, keep the knob pressed for about 6 seconds.

**Using the burners**

In order to obtain the maximum yield without wasting gas, it is important that the diameter of the pot is suitable for the burner potential (see the following table). This is to avoid the flame extremities being larger than the base of the pot.

All of the operating positions must be chosen between the maximum and the minimum ones, never between the minimum position and the closing point.

The gas supply can be interrupted by turning the knob clockwise up to the closing position.

**NOTE:**

If there is no power supply, it is possible to light the burners with matches, setting the knob to the start-up point (large flame, fig. 1).

BURNERS	POWER (MJ/h) POWER (Btu/h)	Ø of pots
Auxiliary	3.2 3000	10 - 14 cm
Semi-rapid	6.3 6000	16 - 18 cm
Rapid	11.6 11000	20 - 22 cm
Wok	17.9 17000	24 - 26 cm

**NOTE:**

When the equipment is switch off, always check that the knobs are in the closing position.

If the flame should blow out accidentally, the safety valve will automatically stop the gas supply, after a few seconds. To restore operation, set the knob to the lighting point (large flame, fig. 1) and press. While cooking with fat or oil, pay the utmost attention as these substances can catch fire when overheated.

**WARNING:**

- Do not use sprays near the appliance in operation.
- Do not place unstable or deformed pots on the burner, so as to prevent them from overturning or overflowing.
- Always turn gas off if moving a pot away from the appliance.

**WARNING:**

- Before any operation, disconnect the appliance from the electric grid.
- Do not clean the appliance while it is hot.

**Enameled Burner Caps**

The enameled burner caps must be washed with a sponge and soapy water or with a light detergent.

**WARNING:**

- Do not use abrasive or corrosive products.
- Do not leave substances, such as lemon or tomato juice, salt water, vinegar, coffee and milk on the enameled surfaces for a long time.

**Stainless Steel**

The stainless steel parts should also be cleaned with soapy water and then dried with a soft cloth.

**WARNING:**

- Stainless steel can be stained if it remains in contact with highly calcareous water or aggressive detergents for an extended period of time.
- Stainless Steel can also discolour if in contact with excessive heat.

**Burners and racks**

These parts can be removed to make cleaning easier.

The burners must be washed with a sponge and soapy water or with a light detergent, wiped well and placed in their housing perfectly.

After cleaning, check that the feeler of the safety valve, start-up electrode and the flame-dividing ducts are not clogged with soap or grime.

The racks can be washed in the dishwasher.

**Gas taps****WARNING:**

Lubrication of the gas taps must be carried out by specialized personnel, exclusively.

In case of hardening or malfunctions in the gas taps, apply to the Customer Service.

**NOTE:**

**THE OPERATIONS INDICATED BELOW MUST BE FOLLOWED BY QUALIFIED PERSONNEL EXCLUSIVELY, IN CONFORMITY WITH THE REGULATIONS IN FORCE.**

**THE MANUFACTURING FIRM REFUSES ALL RESPONSIBILITY FOR DAMAGES TO PEOPLE, ANIMALS OR OBJECTS, RESULTING FROM THE FAILURE TO COMPLY WITH SUCH PROVISIONS.**

The appliance is designed to be embedded into heat-resistant cabinetry.

Cut a hole in the top of the cabinetry, with the dimensions indicated in fig. 3, at a distance of at least 50 mm from the appliance border to the adjacent walls.

**WARNING:**

- The surrounding cabinetry must resist a minimum temperature of 75°C.
- The equipment must not be installed near inflammable materials, such as curtains, cloths, etc.

( Ref to Fig. 3 on page 8)

MODEL	L (mm)	P (mm)
600-750	560	490
900	820	490

If there are any over-head cabinets above the cooktop they must be a minimum of 762 mm (30") higher. The distance on the left and on the right side from lateral wall should be at least 110 mm (4.5"), while the distance from the back wall should be at least 25 mm (1").

It is advisable to isolate the appliance from the piece of furniture below with a separator, leaving a depression space of at least 10 mm (fig. 4).

If the hob is going to be installed above an oven, precautions must be taken to guarantee installation is in accordance with current accident prevention standards. Pay particular attention to the position of the electric cable and gas pipe: they must not touch any hot parts of the oven.

**WARNING:**

If the hob is going to be installed on the top of a built-in oven without forced cooling ventilation, proper air vents must be installed to guarantee an adequate ventilation, with the lower air entering

with a cross section of at least 200cm<sup>2</sup>, and the higher air exiting with a cross section of at least 60 cm<sup>2</sup>.

**Fastening the top**

Every cook-top is equipped with a special washer and a set of hooks for mounting the cook-top.

Once the cut-out is made in the cabinet surface, the installation procedure is as follows:

- Remove the trivets and complete burners from the top.
- Turn the appliance upside down and lay the 'S' washer along the external border (fig. 5).
- Place the cook-top in the hole made in the piece of furniture then block it with the V screws of the fastening hooks G (fig. 6 / 6A).

**NOTE:**

This appliance is not provided with a device for exhausting the products of combustion.

Please check your local regulations to ensure installation is in conformity.

**Gas Connection**

Make sure that the appliance is adjusted for the gas type available in your area (see the label under the appliance). Follow the instructions indicated in the chapter "gas transformations and adjustments" for the possible adaptation to different gases.

The appliance must be connected to the gas system by means of still metal pipes or flexible steel pipes having continuous walls, in compliance with the regulations in force in your area. Some models are equipped with cylindrical A and conical B connectors for gas supply (fig. 7).

**WARNING:**

The connection must not stress the gas ramp.

**Electric connection**

The connection to the electric grid must be carried out by qualified personnel and in conformity with the regulations in force in your area.

The voltage of the electric system must correspond to the value indicated in the label under the appliance. Make sure that the electric system is provided with an effective ground connection in compliance with the regulations and provisions of the law.

Grounding is compulsory.

**GAS TRANSFORMATIONS AND ADJUSTMENTS****Replacing the nozzles**

If the equipment is adjusted for a type of gas that is different from the original, it is necessary to replace the burner nozzles as well. The nozzles used to replace the original must be in accordance with the table of the technical characteristics enclosed.

To remove the racks and burners by means of a straight spanner 'L', unscrew the nozzle 'U' (Fig.8) and substitute it with the corresponding one and tighten the nozzle.

**Adjusting the burners**

The flame should always stay alight when the burner is switched on, even if there is an abrupt shift from the maximum to minimum flame position. If the flame does not stay alight, adjust it as follows:

- Start the burner
- Turn the tap up to the minimum position (small flame)
- Remove the knob from the tap rod
- Using a flat-tip screwdriver 'C' into the hole 'F' of the tap (fig.9) turn the by-pass screw up.

**MAINTENANCE****Lubricating the taps**

In the case of tap hardening, it is necessary to disassemble the tap and grease it.

- Unscrew the two screws that lock the head flange of the tap.
- Lift the gas adjusting cone and carefully clean it with gasoline or diluent.
- Spread a little high-temperature grease on it, making sure that the gas holes are not obstructed.
- Reassemble all of the parts with care.

**Replacing the power supply cable**

If the power supply cable needs to be replaced, it is necessary to use a cable with a section of 3x0.75mm<sup>2</sup>, type H05VV-F or H05RR-F, complying with the regulations in force.

**NOTE:**

The connection to the terminal board must be effected as shown in fig. 10 - 10A:

**Brown cable L (phase)**

**Blue cable N (neutral)**

**Green-yellow cable (ground)**

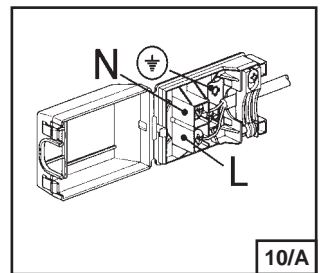
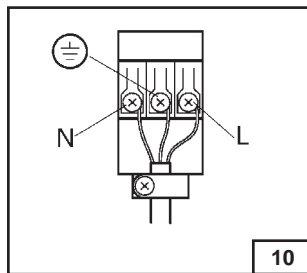
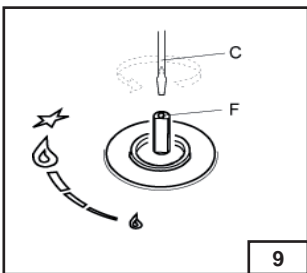
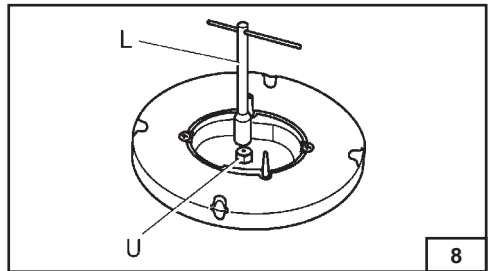
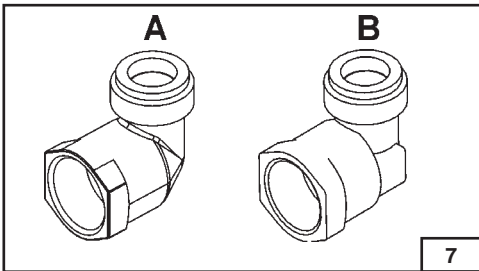
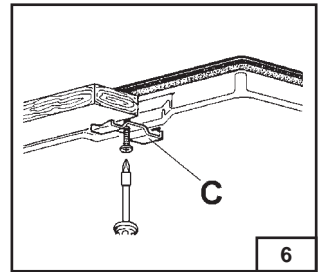
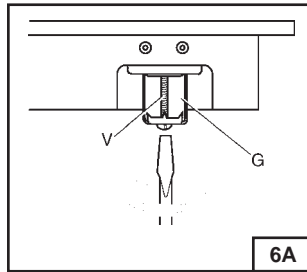
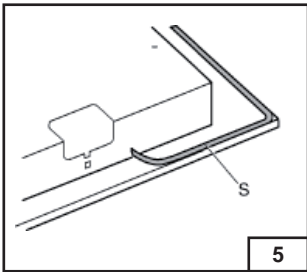
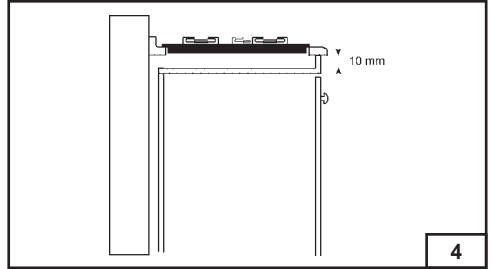
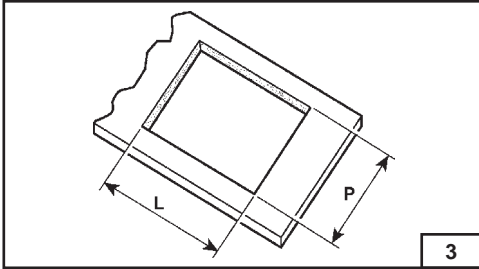
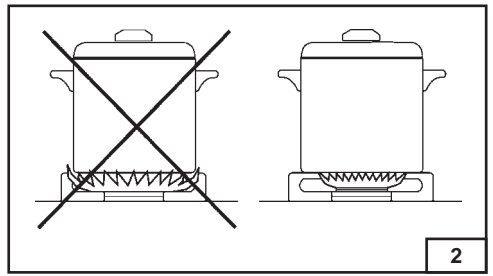
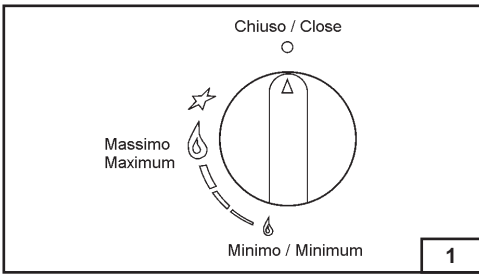



## E -

## Technical Diagrams

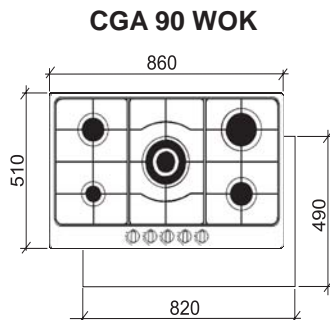
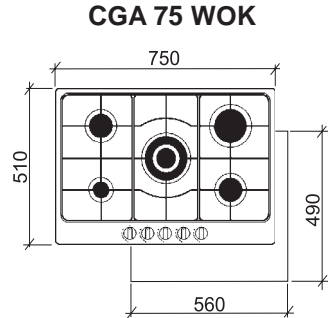
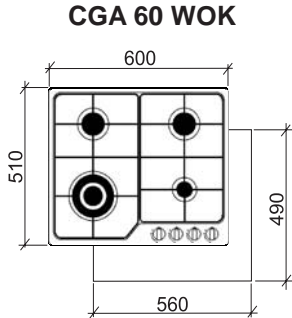

## F -

## Technical Characteristics Table

BURNERS		GAS	NORMAL PRESSURE	INJECTOR DIAMETER	TAPE BY PASS DIAMETER	NOMINAL HEAT INPUT MAX.
N°	DESCRIPTION					
1	RAPID	PROPANE	28	92	42	11.6 (11000)
		NATURAL	10	155	REG.	
2	SEMI-RAPID	PROPANE	28	72	31	6.3 (6000)
		NATURAL	10	120	REG.	
3	AUXILIARY	PROPANE	28	55	27	3.2 (3000)
		NATURAL	10	90	REG.	
4	WOK	PROPANE	28	107	60	17.9 (17000)
		NATURAL	10	175	REG.	

The manufacturing firm refuses all responsibility for any possible imprecision in this booklet, due to misprints or clerical errors. It reserves the right to make all the changes that it will consider necessary in its own products, without affecting the essential characteristics of functionality and safety.

CGA 60 WOK

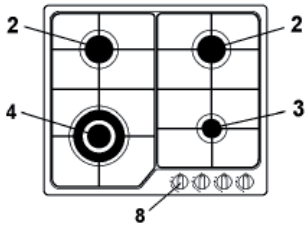

CGA 75 WOK

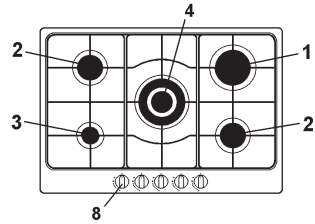

CGA 90 WOK

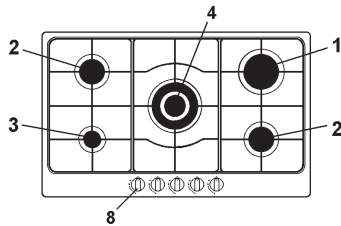

	POWER (MJ/h)	POWER (Btu/h)
1 Rapid burner	11.6	11000
2 Semi-rapid burner	6.3	6000
3 Auxiliary burner	3.2	3000
4 Triple ring burner	17.9	17000
8 Control knob for burner		

**AEG** products are designed and built to the highest standards.

We expect your appliances to provide many years of trouble free enjoyment.

In the event of an appliance requiring attention, each appliance is covered by a 2 year warranty from the date of purchase.

Refer to warranty policy for complete terms and conditions.

Coverage is for costs of parts and labor for appliances in capital cities & metropolitan areas. We reserve the right to charge directly for handling expenses outside the metropolitan region.

**AEG** products are supported by a national service support system.

Call our customer service department for attention.

**Please retain your AEG invoice to quote should you require service assistance. This will identify your product for our priority service back-up. Please attach your invoice to this manual for easy future reference.**

**AEG**  
**Unit 20,**  
**2150 Winston Park Drive,**  
**Oakville, Ontario,**  
**Canada L6H5V1**

Tel 905-829.3980

Fax 905-829.3985

email: [marketing@euro-line-appliances.com](mailto:marketing@euro-line-appliances.com)

For Service & Spares:

**EURO-PARTS**

1-800.678-8352

**Important:** Please record details of your purchase below and mail or fax to AEG:

----- cut along line -----

# AEG

 Electrolux

Name: \_\_\_\_\_ Tel n° \_\_\_\_\_

Address: \_\_\_\_\_

City: \_\_\_\_\_ State: \_\_\_\_\_ Zip Code: \_\_\_\_\_

Where purchased: \_\_\_\_\_ Purchase date : \_\_\_\_\_

Items purchased: \_\_\_\_\_

Serial No. (s): \_\_\_\_\_

# AEG

 Electrolux

**AEG**

Unit 20,  
2150 Winston Park Drive,  
Oakville, Ontario,  
Canada L6H5V1

Tel 905-829.3980

Fax 905-829.3985

email: [marketing@euro-line-appliances.com](mailto:marketing@euro-line-appliances.com)

For Service & Spares:

**EURO-PARTS**

1-800.678-8352

## Free Manuals Download Website

<http://myh66.com>

<http://usermanuals.us>

<http://www.somanuals.com>

<http://www.4manuals.cc>

<http://www.manual-lib.com>

<http://www.404manual.com>

<http://www.luxmanual.com>

<http://aubethermostatmanual.com>

Golf course search by state

<http://golfingnear.com>

Email search by domain

<http://emailbydomain.com>

Auto manuals search

<http://auto.somanuals.com>

TV manuals search

<http://tv.somanuals.com>