

# MC2660E

## Microwave oven

### Operating instructions



PERFEKT IN FORM UND FUNKTION

**AEG**

Download from [Www.Somanuals.com](http://www.Somanuals.com). All Manuals Search And Download.

# Dear Customer,

Thank you for buying an AEG microwave oven and putting your trust in the AEG brand name.

Before using your AEG microwave oven for the first time, please read the instruction book thoroughly. This will enable you to take advantage of all the features that the appliance offers. It will also ensure trouble-free operation and minimize unnecessary service calls.



Important information concerning your safety or the operation of your appliance is noted by this symbol and/or mentions words such as «**Warning**», «**Take care**». Be sure to follow all instructions carefully.



Throughout the manual, this symbol guides you step by step when operating the appliance.



This symbol indicates further information concerning the use of the appliance.



The clover indicates energy-saving tips and hints for environmentally friendly use of your appliance.

In the event of malfunctioning, please follow the instructions given in the section «What to do if...»

# Contents

Important safety instructions .....	2 - 3
Oven & accessories .....	4
Control panel .....	5
Before operation .....	6
Setting the clock .....	6
What are microwaves? .....	7
Suitable ovenware .....	7 - 8
Tips & advice .....	8 - 12
Microwave power levels .....	13
Microwave cooking .....	14
Other convenient functions .....	15 - 16
Auto cook, cook from frozen & auto defrost operation .....	17 - 18
Auto cook, cook from frozen & auto defrost charts .....	19 - 21
Recipes for auto cook .....	22 - 23
Cooking charts .....	24 - 26
Recipes .....	26 - 37
Care & cleaning .....	38
What to do if... ..	38
Service & spare parts .....	39
Customer service .....	39
Guarantee conditions .....	40
Specifications .....	41
Important information .....	41
Installation .....	42 - 43



# Important safety instructions

## IMPORTANT SAFETY INSTRUCTIONS: READ CAREFULLY AND KEEP FOR FUTURE REFERENCE

To avoid the danger of fire.

**The microwave oven should not be left unattended during operation. Power levels that are too high, or cooking times that are too long, may overheat foods resulting in a fire.**

The electrical outlet must be readily accessible so that the unit can be unplugged easily in an emergency. Do not store or use the oven outdoors.

**If food being heated begins to smoke, DO NOT OPEN THE DOOR. Turn off and unplug the oven and wait until the food has stopped smoking. Opening the door while food is smoking may cause a fire.**

**Only use microwave-safe containers and utensils. See Pages 7 - 8.**

**Do not leave the oven unattended when using disposable plastic, paper or other combustible food containers.**

**Clean the waveguide cover, the oven cavity, the turntable and turntable support after use. These must be dry and free from grease. Built-up grease may overheat and begin to smoke or catch fire.**

Do not place flammable materials near the oven or ventilation openings. Do not block the ventilation openings.

Remove all metallic seals, wire twists, etc., from food and food packages. Arcing on metallic surfaces may cause a fire.

Do not use the microwave oven to heat oil for deep frying. The temperature cannot be controlled and the oil may catch fire.

To make popcorn, only use special microwave popcorn makers.

Do not store food or any other items inside the oven.

Check the settings after you start the oven to ensure the oven is operating as desired.

See the corresponding hints in operation manual.

To avoid the possibility of injury

### WARNING:

Do not operate the oven if it is damaged or malfunctioning. Check the following before use:

- The door; make sure the door closes properly and ensure it is not misaligned or warped.
- The hinges and safety door latches; check to make sure they are not broken or loose.
- The door seals and sealing surfaces; ensure that they have not been damaged.
- Inside the oven cavity or on the door; make sure there are no dents.
- The power supply cord and plug; ensure that they are not damaged.

**Never adjust, repair or modify the oven yourself. It is hazardous for anyone other than a competent person to carry out any service or repair operation which involves the removal of a cover which gives protection against exposure to microwave energy.**

Do not operate the oven with the door open or alter the door safety latches in any way.

Do not operate the oven if there is an object between the door seals and sealing surfaces.

**Do not allow grease or dirt to build up on the door seals and adjacent parts. Follow instructions for "Care and Cleaning", Page 38. Failure to maintain the oven in a clean condition could lead to a deterioration of the surface that could adversely affect the life of the appliance and possibly result in a hazardous situation.**

Individuals with PACEMAKERS should check with their doctor or the manufacturer of the pacemaker for precautions regarding microwave ovens.

### To avoid the possibility of electric shock

Under no circumstances should you remove the outer cabinet.

Never spill or insert any objects into the door lock openings or ventilation openings. In the event of a spill, turn off and unplug the oven immediately and call your local Service Force Centre.

Do not immerse the power supply cord or plug in water or any other liquid.

Do not allow the power supply cord to run over any hot or sharp surfaces, such as the hot air vent area at the top rear of the oven.

Do not attempt to replace the oven lamp yourself or allow anyone who is not authorised by Service Force to do so. If the oven lamp fails, please consult your dealer or contact your local Service Force Centre.

If the power supply cord of this appliance is damaged, it must be replaced with a special cord. The exchange must be made by an authorised Service Force technician.



# Important safety instructions

**To avoid the possibility of explosion and sudden boiling:**

**WARNING: Liquids and other foods must not be heated in sealed containers since they are liable to explode.**

Never use sealed containers. Remove seals and lids before use. Sealed containers can explode due to a build up of pressure even after the oven has been turned off.

Take care when microwaving liquids. Use a wide-mouthed container to allow bubbles to escape.

**Microwave heating of beverages can result in delayed eruptive boiling, therefore care has to be taken when handling the container.**

To prevent sudden eruption of boiling liquid and possible scalding:

1. Stir liquid prior to heating/reheating.
2. It is advisable to insert a glass rod or similar utensil into the liquid whilst reheating.
3. Let liquid stand in the oven at the end of cooking time to prevent delayed eruptive boiling.

**Do not cook eggs in their shells, and whole hard boiled eggs should not be heated in microwave ovens since they may explode even after microwave cooking has ended. To cook or reheat eggs which have not been scrambled or mixed, pierce the yolks and the whites, or the eggs may explode. Shell and slice hard boiled eggs before reheating them in the microwave oven.**

Pierce the skin of such foods as potatoes, sausages and fruit before cooking, or they may explode.

**To avoid the possibility of burns**

Use pot holders or oven gloves when removing food from the oven to prevent burns.

Always open containers, popcorn makers, oven cooking bags, etc., away from the face and hands to avoid steam burns.

**To avoid burns, always test food temperature and stir before serving and pay special attention to the temperature of food and drink given to babies, children or the elderly.**

Temperature of the container is not a true indication of the temperature of the food or drink; always check the food temperature.

Always stand back from the oven door when opening it to avoid burns from escaping steam and heat.

Slice stuffed baked foods after heating to release steam and avoid burns.

Keep children away from the door to prevent them burning themselves.

**To avoid misuse by children**

**Warning: Only allow children to use the oven without supervision when adequate instructions have been given so that the child is able to use the oven in a safe way and understands the hazards of improper use.**

Do not lean or swing on the oven door. Do not play with the oven or use it as a toy.

Children should be taught all important safety instructions: use of pot holders, careful removal of food coverings; paying special attention to packaging (e.g. self-heating materials) designed to make food crisp, as they may be extra hot.

**Other warnings**

Never modify the oven in any way.

This oven is for home food preparation only and may only be used for cooking food. It is not suitable for commercial or laboratory use.

**To promote trouble-free use of your oven and avoid damage.**

Never operate the oven when it is empty.

When using a browning dish or self-heating material, always place a heat-resistant insulator such as a porcelain plate under it to prevent damage to the turntable and turntable support due to heat stress. The preheating time specified in the dishes instructions must not be exceeded.

Do not use metal utensils, which reflect microwaves and may cause electrical arcing. Do not put cans in the oven. Only use the turntable and the turntable support designed for this oven. Do not operate the oven without the turntable.

To prevent the turntable from breaking:

- (a) Before cleaning the turntable with water, leave the turntable to cool.
- (b) Do not put hot foods or hot utensils on a cold turntable.
- (c) Do not put cold foods or cold utensils on a hot turntable.

Do not place anything on the outer cabinet during operation.

**NOTE:**

If you are unsure how to connect your oven, please consult an authorised, qualified electrician.

Neither the manufacturer nor the dealer can accept any liability for damage to the oven or personal injury resulting from failure to observe the correct electrical connection procedure.

Water vapour or drops may occasionally form on the oven walls or around the door seals and sealing surfaces. This is a normal occurrence and is not an indication of microwave leakage or a malfunction.

# Oven & accessories

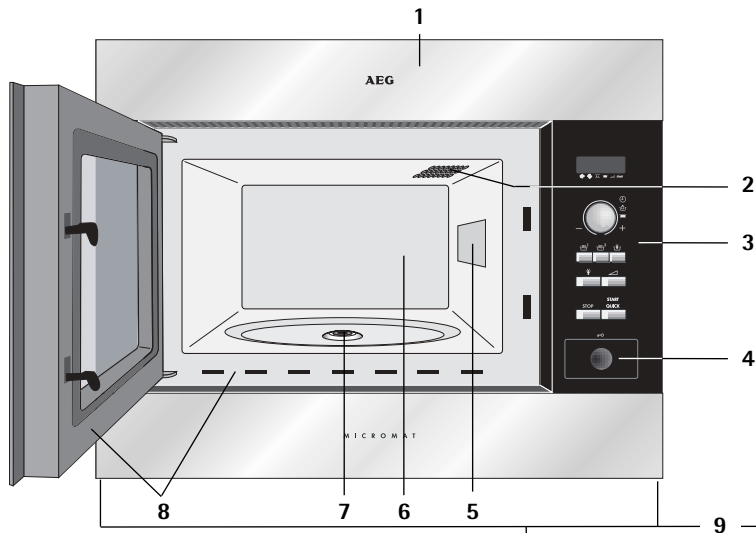

1. Front trim
2. Oven lamp
3. Control panel
4. Door opening button
5. Waveguide cover
6. Oven cavity
7. Seal packing
8. Door seals and sealing surfaces
9. Fixing points (4 points)

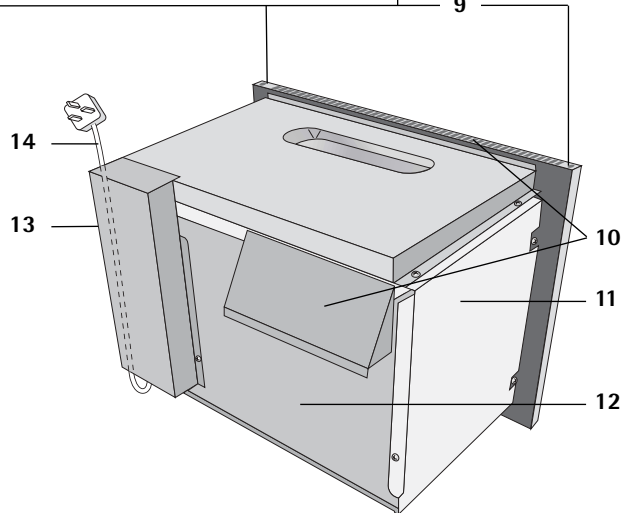

## ACCESSORIES:

Check to make sure the following accessories are provided:

- (15) Turntable (16) Turntable support  
 (17) 4 fixing screws (not shown).

- Place the turntable support in the seal packing on the floor of the cavity.
- Then place the turntable on the turntable support.
- To avoid turntable damage, ensure dishes or containers are lifted clear of the turntable rim when removing them from the oven.

**NOTE:** When you order accessories, please mention two items: part name and model name to your dealer or local Service Force Centre.

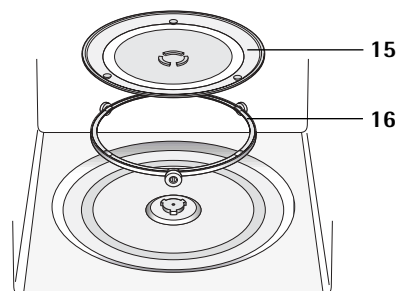



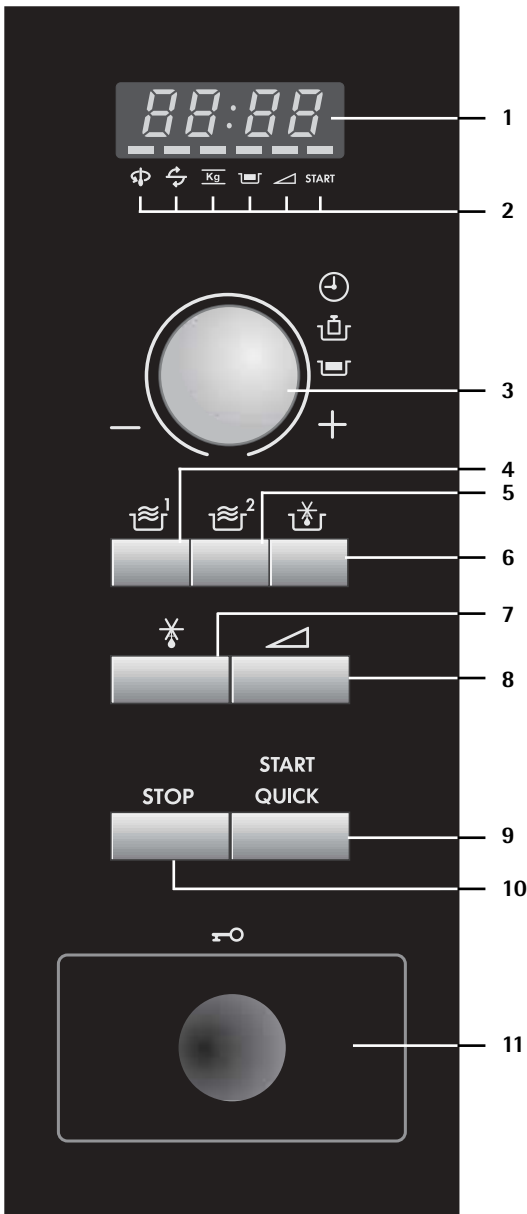



# Control panel



## 1 Digital Display

## 2 Indicators

The appropriate indicator will flash or light up, just above each symbol according to the instruction. When an indicator is flashing, press the appropriate button (having the same symbol) or carry out the necessary operation.

-  Stir
-  Turn over
-  Weight
-  Portion
-  Microwave power level
-  Cooking in progress

## 3 TIMER/WEIGHT/POROTION knob

## 4 AUTO COOK 1 button

Press to select one of the 2 automatic programmes.

## 5 AUTO COOK 2 button

Press to select one of the 2 automatic programmes.

## 6 COOK FROM FROZEN button

Press to select one of the 3 automatic programmes.

## 7 AUTO DEFROST button

Press to select one of the 5 automatic programmes.

## 8 MICROWAVE POWER LEVEL button

## 9 START/QUICK button

## 10 STOP button

## 11 DOOR OPENING button

# Before operation

Plug in the oven.

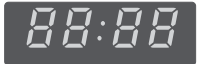
1. The oven display will flash: 

2. Touch the **STOP** button the display will show:



To set the clock, see below.



## Using the Stop button

Use the **STOP** button to:

1. Erase a mistake during programming.
2. Stop the oven temporarily during cooking.
3. Cancel a programme during cooking, touch twice.

# Setting the clock

There are two setting modes: 12 hour clock and 24 hour clock.

1. To set the 12 hour clock, hold the **MICROWAVE POWER LEVEL** button down for 3 seconds.  will appear in the display.
2. To set the 24 hour clock, press the **MICROWAVE POWER LEVEL** button once more after Step 1, in the example below  will appear in the display.



**x1** and hold for 3 secs.

To set the clock, follow the example below.

**Example:** To set the 24 hour clock to 23:35

1. Choose the clock function. (12 hour clock) Choose the 24 hour clock.
2. Set the hours. Rotate the **TIMER/WEIGHT/POROTION** knob until the correct hour is displayed (23).
3. Press the **MICROWAVE POWER LEVEL** button to change from hours to minutes.

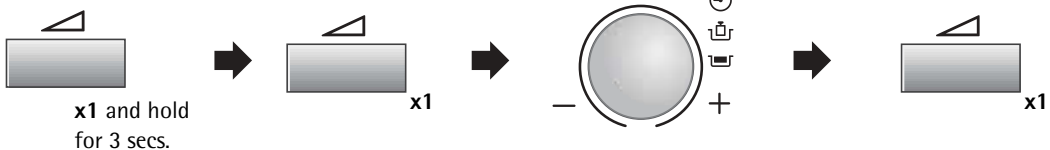

4. Set the minutes. Rotate the **TIMER/WEIGHT/POROTION** knob until the correct minute is displayed. (35).
  5. Press the **MICROWAVE POWER LEVEL** button to start the clock.
- Check the display.**

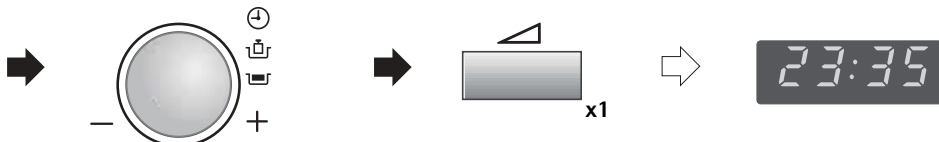

### NOTE:

1. You can rotate the **TIMER/WEIGHT/POROTION** knob clockwise or counter-clockwise.
2. Press the **STOP** button if you make a mistake during programming.
3. If the electrical power supply to your microwave oven is interrupted, the display will intermittently show  after the power is reinstated. If this occurs during cooking, the programme will be erased. The time of day will also be erased.
4. When you want to reset the time of day, follow the above example again.



# **i** What are microwaves?

## What are microwaves?

Like radio and television waves, microwaves are electromagnetic waves.

Microwaves are produced by a magnetron inside the microwave oven, and these vibrate the molecules of water present in the food. The friction this causes produces heat, which ensures that the food is defrosted, heated, or cooked through.

The secret of the reduced cooking times is the fact that the microwaves penetrate the food from every direction. Energy is used to the full. In comparison, the energy from a conventional hob passes from the burner through the pan and so to the food. This method wastes a great deal of energy.

## The characteristics of microwaves.

Microwaves penetrate all non-metal objects made of glass, china, earthenware, plastic, wood or paper. This is why the microwaves never make these materials hot. Dishes become hot only because the food inside them is hot.

The food absorbs the microwaves and is heated.

Microwaves cannot pass through objects made of metal and so they are deflected. For this reason metal objects are not normally suitable for microwave cookery. There are exceptions where you can actually make use of the fact that the microwaves cannot pass through metal. If you cover food with aluminium foil at specific points while it is defrosting or cooking, you can prevent those parts from getting too warm, too hot, or overcooked. Please check out the advice given in the guide.

# **i** Suitable ovenware

## Glass and ceramic glass

Heat-resistant glass utensils are very suitable. The cooking process can be observed from all sides. They must not, however, contain any metal (e.g. lead crystal), nor have a metallic overlay (e.g. gold edge, cobalt blue finish).

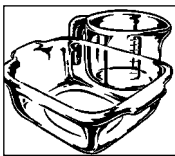

## Ceramics

Generally very suitable. Ceramics must be glazed, since with unglazed ceramics moisture can get into the ceramic. Moisture causes the material to heat up and may make it shatter. If you are not certain whether your utensil is suitable for the microwave, carry out the utensil suitability test.

## Porcelain

Very suitable. Ensure that the porcelain does not have a gold or silver overlay and that it does not contain any metal.

## Plastic & paper utensils

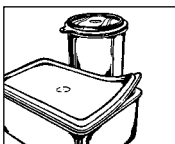

Heat resistant plastic utensils which are suitable for use in the microwave can be used to thaw, heat and cook food. Follow the manufacturers recommendations.

Heat-resistant paper made for use in a microwave oven is also suitable. Follow the manufacturers recommendations.

## Kitchen paper

can be used to absorb any moisture which occurs in short heating methods, e.g. of bread or products in bread crumbs. Insert the paper between the food and the revolving plate. The surface of the food will stay crispy and dry. Covering greasy food with kitchen paper will catch splashes.

## Microwave cling film

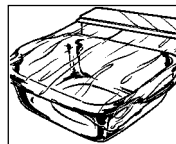

This, or heat-resistant film, is very suitable for covering or wrapping. Please follow the manufacturer's recommendations.

## Roasting bags

Can be used in a microwave oven. Metal clips are not suitable for fastening them since the roasting bag foil might melt. Fasten the roasting bag with string and pierce it several times with a fork. Non heat-resistant food wraps are not recommended for use in a microwave oven.

## Browning dish

A special microwave dish made from ceramic glass with a metal alloy base, which allows food to be browned. When using the browning dish a suitable insulator, e.g. a porcelain plate, must be placed between the turntable and the browning dish. Be careful to adhere exactly to the pre-heating time given in the manufacturer's instructions. Excessive pre-heating can damage the turntable and the turntable stand or can trigger the safety-device which will switch off the oven.

## **i** Suitable ovenware

### Metal

Generally speaking, metal should not be used, since microwaves do not pass through metal and therefore cannot reach the food. There are, however, exceptions: small strips of aluminium foil may be used to cover certain parts of the food, so that these do not thaw too quickly or begin to cook (e.g. chicken wings). Small metal skewers and aluminium containers (e.g. of ready-cooked meals) can be used. They must, however, be small in relation to the food, e.g. aluminium containers must be at least 2/3 to 3/4 filled with food. It is recommended that you transfer the food into a dish suitable for use in the microwave.

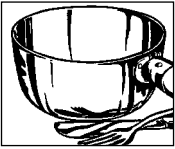
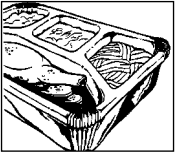

When using aluminium containers or other metal utensils there must be a gap of approx. 2 cms between them and the walls of the cooking area, otherwise the walls could be damaged by possible arcing.

**No utensil should have a metal overlay** metal parts such as screws, bands or handles.

### UTENSIL SUITABILITY TEST

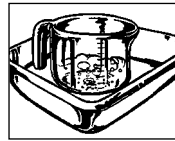

If you are not sure whether your utensil is suitable for use in your microwave oven, carry out the following test: Place the utensil into the oven. Place a glass

container filled with 150 ml of water on or next to the utensil. Switch on the oven at 900 W power for 1 to 2 minutes. If the utensil stays cool or just warm to the touch, it is suitable. Do not use this test on a plastic utensil. It could melt.

## **i** Tips & advice

### Before you start...

To make it as easy as possible to use the microwave oven, we have put together a few hints and tips for you. Only switch on the oven when the food is already inside.

### Setting the cooking time

Defrosting, re-heating and cooking times are generally much shorter than in a conventional oven or hob. So you will need to consult this book for the recommended cooking times. It is better to set shorter rather than longer cooking times. Always test the food after the cooking time has elapsed. It is better to then continue cooking it for a little longer, than to have overcooked food.

### Starting temperature

Defrosting, re-heating and cooking times depend on the temperature of the food when you start. For example, deep-frozen and refrigerated food will need longer than food that is at room temperature. Standard storage temperatures of food are assumed for re-heating and cooking times (refrigerator temperature of 5° C, room temperature of approximately 20° C). For defrosting food a starting temperature of approximately -18° C is assumed.

Cook **popcorn** only in special microwave safe containers. Refer exactly to the manufacturer's instructions. Do not use a normal paper or glass container.



Do not cook **eggs** in their unbroken shells. Pressure builds up inside the shell and this may result in the egg exploding. Prick the yolk before you cook it.



Do not heat **oil or fat** for deep-frying inside the microwave oven. It is impossible to control the temperature of the oil and it may suddenly splash out of the pan.

Do not heat **sealed containers** such as jars or tins. The pressure inside the container could cause the container to explode. (The exception is when you are making preserves).

### All indicated cooking times...

are guidelines only. Cooking times may vary depending on starting temperature, the weight and composition (water, fat content, etc) of the food.

### Salt, herbs and spices

Food cooked in the microwave oven retains its taste better than with conventional cooking methods. Use salt sparingly and as a rule only add salt after the food has cooked. Salt binds liquids and dries out the surface of food. Herbs and spices can be used as normal.

# **i** Tips & advice

## Testing the food

You can test whether food is cooked in the same way as conventional cookery.

- Using a food thermometer. After cooking or re-heating all foods have a certain internal temperature. You can use a food thermometer to test whether the food is hot enough, or 'done'.
- Using a fork. Test fish with a fork. If the flesh is not transparent and comes off the bone easily, it is done. If it is overcooked, it will be brittle and dry.
- Wooden skewer. Test cakes and bread by sticking in a wooden skewer. If the skewer comes out clean and dry, the food is ready.

## Working out cooking times using the food thermometer

After it has cooked, every drink or item of food has a certain internal temperature. When it is reached the cooking can be stopped, and the result will be good. You can test the internal temperature with a food thermometer. The temperature chart below gives most of the important temperatures.

### CHART: USING A FOOD THERMOMETER TO DEFINE COOKING TIMES

Drink/food items	Internal temperature at the end of cooking time	Internal temperature after 10-15 mins standing time
Heating drinks (coffee, water, tea, etc)	65-75° C	
Heating milk	75-80° C	
Heating soup	75-80° C	
Heating stews	75-80° C	
Poultry	80-85° C	85-90° C
Lamb		
Rare	70° C	70-75° C
Well roasted	75-80° C	80-85° C
Roast beef		
Rare	50-55° C	55-60° C
Medium done	60-65° C	65-70° C
Well done	75-80° C	80-85° C
Pork, veal	80-85° C	80-85° C

## Adding water

Vegetables and other foods containing a lot of water can be cooked in their own juices or by adding just a small amount of water. This will retain many vitamins and minerals in the food.

## Food with skin or peel

Pierce foods such as sausages, chickens, chicken legs, potatoes in their skins, tomatoes, egg yolk, etc with a wooden skewer. This allows the steam to escape and the food won't explode.

## Fatty foods

Food 'marbled' with fat or with layers of fat cook faster than lean meat. You should therefore cover these parts with some aluminium foil, and place the food fatty side downward.

## Blanching vegetables

Before they are frozen vegetables should be blanched. This is the best way of retaining the quality and flavour.

How to blanch vegetables:

Wash and chop the vegetable, place 250g of the vegetable in a bowl with 275ml of water, cover and heat for 3-5 minutes.

Plunge into cold water immediately after the blanching process to prevent further cooking, and then allow it to drain. Pack and freeze the vegetable in airtight containers.

## Preserving fruit & vegetables

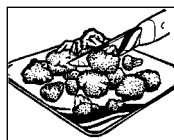

Preserving fruit and vegetables using the microwave is a quick and easy process. You can buy preserving jars, seals and preserving jar clamps specially designed for microwave use. Precise instructions are provided by the manufacturers of these items.

## Small & large quantities

Microwave cooking times depend directly upon the amount of food you want to defrost, re-heat or cook, i.e. small portions cook faster than big ones.

**The rule of thumb is:**

TWICE AS MUCH = ALMOST TWICE AS LONG

HALF AS MUCH = HALF AS LONG

# i Tips & advice

## Tall containers, flat dishes

Both types of container have the same capacity but cooking times are longer for tall containers than for flat ones. Therefore it is preferable to use dishes that

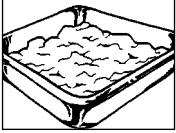

are as flat as possible, with the largest possible flat surface. Only use tall containers for foods that are likely to boil over, e.g. noodles, rice, milk etc.

## Round & oval dishes

Food cooks more evenly in round and oval dishes than in rectangular ones, because the microwave energy concentrates into the corners of rectangular dishes and the food there may get overcooked.

## Covering the food

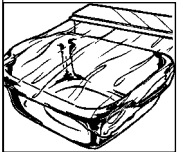

By covering the food as it cooks moisture is retained and cooking time is reduced. Use a lid, microwave film, or cover. Do not cover food that should have a crispy surface, such as roast meat or chicken. As a rule if

you would cover it in a conventional oven, cover it in the microwave. If you would cook it in a conventional oven without a cover, you can cook it without a cover in the microwave.

## Irregular shaped food

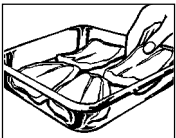

Place the thicker, more compacted end of the food pointing towards the outside. Place vegetables (such as broccoli) with the stalks pointing outward.

## Stirring

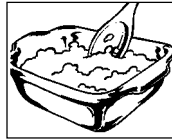

You need to stir the food because the microwaves heat the outer areas first. Stirring the food balances the temperature and the food heats evenly.

## Arranging

Arrange individual portions (pudding moulds, cups or baked potatoes) in a circle on the turntable. Leave space between the portions for the microwave energy to penetrate from all sides.

## Turning

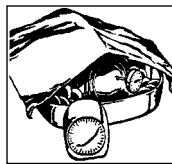

Turn medium sized portions, such as burgers and steaks, once during cooking, to reduce cooking time. Large items such as roasts and chickens must be turned because they receive more microwave

energy on the uppermost side and could dry out if not turned.

## Standing time

One of the most important rules of microwave cooking is standing time. Almost all foods that are defrosted, heated or cooked in a microwave oven require standing time. This may be fairly short or quite long. During this time the temperature is balanced and the liquids inside the food are evenly distributed.

## Browning agents

After more than 15 minutes cooking time food acquires a brownness, although this is not comparable to the deep brownness and crispness obtained through conventional cooking. In order to obtain an appetising brown colour you can use browning agents. For the most part they simultaneously act as seasoning agents. In the following table you will find some suggestions for substances you can use as browning agents and some of the uses to which you might put them.

BROWNING AGENT	DISH	METHOD
Melted butter and dried paprika	Poultry	Coat the poultry with the butter/paprika mixture
Dried paprika	Oven baked dishes - Cheese toasties	Dust with paprika
Soya sauce	Meat and poultry	Coat with the sauce
Barbecue and Worcestershire sauce, Gravy	Roasts, Rissoles, Small roasted items	Coat with the sauce
Rendered down bacon fat or dried onions	Oven baked dishes, toasted items, soups, stews	Sprinkle pieces of bacon or dried onions on top
Cocoa, chocolate flakes, brown icing, honey and marmalade	Cakes and desserts	Sprinkle pieces on top of cakes & desserts or use to glaze

# Heating

- Ready-prepared meals in aluminium containers should be removed from the aluminium container and heated on a plate or in a dish.
- Remove the lids from firmly closed containers.
- Food should be covered with microwave cling film, a plate or cover (obtainable from stores), so that the surface does not dry out. Drinks need not be covered.
- When boiling liquids such as water, coffee, tea or milk, place a glass stirrer in the container.
- If possible, stir large quantities from time to time, to ensure that the temperature is evenly distributed.
- The times are for food at a room temperature of 20° C. The heating time for food stored in a refrigerator should be increased slightly.
- After heating allow the food to stand for 1-2 minutes, so that the temperature inside the food can be evenly distributed (standing time).
- The times given are guidelines which can be varied according to the initial temperature, weight, water content, fat content or the result which you want to achieve.

# Defrosting

Your microwave is ideal for defrosting. Thawing times are usually considerably shorter than in traditional methods. Here are a few tips. Take the frozen item out of its packaging and place on a plate for defrosting.

## Boxes & containers

Boxes and containers suitable for microwaves are particularly good for defrosting and heating food, since they can withstand temperatures in a deep freeze (down to approx. -40° C) as well as being heat resistant (up to approx. 220° C). You can therefore use the same container to freeze, defrost, heat and even cook the food, without having to transfer it.

## Covering

Cover thin parts with small strips of aluminium foil before defrosting. Thawed or warm parts should likewise be covered with aluminium strips during defrosting. This stops the thin parts becoming too hot while thicker parts are still frozen.

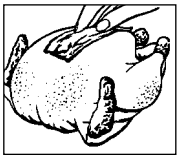

## Correct setting

It is better to choose a setting which is too low rather than one which is too high. By doing so you will ensure that the food defrosts evenly. If the microwave setting is too high, the surface of the food will already have begun to cook while the inside is still frozen.

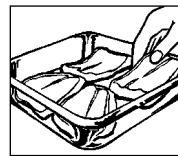

## Turning/stirring

Almost all foods have to be turned or stirred from time to time. As early as possible, separate parts which are stuck together and re-arrange them.

## Small amounts

Thaw more quickly and evenly than large ones. We recommend that you defrost portions which are as small as possible. By doing so you will be able to prepare whole menus quickly and easily.

## Foods requiring careful handling

Foods such as gateaux, cream, cheese and bread should only be partially defrosted and then left to defrost completely at room temperature. By doing so you will avoid the outer areas becoming too hot whilst the inside is still frozen.

## Standing time

This is particularly important after defrosting food, as the defrosting process continues during this period. In the defrosting table you will find the standing times for various foods. Thick, dense foods require a longer standing time than thinner foods or foods of a porous nature. If the food has not defrosted sufficiently, you may continue defrosting it in the microwave or lengthen the standing time accordingly. At the end of the standing time you should process the food as soon as possible and not re-freeze it.

# Cooking fresh vegetables

- When buying vegetables, try to ensure that, as far as possible, they are of similar size. This is particularly important when you want to cook the vegetables whole (e.g. boiled potatoes).
- Wash the vegetables before preparing them, clean them and only then weigh the required quantity for the recipe and chop them up.
- Season them as you would normally, but as a rule only add salt after cooking.
- Add about 5 tbsps of water for 500 g of vegetables. Vegetables which are high in fibre require a little more water. You will find information in the table (see page 27).
- Vegetables are usually cooked in a dish with a lid. Those with a high moisture content, e.g. onions or boiled potatoes, can be cooked in microwave cling film without adding water.
- After half the cooking time has elapsed vegetables should be stirred or turned over.
- After cooking allow the vegetables to stand for approx. 2 minutes, so that the temperature disperses evenly (standing time).
- The cooking times given are guidelines and depend upon the weight, initial temperature and condition of the type of vegetables in question. The fresher the vegetables, the shorter the cooking time.

# Cooking meat, fish & poultry

- When buying food items, try to ensure that, as far as possible, they are of similar size. This will ensure that they are cooked properly.
- Before preparation wash meat, fish and poultry thoroughly under cold running water and pat them dry with kitchen paper. Then continue as normal.
- Beef should be well hung and have little gristle.
- Even though the pieces may be of a similar size, cooking results may vary. This is due, amongst other things, to the kind of food, variations in the fat and moisture content as well as the temperature before cooking.
- After the food has been cooking for 15 minutes it acquires a natural brownness, which may be enhanced by the use of a browning agent. If, in addition, you would like the surface to be crisp you should either use the browning dish or sear the food on your cooker and finish cooking it in your microwave. By doing this you will simultaneously obtain a brown base for making a sauce.
- Turn large pieces of meat, fish or poultry half way through the cooking time, so that they are cooked evenly from all sides.
- After cooking, cover roasts with aluminium foil and allow them to stand for approx. 10 minutes (standing time). During this period the roast carries on cooking and the liquid is evenly distributed, so that when it is carved a minimum amount of juice is lost.

# Cooking & defrosting

Deep-frozen dishes can be defrosted and cooked at the same time in one process in your microwave. You will find some examples in the table. Do take note, however, of the general advice given on "heating" and "defrosting" food.

Please refer to the manufacturer's instructions on the packaging when preparing deep-frozen dishes. These usually contain precise cooking times and offer advice on preparation.

## Microwave power levels

Your oven has 5 power levels. To choose the power level for cooking, follow the advice given in the recipe section. Generally the following recommendations apply:

**900 W** used for fast cooking or reheating e.g. soup, casseroles, canned food, hot beverages, vegetables, fish, etc.

**630 W** used for longer cooking of dense foods such as roast joints, meat loaf and plated meals, also for sensitive dishes such as cheese sauce and sponge cakes. At this reduced setting, the sauce will not boil over and food will cook evenly without over cooking at the sides.

**450 W** for dense foods which require a long cooking time when cooked conventionally, eg. beef dishes, it is advisable to use this power setting to ensure the meat will be tender.

**270 W** (Defrost setting) to defrost, select this power setting, to ensure that the dish defrosts evenly. This setting is also ideal for simmering rice, pasta, dumplings and cooking egg custard.

**90 W** For gentle defrosting, eg. cream gateaux or pastry.

W = WATT

To set the microwave power level :

1. Rotate the **TIMER/WEIGHT/PORTION** knob clockwise or counter-clockwise to select cooking time.
2. Press the **MICROWAVE POWER LEVEL** button until the desired power level appears on the display. (If the **MICROWAVE POWER LEVEL** button is touched once,  will be displayed. If you miss your desired level, continue pressing the **MICROWAVE POWER LEVEL** button until you reach the level again).
3. Press the **START/QUICK** button.

# Microwave cooking

Your oven can be programmed for up to 90 minutes. (90.00) The input unit of cooking (defrosting) time varies from 10 seconds to five minutes. It depends on the total length of the cooking (defrosting) time as shown on the table.

Cooking time	Increasing unit
0-5 minutes	10 seconds
5-10 minutes	30 seconds
10-30 minutes	1 minute
30-90 minutes	5 minutes

## Example:

Suppose you want to heat soup for 2 minutes and 30 seconds on 630 W microwave power.

1. Enter desired cooking time by rotating the **TIMER/WEIGHT/PORTION** knob clockwise.
2. Choose desired power level by pressing **MICROWAVE POWER LEVEL** button twice.
3. Press **START/QUICK** button once to begin cooking.

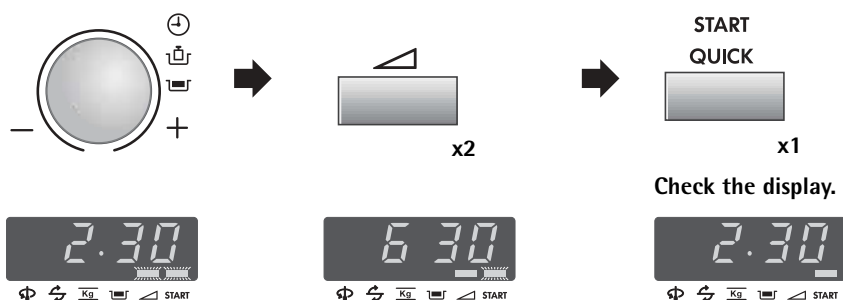

## NOTE:

1. When the door is opened during the cooking process, the cooking time on the digital display stops automatically. The cooking time starts to count down again when the door is closed and the **START/QUICK** button is pressed.
2. If you wish to know the power level during cooking, press the **MICROWAVE POWER LEVEL** button. As long as your finger is touching the **MICROWAVE POWER LEVEL** button, the power level will be displayed.
3. You can rotate the **TIMER/WEIGHT/PORTION** knob clockwise or counter-clockwise. If you rotate the knob counter-clockwise, the cooking time will decrease from 90 minutes by degrees.



# Other convenient functions

## 1. MULTIPLE SEQUENCE COOKING

A maximum of 3 sequences can be input, consisting of manual cooking time and mode.

### Example:

To cook: 5 minutes on 900 W power (Stage 1)

16 minutes on 270 W power (Stage 2)

### STAGE 1

1. Enter the desired cooking time by rotating **TIMER/WEIGHT/PORTION** knob.
2. Choose the desired power level by pressing the **MICROWAVE POWER LEVEL** button once.

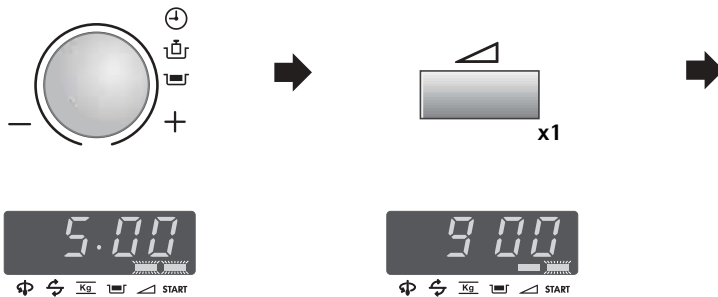

### STAGE 2

3. Enter desired time by rotating **TIMER/WEIGHT/PORTION** knob.
4. Choose the desired power level by pressing the **MICROWAVE POWER LEVEL** button four times.
5. Press the **START/QUICK** button once to begin cooking.

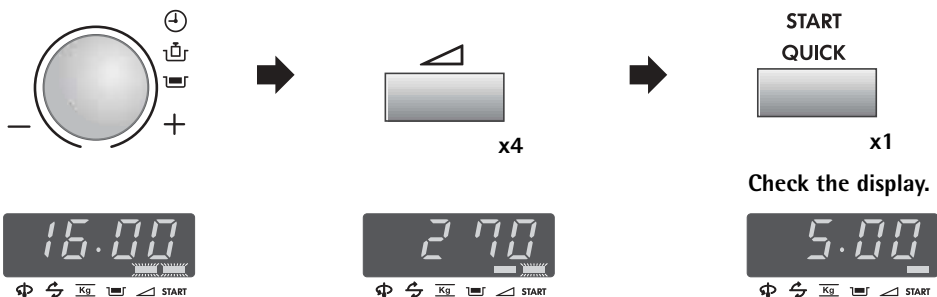

(The oven will begin to cook for 5 minutes and 900 W, and then for 16 minutes on 270 W).

# Other convenient functions

## 2. QUICK START FUNCTION

The **START/QUICK** button allows you to operate the two following functions:

### a. Direct start

You can directly start cooking on 900 W microwave power level for 30 seconds by pressing the **START/QUICK** button.



#### NOTE:

To avoid the misuse by children the **START/QUICK** button can be used only within 3 minute after preceding operation, i.e., closing the door, pressing the **STOP** button or cooking completion.

### b. Extend the cooking time

You can extend the cooking time for multiples of 30 seconds if the **START/QUICK** button is pressed while the oven is in operation.

## 3. TO CHECK THE POWER LEVEL

To check the microwave power level during cooking press the **MICROWAVE POWER LEVEL** button.

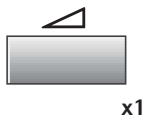

As long as your finger is touching the **MICROWAVE POWER LEVEL** button the power level will be displayed.

The oven continues to count down although the display shows the power level.

## 4. SAFETY LOCK FUNCTION

### TO SET THE SAFETY LOCK FUNCTION

1. Press and hold the **STOP** key for 3 seconds.



x1 for 3 seconds

The display will show:



### TO CANCEL THE SAFETY LOCK FUNCTION

1. Press and hold the **STOP** key for 3 seconds.



x1 for 3 seconds

The display will show the time of day, if set.

**NOTE:** When Safety Lock is set you cannot input any buttons except the **STOP** button.

# Auto cook, cook from frozen & auto defrost operation

**AUTO COOK, COOK FROM FROZEN** and **AUTO DEFROST** automatically work out the correct cooking mode and cooking time. You can choose from 4 **AUTO COOK**, 3 **COOK FROM FROZEN** and 5 **AUTO DEFROST** menus. What you need to know when using this automatic function:

**For example:**

**1a. AUTO COOK 1:** The **AUTO COOK 1** button has two menus. Press the **AUTO COOK 1** button once, the display will appear as shown.



**1b. AUTO COOK 2:** The **AUTO COOK 2** button has two menus. Press the **AUTO COOK 2** button once, the display will appear as shown.

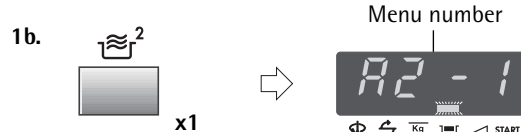

**1c. COOK FROM FROZEN:** The **COOK FROM FROZEN** button has three menus. Press the **COOK FROM FROZEN** button once, the display will appear as shown.

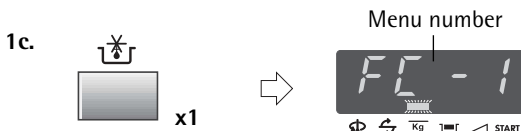

**1d. AUTO DEFROST:** The **AUTO DEFROST** button has five menus. Press the **AUTO DEFROST** button once, the display will appear as shown.

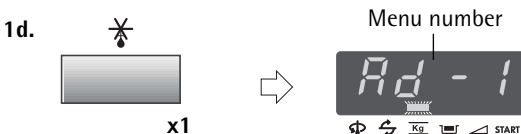

The menu can be chosen by pressing the **AUTO COOK 1, AUTO COOK 2, COOK FROM FROZEN** or **AUTO DEFROST** button until the desired menu number is displayed. See pages 18 - 20 "AUTO COOK, COOK FROM FROZEN & AUTO DEFROST charts".

The menu will be changed automatically by holding down the **AUTO COOK 1, AUTO COOK 2, COOK FROM FROZEN** or **AUTO DEFROST** button.

2. The weight or quantity of the food can be input by rotating the **TIMER/WEIGHT/PORTION** knob until the desired weight/quantity is displayed.

- Enter the weight of the food only. Do not include the weight of the container.
- For food weighing more or less than weights/quantities given in the AUTO COOK, COOK FROM FROZEN & AUTO DEFROST charts, use manual operation. For best results, follow the cooking charts on pages 24 - 26.

3. To start cooking press **START/QUICK** button.

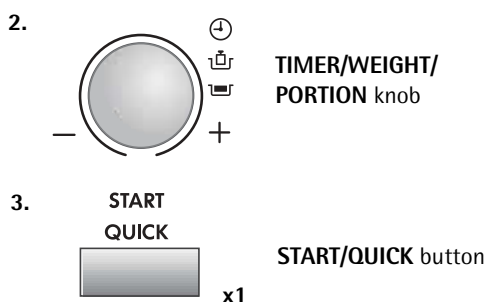

When action is required (e.g. to turn food over) the oven stops and the audible signals sound, remaining cooking time and any indicator will flash on the display. To continue cooking, press the **START/QUICK** button.

The final temperature will vary according to the initial temperature. Check food is piping hot after cooking. If necessary, you can extend the cooking manually.

**NOTE:** If you use the **QUICK START** function during the cooking/defrosting, the food may be overcooked.

# Auto cook, cook from frozen & auto defrost operation

## Example 1 for AUTO COOK 2:

To cook 1,5 kg (3 units) of Fish Fillet with Sauce using Auto Cook 2 (A2-1).

1. Select the menu required by pressing the **AUTO COOK 2** button once.
2. Enter the quantity by rotating the **TIMER/WEIGHT/PORZION** knob clockwise.
3. Press the **START/QUICK** button once.

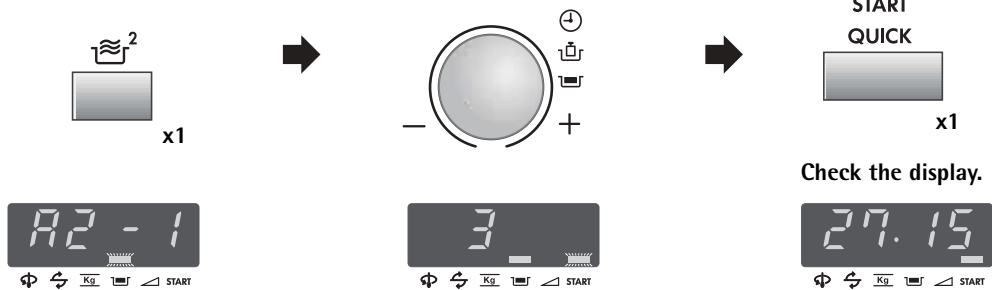

## Example 2 for COOK FROM FROZEN:









To cook Frozen Gratin 0,6 kg using Cook From Frozen (FC-3).

1. Select the menu required by pressing the **COOK FROM FROZEN** button 3 times.
2. Enter the weight by rotating the **TIMER/WEIGHT/PORZION** knob clockwise.
3. Press the **START/QUICK** button once.











# Auto cook, cook from frozen & auto defrost charts

BUTTON	AUTO COOK NO.	WEIGHT (Increasing Unit) / UTENSILS	PROCEDURE
 x1	<b>A1-1 Cook</b> Chicken Pan with Vegetables 	0,5 kg - 1,5 kg * (1 - 3) (initial temp Chicken 5° C) Gratin dish with microwave cling film	<ul style="list-style-type: none"><li>• See recipe for Chicken Pan with Vegetables on page 22.</li><li>* Total weight of all ingredients.</li></ul>
 x2	<b>A1-2 Cook</b> Mince and Onion 	0,5 kg - 1,5 kg * (1 - 3) (initial temp Mince 5° C) Casserole dish with lid	<ul style="list-style-type: none"><li>• See recipe for Mince &amp; Onion on page 22.</li><li>* Total weight of all ingredients.</li></ul>
 x1	<b>A2-1 Cook</b> Fish fillet with sauce 	0,5 kg - 1,5 kg * (1 - 3) (initial temp fish 5° C, sauce 20° C) Gratin dish & microwave cling film	<ul style="list-style-type: none"><li>• See recipe for Fish Fillet with Sauce on page 23.</li><li>* Total weight of all ingredients.</li></ul>
 x2	<b>A2-2 Cook</b> Gratin 	0,5 kg - 1,5 kg * (1 - 3) (initial temp 20° C) Gratin dish	<ul style="list-style-type: none"><li>• See recipe for Gratin on page 23.</li><li>* Total weight of all ingredients.</li></ul>

















# Auto cook, cook from frozen & auto defrost charts

BUTTON	COOK FROM FROZEN NO.	WEIGHT (Increasing Unit) / UTENSILS	PROCEDURE
 <b>x1</b>	<b>FC-1 Cook</b> Frozen Vegetables e.g. Brussel sprouts, green beans, peas, mixed vegetables, broccoli 	0,1 - 0,6 kg (100 g) (initial temp -18° C) Bowl & lid Casserole dish & microwave cling film or lid	<ul style="list-style-type: none"> <li>• Add 1tbsp water per 100 g. (For mushrooms no additional water is necessary).</li> <li>• Cover with microwave cling film or a lid.</li> <li>• When the oven stops and the audible signals sound, stir and re-cover.</li> <li>• After cooking, let stand for approx. 1-2 minutes.</li> </ul> <p><b>NOTE:</b> If frozen vegetables are compacted together, cook manually.</p>
 <b>x2</b>	<b>FC-2 Cook</b> Frozen Ready Meals Stirrable type e.g. Noodles, Bolognese, Chinese Menus. 	0,3 - 1,0 kg* (100 g) (initial temp -18° C) Casserole dish & microwave cling film or lid * If the manufacturer instructs to add water, calculate the total amount for the programme with additional liquid.	<ul style="list-style-type: none"> <li>• Transfer meal to suitable microwave-proof dish.</li> <li>• Add some liquid if recommended by the manufacturer.</li> <li>• Cover with microwave cling film or lid.</li> <li>• Cook without cover if the manufacturer instructs.</li> <li>• When the audible signal sounds, stir and re-cover.</li> <li>• After cooking, stir and let stand for approx. 1 - 2 minutes.</li> </ul>
 <b>x3</b>	<b>FC-3 Cook</b> Frozen Gratin e.g. macaroni gratin, lasagne, etc. 	0,2 - 0,6 kg (100 g) (initial temp -18° C) Shallow, oval gratin dish and microwave cling film or original container and microwave cling film	<ul style="list-style-type: none"> <li>• Remove the frozen gratin from the package. If the container is not suitable for microwave ovens, place in a gratin dish and cover with microwave cling film.</li> <li>• If the container is suitable for microwave ovens, remove original paper cover and cover with microwave cling film.</li> <li>• After cooking, let stand for approx. 5 minutes.</li> </ul>



# Auto cook, cook from frozen & auto defrost charts

BUTTON	AUTO DEFROST NO.	WEIGHT (Increasing Unit) / UTENSILS	PROCEDURE
  x1	<b>Ad-1 Defrost</b> Steak and Chops 	0,2 - 1,0 kg (100 g) (initial temp -18° C) (See note on page 22)	<ul style="list-style-type: none"> <li>Place the food on a plate in the centre of the turntable.</li> <li>When the oven stops and the audible signals sound, turn the food over, rearrange and separate. Shield thin parts and warm spots with aluminium foil.</li> <li>After defrosting, wrap in aluminium foil for 10 - 15 minutes, until thoroughly defrosted.</li> </ul>
  x2	<b>Ad-2 Defrost</b> Minced Meat 	0,2 - 1,0 kg (100 g) (initial temp -18° C) Microwave cling film (See note on page 22)	<ul style="list-style-type: none"> <li>Cover the turntable with microwave cling film.</li> <li>Place the block of minced meat onto the turntable.</li> <li>When the oven stops and the audible signals sound, turn the food over. Remove the defrosted parts if possible.</li> <li>After defrosting, stand for 5 - 10 minutes, until thoroughly defrosted.</li> </ul>
  x3	<b>Ad-3 Defrost</b> Poultry 	0,9 - 1,8 kg (100 g) (initial temp -18° C) (See note on page 22)	<ul style="list-style-type: none"> <li>Place a plate upside down on the turntable and put the poultry breast side down on the plate.</li> <li>When the oven stops and the audible signal sounds, turnover and shield thin parts and warm spots with aluminium foil.</li> <li>After defrosting, cover with aluminium foil and stand for 15 - 30 minutes until thoroughly defrosted.</li> <li>Finally clean the poultry under running water.</li> </ul>
  x4	<b>Ad-4 Defrost</b> Cake 	0,1 - 1,4 kg (100 g) (initial temp -18° C) Flat dish	<ul style="list-style-type: none"> <li>Remove all packaging from the cake.</li> <li>Place on a flat dish in the middle of the turntable.</li> <li>After defrosting, cut the cake into similar sized pieces keeping space between each piece and let stand for 15 - 60 minutes until evenly defrosted.</li> </ul>
  x5	<b>Ad-5 Defrost</b> Bread 	0,1 - 1,0 kg (100 g) (initial temp -18° C) Flat dish (Only sliced bread is recommended for this programme.)	<ul style="list-style-type: none"> <li>Distribute on a flat dish in the centre of the turntable.</li> <li>When the audible signal sounds rearrange, and remove defrosted slices.</li> <li>After defrosting separate all slices and distribute on a large plate. Cover the bread with aluminium foil and let stand for 5 - 10 minutes until thoroughly defrosted.</li> </ul>



# Auto cook, cook from frozen & auto defrost charts

**NOTE:** Auto Defrost

1. Steaks and Chops should be frozen in one layer.
2. Minced meat should be frozen in a thin shape.
3. After turning over, shield the defrosted portions with small, flat pieces of aluminium foil.
4. For Ad-1 and Ad-3 arrange the food in the oven as shown:
5. Gateaux topped and coated with cream are very sensitive to microwave energy. For the best result, if the cream begins to soften rapidly, it is best to remove it from the oven immediately and stand for 10 - 30 minutes at room temperature.

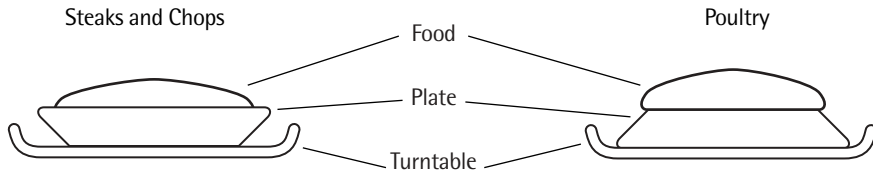

## Recipes for auto cook

### CHICKEN PAN WITH VEGETABLES (A1-1)

#### Spicy chicken fricassee

Ingredients

0,5 kg (1)	1,0 kg (2)	1,5 kg (3)	
60 g	120 g	180 g	long grain rice (parboiled)
1	1	1	sachet saffron
25 g	50 g	75 g	onion (sliced)
50 g	100 g	150 g	red pepper (in strips)
50 g	100 g	150 g	leek (in strips)
150 g	300 g	450 g	fillet of chicken breast (cubed)
			pepper, paprika powder
10 g	20 g	30 g	butter
150 ml	300 ml	450 ml	meat stock

Preparation

1. Mix the rice and saffron and place in the greased dish.
2. Mix the onions, red pepper, leek and chicken. Season and place on the rice.
3. Put butter on the top.
4. Pour the stock over and cover with microwave cling film and cook on **AUTO COOK (A1-1)**, "Chicken Pan with Vegetables".
5. After cooking, let stand for 5-10 minutes.

### MINCE AND ONION (A1-2)

Ingredients

0,5 kg (1)	1,0 kg (2)	1,5 kg (3)	
150 g	300 g	450 g	minced meat (1/2 beef, 1/2 pork)
50 g	100 g	150 g	onion (finely chopped)
1/2	1	1 1/2	egg
15 g	30 g	45 g	white breadcrumbs
			salt and pepper
115 ml	230 ml	345 ml	meat stock
20 g	40 g	60 g	tomato purée
65 g	125 g	190 g	potatoes (finely chopped)
65 g	125 g	190 g	carrots (finely chopped)
1/2 tbsp	1 tbsp	1 1/2 tbsp	chopped parsley

Preparation

1. Mix together the minced meat, onion, egg and the breadcrumbs. Season with salt and pepper. Place the meat dough into a casserole dish.
2. Mix the meat stock with the tomato purée.
3. Add the liquid, potatoes, carrots and parsley to the meat, mix it up well.
4. Cover and cook on **AUTO COOK (A1-2)**, "Mince and Onion".
5. When the oven stops and the audible signals sound, stir and re-cover.
6. After cooking, stir and stand for approx. 5 minutes. Sprinkle with parsley and serve.



# **i** Recipes for auto cook

## **FISH FILLET WITH SAUCE (A2-1)**

### **Fish fillet with piquant sauce**

#### Ingredients

0,5 kg (1)	1,0 kg (2)	1,5 kg (3)	
175 g	350 g	525 g	canned tomatoes (drained)
50 g	100 g	150 g	corn
5 g	10 g	15 g	chilli sauce
15 g	30 g	45 g	onion (finely chopped)
1 tsp	1-2 tsp	2-3 tsp	red wine vinegar
			mustard, thyme, cayenne pepper
250 g	500 g	750 g	fish fillet
			salt

#### Preparation

1. Mix ingredients for the sauce.
2. Place the fish fillet in a gratin dish with the thin ends toward the centre and sprinkle with salt.
3. Spread the sauce on the fish fillet.
4. Cover with microwave cling film and cook on **AUTO COOK (A2-1)**, "Fish Fillet with Sauce".
5. After cooking, let stand for approx. 2 minutes.

## **FISH FILLET WITH SAUCE (A2-1)**

### **Fish fillet with curry sauce**

#### Ingredients

0,5 kg (1)	1,0 kg (2)	1,5 kg (3)	
250 g	500 g	750 g	fish fillet
			salt
50 g	100 g	150 g	banana (sliced)
200 g	400 g	600 g	ready-made curry sauce

#### Preparation

1. Place the fish fillet in a gratin dish with the thin ends toward the centre and sprinkle with salt.
2. Spread the banana and the ready-made curry sauce on the fish fillet.
3. Cover with microwave cling film and cook on **AUTO COOK (A2-1)**, "Fish Fillet with Sauce".
4. After cooking, let stand for approx. 2 minutes.

## **GRATIN (A2-2)**

### **Spinach gratin**

#### Ingredients

0,5 kg (1)	1,0 kg (2)	1,5 kg (3)	
150 g	300 g	450 g	leaf spinach (defrosted, drained)
15 g	30 g	45 g	onion (finely chopped)
			salt, pepper, nutmeg
150 g	300 g	450 g	boiled potatoes (sliced)
35 g	75 g	110 g	cooked ham (diced)
50 g	100 g	150 g	crème fraîche
1	2	3	eggs
40 g	75 g	115 g	grated cheese
			paprika powder

#### Preparation

1. Mix together the leaf spinach with the onion and season with salt, pepper and nutmeg.
2. Grease the gratin dish. Place alternate layers of potato slices, diced ham and spinach in the dish. The top layer should be spinach.
3. Mix the eggs with crème fraîche, add salt and pepper and pour over the vegetables.
4. Cover the gratin with the grated cheese, sprinkle with paprika powder and cook on **AUTO COOK (A2-2)**, "Gratin".
5. After cooking, let stand for 5-10 minutes.

## **GRATIN (A2-2)**

### **Potato-courgette-gratin**

#### Ingredients

0,5 kg (1)	1,0 kg (2)	1,5 kg (3)	
200 g	400 g	600 g	boiled potatoes (sliced)
115 g	230 g	345 g	courgette (finely sliced)
75 g	150 g	225 g	crème fraîche
1	2	3	eggs
1/2	1	2	clove of garlic (crushed)
			salt, pepper
40 g	80 g	120 g	feta cheese (diced)
10 g	20 g	30 g	sunflower kernel
			paprika powder

#### Preparation

1. Grease the gratin dish and place alternate layers of potato slices and courgette in the dish.
2. Mix the eggs with crème fraîche, season with salt, pepper and garlic and pour over the vegetables.
3. Crumble the feta cheese and sprinkle over the gratin.
4. Finally sprinkle the gratin with sunflower kernel and paprika powder and cook on **AUTO COOK (A2-2)**, "Gratin".
5. After cooking, let stand for 5-10 minutes.

# Cooking charts

## ABBREVIATIONS USED

tblsp = tablespoon	g = gram	Sach. = sachet	MW = microwave
tsp = teaspoon	l = litre	DFC = dry fat content	MWO = microwave oven
l.p. = large pinch	ml = millilitre	dm = diameter	min = minutes
s.p. = small pinch	cm = centimetre	kg = kilogram	sec = seconds
Cup = cupful	DF = deep frozen		

## TABLE: HEATING FOOD AND DRINK

Food / Drink	Quantity -g/ml-	Power -Setting-	Time -Min-	Hints
Coffee, 1 cup	150	900 W	approx.1	do not cover
Milk, 1 cup	150	900 W	approx.1	do not cover
Water, 1 cup	150	900 W	approx. 2	do not cover, bring to the boil
6 cups	900	900 W	8-10	do not cover, bring to the boil
1 bowl	1000	900 W	9-11	do not cover, bring to the boil
Platters (Vegetables, meat and trimmings)	400	900 W	3-5	sprinkle some water onto the sauce, cover stir half way through the heating time
Stew	200	900 W	1 1/2 -2	cover, stir after heating
Clear soup	200	900 W	1-1 1/2	cover, stir after heating
Cream soup	200	900 W	1 1/2-2 1/2	cover, stir after heating
Vegetables	200	900 W	2-3	if necessary add some water, cover
	500	900 W	3-5	stir half way through the heating time
Garnishes	200	900 W	2-3	sprinkle with water, cover and stir from time to time
	500	900 W	4-5	
Meat, 1 slice*	200	900 W	3-4	thinly spread sauce over the top, cover
Fish fillet*	200	900 W	3-5	cover
Sausages, 2	180	630 W	1-1 1/2	pierce the skin several times
Cake, 1 piece	150	450 W	1/2-1	place on a cake stand
Baby food, 1 glass	190	450 W	1/2-1	remove the lid, after heating stir well and test the temperature
Melting butter or margarine*	50	900 W	1-1 1/2	
Melting chocolate	100	450 W	3-4	stir from time to time
Dissolving six sheets of gelatin	10	450 W	approx. 1/2	dip into water, squeeze thoroughly and place in a soup bowl, stir from time to time
Glazing for a tart of 1/4 l of liquid	10	450 W	3-5	mix the sugar in 250ml of liquid, cover, stir well during and after heating

\* Refrigerator temperature

## TABLE: COOKING MEAT, FISH AND POULTRY

Fish and Poultry	Quantity -g-	Power -Setting-	Time -Min-	Hints	Standing time -Min-
Roasts	500	630 W	17-22	season to taste, place in a shallow flan dish	10
(pork,	1000	630 W	34-38	turn over halfway through cooking time	10
veal, lamb)	1500	630 W	53-58		10
Roast beef (medium)	1000	630 W	20-24	season to taste, place in a quiche dish,	10
	1500	630 W	27-31	turn over halfway through cooking time	10
Minced meat	1000	900 W	21-24	prepare the minced meat mixture (half pork / half beef) place in a shallow casserole dish	10
Fish fillet	200	900 W	4-6	season to taste, place on a plate, cover	3
Chicken	1200	630 W	29-32	season to taste, place in a casserole dish, turn halfway through cooking time	3
Chicken legs	200	900 W	3-6	season to taste, place on a plate, cover	3

# Cooking charts

**TABLE: DEFROSTING**

Food	Quantity -g-	Power -Setting-	Time -Min-	Hints	Standing time -Min-
Roast	1500	90 W	55-60	Place on an upturned plate,	30 - 90
(pork, beef,	1000	90 W	38-42	turn halfway through	30 - 90
veal, lamb)	500	90 W	20-25		30 - 90
Steaks, escalopes,	200	270 W	2-4	Turn halfway through	10 - 15
chops, liver					
Goulash	500	270 W	8-9	Break up and stir halfway through	10 - 15
Ham or large sausage	200	270 W	2-3	Defrost slightly only	5
as one piece					
Cold cuts	200	270 W	2-4	Each minute, take off the outside slices	5
Sausages 8	600	270 W	6-8	Place alongside one another,	5 - 10
4	300	270 W	3-5	turn halfway through	5 - 10
Duck/turkey	1500	90 W	42-46	Place on an upturned plate, turn halfway through	30 - 90
Chicken	1200	270 W	18-20	Place on an upturned plate, turn halfway through	30 - 90
	1000	270 W	13-15		30 - 90
Chicken legs	1000	270 W	13-15	Turn halfway through	30 - 90
	200	270 W	3-4		10 - 15
Chicken breast	450	270 W	7-9	Turn halfway through	30 - 90
Fish in portions	800	270 W	12-13	Turn halfway through	10 - 15
Fish fillet	400	270 W	5-7	Turn halfway through	5 - 10
Crab	300	270 W	6-8	Turn halfway through, take away defrosted parts	30
Rolls, 2	80	270 W	1-1½	Defrost only	-
Sliced bread (for	250	270 W	2-3	Place alongside one another, defrost only	5
toasting) in slices					
White loaf, whole	500	270 W	3-5	Turn halfway through (ice particles remain)	30
Whole wheat loaf, sliced	250	270 W	2-3	Place slices alongside one another, defrost only	5
Bread made from	1000	270 W	8-10	Turn halfway through (ice particles remain)	30
wheat and rye flour					
Cakes, 1 piece	150	270 W	1-3	Place on a cake tray	5
Fruit flan, 1 piece	150	270 W	2-3	Place on a cake tray	10
Gateaux, 1 piece		270 W	Approx.1	Place on a cake tray	5
Whole Gateaux (25 cm Ø)	270 W	9-11		Place on a cake tray	60
Butter	250	270 W	1-3	Defrost only	5
Cream	200	270 W	2+2	Remove lid, after 2 minutes pour into a bowl and	5 - 10
				continue to defrost	
Cheese slices	200	270 W	1-2	Defrost only	10
Soft fruit: Strawberries	250	270 W	3-5	Position evenly next to each other, turn halfway through	5
Raspberries, Cherries, Plums					

Times given in this chart are guidelines only and may vary according to the starting temperature of the frozen food, its composition, and its weight.

**TABLE: DEFROSTING AND COOKING**

Food	Quantity -g-	Power -Setting-	Time -Min-	Added water -tbsps-	Hints	Standing time -Min-
Fish fillet	300	900 W	9-11	-	cover	1-2
Trout, 1 fish	250	900 W	6-8	-	cover	1-2
Platter	400	900 W	8-10	-	cover, stir after 6 minutes	2
Leaf spinach	300	900 W	7-10	-	cover, stir once or twice during cooking	2
Broccoli	300	900 W	6-8	3-5	cover, stir halfway through cooking time	2
Peas	300	900 W	6-8	3-5	cover, stir halfway through cooking time	2
Kohlrabi	300	900 W	7-8	3-5	cover, stir halfway through cooking time	2
Mixed vegetables	500	900 W	9-11	3-5	cover, stir halfway through cooking time	2
Brussels sprouts	300	900 W	6-8	3-5	cover, stir halfway through cooking time	2
Red cabbage	450	900 W	10-12	3-5	cover, stir halfway through cooking time	2

# Cooking charts

**TABLE: COOKING FRESH VEGETABLES**

Vegetable	Quantity -g-	Power -Setting-	Time -Min-	Hints	Added Water -tbsps/ml-
Artichokes	300	900 W	5-7	remove the stalk, cover	3-4 tbsp
Leaf Spinach	300	900 W	4-5	wash, dry well, cover, stir once or twice during cooking	-
Cauliflower	800	900 W	10-12	1 whole head, cover, divide into florets	5-6 tbsp
	500	900 W	6-8	stir during cooking	4-5 tbsp
Broccoli	500	900 W	6-8	divide into florets, cover, stir occasionally during cooking	4-5 tbsp
Mushrooms	500	900 W	6-8	whole heads, cover, stir occasionally during cooking	-
Chinese leaves	300	900 W	5-7	cut into strips, cover, stir occasionally during cooking	4-5 tbsp
Peas	500	900 W	6-8	cover, stir occasionally during cooking	4-5 tbsp
Fennel	500	900 W	6-8	cut into quarters, cover, stir occasionally during cooking	4-5 tbsp
Onions	250	900 W	4-5	whole, cook in microwave cling film	-
Kohlrabi	500	900 W	7-9	dice, cover, stir occasionally during cooking	50 ml
Carrots	500	900 W	7-9	cut into rings, cover, stir occasionally during cooking	4-5 tbsp
Green peppers	500	900 W	6-8	cut into strips, stir once or twice during cooking	4-5 tbsp
Jacket potatoes	500	900 W	6-8	cover, stir occasionally during cooking	4-5 tbsp
Leeks	500	900 W	7-9	cut into rings, cover, stir occasionally during cooking	4-5 tbsp
Red cabbage	500	900 W	15-17	cut into strips, stir once or twice during cooking	50 ml
Brussels sprouts	500	900 W	7-9	whole sprouts, cover, stir occasionally during cooking	50 ml
Boiled potatoes (salted)	500	900 W	7-9	cut into large pieces of a similar size, add a little salt, cover, stir occasionally during cooking	150 ml
Celery	500	900 W	7-9	dice finely, cover, stir occasionally during cooking	50 ml
White cabbage	500	900 W	15-17	cut into strips, cover, stir occasionally during cooking	50 ml
Courgettes	500	900 W	6-8	slice, cover, stir occasionally during cooking	4-5 tbsp

## Recipes

### ADAPTING RECIPES FOR THE MICROWAVE OVEN

If you would like to adapt your favourite recipes for the microwave, you should take note of the following: Shorten cooking times by a third to a half. Follow the example of the recipes in this book.

Foods which have a high moisture content such as meat, fish, poultry, vegetables, fruit, stews and soups can be prepared in your microwave without any difficulty. Foods which have little moisture, such as platters of food, should have the surface moistened prior to heating or cooking.

The amount of liquid to be added to raw foods, which are to be braised, should be reduced to about two thirds of the quantity in the original recipe. If necessary, add more liquid during cooking.

The amount of fat to be added can be reduced considerably. A small amount of butter, margarine or oil is sufficient to flavour food. For this reason your microwave is excellent for preparing low-fat foods as part of a diet.

### HOW TO USE THE RECIPES

- All the recipes in this book are calculated on the basis of 4 servings - unless otherwise stated.
- Recommendations relating to suitable utensils and the total cooking times are given at the beginning of every recipe.
- As a rule the quantities shown are assumed to be wholly consumable, unless specifically indicated otherwise.
- When eggs are given in the recipes they are assumed to have a weight of approx. 55 g (grade M).

# Soups

Spain

## Avocado soup

Total cooking time: approx. 11-13 minutes

Utensils: Dish with lid (2 l capacity)

Ingredients

3 avocados (600 g of flesh)  
lemon juice  
700 ml meat stock  
70 ml cream  
salt & pepper

1. Peel the soft, ripe avocados, remove the stones, cut the flesh into pieces and purée. Save two thin slices to decorate each portion and sprinkle with lemon juice.
2. Put the meat stock, avocados and cream into a dish, season with salt and pepper and cook with the lid on. Stir occasionally.  
**11-13 min. ◀ 900 W**
3. Stir the soup until it is creamy and decorate with the saved avocado slices. After cooking allow the soup to stand for approx. 5 minutes.

Sweden

## Crab soup

Total cooking time: approx. 11-15 minutes

Utensils: Bowl with lid (2 l capacity)

Ingredients

1 onion (50 g), chopped finely  
50 g sliced carrots  
3 tbsp butter or margarine (30 g)  
500 ml meat stock  
100 ml white wine  
100 ml madeira wine  
200 g tinned crab meat  
1/2 bay leaf  
3 white peppercorns  
thyme  
3 tbsp flour (30 g)  
100 ml cream

1. Place the vegetables into the bowl with the fat (2 tbsp), cover, and heat.  
**2-3 min. ◀ 900 W**
2. Add the meat stock, the wine, crabmeat, and seasoning to the vegetables. Cover and cook.  
**7-9 min. ◀ 450 W**
3. Take out the pepper corns and the bay leaf. Mix the flour with a little cold water and stir into the soup. Add the cream, stir well, and heat.  
**2-3 min. ◀ 900 W**
4. Stir the soup and allow to stand for about 5 minutes. Add the butter (1 tbsp) just before serving.

Switzerland

## Barley soup

Total cooking time approx. 27-34 minutes

Utensils: Bowl with lid (3 l capacity)

Ingredients

2 tbsp butter or margarine (20 g)  
1 onion (50 g), finely chopped  
1-2 carrots (130 g) sliced  
15 g celery, roughly chopped  
1 leek (130 g), cut into rings  
3 white cabbage leaves (100 g), in strips  
200 g veal bones  
50 g streaky bacon, cut into strips  
50 g barley corn  
700 ml meat stock  
pepper  
4 frankfurters (300 g)

1. Place the butter and chopped onion into the bowl, cover and braise.  
**approx. 1-2 min. ◀ 900 W**
2. Add the vegetables to the bowl. Add the bones, the streaky bacon and the barley, and fill the bowl with the meat stock. Season with pepper, cover and cook.  
**1. 9-11 min. ◀ 900 W**  
**2. 17-21 min. ◀ 450 W**
3. Chop the frankfurters into small pieces and heat with the rest of the soup for the last five minutes.
4. Allow to stand for about 5 minutes after it has cooked. Take the bones out just before you serve the soup.

# Meat, fish & poultry

Austria

## Roast chicken with stuffing

2 Portions

Total cooking time: approx. 36-40 minutes

Utensils: Bowl (2 l capacity)

Kitchen twine

Ingredients

- 1 chicken (1000 g)
- salt
- rubbed rosemary
- rubbed marjoram
- 1 stale bread roll (white bread, 40 g)
- 1 bunch of parsley, chopped finely (10 g)
- pinch nutmeg
- 2 tbsps butter or margarine (20 g)
- 1 yolk of egg
- 3 tbsps butter or margarine (30g)
- 1 tbsp paprika pepper
- 1 tbsp butter or margarine to grease the dish

Italy

## Quails in cheese and herb sauce

Total cooking time: approx. 27-33 minutes

Utensils: Kitchen twine or thick thread

Flat round dish (diameter approx. 22 cm)

Bowl with lid (1 l capacity)

Ingredients

- 4 quails (600 g)
- salt & pepper
- 200 g streaky bacon, sliced thinly
- 1 tsp butter or margarine to grease the dish
- 1 tsp fresh parsley for each quail
- sage
- rosemary
- basil, chopped finely
- 150 ml port
- 250 ml meat stock
- 2 tbsps butter or margarine (20 g)
- 2 tbsps flour (20 g)
- 50 g grated Emmental cheese

1. Wash the chicken, dab dry with kitchen towel and season with salt, rosemary and marjoram.
2. To make the stuffing, soak the roll for about 10 minutes in cold water, then press the water out. Mix in the salt, parsley, nutmeg butter and egg yolk and stuff the chicken with the mixture. Tie up the opening with ties or butcher's twine.
3. Heat the butter (30 g).  
**approx. 1 min. ◁ 900 W**  
Stir the paprika pepper and the salt into the butter, and drizzle the mixture over the chicken.
4. Place the chicken in the greased bowl and cook without lid. Turn halfway through.  
**35-39 min. ◁ 630 W**  
Allow the chicken to stand for about 3 minutes after cooking.

1. Wash the quails and carefully dab them dry. Season with salt and pepper inside and out, wrap bacon around each bird, and tie up tightly with the twine.
2. Grease the dish, place the quails in the dish and cook. Turn over once halfway through.  
**10-12 min. ◁ 900 W**
3. Chop the herbs very fine, sprinkle over the quails, and pour the port over the top. Continue to cook the quails.  
**13-15 min. ◁ 630 W**  
Take the quails out of the roasting sauce.
4. To make the sauce, heat the meat stock in the covered bowl.  
**2-3 min. ◁ 900 W**  
Blend the butter with the flour, stir into the liquid, allow to boil, and cook. Stir once halfway through.  
**1-2 min. ◁ 900 W**
5. Stir the cheese into the sauce. Add the cheese sauce to the sauce, stir everything together well, and reheat.  
**approx. 1 min. ◁ 900 W**
6. Pour the sauce over the quails and serve.

# Meat, fish & poultry

Holland

## Mince and onions

Total cooking time: approx. 20-23 minutes

Utensils: Bowl with cover (2 l capacity)

Ingredients

500 g minced meat (half pork, half beef)  
3 onions (150 g), finely chopped  
1 egg  
50 g white breadcrumbs  
salt & pepper  
350 ml meat stock  
70 g tomato purée  
2 potatoes (200 g), diced  
2 carrots (200 g), diced  
2 tbsps chopped parsley

1. Mix together the minced meat, the chopped onion, the egg and the breadcrumbs to form a dough, knead, and season with salt and pepper. Place the meat dough into the bowl.
2. Mix the meat stock with the tomato purée.
3. Place the potatoes and carrots, with the liquid over the minced meat, mix it up well, cover and cook. Stir once halfway through.

**20-23 min. ◀ 900 W**

Stir the mince once again, and allow it to stand for about 5 minutes. Sprinkle with parsley and serve.

Germany

## Spicy turkey fricassee

2 servings

Total cooking time: approx. 20-25 minutes

Utensils: Flat, oval dish with a lid (about 26 cm long)

Ingredients

1 cup of long grain rice, parboiled (120 g)  
1 pack saffron (containing the whole stigma)  
1 tsp butter or margarine to grease the dish  
1 onion (50 g), sliced  
1 red pepper (100 g), cut into strips  
1 small leek (100 g), cut into strips  
300 g turkey breast, diced  
pepper  
paprika pepper  
2 tbsps butter or margarine (20 g)  
2 cups meat stock (300 ml)

1. Mix the rice with the saffron stigma and place in the greased dish. Mix in the onion slices, strips of pepper and leek and the diced turkey breast and season. Stack them on top of the rice. Dot with butter.
2. Pour the stock over the dish, cover and cook.

**1. 4-6 min. ◀ 900 W**

**2. 16-19 min. ◀ 270 W**

Allow the turkey fricassee to stand for about 5 minutes after cooking.

Switzerland

## Zürich veal in cream

Total cooking time: approx. 9-14 minutes

Utensils: Dish with lid (2 l capacity)

Ingredients

600 g veal fillet  
1 tbsp butter or margarine  
1 onion (50 g), finely chopped  
100 ml white wine  
seasoned gravy browning, for approx.  
1/2 l gravy  
300 ml cream  
1 tbsp parsley, chopped

1. Cut the fillet into finger-width strips.
2. Grease the dish all over with the butter. Put the onion and the meat into the dish, cover and cook. Stir once during cooking.

**6-9 min. ◀ 900 W**

3. Add the white wine, gravy browning and cream, stir, cover and continue cooking. Stir occasionally.
4. Test the veal, stir the mixture once more and allow to stand for approx. 5 minutes. Serve garnished with parsley.

**3-5 min. ◀ 900 W**

# Meat, fish & poultry

Spain

## Stuffed ham

Total cooking time: approx. 16-20 minutes

Utensils: Bowl with lid (2 l capacity)

Flat oval soufflé dish (about 32 cm long)

Ingredients

- 150 g leaf spinach, with stalks removed
- 150 g fromage frais, 20 % fat content
- 50 g grated Emmental cheese
- pepper
- paprika
- 8 slices of cooked ham (400 g)
- 125 ml water
- 125 ml cream
- 2 tbsps flour (20 g)
- 2 tbsps butter or margarine (20 g)
- 1 tsp butter or margarine to grease the dish

Tip: You can buy ready-made béchamel sauce and use it for this recipe

1. Chop the spinach into small pieces, mix with the cheese and the fromage frais and season to taste.
2. Place a tablespoon of the filling on top of each slice of cooked ham, and roll up. Spear the ham with a wooden skewer to fasten it.
3. Make a béchamel sauce; to do this pour the liquid into the bowl, cover, and heat.  
**3-4 min. ◀ 900 W**  
Mix the flour and butter to make a roux, add to the liquid, and whisk with an egg whisk until dissolved. Cover, bring to the boil, and allow the thicken.  
**1-2 min. ◀ 900 W**  
Stir and taste.
4. Place the sauce into the greased dish, position the filled rolls of ham onto the sauce and cook with lid.  
**12-14 min. ◀ 630 W**  
Allow the rolls of ham to stand for about 5 minutes after cooking.

Greece

## Aubergines with mince stuffing

Total cooking time: approx. 20-24 minutes

Utensils: Bowl with lid (1 l capacity)

Flat oval soufflé dish with lid  
(about 30 cm long)

Ingredients

- 2 aubergines, with stalks removed  
(weighing about 250 g each)
- salt
- 3 tomatoes (approx. 200 g)
- 1 tsp olive oil to grease the bowl
- 2 onions (100 g), chopped
- 4 mild green chilli peppers
- 200 g minced meat (beef or lamb)
- 2 cloves of garlic, crushed
- 2 tbsps smooth leafed parsley, chopped
- salt & pepper
- rose paprika (light paprika)
- 60 g Feta cheese, diced

Tip: You can use courgettes instead of aubergines.

1. Cut the aubergines in half lengthways. Remove the flesh inside with a teaspoon, leaving about 1 cm of flesh on the skin. Salt the aubergines. Dice the flesh.
2. Skin two tomatoes, cut away the stem area and dice the rest.
3. Grease the bowl with the olive oil, add the onions, cover, and braise.  
**2-3 min. ◀ 900 W**
4. Cut out the stalks of the sweet chilli peppers, remove the seeds, and cut into rings. Keep a third of these for garnish. Mix the minced meat with the aubergines, onions and tomatoes, the chilli rings, the crushed garlic clove and the parsley, and season.
5. Dab the hollowed out aubergine halves dry. Fill each half with the minced meat mixture, spread out the Feta cheese on top, and then put the rest of the mixture on top.
6. Garnish the aubergine halves with the slices of tomato and chilli rings, place into the greased dish, cover and cook.  
**18-21 min. ◀ 630 W**  
Allow the aubergines to stand for about 2 minutes after cooking.



# Meat, fish & poultry

France

## Sole fillets

Total cooking time: approx. 11-13 minutes

Utensils: Shallow, oval oven dish with lid  
(approx. 26 cm long)

### Ingredients

400 g sole fillets  
1 lemon, whole  
2 tomatoes (150 g)  
1 tsp butter or margarine for greasing  
1 tbsp vegetable oil  
1 tbsp parsley, chopped  
salt & pepper  
4 tbsps white wine (30 ml)  
2 tbsps butter or margarine (20 g)

1. Wash the sole fillets and pat them dry. Remove any bones.
2. Cut the lemon and the tomatoes into thin slices.
3. Grease the oven dish with butter. Place the fish fillets inside and drizzle the vegetable oil over them.
4. Sprinkle parsley over the fish, place the tomato slices on top and season. Place the lemon slices on top of the tomatoes and pour the white wine over them.
5. Place small pots of butter on top of the lemon, cover and cook.  
**11-13 min.** ◀ **630 W**  
After cooking allow the fish fillets to stand for approx. 2 minutes.

Tip: This recipe can also be used for Haddock, Halibut, Mullet, Plaice or Cod.

# Vegetables, noodles, rice & dumplings

Austria

## Spinach gratin

Total cooking time: approx. 37-42 minutes

Utensils: Bowl with lid (capacity 2 l)  
Flat, oval dish (length: approx 26 cm)

### Ingredients

2 tbsps butter or margarine (20 g)  
1 onion (50 g), finely chopped  
600 g leaf spinach, deep-frozen  
salt & pepper  
nutmeg  
garlic powder  
1 tsp butter or margarine (for greasing the pan)  
500 g boiled potatoes, sliced  
200 g cooked ham, diced  
4 eggs  
125 ml crème fraîche  
100 g grated cheese (e.g. Gouda)  
paprika pepper to sprinkle over the top

1. Spread the butter on the bottom of the dish. Add chopped onion, cover and cook.  
**2-3 min.** ◀ **900 W**
2. Add spinach, cover and cook. Stir once or twice halfway through.  
**12-14 min.** ◀ **900 W**  
Pour off liquid and add seasoning to spinach.
3. Grease the dish. Place alternate layers of potato slices, diced ham and spinach in the dish. The top layer should be spinach.
4. Mix the eggs with the cream, add salt and pepper and pour over the vegetables. Cover the casserole with the grated cheese and sprinkle with ground paprika.  
**23-25 min.** ◀ **630 W**  
Allow the dish to stand for approx. 10 minutes after cooking.

Tip: Ingredients can be varied as desired (using broccoli, salami, noodles, for example).

# Vegetables, noodles, rice & dumplings

Switzerland

## Kohlrabi in dillsauce

Total cooking time: approx. 10<sup>1</sup>/<sub>2</sub>-13<sup>1</sup>/<sub>2</sub> minutes

2 servings

Utensils: 2 Bowls with lids (capacity 1 l)

Ingredients

400 g kohlrabi, sliced (approx. 2)

4-5 tbsps water

2 tbsps butter or margarine (20 g)

150 ml crème fraîche

salt & pepper

nutmeg & ground paprika

lemon juice

1 bunch dill, finely chopped

1. Place the kohlrabi and water in the dish, cover and cook. Stir once halfway through.

**9-12 min.**  **900 W**

Pour off the liquid

2. Spread the butter in the bowl. Add the cream and heat uncovered. Do not allow to boil!

**approx. 1<sup>1</sup>/<sub>2</sub> min.**  **900 W**

3. Add salt, seasonings and lemon juice as desired. Fold in the dill and pour the sauce over the kohlrabi. Allow the kohlrabi to stand for approx. 2 minutes after cooking.

Tip: Black salsify can be used instead of kohlrabi.

Italy

## Tagliatelle with cream and basil sauce

makes 2 servings

Total cooking time: approx. 16-22 minutes

Utensils: Bowl with lid (2 l capacity)

Round soufflé dish (approx. 20 cm diameter)

Ingredients

1 l water

1 tsp salt

200 g tagliatelle

1 clove of garlic

15-20 basil leaves

200 g crème fraîche

30 g grated Parmesan cheese

salt & pepper

1. Place the water and the salt into the bowl, cover and bring to the boil.

**9-11 min.**  **900 W**

2. Add the pasta, bring to the boil again, and then simmer.

**1. 1-2 min.**  **900 W**

**2. 6-9 min.**  **270 W**

3. Meanwhile rub the garlic cloves over the soufflé dish. Chop the basil leaves. Keep some aside for garnishing.

4. Drain the pasta well. Stir in the crème fraîche and sprinkle the basil over the pasta.

5. Add the parmesan cheese, salt and pepper, place into a soufflé dish and stir. Garnish the dish with basil and serve hot.

Switzerland

## Tessiner Risotto

Total cooking time: approx. 20-25 minutes

Utensils: Bowl with a lid (2 l capacity)

Ingredients

50 g streaky bacon

2 tbsps butter or margarine (20 g)

1 onion (50 g), finely chopped

200 g pudding rice (Arboris)

400 ml meat stock

70 g Sbrinz cheese (if you are unable to obtain this type of Swiss cheese, use Emmental instead)

pinch saffron

salt & pepper

1. Cut the bacon into cubes. Spread the butter over the base of the bowl. Place the onions and bacon cubes, cover, and braise.

**2-3 min.**  **900 W**

2. Add the rice, fill with the meat stock, bring to the boil, and then simmer.

**1. 3-5 min.**  **900 W**

**2. 15-17 min.**  **270 W**

Allow the rice to stand for about 3-5 minutes after cooking.

3. Mix the cheese with the saffron and season to taste.

Tip: Braised chanterelle mushrooms, or button mushrooms and a mixed salad go very well with this dish.

# Vegetables, noodles, rice & dumplings

Italy

## Lasagne al forno

Total cooking time: approx. 18-25 minutes

Utensils: Bowl with lid (2 l capacity)

Shallow square soufflé mould with lid  
(approx. 20 x 20 x 6 cm)

Ingredients

300 g tinned tomatoes  
50 g ham, finely cubed  
1 onion (50 g), finely chopped  
1 clove of garlic, crushed  
250 g minced meat (beef)  
2 tbsps mashed tomato (30 g)  
salt & pepper  
oregano, thyme, basil, nutmeg  
150 ml cream (crème fraîche)  
100 ml milk  
50 g grated Parmesan cheese  
1 tsp mixed chopped herbs  
1 tsp olive oil  
1 tsp vegetable oil to grease the mould  
125 g lasagne verde  
1 tbsp grated Parmesan cheese  
1 tbsp butter or margarine

1. Cut the tomatoes into slices, mix with the ham, onion cubes, garlic, minced meat and mashed tomato. Season and cook with the lid on.

**5-8 min.** ◀ **900 W**

2. Mix the cream with the milk, Parmesan cheese, herbs, oil and spices.
3. Grease the soufflé mould and cover the bottom of the mould with about  $\frac{1}{3}$  of the pasta. Put half of the minced meat mixture on the pasta and pour on some sauce. Put an additional  $\frac{1}{3}$  of the pasta on top followed by another layer of the minced meat mixture and some sauce, finishing with the remaining pasta on top. Finally, cover the pasta with lots of sauce and sprinkle with Parmesan cheese. Place butter flakes on top and cook with the lid on.

**13-17 min.** ◀ **630 W**

After cooking, let the lasagne stand for approximately 5-10 minutes.

Greece

## Potato-garlic paté

Total cooking time: approx. 8-10 minutes

Utensils: Bowl with lid (capacity 1 l)

Ingredients

400 g boiled potatoes (with skins)  
2-3 tbsp water  
2-3 garlic cloves  
6 tbsps olive oil  
6 tbsps meat stock  
salt  
juice of one lemon  
1 mild chilli pepper

1. Place the potatoes and water in the dish. Cover and cook. Stir once halfway through.
- 8-10 min.** ◀ **900 W**
2. Peel the potatoes and press through a potato press or a fine sieve.
  3. Crush the garlic cloves with the garlic press and add to the potatoes.
  4. Add olive oil, meat stock, salt and lemon juice with the potatoes to taste, and stir until a smooth mixture is formed. Add more oil or stock as required.
  5. Decorate the paté with chilli pepper rings and serve.

# Vegetables, noodles, rice & dumplings

Austria

## Bread dumplings

Total cooking time: approx. 8-11 minutes

Utensils: Bowl with lid (2 l capacity)

5 cups or ramekins

Ingredients

2 tbsps butter or margarine (20 g)  
1 onion (50 g), chopped finely  
approx. 500 ml milk  
200 g cubes of dry bread (from about 5 bread rolls)  
3 eggs

1. Put the bread cubes in a bowl and pour the milk over it.
2. Spread the fat over the base of the bowl, add the diced onions, cover and heat.  
**1-2 min. ◀ 900 W**
3. Add the onions to the bread cubes. Beat the eggs, add and stir everything well to form a smooth dough. If necessary add more milk.
4. Distribute the dough equally into the 5 cups or ramekins, cover with microwave film, arrange around the edge of the turntable plate, and cook.

**7-9 min. ◀ 900 W**

Allow the dumplings to stand for about 2 minutes after cooking. Turn them out onto a plate before serving.

# Drinks, desserts & cakes

Germany

## Semolina pudding with raspberry sauce

Total cooking time: approx. 15-20 minutes

Utensils: Bowl with lid (2 l capacity)

Ingredients

500 ml milk  
40 g sugar  
15 g chopped almonds  
50 g semolina  
1 egg yolk  
1 tbsp water  
1 egg white  
250 g raspberries  
50 ml water  
40 g sugar

1. Place the milk, sugar and almonds in the bowl, cover and heat.  
**3-5 min. ◀ 900 W**
2. Add the semolina, stir, cover and cook.  
**10-12 min. ◀ 270 W**
3. Beat the egg yolk with the water in a cup, and stir into the hot mixture. Beat the egg white until it is stiff, and fold it into the mixture. Pour the pudding mixture into ramekins or small dishes.
4. To make the sauce wash the raspberries, dab them dry carefully, and place them in a bowl with the water and sugar. Cover, and heat.  
**2-3 min. ◀ 900 W**
5. Purée the raspberries and serve either hot or cold with the semolina pudding.

Germany

## Hot lemonade

Total cooking time: 1 minute

Utensils: Glass for lemon tea (150 ml)

Ingredients

100 ml water  
juice of one lemon  
2-3 tsp sugar

1. Mix water and lemon juice in a glass and heat.  
**approx. 1 min. ◀ 900 W**  
Add sugar to taste.

# Drinks, desserts & cakes

Netherlands

## Hot punch

For 10 servings

Ingredients

500 ml white wine  
500 ml dry red wine  
500 ml rum, 54 % vol  
1 unwaxed orange  
3 sticks of cinnamon  
75 g sugar  
10 tsp klontjes (crystallised sugar lumps)

1. Pour the alcoholic ingredients into the bowl. Thinly pare the skin of the orange, and add the orange peel, together with the cinnamon and the sugar, to the alcohol. Cover and heat.

**8-10 min.** ⚡ **900 W**

Remove the orange peel and the cinnamon. Place a teaspoon of the klontjes (crystallised sugar lumps) into 10 punch glasses, pour in the punch, and serve.

England

## Chocolate cake

Total cooking time: 15-21 minutes

Utensils: Round cake dish (diam. 21 cm, height 10 cm)

Ingredients

175 g butter or margarine  
175 g sugar  
3 eggs  
175 g flour  
1 tsp baking powder  
2 tbsps cocoa (20 g)  
50 ml milk

1. Beat the butter until frothy and slowly mix in the sugar. Add the eggs gradually, mixing well. Mix together the flour, baking powder and cocoa. Add milk and mix thoroughly.

2. Grease the pan. pour in dough and cook.

**8-10 min.** ⚡ **630 W**

3. Use a wooden skewer to check that the cake is done. Allow the cake to cool for 10 minutes in the dish.

Austria

## Chocolate with whipped cream

1 portion

Total cooking time: about 1 minute

Utensils: Large cup or mug (capacity 200 ml)

Ingredients

150 ml milk  
30 g bar of chocolate grated  
30 ml cream  
chocolate vermicelli

1. Pour the milk into the cup or mug. Add the grated chocolate to the milk, stir and heat. Stir halfway through.

**approx. 1 min.** ⚡ **900 W**

2. Whip the cream until it is stiff, place on top of the chocolate, sprinkle with chocolate vermicelli and serve.

# Drinks, desserts & cakes

France

## Pears in chocolate sauce

Total cooking time: approx. 8-13 minutes

Utensils: Bowl with lid (2 l capacity)

Bowl with lid (1 l capacity)

Ingredients

4 pears (600 g)  
60 g sugar  
1 pack vanilla sugar (10 g)  
1 tbsps pear liqueur, 30 % vol  
150 ml water  
130 g dark chocolate  
100 g crème fraîche

1. Peel the pears whole.
2. Place the sugar, vanilla sugar, the pear liqueur and the water into the bowl, stir, cover and heat.  
**1-2 min. ◀ 900 W**
3. Place the pears into the liquid, cover and cook.  
**5-8 min. ◀ 900 W**  
Take the pears out of the cooking liqueur, and place in a cold place.
4. Pour 50 ml of the cooking liqueur into the smaller bowl. Add the chopped chocolate and the crème fraîche, cover, and heat.  
**2-3 min. ◀ 900 W**
5. Stir the sauce well. Pour the sauce over the pears, and serve.

Tip: Delicious when served with a ball of vanilla ice cream.

Sweden

## Pistachio rice pudding with strawberries

Total cooking time: approx. 27-31 minutes.

Utensils: Tall bowl with a lid (2 l capacity)

Ingredients

125 g long grain rice  
150 ml milk  
175 ml water  
1 vanilla pod  
pinch salt  
50 g sugar  
250 g strawberries  
40 g sugar  
40 ml Cointreau (40 % vol orange liqueur)  
200 ml cream  
1 egg white  
50 g pistachio nuts (shell off)

1. Place the rice in the bowl and fill with the liquid ingredients. Slit open the vanilla pod, add to the rice with the salt and the sugar, cover, and cook.  
**1. 3-5 min. ◀ 900 W**  
**2. 24-26 min. ◀ 270 W**  
Allow the rice to stand for about 5 minutes after cooking.
2. Cut the strawberries in half, mix in the sugar and the Cointreau.
3. Remove the vanilla pod from the rice, and cool the rice in a cold water bain marie, while stirring. Whip the cream and the egg white separately until both are stiff. Fold in first the pistachios, then the cream, and finally the egg white into the cold rice.
4. Place the rice in a large dish. Make a well in the top and place the strawberries in the well.

# Drinks, desserts & cakes

Germany

## Cheesecake



makes 12 portions

Total cooking time: approx. 21-27 minutes

Utensils: Spring form pan (approx. 26 cm diameter)

Ingredients

300 g flour  
1 tbsp cocoa  
3 tsp baking powder (9 g)  
150 g sugar  
1 egg  
150 g butter or margarine  
1 tsp butter or margarine to grease the form  
100 g butter or margarine to grease the pan  
100 g sugar  
1 pack vanilla sugar (10 g)  
3 eggs  
400 g fromage frais, 20 % fat content  
1 pack powdered vanilla pudding mix (40 g)

1. Mix the flour and cocoa with the baking flour. Add the sugar, egg and butter and use the kneading hook on the hand-held blender to knead.
2. Grease the pan, roll out  $\frac{2}{3}$  of the dough and place it in the pan. Lift the edges 2 cm to form a rim. Pre-bake the pastry.  
**6-8 min.**  **630 W**
3. Whisk the butter until light and fluffy, add the sugar and eggs one at a time. Finally add the fromage frais and the powdered vanilla pudding mix.
4. Spread the filling over the pre-baked dough and add the remaining crumbling dough on the cake and bake.  
**15-19 min.**  **630 W**

Denmark



## Fruit jelly with vanilla sauce

Total cooking time: approx. 8-12 minutes

Utensils: Dish with lid (2 l capacity)

Ingredients

150 g redcurrants, washed and stalks removed  
150 g strawberries, washed and haulms removed  
150 g raspberries, washed and haulms removed  
250 ml white wine  
100 g sugar  
50 ml lemon juice  
8 gelatin leaves  
300 ml milk  
inside of  $\frac{1}{2}$  vanilla pod  
30 g sugar  
15 g food thickener

1. Put some of the fruit to one side for decoration. Purée the rest of the fruit with the white wine, put it into a dish, cover and heat.  
**5-7 min.**  **900 W**  
Fold in the sugar and the lemon juice.
2. Soak the gelatin in cold water for approx. 10 minutes, then take it out and squeeze dry. Stir the gelatin in with the hot purée until it has dissolved. Place the jelly in the refrigerator and leave to set.
3. To make the vanilla sauce, put the milk into a dish. Slit the vanilla pod and remove the inside. Stir this in with the milk, together with the sugar and the food thickener, cover and cook, stirring during cooking and again at the end.  
**3-5 min.**  **900 W**
4. Turn out the jelly onto a plate and decorate with the whole fruit. Add the vanilla sauce.

Tip: You can also use defrosted frozen fruits.

# Care & cleaning

**CAUTION: DO NOT USE COMMERCIAL OVEN CLEANERS, STEAM CLEANERS, ABRASIVE, HARSH CLEANERS, ANY THAT CONTAIN SODIUM HYDROXIDE OR SCOURING PADS ON ANY PART OF YOUR MICROWAVE OVEN.**

## Oven exterior

The outside of your oven can be cleaned easily with mild soap and water. Make sure the soap is wiped off with a moist cloth, and dry the exterior with a soft towel.

## Oven controls

Open the door before cleaning to de-activate the oven controls. Care should be taken when cleaning the oven control. Using a cloth dampened with water only, gently wipe the panel until it becomes clean. Avoid using excessive amounts of water. Do not use any sort of chemical or abrasive cleaner.

## Oven Interior

1. For cleaning, wipe any splatters or spills with a soft damp cloth or sponge after each use while the oven is still warm. For heavier spills, use a mild soap and wipe several times with a damp cloth until all residues are removed. Do not remove the waveguide cover.
2. Make sure that mild soap or water does not penetrate the small vents in the walls which may cause damage to the oven.
3. Do not use spray type cleaners on the oven interior.

## Turntable and turntable support

Remove the turntable and turntable support from the oven. Wash the turntable and turntable support in mild soapy water. Dry with a soft cloth. Both the turntable and the turntable support are dishwasher safe.

## Door

To remove all trace of dirt, regularly clean both sides of the door, the door seals and sealing surfaces with a soft, damp cloth.

**NOTE:** A steam cleaner should not be used.

# What to do if...

## ... the microwave appliance is not working properly ?

Check that

- the fuses in the fuse box are working,
- there has not been a power outage.
- If the fuses continue to blow, please contact a qualified electrician.

## ... the microwave mode is not working ?

Check that

- the door is properly closed,
- the door seals and their surfaces are clean,
- the START-button has been pressed

## ... the turntable is not turning ?

Check that

- the turntable support is correctly connected to the drive,
- the ovenware does not extend beyond the turntable,
- food does not extend beyond the edge of the turntable preventing it from rotating.
- there is nothing in the well beneath the turntable.

## ... the microwave will not switch off ?

- Isolate the appliance from the fuse box.
- Contact your local Service Force Centre.

## ... the interior light is not working ?

- Call your local Service Force Centre. The interior light bulb can be exchanged only by trained Service Force technicians.

## ... the food is taking longer to heat through and cook than before ?

- Set a longer cooking time (double quantity = nearly double time) or
- if the food is colder than usual, rotate or turn from time to time or
- set a higher power setting.

**NOTE:** If you cook the food over the standard time with only 900 W, the power of the oven will lower automatically to avoid overheating. (The microwave power level will be reduced to 630 W).

After pausing for 75 seconds, 900 W power can be reset.

Cooking Mode	Standard time	Reduced Power
Microwave 900 W	40 minutes	Microwave 630 W



# Service & spare parts

If you wish to purchase spare parts or require an engineer, contact your local AEG Service Force Centre by telephoning:

**08705 929 929**

Your telephone call will be automatically routed to the Service Force Centre covering your post code area.

For the address of your local Service Force Centre and further information about Service Force, please visit the website at:

**[www.serviceforce.co.uk](http://www.serviceforce.co.uk)**

When you contact the Service Force Centre they will need the following information:

1. Your name & address, including post code.
2. Your telephone number
3. Clear and concise details of the fault.
4. The model and serial number of the appliance (found on the rating plate).
5. The purchase date:  
Please note that a valid purchase receipt or guarantee documentation is required for in-guarantee service calls.

## Customer care

For general enquiries concerning your AEG appliance or for further information on AEG products please contact our Customer Care Department by letter or telephone at the address below or visit our website at:

**[www.aeg.co.uk](http://www.aeg.co.uk)**

Customer Care Department  
AEG Domestic Appliances  
55-77 High Street  
Slough  
Berkshire, SL1 1DZ

Tel. 08705 350350 (\*)

(\*) Calls may be recorded for training purposes.

For Customer Service in Ireland please contact us at the address below:

AEG  
Electrolux Group (Irl) Ltd  
Long Mile Road  
Dublin 12  
Republic of Ireland

Tel: + 353 (0)1 4090754

Email: [service.eid@electrolux.ie](mailto:service.eid@electrolux.ie)

# Guarantee conditions

## Standard guarantee conditions

We, AEG, undertake that if within 12 months of the date of the purchase this AEG appliance or any part thereof is proved to be defective by reason only of faulty workmanship or materials, we will, at our discretion repair or replace the same FREE OF CHARGE for labour, materials or carriage on condition that:

- The appliance has been correctly installed and used only on the electricity or gas supply stated on the rating plate.
- The appliance has been used for normal domestic purposes only, and in accordance with the manufacturer's operating and maintenance instructions.
- The appliance has not been serviced, maintained, repaired, taken apart or tampered with by any person not authorised by us.
- All service work under this guarantee must be undertaken by a Service Force Centre. Any appliance or defective part replaced shall become the Company's property.
- This guarantee is in addition to your statutory and other legal rights.
- Home visits are made between 8.30am and 5.30pm Monday to Friday.  
Visits may be available outside these hours in which case a premium will be charged.

## Exclusions

This guarantee does not cover:

- Damage or calls resulting from transportation, improper use or neglect, the replacement of any light bulbs or removable parts of glass or plastic.
- Costs incurred for calls to put right an appliance which is improperly installed or calls to appliances outside the United Kingdom.
- Appliances found to be in use within a commercial environment, plus those which are subject to rental agreements.
- Products of AEG manufacture which are not marketed by AEG.

## European Guarantee

If you should move to another country within Europe then your guarantee moves with you to your new home subject to the following qualifications:

- The guarantee starts from the date you first purchased your product.
- The guarantee is for the same period and to the same extent for labour and parts as exists in the new country of use for this brand or range of products.
- This guarantee relates to you and cannot be transferred to another user.
- Your new home is within the European Community (EC) or European Free Trade Area.
- The product is installed and used in accordance with our instructions and is only used domestically, i.e. a normal household.
- The product is installed taking into account regulations in your new country.

Before you move please contact your nearest Customer Care centre, listed below, to give them details of your new home. They will then ensure that the local Service Organisation is aware of your move and able to look after you and your appliances.

France	Senlis	+33 (0) 3 44 62 29 29
Germany	Nürnberg	+49 (0) 800 234 7378
Italy	Pordenone	+39 (0) 800 117511
Sweden	Stockholm	+46 (0) 8 672 5360
UK	Slough	+44 (0) 1753 219899

# Specifications

AC Line Voltage	: 230-240 V, 50 Hz, single phase
Distribution line fuse/circuit breaker	: Minimum 10 A
AC Power required:	Microwave : 1.3 kW
Output power:	Microwave : 900 W (IEC 60705)
Microwave Frequency:	: 2450 MHz
Outside Dimensions:	: 592 mm (W) x 460 mm (H) x 437 mm (D)
Cavity Dimensions	: 342 mm (W) x 207 mm (H) x 368 mm (D) *
Oven Capacity	: 26 litres *
Turntable	: ø 325 mm, glass
Weight	: approx. 20 kg
Oven lamp	: 25 W/240 - 250 V

\* Internal capacity is calculated by measuring maximum width, depth and height.  
Actual capacity for holding food is less.



This oven complies with the requirements of Directives 89/336/EEC and 73/23/EEC as amended by 93/68/EEC.

SPECIFICATIONS ARE SUBJECT TO CHANGE WITHOUT NOTICE AS PART OF CONTINUOUS IMPROVEMENT

## Important information



### Ecologically responsible disposal of packaging materials and old appliances



#### Packaging materials

AEG microwave ovens require effective packaging to protect them during transportation.

Only the minimum packaging necessary is used.

Packaging materials (e.g. foil or styrofoam) can place children at risk.



**Danger of suffocation. Keep packaging material away from children.**



All packaging materials used are environment friendly and can be recycled. The cardboard is made from recycled paper and the wooden parts are untreated. Plastic items are marked as follows:

«PE» polyethylene eg packaging film

«PS» polystyrene eg packaging (CFC-free)

«PP» polypropylene eg packaging straps

By using and re-using the packaging, raw materials are saved and waste volume is reduced.

Packaging should be taken to your nearest recycling centre.

Contact your local council for information.



#### Disposal of old appliances

Old appliances should be made safe before disposal by removing the plug, and cutting off and disposing of the power cable.

It should then be taken to the nearest recycling centre. Check with your local Council or

Environmental Health Office to see if there are facilities in your area for recycling the appliance.

# **i** Installation

## INSTALLING THE APPLIANCE

1. Remove all packaging and check carefully for any signs of damage.
2. If fitting the microwave oven above a conventional oven (position A) then use the mylar sheet provided.
  - a. Cut the Mylar sheet to fit the internal width of the unit.
  - b. Peel back the protective cover on the tape and fix to the rear of the shelf so that it covers the service gap. (See diagram).

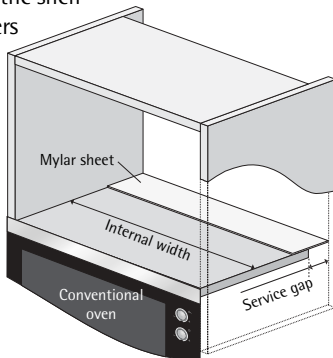

3. Fit the appliance into the kitchen cupboard slowly, and without force, until the front frame of the oven seals against the front opening of the cupboard.

4. Ensure the appliance is stable and not leaning. Ensure that a 5mm gap is kept between the cupboard door above and the top of the frame (see diagram).



5. Fix the oven in position with the screws provided.

The fixing points are located on the top and bottom corners of the oven (see diagram, item 9, on page 4).

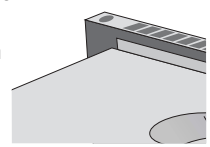

6. It is important to ensure that the installation of this product conforms to the instructions in this operation manual and the conventional oven manufacturer's installation instructions.

The microwave can be fitted in position A or B:

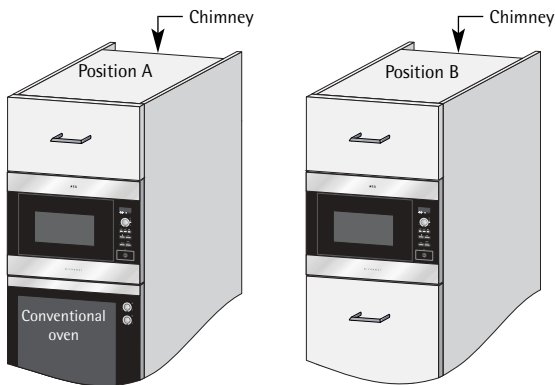

POSITION	NICHE SIZE			CHIMNEY (min)	Gap Between Cupboard & Ceiling
	W	D	H		
A	560	550	450	50	50
B	560	500	450	40	50

Measurements in (mm)

# Installation

## CONNECTING THE APPLIANCE TO THE POWER SUPPLY

- The electrical outlet should be readily accessible so that the unit can be unplugged easily in an emergency.
- The socket should not be positioned behind the cupboard.
- The best position is above the cupboard, see (A).  
When not connecting the power supply cord to position (A) it should be removed from the support clip (see diagram, item 13, on page 4) and routed under the oven.
- Connect the appliance to a single phase 230–240V/50Hz alternating current via a correctly installed earth socket. The socket must be fused with a  $\geq 10A$  fuse.
- If the appliance is to be operated in a non-European country, the supply voltage, current type and frequency of the appliance indicated on the rating plate must correspond with the specification of your power supply. The rating plate can be found on the inside face of the control panel.
- The power supply cord may only be replaced by an electrician.
- Before installing, tie a piece of string to the power supply cord to facilitate connection to point (A) when the appliance is being installed.
- When inserting the appliance into the high-sided cupboard, DO NOT crush the power supply cord.

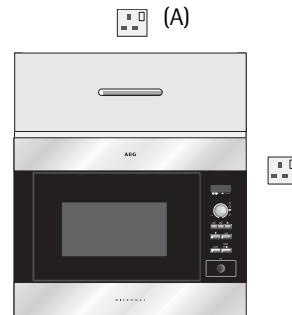

## ELECTRICAL CONNECTIONS



**WARNING:**  
**THIS APPLIANCE MUST BE EARTHED**  
The manufacturer declines any liability should this safety measure not be observed.

- If the plug that is fitted to your appliance is not suitable for your socket outlet, it must be cut off and the appropriate plug fitted.
- Remove the fuse from the cut off plug. The cut off plug should then be disposed of to prevent the hazard of shocks in case it should be plugged into a 13 Amp socket in another part of your home.
- Connect the green and yellow (earth) wire to the terminal in the plug which is marked with the letter "E" or the earth symbol (  $\perp$  ) or coloured green and yellow.
- Connect the blue (neutral) wire to the terminal in the plug which is marked with the letter "N" or coloured black.
- Connect the brown (live) wire to the terminal in the plug which is marked with the letter "L" or coloured red.

### IMPORTANT

The wires in the mains lead are coloured in accordance with the following code:

GREEN AND YELLOW	EARTH
BLUE	NEUTRAL
BROWN	LIVE

If you fit your own plug, the colours of the wires in the mains lead of your appliance may not correspond with the markings identifying the terminals in your plug, proceed as follows:

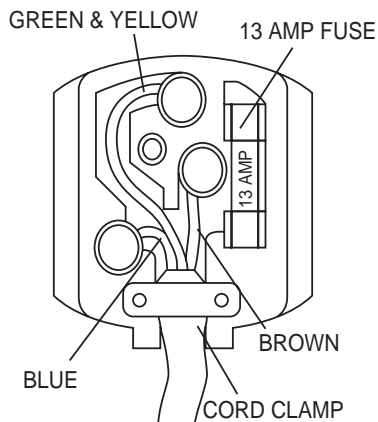







**From the Electrolux Group. The World's No.1 choice.**

*The Electrolux group is the world's largest producer of powered appliances for the kitchen, cleaning and outdoor use. More than 55 million Electrolux Group products (such as refrigerators, cookers, washing machines, vacuum cleaners, chain saws and lawn mowers) are sold each year to a value of approx. USD 14 billion in more than 150 countries around the world.*

AEG Domestic Appliances  
Cornwall House  
55 - 77 High Street  
SLOUGH  
SL1 1DZ

Telephone: 08705 350350

© Electrolux plc 2004

TINS-A356URR0 △

Printed on recycled paper-  
AEG - putting words into action

Printed on paper manufactured with  
environmentally sound processes.  
He who thinks ecologically acts accordingly ...



## Free Manuals Download Website

<http://myh66.com>

<http://usermanuals.us>

<http://www.somanuals.com>

<http://www.4manuals.cc>

<http://www.manual-lib.com>

<http://www.404manual.com>

<http://www.luxmanual.com>

<http://aubethermostatmanual.com>

Golf course search by state

<http://golfingnear.com>

Email search by domain

<http://emailbydomain.com>

Auto manuals search

<http://auto.somanuals.com>

TV manuals search

<http://tv.somanuals.com>