

L 98685 FL
L 98485 FL

WASHING MACHINE

USER MANUAL

CONTENTS

4	SAFETY INFORMATION
6	ENVIRONMENT CONCERNS
6	TECHNICAL INFORMATION
7	PRODUCT DESCRIPTION
7	INTERIOR ACCESSORIES
8	CONTROL PANEL
13	WASHING PROGRAMMES
17	BEFORE FIRST USE
18	USING THE APPLIANCE
18	ACTIVATING THE APPLIANCE AND SETTING A PROGRAMME
18	LOADING THE LAUNDRY
19	USING THE DETERGENT AND ADDITIVES
21	STARTING A PROGRAMME
21	AT THE END OF PROGRAMME
22	HELPFUL HINTS AND TIPS
23	CARE AND CLEANING
28	TROUBLESHOOTING
31	INSTALLATION

SERVICE

When contacting Service, ensure that you have the following data available. The information can be found on the rating plate.

Model _____

PNC _____

Serial Number _____

The following symbols are used in this user manual:



Warning - Important Safety information.



General information and tips



Environmental information

Subject to change without notice

Download from [Www.Somanuals.com](http://www.Somanuals.com). All Manuals Search And Download.

FOR PERFECT RESULTS

Thank you for choosing this AEG product. We have created it to give you impeccable performance for many years, with innovative technologies that help make life simpler – features you might not find on ordinary appliances. Please spend a few minutes reading to get the very best from it.

ACCESSORIES AND CONSUMABLES

In the AEG webshop, you'll find everything you need to keep all your AEG appliances looking spotless and working perfectly. Along with a wide range of accessories designed and built to the high quality standards you would expect, from specialist cookware to cutlery baskets, from bottle holders to delicate laundry bags...



Visit the webshop at:
www.aeg.com/shop

VISIT OUR WEBSITE FOR:

- Products
- Brochures
- User manuals
- Trouble shooter
- Service information

www.aeg.com



SAFETY INFORMATION

Before the installation and use, read this manual carefully:

- For your safety and the safety of your property
- To help the environment
- For the correct operation of the appliance.

Always keep these instructions with the appliance also if you move or give it to a different person.

The manufacturer is not responsible if an incorrect installation and use causes damage.

CHILDREN AND VULNERABLE PERSON SAFETY

- Do not let persons, children included, with reduced physical sensory, reduced mental functions or lack of experience and knowledge use the appliance. They must have supervision or instruction for the operation of the appliance by a person who is responsible for their safety.
- Keep all packaging away from children. There is the risk of suffocation or injury.
- Keep all detergents away from children.
- Keep children and pets away from the appliance when the door is open.
- Before you close the appliance door, make sure that children and pets are not into the drum.
- If the appliance has a child safety device, we recommend to activate it.

CHILD SAFETY DEVICE

- When you activate this device, you cannot close the door. This prevents children or pets to be closed in the drum. To activate the device, turn it clockwise, until the groove is horizontal. To deactivate the device, turn it counterclockwise, until the groove is vertical.

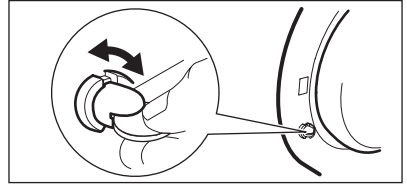

GENERAL SAFETY

- Do not use the appliance for professional use. The appliance is only for domestic use.
- Do not change the specifications of this appliance. There is the risk of injury and damage to the appliance.
- Do not put flammable products or items that are wet with flammable products in, near or on the appliance. Risk of explosion or fire.
- Obey the safety instructions on the detergent packaging to prevent burns to eyes, mouth and throat.
- Make sure that you remove all metal objects from the laundry. Hard and sharp material can cause damage to the appliance.
- Do not touch the glass of the door while a programme operates. The glass can be hot (only for front-loading appliances).

CARE AND CLEANING

- Deactivate the appliance and disconnect the mains plug from the mains socket.
- Do not use the appliance without the filters. Make sure that the installation of the filters is correct. An incorrect installation causes water leakages.

INTERNAL LAMP

This appliance has an internal lamp that comes on when you open the door and goes off when the door is closed.

**WARNING!**

Do not look directly into the beam of the lamp.



To replace the internal lamp, contact the service centre. Disconnect the mains plug from the mains socket before the replacement of the internal lamp.

INSTALLATION

- The appliance is heavy, be careful when you move it.
- Do not transport your appliance without the transit bolts, you can damage internal components and cause leakages or malfunctions.
- Do not install and connect a damaged appliance.
- Make sure to remove all packaging and transport bolts.
- Make sure that the mains plug is disconnected from the mains socket during installation.
- Only a qualified person must do the electrical installation, the plumbing and the installation of the appliance. This to prevent the risks of structural damage or injury.
- Do not install or use the appliance where the temperature is less than 0 °C.
- When you install the appliance on a carpet floor, make sure that there is air circulation between the appliance and the carpet. Adjust the feet to have the necessary space between the appliance and the carpet.

Water connection

- Do not connect the appliance with old hoses already used. Only use new hoses.
- Make sure not to cause damage to the water hoses.

- Do not connect the appliance to new pipes or pipes not used for a long time. Let the water flow for some minutes, then connect the inlet hose.
- The first time you use the appliance, make sure that the water hoses and the couplings do not have leakages.

Electrical connection

- Make sure that the appliance is earthed.
- Make sure that the electrical information on the rating plate agrees with the power supply.
- Always use a correctly installed shockproof socket.
- Do not use multiple plugs and extension cables. There is a risk of fire.
- Do not replace or change the mains cable. Contact the service centre.
- Make sure not to cause damage to the mains plug and cable.
- Connect the mains plug to the mains socket only at the end of the installation. Make sure that there is access to the mains plug after the installation.
- Do not pull the mains cable to disconnect the appliance. Always pull the mains plug.

DISCARD THE APPLIANCE

1. Disconnect the mains plug from the mains socket.
2. Cut off the mains cable and discard it.
3. Discard the door catch. This prevents children or pets to be closed in the appliance. There is a risk of suffocation (only for front-loading appliances).



ENVIRONMENT CONCERNS

PACKAGING MATERIALS

Recycle the materials with the symbol



Put the packaging in applicable containers to recycle it.

ECOLOGICAL HINTS

To help the environment, use less water and energy, obey these instructions:

- Set a programme without the pre-wash phase to wash laundry with normal soil.
- Always start a washing programme with the maximum load of laundry.
- If necessary, use a stain remover when you set a programme with a low temperature.
- To use the correct quantity of the detergent, check the water hardness of your domestic system

The symbol  on the product or on its packaging indicates that this product may not be treated as household waste. Instead it should be taken to the appropriate collection point for the recycling of electrical and electronic equipment. By ensuring this product is disposed of correctly, you will help prevent potential negative consequences for the environment and human health, which could otherwise be caused by inappropriate waste handling of this product. For more detailed information about recycling of this product, please contact your local council, your household waste disposal service or the shop where you purchased the product.

TECHNICAL INFORMATION

Dimensions	Width / Height / Depth	600 / 850 / 600 mm
	Total depth	640 mm
Electrical connection:	Voltage	230 V
	Overall power	2200 W
	Fuse	10 A
	Frequency	50 Hz
Water supply pressure	Minimum	0,5 bar (0,05 MPa)
	Maximum	8 bar (0,8 MPa)
Water supply ¹⁾		Cold water
Maximum load	Cotton	8 kg
Spin speed	Maximum	1400 rpm (L98485FL)
		1600 rpm (L98685FL)

¹⁾ Connect the water inlet hose to a water tap with a 3/4" thread.

PRODUCT DESCRIPTION

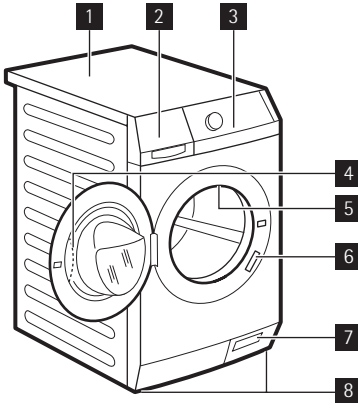

- 1** Worktop
- 2** Detergent dispenser
- 3** Control panel
- 4** Door handle
- 5** Internal lamp
- 6** Rating plate
- 7** Drain pump

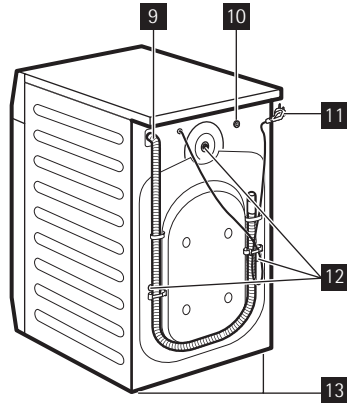

- 8** Feet for the appliance level
- 9** Water drain hose
- 10** Water inlet hose
- 11** Mains cable
- 12** Transit bolts
- 13** Feet for the appliance level

INTERIOR ACCESSORIES

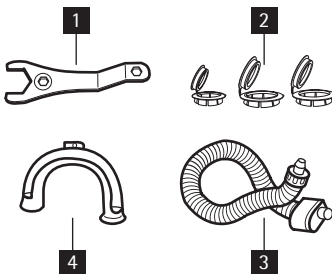

- 1** **Spanner**
To remove the transit bolts.
- 2** **Plastic caps**
To close the holes on the rear side of the cabinet after the removal of the transit bolts.
- 3** **Anti-flood inlet hose**
To prevent possible leakage
- 4** **Plastic hose guide**
To connect the drain hose on the edge of a sink.

CONTROL PANEL

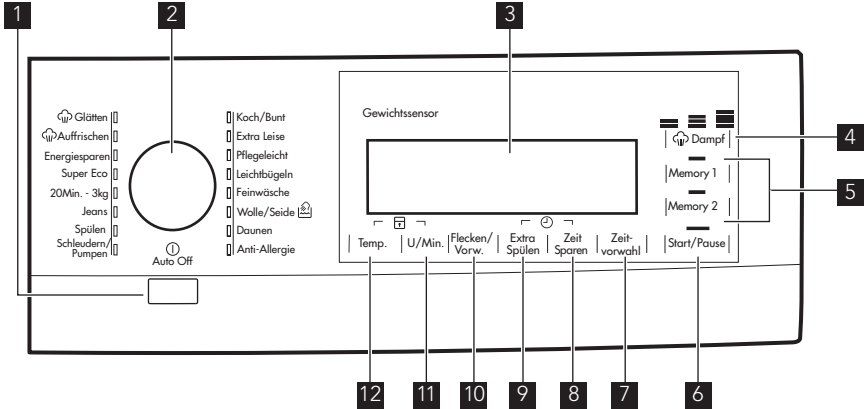

- | | |
|--|--|
| <p>1 Auto Off button</p> <p>2 Programme knob</p> <p>3 Display</p> <p>4 Dampf touch button</p> <p>5 Memory touch buttons</p> <p>6 Start/Pause touch button</p> <p>7 Zeitvorwahl touch button</p> | <p>8 Zeit Sparen touch button</p> <p>9 Extra Spülen touch button</p> <p>10 Flecken/Vorwäsche/Einweichen touch button</p> <p>11 Spin reduction touch button (U./Min.)</p> <p>12 Temperature touch button (Temp.)</p> |
|--|--|

TOUCH SCREEN



Do not wear gloves when you touch the buttons. Make sure the touch screen and buttons are always clean and dry.

- Before press button **6**, you do not use the appliance for five minutes. Press button **1** to activate the appliance again.
- After 5 minutes from the end of the washing programme. Refer to 'At the end of programme'.

AUTO OFF BUTTON **1**





Press this button to activate or deactivate the appliance. A tune sounds when the appliance is activated. The AUTO OFF function automatically deactivates the appliance to decrease energy consumption when:



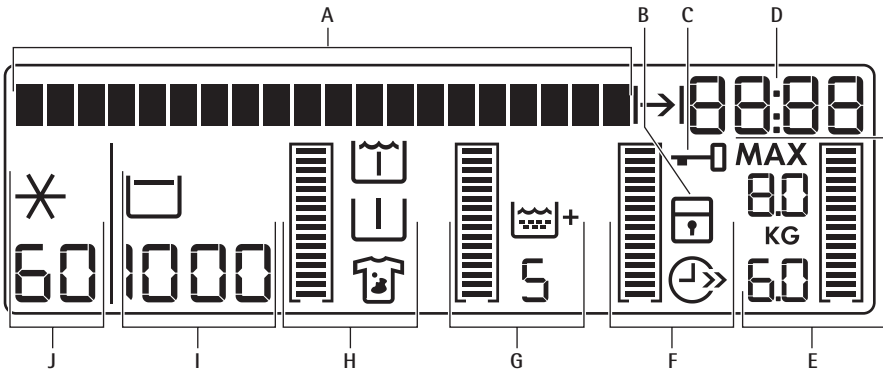







PROGRAMME KNOB **2**

Turn this knob to set a programme. The related programme indicator comes on.

DISPLAY 3



<p>The text bar:</p> <ul style="list-style-type: none"> • Guides you in the use of the appliance. • Shows the programme status and phase. • Shows alarm messages. Refer to 'Troubleshooting'. 	
<p>The symbols appear on the display when the related phase or function is set.</p>	
B	 Child lock
C	 <p>Door locked You cannot open the door when the symbol is on. You can open the door only when the symbol goes off. If the symbol stays on but the programme is completed:</p> <ul style="list-style-type: none"> • There is water in the drum. • The ' Rinse Hold ' function is on.
D	<p>• The time of the day When you activate the appliance the display shows the time of the day for some seconds. To adjust the clock, refer to "Clock setting".</p> <p>• The programme duration When the washing programme starts, the programme time decreases every minute.</p> <p> Programme duration symbol The symbol comes on when the digits shows the programme duration.</p> <p>• The end time of the washing programme .</p> <p> Programme end symbol The symbol comes on when the digits shows the programme end time.</p>

	<ul style="list-style-type: none"> The time of delay <ul style="list-style-type: none"> When you set the delayed start the time of the programme end increases by steps of 30 minutes till 10 hours and by steps of one hour till 20 hours.
	<ul style="list-style-type: none"> The end of the programme The display shows a zero.
This part comes on only if the door is open - Refer to 'Loading the laundry'.	
	MAX The programme maximum load
E	KG The weight of the laundry
	 The indicator bar fills accordingly to the laundry weight.
	 The indicator fully fills when you put the maximum load.
If you need to set a function	
	<ul style="list-style-type: none"> An empty indicator bar comes on when the related function is available with the set programme. If an indicator bar does not come on, it means that it is not available.
	<ul style="list-style-type: none"> The function symbol comes on when the function is set. The indicator bar fills accordingly to the set function. If you make an incorrect selection the text bar on the display tells that the selection is not possible.
	 Time save The symbol comes on when you set the following functions:
F	 Shortened duration
	 Extra quick
G	 Extra rinsing
	 The indicator bar fills accordingly the numbers of rinses.
	 Stains
	 Prewash
H	 Soak
	 The indicator bar fills accordingly to the set functions.
I	The default spin speed of the programme.
	--- No spin ¹⁾



Rinse hold

1) Only available for Spin/Drain programme.

J

The default temperature of the programme.



Cold wash

DAMPF BUTTON 4

Touch button **4** to set the steam level. This is possible only with programmes where the steam function is available. The duration of the steam phase changes accordingly to your selection.

MEMORY BUTTONS 5

Touch one of the buttons **5** to memorise a programme or to set a memorised programme.

Memorise a programme

1. Press button **1** to activate the appliance.
2. Turn the programme knob (**2**) to your favourite programme.
3. If it is necessary, set one or more functions.
4. Touch and hold one of the buttons **5** for some seconds. The buzzer sounds and the display shows that the programme is saved. .

Set a memorised programme

1. Touch the button where you memorised the programme you want to set.
2. The programme indicator comes on and the display shows all the information.



To cancel a memorised programme you can only memorise a new programme.

START/PAUSE BUTTON 6

Touch button **6** to start or interrupt a programme.

ZEITVORWAHL BUTTON 7

Touch button **7** to delay the start of a programme from 30 minutes to 20 hours.

ZEITSPAREN BUTTON 8

Touch button **8** to decrease the programme time.

You can select:

SHORTENED DURATION

To wash items with daily soil.

EXTRA QUICK

To wash quickly items with almost no soil.

Some programmes accept only one of these functions.

EXTRA SPÜLEN BUTTON 9

Touch button **9** to add rinsing phases to a programme.

Use this function for persons allergic to detergents and in areas where the water is soft.

FLECKEN, VORWÄSCHE UND EINWEICHEN BUTTON 10

Touch button **10** to set one of the these functions:

FLECKEN

Use this function for laundry with hard stains to remove.

When you set this function, put the stain remover into compartment



The programme duration increases. This function is not available with a temperature lower than 40° C.

VORWÄSCHE

Use this function for heavy soil.
The appliance adds a prewash phase to the main wash.
The programme duration increases.

EINWEICHEN

Use this function for heavy soil.
The appliance soaks the laundry at 30°C for about half an hour before to wash.

SPIN BUTTON 11

Touch button 11 to:

- Decrease the maximum speed of the spin phase of the programme.

 The display shows only the spin speeds available with the set programme.

- Deactivate the spin phase (' No Spin ' function).
- Activate the ' Rinse Hold ' function.
Set this function to prevent fabric creases. The appliance does not drain the water when the programme is completed.

TEMPERATURE BUTTON 12

Touch button 12 to change the default temperature.
Symbols - - - and ✖ = cold water

ACOUSTIC SIGNALS FUNCTION

You can hear the acoustic signals when:

- You activate the appliance.
- You deactivate the appliance.
- You touch the buttons.
- The programme is completed.



- The appliance has a malfunction.
To **deactivate/activate** the acoustic signals, touch button 10 and button 9 at the same time for 6 seconds.



If you deactivate the acoustic signals, they continue operate only when you touch the buttons and when a malfunction occurs.

CHILD LOCK FUNCTION

This function prevents children to play with the control panel.



- To activate the function, touch button 12 and button 11 at the same time until the display shows the symbol .
- To deactivate the function, touch button 12 and button 11 at the same time until the symbol  goes off.

You can activate the function:

- Before you touch the button 6 : the appliance cannot start.
- After you touch the button 6 , all the buttons and the programme knob are deactivated.

PERMANENT EXTRA RINSE FUNCTION

With this function you can keep the extra rinse function permanently on when you set a new programme.

- To **activate** the function touch button 8 and button 7 at the same time until the display shows the symbol .
- To **deactivate** the function touch button 8 and button 7 at the same time until the symbol  goes off.

WASHING PROGRAMMES

Programme	Temperature	Type of load Weight of load	Programme description	Functions
Koch/Bunt	95° - Cold	White and coloured cotton with heavy level of soil. Maximum load 8 kg	Wash Rinses Long spin	SPIN REDUCTION SPÜLSTOPP FLECKEN ¹⁾ VORWÄSCHE ²⁾ EINWEICHEN EXTRA SPÜLEN ZEIT SPAREN ³⁾
Extra Leise	95° - Cold	White and coloured cotton with normal level of soil. Maximum load 8 kg	Wash Rinses Long spin Stop with water in the drum	SPÜLSTOPP FLECKEN ¹⁾ VORWÄSCHE ²⁾ EINWEICHEN EXTRA SPÜLEN ZEIT SPAREN ³⁾
Pflegeleicht	60° - Cold Rinses Short spin	Synthetic or mixed fabric items with normal soil. Maximum load 4 kg	Wash Rinses Short spin	SPIN REDUCTION SPÜLSTOPP FLECKEN ¹⁾ VORWÄSCHE ²⁾ EINWEICHEN EXTRA SPÜLEN ZEIT SPAREN ³⁾
Leichtbügeln	60° - Cold	Synthetic fabric items with normal soil. It prevents the creases of the laundry. Maximum load 1,5 kg	Wash Rinses Short spin	SPIN REDUCTION SPÜLSTOPP VORWÄSCHE ²⁾ EINWEICHEN EXTRA SPÜLEN ZEIT SPAREN ³⁾

Programme	Temperature	Type of load Weight of load	Programme description	Functions
Feinwäsche	40° - Cold Rinses Short spin	Delicate fabrics as acrylics, vis- cose, polyester items with nor- mal soil. Maximum load 4 kg	Wash Rinses Short spin	SPIN REDUC- TION SPÜLSTOPP VORWÄ- SCHE ²⁾ FLECKEN EINWEICHEN EXTRA SPÜ- LEN ZEIT SPA- REN ³⁾
Wolle / Seide	40° - Cold Rinses Short spin	Machine wash- able wool as well as for hand wash- able woollens and delicate fab- rics with «hand washing» care symbol. Maximum load 2 kg	Wash Rinses Short spin	SPIN REDUC- TION SPÜLSTOPP
Daunen	60° - 30° Rinses Short spin	Special pro- gramme for one synthetic blanket, duvet, bed- spread and so on. Maximum load 3 kg	Wash Rinses Short spin	SPIN REDUC- TION
Anti-Allergie	60°	White cotton items ⁴⁾ . Maximum load 8 kg	Wash at 60° Rinses Short spin	SPIN REDUC- TION SPÜLSTOPP FLECKEN VORWÄ- SCHE ²⁾ EINWEICHEN EXTRA SPÜ- LEN
Schleudern / Pumpen ⁵⁾	0°	All fabrics The maximum load of the laun- dry is related to the type of laun- dry.	Drainage of the water Spin phase at the maximum speed	SPIN REDUC- TION OHNE SCHLEU- DERN ⁶⁾

Programme	Temperature	Type of load Weight of load	Programme description	Functions
Spülen	0°	All fabrics Maximum load 8 kg	Rinse with ad- ditives Spin phase	SPIN REDUC- TION SPÜLSTOPP EXTRA SPÜ- LEN ⁷⁾
Jeans	60° - Cold	Items like pants, shirts or jackets in Jeans and also jersey realized with hi-tech ma- terials. Maximum load 3,5 kg	Wash Rinses Short spin	SPIN REDUC- TION SPÜLSTOPP VORWÄSCHE 2) EINWEICHEN EXTRA SPÜ- LEN ZEIT SPA- REN ³⁾
20 min. - 3 kg	40° or 30°	Quick wash of sport items or cotton and syn- thetic items, lightly soiled or worn once. Maximum load 3 kg	Wash Rinses Short spin	SPIN REDUC- TION
Super Eco	0°	Mixed fabrics (cotton and syn- thetic items) ⁸⁾ . Maximum load 3 kg	Wash Rinses Long spin	SPIN REDUC- TION SPÜLSTOPP EXTRA SPÜ- LEN
Energiespa- ren	60° or 40°	White and fast coloured cotton with the normal soil ⁹⁾ . Maximum load 8 kg	Wash Rinses Short spin	SPIN REDUC- TION SPÜLSTOPP FLECKEN VORWÄ- SCHE ²⁾ EINWEICHEN EXTRA SPÜ- LEN ZEIT SPA- REN ³⁾

1) Not available with temperature lower than 40°C.



2) If you use liquid detergent, set a programme without PREWASH.

3) If you touch the button **3** to set the Extra Kurz function, we recommend that you decrease the quantity of the load. It is possible to keep the full load but the washing results are not good.

4) This program removes the micro-organisms thanks to the washing by 60°C and adds on rinse. In this way the action is more effective. **Important! Put into the compartment Stain a special additive for hygiene and select the option Stain.**

- 5) The default spin speed is for cotton items. Set the spin speed applicable with your laundry.
- 6) If you select this function the appliance performs only a drain phase.
- 7) Press button to add rinses. With a low spin speed the appliance performs delicate rinses and a short spin.
- 8) Use a special detergent for very low temperature.
- 9) Set this programme to have a good washing results and decrease the energy consumption. The time of the washing programme is extended.

STEAM PROGRAMMES

Programme ¹⁾	Type of load	Load
Dampf Auffrischen ²⁾ This cycle removes odour from the laundry.	Cotton and synthetic items. Do not set the Steam programme for this type of clothes: <ul style="list-style-type: none"> • Clothes which is not specified on the care label as being suitable for tumble-drying. 	up to 1,5 Kg
 Steam does not remove animal odours.		
Dampf Glätten ²⁾ This programme helps to dewrinkle odour from the laundry.	<ul style="list-style-type: none"> • Clothes with inclusion of plastic, metal, wooden parts or alike. 	up to 1,5 Kg
 Steam can be used for dried, washed or worn once laundry. These programmes can reduce creases and odours and make your laundry more smooth. Do not use any detergent. If necessary, remove stains by washing or using localized stain removal. Steam programmes do not perform any hygienic cycle.		
 Touch the button 4 to change the duration of steam phase.		

1) If you set a Steam programme with dried laundry, at the end of the cycle the laundry feel humid. It is better to expose clothes to the open air for about 10 minutes to let the humidity go away. Laundry should be removed from the drum as quick as possible. After a steam cycle, clothes may be ironed anyway, but with less effort!

2) For the programme time, refer to the display.

CONSUMPTION VALUES

Programme ¹⁾	Energy consumption (KWh) ²⁾	Water consumption (litre) ²⁾
White Cottons 95 °C	2.40	70
Cottons 60 °C	1.50	66
Cottons 40 °C	0.90	66
Synthetics 40 °C	0.60	48
Delicates 40 °C	0.70	58
Wool/ Handwash 30 °C	0.35	57
Programmes for energy saving		
Cotton 60 °C economy ³⁾	0.88	57

Programme ¹⁾	Energy consumption (kWh) ²⁾	Water consumption (litre) ²⁾
Cotton 40 °C economy ³⁾	0.70	57
<p>i The cotton 60 °C economy and cotton 40 °C economy are the standard cotton programmes for normally soiled cotton laundry. They are suitable to clean normally soiled cotton laundry and they are the most efficient programmes in terms of combined energy and water consumption for washing that type of cotton laundry. The actual water temperature may differ from the declared cycle temperature.</p>		

1) Refer to the display for the programme time.

2) The consumption information shown in this chart is indicative. It can vary depending on the quantity and the type of laundry, on the temperature of the water supply and on the ambient temperature.

3) This is the programme for test institutes. It agrees with EN60456.

BEFORE FIRST USE

- To activate the drain system, put 2 litre of water in the main wash compartment of the detergent dispenser.
- Put a small quantity of detergent in the main wash compartment of the detergent dispenser. Set and start a programme for cotton at the highest temperature without laundry. This removes all possible dirt from the drum and the tub.

LANGUAGE SETTING

The first time you activate the appliance, the display shows the default language and tells you to confirm it or change it:

- Turn the programme knob to set the desired language.
- When the display shows the necessary language, touch button **6** to confirm the selection.

Change the language after the first activation

- Touch button **11** and button **10** at the same time for some seconds.
- When display shows the language set, turn the programme knob to set the new language.

- Touch button **6** to confirm the selection.

CLOCK SETTING

After you set the language, the display tells to set the clock:

- The hour digits flash.
- Turn the programme knob to change the hour.
- Touch button **6** to confirm the selection.
- The minute digits flash.
- Turn the programme knob to change the minutes.
- Touch button **6** to confirm the selection.

Change the time of the day after the first activation

- Touch button **9** and the button **8** at the same time for some seconds.
- The hour digits flash.
- Turn the programme knob to change the hour.
- Touch button **6** to confirm the selection.
- The minute digits flash.
- Turn the programme knob to change the minutes.

7. Touch button **6** to confirm the selection.

USING THE APPLIANCE

1. Open the water tap.
2. Connect the mains plug to the mains socket.

ACTIVATING THE APPLIANCE AND SETTING A PROGRAMME



For a correct operation of the weight sensor, activate the appliance and set the programme BEFORE you put the laundry in the drum.

1. Press button **1** to activate the appliance.
2. Turn the programme knob (**2**) to the necessary programme or touch one of the buttons **5** to set a memorised programme. The programme indicator comes on.
3. The indicator of button **6** flashes with red colour.
4. The display shows the default temperature and spin. If it is necessary, touch button **12** and button **11** to change the water temperature and the spin speed.
5. If it is necessary, touch the other buttons to add some functions or to set a delayed start. The display shows the symbol of the set function and the digit (**D**) shows the delayed time.

LOADING THE LAUNDRY

1. Open the appliance door.
2. The display (**E**) shows the maximum programme load for the programme (**MAX**) and the weight of the laundry (**KG**). The text bar on the display tells to add the laundry.
3. Put the laundry in the drum, one item at a time. Shake the items before you put them in the appliance.
4. On the display the weight of the laundry updates by step of kg 0.5. The weight is indicative and changes with the type of the laundry.



If you put more laundry than the maximum load, the display tells that you put more than the maximum load.

You can wash your laundry but the energy and water consumption increase.

To have the best consumption and washing performance remove some items.

The overload indication is available only for programmes with a maximum load lower than the appliance maximum load.

5. Close the door. The text bar on the display tells the percentage of detergent to use. This data is indicative and refers to the detergent quantity for a maximum load that the manufacturer recommends.

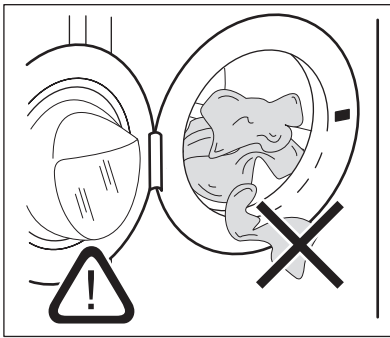

Make sure not to have the laundry out of the drum between the seal and the door. There is the risk of water leakage or damage laundry.

USING THE DETERGENT AND ADDITIVES

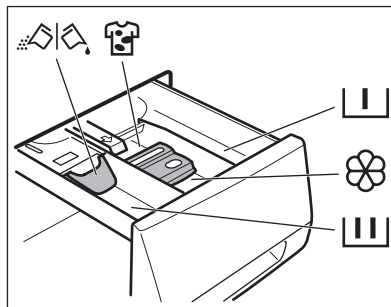

	<p>The detergent compartment for the prewash phase and the soak programme. Add the detergent for prewash and soak before the start of the programme.</p>
	<p>The detergent compartment for the washing phase. If you use a liquid detergent, put it immediately before you start the programme.</p>
	<p>Liquid additives compartment (fabric conditioner, starch). Put the product in the compartment before you start the programme.</p>
<p>MAX</p>	<p>This is the maximum level for the quantity of liquid additives.</p>
	<p>The compartment for the stain remover. Put the product in the compartment and set the stain function before you start the programme.</p>
	<p>Flap for powder or liquid detergent Turn it (up or down) in the correct position to use powder or liquid detergent.</p>
	<p>Always obey the instructions that you find on the packaging of the detergent products.</p>

Check the position of the flap

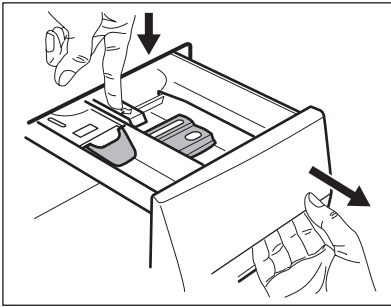

1. Pull out the detergent dispenser until it stops.
2. Press the lever down to remove the dispenser.

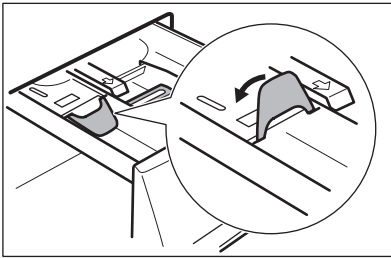

3. To use powder detergent, turn the flap up.

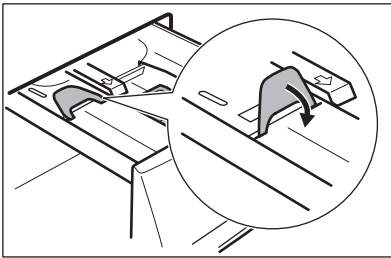

4. To use liquid detergent, turn the flap down.



With the flap in the position DOWN:

- Do not use gelatinous or thick liquid detergents.
- Do not put more liquid detergent than the limit showed in the flap.
- Do not set the prewash phase.
- Do not set the delay start function.

5. Measure out the detergent and the fabric conditioner.
6. Carefully close the detergent dispenser. Make sure that the flap does not cause a blockage when you close the drawer.

SET THE DELAY START

1. Touch button **7** again and again to set the desired delayed start. The display shows the expected end of the programme

2. Touch button **6**, the appliance starts the countdown of the delay start.
When the countdown is completed, the programme starts automatically.



Before you touch button **6** to start the appliance, you can cancel or change the set of the delay start.



You cannot set the delay start with the **Steam** programme.

STARTING A PROGRAMME

1. Touch button **6** to start the programme. The indicator of button **6** stops to flash and is on with red colour.

If a delayed start is set, the appliance starts the countdown.



The appliance adjust automatically the cycle time to the laundry you have put in the drum to have perfect washing results in the minimum necessary time. After approximately 15 minutes from the start of the programme, the display shows the new time value.

1. Touch button **6**. The indicator flashes.
2. Change the function set.
3. Touch button **6** again. The washing programme continues.

OPEN THE DOOR

While a programme or the delay start operates, the appliance door is locked.

To open the appliance door:

1. Touch button **6**. The door lock symbol in the display goes off and a message tells you that the door is unlocked.
2. Open the appliance door.
3. Close the appliance door and touch button **6** again. The programme or the delay start continues.

INTERRUPT A PROGRAMME

1. Touch button **6**. The indicator flashes.
2. Touch button **6** again. The washing programme continues.

CANCEL A PROGRAMME

1. Press button **1** to cancel the programme and to deactivate the appliance.
2. Press button **1** again to activate the appliance. Now, you can set a new washing programme.



The appliance does not drain the water.



If the temperature and the level of the water is too high, the door lock symbol stays on. You cannot open the door. If necessary, do the following procedure to open the door:

1. Deactivate the appliance.
2. Wait for some minutes.
3. Make sure that no water is in the drum.



If you deactivate the appliance, it is necessary to set the programme again.

CHANGE A FUNCTION

You can change only some functions before they operate.

AT THE END OF PROGRAMME

1. The appliance stops automatically.
2. The acoustic signals operate, if it is active.
3. In the display goes on and the message tells you that the programme is completed.

4. The indicator of button **6** goes off.
5. The door lock symbol goes off.
6. Press button **1** to deactivate the appliance. After five minutes from the end of the programme, the AUTO OFF function automatically deactivates the appliance.



When you activate the appliance again, the display shows the end of the last set programme. Turn the programme knob to set a new cycle.

7. Remove the laundry from the appliance. Make sure that the drum is empty.
8. Keep the door ajar, to prevent mildew and odours.
9. Close the water tap.

The washing programme is completed, but there is water in the drum:

- The drum turns regularly to prevent the creases in the laundry.

- The door stays locked.
- You must drain the water to open the door.

To drain the water:

1. If necessary, decrease the spin speed.
2. Touch button **6**. The appliance drains the water and spins.
3. When the programme is completed and the door lock symbol goes off, you can open the door
4. Press button **1** to deactivate the appliance.



The appliance drain and spin automatically after approximately 18 hours.

HELPFUL HINTS AND TIPS

THE LAUNDRY LOAD

- Divide the laundry in: white, coloured, synthetics, delicates and wool.
- Obey the washing instructions that are on the laundry care labels.
- Do not wash together white and coloured items.
- Some coloured items can discolour with the first wash. We recommend that you wash them separately for the first times.
- Button up pillowcases, close zippers, hooks and poppers. Tie up belts.
- Empty the pockets and unfold the items.
- Turn inside out multilayered fabrics, wool and items with painted illustrations.
- Remove hard stains.
- Wash with a special detergent heavy soil stains.

- Be careful with the curtains. Remove the hooks or put the curtains in a washing bag or pillowcase.
- Do not wash in the appliance :
 - Laundry without hems or with cuts
 - Underwired bras.
 - Use a washing bag to wash small items.
- A very small load can cause balance problems with the spin phase. If this occurs, adjust manually the items in the tub and start the spin phase again.

STUBBORN STAINS

For some stains, water and detergent is not sufficient.

We recommend that you remove these stains before you put the items in the appliance.

Special stain removers are available. Use the special stain remover that is applicable to the type of stain and fabric.

DETERGENTS AND ADDITIVES

- Only use detergents and additives specially made for washing machines.
- Do not mix different types of detergents.
- To help the environment, do not use more than the correct quantity of detergent.
- Obey the instructions that you find on the on packaging of these products.
- Use the correct products for the type and colour of the fabric, the programme temperature and the level of soil.
- If you use liquid detergents, do not set the prewash phase.
- If your appliance has not the detergent dispenser with the flap device, add the liquid detergents with a dosing ball.

WATER HARDNESS

If the water hardness in your area is high or moderate, we recommend that you use a water softener for washing machines. In areas where the water hardness is soft it is not necessary to use a water softener.

To know the water hardness in your area, contact your local water authority. Obey the instructions that you find on the packaging of the products. Equivalent scales measure the water hardness:

- German degrees (°dH).
- French degrees (°TH).
- mmol/l (millimol for each litre - international unit for the hardness of water).
- Clarke degrees.

Water hardness table

Level	Type	Water hardness			
		°dH	°T.H.	mmol/l	Clarke
1	soft	0-7	0-15	0-1.5	0-9
2	medium	8-14	16-25	1.6-2.5	10-16
3	hard	15-21	26-37	2.6-3.7	17-25
4	very hard	> 21	> 37	>3.7	>25

CARE AND CLEANING



WARNING!

Disconnect the appliance from the mains supply before you clean it.

DESCALING

The water we use contains limescale. If it becomes necessary, use a water softener to remove limescales.

Use a special product made for washing machines. Obey the instructions that you find on the packaging of the manufacturer.

Do this separately from the laundry wash.

EXTERNAL CLEANING

Clean the appliance only with soap and warm water. Fully dry all the surfaces.



CAUTION!

Do not use alcohol, solvents or chemical products.

MAINTENANCE WASH

With the low temperature programmes it is possible that some detergent stays in the drum. Make regularly a maintenance wash. To do this:

- Empty the laundry from the drum.

- Set the hottest cotton wash programme
- Use a correct quantity of powder detergent with biological properties.

After each wash, keep the door open for a while to prevent mould and to let unpleasant smells go out.

DOOR SEAL

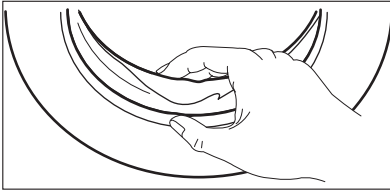

Regularly examine the seal and remove all objects from the inner part.

DRUM

Regularly examine the drum to prevent limescale and rust particles. Only use special products to remove rust particles from the drum. To do this:

- Clean the drum with special product for stainless steel.
- Start a short programme for cotton at the maximum temperature with a small quantity of detergent.

DETERGENT DISPENSER

To clean the dispenser:

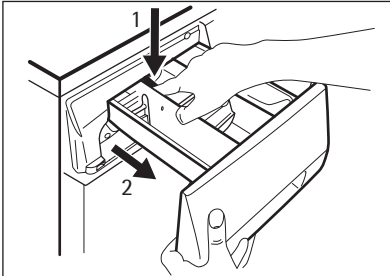

1. Press the lever.
2. Pull the dispenser out.

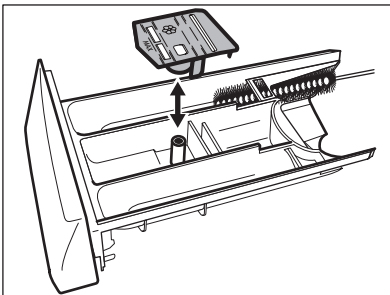

3. Remove the top part of the liquid additive compartment.
4. Clean all the parts with water.

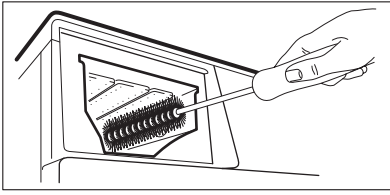

5. Clean the dispenser recess with a brush.
6. Put back the dispenser in the recess.

DRAIN PUMP



Regularly examine the drain pump and make sure that it is clean.

Clean the pump if:

- The appliance does not drain the water.
- The drum cannot turn.
- The appliance makes an unusual noise because of the blockage of the drain pump.
- The display shows an alarm code because of the problem with water drain.



WARNING!

1. Disconnect the mains plug from the mains socket.
2. Do not remove the filter while the appliance operates. Do not clean the drain pump if the water in the appliance is hot. The water must be cold before you clean the drain pump.

To clean the drain pump:

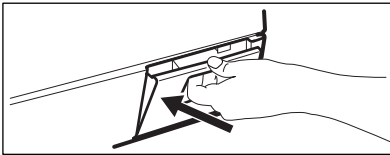

1. Open the drain pump door.

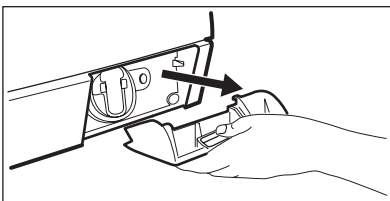

2. Pull the flap out to remove it.

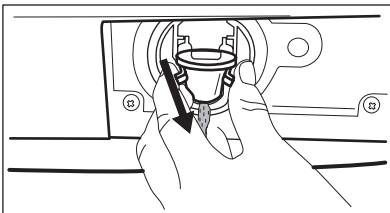

3. Put a container below the recess of the drain pump to collect the water that flows out.
4. Press the two levers and pull forward the drainage duct to let the water flow out.

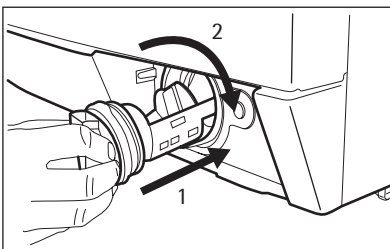
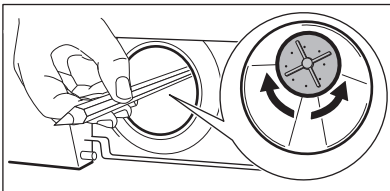
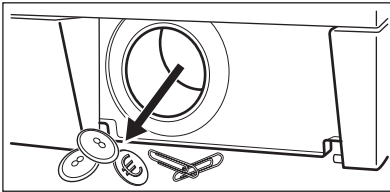
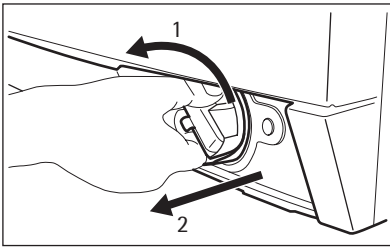

5. When the container is full of water, put the drainage duct back again and empty the container. Do steps 4 and 5 again and again until no more water flows out from the drain pump.
6. Pull back the drainage duct and turn the filter to remove it.
7. Remove fluff and objects from the pump.
8. Make sure that the impeller of the pump can turn. If this does not occur, contact the service centre.
9. Clean the filter under the water tap and put it back in the pump into the special guides.
10. Make sure that you tighten correctly the filter to prevent leakages.
11. Put the flap back and close the drain pump door.

THE INLET HOSE FILTER AND THE VALVE FILTER

It could be necessary to clean the filters when:

- The appliance does not fill with water.
- The appliance fills with the water for a long time.

- The indicator of button **6** flashes and the display shows the related alarm. Refer to 'Trouble shooter and service'.



WARNING!

Disconnect the mains plug from the mains socket.

To clean the water inlet filters:

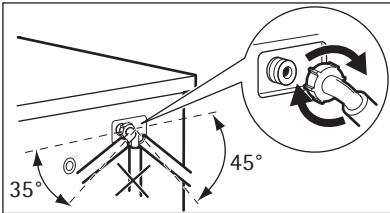
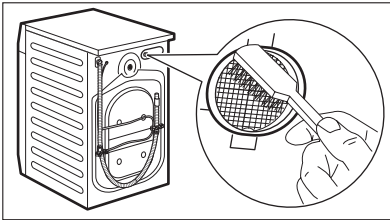
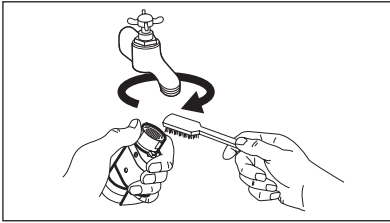

1. Close the water tap.
2. Remove the water inlet hose from the water tap.
3. Clean the filter in the inlet hose with a stiff brush.
4. Remove the inlet hose behind the appliance.
5. Clean the filter in the valve with a stiff brush or a towel.
6. Install again the inlet hose. Make sure that the couplings are tight to prevent leakages.
7. Open the water tap.

EMERGENCY DRAIN

Because of a malfunction, the appliance cannot drain the water.

If this occurs, do steps (1) through (6) of 'To clean the drain pump'.

If necessary, clean the pump.

Put the drainage duct back and close the drain pump flap.

When you drain the water with the emergency drain procedure, you must activate again the drain system:

1. Put 2 litres of water in the main wash compartment of the detergent dispenser.
2. Start the programme to drain the water.

FROST PRECAUTIONS

If the appliance is installed in an area where the temperature can be less than

0 °C, remove the remaining water from the inlet hose and the drain pump.

1. Disconnect the mains plug from the mains socket.
2. Close the water tap.
3. Remove the water inlet hose
4. Put the two ends of the inlet hose in a container and let the water flow out of the hose.
5. Empty the drain pump. Refer to the emergency drain procedure
6. When the drain pump is empty, install the inlet hose again.



WARNING!

Make sure that the temperature is more than 0 °C before you use the appliance again. The manufacturer is not responsible for damages caused by low temperatures.

TROUBLESHOOTING

The start of the appliance does not occur or it stops during operation.

Try to find a solution to the problem before you contact the service centre (refer to the table).

With some problems, the acoustic signals operate and the display shows an alarm message.



WARNING!

Deactivate the appliance before you do the checks.

Problem	Possible cause	Possible solution
The display tells to check the tap: the appliance does not fill with water.	The water tap is closed.	Open the water tap.
	The water inlet hose is damaged.	Make sure that the water inlet hose has no damages.
	The filters in the water inlet hose is blocked .	Clean the filters. Refer to 'Care and cleaning'.
	The connection of the water inlet hose is not correct.	Make sure that the connection is correct.
	The water pressure is too low.	Contact your local water authority.
	The water tap is blocked or is furred with lime-scale.	Clean the water tap.
The display tells to check the drain filter: the appliance does not drain the water.	The water drain hose is damaged.	Make sure that the water drain hose has no damages.
	The filter of the drain pump is blocked.	Clean the filter of the drain pump. Refer to 'Care and cleaning'.
	The connection of the water drain hose is not correct.	Make sure that the connection is correct.
The display tells to check the door.	The appliance door is open or not closed correctly.	Close the door correctly.
The display tells there is a water alert.	The anti-flood device is activated.	<ul style="list-style-type: none"> • Disconnect the appliance. • Close the water tap. • Contact the service centre.

PROBLEM WITHOUT ALARM MESSAGE

Problem	Possible cause	Possible solution
The appliance does not drain the water.	A washing programme without the drain phase is set.	Set the drain programme.
	The function Rinse Hold is on.	Set the drain programme.
The spin phase does not operate.	The spin phase is off.	Set the spin programme.
	The filter of the drain pump is blocked.	Clean the filter of the drain pump. Refer to 'Care and cleaning'.
	Balance problems with the laundry load.	Adjust manually the items in the tub and start the spin phase again.
The programme does not start.	The mains plug is not connected in the mains socket.	Put in the mains plug.
	Blow out fuse in the household fuse box.	Replace the fuse.
	You did not touch button 6 .	Touch button 6 .
	The delay start is set.	If necessary to wash the laundry immediately, cancel the delay start.
	The Child Lock function is activated.	Deactivate the Child Lock function.
There is water on the floor.	Leakages from the couplings of the water hoses.	Make sure that the couplings are tight.
	Leakages from the drain pump.	Make sure that the drain pump filter is tight.
	The water drain hose is damaged.	Make sure that the water inlet hose has no damages.
You cannot open the appliance door.	The washing programme is in operation.	Let the washing programme end.
	There is water in the drum.	Set the drain or the spin programme.
The appliance makes an unusual noise.	Incorrect level of the appliance.	Adjust the level of the appliance. Refer to 'Installation'.

Problem	Possible cause	Possible solution
	You did not remove the packaging and/or the transit bolts.	Remove the packaging and/or the transit bolts. Refer to 'Installation'.
	The load is very small.	Add more laundry in the drum.
The appliance fills with water and drain immediately.	The end of the drain hose is too low.	Make sure that the drain hose is in the correct position.
The washing results are not satisfactory.	The detergent you used was not sufficient or correct.	Increase the detergent quantity or use a different one.
	You did not remove the stubborn stains before you wash the laundry.	Use special products to remove the stubborn stains.
	You set a not correct temperature.	Make sure that you set the correct temperature.
	Too much laundry load.	Decrease the laundry load.
The internal lamp is off.	The lamp is burned.	To replace the lamp, contact the service centre.
After a steam programme, garments are partially wet.	The appliance is not accurately levelled.	Check the levelling and adjust the appliance by raising or lowering the feet.
After a steam programme, garments are not sufficiently smooth.	A wrong STEAM programme has been selected (e.g. Synthetic instead of Cotton).	Note the composition of the fabric.
	Excessive laundry load.	Reduce the laundry load
The drum is empty and the display shows there is some weight in .	It is necessary to set a tare.	Press button 1 to deactivate the appliance and to activate it again.
The drum is full but the display shows 0.0 kg.	You loaded the laundry before to activate the appliance.	Press button 1 to deactivate the appliance . Empty the drum and obey to the necessary steps. (Refer to 'Loading the laundry')

After the check, activate the appliance. The programme continues from the point of interruption. If the problem occurs again, contact the service centre.

If the display shows other alarm message, contact the service centre.

INSTALLATION

UNPACKING

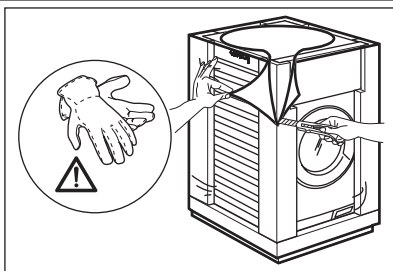

1. Use the gloves. Remove the external film. If necessary, use a cutter.

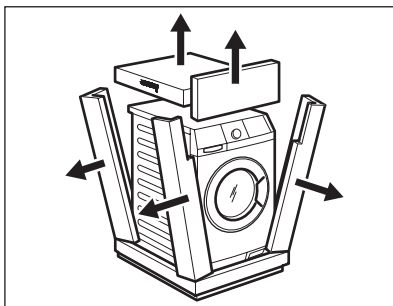

2. Remove the cardboard top.
3. Remove the polystyrene packaging materials.

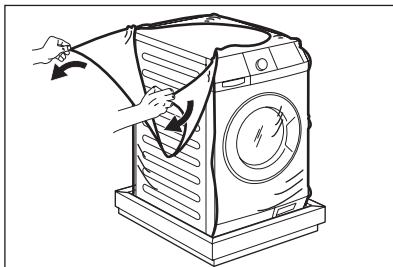

4. Remove the internal film.

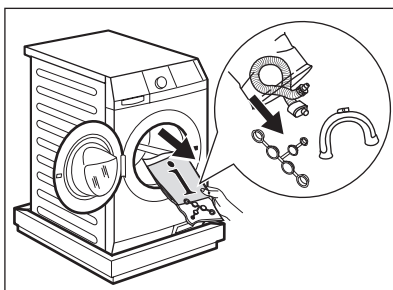

5. Open the door. Remove the polystyrene piece from the door seal and all the items from the drum.

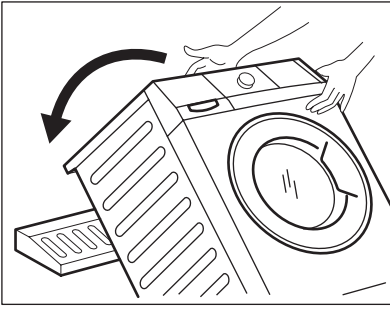

6. Put the front piece on the floor behind the appliance. Carefully put down the appliance with the rear side on it. Make sure not to damage the hoses.

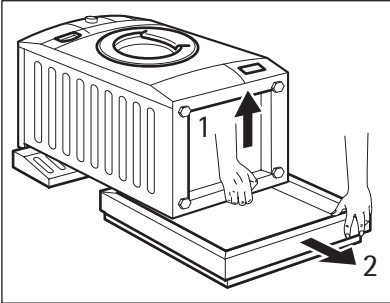

7. Remove the polystyrene protection from the bottom.
8. Pull up the appliance in vertical position.

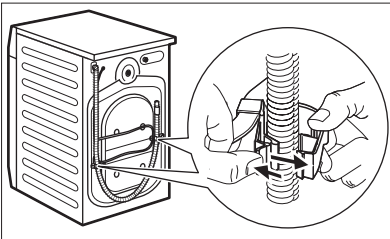

9. Remove the power supply cable and the drain hose from the hose holders.

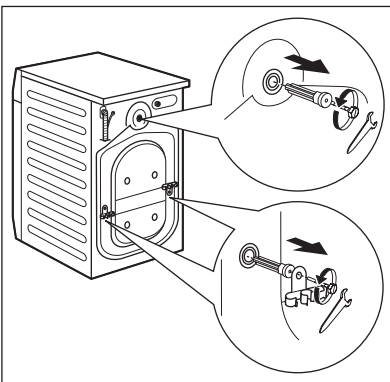

10. Remove the three bolts. Use the key supplied with the appliance.
11. Pull out the plastic spacers.

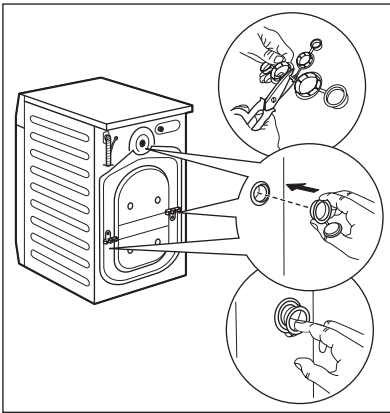

12. Replace the plastic spacers with the plastic caps. You can find these caps in the user manual bag.



WARNING!

Remove all the packaging and the transit bolts before you install the appliance.



We recommend that you keep the packaging and the transit bolts for when you move the appliance.

POSITIONING AND LEVELLING

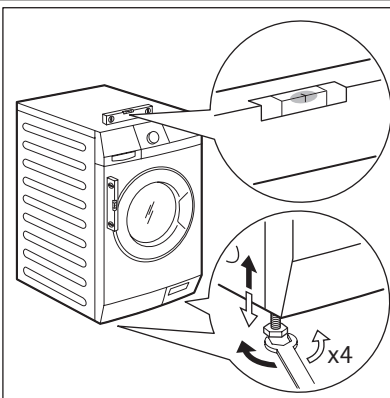

- Install the appliance on a flat hard floor.
- Make sure that carpets do not stop the air circulation below the appliance.
- Make sure that the appliance does not touch the wall or other units
- Loosen or tighten the feet to adjust the level. A correct adjustment of the appliance level prevents the vibration, noise and the movement of the appliance when in operation.

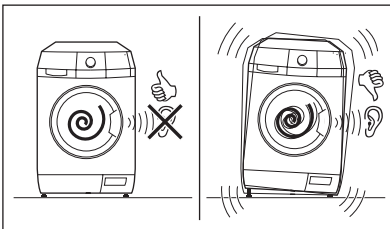

- The appliance must be level and stable.



CAUTION!

Do not put cardboard, wood or equivalent materials below the appliance feet to adjust the level.

THE INLET HOSE

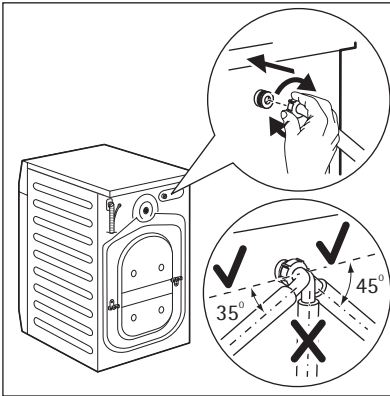

- Connect the hose to the appliance. Turn the inlet hose only left or right. Loose the ring nut to set it in the correct position.

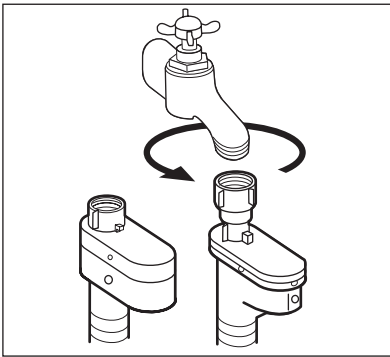

- Connect the water inlet hose to the cold water tap with 3/4 thread.



CAUTION!

Make sure that there are no leaks from the couplings.



Do not use an extension hose if the inlet hose is too short. Contact the service centre for the replacement of the inlet hose.

Water-stop device

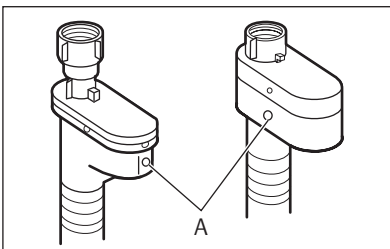

The inlet hose has a water stop device. This device prevents water leaks in the hose because of its natural ageing. The red sector in the window «A» shows this fault.

If this occur, close the water tap and contact the service centre to replace the hose.

WATER DRAINAGE

There are different procedures to connect the drain hose:

With the plastic hose guide.

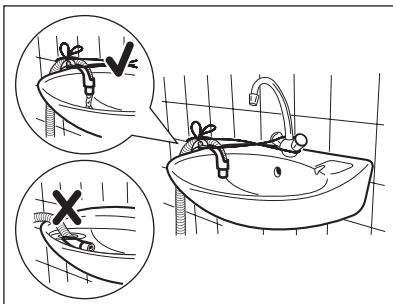
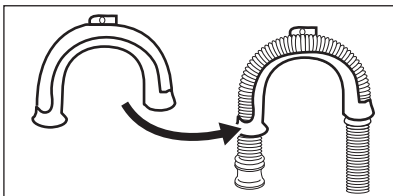

- On the edge of a sink.
- Make sure that the plastic guide cannot move when the appliance drains. Attach the guide to the water tap or the wall.

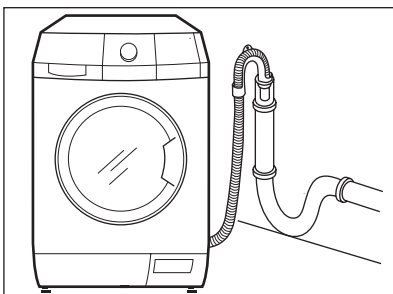

- To a stand pipe with vent-hole.
Refer to the illustration. Directly into a drain pipe at a height of not less than 60 cm and not more than 100 cm. The end of the drain hose must always be ventilated, i.e. the inner diameter of the drainpipe must be larger than the external diameter of the drain hose.

Without the plastic hose guide.

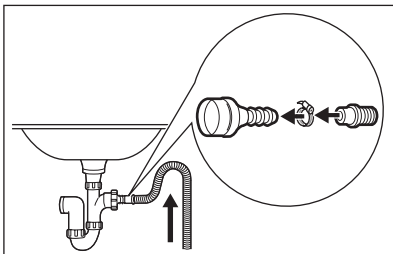

- To a sink spigot.
Refer to the illustration. Put the drain hose in the spigot and tighten it with a clip. Make sure that the drain hose makes a loop to prevent that remaining particles go in the appliance from the sink.

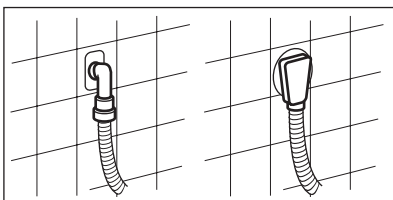

- Directly to a built-in drain pipe in the room wall and tighten it with a clip.



You can extend the drain hose to maximum 400 mm. Contact the service centre for the other drain hose and the extension.



Free Manuals Download Website

<http://myh66.com>

<http://usermanuals.us>

<http://www.somanuals.com>

<http://www.4manuals.cc>

<http://www.manual-lib.com>

<http://www.404manual.com>

<http://www.luxmanual.com>

<http://aubethermostatmanual.com>

Golf course search by state

<http://golfingnear.com>

Email search by domain

<http://emailbydomain.com>

Auto manuals search

<http://auto.somanuals.com>

TV manuals search

<http://tv.somanuals.com>