



User Manual

AIMB-210

**Intel® Atom™ processor N270
1.6 GHz
FSB 533 MHz Mini-ITX
Motherboard with VGA, LVDS,
TV-Out, 6 COM, Dual GbE,
8 USB, 2 SATA II**

Trusted ePlatform Services

ADVANTECH

Copyright

The documentation and the software included with this product are copyrighted 2009 by Advantech Co., Ltd. All rights are reserved. Advantech Co., Ltd. reserves the right to make improvements in the products described in this manual at any time without notice. No part of this manual may be reproduced, copied, translated or transmitted in any form or by any means without the prior written permission of Advantech Co., Ltd. Information provided in this manual is intended to be accurate and reliable. However, Advantech Co., Ltd. assumes no responsibility for its use, nor for any infringements of the rights of third parties, which may result from its use.

Acknowledgements

AWARD is a trademark of Phoenix Technologies Ltd.

IBM and PC are trademarks of International Business Machines Corporation.

Intel® Atom™ N270 is trademark of Intel Corporation

WinBond is a trademark of Winbond Corporation.

All other product names or trademarks are properties of their respective owners.

Part No. 2006021001

Printed in Taiwan

Edition 2

April 2009

A Message to the Customer

Advantech Customer Services

Each and every Advantech product is built to the most exacting specifications to ensure reliable performance in the harsh and demanding conditions typical of industrial environments. Whether your new Advantech equipment is destined for the laboratory or the factory floor, you can be assured that your product will provide the reliability and ease of operation for which the name Advantech has come to be known.

Your satisfaction is our primary concern. Here is a guide to Advantech's customer services. To ensure you get the full benefit of our services, please follow the instructions below carefully.

Technical Support

We want you to get the maximum performance from your products. So if you run into technical difficulties, we are here to help. For the most frequently asked questions, you can easily find answers in your product documentation. These answers are normally a lot more detailed than the ones we can give over the phone.

So please consult this manual first. If you still cannot find the answer, gather all the information or questions that apply to your problem, and with the product close at hand, call your dealer. Our dealers are well trained and ready to give you the support you need to get the most from your Advantech products. In fact, most problems reported are minor and are able to be easily solved over the phone.

In addition, free technical support is available from Advantech engineers every business day. We are always ready to give advice on application requirements or specific information on the installation and operation of any of our products.

Declaration of Conformity

FCC

This device complies with the requirements in part 15 of the FCC rules:

Operation is subject to the following two conditions:

- This device may not cause harmful interference
- This device must accept any interference received, including interference that may cause undesired operation.

This equipment has been tested and found to comply with the limits for a Class A digital device, pursuant to Part 15 of the FCC Rules. These limits are designed to provide reasonable protection against harmful interference when the equipment is operated in a commercial environment. This equipment generates, uses, and can radiate radio frequency energy and, if not installed and used in accordance with the instruction manual, may cause harmful interference to radio communications. Operation of this device in a residential area is likely to cause harmful interference in which case the user will be required to correct the interference at his/her own expense. The user is advised that any equipment changes or modifications not expressly approved by the party responsible for compliance would void the compliance to FCC regulations and therefore, the user's authority to operate the equipment.

Caution! *There is a danger of a new battery exploding if it is incorrectly installed. Do not attempt to recharge, force open, or heat the battery. Replace the battery only with the same or equivalent type recommended by the manufacturer. Discard used batteries according to the manufacturer's instructions.*



Memory Compatibility

Brand	Size	Speed	Vendor PN	Advantech PN	Memory
Transcend (RoHS)	256 MB	DDR2 667	TS32MSQ64V	NA	Hynix HY5PS121621B FP-Y5 (32x16)
	512 MB	DDR2 667	TS6QSJ23002-6S	96SD2-512M667NN- TR	SAMSUNG K4T51083QC ZCE6 (64x8)
	1 GB	DDR2 667	TS128MSQ64V6J	NA	SAMSUNG K4T51083QC ZCE6 (64x8)
	2 GB	DDR2 667	TS5QSU21640-6S	96SD2-2G667NN- TR1	Micron D9HNL (128x8)
Apacer (RoHS)	512 MB	DDR2 667	76.9325G.B17	96SD2I-512M667- AP	ELPIDA E5108AG-6E- E (64x8)
	1 GB	DDR2 667	76.0325G.B18	96SD2I-1G667-AP	ELPIDA E5108AGBG- 6E-E (64x8)
DSL (RoHS)	256 MB	DDR2 667	NA	NA	ELPIDA E5116AF-6E- E (32x16)
	512 MB	DDR2 667	NA	NA	ELPIDA E5108AGBG- 6E-E (64x8)
	1 GB	DDR2 667	NA	NA	ELPIDA E5108AGBG- 6E-E (64x8)
	2 GB	DDR2 667	NA	NA	ELPIDA E1108ACSE- 6E-E (128x8)
Transcend (RoHS)	1 GB	DDR2 800	TS2QSU23003-5E	96SD2-1G800NN- TR	HYNIX HY5PS12821E-FP-S5 (64x8)
DSL (RoHS)	1 GB	DDR2 800	NA	NA	ELPIDA TWN E5108AHSE-8E-E (64x8)
	2 GB	DDR2 800	NA	NA	ELPIDA JPN E1108ACSE-8E-E (128x8)
Transcend	256 MB	DDR2 533	TS32MSQ64V	NA	Hynix HY5PS121621B FP-Y5 (32x16)
	512 MB	DDR2 533	TS64MSQ64V5J	96SD2-512M533NN- TR	Infineon HYB18T512 800AF37 SVV39006 0526 (32x8)
	2 GB	DDR2 533	TS5QSU21640-6S	96SD2-2G667NN- TR1	Micron D9HNL (128x8)
Apacer	256 MB	DDR2 533	78.82054.420	NA	ELPIDA JAPAN E5116AB-E 05050WPWA (64x8)
	512MB	DDR2 533	76.8325G.116	96SD2-512M533NN- AP	ELPIDA JAPAN E5108AB-E 04520WR5Q (64x8)
	1GB	DDR2 533	78.02G71.422	96SD2-1G533NN- AP	ELPIDA TWN E5108AE-E (64x8)

Ordering Information

AIMB-210 Ordering Information

Part Number	On-board Processor	Chipset	Memory	LAN	COM	DVI	LVDS	TPM
AIMB-210G2-S6A1E	ATOM N270 1.6 GHz	945GSE	DDR2 533	2	6	None	Single	None
AIMB-210F-S6A1E*	ATOM N270 1.6 GHz	945GSE	DDR2 533	2	6	None	Dual	Yes

* Minimum order quantity is required

Product Warranty (2 years)

Advantech warrants to you, the original purchaser, that each of its products will be free from defects in materials and workmanship for two years from the date of purchase.

This warranty does not apply to any products which have been repaired or altered by persons other than repair personnel authorized by Advantech, or which have been subject to misuse, abuse, accident or improper installation. Advantech assumes no liability under the terms of this warranty as a consequence of such events.

Because of Advantech's high quality-control standards and rigorous testing, most of our customers never need to use our repair service. If an Advantech product is defective, it will be repaired or replaced at no charge during the warranty period. For out-of-warranty repairs, you will be billed according to the cost of replacement materials, service time and freight. Please consult your dealer for more details.

If you think you have a defective product, follow these steps:

1. Collect all the information about the problem encountered. (For example, CPU speed, Advantech products used, other hardware and software used, etc.) Note anything abnormal and list any onscreen messages you get when the problem occurs.
2. Call your dealer and describe the problem. Please have your manual, product, and any helpful information readily available.
3. If your product is diagnosed as defective, obtain an RMA (return merchandise authorization) number from your dealer. This allows us to process your return more quickly.
4. Carefully pack the defective product, a fully-completed Repair and Replacement Order Card and a photocopy proof of purchase date (such as your sales receipt) in a shippable container. A product returned without proof of the purchase date is not eligible for warranty service.
5. Write the RMA number visibly on the outside of the package and ship it prepaid to your dealer.

Initial Inspection

Before you begin installing your motherboard, please make sure that the following materials have been shipped:

- 1 x AIMB-210 ATOM N270 1.6 GHz Mini-ITX with VGA/LVDS/Dual GbE LAN
- 1 x IDE HDD cable
- 2 x SATA HDD cable
- 2 x SATA Power cable
- 3 x Serial port cable
- 1 x I/O port bracket
- 1 x Startup manual
- 1 x Driver CD
- 1 x Warranty card

If any of these items are missing or damaged, contact your distributor or sales representative immediately. We have carefully inspected the AIMB-210 mechanically and electrically before shipment. It should be free of marks and scratches and in perfect working order upon receipt. As you unpack the AIMB-210, check it for signs of shipping damage. (For example, damaged box, scratches, dents, etc.) If it is damaged or it fails to meet the specifications, notify our service department or your local sales representative immediately. Also notify the carrier. Retain the shipping carton and packing material for inspection by the carrier. After inspection, we will make arrangements to repair or replace the unit.

Contents

Chapter 1 General Information1

1.1	Introduction	2
1.2	Features	2
1.3	Specifications	3
1.3.1	System	3
1.3.2	Memory	3
1.3.3	Input/Output	3
1.3.4	Graphics.....	3
1.3.5	Ethernet LAN	3
1.3.6	Industrial features	4
1.3.7	Mechanical and environmental specifications.....	4
1.4	Jumpers and Connectors	4
	Table 1.1: Jumpers.....	4
	Table 1.2: Connectors	4
1.5	Board layout: Jumper and Connector Locations	6
	Figure 1.1 Jumper and Connector Location	6
	Figure 1.2 I/O Connectors	6
1.6	AIMB-210 Board Diagram	7
	Figure 1.3 AIMB-210 Board Diagram	7
1.7	Safety Precautions	8
1.8	Jumper Settings	9
1.8.1	How to Set Jumpers.....	9
1.8.2	CMOS Clear (CMOS1)	9
	Table 1.3: CMOS1	9
1.8.3	COM2 RS 232/422/485 Mode Selector (JSETCOM2).....	10
	Table 1.4: COM2 RS 232/422/485 Mode Selector (JSETCOM2).....	10
1.8.4	JLV1/JLV2: LCD Power 3.3 V/5 V Selector	10
	Table 1.5: JLV1/JLV2: LCD Power 3.3 V/5 V Selector.....	10
1.8.5	JPERSON1: ATX, AT Mode Selector	11
	Table 1.6: JPERSON1: ATX, AT Mode Selector.....	11
1.8.6	JWDT1: Watchdog Timer Output Option	11
	Table 1.7: JWDT1: Watchdog Timer Output Option.....	11
1.9	System Memory	12
1.10	Memory Installation Procedures.....	12

Chapter 2 Connecting Peripherals13

2.1	Introduction	14
2.2	Parallel Port (LPT1).....	14
2.3	Primary (IDE1) IDE Connector.....	15
2.4	USB Ports (LAN1_USB12/LAN2_USB34/USB56/USB78)	16
	Table 2.1: LAN LED Indicator.....	16
2.5	TV-Out Connector (TVOUT1)	17
	Table 2.2: TV-Out Connector (TVOUT1).....	17
2.6	VGA Connector (VGA1).....	18
2.7	Serial Ports (COM1~COM6)	19
2.8	PS/2 Keyboard and Mouse Connector (KBMS1)	20
2.9	CPU Fan Connector (CPU_FAN1).....	21
2.10	System FAN Connector (CHA_FAN1)	22
2.11	Front Panel Connectors (JFP1/JFP2/JFP3).....	23
2.11.1	ATX soft power switch (JFP1 / PWR_SW)	23
2.11.2	Reset (JFP1 / RESET).....	23
2.11.3	HDD LED (JFP2 / HDDLED).....	23

2.11.4	External speaker (JFP2 / SPEAKER).....	23
2.11.5	Power LED and keyboard lock connector (JFP3 / PWR_LED & KEY LOCK)	24
	Table 2.3: ATX power supply LED status (No support for AT power).....	24
2.12	Line In, Line Out, Mic In Connector (AUDIO1).....	25
2.13	Serial ATA Interface (SATA1, SATA2).....	26
2.14	PCI	27
2.15	Front Headphone Connector (FPAUD1).....	28
2.16	ATX Power Connector (EATXPWR1).....	29
2.17	SPI Flash connector(SPI_CN1)	30
2.18	LCD Inverter Connector INV1 & INV2 (Optional).....	31
2.19	LVDS Connector LVDS1 & LVDS2 (Optional).....	32
2.20	Digital I/O Connector (DIO1).....	33

Chapter 3 BIOS Operation 35

3.1	Introduction	36
3.2	BIOS Setup	36
3.2.1	Main Menu	37
3.2.2	Standard CMOS Features	38
3.2.3	Advanced BIOS Features	39
3.2.4	Advanced Chipset Features	40
3.2.5	Integrated Peripherals	42
3.2.6	USB Device Setting	44
3.2.7	Security Chip Configuration (Optional Item)	45
3.2.8	TPM Support.....	45
3.2.9	Power Management Setup	46
3.2.10	PnP/PCI Configurations.....	48
3.2.11	PC Health Status	49
3.2.12	Frequency/Voltage Control	49
3.2.13	Load Setup Defaults	50
3.2.14	Set Password.....	50
3.2.15	Save & Exit Setup.....	52
3.2.16	Quit without Saving.....	52

Chapter 4 Chipset Software Installation Utility 53

4.1	Before You Begin.....	54
4.2	Introduction	54
4.3	Windows XP Driver Setup.....	55

Chapter 5 VGA Setup 57

5.1	Introduction	58
5.2	Windows Vista/XP/2000.....	58

Chapter 6 LAN Configuration 59

6.1	Introduction	60
6.2	Features.....	60
6.3	Installation.....	60
6.4	Win XP/Vista Driver Setup (Realtek RTL8111C).....	60

Appendix A Programming the Watchdog Timer..61

A.1	Programming the Watchdog Timer	62
A.1.1	Watchdog Timer Overview.....	62
A.1.2	Programming the Watchdog Timer	62
	Table A.1: Watchdog Timer Registers	64
A.1.3	Example Program	65

Appendix B I/O Pin Assignments.....69

B.1	Parallel Port (LPT1).....	70
	Table B.1: Parallel Port (LPT1).....	70
B.2	USB Header (USB56, USB78).....	70
	Table B.2: USB Header (USB56).....	70
B.3	VGA Connector (VGA1).....	71
	Table B.3: VGA Connector (VGA1)	71
B.4	RS-232 Interface	71
	Table B.4: RS-232 Interface (COM1~COM4)	71
B.5	RS-232/422/485 Setting Interface (JETCOM2).....	72
	Table B.5: RS-232/422/485 Setting Interface (JETCOM2)	72
B.6	SPI_CN1: SPI Fresh Card Pin Connector.....	72
	Table B.6: SPI_CN1:SPI Fresh Card Pin Connector	72
B.7	PS/2 Keyboard and Mouse Connector (KBMS1).....	73
	Table B.7: PS/2 Keyboard and Mouse Connector (KBMS1)	73
B.8	CPU Fan Power Connector (CPU_FAN1)	73
	Table B.8: CPU Fan Power Connector (CPU_FAN1).....	73
B.9	System Fan Power Connector (CHA_FAN1)	74
	Table B.9: System Fan Power Connector (SYSFAN1/SYSFAN2)	74
B.10	Power LED & Keyboard Lock Connector (JFP3)	74
	Table B.10:Power LED & Keyboard Lock Connector (JFP3).....	74
B.11	HDD LED and External Speaker Connector (JFP2/HDD LED and SPEAKER).....	75
	Table B.11:External Speaker Connector (JFP2/SPEAKER).....	75
B.12	ATX Soft Power Switch and Reset Connector (JFP1/ PWR-SW and RESET)	75
	Table B.12:Reset Connector (JFP1/ RESET).....	75
B.13	ATX Power Connector (EATXPWR1)	76
	Table B.13:ATX Power Connector (ATX2)	76
B.14	USB/LAN ports (LAN1_USB12/LAN2_USB34).....	76
	Table B.14:USB Port.....	76
	Table B.15:Ethernet 10/100 Mbps RJ-45 Port	76
B.15	Line In, Line Out, Mic In Connector (AUDIO1).....	77
B.16	Serial ATA0/1 (SATA1/SATA2).....	77
	Table B.16:Serial ATA 0/1 (SATA1/SATA2)	77
B.17	AT/ATX Mode (PSON1)	77
	Table B.17:AT/ATX Mode (PSON1)	77
B.18	AC-97 Audio Interface (FPAUD1)	77
	Table B.18:AT/ATX Mode (PSON1)	77
B.19	GPIO Pin Header (GPIO1).....	78
	Table B.19:AT/ATX Mode (PSON1)	78
B.20	LVDS Connector: LVDS1 & LVDS2 (Optional)	79
	Table B.20:LVDS1 Connector (Optional).....	79
	Table B.21:LVDS2 Connector (Optional).....	80
B.21	LVDS Power Jumper (JLV1, JLV2).....	80
	Table B.22:LVDS Power Jumper	80
B.22	LVDS Invert: INV1 & INV2 (Optional).....	81
	Table B.23:LVDS Power Jumper	81
B.23	System I/O Ports	81

	Table B.24: System I/O Ports	81
B.24	DMA Channel Assignments	82
	Table B.25: DMA Channel Assignments	82
B.25	Interrupt Assignments	82
	Table B.26: Interrupt Assignments	82
B.26	1st MB Memory Map	82
	Table B.27: 1st MB Memory Map	82

Chapter 1

General Information

1.1 Introduction

The AIMB-210 is designed with the Intel® 945GSE and the ICH7M for industrial applications that require both performance computing and enhanced power management capabilities. The motherboard has on board CPU Intel® Atom™ N270 1.6GHz with 533 MHz front side bus and DDR2 533 MHz up to 2 GB.

The AIMB-210 offers cost-saving integrated graphics, built on the Intel® 945GSE chipset and features the unique Intel® Extreme Graphics architecture that maximizes VGA performance and shares system memory up to 224 MB.

Advantech AIMB-210 is designed with an Intel® 945GSE chipset and on board CPU Intel® ATOM™ N270 1.6GHz FSB 533 MHz processor. A rich I/O connectivity of 6 serial ports, 8 USB 2.0, Dual GbE LAN and 2 SATA ports.

1.2 Features

- **Cost effective 945GSE chipset:** supports 533 Front side bus
- **Rich I/O connectivity:** 6 serial ports, 8 USB 2.0, Dual GbE LAN
- **Standard Mini-ITX form factor with industrial feature:** The AIMB-210 is a full-featured Mini-ITX motherboard with balanced expandability and performance
- **Wide selection of storage devices:** IDE HDD, SATA HDD, CF, customers benefit from the flexibility of using the most suitable storage device for larger capacity
- **Optimized integrated graphic solution:** With Intel® Graphics Media Accelerator 950, supports versatile display options and 32-bit 3D graphics engine.

1.3 Specifications

1.3.1 System

- **CPU:** Intel® Atom™ N270 1.6 GHz FSB 533 MHz
- **BIOS:** Award SPI 16 Mbit BIOS
- **System chipset:** Intel® 945GSE with ICH7M
- **SATA hard disk drive interface:** Two on-board SATA connectors with data transmission rate up to 150 MB
- **IDE Interface:** One onboard IDE connector supporting up to two enhanced IDE devices. Supports PIO mode 4 (16.67 MB/s data transfer rate) and ATA 33/66/100 (33/66/100 MB/s data transfer rate) BIOS enabled/disabled
- **CF interface:** Supports compact flash Type II

1.3.2 Memory

- **RAM:** Up to 2 GB in 1 slots 200-pin SODIMM sockets. Supports single channel DDRII 533 SDRAM

1.3.3 Input/Output

- **PCI bus:** 1 PCI slot
- **Enhanced parallel port:** Configured to LPT1, with 25 pin box header. Supports EPP/SPP/ECP
- **Serial ports:** Six serial ports, COM2 is RS-232/422/485 and five of RS-232 serial ports
- **Keyboard and PS/2 mouse connector:** Two 6-pin mini-DIN connectors are located on the mounting bracket for easy connection to a PS/2 keyboard and mouse
- **USB port:** Supports up to eight USB 2.0 ports with transmission rate up to 480 Mbps, 4 on board pin header and 4 external ports)
- **GPIO connector:** 16-bit general purpose Input/Output

1.3.4 Graphics

- **Controller:** Chipset integrated VGA controller
- **Display memory:** Dynamically shared system memory up to 224 MB
- **CRT:** Up to 2048 x 1536 resolution, 400 MHz RAMDAC
- **LVDS1:** Supports single channel 18-bit/ dual channel 36-bit LVDS
- **LVDS2 (optional):** Supports single channel 18/24-bit/ dual channel 24/48-bit LVDS via Chronitel 7308B transmitter
- **TV-Out:** Support both S-video and composite video via cables (TV-out function is not supported during POST stage)

1.3.5 Ethernet LAN

- Supporting dual 10/100/1000 Mbps Ethernet port (s) via PCI Express x1 bus which provides 500 MB/s data transmission rate
- **Controller:** LAN: Realtek RTL8111C

1.3.6 Industrial features

- **Watchdog timer:** Can generate a system reset. The watchdog timer is programmable, with each unit equal to one second or one minute (255 levels)
- **TPM1.2(optional):** Infineon TPM chip SLB9635 TT 1.2 Module Onboard

1.3.7 Mechanical and environmental specifications

- **Operating temperature:** 0 ~ 60° C (32 ~ 140° F, Depending on CPU)
- **Storage temperature:** -20 ~ 70° C (-4 ~ 158° F)
- **Humidity:** 5 ~ 95% non-condensing
- **Power supply voltage:** +3.3 V, +5 V, +12 V, -12 V, 5 Vsb
- **Power consumption:**
+5 V @ 1.96 A, +3.3 V @ 1.21 A, +12 V @ 0.19 A, 5 VSB @ 0.28, -12 V @ 0.06 A. Measure the maximum current value which system under maximum load (CPU: Top speed, RAM & Graphic: Full loading)
- **Board size:** 170 mm x 170 mm (6.69" x 6.69")
- **Board weight:** 0.365 kg

1.4 Jumpers and Connectors

Connectors on the AIMB-210 motherboard link it to external devices such as hard disk drives and a keyboard. In addition, the board has a number of jumpers used to configure your system for your application.

The tables below list the function of each of the board jumpers and connectors. Later sections in this chapter give instructions on setting jumpers. Chapter 2 gives instructions for connecting external devices to your motherboard.

Table 1.1: Jumpers

Label	Function
CMOS1	CMOS clear
JPERSON1	AT/ATX mode selector
JSETCOM2	Serial port: RS232/RS422/RS485

Table 1.2: Connectors

Label	Functions
JFP1	Power Switch / Reset connector
JFP2	External speaker / SATA HDD LED connector / SM Bus connector
JFP3(Keyboard Lock and Power LED)	Power LED
	Suspend: Fast flash (ATX/ AT)
	System On: ON (ATX/ AT)
	System Off: OFF (AT)
CMOS1	System Off: Slow flash (ATX)
	CMOS clear (Default 1-2)
JSETCOM2	COM2 RS232/422/485 Jumper Setting
JLV1	LVDS1 LCD power 3.3V/5V selection Default (1-2, 3.3V)
JLV2	LVDS2 LCD power 3.3V/5V selection Default (1-2, 3.3V)
JPERSON1	AT(1-2) / ATX(2-3) (Default 2-3)
LPT1	parallel connector

USB56	USB port 5, 6 (on board)
USB78	USB port 7, 8 (on board)
VGA1	VGA connector
VGA2	TV-Out connector
COM12	Serial port: COM1 (RS232) and COM2 (RS232, RS422 and RS485)
COM3	Serial port: COM3 (RS232)
COM4	Serial port connector
COM5	Serial port connector
COM6	Serial port connector
KBMS1	PS/2 Keyboard and Mouse connector
CPUFAN1	CPU FAN connector(3-pin)
SYSFAN1	System FAN connector(3-pin)
LAN1_USB12	LAN1 / USB port 1, 2
LAN2_USB34	LAN2 / USB port 3, 4
CF1	CF Socket
AUDIO1	Audio connector
FPAUD1	HD Audio Front Panel Pin Header
GPIO1	GPIO Header
IDE1	IDE connector
EATXPWR1	ATX 20Pin Main power connector
INV1	LVDS1 Inverter Power
INV2	LVDS2 Inverter Power
LVDS1	LVDS1 connector (Internal)
LVDS2	LVDS2 connector (Internal)
PCI1	PCI Slot
SATA1	Serial ATA1
SATA2	Serial ATA2
DIMMA1	Memory connector channel
BAT1	Battery Connector
SPI_CN1	SPI flash update connector
JWDT1	Watchdog Reset
SPI1	SPI BIOS socket

1.5 Board layout: Jumper and Connector Locations

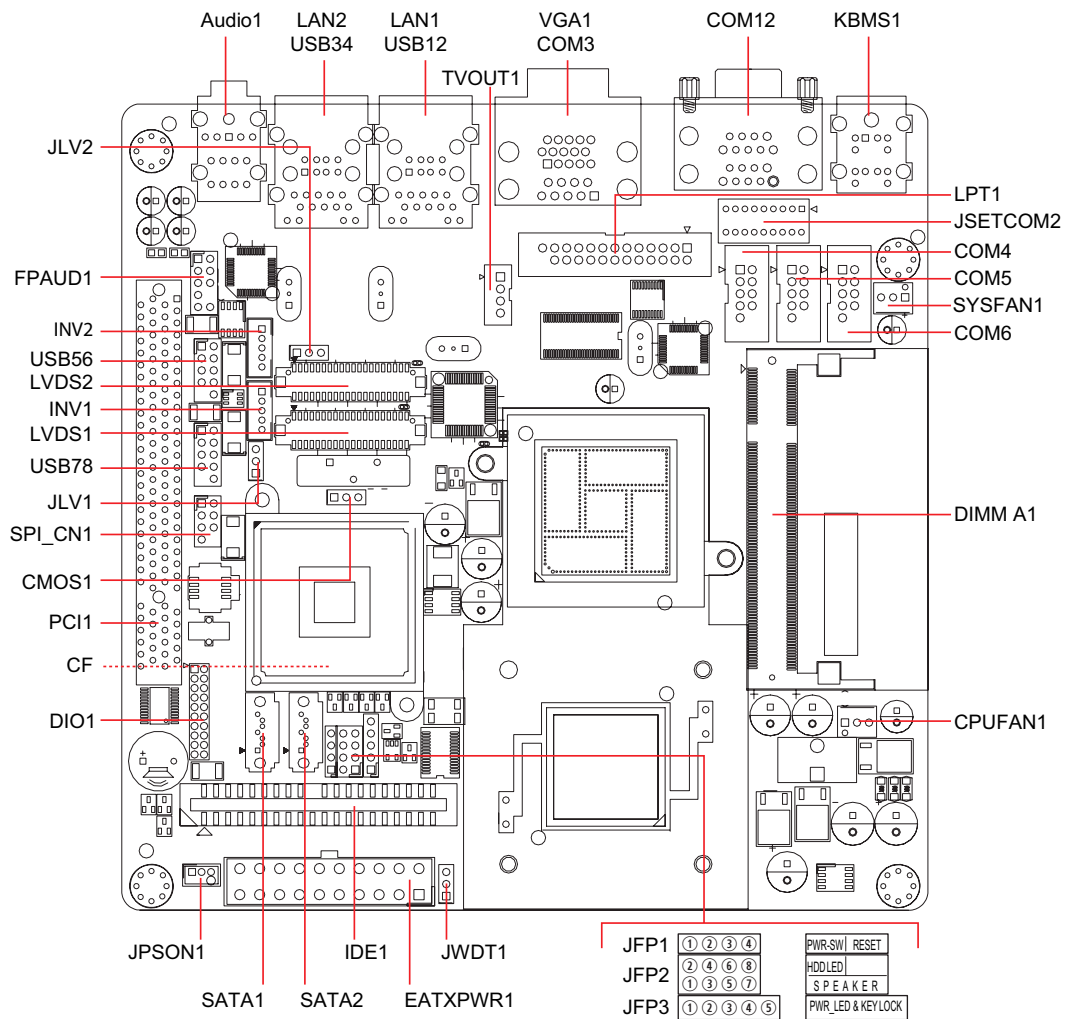

Figure 1.1 Jumper and Connector Location



Figure 1.2 I/O Connectors

1.6 AIMB-210 Board Diagram

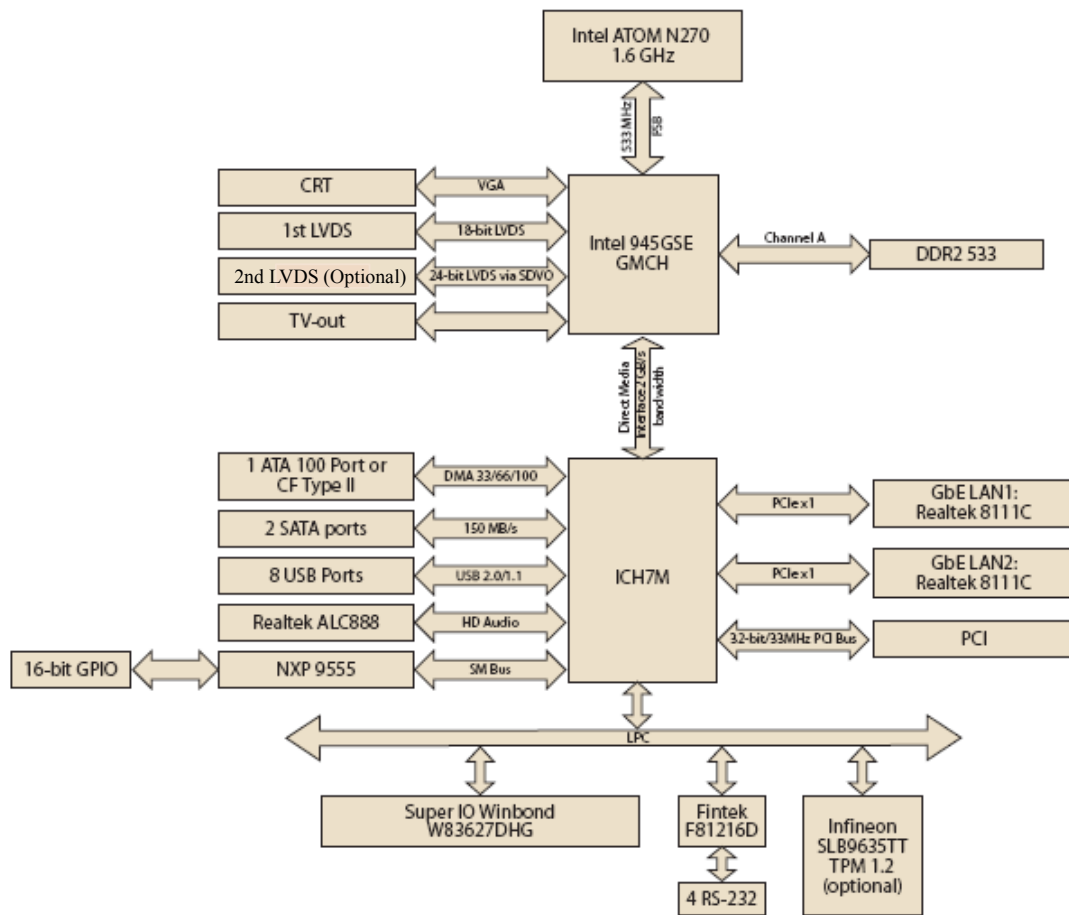

Figure 1.3 AIMB-210 Board Diagram

1.7 Safety Precautions

Warning! *Always completely disconnect the power cord from chassis whenever you work with the hardware. Do not make connections while the power is on. Sensitive electronic components can be damaged by sudden power surges. Only experienced electronics personnel should open the PC chassis.*



Caution! *Always ground yourself to remove any static charge before touching the motherboard. Modern electronic devices are very sensitive to electrostatic discharges. As a safety precaution, use a grounding wrist strap at all times. Place all electronic components on a static-dissipative surface or in a static-shielded bag when they are not in the chassis.*



Caution! *The computer is provided with a battery-powered real-time clock circuit. There is a danger of explosion if battery is incorrectly replaced. Replace only with same or equivalent type recommended by the manufacturer. Discard used batteries according to manufacturer's instructions.*



Caution! *There is a danger of a new battery exploding if it is incorrectly installed. Do not attempt to recharge, force open, or heat the battery. Replace the battery only with the same or equivalent type recommended by the manufacturer. Discard used batteries according to the manufacturer's instructions.*



1.8 Jumper Settings

This section provides instructions on how to configure your motherboard by setting the jumpers. It also includes the motherboards's default settings and your options for each jumper.



1.8.1 How to Set Jumpers

You can configure your motherboard to match the needs of your application by setting the jumpers. A jumper is a metal bridge that closes an electrical circuit. It consists of two metal pins and a small metal clip (often protected by a plastic cover) that slides over the pins to connect them. To “close” (or turn ON) a jumper, you connect the pins with the clip. To “open” (or turn OFF) a jumper, you remove the clip. Sometimes a jumper consists of a set of three pins, labeled 1, 2, and 3. In this case you connect either pins 1 and 2, or 2 and 3. A pair of needle-nose pliers may be useful when setting jumpers.

1.8.2 CMOS Clear (CMOS1)

The AIMB-210 motherboard contains a jumper that can erase CMOS data and reset the system BIOS information. Normally this jumper should be set with pins 1-2 closed. If you want to reset the CMOS data, set J1 to 2-3 closed for just a few seconds, and then move the jumper back to 1-2 closed. This procedure will reset the CMOS to its default setting.

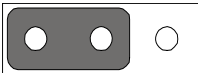
Table 1.3: CMOS1

Function	Jumper Setting
*Keep CMOS data	 1-2 closed
Clear CMOS data	 2-3 closed

* Default

1.8.3 COM2 RS 232/422/485 Mode Selector (JSETCOM2)

Users can use JSETCOM2 to select among RS 232/422/485 modes for COM2. The default setting is RS 232.

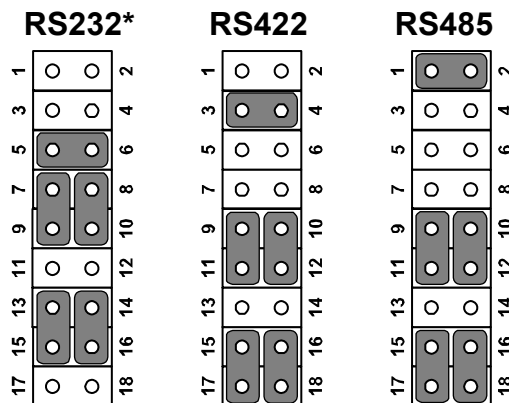

Table 1.4: COM2 RS 232/422/485 Mode Selector (JSETCOM2)

Function	Jumper Setting
*RS232	(5-6) + (7-9) + (8-10) + (13-15) + (14-16) closed
RS422	(3-4) + (9-11) + (10-12) + (15-17) + (16-18) closed
RS-485	(1-2) + (9-11) + (10-12) + (15-17) + (16-18) closed
*: Default	

1.8.4 JLV1/JLV2: LCD Power 3.3 V/5 V Selector

Table 1.5: JLV1/JLV2: LCD Power 3.3 V/5 V Selector

Closed Pins	Result
1-2*	3.3 V*
2-3	5 V

*Default

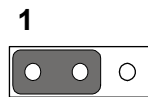

3.3 V
1-2 closed

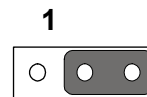

5 V
2-3 closed

1.8.5 JPSON1: ATX, AT Mode Selector

Table 1.6: JPSON1: ATX, AT Mode Selector

Closed Pins	Result
1-2	AT Mode
2-3*	ATX Mode

*Default

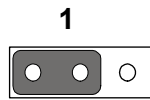

AT Mode
1-2 closed

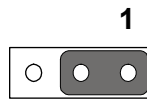

ATX Mode
2-3 closed

1.8.6 JWDT1: Watchdog Timer Output Option

Table 1.7: JWDT1: Watchdog Timer Output Option

Closed Pins	Result
1-2	NC
2-3*	System Reset*

*Default

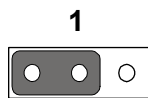

NC
1-2 closed

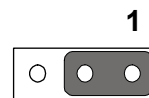

System Reset
2-3 closed

1.9 System Memory

The AIMB-210 has one socket for a 200-pin SODIMMx1.

All these sockets use 1.8 V unbuffered double data rate synchronous DRAMs (DDR SDRAM). They are available in capacities of 256, 512, and 1024 MB. The sockets can be filled in any combination with DIMMs of any size, giving a total memory size between 256 MB and 2 GB. AIMB-210 does NOT support ECC (error checking and correction).

1.10 Memory Installation Procedures

To install SODIMMs, first make sure the two handles of the SODIMM socket are in the “open” position, i.e., the handles lean outward. Slowly slide the SODIMM module along the plastic guides on both ends of the socket. Then press the SODIMM module well down into the socket, until you hear a click when the two handles have automatically locked the memory module into the correct position of the SODIMM socket. To remove the memory module, just push both handles outward, and the memory module will be ejected by the mechanism.

Chapter 2

Connecting Peripherals

2.1 Introduction

You can access most of the connectors from the top of the board as it is being installed in the chassis. If you have a number of cards installed or have a packed chassis, you may need to partially remove the card to make all the connections.

2.2 Parallel Port (LPT1)

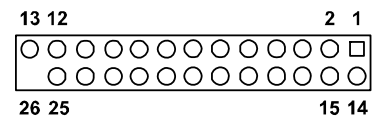
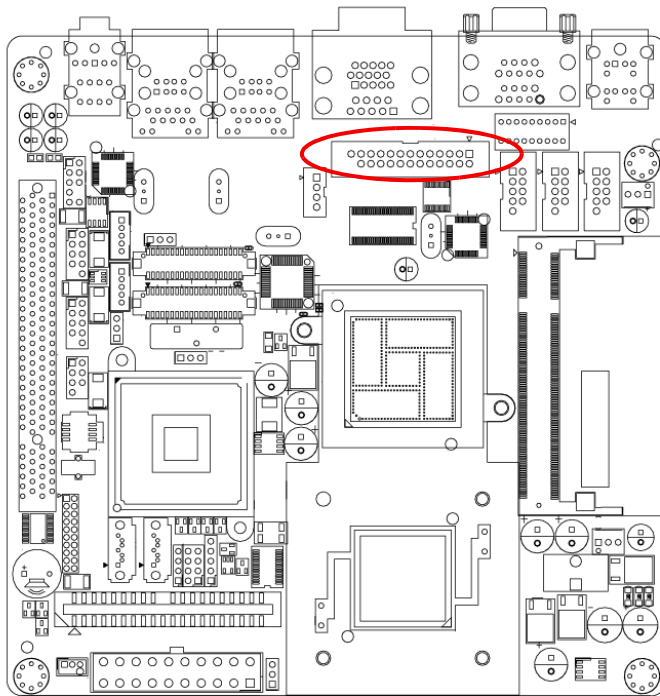

The parallel port is normally used to connect the motherboard to a printer. The AIMB-210 includes an onboard parallel port, accessed through a 25-pin flat-cable connector, LPT1.

Note! *Parallel cable is not enclosed in the box as a standard accessory. The order part number is 1700008809.*



2.3 Primary (IDE1) IDE Connector

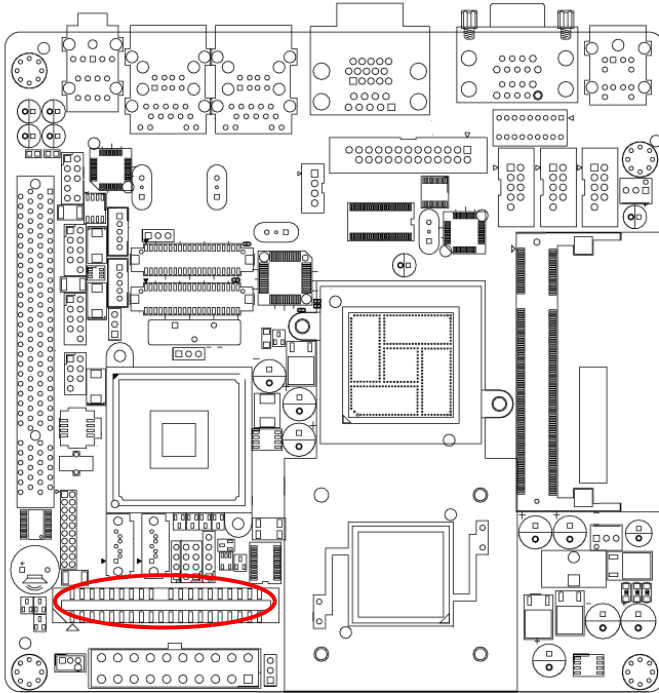

2.4 USB Ports (LAN1_USB12/LAN2_USB34/USB56/USB78)

The AIMB-210 provides up to eight ports of USB (Universal Serial Bus). The USB interface complies with USB Specification Rev. 2.0 supporting transmission rate up to 480 Mbps and is fuse protected. The USB interface can be disabled in the system BIOS setup.

The AIMB-210 is equipped with one high-performance 1000 Mbps Ethernet LANs. They are supported by all major network operating systems. The RJ-45 jacks on the rear plate provide convenient or 1000 Mbps operation.

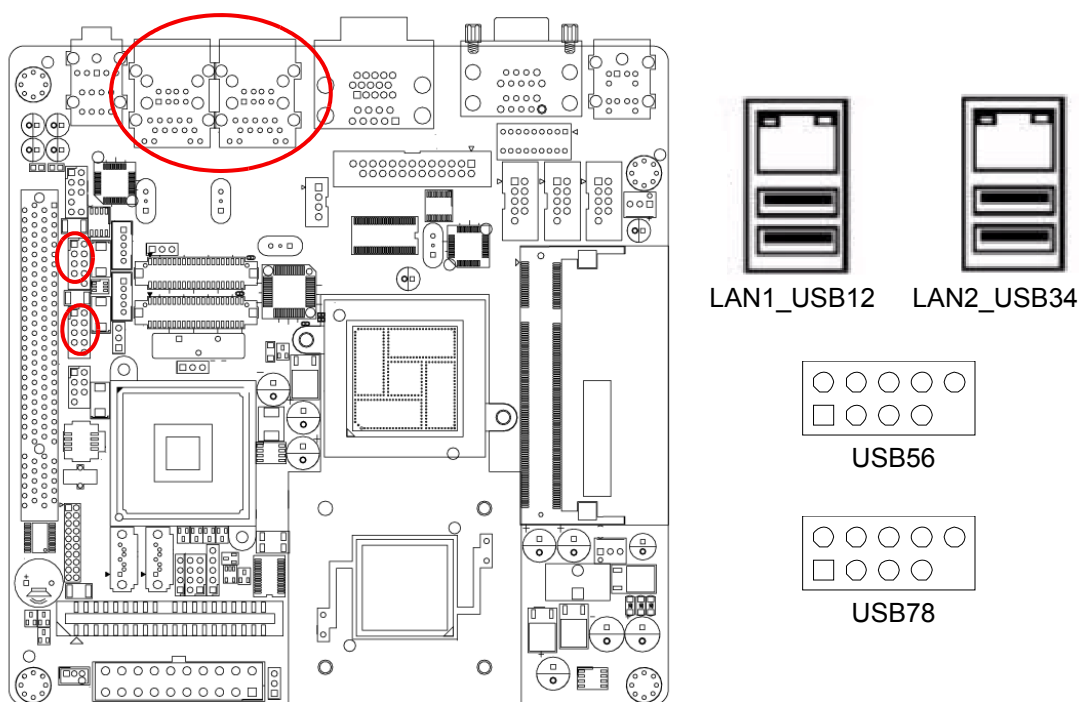

Table 2.1: LAN LED Indicator

LAN Mode	Lan Indicator
1 Gbps Link on	LED1 Green on
100 Mbps Link on	LED1 Orange on
Active	LED2 Green flash

2.5 TV-Out Connector (TVOUT1)

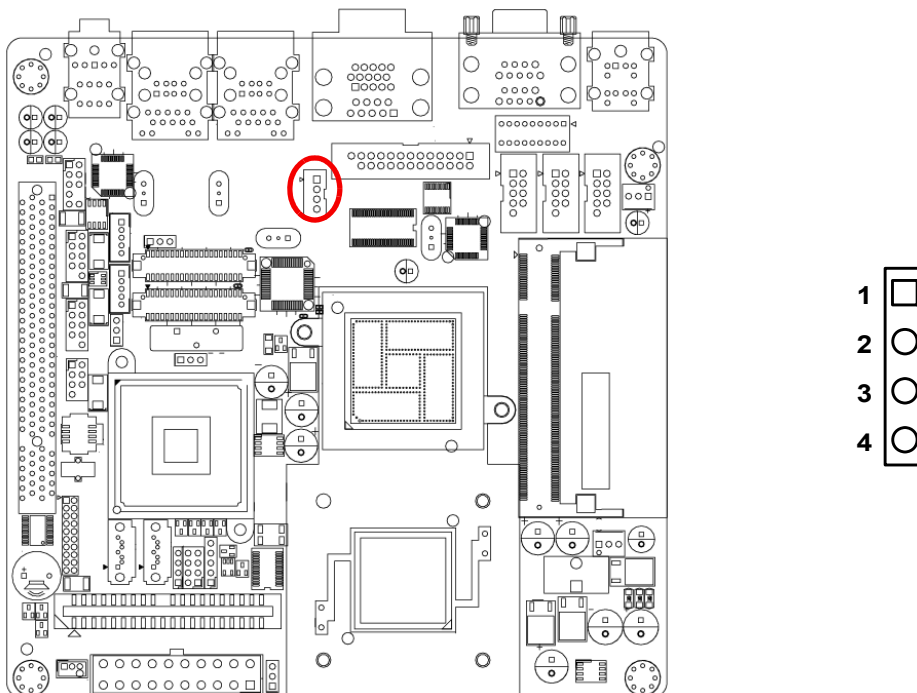
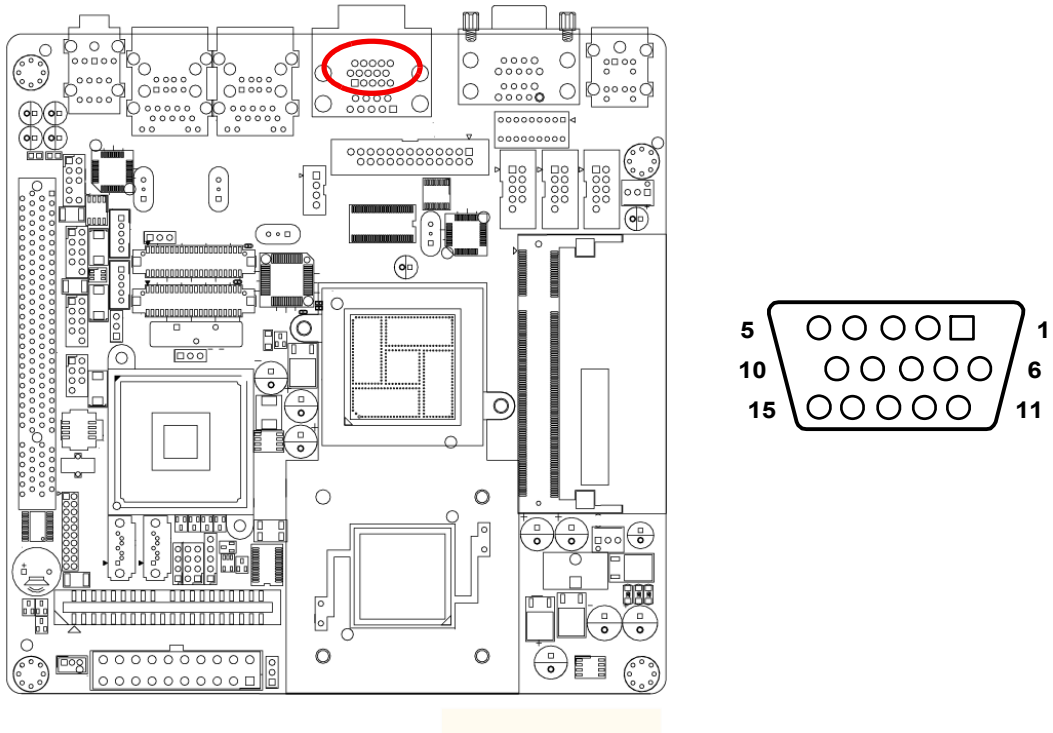

Table 2.2: TV-Out Connector (TVOUT1)

Pin	Signal
1	TV_Pb
2	TV_Y
3	TV_Pr
4	GND

2.6 VGA Connector (VGA1)



The AIMB-210 includes a VGA interface that can drive conventional CRT displays. VGA1 is a standard 15-pin D-SUB connector commonly used for VGA. Pin assignments for CRT connector VGA1 are detailed in Appendix B.

2.7 Serial Ports (COM1~COM6)

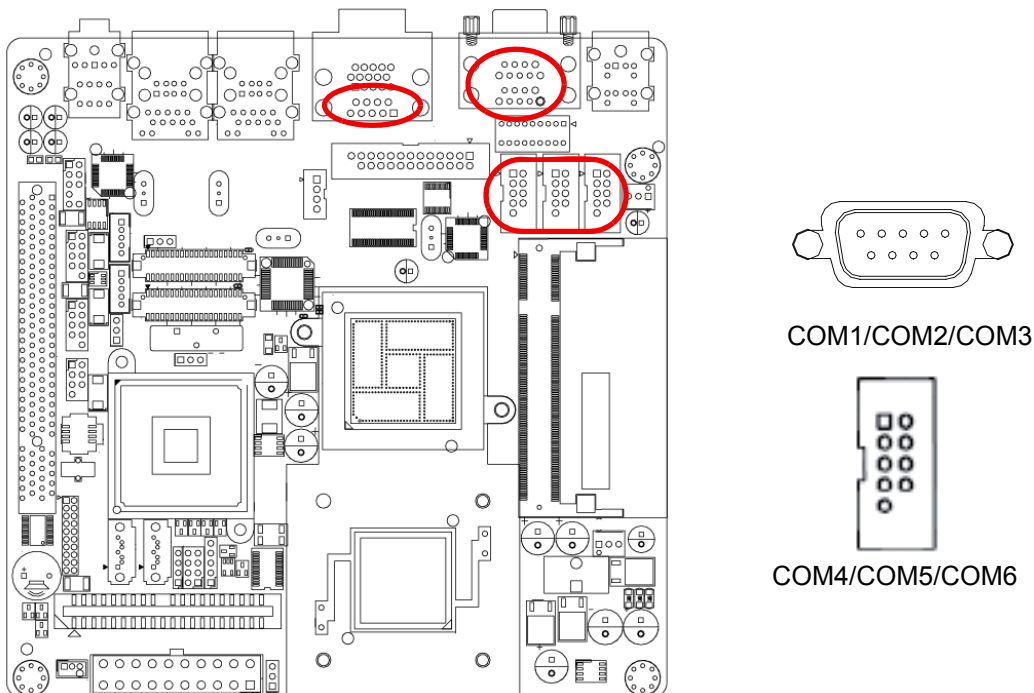

AIMB-210 supports six serial ports. 1 of RS-232/422/485 - COM1, COM2, COM3, COM4, COM5 and COM6. The user can use JSETCOM2 to select among RS 232/422/485 modes for COM2. These ports can connect to serial devices, such as a mouse or a printer, or to a communications network.

The IRQ and address ranges for both ports are fixed. However, if you want to disable the port or change these parameters later, you can do this in the system BIOS setup.

Different devices implement the RS-232/422/485 standards in different ways. If you are having problems with a serial device, be sure to check the pin assignments for the connector.

2.8 PS/2 Keyboard and Mouse Connector (KBMS1)

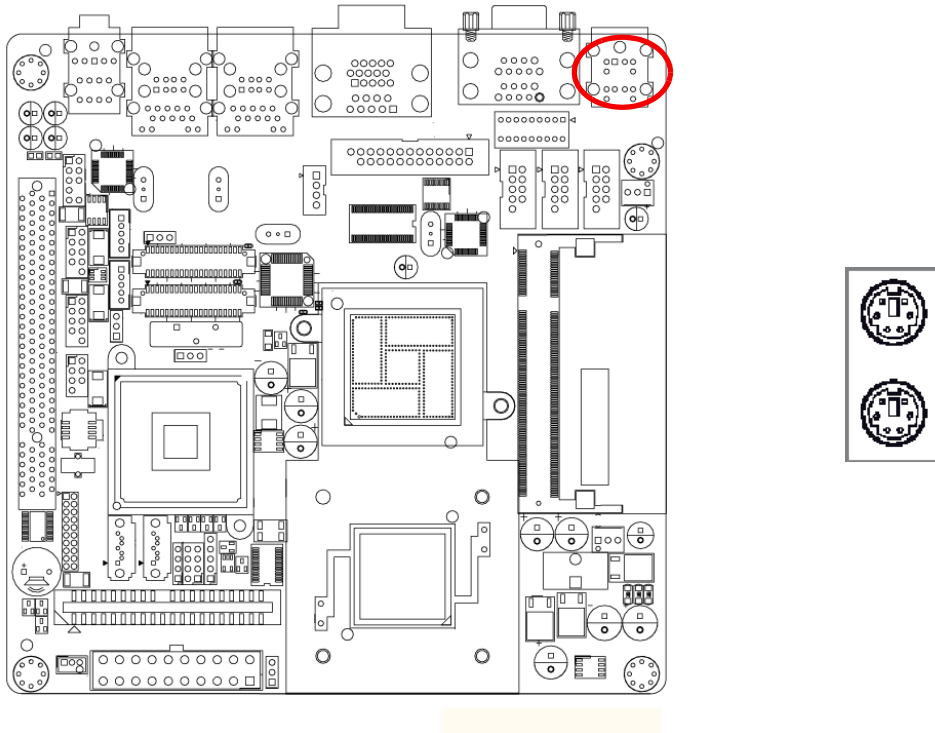

Two 6-pin mini-DIN connectors (KBMS1) on the motherboard provide connection to a PS/2 keyboard and a PS/2 mouse, respectively.

2.9 CPU Fan Connector (CPU_FAN1)

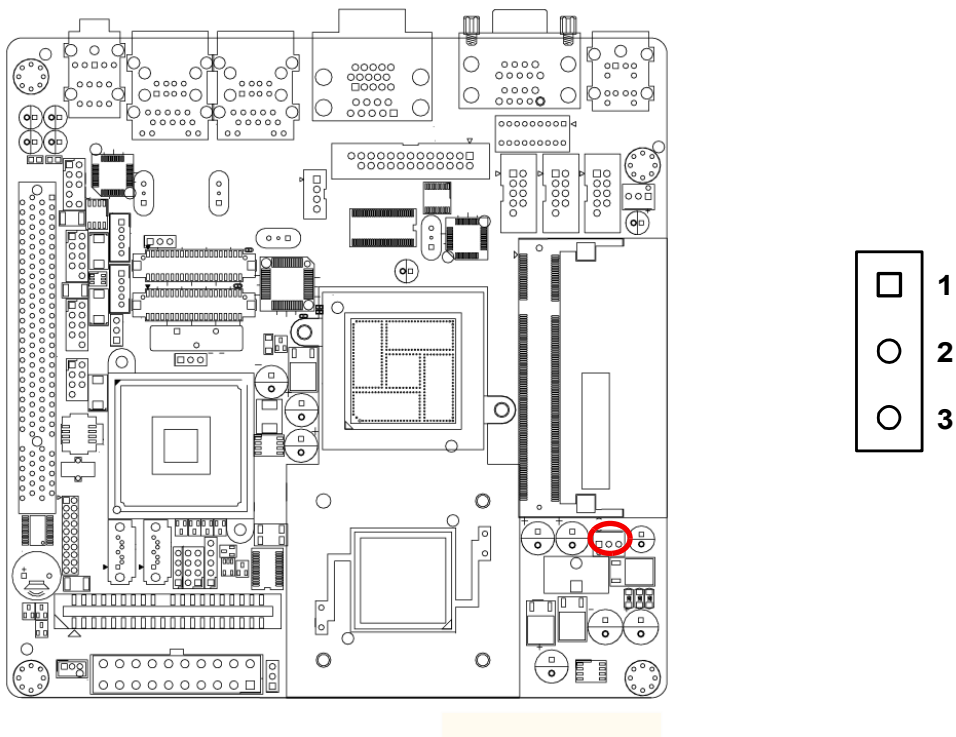

If fan is used, this connector supports cooling fans of 500 mA (6 W) or less.

2.10 System FAN Connector (CHA_FAN1)

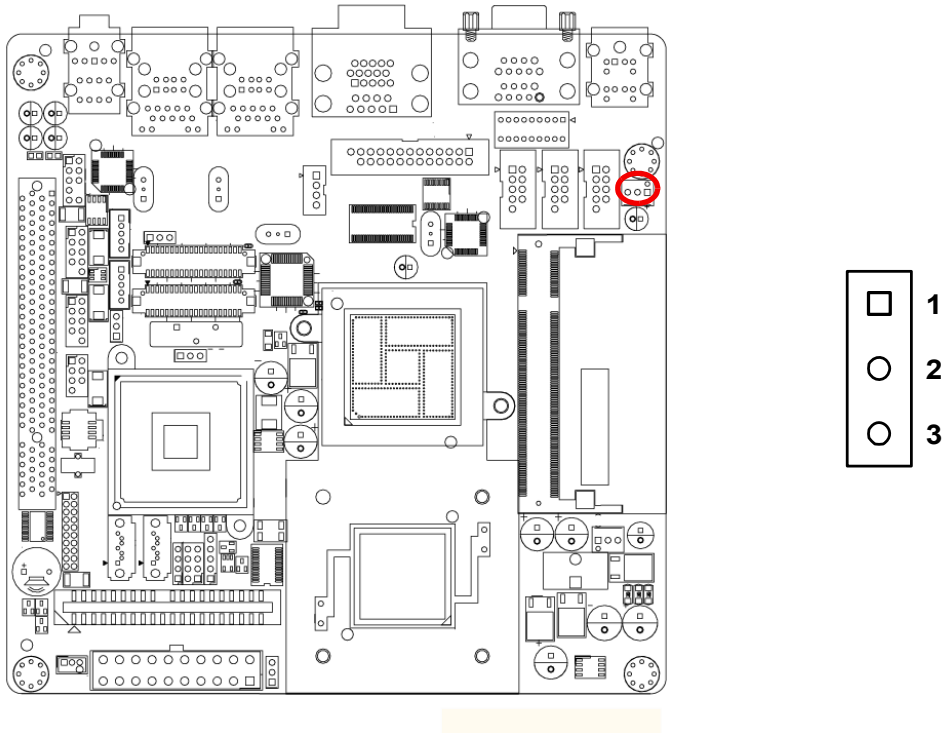

If fan is used, this connector supports cooling fans of 500 mA (6 W) or less.

2.11 Front Panel Connectors (JFP1/JFP2/JFP3)

There are several external switches to monitor and control the AIMB-210.

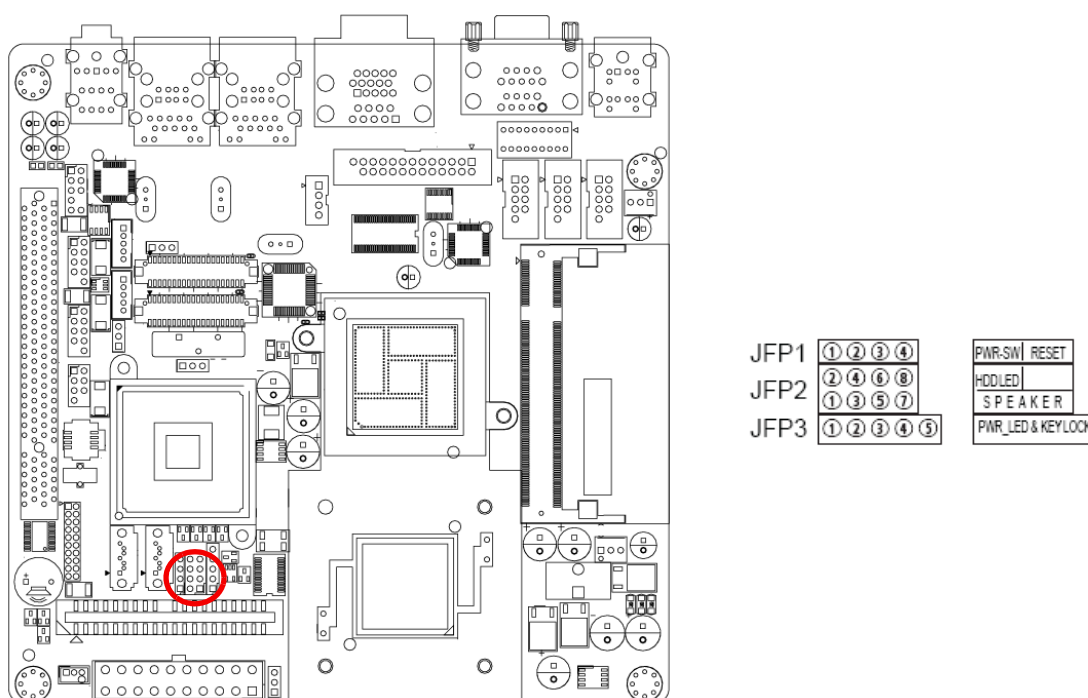

2.11.1 ATX soft power switch (JFP1 / PWR_SW)

If your computer case is equipped with an ATX power supply, you should connect the power on/off button on your computer case to (JFP1/PWR_SW). This connection enables you to turn your computer on and off.

2.11.2 Reset (JFP1 / RESET)

Many computer cases offer the convenience of a reset button. Connect the wire for the reset button.

2.11.3 HDD LED (JFP2 / HDDLED)

You can connect an LED to connector (JFP2/HDDLED) to indicate when the HDD is active.

2.11.4 External speaker (JFP2 / SPEAKER)

(JFP2 / SPEAKER) is a 4-pin connector for an external speaker. If there is no external speaker, the AIMB-210 provides an onboard buzzer as an alternative. To enable the buzzer, set pins 3-4 as closed.

2.11.5 Power LED and keyboard lock connector (JFP3 / PWR_LED & KEY LOCK)

(JFP3 / PWR_LED&KEY LOCK) is a 5-pin connector for the power on LED and Key Lock function. Refer to Appendix B for detailed information on the pin assignments. The Power LED cable should be connected to pin 1-3. The key lock button cable should be connected to pin 4-5.

There are 3 modes for the power supply connection. The first is “ATX power mode”, system is on/off by a tentative power button. The second is “AT Power Mode”, system is on/off by the switch of the Power supply. The third is another “AT Power Mode” which is using the front panel power switch. The power LED status is indicated as following table:

Table 2.3: ATX power supply LED status (No support for AT power)

Power mode	LED (ATX Power Mode) (On/off by tentative button)	LED (AT power Mode) (On/off by switching power supply)	LED (AT power Mode) (On/off by front panel switch)
PSON1 (On Back plane) Jumper setting	2-3 pin closed	1-2 pin closed	Connect 1-2 pin cable with switch
System On	On	On	On
System Suspend	Fast flashes	Fast flashes	Fast flashes
System Off	Slow flashes	Off	Off

2.12 Line In, Line Out, Mic In Connector (AUDIO1)

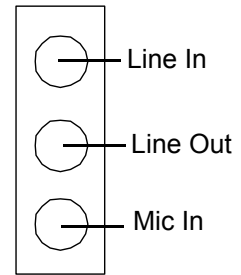
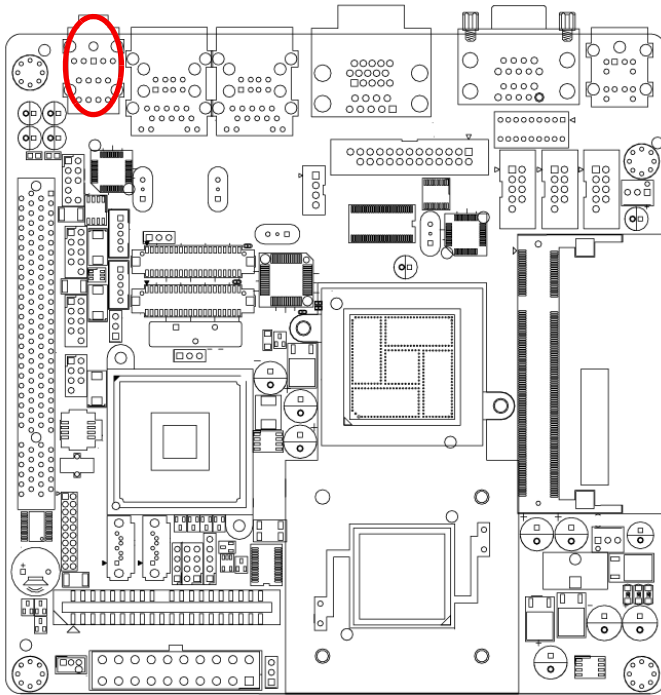

2.13 Serial ATA Interface (SATA1, SATA2)

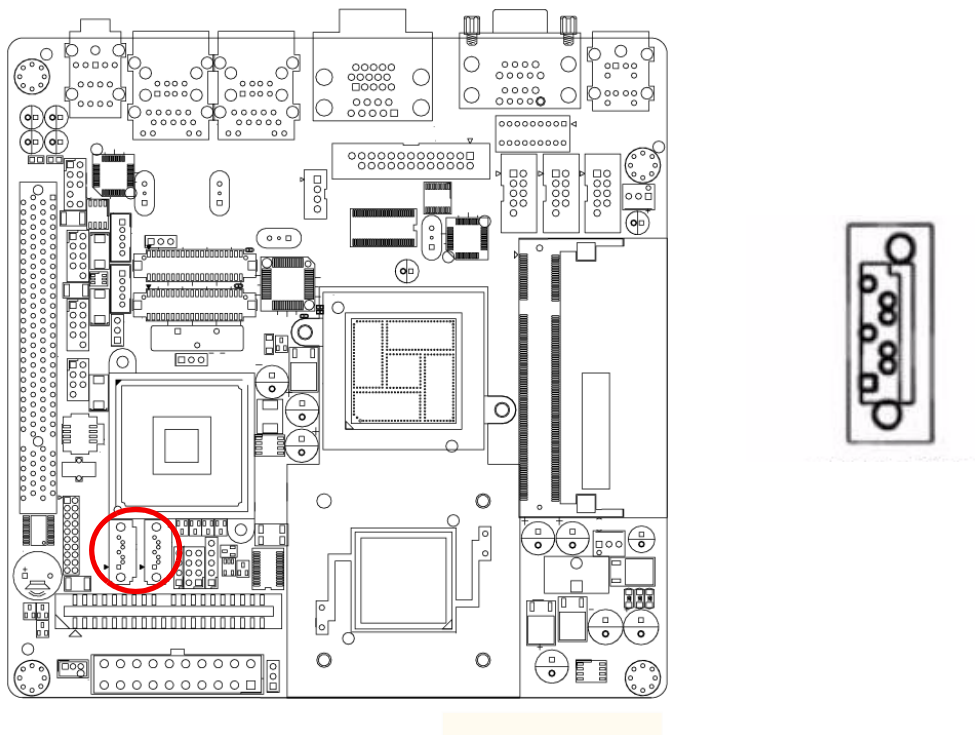

AIMB-210 features a high performance serial ATA interface (up to 150 MB/s) which eases cabling to hard drives with thin and long cables.

2.14 PCI

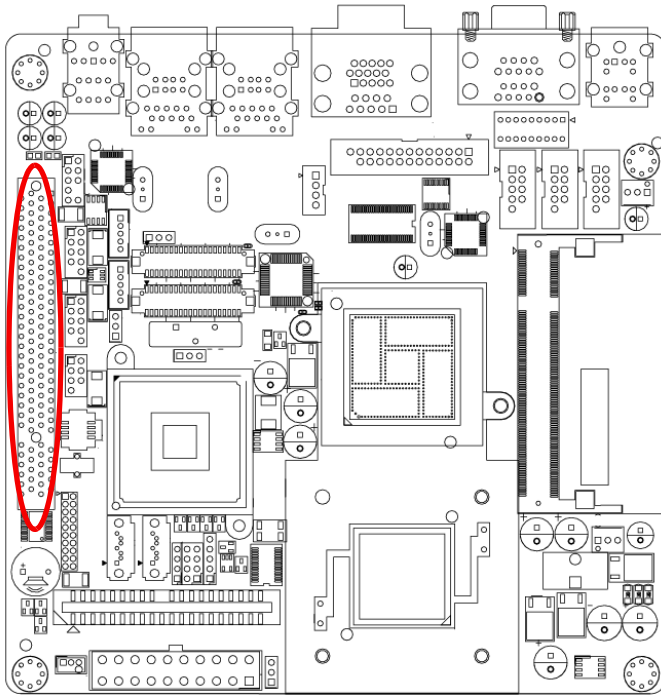

The AIMB-210 provides 1 x PCI slot.

2.15 Front Headphone Connector (FPAUD1)

This connector is for a chassis-mounted front panel audio I/O module that supports either HD Audio or legacy AC'97 (optional) audio standard. Connect one end of the front panel audio I/O module cable to this connector.

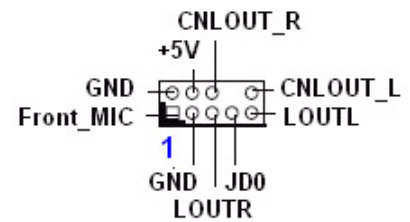
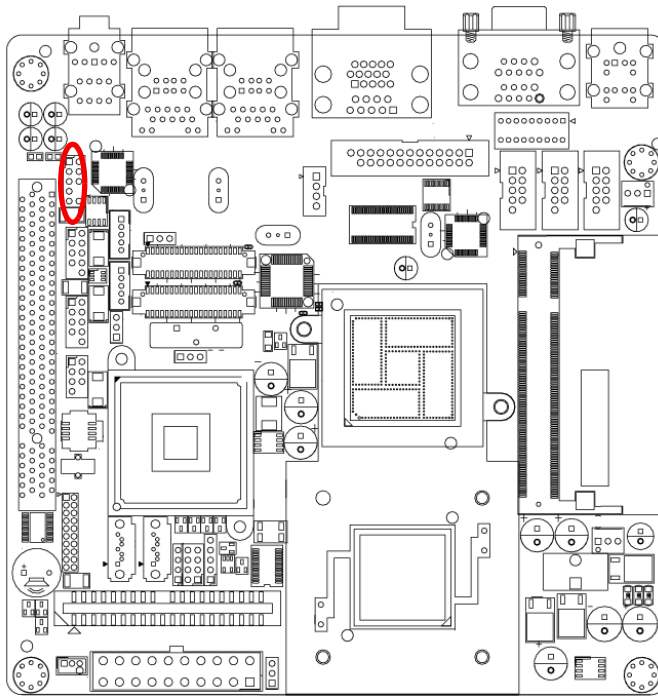

Note! For motherboards with the optional HD Audio feature, we recommend that you connect a high-definition front panel audio module to this connector to avail of the motherboard's high definition audio capability.



2.16 ATX Power Connector (EATXPWR1)

This connector is for an ATX Micro-Fit power supply. The plugs from the power supply are designed to fit these connectors in only one orientation. Find the proper orientation and push down firmly until the connectors completely fit.

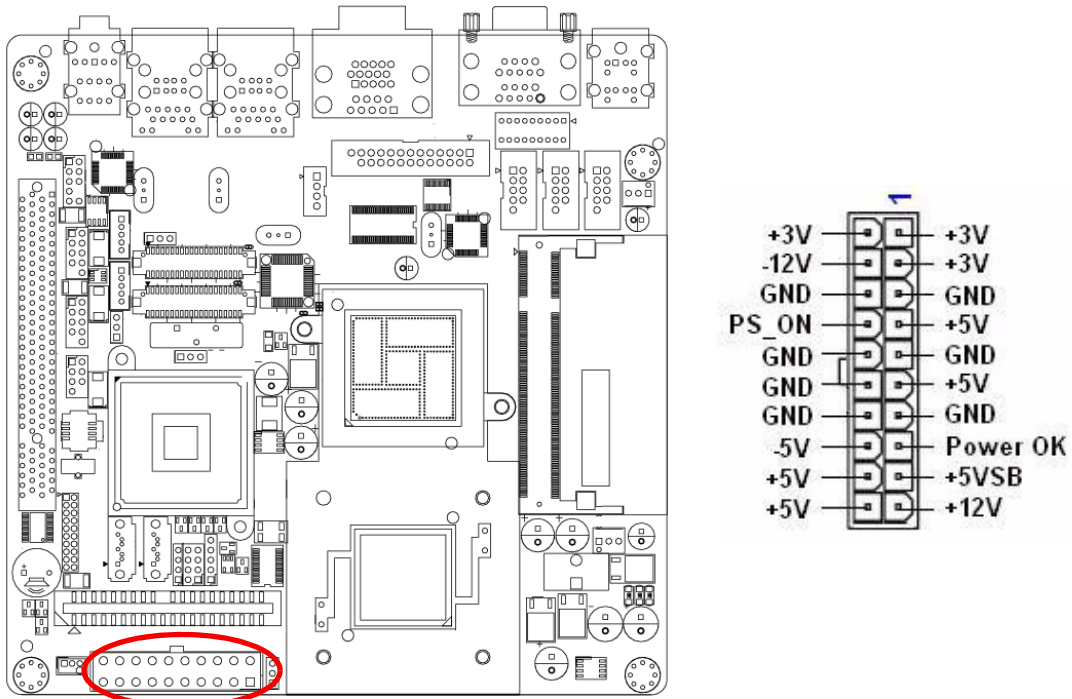

2.17 SPI Flash connector(SPI_CN1)

SPI flash card pin header may be used to flash BIOS if AIMB-210 cannot power on.

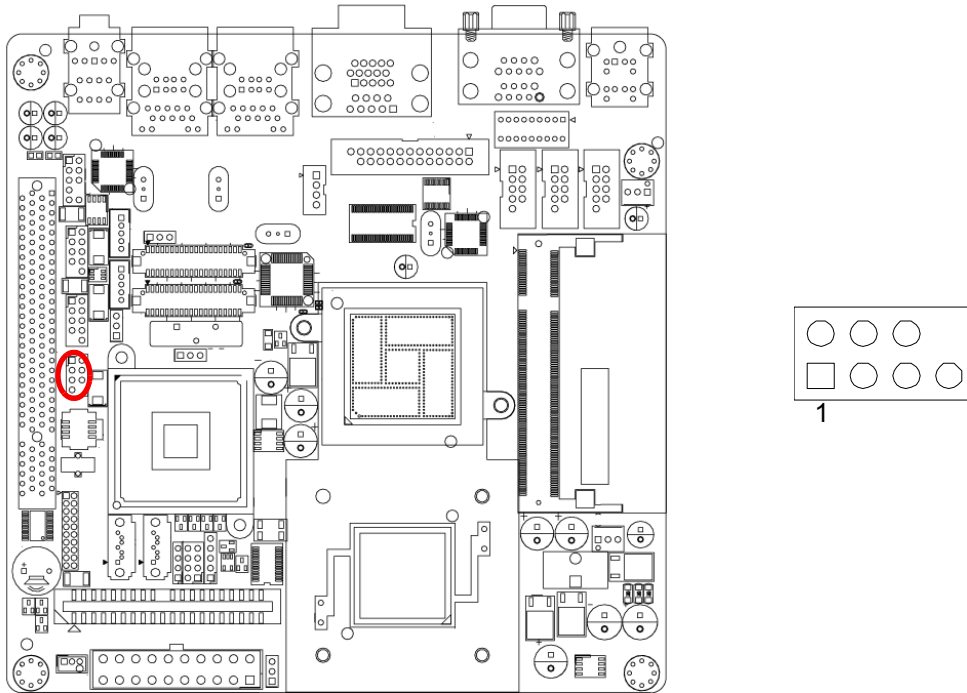

2.18 LCD Inverter Connector INV1 & INV2 (Optional)

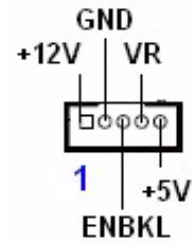
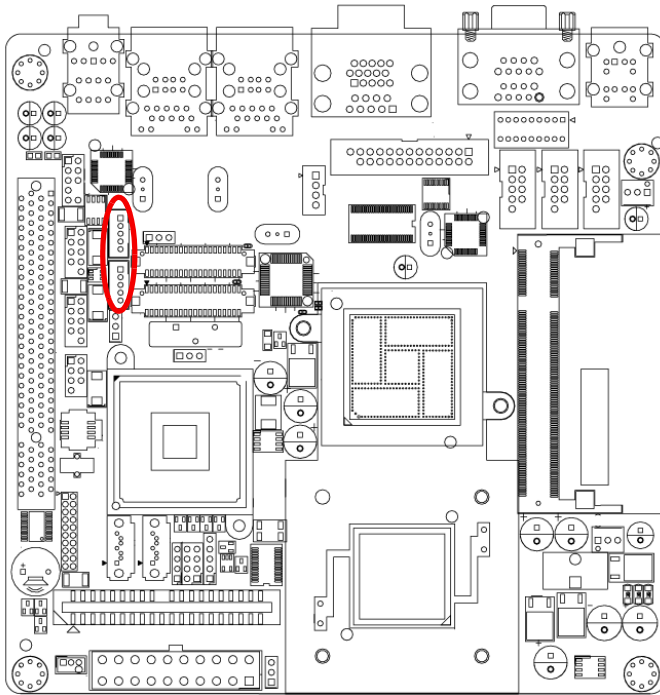

Note! ■ **Signal Description**



Signal

VR

ENBKL

Signal Description

Vadj=0.75 V

(Recommended: 4.7 KΩ, >1/16 W)

LCD backlight ON/OFF control signal

2.19 LVDS Connector LVDS1 & LVDS2 (Optional)

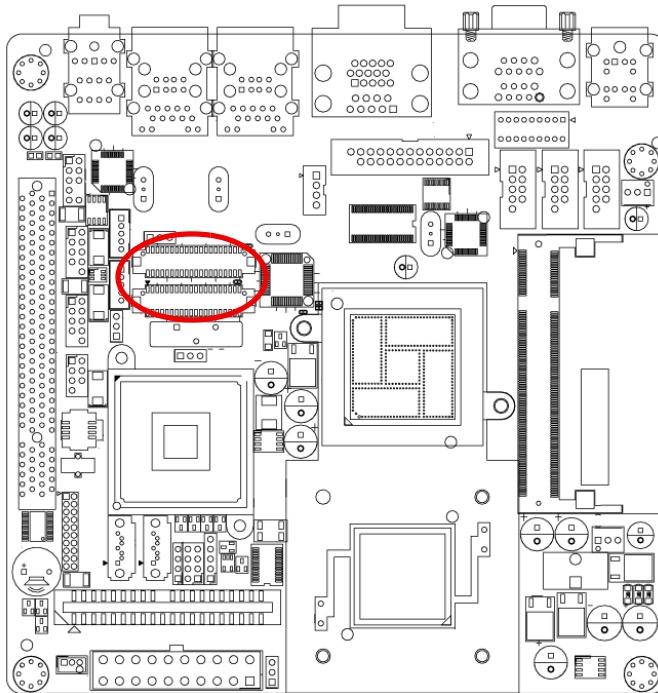

LVDS 1

VDDSAFE_1	<input type="checkbox"/>	VDDSAFE_2	<input type="checkbox"/>
GND_1	<input type="checkbox"/>	GND_7	<input type="checkbox"/>
VDDSAFE_3	<input type="checkbox"/>	VDDSAFE_4	<input type="checkbox"/>
OD0-	<input type="checkbox"/>	ED0-	<input type="checkbox"/>
OD0+	<input type="checkbox"/>	ED0+	<input type="checkbox"/>
GND_2	<input type="checkbox"/>	GND_8	<input type="checkbox"/>
OD1-	<input type="checkbox"/>	ED1-	<input type="checkbox"/>
OD1+	<input type="checkbox"/>	ED1+	<input type="checkbox"/>
GND_3	<input type="checkbox"/>	GND_9	<input type="checkbox"/>
OD2-	<input type="checkbox"/>	ED2-	<input type="checkbox"/>
OD2+	<input type="checkbox"/>	ED2+	<input type="checkbox"/>
GND_4	<input type="checkbox"/>	GND_10	<input type="checkbox"/>
OCK-	<input type="checkbox"/>	ECK-	<input type="checkbox"/>
OCK+	<input type="checkbox"/>	ECK+	<input type="checkbox"/>
GND_5	<input type="checkbox"/>	GND_11	<input type="checkbox"/>
DDC_CLK	<input type="checkbox"/>	DDC_DAT	<input type="checkbox"/>
GND_6	<input type="checkbox"/>	GND_12	<input type="checkbox"/>
NC	<input type="checkbox"/>	NC	<input type="checkbox"/>
NC	<input type="checkbox"/>	NC	<input type="checkbox"/>
HPLG	<input type="checkbox"/>	VCON	<input type="checkbox"/>

LVDS 2

VDDSAFE_1	<input type="checkbox"/>	VDDSAFE_2	<input type="checkbox"/>
GND_1	<input type="checkbox"/>	GND_7	<input type="checkbox"/>
VDDSAFE_3	<input type="checkbox"/>	VDDSAFE_4	<input type="checkbox"/>
OD0-	<input type="checkbox"/>	ED0-	<input type="checkbox"/>
OD0+	<input type="checkbox"/>	ED0+	<input type="checkbox"/>
GND_2	<input type="checkbox"/>	GND_8	<input type="checkbox"/>
OD1-	<input type="checkbox"/>	ED1-	<input type="checkbox"/>
OD1+	<input type="checkbox"/>	ED1+	<input type="checkbox"/>
GND_3	<input type="checkbox"/>	GND_9	<input type="checkbox"/>
OD2-	<input type="checkbox"/>	ED2-	<input type="checkbox"/>
OD2+	<input type="checkbox"/>	ED2+	<input type="checkbox"/>
GND_4	<input type="checkbox"/>	GND_10	<input type="checkbox"/>
OCK-	<input type="checkbox"/>	ECK-	<input type="checkbox"/>
OCK+	<input type="checkbox"/>	ECK+	<input type="checkbox"/>
GND_5	<input type="checkbox"/>	GND_11	<input type="checkbox"/>
DDC_CLK	<input type="checkbox"/>	DDC_DAT	<input type="checkbox"/>
GND_6	<input type="checkbox"/>	GND_12	<input type="checkbox"/>
OD3-	<input type="checkbox"/>	ED3-	<input type="checkbox"/>
OD3+	<input type="checkbox"/>	ED3+	<input type="checkbox"/>
HPLG	<input type="checkbox"/>	VCON	<input type="checkbox"/>

2.20 Digital I/O Connector (DIO1)

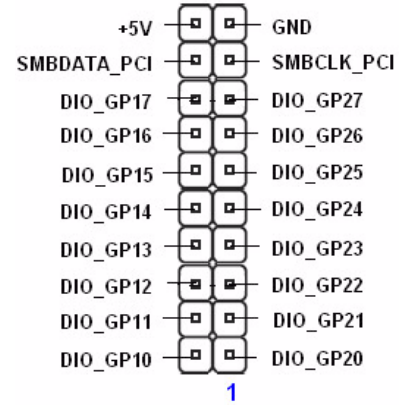
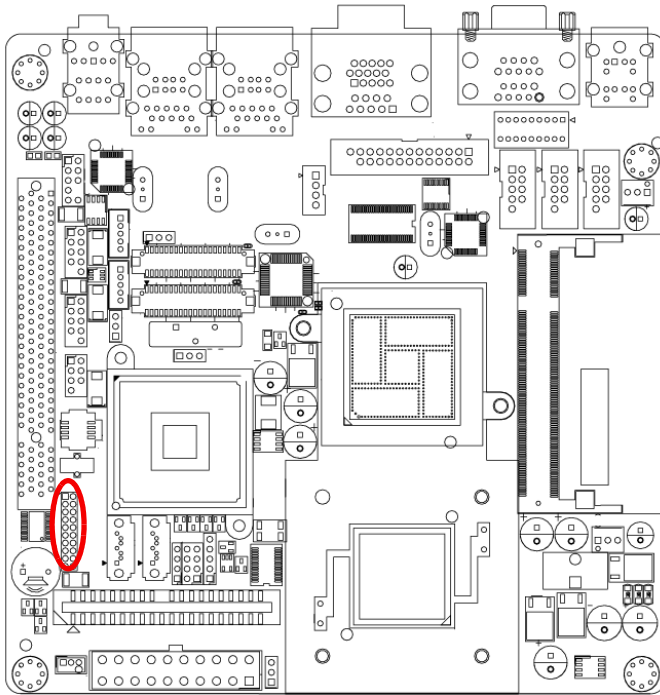

Chapter 3

BIOS Operation

3.1 Introduction

Advantech provides a full-featured Award BIOS 6.0 that delivers superior performance, compatibility and functionality for manufactures of Industrial PCs and embedded boards; its many options and extensions let you customize your products to a wide range of designs and target markets.

The modular, adaptable AwardBIOS 6.0 supports the broadest range of third-party peripherals and all popular chipsets, plus Intel[®], AMD, nVidia, VIA, and compatible CPUs from 386 through Pentium[®] and AMD Geode[™], K7 and K8 (including multiple processor platforms), and VIA Eden C3 and C7 CPU.

You can use Advantech's utilities to select and install features to suit your design needs.

3.2 BIOS Setup

The AIMB-210 Series system has build-in AwardBIOS with a CMOS SETUP utility which allows users to configure required settings or to activate certain system features.

The CMOS SETUP saves the configuration in the CMOS RAM of the motherboard. When the power is turned off, the battery on the board supplies the necessary power to the CMOS RAM.

When the power is turned on, press the button during the BIOS POST (Power-On Self Test) will take you to the CMOS SETUP screen.

Control Keys

< ↑ >< ↓ >< ← >< → >	Move to select item
<Enter>	Select Item
<Esc>	Main Menu - Quit and not save changes into CMOS Sub Menu - Exit current page and return to Main Menu
<Page Up/+>	Increase the numeric value or make changes
<Page Down/->	Decrease the numeric value or make changes
<F1>	General help, for Setup Sub Menu
<F2>	Item Help
<F5>	Load Previous Values
<F7>	Load Setup Default
<F10>	Save all CMOS changes

3.2.1 Main Menu

Press to enter AwardBIOS CMOS Setup Utility, the Main Menu will appear on the screen. Use arrow keys to select among the items and press <Enter> to accept or enter the sub-menu.

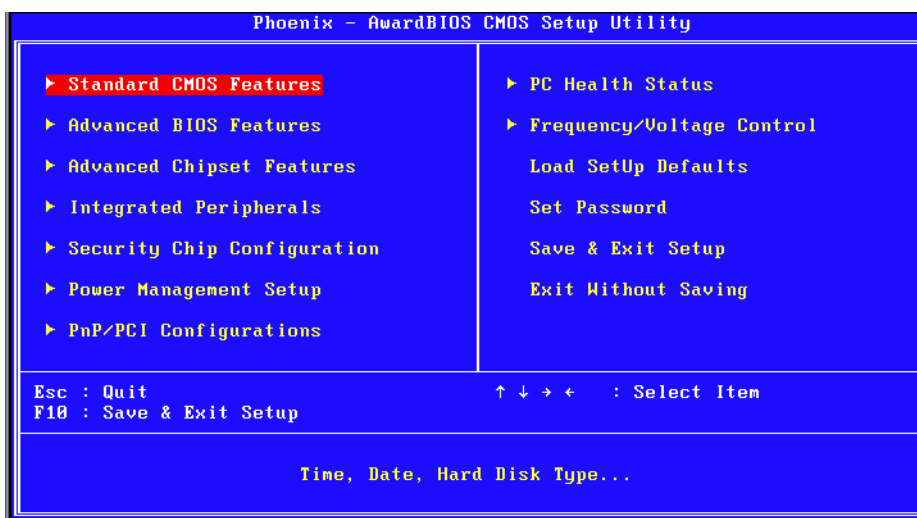

- **Standard CMOS Features**
This setup page includes all the items in standard compatible BIOS.
- **Advanced BIOS Features**
This setup page includes all the items of Award BIOS enhanced features.
- **Advanced Chipset Features**
This setup page includes all the items of Chipset configuration features.
- **Integrated Peripherals**
This setup page includes all onboard peripheral devices.
- **Security chip configuration**
This SETUP page includes all the items of Trusted Module Configuration features. This sub-menu item only appears when the Trusted Module is plugged in.
- **Power Management Setup**
This setup page includes all the items of Power Management features.
- **PnP/PCI Configurations**
This setup page includes PnP OS and PCI device configuration.
- **PC Health Status**
This setup page includes the system auto detect CPU and system temperature, voltage, fan speed.
- **Frequency/Voltage Control**
This setup page includes CPU host clock control, frequency ratio and voltage.
- **Load Setup Defaults**
This setup page includes Load system optimized value, and the system would be in best performance configuration.
- **Set Password**
Establish, change or disable password.
- **Save & Exit Setup**
Save CMOS value settings to CMOS and exit BIOS setup.
- **Exit Without Saving**
Abandon all CMOS value changes and exit BIOS setup.

3.2.2 Standard CMOS Features

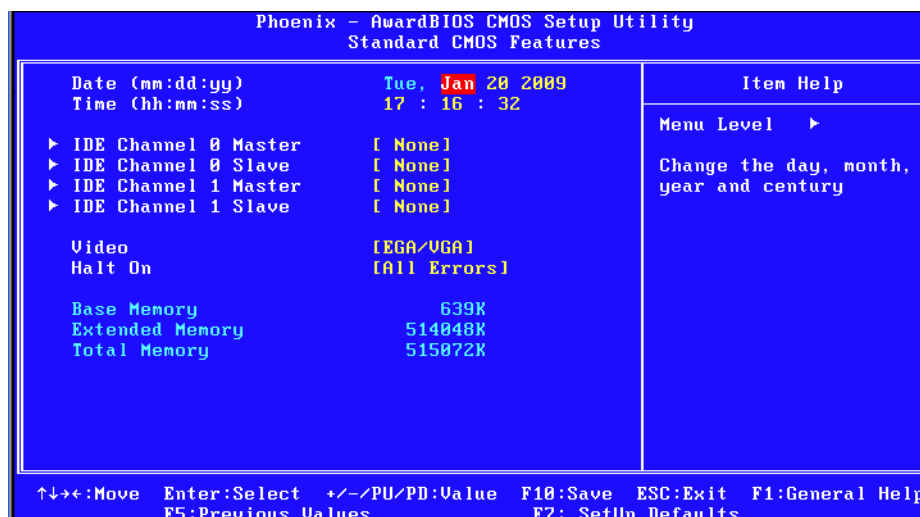

- **Date**

The date format is <weekday>, <month>, <day>, <year>.

Weekday	From Sun to Sat, determined and displayed by BIOS only
Month	From Jan. to Dec.
Day	From 1 to 31
Year	From 1999 through 2098
- **Time**

The time format is <hour> <minute> <second>, based on 24-hour time.
- **IDE Channel 0 Master/Slave**

IDE HDD Auto-Detection Press "Enter" for automatic device detection.
- **Video**

Select EGA or VGA display.
- **Halt on**

The item determines whether the computer will stop if an error is detected during power up.

No Errors	The system boot will not stop for any error.
All Errors	Whenever the BIOS detects a non-fatal error the system will be stopped.
All, But Keyboard	The system boot will not stop for a keyboard error; it will stop for all other errors. (Default value)
- **Base Memory**

The POST of the BIOS will determine the amount of base (or conventional) memory installed in the system.
- **Extended Memory**

The BIOS POST will determine the amount of extended memory (above 1 MB in CPU's memory address map) installed in the system.
- **Total Memory**

This item displays the total system memory size.

3.2.3 Advanced BIOS Features

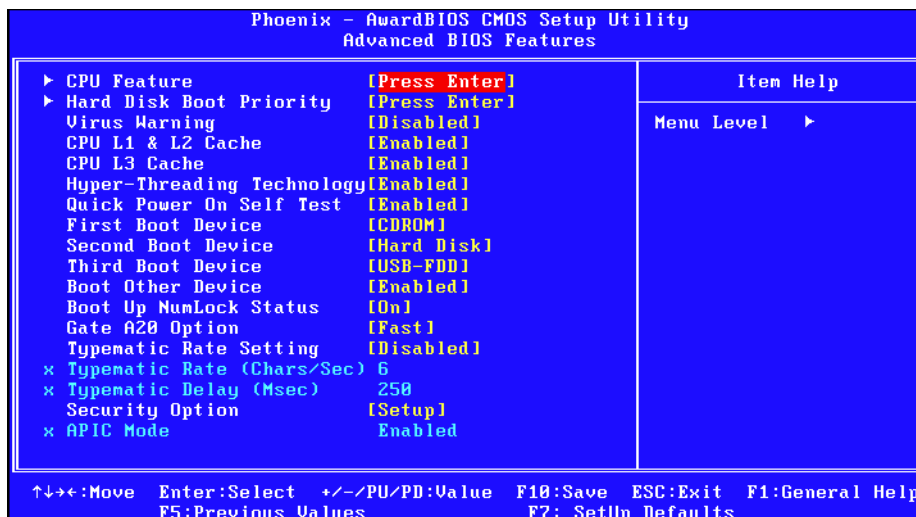

- **CPU Feature**
This item allows users to adjust CPU features.
- **Hard Disk Boot Priority**
This item allows users to select boot sequence for system device HDD, USB-HDD, SCSI, RAID.
- **Virus Warning[Disabled]**
Enables or disables the virus warning.
- **CPU L1 & L2 Cache [Enabled]**
This item allows users to enable CPU L1 and L2 cache.
- **CPU L3 Cache**
This item allows users to enable CPU L3 cache.
- **Quick Power On Self Test[Enabled]**
This field speeds up the Power-On Self Test (POST) routine by skipping retesting a second, third and fourth time. Setup setting default is enabled.
- **First / Second / Third / Other Boot Drive**

Hard Disk	Select boot device priority by Hard Disk.
CDROM	Select boot device priority by CDROM.
USB-FDD	Select boot device priority by USB-FDD.
USB-ZIP	Select boot device priority by USB-ZIP.
USB-CDROM	Select boot device priority by USB-CDROM.
LAN	Select boot device priority by LAN.
Disabled	Disable this boot function.
- **Gate A20 Option [Fast]**
This item enables users to switch A20 control by port 92 or not.
- **Typematic Rate Setting**
This item enables users to set the two typematic controls items.
 - Typematic Rate (Chars/Sec)
This item controls the speed at which the system registers auto-repeated keystrokes. The eight settings are 6, 8, 10, 12, 15, 20, 24 and 30.
 - Typematic Delay (Msec)
This item sets the keypress time delay before autorepeat begins.

Four delay rate options are 250, 500, 750 and 1000.

■ Security Option [Setup]

System	System will not boot and refuses access to Setup page if the correct password is not entered at the prompt.
Setup	System will boot, but access to Setup requires password (default value).

■ APIC Mode [Enabled]

This item allows user to enabled of disabled “Advanced Programmable Interrupt Controller”. APIC is implemented in the motherboard and must be supported by the operating system, and it extends the number of IRQ’s available.

3.2.4 Advanced Chipset Features

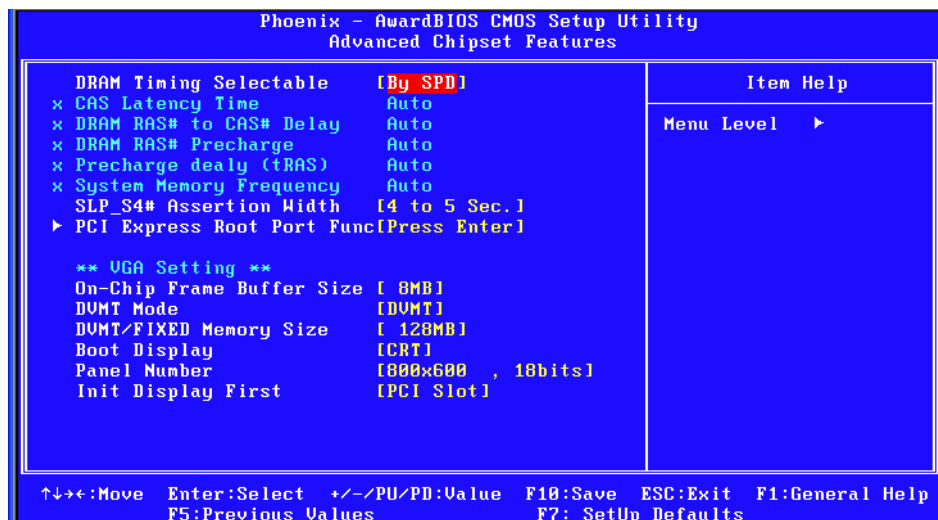

Note!  This “Advanced Chipset Features” page controls configuration of the board’s chipset. This page is chipset dependent; screens may differ somewhat depending on the chipset. It is strongly recommended that only technical users make changes to the default settings.

■ DRAM Timing Selectable [By SPD]

This item enables users to set the optimal timings for items 2 through 5; system default setting “By SPD” follows the SPD information and ensures the system runs stably with optimal performance.

■ CAS Latency Time [Auto]

This item enables users to set the timing delay in clock cycles before SDRAM starts a read command after receiving it.

■ DRAM RAS# to CAS# Delay [Auto]

This item enables users to set the timing of the transition from RAS (row address strobe) to CAS (column address strobe) as both rows and column are separately addressed shortly after DRAM is refreshed.

■ DRAM RAS# Precharge [Auto]

This item enables users to set the DRAM RAS# precharge timing, system default is setting to “Auto” to reference the data from SPD ROM.

■ Precharge delay (tRAS) [Auto]

This item allows user to adjust memory precharge time.

- **System Memory Frequency [Auto]**
This item allows user to adjust memory frequency to improvement performance.
- **PCI Express Root port Func [Press Enter]**
This item allows the user to adjust PCIE port on, off or auto.
- **On-Chip Frame Buffer Size[8 MB]**
This item allows the user to adjust the on-chip frame buffer size 8 MB or 1 MB.
- **DVMT Mode [DVMT]**
This item allows the user to adjust Intel's Dynamic Video Memory Technology (DVMT). BIOS provides three options: DVMT, FIXED, and Both.
- **DVMT/FIXED Memory Size [128MB]**
This item allows the user to adjust DVMT/FIXED graphics memory size.
- **Boot Display**
This item allows the user to decide boot display mode.
- **Panel Number**
This item allows the user to decide display resolution.
- **Init Display First**
This item is the setting for start up video output: either from PCI Express or Onboard device.

3.2.5 Integrated Peripherals

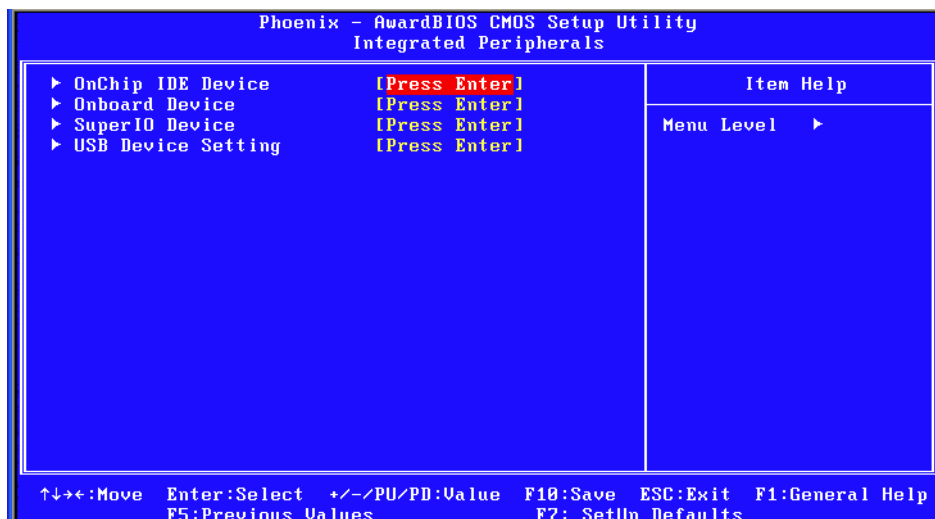

Note!  This “Integrated Peripherals” page controls the configuration of the board’s chipset, including IDE, ATA, SATA, USB, AC97, MC97 and Super IO and Sensor devices. This page is chipset dependent; the screen capture above is illustrative, but screens do differ depending on chipset features.

■ OnChip IDE Device

This item enables users to set the OnChip IDE device status, including some of new chipsets also support SATA devices (Serial-ATA).

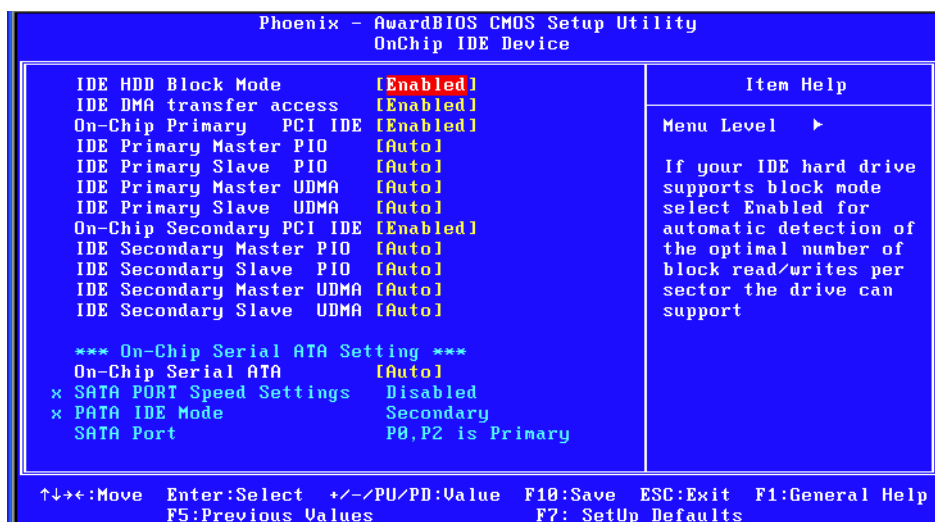

■ Onboard Device

This item enables users to set the Onboard device status, including enabling AC97, and LAN devices.

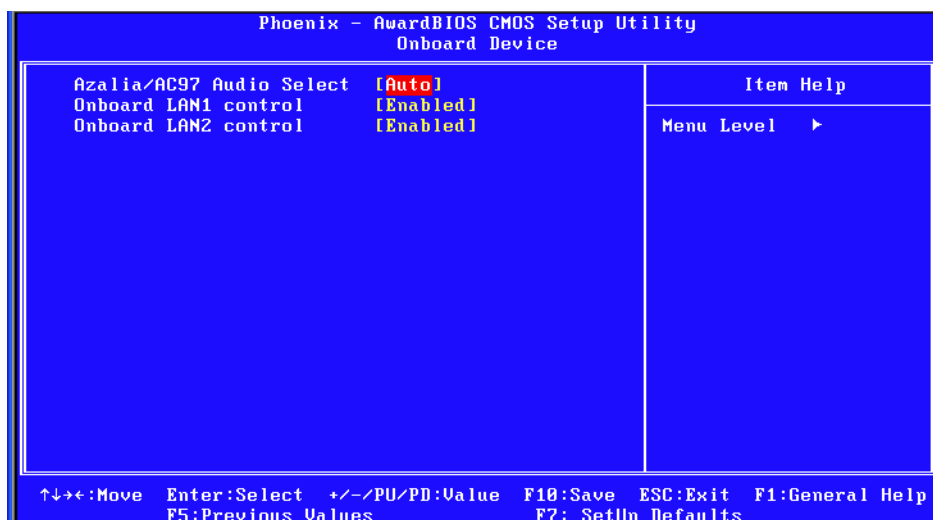

■ Super IO Device

This item enables users to set the Super IO device status, including enabling of COM, and LPT.

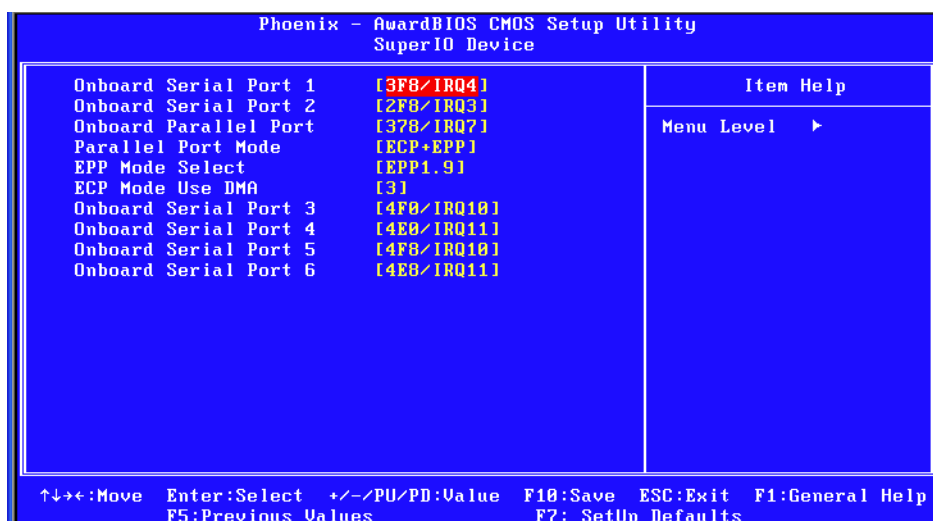

■ Onboard Serial port 1 [3F8 / IRQ4]

This item allows user to adjust serial port 1 of address and IRQ.

■ Onboard Serial port 2 [2F8/ IRQ3]

This item allows user to adjust serial port 2 of address and IRQ.

■ Onboard Parallel Port [378/IRQ7]

This item allows user to adjust parallel port of address and IRQ.

■ Parallel Port Mode [ECP+EPP]

This item allows user to adjust parallel port mode.

■ EPP Mode Select [EPP1.9]

This field allows you to select EPP port type 1.7 or 1.9. The choices are "EPP1.9" and "EPP1.7".

■ ECP Mode Use DMA [3]

This item allows user to adjust ECP DMA resource.

■ Onboard Serial port 3 [4F0/IRQ10]

This item allows user to adjust serial port 3 of address and IRQ.

- **Onboard Serial port 4 [4E0/IRQ11]**
This item allows user to adjust serial port 4 of address and IRQ.
- **Onboard Serial port 5 [4F8/IRQ10]**
This item allows user to adjust serial port 4 of address and IRQ.
- **Onboard Serial port 6 [4E8/IRQ11]**
This item allows user to adjust serial port 4 of address and IRQ.

3.2.6 USB Device Setting

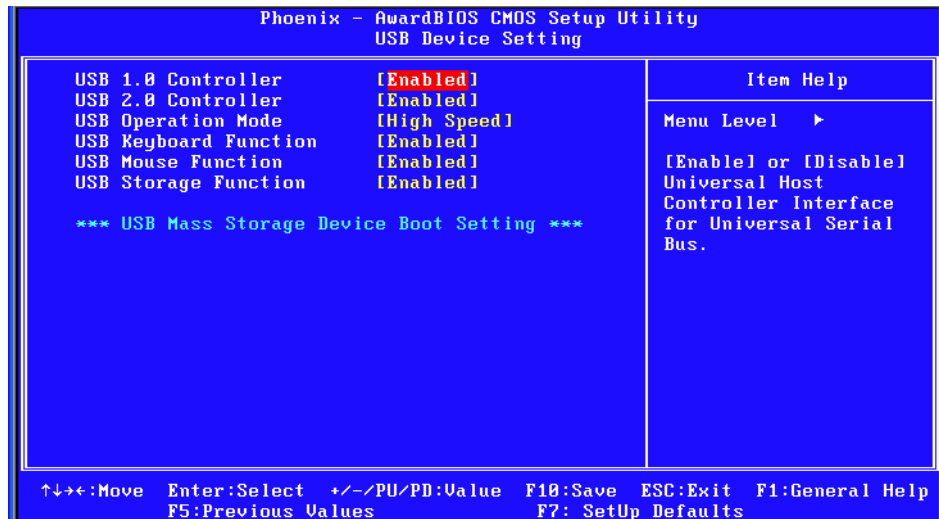

- **USB 1.0 Controller**
Select.Enabled. if your system contains a Universal Serial Bus (USB) controller and you have USB peripherals. The choices are "Enabled" and "Disabled".
- **USB 2.0 Controller**
This entry is used to disable/enable the USB 2.0 controller only. The BIOS itself may or may not have high-speed USB support. If the BIOS has high speed USB support built in, the support will automatically turn on when a high speed device is attached. The choices are "Enabled" or "Disabled".
- **USB Operation Mode**
Set the USB 2.0 controller to Hi Speed (480 Mbps) or Full Speed (12 Mbps).
- **USB Keyboard / Mouse Function**
Select "Enabled" if you plan to use a USB keyboard/Mouse. The choices are "Enabled" and "Disabled".
- **USB Storage Function**
Select "Enabled" if you plan to use an external USB storage device to boot system under DOS mode. The choices are "Enabled" and "Disabled".

3.2.7 Security Chip Configuration (Optional Item)

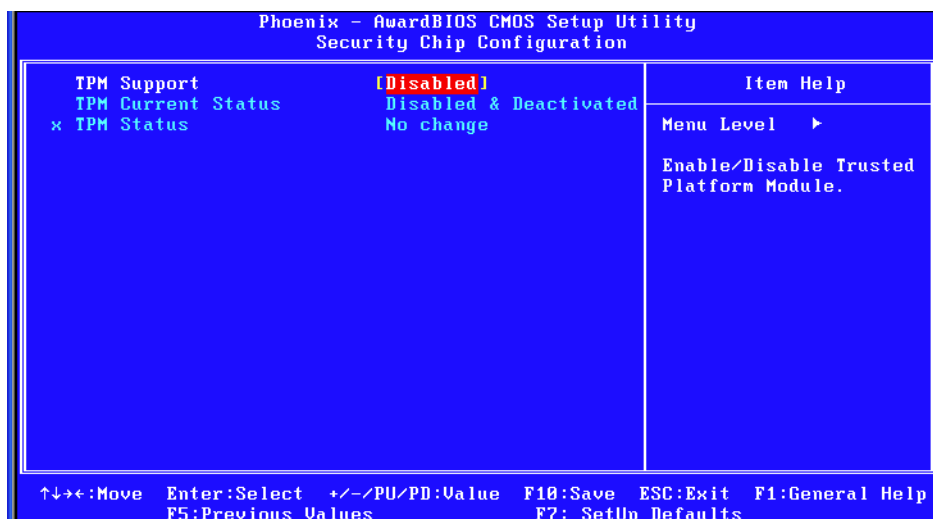

3.2.8 TPM Support

The items in this menu allow you to set the TPM (Trusted Platform Module) features. Select an item and then press <Enabled> to display the configuration options.

Note! *To enable the TPM function, set the TPM Support item to [Enabled] and then save the change; after rebooting, the TPM configuration menu will show the active options.*



3.2.9 Power Management Setup

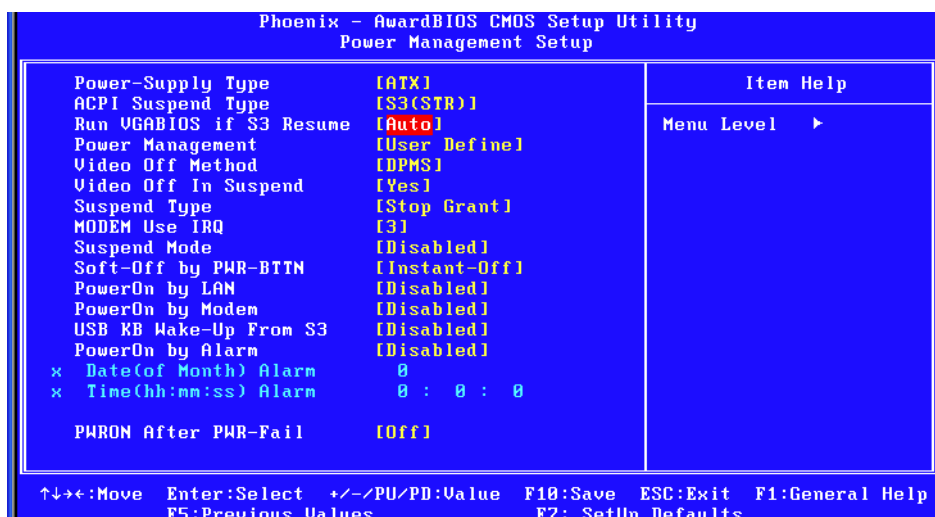

Note! Adjust “Power management Setup” to configure the system to most effective energy savings still consistent with the intended style of use.



- **Power-Supply Type [ATX]**
This item allows user to set power-supply type, ATX or AT mode.
- **ACPI Suspend Type [S3(STR)]**
This item allows user to select sleep state when in suspend.

S1(POS)	The suspend mode is equivalent to a software power down;
S3(STR)	The system shuts down with the exception of a refresh current to the system memory.
- **Run VGA BIOS if S3 Resume [Auto]**
This item allows system to reinitialize VGA BIOS after system resume from ACPI S3 mode.
- **Power Management [User Define]**
This item allows user to select system power saving mode.

Min Saving	Minimum power management. Suspend Mode=1 hr.
Max Saving	Maximum power management. Suspend Mode=1 min.
User Define	Allows user to set each mode individually. Suspend Mode= Disabled or 1 min ~1 hr.
- **Video Off Method [DPMS]**
This item allows user to determine the manner in which the monitor is blanked.

V/H SYNC+Blank	This option will cause system to turn off vertical and horizontal synchronization ports and write blanks to the video buffer.
Blank Screen	This option only writes blanks to the video buffer.
DPMS	Initial display power management signaling.
- **Video Off In Suspend [Yes]**
This item allows users to turn off video when system is in suspend mode.
- **Suspend Type [Stop Grant]**
This item allows users to determine the suspend type.

- **Modem use IRQ [3]**
This item allows users to determine which IRQ the MODEM can use.
- **Suspend Mode [Disabled]**
This item allows users to set a delay time. If system inactivity exceeds the delay time, all devices except the CPU will be shut off.
- **Soft-Off by PWR-BTTN [Instant-Off]**
This item allows users to define function of power button.

Instant-Off	Press power button for instant power off.
Delay 4 Sec	Press power button for four seconds to initiate power off.
- **PowerOn by LAN [Enabled]**
This item allows users to power on the system via LAN. The choices are "Enabled" and "Disabled".
- **PowerOn by Modem [Enabled]**
This item allows users to power on the system by Modem. The choices are "Enabled" and "Disabled".
- **USB KB Wake_Up From S3 [Disabled]**
This item allows users to allow a USB keyboard to wake up the system from S3 suspend. Options: Enabled or Disabled.
- **PowerOn by Alarm [Disabled]**
The choices are "Enabled" and "Disabled". If enabled, the fields that follow indicate dates and times of alarm settings.
- **PWRON After PWR-Fail [ON/Off/Former-Sts]**
Use this to set up the system after power failure. The "Off" setting keeps the system powered off after power failure, the "On" setting boots up the system after failure, and the "Former-Sts" returns the system to the status before power failure.

3.2.10 PnP/PCI Configurations

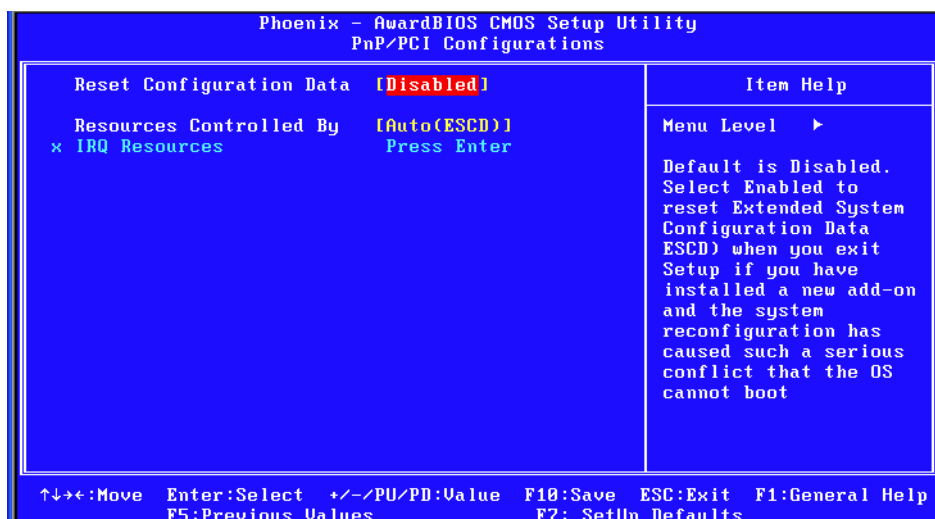

- **Reset Configuration Data [Disabled]**
The default is Disabled. Select Enabled to reset Extended System Configuration Data (ESCD) if you have installed a new add-on card, and system configuration is in such a state that the OS cannot boot.
- **Resources Controlled By [Auto(ESCD)]**
The commands here are "Auto(ESCD)" or "Manual". Choosing "Manual" requires you to choose resources from the following sub-menu. "Auto(ESCD)" automatically configures all of the boot and Plug and Play devices, but you must be using Windows 95 or above.

3.2.11 PC Health Status

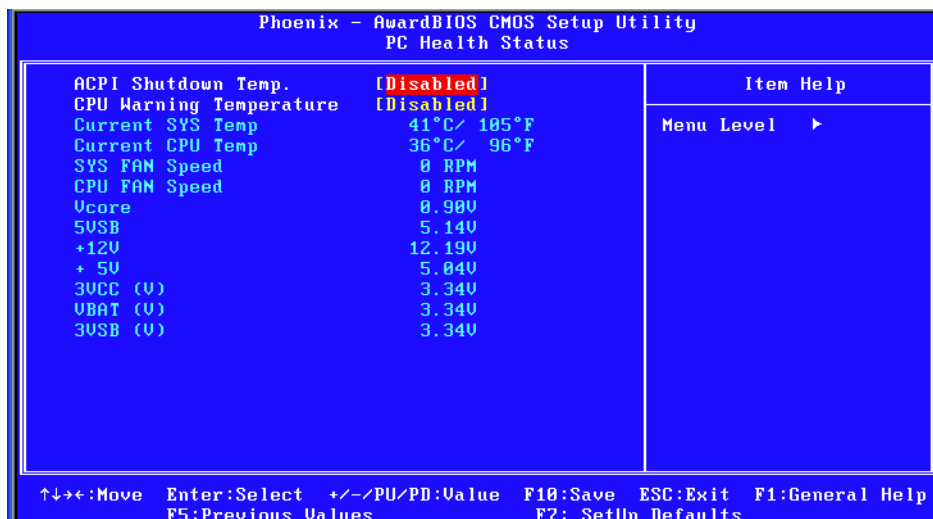

- **ACPI Shutdown Temperature [Disabled]**
The system will shut down automatically if the CPU temperature goes over the selected setting.
- **CPU Warning Temperature [Disabled]**
The system will give an automatic warning if the CPU temperature goes over the selected setting.
- **Current System Temperature**
This shows you the current temperature of system.
- **Current CPU Temperature**
This shows the current CPU temperature.
- **VCORE and Other Voltages**
This shows the voltage of VCORE, +3.3 V, +5 V, +12 V, -12 V, VBAT(V), and 5 VSB (V).

3.2.12 Frequency/Voltage Control

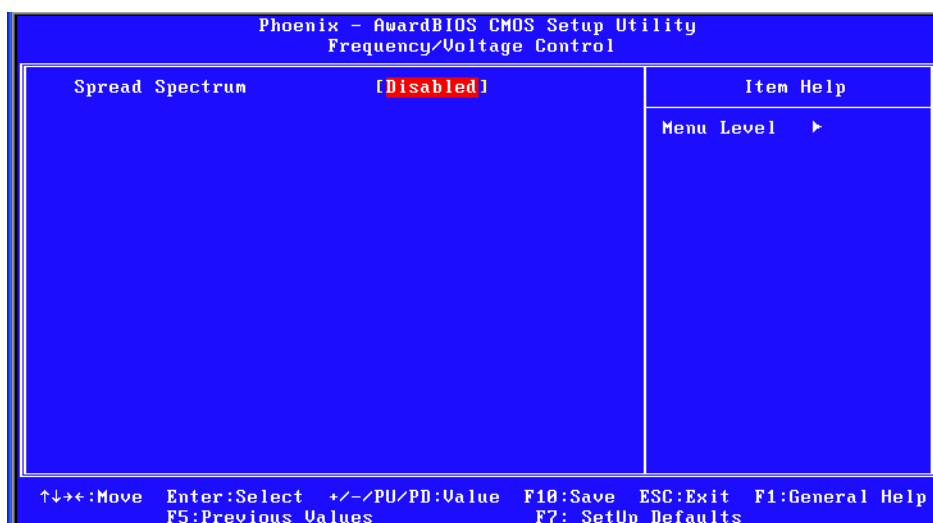

- **Spread Spectrum [Disabled]**
This item enables users to set the spread spectrum modulation.

3.2.13 Load Setup Defaults

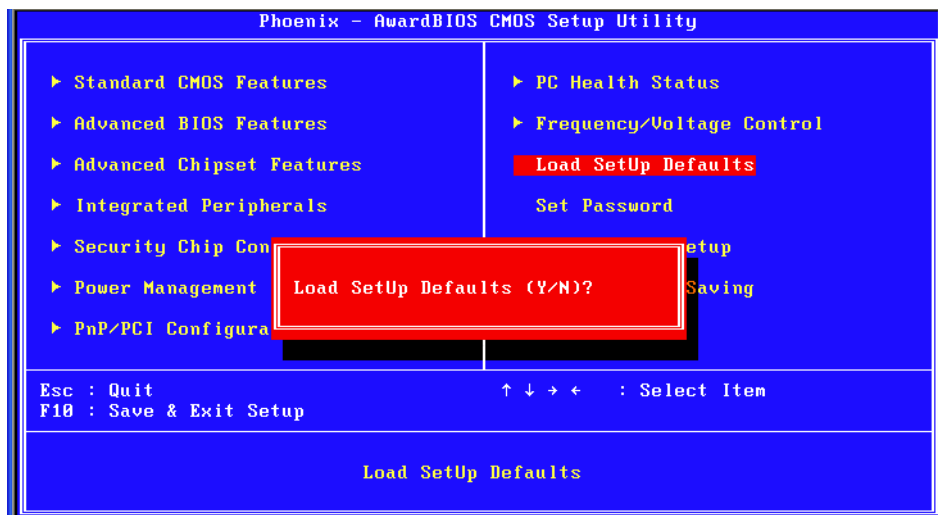

Note! *Load Setup Defaults loads the default system values directly from ROM. Useful if the stored record created by the Setup program should ever become corrupted (and therefore unusable).*



3.2.14 Set Password

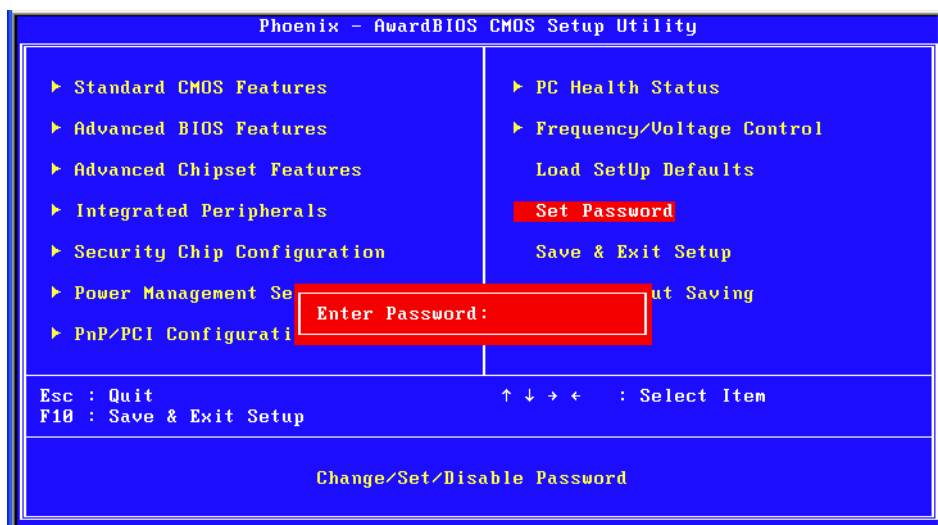

Note! *To enable this feature, you should first go to the Advanced BIOS Features menu, choose the Security Option, and select either Setup or System, depending on which aspect you want password protected. "Setup" requires a password only to enter Setup. "System" requires the password either to enter Setup or to boot the system. A password can be at most 8 characters long.*



To Establish Password

1. Choose the Set Password option from the CMOS Setup Utility main menu and press <Enter>.
2. When you see “Enter Password”, enter the desired password and press <Enter>.
3. At the “Confirm Password” prompt, retype the desired password, then press <Enter>.
4. Select Save to CMOS and EXIT, type <Y>, then <Enter>.

To Change Password

1. Choose the Set Password option from the CMOS Setup Utility main menu and press <Enter>.
2. When you see “Enter Password”, enter the existing password and press <Enter>.
3. You will see “Confirm Password”. Type it again, and press <Enter>.
4. Select Set Password again, and at the “Enter Password” prompt, enter the new password and press <Enter>.
5. At the “Confirm Password” prompt, retype the new password, and press <Enter>.
6. Select Save to CMOS and EXIT, type <Y>, then <Enter>.

To Disable Password

1. Choose the Set Password option from the CMOS Setup Utility main menu and press <Enter>.
2. When you see “Enter Password”, enter the existing password and press <Enter>.
3. You will see “Confirm Password”. Type it again, and press <Enter>.
4. Select Set Password again, and at the “Enter Password” prompt, please don’t enter anything; just press <Enter>.
5. At the “Confirm Password” prompt, again, don’t type in anything; just press <Enter>.
6. Select Save to CMOS and EXIT, type <Y>, then <Enter>.

3.2.15 Save & Exit Setup

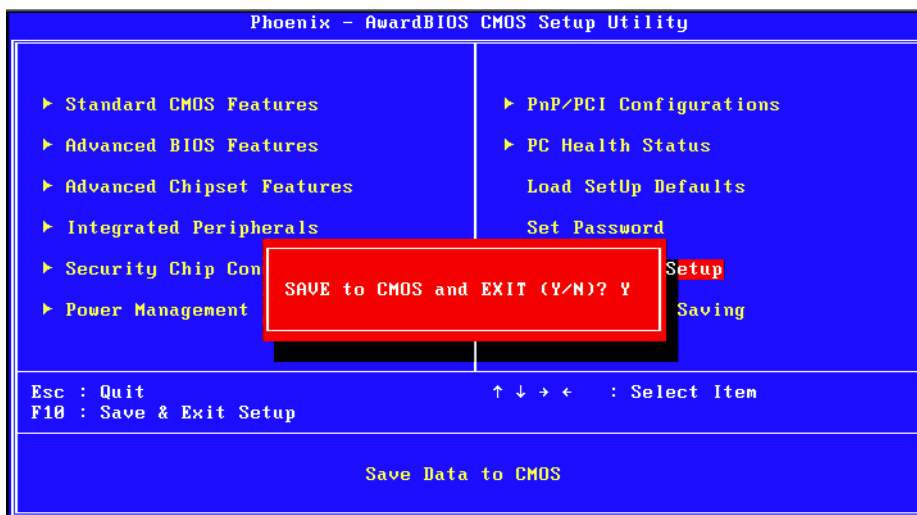

Note! Typing "Y" will quit the BIOS Setup Utility and save user setup values to CMOS.
 Typing "N" will return to BIOS Setup Utility.

3.2.16 Quit without Saving

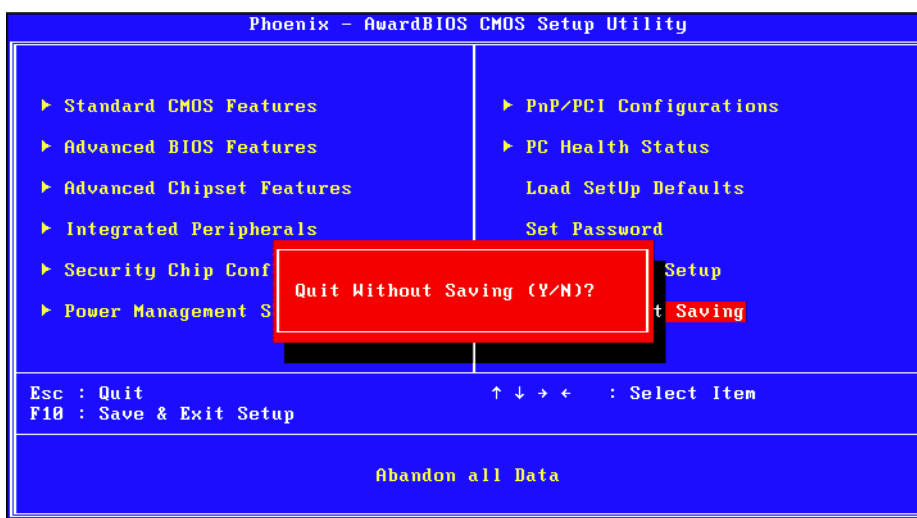

Note! Typing "Y" will quit the BIOS Setup Utility without saving to CMOS.
 Typing "N" will return to BIOS Setup Utility.

Chapter 4

Chipset Software Installation Utility

4.1 Before You Begin

To facilitate the installation of the enhanced display drivers and utility software, read the instructions in this chapter carefully. The drivers for the AIMB-210 are located on the software installation CD. The driver in the folder of the driver CD will guide and link you to the utilities and drivers under a Windows system. Updates are provided via Service Packs from Microsoft*.

Note! *The files on the software installation CD are compressed. Do not attempt to install the drivers by copying the files manually. You must use the supplied SETUP program to install the drivers.*



Before you begin, it is important to note that most display drivers need to have the relevant software application already installed in the system prior to installing the enhanced display drivers. In addition, many of the installation procedures assume that you are familiar with both the relevant software applications and operating system commands. Review the relevant operating system commands and the pertinent sections of your application software's user manual before performing the installation.

4.2 Introduction

The Intel® Chipset Software Installation (CSI) utility installs the Windows INF files that outline to the operating system how the chipset components will be configured. This is needed for the proper functioning of the following features:

- Core PCI PnP services
- IDE Ultra ATA 100/66/33 and Serial ATA interface support
- USB 1.1/2.0 support (USB 2.0 driver needs to be installed separately for Win98)
- Identification of Intel® chipset components in the Device Manager
- Integrates superior video features. These include filtered sealing of 720 pixel DVD content, and MPEG-2 motion compensation for software DVD

Note! *This utility is used for the following versions of Windows, and it has to be installed **before** installing all the other drivers:*



- Windows 2000
- Windows XP
- Windows Vista

4.3 Windows XP Driver Setup

1. Insert the driver CD into your system's CD-ROM drive. You can see the driver folder items. Navigate to the "Drv_INF" folder and click "infinst_autol.exe" to complete the installation of the driver.

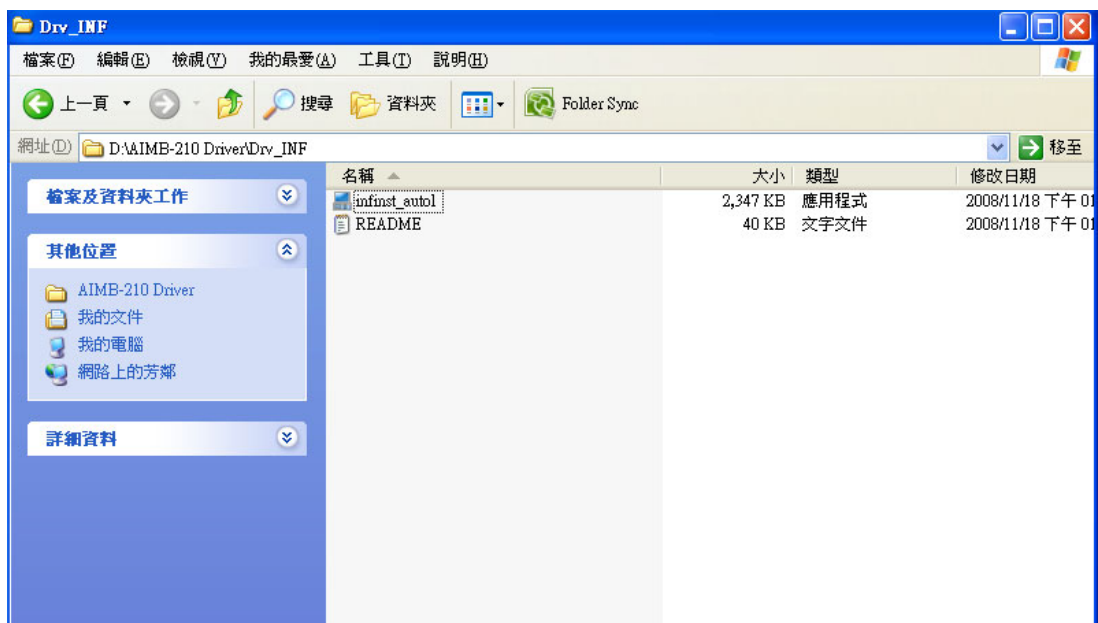
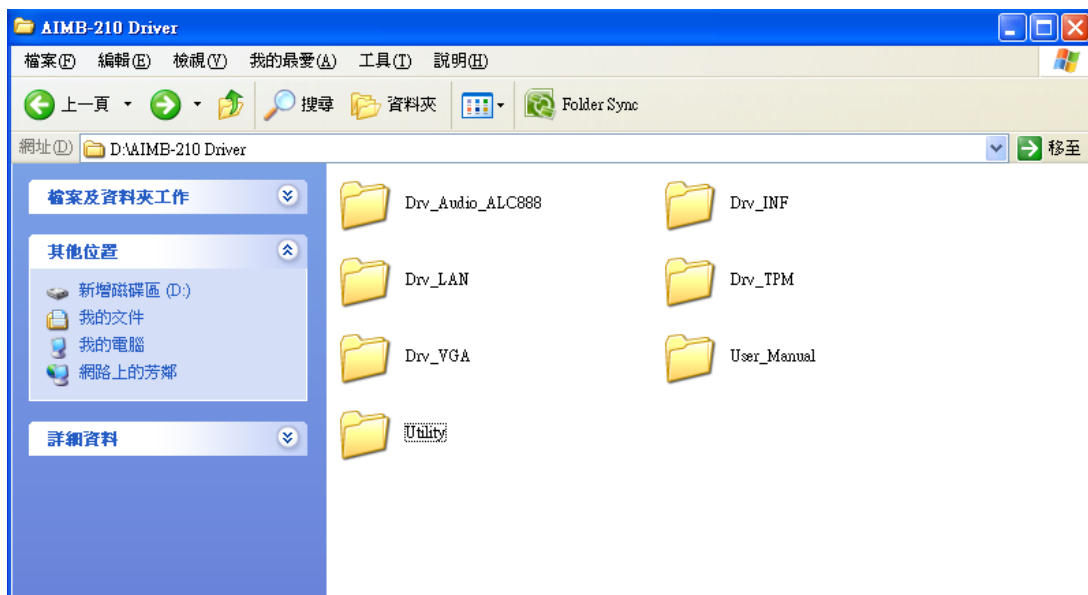

Chapter 5

VGA Setup

5.1 Introduction

To benefit from the Intel® 945GSE integrated graphics controller, you need to install the VGA driver. The Intel® 945GSE integrated graphics controller includes the following features:

- Intel® Graphics Media Accelerator 950: Incorporating the latest Microsoft* DirectX*9 support capabilities. Dual independent display, enhanced display modes for widescreen flat panels, and optimized 3D support deliver an intense and realistic visual experience without requiring a separate graphics card.

5.2 Windows Vista/XP/2000

Note! Before installing this driver, make sure the CSI utility has been installed in your system. See Chapter 4 for information on installing the CSI utility.



Insert the driver CD into your system's CD-ROM drive. You can see the driver folders items. Navigate to the "Drv_VGA" folder and click "setup.exe" to complete the installation of the drivers for Vista, Windows XP, and Windows 2000.

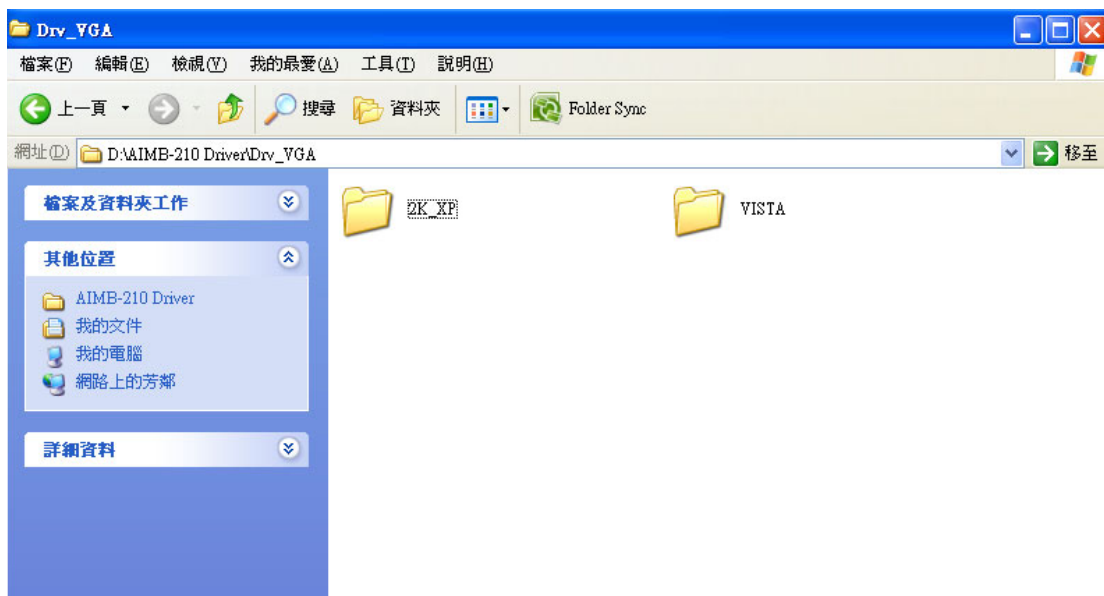

Chapter 6

LAN Configuration

6.1 Introduction

The AIMB-210 has a dual Gigabit Ethernet LAN via dedicated PCI Express x 1 bus (Realtek RTL8111C), which offers bandwidth of up to 500 MB/sec, eliminating the bottleneck of network data flow and incorporating Gigabit Ethernet to operate at 1000 Mbps.

6.2 Features

- Integrated 10/100/100 Mbps transceiver
- 10/100/1000 Mbps triple-speed MAC
- High-speed RISC core with 24-KB cache
- On-chip voltage regulation
- Wake-on-LAN (WOL) support
- PCI Express X1 host interface

6.3 Installation

Note! Before installing the LAN drivers, make sure the CSI utility has been installed on your system. See Chapter 4 for information on installing the CSI utility.



The AIMB-210 Realtek RTL8111C Gigabit integrated controller supports all major network operating systems. However, the installation procedure varies with different operating systems. Please find and use the section that provides the driver setup procedure for the operating system you are using.

6.4 Win XP/Vista Driver Setup (Realtek RTL8111C)

Insert the driver CD into your system's CD-ROM drive. Select the Drv_LAN folder then navigate to the directory for your OS.

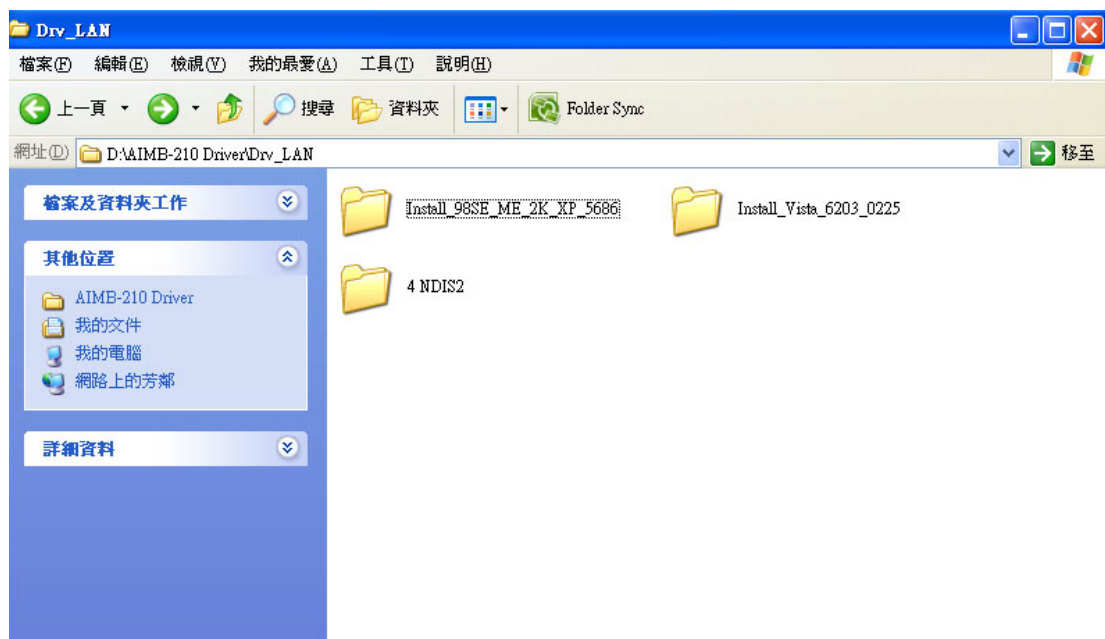

Appendix **A**

Programming the Watchdog Timer

A.1 Programming the Watchdog Timer

The AIMB-210's watchdog timer can be used to monitor system software operation and take corrective action if the software fails to function within the programmed period. This section describes the operation of the watchdog timer and how to program it.

A.1.1 Watchdog Timer Overview

The watchdog timer is built into the super I/O controller W83627DHG. It provides the following user-programmable functions:

- Can be enabled and disabled by user program
- Timer can be set from 1 to 255 seconds or 1 to 255 minutes
- Generates an interrupt or resets signal if the software fails to reset the timer before time-out

A.1.2 Programming the Watchdog Timer

The I/O port address of the watchdog timer is 2E (hex) and 2F (hex). 2E (hex) is the address port. 2F (hex) is the data port. You must first assign the address of register by writing an address value into address port 2E (hex), then write/read data to/from the assigned register through data port 2F (hex).

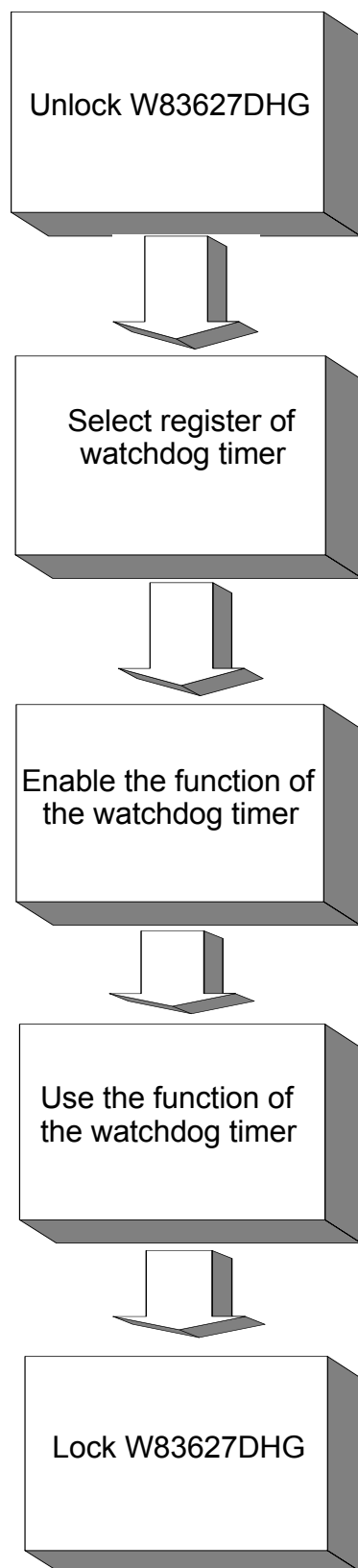

Table A.1: Watchdog Timer Registers

Address of Register (2E)	Attribute	Value (2F) & description
87 (hex)	-----	Write this address to I/O address port 2E (hex) twice to unlock the W83627DHG.
07 (hex)	write	Write 08 (hex) to select register of watchdog timer.
30 (hex)	write	Write 01 (hex) to enable the function of the watchdog timer. Disabled is set as default.
F5 (hex)	write	Set seconds or minutes as units for the timer. Write 0 to bit 3: set second as counting unit. [default] Write 1 to bit 3: set minutes as counting unit.
F6 (hex)	write	0: stop timer [default] 01~FF (hex): The amount of the count, in seconds or minutes, depends on the value set in register F5 (hex). This number decides how long the watchdog timer waits for strobe before generating an interrupt or reset signal. Writing a new value to this register can reset the timer to count with the new value.
F7 (hex)	read/write	Bit 7: Write 1 to enable mouse to reset the timer, 0 to disable [default]. Bit 6: Write 1 to enable keyboard to reset the timer, 0 to disable. [default] Bit 5: Write 1 to generate a timeout signal immediately and automatically return to 0. [default=0] Bit 4: Read status of watchdog timer, 1 means timer is "timeout".
AA (hex)	-----	Write this address to I/O port 2E (hex) to lock the watchdog timer 2.

A.1.3 Example Program

1. Enable watchdog timer and set 10 sec. as timeout interval

```

;-----
Mov dx,2eh ; Unlock W83627DHG
Mov al,87h
Out dx,al
Out dx,al
;-----
Mov al,07h ; Select registers of watchdog timer
Out dx,al
Inc dx
Mov al,08h
Out dx,al
;-----
Dec dx ; Enable the function of watchdog timer
Mov al,30h
Out dx,al
Inc dx
Mov al,01h
Out dx,al
;-----
Dec dx ; Set second as counting unit
Mov al,0f5h
Out dx,al
Inc dx
In al,dx
And al,not 08h
Out dx,al
;-----
Dec dx ; Set timeout interval as 10 seconds and start counting
Mov al,0f6h
Out dx,al
Inc dx
Mov al,10
Out dx,al
;-----
Dec dx ; Lock W83627DHG
Mov al,0aah
Out dx,al

```

2. Enable watchdog timer and set 5 minutes as timeout interval

```

;-----
Mov dx,2eh ; Unlock W83627DHG
Mov al,87h
Out dx,al
Out dx,al

```

```

;-----
Mov al,07h ; Select registers of watchdog timer
Out dx,al
Inc dx
Mov al,08h
Out dx,al
;-----
Dec dx ; Enable the function of watchdog timer
Mov al,30h
Out dx,al
Inc dx
Mov al,01h
Out dx,al
;-----
Dec dx ; Set minute as counting unit
Mov al,0f5h
Out dx,al
Inc dx
In al,dx
Or al,08h
Out dx,al
;-----
Dec dx ; Set timeout interval as 5 minutes and start counting
Mov al,0f6h
Out dx,al
Inc dx
Mov al,5
Out dx,al
;-----
Dec dx ; Lock W83627DHG
Mov al,0aah
Out dx,al
3. Enable watchdog timer to be reset by mouse
;-----
Mov dx,2eh ; Unlock W83627DHG
Mov al,87h
Out dx,al
Out dx,al
;-----
Mov al,07h ; Select registers of watchdog timer
Out dx,al
Inc dx
Mov al,08h
Out dx,al
;-----

```

```

Dec dx ; Enable the function of watchdog timer
Mov al,30h
Out dx,al
Inc dx
Mov al,01h
Out dx,al
;-----
Dec dx ; Enable watchdog timer to be reset by mouse
Mov al,0f7h
Out dx,al
Inc dx
In al,dx
Or al,80h
Out dx,al
;-----
Dec dx ; Lock W83627DHG
Mov al,0aah
Out dx,al
4. Enable watchdog timer to be reset by keyboard
;-----
Mov dx,2eh ; Unlock W83627DHG
Mov al,87h
Out dx,al
Out dx,al
;-----
Mov al,07h ; Select registers of watchdog timer
Out dx,al
Inc dx
Mov al,08h
Out dx,al
;-----
Dec dx ; Enable the function of watchdog timer
Mov al,30h
Out dx,al
Inc dx
Mov al,01h
Out dx,al
;-----
Dec dx ; Enable watchdog timer to be strobed reset by keyboard
Mov al,0f7h
Out dx,al
Inc dx
In al,dx
Or al,40h
Out dx,al

```

```

;-----
Dec dx ; Lock W83627DHG
Mov al,0aah
Out dx,al
5. Generate a time-out signal without timer counting
;-----
Mov dx,2eh ; Unlock W83627DHG
Mov al,87h
Out dx,al
Out dx,al
;-----
Mov al,07h ; Select registers of watchdog timer
Out dx,al
Inc dx
Mov al,08h
Out dx,al
;-----
Dec dx ; Enable the function of watchdog timer
Mov al,30h
Out dx,al
Inc dx
Mov al,01h
Out dx,al
;-----
Dec dx ; Generate a time-out signal
Mov al,0f7h
Out dx,al ;Write 1 to bit 5 of F7 register
Inc dx
In al,dx
Or al,20h
Out dx,al
;-----
Dec dx ; Lock W83627DHG
Mov al,0aah
Out dx,al

```

Appendix **B**

I/O Pin Assignments

B.1 Parallel Port (LPT1)

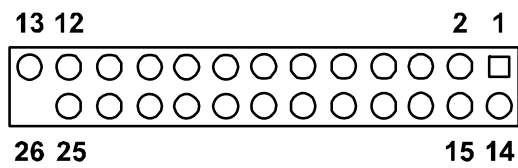

Table B.1: Parallel Port (LPT1)

Pin	Signal	Pin	Signal
1	STROBE*	14	AUTOFD*
2	D0	15	ERR
3	D1	16	INIT*
4	D2	17	SLCTINI*
5	D3	18	GND
6	D4	19	GND
7	D5	20	GND
8	D6	21	GND
9	D7	22	GND
10	ACK*	23	GND
11	BUSY	24	GND
12	PE	25	GND
13	SLCT	26	N/C

* Low activity

B.2 USB Header (USB56, USB78)

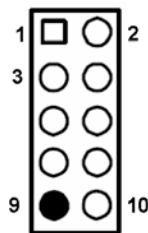

Table B.2: USB Header (USB56)

Pin	Signal	Pin	Signal
1	USB0_VCC5	2	USB1_VCC5
3	USB0_D-	4	USB1_D-
5	USB0_D+	6	USB1_D+
7	GND	8	GND
9	Key	10	GND

B.3 VGA Connector (VGA1)

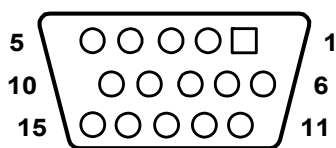

Table B.3: VGA Connector (VGA1)

Pin	Signal	Pin	Signal
1	RED	9	CRT_VCCIN
2	VGA_G	10	GND
3	VGA_B	11	N/C
4	N/C	12	V_SDAT
5	GND	13	H-SYNC
6	GND	14	V-SYNC
7	GND	15	V_SCLK

B.4 RS-232 Interface

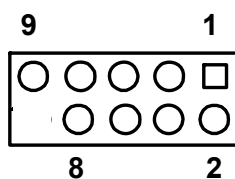

Table B.4: RS-232 Interface (COM1~COM4)

Pin	Signal
1	DCD
2	DSR
3	RXD
4	RTS
5	TXD
6	CTS
7	DTR
8	RRI
9	GND

B.5 RS-232/422/485 Setting Interface (JETCOM2)

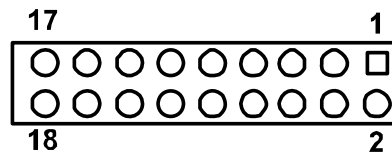

Table B.5: RS-232/422/485 Setting Interface (JETCOM2)

Pin	Signal	Pin	Signal
1	R_SINA	2	RXD485_1
3	R_SINA	4	RXD422_1
5	R_SINA	6	RXD232_1
7	DCDA	8	SOUTA
9	COM1_DCD#	10	COM1_SOUT
11	COM1_TXD485N	12	COM1_RXD485P
13	SINA	14	DTRA
15	COM1_SIN	16	COM1_DTR#
17	COM1_TXD485P	18	COM1_RXD485N

B.6 SPI_CN1: SPI Fresh Card Pin Connector

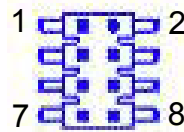

Table B.6: SPI_CN1:SPI Fresh Card Pin Connector

Pin	Signal	Pin	Signal
1	+F1_3V	2	GND
3	F1_SPI_CS#_Q	4	F1_SPI_CLK_Q
5	F1_SPI_MISO_Q	6	F1_SPI_MOSI_Q
7	NC	8	NC

B.7 PS/2 Keyboard and Mouse Connector (KBMS1)



Table B.7: PS/2 Keyboard and Mouse Connector (KBMS1)

Pin	Signal
1	KB DATA
2	N/C
3	GND
4	KB VCC
5	KB CLK
6	N/C
7	M_DATA
8	N/C
9	GND
10	M_VCC
11	M_CLK
12	N/C

B.8 CPU Fan Power Connector (CPU_FAN1)

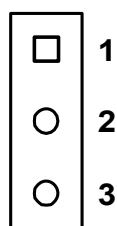

Table B.8: CPU Fan Power Connector (CPU_FAN1)

Pin	Signal
1	GND
2	+12 V
3	DETECT
4	PWM

B.9 System Fan Power Connector (CHA_FAN1)

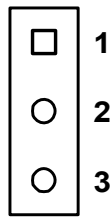

Table B.9: System Fan Power Connector (SYSFAN1/SYSFAN2)

Pin	Signal
1	GND
2	+12 V
3	DETECT

B.10 Power LED & Keyboard Lock Connector (JFP3)

You can use an LED to indicate when the single board computer is on. Pin 1 of JFP3 supplies the LED's power, and Pin 3 is the ground.

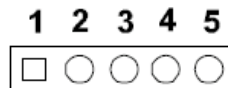

Table B.10: Power LED & Keyboard Lock Connector (JFP3)

Pin	Function
1	LED power (+5 V)
2	NC
3	GND
4	KEYLOCK#
5	GND

B.11 HDD LED and External Speaker Connector (JFP2/HDD LED and SPEAKER)

The single board computer has its own buzzer. You can also connect it to the external speaker on your computer chassis.

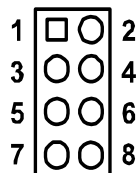

Table B.11: External Speaker Connector (JFP2/SPEAKER)

Pin	Signal	Pin	Signal
1	SPK+	2	HDDLED+
3	NC	4	HDDLED-
5	SPK_IN	6	SMB_DAATA
7	SPK-	8	SMB_CLK

B.12 ATX Soft Power Switch and Reset Connector (JFP1/ PWR-SW and RESET)

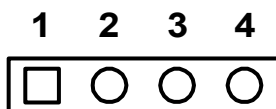

Table B.12: Reset Connector (JFP1/ RESET)

Pin	Signal
1	PWR_BTN#
2	GND
3	RESET
4	GND

B.13 ATX Power Connector (EATXPWR1)

Table B.13: ATX Power Connector (ATX2)

Pin	Signal	Pin	Signal
1	+3.3 V	2	+3.3 V
3	GND	4	+5 V
5	GND	6	+5 V
7	GND	8	POK
9	5 VSB	10	12 V
11	+3.3 V	12	-12 V
13	GND	14	PSON
15	GND	16	GND
17	GND	18	-5 V
19	+5 V	20	+5 V

B.14 USB/LAN ports (LAN1_USB12/LAN2_USB34)

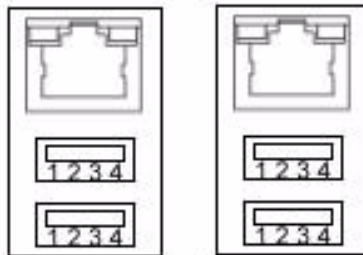

Table B.14: USB Port

Pin	Signal	Pin	Signal
1	VCC	3	Data0+
2	Data0-	4	GND

Table B.15: Ethernet 10/100 Mbps RJ-45 Port

Pin	Signal	Pin	Signal
1	XMT+	5	N/C
2	XMT-	6	RCV-
3	RCV+	7	N/C
4	N/C	8	N/C

B.15 Line In, Line Out, Mic In Connector (AUDIO1)

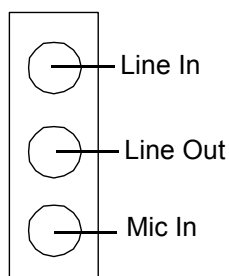

B.16 Serial ATA0/1 (SATA1/SATA2)

Table B.16: Serial ATA 0/1 (SATA1/SATA2)

Pin	Signal	Pin	Signal
1	GND	2	SATA_0TX+
3	SATA_0TX-	4	GND
5	SATA_0RX-	6	SATA_0RX+
7	GND	8	

B.17 AT/ATX Mode (PSON1)

Table B.17: AT/ATX Mode (PSON1)

Pin	Signal	Pin	Signal
1	#PSON_SIO (to super IO)	2	#PSON (to power supply)
3	GND		

B.18 AC-97 Audio Interface (FPAUD1)

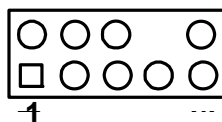

Table B.18: AT/ATX Mode (PSON1)

Pin	Signal	Pin	Signal
1	MIC-IN	2	GND
3	MIC_VCC	4	VCC
5	LRR	6	LOUT_R
7	JDO	8	NC
9	LRL	10	LOUT_L

B.19 GPIO Pin Header (GPIO1)

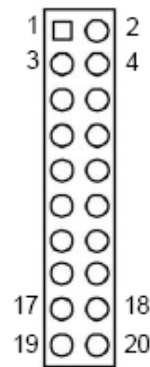

Table B.19: AT/ATX Mode (PSON1)

Pin	Signal	Pin	Signal
1	DIO_GP20	2	DIO_GP10
3	DIO_GP21	4	DIO_GP11
5	DIO_GP22	6	DIO_GP12
7	DIO_GP23	8	DIO_GP13
9	DIO_GP24	10	DIO_GP14
11	DIO_GP25	12	DIO_GP15
13	DIO_GP26	14	DIO_GP16
15	DIO_GP27	16	DIO_GP17
17	SMBCLK_PCI	18	SMBDATA_PCI
19	GND	20	VCC5_DIO

B.20 LVDS Connector: LVDS1 & LVDS2 (Optional)

LVDS 1		LVDS 2	
VDDSAFE_1	<input type="checkbox"/>	VDDSAFE_2	<input type="checkbox"/>
GND_1	<input type="checkbox"/>	GND_7	<input type="checkbox"/>
VDDSAFE_3	<input type="checkbox"/>	VDDSAFE_4	<input type="checkbox"/>
OD0-	<input type="checkbox"/>	ED0-	<input type="checkbox"/>
OD0+	<input type="checkbox"/>	ED0+	<input type="checkbox"/>
GND_2	<input type="checkbox"/>	GND_8	<input type="checkbox"/>
OD1-	<input type="checkbox"/>	ED1-	<input type="checkbox"/>
OD1+	<input type="checkbox"/>	ED1+	<input type="checkbox"/>
GND_3	<input type="checkbox"/>	GND_9	<input type="checkbox"/>
OD2-	<input type="checkbox"/>	ED2-	<input type="checkbox"/>
OD2+	<input type="checkbox"/>	ED2+	<input type="checkbox"/>
GND_4	<input type="checkbox"/>	GND_10	<input type="checkbox"/>
OCK-	<input type="checkbox"/>	ECK-	<input type="checkbox"/>
OCK+	<input type="checkbox"/>	ECK+	<input type="checkbox"/>
GND_5	<input type="checkbox"/>	GND_11	<input type="checkbox"/>
DDC_CLK	<input type="checkbox"/>	DDC_DAT	<input type="checkbox"/>
GND_6	<input type="checkbox"/>	GND_12	<input type="checkbox"/>
NC	<input type="checkbox"/>	NC	<input type="checkbox"/>
NC	<input type="checkbox"/>	NC	<input type="checkbox"/>
HPLG	<input type="checkbox"/>	VCON	<input type="checkbox"/>

Table B.20: LVDS1 Connector (Optional)

Pin	Signal	Pin	Signal
1	VDDSAFE_1	2	VDDSAFE_2
3	GND_1	4	GND_7
5	VDDSAFE_3	6	VDDSAFE_4
7	OD0-	8	ED0-
9	OD0+	10	ED0+
11	GND_2	12	GND_8
13	OD1-	14	ED1-
15	OD1+	16	ED1+
17	GND_3	18	GND_9
19	OD2-	20	ED2-
21	OD2+	22	ED2+
23	GND_4	24	GND_10
25	OCK-	26	ECK-
27	OCK+	28	ECK+
29	GND_3	30	GND_11
31	DDC_CLK	32	DDC_DAT
33	GND_6	34	GND_12
35	NC	36	NC
37	NC	38	NC
39	HPLG	40	VCON

Table B.21: LVDS2 Connector (Optional)

Pin	Signal	Pin	Signal
1	VDDSAFE_1	2	VDDSAFE_2
3	GND_1	4	GND_7
5	VDDSAFE_3	6	VDDSAFE_4
7	OD0-	8	ED0-
9	OD0+	10	ED0+
11	GND_2	12	GND_8
13	OD1-	14	ED1-
15	OD1+	16	ED1+
17	GND_3	18	GND_9
19	OD2-	20	ED2-
21	OD2+	22	ED2+
23	GND_4	24	GND_10
25	OCK-	26	ECK-
27	OCK+	28	ECK+
29	GND_3	30	GND_11
31	DDC_CLK	32	DDC_DAT
33	GND_6	34	GND_12
35	OD3-	36	ED3-
37	OD3+	38	ED3+
39	HPLG	40	VCON

B.21 LVDS Power Jumper (JLV1, JLV2)

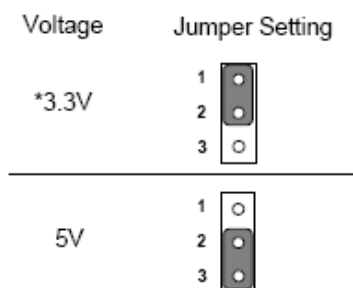

* default setting

Table B.22: LVDS Power Jumper

Pin	Signal
1	VCC3
2	VCC_LCD
3	VCC

B.22 LVDS Invert: INV1 & INV2 (Optional)

Table B.23: LVDS Power Jumper

Pin	Signal
1	VCC12
2	GND
3	BKLTEN
4	VBR
5	VCC

B.23 System I/O Ports

Table B.24: System I/O Ports

Addr. range (Hex)	Device
000-01F	Interrupt controller 1, master
022-023	Chipset address
040-05F	8254 timer
060-06F	8042 (keyboard controller)
070-07F	Real-time clock, non-maskable interrupt (NMI) mask
080-09F	DMA page register
0A0-0BF	Interrupt controller 2
0C0-0DF	DMA controller
0F0	Clear math co-processor
0F1	Reset math co-processor
0F8-0FF	Math co-processor
1F0-1F8	Fixed disk
200-207	Game I/O
278-27F	Parallel printer port 2 (LPT3)
290-297	On-board hardware monitor
2F8-2FF	Serial port 2
360-36F	Reserved
378-37F	Parallel printer port 1 (LPT2)
380-38F	SDLC, bisynchronous 2
3A0-3AF	Bisynchronous 1
3B0-3BF	Monochrome display and printer adapter (LPT1)
3C0-3CF	Reserved
3D0-3DF	Color/graphics monitor adapter
3F0-3F7	Diskette controller
3F8-3FF	Serial port 1
4E0-4E7	Serial port 4
3E8-3EF	Serial port 6
4F0-4F8	Serial port 3
4F8-4FF	Serial port 5

B.24 DMA Channel Assignments

Table B.25: DMA Channel Assignments

Channel	Function
0	Available
1	Available
2	Floppy disk (8-bit transfer)
3	Available
4	Cascade for DMA controller 1
5	Available
6	Available
7	Available

B.25 Interrupt Assignments

Table B.26: Interrupt Assignments

Priority	Interrupt#	Interrupt source
1	NMI	Parity error detected
2	IRQ0	Interval timer
3	IRQ1	Keyboard
-	IRQ2	Interrupt from controller 2 (cascade)
4	IRQ8	Real-time clock
5	IRQ9	Cascaded to INT 0A (IRQ 2)
6	IRQ10	Serial communication port 3/5
7	IRQ11	Serial communication port 4/6
8	IRQ12	PS/2 mouse
9	IRQ13	INT from co-processor
10	IRQ14	Primary IDE Channel
11	IRQ15	Secondary IDE Channel
12	IRQ3	Serial communication port 2
13	IRQ4	Serial communication port 1
14	IRQ5	Available
15	IRQ6	Available
16	IRQ7	Parallel port 1 (print port)

B.26 1st MB Memory Map

Table B.27: 1st MB Memory Map

Addr. range (Hex)	Device
E0000h - FFFFFh	BIOS
CC000h - DFFFFh	Unused
C0000h - CBFFFh	VGA BIOS
A0000h - BFFFFh	Video Memory
00000h - 9FFFFh	Base memory

Trusted ePlatform Services

ADVANTECH

www.advantech.com

Please verify specifications before quoting. This guide is intended for reference purposes only.

All product specifications are subject to change without notice.

No part of this publication may be reproduced in any form or by any means, electronic, photocopying, recording or otherwise, without prior written permission of the publisher.

All brand and product names are trademarks or registered trademarks of their respective companies.

© Advantech Co., Ltd. 2009

Free Manuals Download Website

<http://myh66.com>

<http://usermanuals.us>

<http://www.somanuals.com>

<http://www.4manuals.cc>

<http://www.manual-lib.com>

<http://www.404manual.com>

<http://www.luxmanual.com>

<http://aubethermostatmanual.com>

Golf course search by state

<http://golfingnear.com>

Email search by domain

<http://emailbydomain.com>

Auto manuals search

<http://auto.somanuals.com>

TV manuals search

<http://tv.somanuals.com>