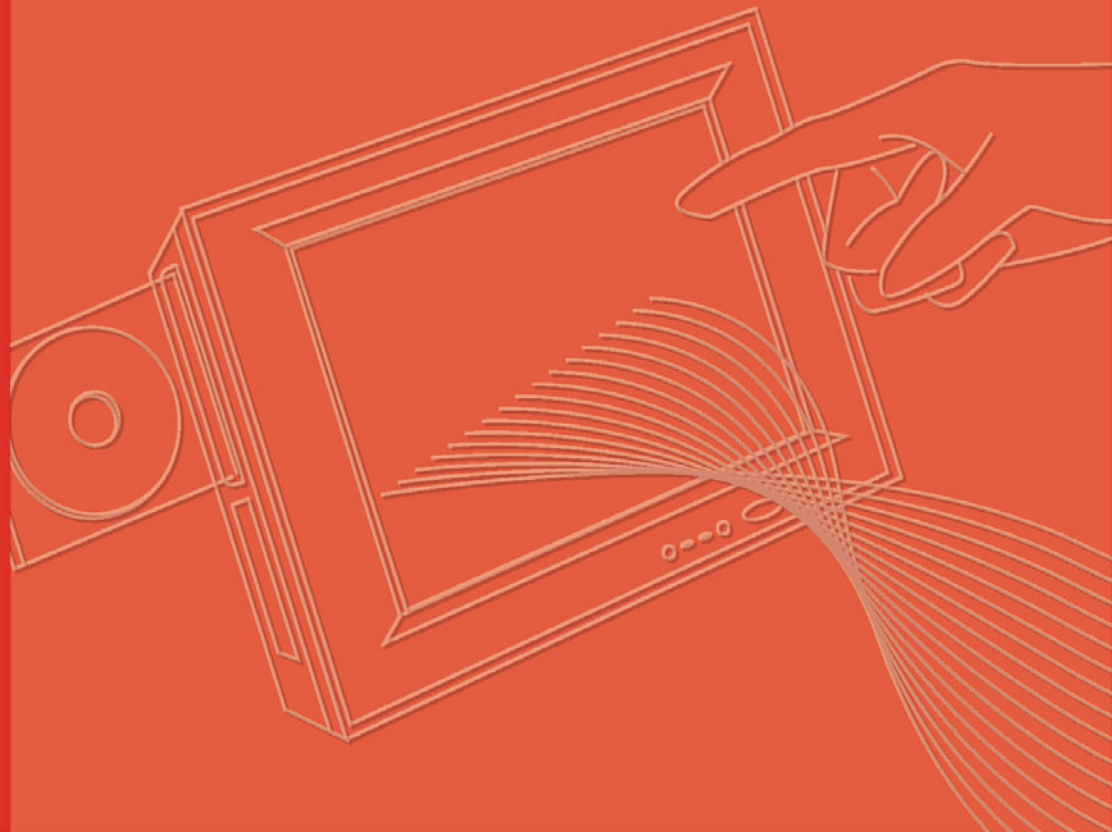


**User Manual**



## **PPC-175T**

**Pentium / Celeron M Processor-  
Based Panel PC with 17" Color  
TFT LCD Display**

*Trusted ePlatform Services*

**ADVANTECH**

## Copyright

The documentation and the software included with this product are copyrighted 2007 by Advantech Co., Ltd. All rights are reserved. Advantech Co., Ltd. reserves the right to make improvements in the products described in this manual at any time without notice. No part of this manual may be reproduced, copied, translated or transmitted in any form or by any means without the prior written permission of Advantech Co., Ltd. Information provided in this manual is intended to be accurate and reliable. However, Advantech Co., Ltd. assumes no responsibility for its use, nor for any infringements of the rights of third parties, which may result from its use.

## Acknowledgements

*Award* is a trademark of *Award Software International, Inc.*

*VIA* is a trademark of *VIA Technologies, Inc.*

*IBM, PC/AT, PS/2* and *VGA* are trademarks of *International Business Machines Corp.*

*Intel* and *Pentium* are trademarks of *Intel Corporation.*

*Microsoft WindowsÆ* is a registered trademark of *Microsoft Corp.*

*RTL* is a trademark of *Realtek Semi-Conductor Co., Ltd.*

*Winbond* is a trademark of *Winbond Electronics Corporation.*

*Ricoh* is a trademark of *Ricoh Company LTD.*

All other product names or trademarks are properties of their respective owners.

- For more information on this and other Advantech products, please visit our websites at:
  - <http://www.advantech.com>
  - <http://www.advantech.com/ppc>
- For technical support and service, please visit our support website at:
  - <http://support.advantech.com>

This manual supports the PPC-175T.

## Product Warranty (2 years)

Advantech warrants to you, the original purchaser, that each of its products will be free from defects in materials and workmanship for two years from the date of purchase.

This warranty does not apply to any products which have been repaired or altered by persons other than repair personnel authorized by Advantech, or which have been subject to misuse, abuse, accident or improper installation. Advantech assumes no liability under the terms of this warranty as a consequence of such events.

Because of Advantech's high quality-control standards and rigorous testing, most of our customers never need to use our repair service. If an Advantech product is defective, it will be repaired or replaced at no charge during the warranty period. For out-of-warranty repairs, you will be billed according to the cost of replacement materials, service time and freight. Please consult your dealer for more details.

If you think you have a defective product, follow these steps:

1. Collect all the information about the problem encountered. (For example, CPU speed, Advantech products used, other hardware and software used, etc.) Note anything abnormal, and list any onscreen messages when the problem occurs.
2. Call your dealer and describe the problem. Please have the manual, product, and any helpful information readily available.
3. If the product is diagnosed as defective, obtain an RMA (return merchandise authorization) number from the dealer. This allows Advantech to process the return more quickly.
4. Carefully pack the defective product, a fully-completed Repair and Replacement Order Card and a photocopy proof of purchase date (such as your sales receipt) in a shippable container. A product returned without proof of the purchase date is not eligible for warranty service.
5. Write the RMA number visibly on the outside of the package and ship it prepaid to the dealer.

## Declaration of Conformity

### CE

This product has passed the CE test for environmental specifications when shielded cables are used for external wiring. We recommend the use of shielded cables. This kind of cable is available from Advantech. Please contact your local supplier for ordering information.

### CE

This product has passed the CE test for environmental specifications. Test conditions for passing included the equipment being operated within an industrial enclosure. In order to protect the product from being damaged by ESD (Electrostatic Discharge) and EMI leakage, we strongly recommend the use of CE-compliant industrial enclosure products.

### FCC Class A

Note: This equipment has been tested and found to comply with the limits for a Class A digital device, pursuant to part 15 of the FCC Rules. These limits are designed to provide reasonable protection against harmful interference when the equipment is operated in a commercial environment. This equipment generates, uses, and can

radiate radio frequency energy and, if not installed and used in accordance with the instruction manual, may cause harmful interference to radio communications. Operation of this equipment in a residential area is likely to cause harmful interference in which case the user will be required to correct the interference at his own expense.

### **FCC Class B**

Note: This equipment has been tested and found to comply with the limits for a Class B digital device, pursuant to part 15 of the FCC Rules. These limits are designed to provide reasonable protection against harmful interference in a residential installation. This equipment generates, uses and can radiate radio frequency energy and, if not installed and used in accordance with the instructions, may cause harmful interference to radio communications. However, there is no guarantee that interference will not occur in a particular installation. If this equipment does cause harmful interference to radio or television reception, which can be determined by turning the equipment off and on, the user is encouraged to try to correct the interference by one or more of the following measures:

- Reorient or relocate the receiving antenna.
- Increase the separation between the equipment and receiver.
- Connect the equipment into an outlet on a circuit different from that to which the receiver is connected.
- Consult the dealer or an experienced radio/TV technician for help.

### **FM**

This equipment has passed the FM certification. According to the National Fire Protection Association, work sites are classified into different classes, divisions and groups, based on hazard considerations. This equipment is compliant with the specifications of Class I, Division 2, Groups A, B, C and D indoor hazards.

## **Technical Support and Assistance**

1. Visit the Advantech web site at [www.advantech.com/support](http://www.advantech.com/support) where you can find the latest information about the product.
2. Contact your distributor, sales representative, or Advantech's customer service center for technical support if you need additional assistance. Please have the following information ready before you call:
  - Product name and serial number
  - Description of your peripheral attachments
  - Description of your software (operating system, version, application software, etc.)
  - A complete description of the problem
  - The exact wording of any error messages

## Warnings, Cautions and Notes

**Warning!** Warnings indicate conditions, which if not observed, can cause personal injury!



**Caution!** Cautions are included to help you avoid damaging hardware or losing data.



*Ex.: There is a danger of a new battery exploding if it is incorrectly installed. Do not attempt to recharge, force open, or heat the battery. Replace the battery only with the same or equivalent type recommended by the manufacturer. Discard used batteries according to the manufacturer's instructions.*

**Note!** If the unit you have bought is basic (i.e. without a CPU, HDD, or SDRAM), you will find this optional item in the accessory box..



## Document Feedback

To assist us with making improvements to this manual, we welcome comments and constructive criticism. Please send all suggestions in writing to: [support@advan-tech.com](mailto:support@advan-tech.com)

## Packing List

Before setting up the system, check that the items listed below are included and in good condition. If any item does not accord with the table, please contact your dealer immediately.

- PPC-175T series panel PC
- User's manual
- Accessories for PPC-175T
- A power cord is not included with this product, but is available for purchase as a separate option.
- "Drivers and Utilities" CD-ROM disc
- Heat sink (optional) (refer to Notes 1 and 2 below)

**Note!** If the supplied unit is the basic version (i.e. without a CPU, HDD, or SDRAM), look for optional items in the accessory box.



**Note!** If installing an Intel  $\text{\AE}$  processor, it is necessary to install a heat sink above the CPU. This will avoid heat damage to the CPU.



## Additional Information and Assistance

1. Visit the Advantech web site at [www.advantech.com](http://www.advantech.com) to can find the latest information about the product.
2. Contact the distributor, sales representative, or Advantech's customer service center for technical support and additional assistance. Please have the following information ready before calling:
  - Product name and serial number
  - Description of peripheral attachments
  - Description of software (operating system, version, application software, etc.)
  - A complete description of the problem
  - The exact wording of any error messages

### **Warning!**



1. *Input voltage rated 100-240 VAC, 50/60 Hz, 4 A.*
2. *Use a 3 V @ 196 mA lithium battery.*
3. *Packing: please carry the unit with both hands, handle with care.*
4. *Maintenance: to properly maintain and clean the surfaces, use only approved products or clean with a dry applicator.*
5. *CompactFlash: Turn off power before insert- ing or removing CompactFlash storage card.*

### **Contact information:**

Our European representative:

*Advantech Europe GmbH*  
Kolberger Strafle 7  
D-40599 Dusseldorf, Germany  
Tel: 49-211-97477350  
Fax: 49-211-97477300

## Safety Instructions

1. Read these safety instructions carefully.
2. Keep this User Manual for later reference.
3. Disconnect this equipment from any AC outlet before cleaning. Use a damp cloth. Do not use liquid or spray detergents for cleaning.
4. For plug-in equipment, the power outlet socket must be located near the equipment and must be easily accessible.
5. Keep this equipment away from humidity.
6. Put this equipment on a reliable surface during installation. Dropping it or letting it fall may cause damage.
7. The openings on the enclosure are for air convection. Protect the equipment from overheating. **DO NOT COVER THE OPENINGS.**
8. Make sure the voltage of the power source is correct before connecting the equipment to the power outlet.
9. Position the power cord so that people cannot step on it. Do not place anything over the power cord.
10. All cautions and warnings on the equipment should be noted.
11. If the equipment is not used for a long time, disconnect it from the power source to avoid damage by transient overvoltage.
12. Never pour any liquid into an opening. This may cause fire or electrical shock.
13. Never open the equipment. For safety reasons, the equipment should be opened only by qualified service personnel.
14. If one of the following situations arises, get the equipment checked by service personnel:
  15. The power cord or plug is damaged.
  16. Liquid has penetrated into the equipment.
  17. The equipment has been exposed to moisture.
  18. The equipment does not work well, or you cannot get it to work according to the user's manual.
  19. The equipment has been dropped and damaged.
  20. The equipment has obvious signs of breakage.
21. **DO NOT LEAVE THIS EQUIPMENT IN AN ENVIRONMENT WHERE THE STORAGE TEMPERATURE MAY GO BELOW -20° C (-4° F) OR ABOVE 60° C (140° F). THIS COULD DAMAGE THE EQUIPMENT. THE EQUIPMENT SHOULD BE IN A CONTROLLED ENVIRONMENT.**
22. **CAUTION: DANGER OF EXPLOSION IF BATTERY IS INCORRECTLY REPLACED. REPLACE ONLY WITH THE SAME OR EQUIVALENT TYPE RECOMMENDED BY THE MANUFACTURER, DISCARD USED BATTERIES ACCORDING TO THE MANUFACTURER'S INSTRUCTIONS.**
23. The sound pressure level at the operator's position according to IEC 704-1:1982 is no more than 70 dB (A).

**DISCLAIMER:** This set of instructions is given according to IEC 704-1. Advantech disclaims all responsibility for the accuracy of any statements contained herein.

## Wichtige Sicherheitshinweise

1. Bitte lesen sie Sich diese Hinweise sorgfältig durch.
2. Heben Sie diese Anleitung für den späteren Gebrauch auf.
3. Vor jedem Reinigen ist das Gerät vom Stromnetz zu trennen. Verwenden Sie Keine Flüssig-oder Aerosolreiniger. Am besten dient ein angefeuchtetes Tuch zur Reinigung.
4. Die Netzanschlussteckdose soll nahe dem Gerät angebracht und leicht zugänglich sein.
5. Das Gerät ist vor Feuchtigkeit zu schützen.
6. Bei der Aufstellung des Gerätes ist auf sicheren Stand zu achten. Ein Kippen oder Fallen könnte Verletzungen hervorrufen.
7. Die Belüftungsöffnungen dienen zur Luftzirkulation die das Gerät vor überhit-zung schützt. Sorgen Sie dafür, daB diese Öffnungen nicht abgedeckt werden.
8. Beachten Sie beim. AnschluB an das Stromnetz die AnschluBwerte.
9. Verlegen Sie die Netzanschlusbleitung so, daB niemand darüber fallen kann. Es sollte auch nichts auf der Leitung abgestellt werden.
10. Alle Hinweise und Warnungen die sich am Geräten befinden sind zu beachten.
11. Wird das Gerät über einen längeren Zeitraum nicht benutzt, sollten Sie es vom Stromnetz trennen. Somit wird im Falle einer Überspannung eine Beschädigung vermieden.
12. Durch die Lüftungsöffnungen dürfen niemals Gegenstände oder Flüssigkeiten in das Gerät gelangen. Dies könnte einen Brand bzw. elektrischen Schlag auslösen.
13. Öffnen Sie niemals das Gerät. Das Gerät darf aus Gründen der elektrischen Sicherheit nur von autorisiertem Servicepersonal geöffnet werden.
14. Wenn folgende Situationen auftreten ist das Gerät vom Stromnetz zu trennen und von einer qualifizierten Servicestelle zu überprüfen:
  15. Netzkabel oder Netzstecker sind beschädigt.
  16. Flüssigkeit ist in das Gerät eingedrungen.
  17. Das Gerät war Feuchtigkeit ausgesetzt.
  18. Wenn das Gerät nicht der Bedienungsanleitung entsprechend funktioniert oder Sie mit Hilfe dieser Anleitung keine Verbesserung erzielen.
  19. Das Gerät ist gefallen und/oder das Gehäuse ist beschädigt.
  20. Wenn das Gerät deutliche Anzeichen eines Defektes aufweist.
21. **VORSICHT:** Explosionsgefahr bei unsachgemaben Austausch der Batterie.Ersatz nur durch denselben oder einem vom Hersteller empfohlene-männlichen Typ. Entsorgung gebrauchter Batterien navh Angaben des Herstellers.
22. **ACHTUNG:** Es besteht die Explosionsgefahr, falls die Batterie auf nicht fach-männische Weise gewechselt wird. Verfangen Sie die Batterie nur gleicher oder entsprechender Type, wie vom Hersteller empfohlen. Entsorgen Sie Batterien nach Anweisung des Herstellers.
23. Der arbeitsplatzbezogene Schalldruckpegel nach DIN 45 635 Teil 1000 beträgt 70dB(A) oder weiger.

Haftungsausschluss: Die Bedienungsanleitungen wurden entsprechend der IEC-704-1 erstellt. Advantech lehnt jegliche Verantwortung für die Richtigkeit der in diesem Zusammenhang getätigten Aussagen ab.



## **Safety Precaution - Static Electricity**

Follow these simple precautions to protect yourself from harm and the products from damage.

- To avoid electrical shock, always disconnect the power from the PC chassis before working on it. Don't touch any components on the CPU card or other cards while the PC is on.
- Disconnect power before making any configuration changes. The sudden rush of power while connecting a jumper or installing a card may damage sensitive electronic components.



# Contents

---

<b>Chapter 1</b>	<b>General Information .....</b>	<b>2</b>
1.1	Introduction .....	2
1.2	Specifications.....	2
	Table 1.1: Touchscreen specifications .....	3
1.3	Dimensions .....	5
	Figure 1.1 Dimensions of PPC-175T .....	5
<b>Chapter 2</b>	<b>System Setup .....</b>	<b>8</b>
2.1	A Quick Tour of the Panel PC.....	8
	Figure 2.1 Front panel of PPC-175T .....	8
	Figure 2.2 Left side view of the panel PC.....	8
	Figure 2.3 I/O Peripheral Connectors Panel.....	9
	Figure 2.4 Rear view of the panel PC.....	9
2.2	Preparing for First-time Use .....	10
2.3	Installation Procedures .....	10
	2.3.1 Connecting the power cord.....	10
	2.3.2 Connecting the keyboard and mouse.....	10
	2.3.3 Switching on the power .....	10
2.4	Running the BIOS Setup Program.....	10
2.5	Installing System Software.....	11
2.6	Installing the Drivers .....	11
	Figure 2.5 Drivers and Utilities on the CD-ROM.....	11
<b>Chapter 3</b>	<b>Using the Panel PC .....</b>	<b>14</b>
3.1	Introduction .....	14
3.2	CD-ROM Drive (optional).....	14
	Figure 3.1 Inserting and ejecting a CD-ROM.....	14
3.3	PCMCIA.....	15
	Figure 3.2 Inserting and ejecting a PCMCIA card .....	15
3.4	PS/2 Mouse and Keyboard .....	15
3.5	PCI Bus Expansion .....	16
	Figure 3.3 PCI bus expansion .....	16
3.6	Serial COM Ports .....	17
	Figure 3.4 I/O ports.....	17
3.7	VGA Port.....	17
3.8	USB Ports .....	17
3.9	Audio Interface.....	18
3.10	Ethernet .....	18
3.11	Front Bezel LED and Light Sensor .....	18
	Figure 3.5 LED & light sensor.....	18
3.12	Touchscreen (Optional) .....	19
<b>Chapter 4</b>	<b>Hardware Installation.....</b>	<b>22</b>
4.1	Jumpers and Connectors.....	22
4.2	Disassembling the Panel PC .....	22
	Figure 4.1 Unfastening the HDD side cover .....	22
	Figure 4.2 Unfastening the rear cover .....	23
	Figure 4.3 Disconnecting the fan connector .....	23
	Figure 4.4 The PPC without the Rear Cover .....	24
4.3	Installing the 2.5" Hard Disk Drive .....	24

	Figure 4.5	Fastening the HDD metal frame to the HDD .....	24
	Figure 4.6	Plugging in the EIDE cable .....	25
	Figure 4.7	Aligning the HDD frame .....	25
4.4		Installing the Central Processing Unit (CPU).....	26
	Figure 4.8	Placing the CPU in the socket.....	26
	Figure 4.9	Tightening the screws on the CPU.....	27
	Figure 4.10	Placing the heatsink and fan on the CPU .....	27
	Figure 4.11	Fastening the CPU module to the motherboard..	28
4.5		Installing the DDR SDRAM Memory Module .....	29
	Figure 4.12	Placing the memory module in the DIMM .....	29
<b>Chapter 5</b>	<b>Jumpers &amp; Connectors .....</b>	<b>32</b>	
5.1		Jumpers and Connectors .....	32
	5.1.1	Setting jumpers .....	32
	5.1.2	Jumpers.....	32
	Table 5.1:	PCI slot voltage setting (JP2).....	33
	Table 5.2:	Clear CMOS (JP3) .....	33
	Table 5.3:	LVDS voltage setting (JP5) .....	33
	Figure 5.1	Jumpers and connectors on the PPC-175T mother- board .....	34
	5.1.3	Connectors .....	35
	Table 5.4:	PPC-175T connectors table .....	35
<b>Chapter 6</b>	<b>Driver Installation .....</b>	<b>38</b>	
6.1		Driver Installation.....	38
6.2		Updating Driver Searching on the Advantech Website.....	38
<b>Chapter 7</b>	<b>Pin Assignments .....</b>	<b>40</b>	
7.1		MAN-Heading01 style: Arial, Bold, 18pt, MAN-H1 color.....	40
	7.1.1	Heading02 style: Arial, Bold, 14pt, MAN-H1 color.....	40
	Table 7.1:	MAN-TableTitle style: Arial, Bold, 12pt, Black.....	40
	Figure 7.1	Test figure .....	40
	Figure 7.2	Another test figure .....	40
	Figure 7.3	A third test figure .....	40
<b>Appendix A</b>	<b>Disassembly .....</b>	<b>42</b>	
A.1		Disassembly Procedure.....	42
	Figure A.1	Unfastening the HDD side cover .....	42
	Figure A.2	Unfastening the rear cover .....	43
	Figure A.3	Disconnecting the fan connector .....	43
	Figure A.4	The PPC without the rear cover .....	44
	Figure A.5	Removing the PCI riser card .....	44
	Figure A.6	Unfastening the middle plate.....	45
	Figure A.7	Removing the middle plate.....	45
	Figure A.8	Unfastening the HDD module .....	46
	Figure A.9	Removing the HDD .....	46
	Figure A.10	Disconnecting the HDD cable .....	47
	Figure A.11	Loosening the screws on the HDD bracket.....	47
	Figure A.12	Loosening the screws on the CD-ROM module ..	48
	Figure A.13	Pushing out the brace holding the CD-ROM.....	48
	Figure A.14	Removing the fixed brace .....	49
	Figure A.15	Unfastening the CD-ROM / PCMCIA slot cover ..	49
	Figure A.16	Removing the CD-ROM / PCMCIA slot cover.....	50
	Figure A.17	Removing the CD-ROM module.....	50

Figure A.18 Disconnecting the CD-ROM connector .....	51
Figure A.19 Removing the CPU module .....	51
Figure A.20 Unfastening the CPU socket .....	52
Figure A.21 Removing the CPU.....	52
Figure A.22 Removing the SDRAM module.....	53

## **Appendix B**      **PCI Card Size Limits .....56**

Figure B.1 PCI Card Dimensional Limits.....	56
---------------------------------------------	----



# Chapter 1

## General Information

This chapter gives background information on the PPC-175T

Sections include:

- Specifications
- Dimensions

# Chapter 1 General Information

## 1.1 Introduction

Advantech PPC-175T is an Intel Pentium-M processor based Panel PC with a bright 17" LCD display. The powerful Pentium-M/Celeron-M CPU and Intel 855GME chipset brings the most dynamic applications to life without sacrifices to any industrial reliability. Internal CF card interface can treat as alternative HDD solution for OS booting and Mini-PCI interface can equip with many expansion cards such as Wireless LAN card to extend mobility application. Front bezel LEDs display PPC Power on, HDD and LAN operating status and a built-in front light sensor can automatically adjust the brightness level in different operating conditions. In order to satisfy customers security concerns, PPC-175T is also offered in a two LAN port configuration; customers can contact local sales for OEM orders.

## 1.2 Specifications

### 1.2.0.1 General

- Dimensions (W x H x D): 442 x 362 x 111.5 mm (17.4" x 14.25" x 4.39")
- Weight: 7.52kg (16.56lbs)
- Power supply:
  - AC model: 100 watts
  - Input voltage: 100 ~ 250 VAC @ 50 ~ 60 Hz
  - Max Output voltage: +3.3V@6A, +5V@8A, +12V@5A, -12V@0.5A,
  - +5VSB@0.75A, -3.3V, 5V total 50W(max)
- Disk drive housing: Space for one 2.5" HDD, one 12.7 mm compact CD-ROM drive
- Front panel: IP65 protection (not for the model with SAW touchscreen)

### 1.2.0.2 Standard PC functions

- CPU: Supports Intel Pentium-M and Celeron-M up to 1.8 / 1.5GHz.
- BIOS: Award 4 MB Flash BIOS, supports Plug & Play, APCI
- Chipset: Intel 855GME / ICH4
- RAM: Two 184-pin DDR DIMM sockets up to 2GB DDR SDRAM
- Serial ports: Three serial ports with three RS-232 ports (COM1, 2, and 3), one RS-232/422/485 port (COM2) which can be selected from BIOS set up program. All ports are compatible with 16C550 UARTs
- Universal serial bus (USB) port: Supports up to four USB V2.0 ports
- PCI bus expansion slot: Accepts one PCI bus card
- Watchdog timer: 255-level, interval timer, set up by software
- Battery: 3.0 V @ 196 mA lithium battery

### 1.2.0.3 AGP SVGA Flat panel interface

- Chipset: Intel 855GME chipset with integrated Intel Extreme Graphics 2
- Display memory: optimized shared memory architecture, supports up to 64MB frame buffer using system memory
- Display type: Simultaneously supports CRT and flat panel displays (EL, LCD and gas plasma)
- Display resolution: Supports non-interlaced CRT and TFT LCD displays up to 1024 x 768 @ 256K



**1.2.0.4 Audio function**

- Chipset: Realtek ALC650
- Audio controller: AC97 Ver. 2.0 compliant interface, Multi-stream, Direct Sound and Direct Sound 3D acceleration
- Stereo sound: 18-bit full-duplex codec
- Audio interface: Microphone-in, Line-in, Line-out

**1.2.0.5 Ethernet interface**

- Full compliance with IEEE 802.3u 100Base-T and 10 Base-T specifications. Includes software drivers and boot ROM.
- Wake on LAN (WOL) and wake on USB support: Wake on LAN/USB function support for ATX power control

**1.2.0.6 PCMCIA interface**

- Chipset: RICOH R5C842
- Cardbus controller: A PC card controller offers a single chip solution as a bridge between the PCI bus and the Cardbus
- PCI bus interface: Complies with PCI Local Bus Specification 2.1, and supports the 32-bit Cardbus (Card-32) and the 16-bit PC card (Card-16) without external buffers

**1.2.0.7 Touchscreen specifications (optional)**

<b>Table 1.1: Touchscreen specifications</b>			
Type	Analog Resistive	Capacitive	Surface Acoustic Wave (SAW)
Resolution	Continuous	1024 x 1024	4096 x 4096
Light Transmission	75%	85%	91%
Controller	RS-232 Interface (COM4)		
Power Consumption	+5 V @ 200 mA	+5 V @ 100 mA	+5 V @ 150 mA
Software Driver	Supports both DOS and Windows		
Durability (touches in a life- time)	35 million	225 million	50 million

**1.2.0.8 Optional Modules**

- CPU: Intel Pentium-M or Celeron-M processor up to 1.8 / 1.5 GHz.
- Memory: Supports up to 2 GB DDR SDRAM (184-Pin)
- HDD 2.5" IDE HDD (Notices: It is advisable that customers equip the system with an HDD with an operating temperature rating of 50° C or above whenever the ambient temperature exceeds 35° C.)
- Touchscreen : Analog resistive, capacitive, or Surface Acoustic Wave
- CD-ROM drive : Slim type 24X CD-ROM or above
- DVD-ROM drive : Slim type 6X DVD-ROM or above
- PCMCIA interface: Complies with 1995 PCMCIA card standard. Supports two PCMCIA card/CardBus slots. Two sockets support both a 16-bit PCMCIA card and a 32-bit CardBus simultaneously. Hot insertion and removal.
- CF Interface: type II CF slot (IDE interface) for OS booting
- LAN: 2nd 10/100 Bases LAN or Giga LAN are optional

#### **1.2.0.9 Environment**

- Temperature: 0 ~ 45° C (32 ~ 122° F)
- Relative humidity: 10 ~ 95% @ 40° C (non-condensing)
- Shock: 10 G peak acceleration (11 msec duration)
- Power MTBF: >130,000hrs

#### **1.2.0.10 Certifications:**

- EMC: CE, FCC, VCCI, BSMI, 3C
- BSMI approved Safety: CE, UL, CB.

### 1.3 Dimensions

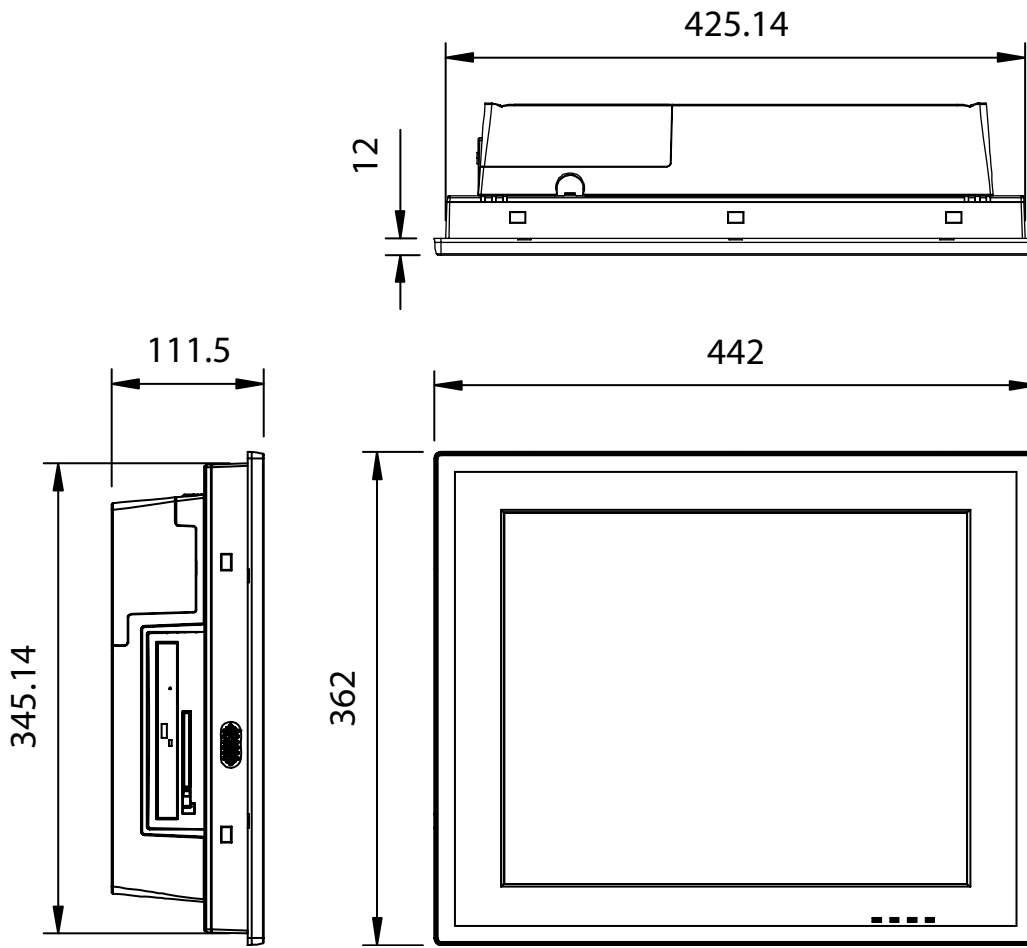


Figure 1.1 Dimensions of PPC-175T



# Chapter **2**

## System Setup

This chapter gives system setup information for the PPC-175T

Sections include:

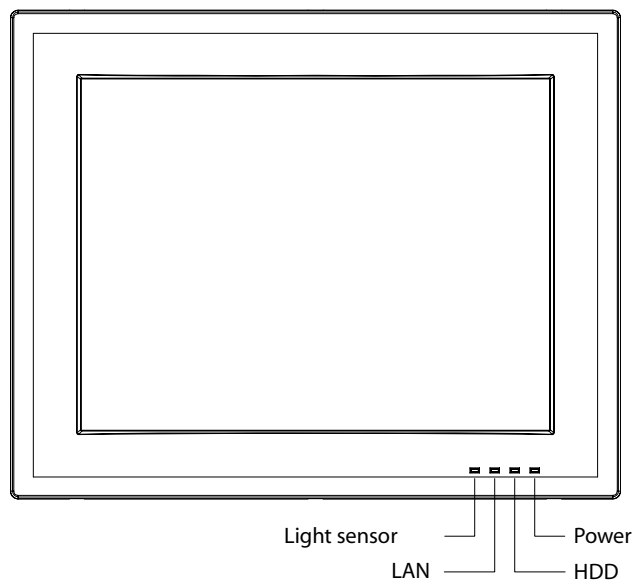
- A Quick Tour
- Installation Procedures
- Running the BIOS Setup
- Installing System Software

# Chapter 2 System Setup

## 2.1 A Quick Tour of the Panel PC

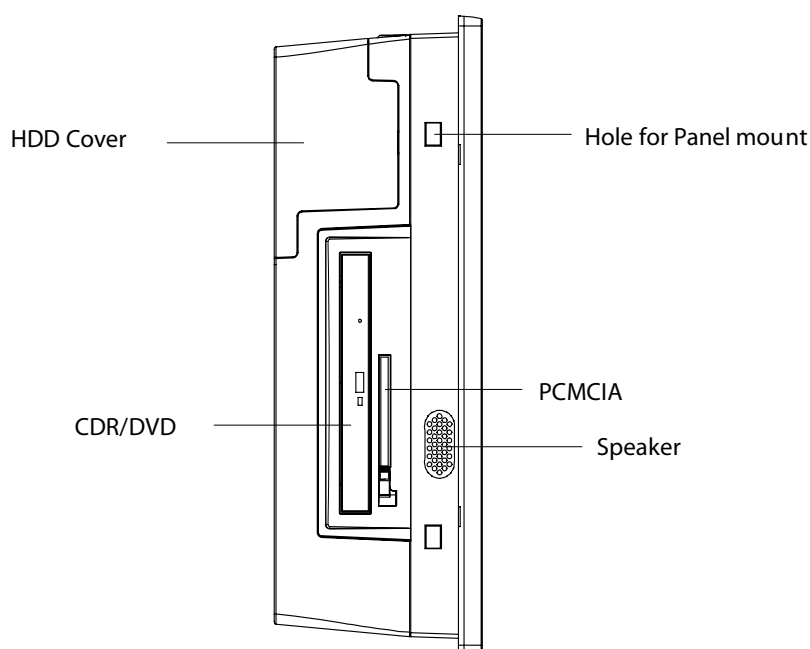
Before starting to set up the panel PC, take a moment to become familiar with the locations and purposes of controls, drives, connectors and ports, which are illustrated in the figures below.

When placed upright on the desktop, the front panel of the panel PC appears as shown in Figure 2-1:



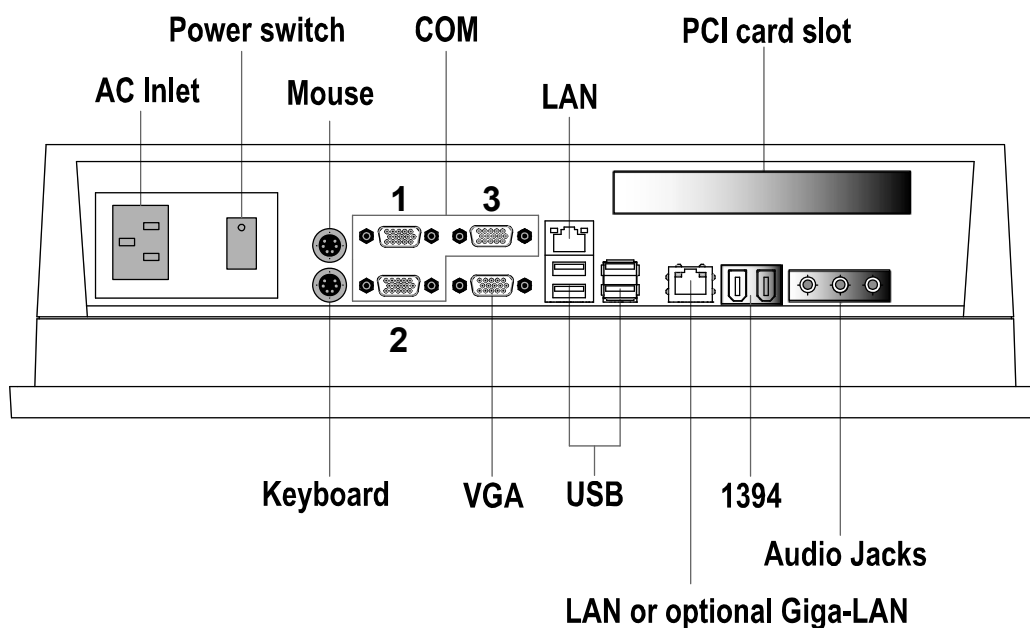
**Figure 2.1 Front panel of PPC-175T**

When viewed from the left side of the panel PC, the CD-ROM drive and PCMCIA expansion sockets are visible, as shown in Fig. 2-2:



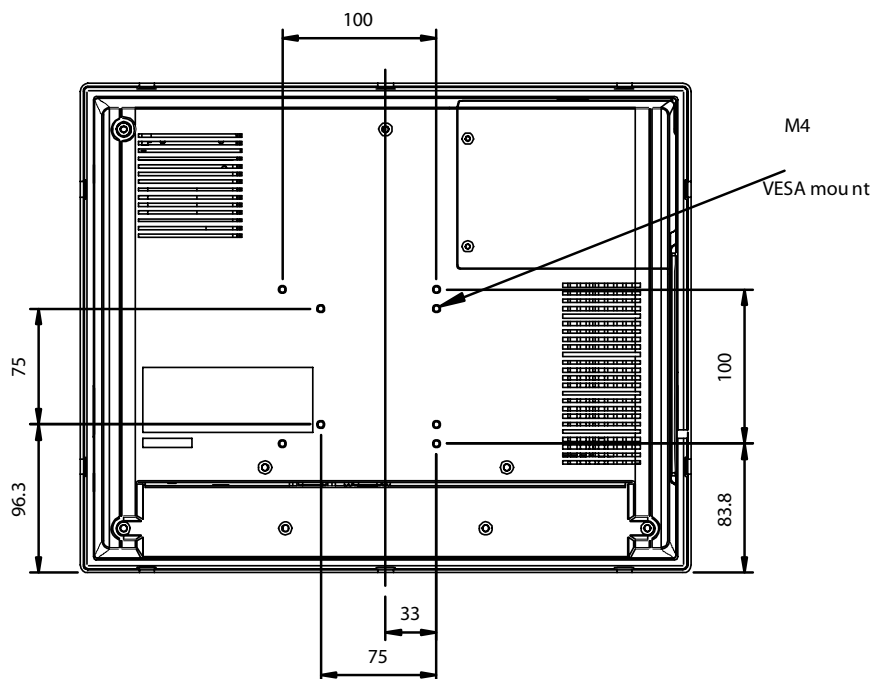
**Figure 2.2 Left side view of the panel PC**

Viewed from the bottom side, the PCI expansion slot is located along with other IO, on the bottom left side. This slot is covered by a side panel cover. The sunken I/O section is at the bottom of the panel PC, as shown in Fig. 2-3. (The I/O section includes various I/O ports, including serial ports, parallel port, the Ethernet port, USB ports, the audio jacks, and so on.)



**Figure 2.3 I/O Peripheral Connectors Panel**

Both standard VESA standard 75 x 75 / 100 x 100 mm mounting sizes are supported, so that customers may install different accessories for various applications.



**Figure 2.4 Rear view of the panel PC**

## 2.2 Preparing for First-time Use

Before commencing set up of the panel PC system, the following items should be available:

- Keyboard
- Mouse (for system software installation)

## 2.3 Installation Procedures

### 2.3.1 Connecting the power cord

The panel PC can only be powered through an AC electrical outlet (100 ~ 250 volts, 50 ~ 60 Hz). Be sure to handle the power cords by holding the plug ends only.

Follow these procedures in order:

1. Connect the female end of the power cord to the AC inlet of the panel PC.
2. Connect the 3-pin male plug of the power cord to an electrical outlet.

### 2.3.2 Connecting the keyboard and mouse

Connect the PS/2 mouse and keyboard to the I/O section of PPC.

If using a serial mouse and the panel PC has a touchscreen, it is possible to connect the mouse to any COM port *except* COM4.

### 2.3.3 Switching on the power

Switch on the power switch, which is located inside the bottom side cover.

## 2.4 Running the BIOS Setup Program

The panel PC will be properly set up and configured by the dealer prior to delivery. However, it may be necessary to use the panel PC's BIOS (Basic Input-Output System) setup program to change the system configuration information, such as the current date and time, or the type of hard drive. The setup program is stored in read-only memory (ROM). It can be accessed either when you turn on or reset the panel PC, by pressing the "Del" key on your keyboard immediately after powering on the computer.

The settings specified with the setup program are recorded in a special area of memory called "CMOS RAM." This memory is backed up by a battery so that it will not be erased after turning off or resetting the system. Whenever the power is turned on, the system reads the settings stored in CMOS RAM and compares them to the equipment check conducted during the power on self-test (POST). If a problem occurs, an error message will be displayed on screen, and the computer prompts the user to run the setup program.



## 2.5 Installing System Software

Recent releases of operating systems from major vendors include setup programs which load automatically and guide you through hard disk formatting and operating system installation. The guidelines below will help determine the steps necessary to install the operating system onto the panel PC hard drive.

**Note!** *Some distributors and system integrators may have already pre-installed system software prior to shipment.*



The BIOS of the panel PC supports system boot-up directly from the CD-ROM drive. Alternatively, it is possible to insert the system installation CD into the CD-ROM drive.

To power on the panel PC, or to reset the system: press the "Ctrl"+"Alt"+"Del" keys simultaneously. The panel PC will automatically load the operating system from the diskette or CD-ROM.

If presented with a setup or installation program, follow the instructions on screen. The setup program guides the user through preparation of a new hard drive, and installation of the new operating system.

If presented with an operating system command prompt, such as E:\>, then partition and format the hard drive, and manually copy the operating system files to it. Refer to the operating system user manual for instructions on partitioning and formatting a hard drive.

## 2.6 Installing the Drivers

After installing your system software, you will be able to set up the Chipset, Ethernet, VGA, audio, PCMCIA, light sensor and touchscreen functions. All the drivers are stored in a CD-ROM disc entitled "Drivers and Utilities." the CD-ROM can be found in your accessory box.



**Figure 2.5 Drivers and Utilities on the CD-ROM**

The various drivers and utilities in the CD-ROM disc which help users install the drivers and understand their functions. These files are a very useful supplement to the information in this manual.

**Note!** *The drivers and utilities used for the PPC-175T panel PCs are subject to change without notice. If in doubt, check Advantech's website or contact our application engineers for the latest information regarding drivers and utilities.*





# Chapter 3

## Using the Panel PC

This chapter explains onboard devices and peripheral I/O ports available on the PPC-175T

Sections include:

- CD-ROM Drive
- PCMCIA
- PS/2 Mouse and Keyboard
- PCI Bus Expansion
- Serial COM Ports
- VGA Port
- USB Ports
- Audio Interface
- Ethernet
- Front Bezel LED and Light Sensor
- Touchscreen (Optional)

# Chapter 3 Using the Panel PC

## 3.1 Introduction

This chapter describes basic features and procedures for using the panel PC. Topics covered include: the floppy drive, CD-ROM drive, I/O ports and the touchscreen.

## 3.2 CD-ROM Drive (optional )

It is possible to use the USB external optical device, or order the PPC-175T, which is equipped with slim optical devices.

To insert a CD-ROM disc, press the eject button on the CD-ROM drive.

To eject a CD-ROM disc, first ensure that the drive activity light is not active. Then press the eject button on the drive.



**Figure 3.1 Inserting and ejecting a CD-ROM**

### 3.3 PCMCIA

Memory Flash Cards are inserted and ejected in much the same way as diskettes.

To insert a Flash Memory card, align the card with the socket and slide the card into the socket until it locks into place. Take note that some FlashMemory cards must be properly configured through the operating system before they can be used for data storage. (See the *Flash Memory card manual for details.*)

To eject a Flash Memory card, first ensure that the panel PC is not accessing the memory card or device. Then press the appropriate eject button on the socket.



Figure 3.2 Inserting and ejecting a PCMCIA card

### 3.4 PS/2 Mouse and Keyboard

To install a full-size desktop PS/2 keyboard and mouse with the panel PC, follow these instructions:

1. Be sure the panel PC is turned off.
2. Attach the keyboard to the purple colored 5-pin PS/2 port.
3. Attach the PS/2 mouse to the green colored port.
4. Turn on the panel PC.

## 3.5 PCI Bus Expansion

The panel PC supports PCI bus expansion cards. To integrate a new PCIbus card into the system, follow these instructions:

1. Turn off the panel PC.
2. Unscrew the eight screws on the top of the rear cover, and remove it.
3. Remove the metal plate by unscrewing the single attaching screw.
4. Insert the PCI bus card into the PCI slot of the riser card. (See Fig. 3-3)
5. Run the setup program within the OS to configure the system.



Figure 3.3 PCI bus expansion

## 3.6 Serial COM Ports

There are three serial COM ports on the bottom. It is simple to attach a serial device to the panel PC, like an external modem or mouse.

Follow these instructions:

1. Be sure the panel PC and any other peripheral devices that are connected to the panel PC are turned off.
2. Attach the interface cable of the serial device to the panel PC's serial port. (See Fig. 3-4.) If necessary, attach the other end of the interface cable to the serial device. Fasten any retaining screws.
3. Turn on any other peripheral devices that is connected to the panel PC, and then turn on the panel PC.
4. Refer to the manual(s) which accompanied any serial device(s) for instructions on configuring the operating environment to recognize the device(s).
5. Run the BIOS setup program and configure the jumper settings to change the mode of the COM ports.

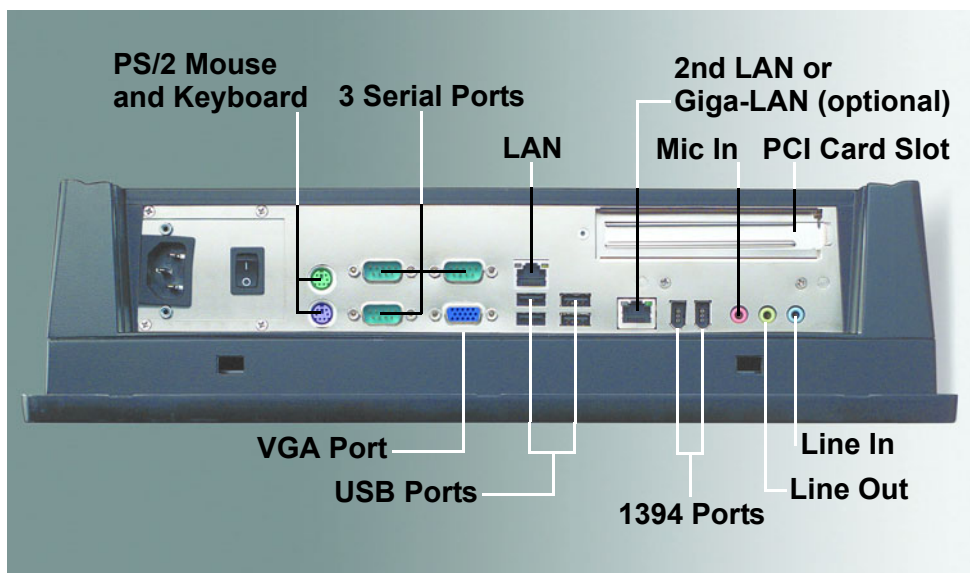


Figure 3.4 I/O ports

## 3.7 VGA Port

An external VGA-compatible device may be connected to the system through the 15-pin external port located on the bottom of the system unit.

The panel PC simultaneously supports an external CRT monitor in addition to the built-in LCD display.

1. Be sure the panel PC is turned off.
2. Connect the external monitor to the system. (See Fig. 3-4.)
3. Turn on the panel PC and the external monitor.

## 3.8 USB Ports

An external USB device may be connected to the system through the 4-pin USB ports located on the rear side of the system unit.

1. Connect the external device to the system. (See Fig. 3-4.)
2. The USB ports support hot plug-in connection. Install the device driver before using the device.

## 3.9 Audio Interface

The audio interface includes three jacks: Microphone in, Line out and Line in. (See Fig. 3-4.) Their functions are:

- Microphone in: Use an external microphone to record voice and sound.
  - Line out: Output audio to external devices such as speakers or earphones.
  - Line in: Input audio from an external CD player or radio.
1. Connect the audio device to the system. (See Fig. 3-4.)
  2. Install the driver before using the device.

## 3.10 Ethernet

External devices on the network may be connected to the system through the external Ethernet port located on the bottom of the system unit.

1. Be sure the panel PC is turned off.
2. Connect the external device(s) to the panel PC.
3. Turn on the panel PC and the external device(s).

**Note!** Customer can order two LAN ports or Change default LAN port to Giga LAN via Advantech OEM processes.



## 3.11 Front Bezel LED and Light Sensor

On the front bezel of the PPC-175T there are three LEDs to indicate Power, HDD, LAN. A light sensor with built-in panel brightness level control completes the array. (See Figure 3.5).



**Figure 3.5 LED & light sensor**

Details about the light sensor are available on the Driver CD, inside the “light sensor” folder. The Advantech “Smart Backlight Utility” is aimed to help the user adjust the backlighting of the panel. Users can also configure the backlight of the panel from desktop utility; switch between manual-mode/auto-mode set the backlight value. The SUSI software library is also available to support configuration and operation of the system controls and sensors.



## 3.12 Touchscreen (Optional)

The touchscreen is connected to the internal RS-232 port. Its function is similar to that of a mouse. There are 3 kinds of touchscreens that support the PPC-175T: *resistive*, *capacitive* and *SAW* type.

It is necessary to install the touchscreen driver before it will function. The touchscreen drivers for various operating systems are stored on the CD-ROM disc inside the accessory box.



# Chapter 4

## Hardware Installation

This chapter gives instructions for installing hardware devices on the PPC-175T

Sections include:

- Jumpers and Connectors
- Disassembling the Panel PC
- Installing the Central Processing Unit (CPU)
- Installing the DDR SDRAM Memory Module

# Chapter 4 Hardware Installation

## 4.1 Jumpers and Connectors

The panel PC consists of a PC-based computer that is housed in a metal shielding case with a plastic cover on the rear and bottom. All the computer devices, like the CPU, HDD, SDRAM, and power supply are all readily accessible after removing the rear panel or the HDD cover. Any maintenance or hardware upgrades can be easily completed after removing the rear panel and/or HDD cover.

For information about complete disassembly of the panel PC, refer to Appendix B.

**Warning!** Do not remove the plastic rear cover until verifying that no power is flowing within the panel PC. Power must be switched off and the power cord must be unplugged. Each time the panel PC is serviced, users should be aware of this condition.



## 4.2 Disassembling the Panel PC

The following are standard procedures for disassembling the panel PC before upgrading the system. All procedures are illustrated in Fig. 4-1, 4-2, 4-3 and 4-4.

1. Unscrew the side cover on the plastic HDD cover to expose the HDD module. The Type II CF slot lies underneath the HDD module.

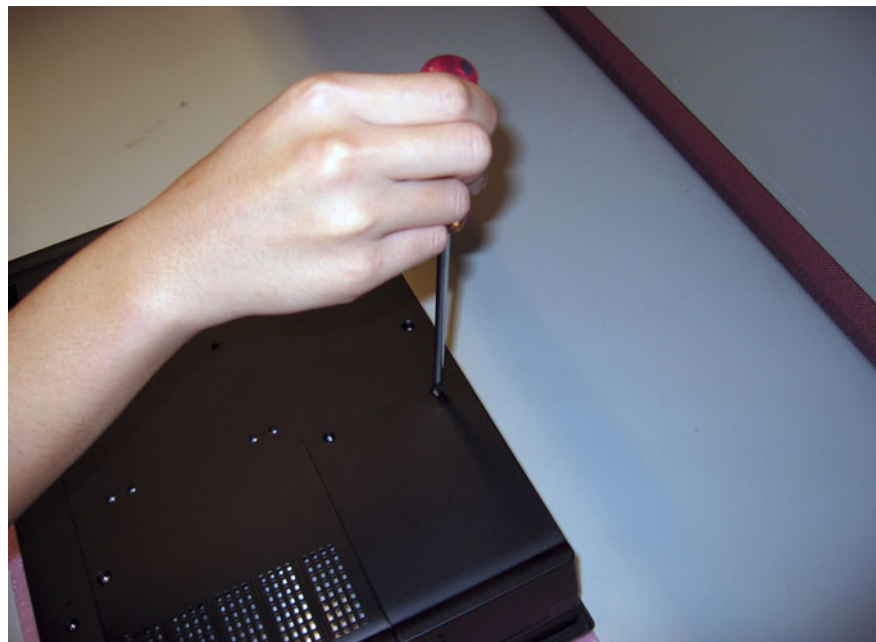


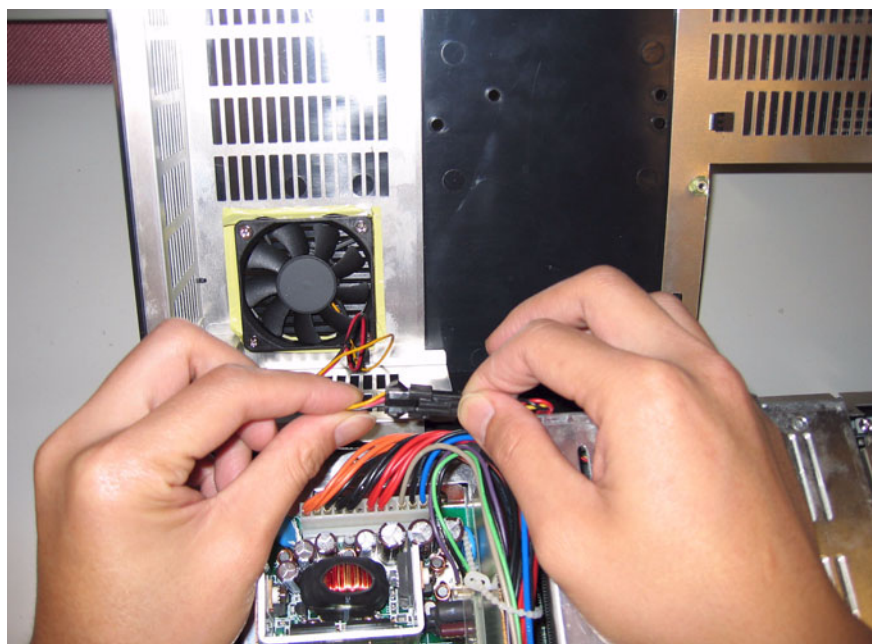
Figure 4.1 Unfastening the HDD side cover

2. Unfasten the screws securing the rear plastic cover and remove it.

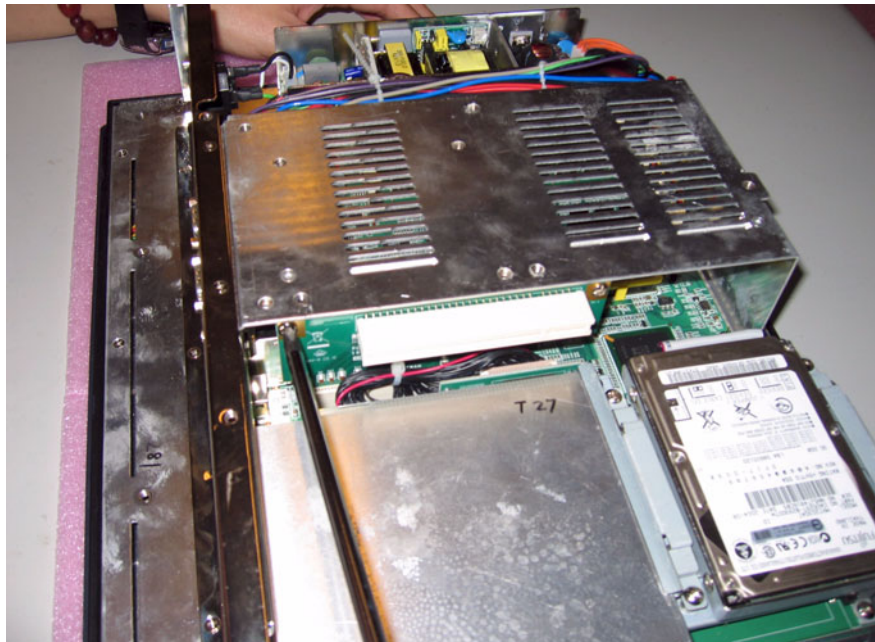


**Figure 4.2 Unfastening the rear cover**

3. Before removing the rear cover, disconnect the system fan connector.



**Figure 4.3 Disconnecting the fan connector**

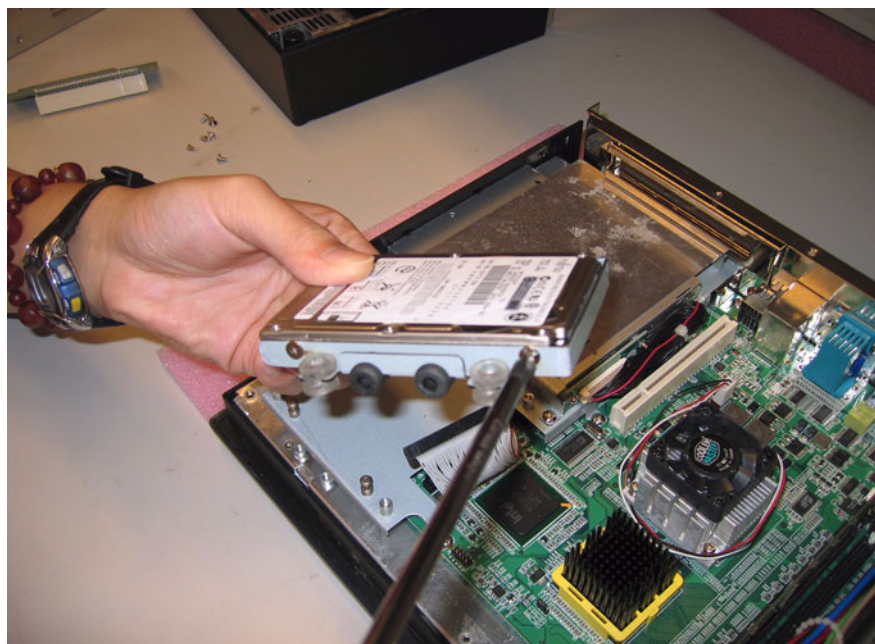


**Figure 4.4 The PPC without the Rear Cover**

### **4.3 Installing the 2.5" Hard Disk Drive**

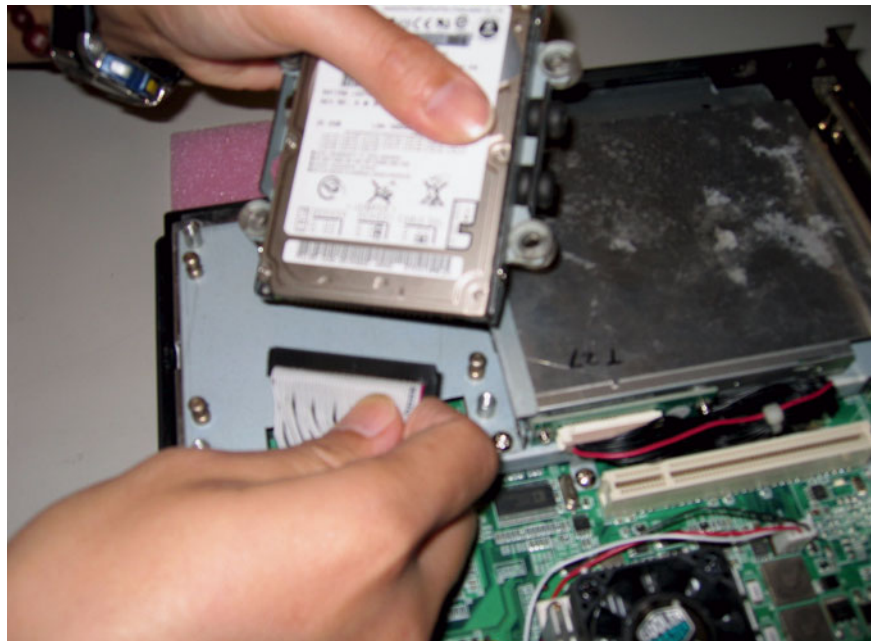
One enhanced Integrated Device Electronics (IDE) hard disk drive may be attached to the panel PC's internal controller which uses a PCI local-bus interface. The following instructions are for installing the HDD:

1. A metal plate holds the HDD to the upper right-hand side of the metal shielding case. (See Fig. 4-5.) Fix the two screws on the metal plate of two side of HDD.
2. Connect IDE cable from main board.
3. Place the HDD on the metal plate, and tighten the four screws from the bottom of the metal plate.



**Figure 4.5 Fastening the HDD metal frame to the HDD**

4. Plug the EIDE cable connector into the HDD.



**Figure 4.6** Plugging in the EIDE cable

5. Align the metal frame on the HDD to the mounting points and fasten the four screws.



**Figure 4.7** Aligning the HDD frame

## 4.4 Installing the Central Processing Unit (CPU)

The panel PC is equipped with a central processing unit (CPU) that can be upgraded to improve system performance. The panel PC provides one 478-pin ZIF (Zero Insertion Force) socket, or “Socket 478.” The CPU must be fitted with an appropriate heat-sink and CPU fan to prevent overheating.

**Warning!** The CPU may be damaged if operated without a heat sink, and if the fan is not connected to the CPU fan power connector.

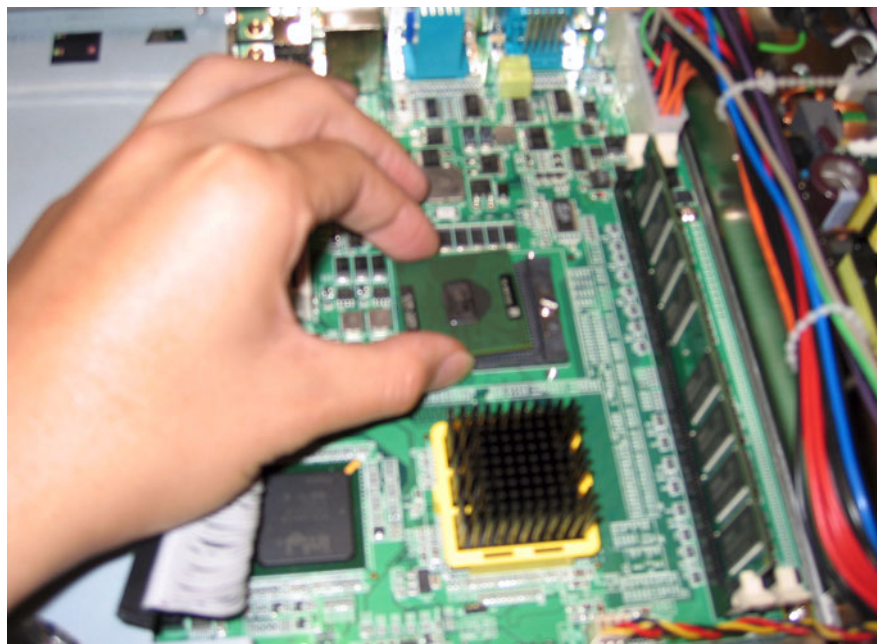


**Caution!** Always disconnect the power cord from your panel PC when you are working on it. Do not make connections while the power is on as sensitive electronic components can be damaged by the sudden rush of power. Only experienced electronics personnel should open the panel PC.



Follow these instructions to install a CPU:

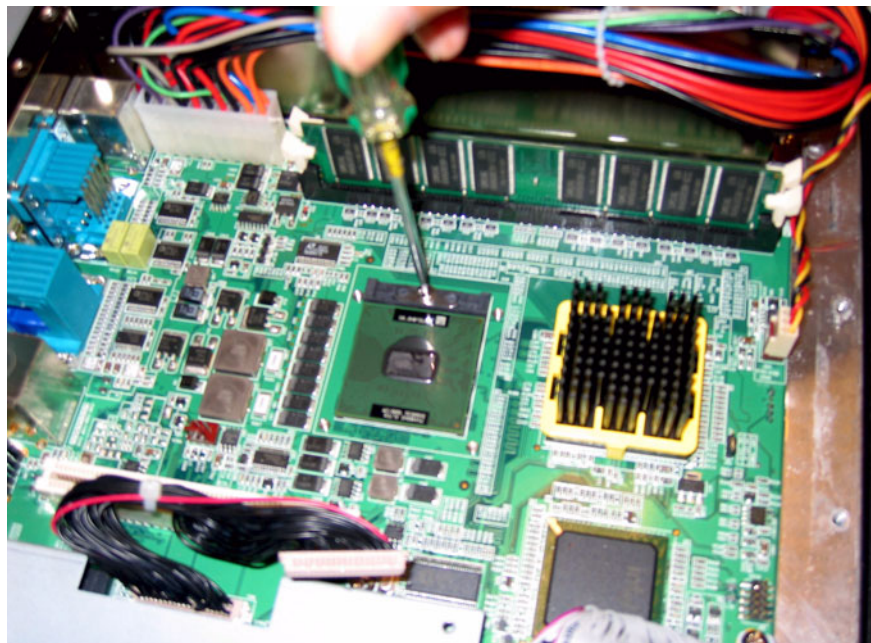
1. Place the CPU carefully into the socket, taking care to align it properly.



**Figure 4.8** Placing the CPU in the socket

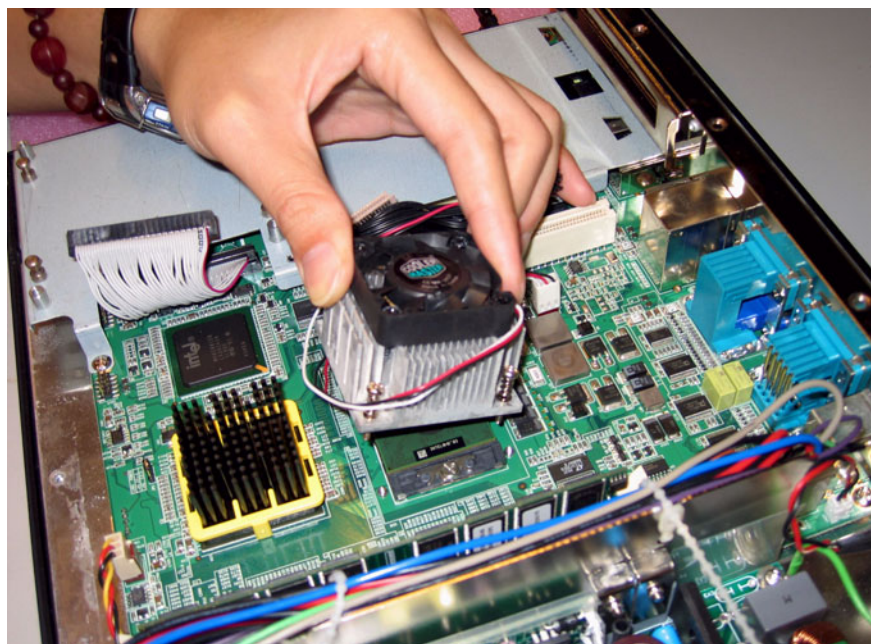


2. Fasten the screw on the CPU socket mounting plate.



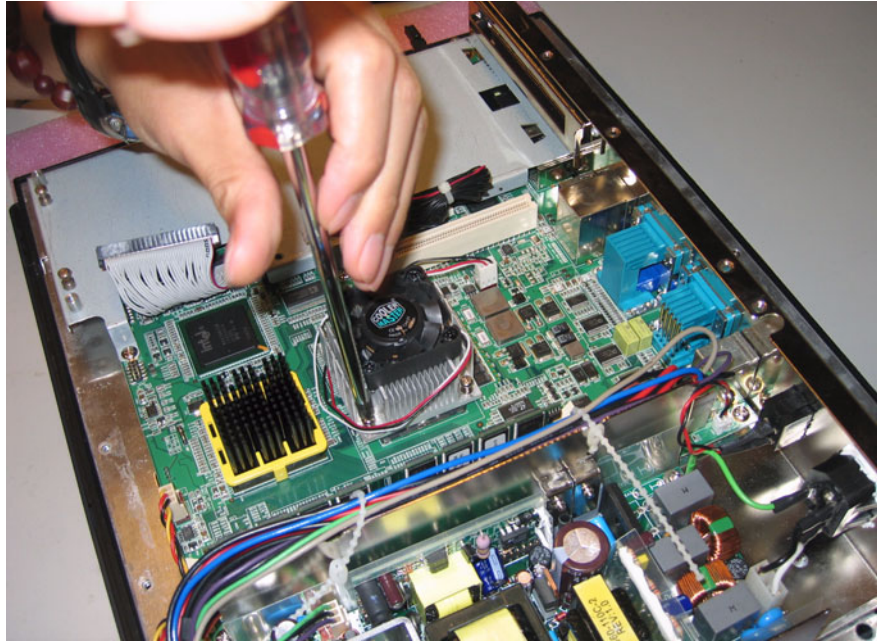
**Figure 4.9 Tightening the screws on the CPU**

3. Place the heatsink and fan on top of the CPU, and fasten them with the retention bracket.



**Figure 4.10 Placing the heatsink and fan on the CPU**

4. Fasten the four screws onto the CPU cooler module.



**Figure 4.11 Fastening the CPU module to the motherboard**

## 4.5 Installing the DDR SDRAM Memory Module

It is possible to install from 256 MB to 2 GB of DDR SDRAM memory. The panel PC system provides two 184-pin DIMM (Dual Inline Memory Module) sockets and supports 2.5V DDR SDRAM.

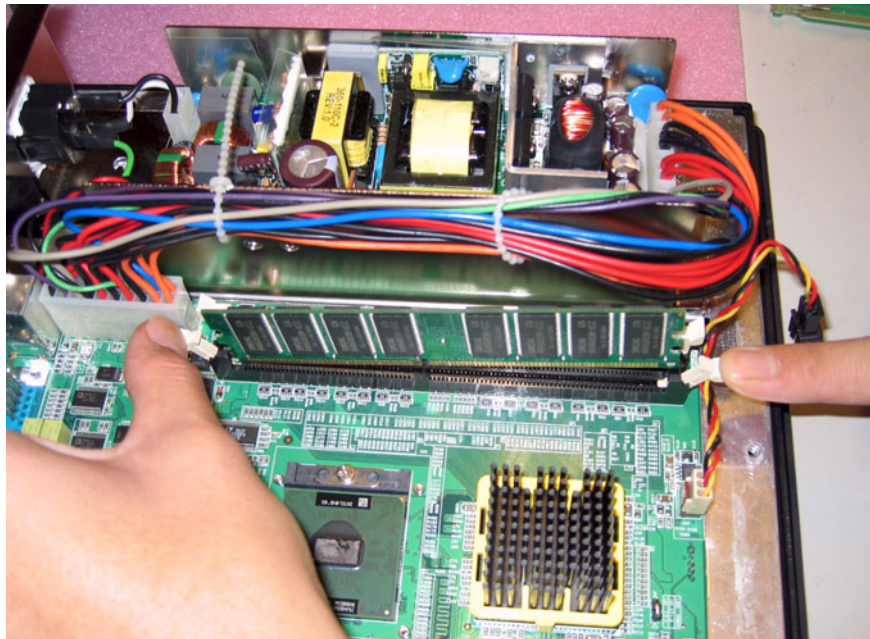


Figure 4.12 Placing the memory module in the DIMM



# Chapter 5

## Jumpers and Connectors

This chapter gives information on setting jumpers and using the connectors on the PPC-175T motherboard

Sections include:

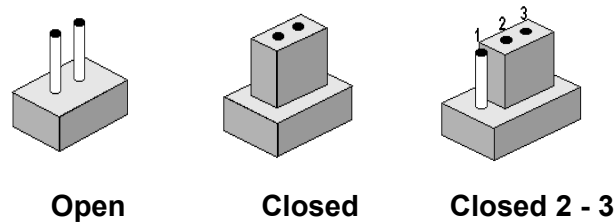
- Setting Jumpers
- Jumper and Connector Locations
- Connectors

## 5.1 Jumpers and Connectors

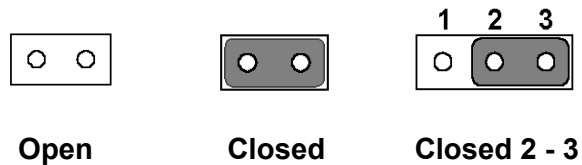
This chapter supplies more detailed information about the internal jumper settings and an outline of the I/O ports available on the PPC-175T.

### 5.1.1 Setting jumpers

The Panel PC can be configured to match the needs of each application by setting the jumpers. A jumper is the simplest kind of electrical switch. It consists of two metal pins and a small metal clip (often protected by a plastic cover), which slides over the pins to close the circuit and connect them. To “close” a jumper, connect the pins with the clip. To “open” a jumper, remove the clip. Sometimes a jumper has three pins, labeled 1, 2, and 3. In this case, it is possible to connect either pins 1 and 2 or pins 2 and 3 to each other.



The jumper settings are schematically depicted in this manual as follows:



A pair of needle-nose pliers may be helpful when working with jumpers. If there are any doubts about the best hardware configuration for a particular application, contact the local distributor or sales representative before making any changes.

An arrow is printed on the motherboard to indicate the first pin of each jumper.

### 5.1.2 Jumpers

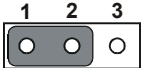
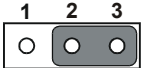
The motherboard of the Vehicle Mounted Computer has a number of jumpers that help configure the system. It also has LED indicator lamps that display the system operation status. The table below lists the function of each jumper and LED.

The motherboard of the PPC-175T has a number of jumpers that allow you to configure your system to suit your applications.

### 5.1.2.1 PCI slot voltage setting (JP2)

The panel PC supports 5V and 3.3V PCI\_VIO slot voltages. The default voltage is 3.3V (closed pins 1-2). 5V may be selected by closing jumpers 2-3.

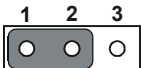
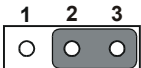
**Table 5.1: PCI slot voltage setting (JP2)**

3.3V (default)	5V
	

### 5.1.2.2 Clear CMOS (JP3)

This jumper erases the CMOS data and resets the system BIOS information.


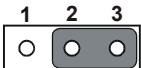
**Table 5.2: Clear CMOS (JP3)**

Normal operation (default)	Clear CMOS
	

### 5.1.2.3 LVDS voltage setting (JP5)

The panel PC supports 5V and 3.3V LVDS voltages. The default voltage is 3.3V (closed pins 1-2). 5V may be selected by closing jumpers 2-3.

**Table 5.3: LVDS voltage setting (JP5)**

3.3V (default)	5V
	

#### 5.1.2.4 Jumper and Connector Locations

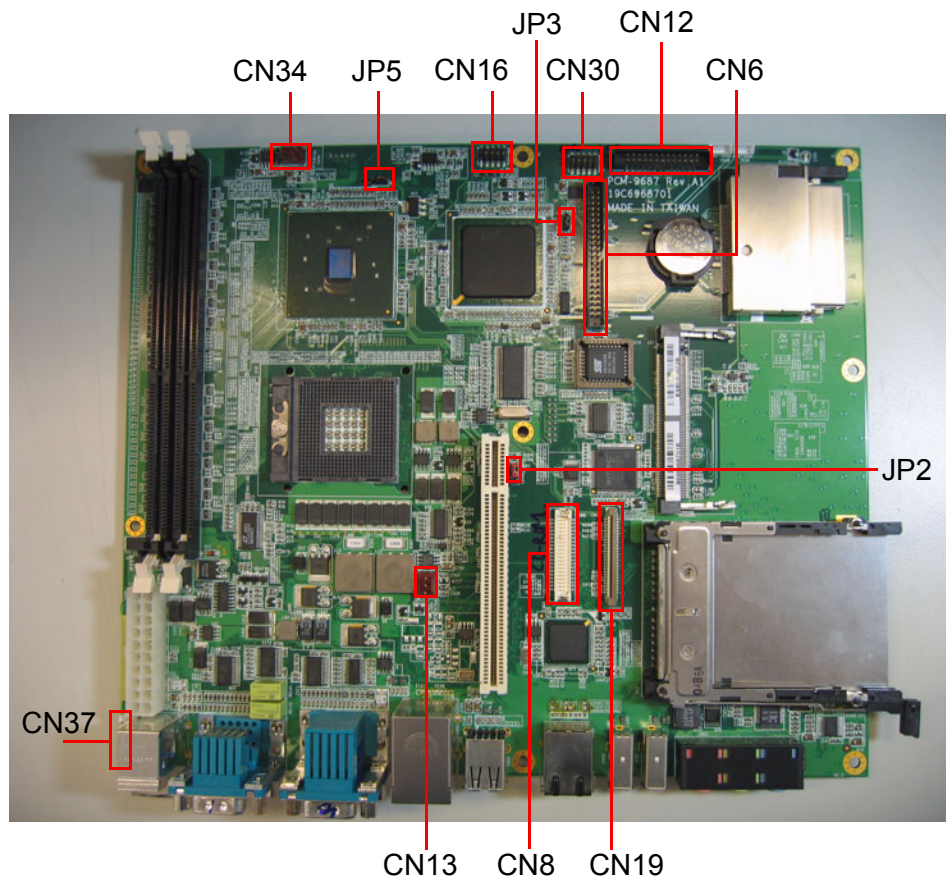


Figure 5.1 Jumpers and connectors on the PPC-175T motherboard



### 5.1.3 Connectors

Onboard connectors link the panel PC to external devices such as hard disk drives or floppy drives. The table below lists the function of each of connectors.

CN1	Serial port for touch	CN21	X
CN2	X	CN22	Audio Jack
CN3	Serial+VGA port	CN23	X
CN4	Inverter power	CN24	PS/2*2
CN5	LAN+USB*2	CN25	X
CN6	IDE-HDD	CN26	X
CN7	Mini-PCI	CN27	X
CN8	IDE-Slim CD-ROM	CN28	X
CN9	LVDS	CN29	X
CN10	X	CN30	GPIO
CN11	ATX power	CN31	TYPE II CF slot
CN12	LPT	CN32	1394 port
CN13	CPU fan	CN33	1394 port
CN14	X	CN34	System FAN
CN15	X	CN35	COM*2
CN16	internal USB pin header	CN36	2nd LAN
CN17	internal Speakers	CN37	Power Switch
CN18	X	CN38	Light sensor
CN19	FDD	CN39	LED*3
CN20	USB*2	CN40	X



# Chapter 6

## Driver Installation

This chapter gives information on installing drivers for the PPC-175T

Sections include:

- Driver Installation
- Updating Drivers

# Chapter 6 Driver Installation

---

A Driver CD is supplied inside the accessory box. Customers may need to use an external USB CD-ROM related device to load the CD and install the drivers for the PPC-175T.

## 6.1 Driver Installation

Before installing the Ethernet driver, note the procedures below. It is necessary to know which operating system is installed on the PPC-175T. Then refer to the corresponding installation flow chart. Follow the steps described in the flow chart to complete the installation quickly. Drivers and documents included on the CD are for the chipset, LAN, Audio, Touchscreen, VGA, USB, light sensor utility, and the light sensor guide and a PDF copy of this user manual.

- Note!**
1. The CD-ROM drive is designated as "D" throughout this chapter.
  2. <Enter> means pressing the "Enter" key on the keyboard.



## 6.2 Updating Driver Searching on the Advantech Website

For further information about installing drivers on the PPC-175T, and to access driver updates, troubleshooting guides and FAQ lists, visit the following web resources:

Advantech websites:

- [www.advantech.com](http://www.advantech.com)
- [www.advantech.com.tw](http://www.advantech.com.tw)

# Chapter 7

## Pin Assignments

This chapter gives background information on the PPC-175T

Sections include:

- MAN-Heading01 style: Arial, Bold, 18pt, MAN-H1 color

# Chapter 7 Pin Assignments

## 7.1 MAN-Heading01 style: Arial, Bold, 18pt, MAN-H1 color

"MAN-Body" style: (Arial Unicode MS, Regular 11pt, Black. These notes are for reference only. Delete them before inserting new content.)

### 7.1.1 Heading02 style: Arial, Bold, 14pt, MAN-H1 color

#### 7.1.1.1 CompactFlash (CN10)

**Table 7.1: MAN-TableTitle style: Arial, Bold, 12pt, Black**

Pin	Signal	Pin	Signal
1	DCD	2	RXD
3	TxD	4	DTR
5	GND	6	DSR
7	RTS	8	CTS
9	RI (RI/+5V/+12V)		

Figure 7.1 Test figure

Figure 7.2 Another test figure

Figure 7.3 A third test figure

**Note!** *"MAN-Note" table style. Use it just like Caution and Warning tables. Remember to add a TAB at the beginning, then just select all and convert: Table/Convert To Table*



# Appendix **A**

## Disassembly

This chapter details a complete procedure for disassembling the Panel PC

# Appendix A Disassembly

## A.1 Disassembly Procedure

To completely disassemble the panel PC, follow the step-by-step procedures below. Users should be aware that Advantech Co., Ltd. takes no responsibility whatsoever for any problems or damage caused by disassembly of the panel PC by the user.

**Warning!** Make sure the power cord of the panel PC is unplugged before starting disassembly.



The following procedures do not include detailed assembly procedures for the CPU, HDD, CD-ROM drive, FDD, and SDRAM. Further details can be found in Chapter 4.

1. Unfasten the HDD side cover.

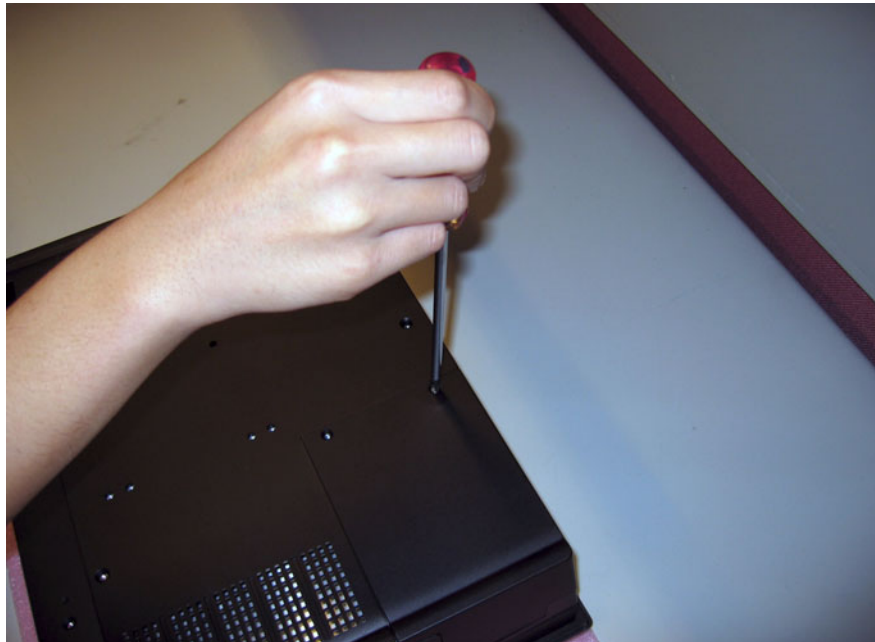


Figure A.1 Unfastening the HDD side cover



2. Unfasten the rear cover and remove it.



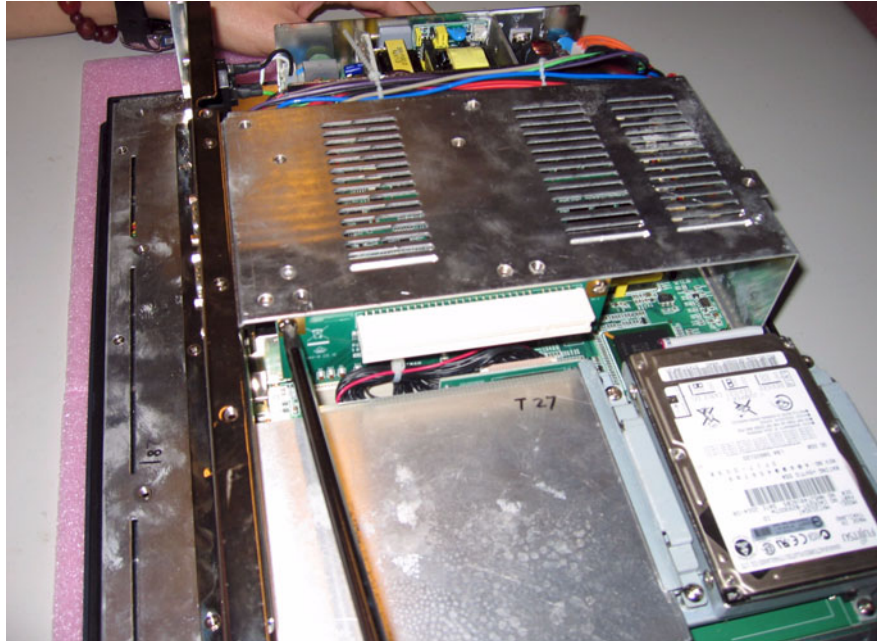
**Figure A.2 Unfastening the rear cover**

3. Before removing the rear cover, disconnect the system fan connector.



**Figure A.3 Disconnecting the fan connector**

4. The PPC without the rear cover.



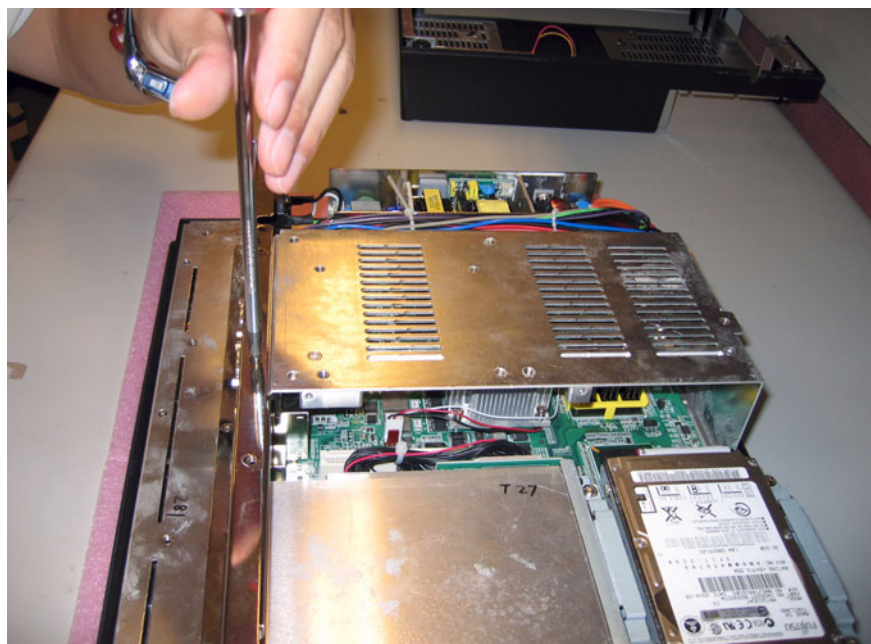
**Figure A.4 The PPC without the rear cover**

5. Remove the PCI riser card.



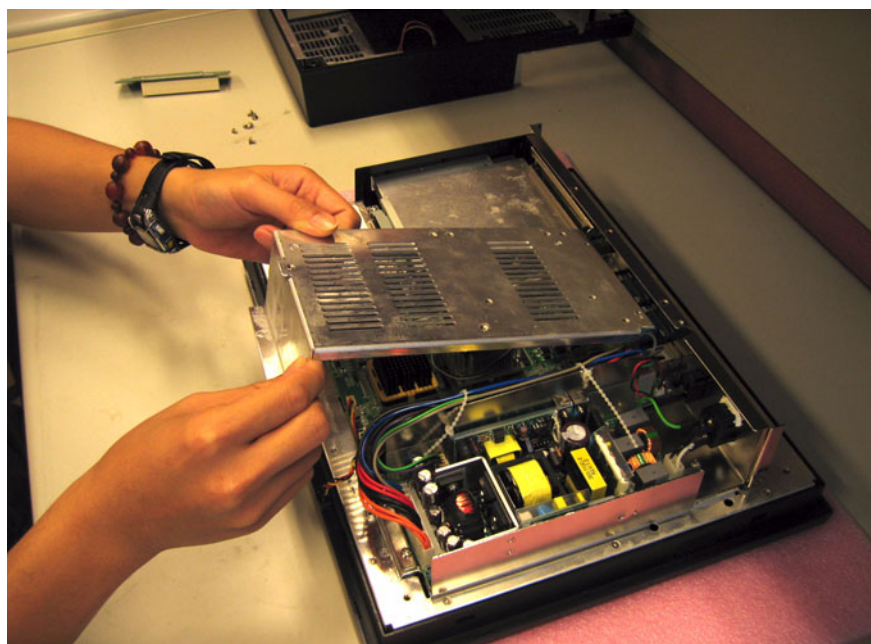
**Figure A.5 Removing the PCI riser card**

6. Unfasten the middle plate.



**Figure A.6 Unfastening the middle plate**

7. Remove the middle plate.



**Figure A.7 Removing the middle plate**

8. Unfasten the side screws on the HDD module and remove the left side plate.



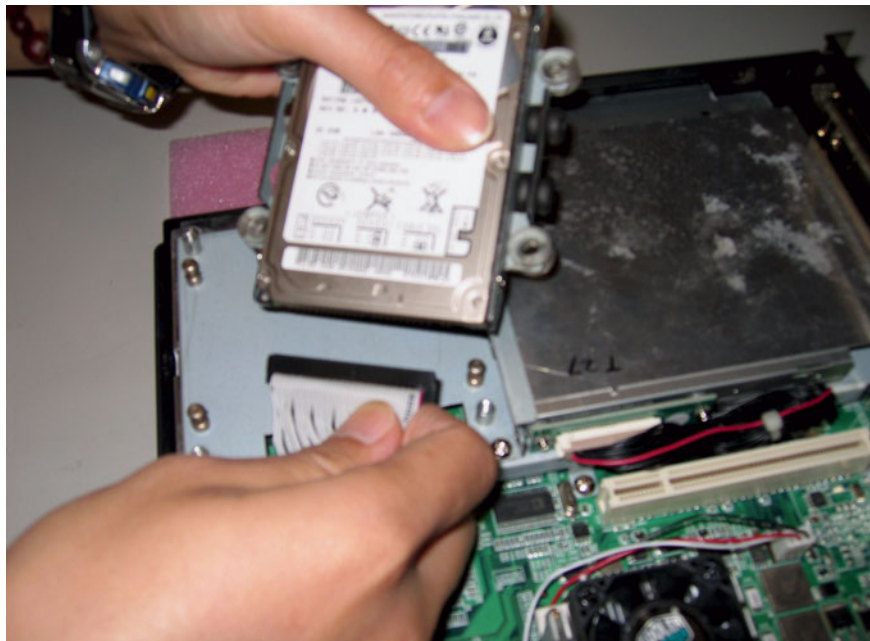
**Figure A.8 Unfastening the HDD module**

9. Remove the right side plate and lift out the HDD.



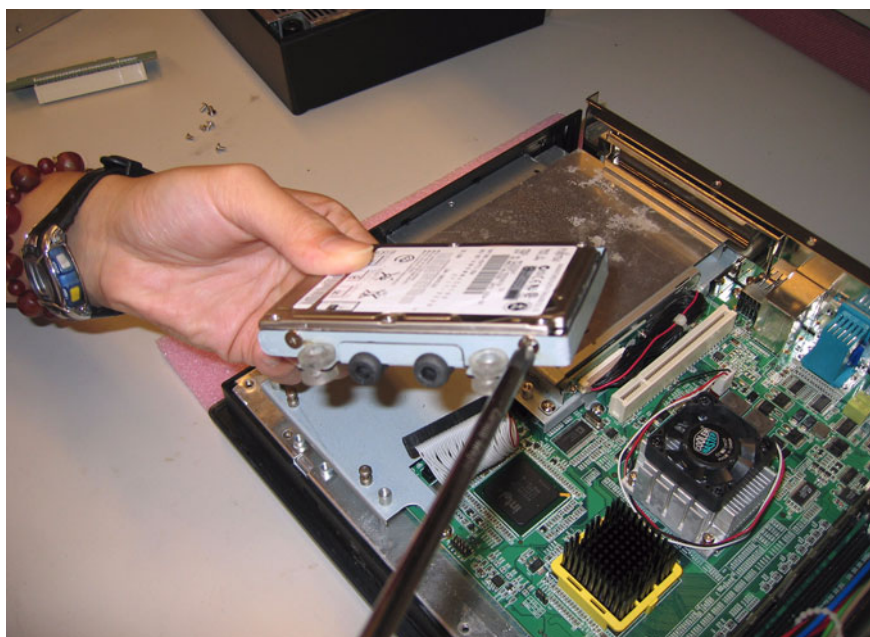
**Figure A.9 Removing the HDD**

10. Disconnect the HDD cable from the PPC-175T motherboard.



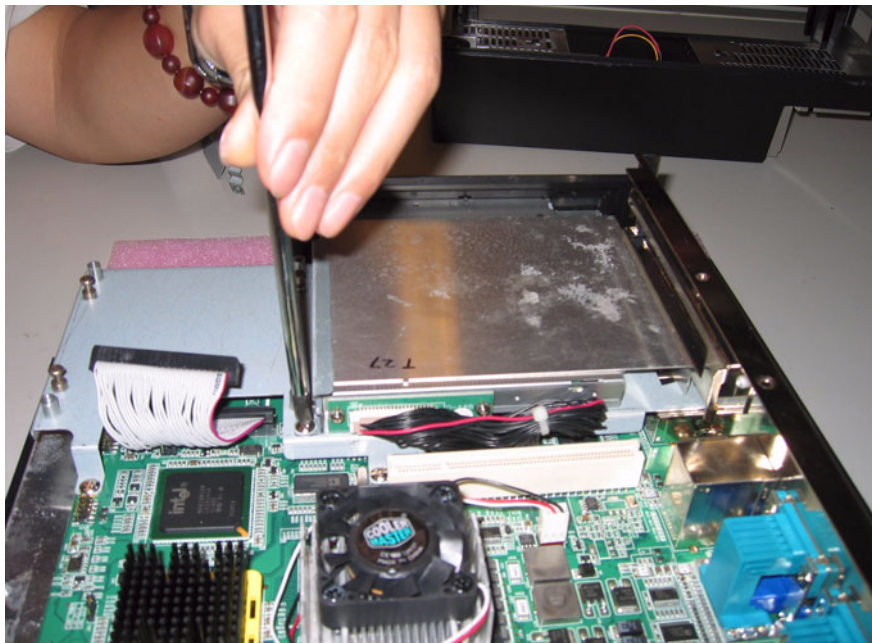
**Figure A.10 Disconnecting the HDD cable**

11. Loosen the screws on the bracket holding the HDD module.



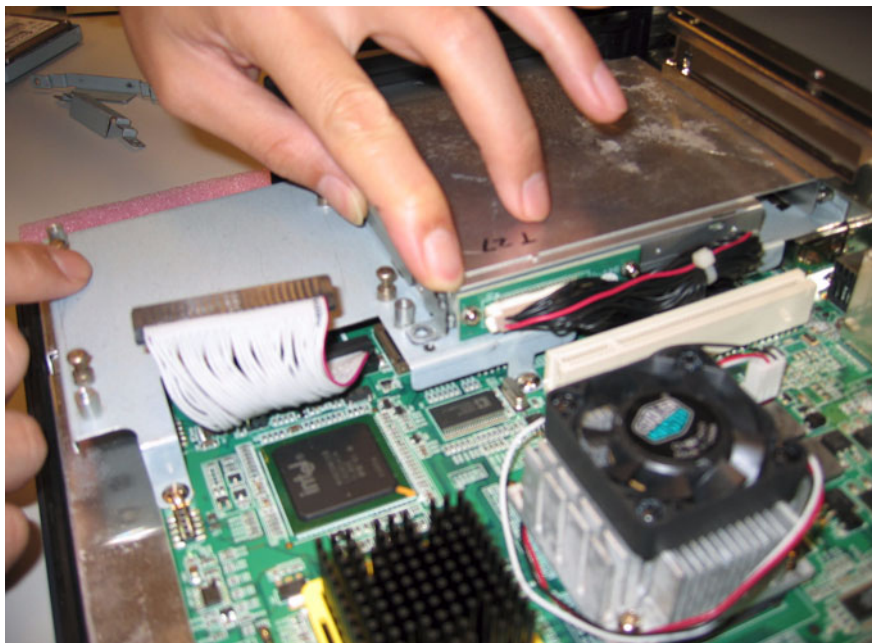
**Figure A.11 Loosening the screws on the HDD bracket**

12. Loosen the screws on the CD-ROM module.



**Figure A.12 Loosening the screws on the CD-ROM module**

13. Carefully push out the fixed brace holding the CD-ROM.



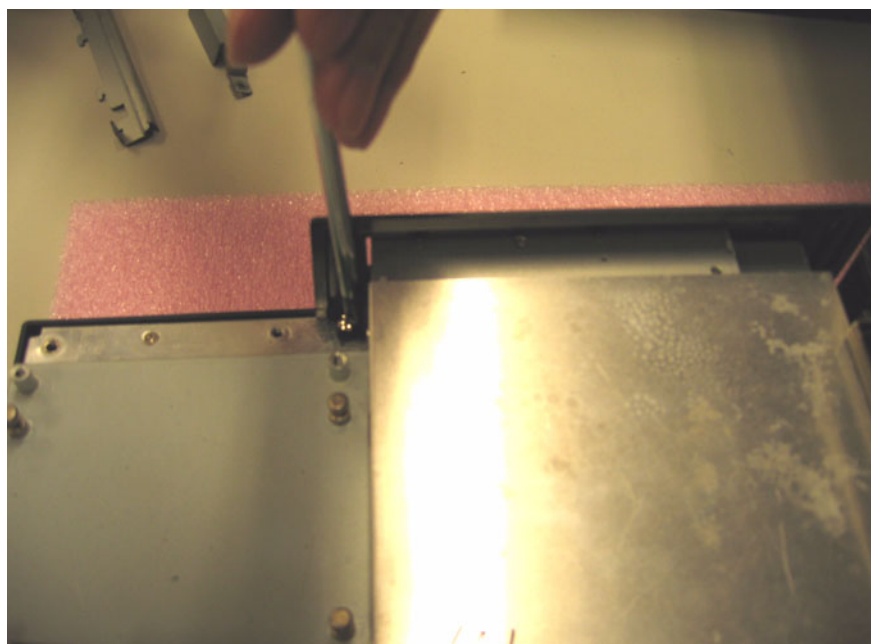
**Figure A.13 Pushing out the brace holding the CD-ROM**

14. Remove the fixed brace.



**Figure A.14 Removing the fixed brace**

15. Unfasten the CD-ROM / PCMCIA slot cover.



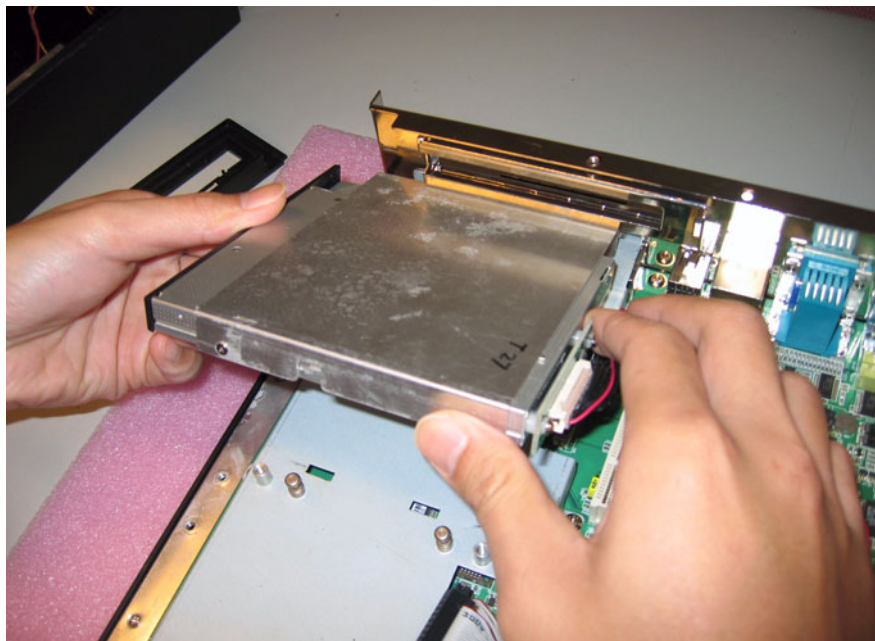
**Figure A.15 Unfastening the CD-ROM / PCMCIA slot cover**

16. Remove the CD-ROM / PCMCIA slot cover.



**Figure A.16 Removing the CD-ROM / PCMCIA slot cover.**

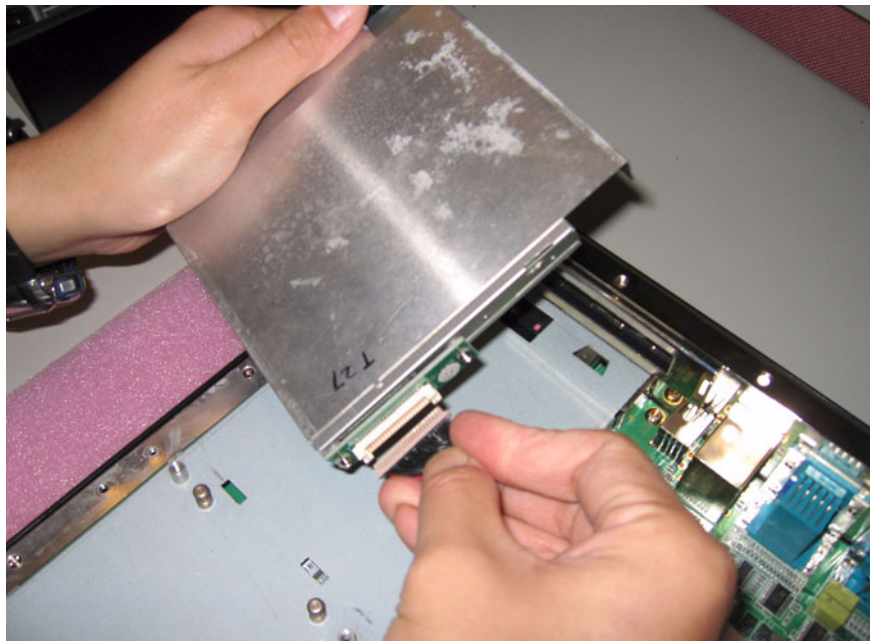
17. Remove the CD-ROM module.



**Figure A.17 Removing the CD-ROM module**

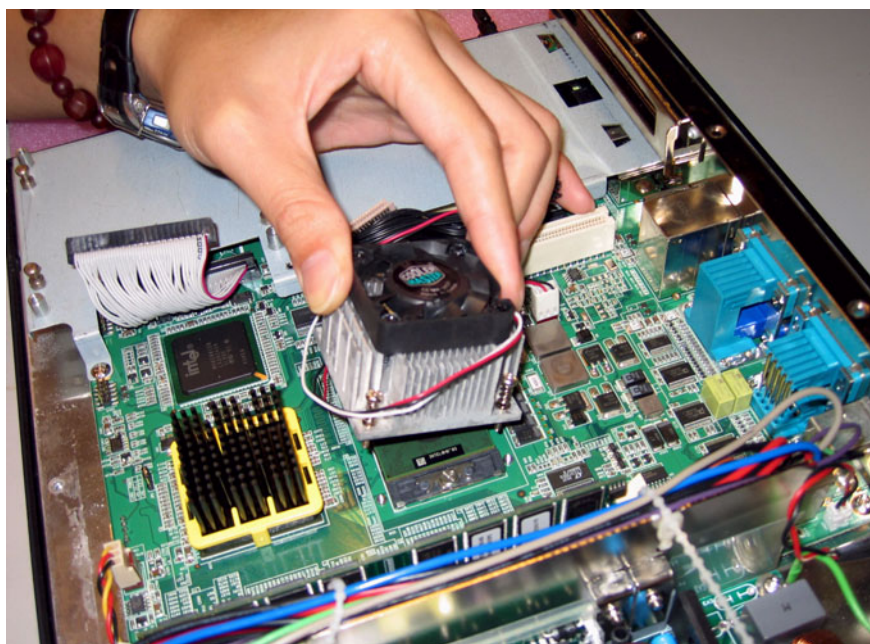


18. Disconnect the CD-ROM connector.



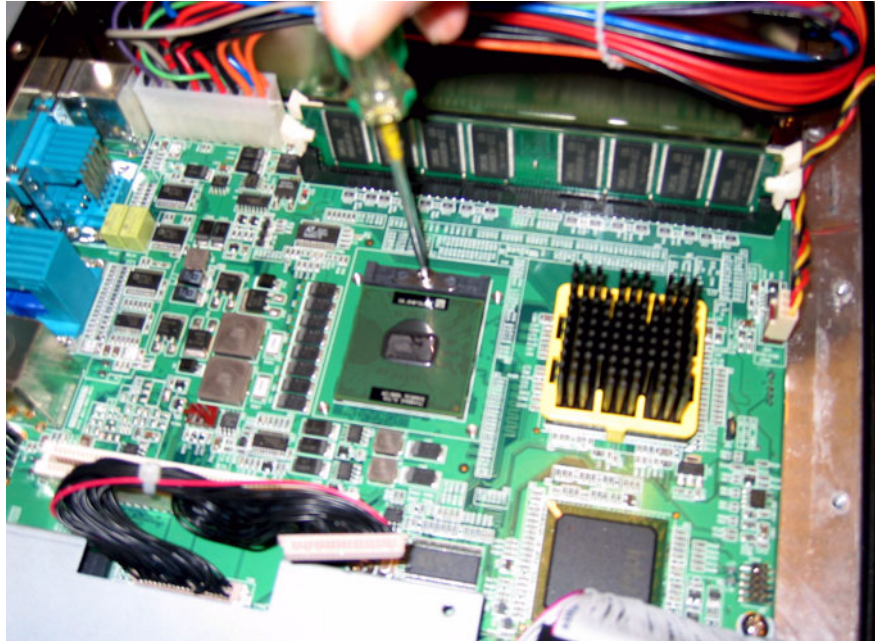
**Figure A.18 Disconnecting the CD-ROM connector**

19. Unfasten the four screws on the CPU module and remove it.



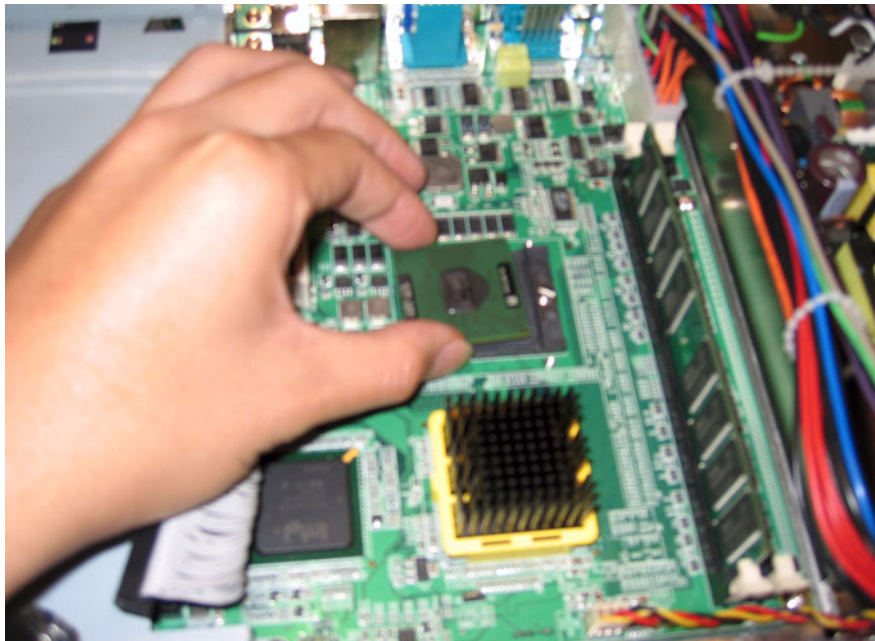
**Figure A.19 Removing the CPU module**

20. Unfasten the CPU socket.



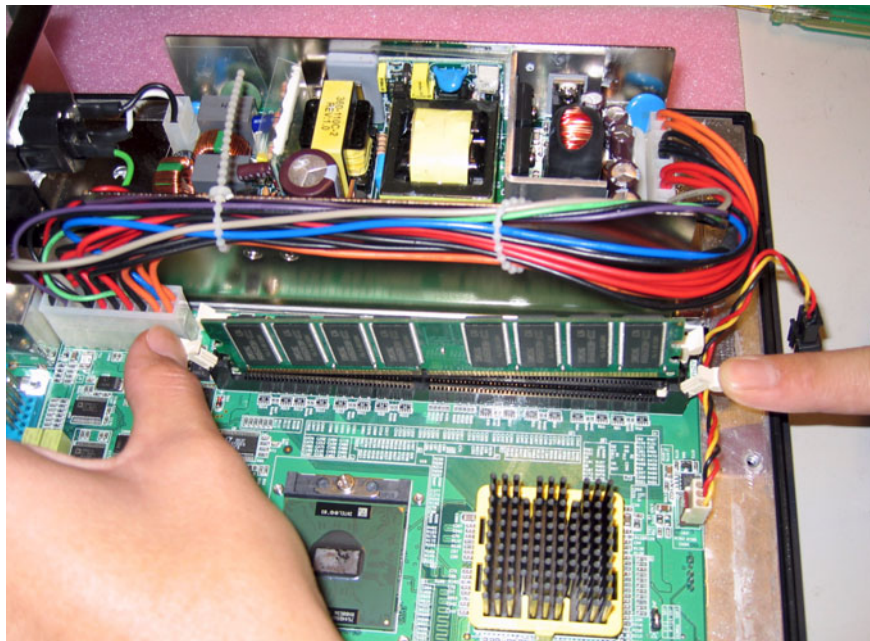
**Figure A.20 Unfastening the CPU socket**

21. Unfasten the screw on the CPU socket mounting plate and remove the CPU.



**Figure A.21 Removing the CPU**

22. Remove the SDRAM module.



**Figure A.22 Removing the SDRAM module**



# Appendix **B**

## PCI Card Size Limits

This chapter details the size limits for PCI cards that may be installed on the Panel PC motherboard

# Appendix B PCI Card Size Limits

PCI Cards must be sized within the following dimensional limits:

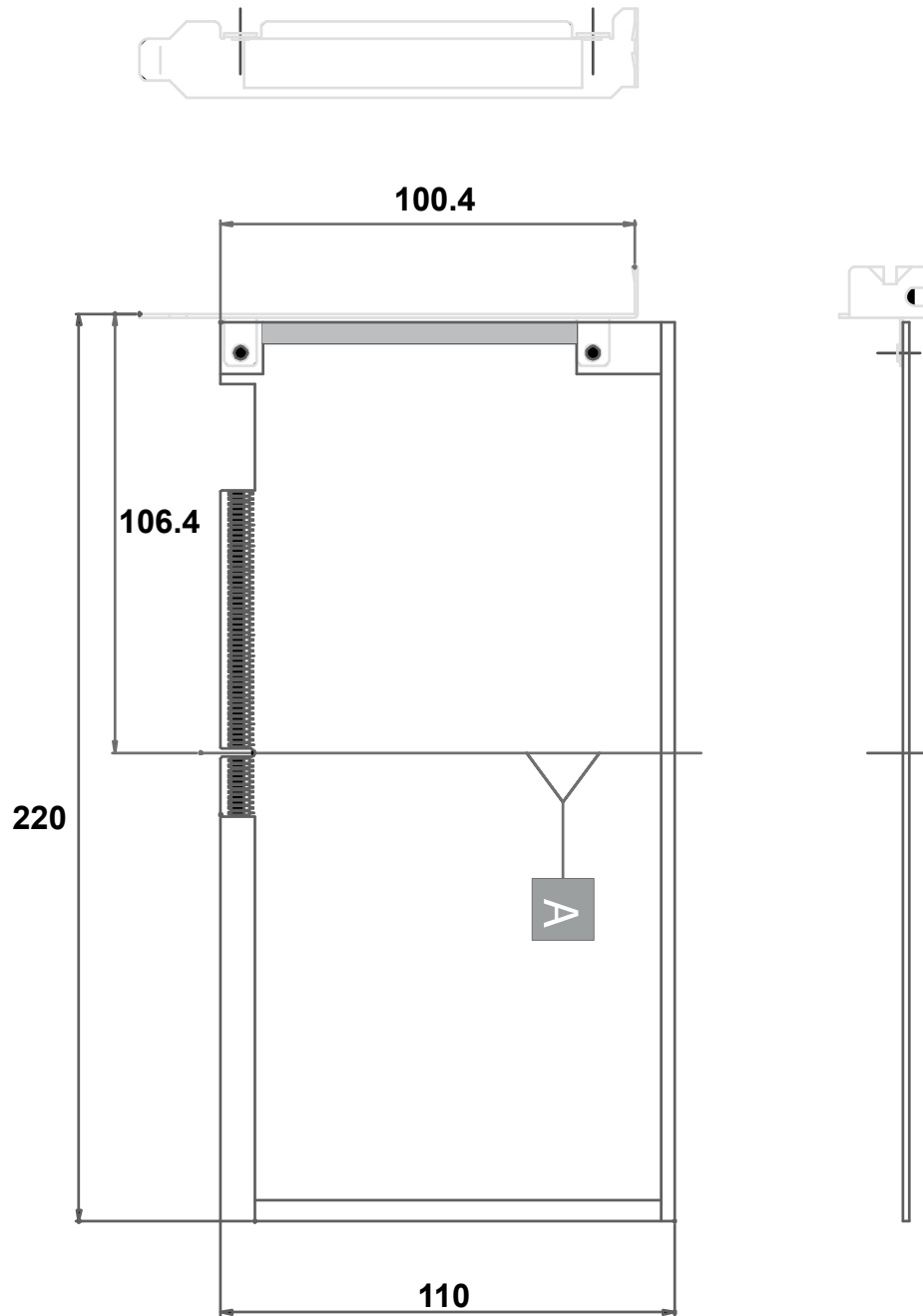


Figure B.1 PCI Card Dimensional Limits



*Trusted ePlatform Services*

**ADVANTECH**

**[www.advantech.com](http://www.advantech.com)**

Please verify specifications before quoting. This guide is intended for reference purposes only.

All product specifications are subject to change without notice.

No part of this publication may be reproduced in any form or by any means, electronic, photocopying, recording or otherwise, without prior written permission of the publisher.

All brand and product names are trademarks or registered trademarks of their respective companies.

© Advantech Co., Ltd. 2006



## Free Manuals Download Website

<http://myh66.com>

<http://usermanuals.us>

<http://www.somanuals.com>

<http://www.4manuals.cc>

<http://www.manual-lib.com>

<http://www.404manual.com>

<http://www.luxmanual.com>

<http://aubethermostatmanual.com>

Golf course search by state

<http://golfingnear.com>

Email search by domain

<http://emailbydomain.com>

Auto manuals search

<http://auto.somanuals.com>

TV manuals search

<http://tv.somanuals.com>