

Drying Tumblers

25 Pound Capacity

30 Pound Capacity

35 Pound Capacity

Stacked 30 Pound Capacity

Through Serial No. 0602004143

Refer to Page 5 for Model Numbers

— Operation/Programming/Maintenance —

Keep These Instructions for Future Reference.

(If this machine changes ownership, this manual must accompany machine.)

Installation must conform with local codes or in the absence of local codes with:

In the U.S.A., installation must conform to the latest edition of the American National Standard Z223.1/ NFPA 54 “National Fuel Gas Code” and Standard ANSI/NFPA 70 “National Electric Code.”

In Canada, installation must comply with Standards CSA-B149.1 or Natural Gas and Propane Code CSA C22.1, latest edition, Canadian Electric Code, Part I.

In Australia, installation must comply with the Australian Gas Association Installation Code for Gas Burning Appliances and Equipment.

	WARNING
<p>FOR YOUR SAFETY, the information in this manual must be followed to minimize the risk of fire or explosion or to prevent property damage, personal injury or death.</p> <p style="text-align: right;">W033</p> <ul style="list-style-type: none">• Do not store or use gasoline or other flammable vapors and liquids in the vicinity of this or any other appliance.• WHAT TO DO IF YOU SMELL GAS:<ul style="list-style-type: none">– Do not try to light any appliance.– Do not touch any electrical switch; do not use any phone in your building.– Clear the room, building or area of all occupants.– Immediately call your gas supplier from a neighbor’s phone. Follow the gas supplier’s instructions.– If you cannot reach your gas supplier, call the fire department.• Installation and service must be performed by a qualified installer, service agency or the gas supplier. <p style="text-align: right;">W052</p>	
<p>FOR YOUR SAFETY</p> <p>Do not store or use gasoline or other flammable vapors and liquids in the vicinity of this or any other appliance.</p> <p style="text-align: right;">W053</p>	

	MISE EN GARDE
<p>POUR VOTRE SÉCURITÉ, veuillez à bien respecter les indications de ce manuel afin de minimiser les risques d’incendie ou d’explosion ou d’écarter les dangers de dommages matériels, corporel ou de mort.</p> <p style="text-align: right;">W033FR</p> <ul style="list-style-type: none">• Ne pas entreposer ni utiliser d’essence ni d’autres vapeurs ou liquides inflammables dans le voisinage de cet appareil ou de tout autre appareil.• QUE FAIRE SI VOUS SENTEZ UNE ODEUR DE GAZ :<ul style="list-style-type: none">– Ne pas tenter d’allumer d’appareil.– Ne touchez à aucun interrupteur. Ne pas vous servir des téléphones se trouvant dans le bâtiment où vous vous trouvez.– Évacuez la pièce, le bâtiment ou la zone.– Appelez immédiatement votre fournisseur de gaz depuis un voisin. Suivez les instructions du fournisseur.– Si vous ne pouvez rejoindre le fournisseur de gaz, appelez le service des incendies.• L’installation et l’entretien doivent être assurés par un installateur ou un service d’entretien qualifié ou par le fournisseur de gaz. <p style="text-align: right;">W052Q</p>	
<p>POUR VOTRE SÉCURITÉ</p> <p>Ne pas entreposer ni utiliser d’essence ou autres gaz et liquides inflammables au voisinage de cet appareil ou de tout autre.</p> <p style="text-align: right;">W053FR</p>	

IMPORTANT: Information must be obtained from a local gas supplier on instructions to be followed if the user smells gas. These instructions must be posted in a prominent location. Step-by-step instructions of the above safety information must be posted in a prominent location near the tumbler for customer use.

Table of Contents

Introduction	5
Model Identification	5
Customer Service.....	6
Wiring Diagram	6
Serial Plate Location.....	6
Safety Information	7
Explanation of Safety Messages	7
Important Safety Instructions	8
Operating Instructions	11
Emergency Stop Button on CE Models.....	11
Operating Instructions	11
Control Instructions	12
Electromechanical Coin Control.....	12
Manual Timer.....	13
Diagnostic Microprocessor Control	14
DMP Coin	15
DMP OPL Models	17
Maintenance	21
Daily	21
Monthly.....	23
Quarterly	23
Bi-Annually	23
Before You Call for Service	26
Customer Service.....	26

© Copyright 2006, Alliance Laundry Systems LLC

All rights reserved. No part of the contents of this book may be reproduced or transmitted in any form or by any means without the expressed written consent of the publisher.

Introduction

Model Identification

Information in this manual is applicable to these models.

	Gas		Steam	Electric
25 Pound	CHD25G2-CA025L CHD25G2-CA025N CHD25G2-CT025L CHD25G2-CT025N CHD25G2-CU025L CHD25G2-CU025N DR25G2-BA025L	DR25G2-BA025N DR25G2-BT025L DR25G2-BT025N DR25G2-BU025L DR25G2-BU025N IPD25G2-IT025L IPD25G2-IT025N	CHD25S2-CT025S CHD25S2-CU025S DR25S2-BT025S DR25S2-BU025S IPD25S2-IT025S	CHD25E2-CT025E CHD25E2-CU025E DR25E2-BT025E DR25E2-BU025E IPD25E2-IT025E
30 Pound	CHD30G2-CA030L CHD30G2-CA030N CHD30G2-CT030L CHD30G2-CT030N CHD30G2-CU030L CHD30G2-CU030N DR30G2-BA030L	DR30G2-BA030N DR30G2-BT030L DR30G2-BT030N DR30G2-BU030L DR30G2-BU030N IPD30G2-IT030L IPD30G2-IT030N	CHD30S2-CT030S CHD30S2-CU030S DR30S2-BT030S DR30S2-BU030S IPD30S2-IT030S	CHD30E2-CT030E CHD30E2-CU030E DR30E2-BT030E DR30E2-BU030E IPD30E2-IT030E
T30	CHD30STG2-CAT30L CHD30STG2-CAT30N CHD30STG2-CTT30L CHD30STG2-CTT30N CHD30STG2-CUT30L CHD30STG2-CUT30N DRST30G2-BAT30L	DRST30G2-BAT30N DRST30G2-BTT30L DRST30G2-BTT30N DRST30G2-BUT30L DRST30G2-BUT30N IPD30STG2-ITT30L IPD30STG2-ITT30N	CHD30STS2-CTT30S CHD30STS2-CUT30S DRST30S2-BTT30S DRST30S2-BUT30S IPD30STS2-ITT30S	CHD30STE2-CTT30E CHD30STE2-CUT30E DRST30E2-BTT30E DRST30E2-BUT30E IPD30STE2-ITT30E
35 Pound	CHD35G2-CA035L CHD35G2-CA035N CHD35G2-CT035L CHD35G2-CT035N CHD35G2-CU035L CHD35G2-CU035N DR35G2-BA035L	DR35G2-BA035N DR35G2-BT035L DR35G2-BT035N DR35G2-BU035L DR35G2-BU035N IPD35G2-IT035L IPD35G2-IT035N	CHD35S2-CT035S CHD35S2-CU035S DR35S2-BT035S DR35S2-BU035S IPD35S2-IT035S	CHD35E2-CT035E CHD35E2-CU035E DR35E2-BT035E DR35E2-BU035E IPD35E2-IT035E

Includes models with control suffixes:

3O – DX4 OPL
3V – DX4 vended
3X – DX4 prep for coin

DO – DMP OPL
DV – DMP vended
CD – rotary coin drop

CX – prep for coin
MT – manual timer

Introduction

Customer Service

If literature or replacement parts are required, contact the source from which the machine was purchased or contact Alliance Laundry Systems at (920) 748-3950 for the name and address of the nearest authorized parts distributor.

For technical assistance, call (920) 748-3121.

Wiring Diagram

The wiring diagram is located in the junction or contactor box.

Models starting Serial No. 0309_____ or later will have the wiring diagram part number in the lower portion of the electrical data on the serial plate.

Serial Plate Location

When calling or writing for information about your product, be sure to mention model and serial numbers. Model and serial numbers are found on serial plate on rear of machine, and inside door hinge. Refer to *Figure 1*.

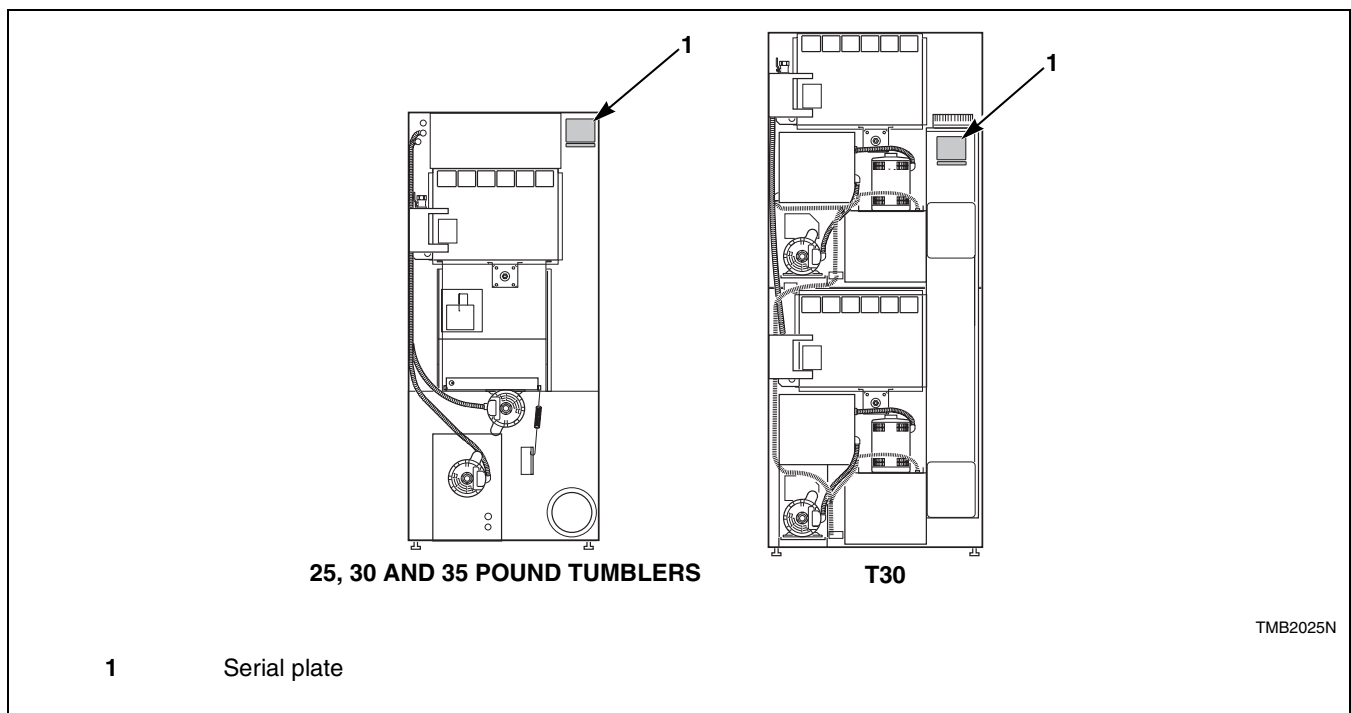



Figure 1

Conversion Table						
Multiply	By	To Obtain		Multiply	By	To Obtain
Btu	0.252	kCal		Pounds/sq. inch	0.06895	Bars
Btu	1055	Joules		Pounds/sq. inch	0.070	kg/sq. cm
Inch	25.4	Millimeters		Pounds (lbs.)	0.454	Kilograms
Inches W.C.	0.036	Pounds/sq. inch		Boiler Horsepower	33,479	Btu/hr.
Inches W.C.	0.249	kPa		Boiler Horsepower	34.5	lbs. steam/hr.
lb/inch ² (psi)	6.895	kPa		CFM	0.471	liters/second
ft ³	28.32	Liters		kW	3414	Btu/hr.

Safety Information

Explanation of Safety Messages

Precautionary statements (“DANGER,” “WARNING,” and “CAUTION”), followed by specific instructions, are found in this manual and on machine decals. These precautions are intended for the personal safety of the operator, user, servicer, and those maintaining the machine.

	DANGER
Indicates an imminently hazardous situation that, if not avoided, will cause severe personal injury or death.	

	WARNING
Indicates a hazardous situation that, if not avoided, could cause severe personal injury or death.	

	CAUTION
Indicates a hazardous situation that, if not avoided, may cause minor or moderate personal injury or property damage.	

Additional precautionary statements (“IMPORTANT” and “NOTE”) are followed by specific instructions.

IMPORTANT: The word “IMPORTANT” is used to inform the reader of specific procedures where minor machine damage will occur if the procedure is not followed.

NOTE: The word “NOTE” is used to communicate installation, operation, maintenance or servicing information that is important but not hazard related.

IMPORTANT: Warranty is void unless tumbler is installed according to instructions in the *Installation Manual*. Compliance with minimum specifications and requirements detailed herein, and with applicable local gas fitting regulations, municipal building codes, water supply regulations, electrical wiring regulations, and any other relevant statutory regulations. Because of varied requirements, applicable local codes should be thoroughly understood and all pre-installation work arranged for accordingly.

	WARNING
Failure to install, maintain, and/or operate this machine according to manufacturer’s instructions may result in conditions which can produce serious injury, death and/or property damage.	
W051R1	

NOTE: The WARNING and IMPORTANT instructions appearing in this manual are not meant to cover all possible conditions and situations that may occur. It must be understood that common sense, caution and carefulness are factors which CANNOT be built into this tumbler. These factors MUST BE supplied by the person(s) installing, maintaining or operating the tumbler.

Always contact your dealer, distributor, service agent or the manufacturer on any problems or conditions you do not understand.

Important Safety Instructions

Save These Instructions

	WARNING
Hazardous Voltage. Can cause shock, burn or cause death. Allow machine power to remain off for two minutes prior to working in and around AC inverter drive.	
<small>W359</small>	

1. Read all instructions before using the tumbler.
2. Refer to the **GROUNDING INSTRUCTIONS** for the proper grounding of the tumbler.
3. Do not dry articles that have been previously cleaned in, washed in, soaked in, or spotted with gasoline, dry cleaning solvents, other flammable or explosive substances as they give off vapors that could ignite or explode.
4. Do not allow children on or in the tumbler. This appliance is not intended for use by young children or infirm persons without supervision. Young children should be supervised to ensure that they do not play with the appliance.
5. Before the tumbler is removed from service or discarded, remove the door to the drying compartment and the door to the lint compartment.
6. Do not reach into the tumbler if the cylinder is revolving.
7. Do not install or store the tumbler where it will be exposed to water and/or weather.
8. Do not tamper with the controls.
9. Do not repair or replace any part of the tumbler, or attempt any servicing unless specifically recommended in the user-maintenance instructions or in published user-repair instructions that you understand and have the skills to carry out.
10. Do not use fabric softeners or products to eliminate static unless recommended by the manufacturer of the fabric softener or product.
11. To reduce the risk of fire, **DO NOT DRY** plastics or articles containing foam rubber or similarly textured rubberlike materials.
12. Always clean the lint filter daily.
13. Keep area around the exhaust opening and adjacent surrounding area free from the accumulation of lint, dust and dirt.
14. The interior of the tumbler and the exhaust duct should be cleaned periodically by qualified service personnel.
15. If not installed, operated and maintained in accordance with the manufacturer's instructions or if there is damage to or mishandling of this product's components, use of this product could expose you to substances in the fuel or from fuel combustion which can cause death or serious illness and which are known to the State of California to cause cancer, birth defects or other reproductive harm.
16. Tumbler will not operate with the loading door open. **DO NOT** bypass the door safety switch to permit the tumbler to operate with the door open. The tumbler will stop tumbling when the door is opened. Do not use the tumbler if it does not stop tumbling when the door is opened or starts tumbling without pressing or turning the START mechanism. Remove the tumbler from use and call for service.
17. Tumbler will not operate with lint panel open. **DO NOT** bypass lint panel safety switch to permit the tumbler to operate with the lint panel open.
18. Do not put articles soiled with vegetable or cooking oil in the tumbler, as these oils may not be removed during washing. Due to the remaining oil, the fabric may catch on fire by itself.
19. To reduce the risk of fire, **DO NOT** put clothes which have traces of any flammable substances such as machine oil, flammable chemicals, thinner, etc. or anything containing wax or chemicals such as in mops and cleaning cloths, or anything dry-cleaned at home with dry-cleaning solvent in the tumbler.
20. Use the tumbler only for its intended purpose, drying fabrics.
21. **ALWAYS** disconnect and lockout the electrical power to the tumbler before servicing. Disconnect power by shutting off appropriate breaker or fuse.
22. Install this tumbler according to the **INSTALLATION INSTRUCTIONS**. All connections for electrical power, grounding, and gas supply must comply with local codes and be made by licensed personnel when required.

23. Remove laundry immediately after tumbler stops.
24. Always read and follow manufacturer's instructions on packages of laundry and cleaning aids. Heed all warnings or precautions. To reduce the risk of poisoning or chemical burns, keep them out of reach of children at all times (preferably in a locked cabinet).
25. Do not tumble fiberglass curtains and draperies unless the label says it can be done. If they are dried, wipe out the cylinder with a damp cloth to remove particles of fiberglass.
26. Always follow the fabric care instructions supplied by the garment manufacturer.
27. Never operate the tumbler with any guards and/or panels removed.
28. **DO NOT** operate the tumbler if it is smoking, grinding, has missing or broken parts.
29. **DO NOT** bypass any safety devices.
30. Solvent vapors from dry-cleaning machines create acids when drawn through the heater of the drying unit. These acids are corrosive to the tumbler as well as to the laundry load being dried. Be sure make-up air is free of solvent vapors.
31. Failure to install, maintain, and/or operate this machine according to the manufacturer's instructions may result in conditions which can produce bodily injury and/or property damage.

	WARNING
To reduce the risk of serious injury, install lockable door(s) to prevent public access to rear of tumblers.	
<small>W055</small>	

Operating Instructions



WARNING

To reduce the risk of fire:

- DO NOT DRY articles containing foam rubber or similarly textured rubberlike materials.
- DO NOT DRY plastics, anything containing wax or chemicals such as mops and cleaning cloths, or anything dry-cleaned at home with a dry-cleaning solvent.
- DO NOT TUMBLE fiberglass curtains and draperies unless the label says it can be done. If they are dried, wipe out the cylinder with a damp cloth to remove particles of fiberglass.

W076

To reduce the risk of serious injury, allow cylinder to stop before cleaning lint screen.

W412

Emergency Stop Button on CE Models

All CE approved OPL tumblers are factory equipped with an emergency stop button located on the front panel. Refer to *Figure 2*.

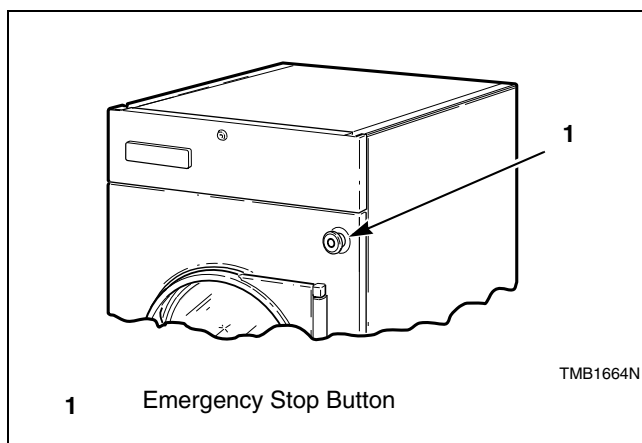

Figure 2

To operate emergency stop button:

- a. Press red emergency stop button to stop all action.
- b. To restart machine, pull red emergency stop button out and press START pad or button.

NOTE: Activation of the emergency stop button stops all machine control circuit functions, but DOES NOT remove all electrical power from machine.

Operating Instructions

Step 1: Clean Lint Screen/Compartment

Remove any accumulated lint from the lint screen and compartment. Close panel tightly against tumbler frame and lock panel securely, if applicable.

IMPORTANT: Clean lint screen and lint compartment daily. Failure to clean the lint screen daily will result in higher than normal temperatures that may damage laundry.

Step 2: Load Laundry

Open loading door and load cylinder with laundry. DO NOT OVERLOAD.

NOTE: Overloading causes slow drying and wrinkling.

Close loading door. Tumbler will not operate with the door open.

Step 3: Determine Control Type and Temperature Setting

Refer to the various controls, pages 12 - 20, and follow instructions for the appropriate control type.

T30 models only: use the correct coin slot and control panel for the top or bottom cylinder.

The type of fabric being dried will determine the setting. Consult the fabric care label or fabric manufacturer to determine proper temperature setting.

IMPORTANT: Always follow the fabric care instructions supplied by the garment manufacturer.

Step 4: Remove Laundry

When the cycle is complete, open door and remove the laundry.

Control Instructions

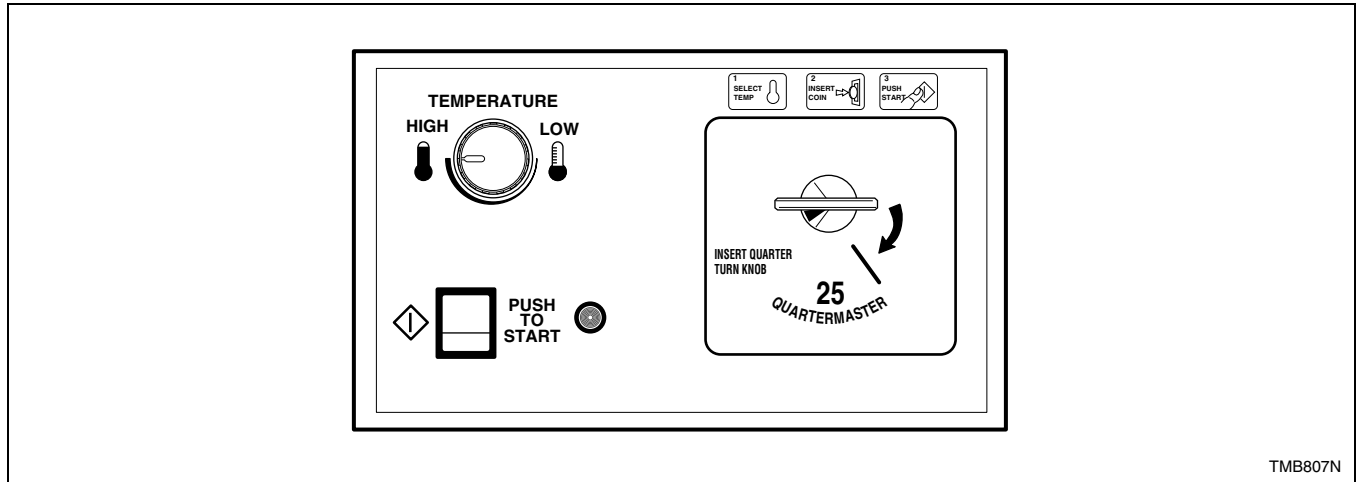

Figure 3

Electromechanical Coin Control

CD and CX Control Suffixes

1. Set the TEMPERATURE selector at HIGH or LOW, or anywhere between these settings.
2. Coin Drop Models: Insert the coin(s) in the coin slot, turn the knob to the right and release it.
3. Press the PUSH TO START button and hold it for approximately three (3) seconds.

NOTE: Additional drying time may be purchased at cycle start, or while tumbler is running, by adding additional coin(s).

IMPORTANT: If the loading door or lint panel door is opened during the cycle, the heating system will shut off and the motor will stop. However, the timer will continue to run. To restart the cycle, both doors must be closed and the PUSH TO START button must be pressed in.

4. When the cycle is complete, open door and remove the laundry.

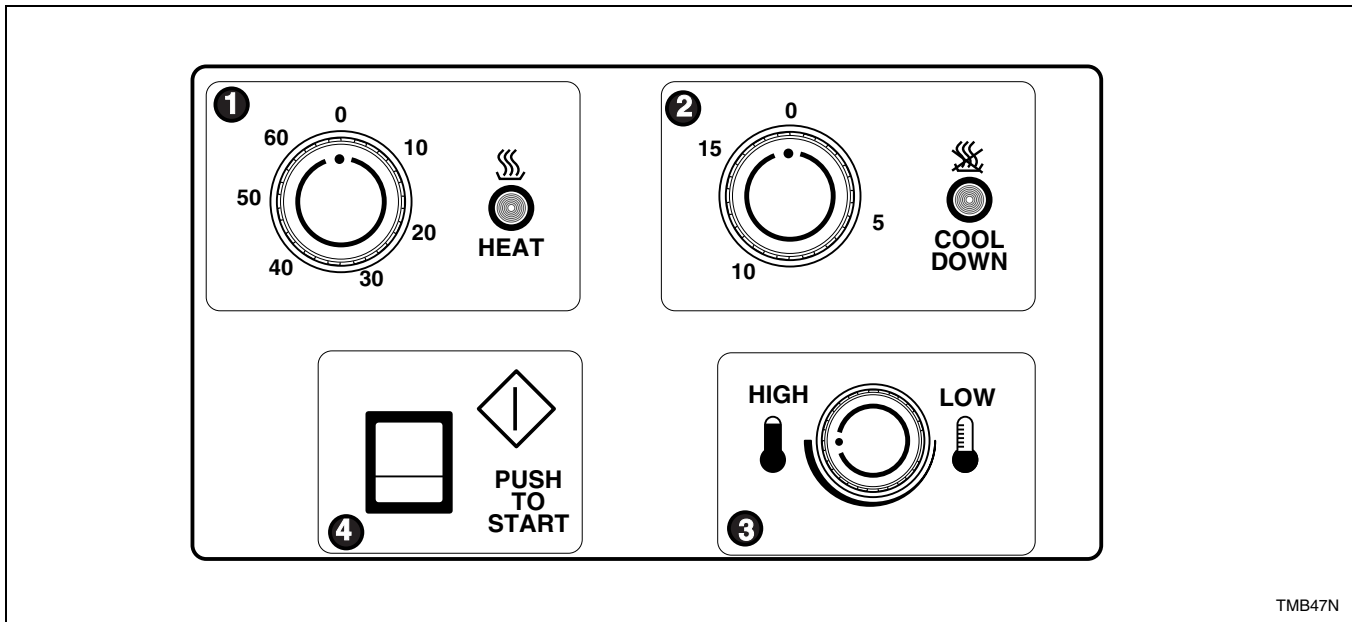

Figure 4

Manual Timer

MT Control Suffix

1. Set the HEAT (Drying) timer for the number of minutes (from 0-60) desired.
2. Set the COOL DOWN (Cooling) timer for the number of minutes (from 0-15) desired.
3. Set the Temperature selector at HIGH, LOW or anywhere between these settings.
4. Press the PUSH TO START button in and hold it in for approximately three seconds. This starts the tumbler cycle.

IMPORTANT: If the door is opened during the cycle, the heating system will shut off and the motor will stop. To restart the cycle, door must be closed and the PUSH TO START button must be pressed in.

5. When the cycle is complete, open door and remove the laundry.

TMB47N

Operating Instructions

Diagnostic Microprocessor Control

General Operation

The Diagnostic Microprocessor Control (DMP) is designed to manage the drying and cooling cycles of the tumbler. The controller is also programmed from the factory with five different default programs as described below. The operator has the flexibility to select the time for the drying and the cool down cycles and the drying temperature. The operator may also select either reversing or nonreversing basket action only if the tumbler is equipped for reversing. The operator may also reprogram the default programs. See Programming.

Default Programs

Programs	Dry Time (Min.)	Cool Time (Min.)	Temp. Set Point	Reversing
1 – Towels	40	5	185°/195°F (85°/91°C)	No
2 – Sheets	30	5	165°F (74°C)	Yes
3 – Misc-1	30	5	150°F (66°C)	No
4 – Misc-2	25	5	135°F (57°C)	Yes
5 – Extra Dry	5	2	150°F (66°C)	No

NOTE: If an altered program is determined to be corrupted, the default program settings will be used.

Table 1

Features

- Drying time: 0-60 minutes
- Cooling time: 2-60 minutes
- LED display of cycle time, set temperature, and actual temperature
- Thermistor controlled temperature
- Safety tumble cycle
- Buzzer for end of cycle, audible alarm
- Reversing/Nonreversing selection
- Five user programmable programs
- RPM display – when equipped with rotational sensor only
- Monitors the lint door switch operation
- Monitors the thermistor for operation

The minimum drying time is 0 minutes, and the minimum cooling time is 2 minutes. The maximum drying or cooling time is 60 minutes. The drying temperature may be set from 100°F (38°C) to 185°/195°F (85°/91°C). The drying time, cooling time, or temperature may be modified during an operating cycle.

If it is necessary to reset the drying and cooling times for the current cycle, press STOP once to stop the tumbler. Press STOP again to cancel the cycle.

If it is necessary to change programs during a current cycle, press STOP once to stop the tumbler and press STOP again to cancel the current cycle.

DMP Coin

DV Control Suffix

Description of The Coin Control Panel

Refer to *Figure 5*.

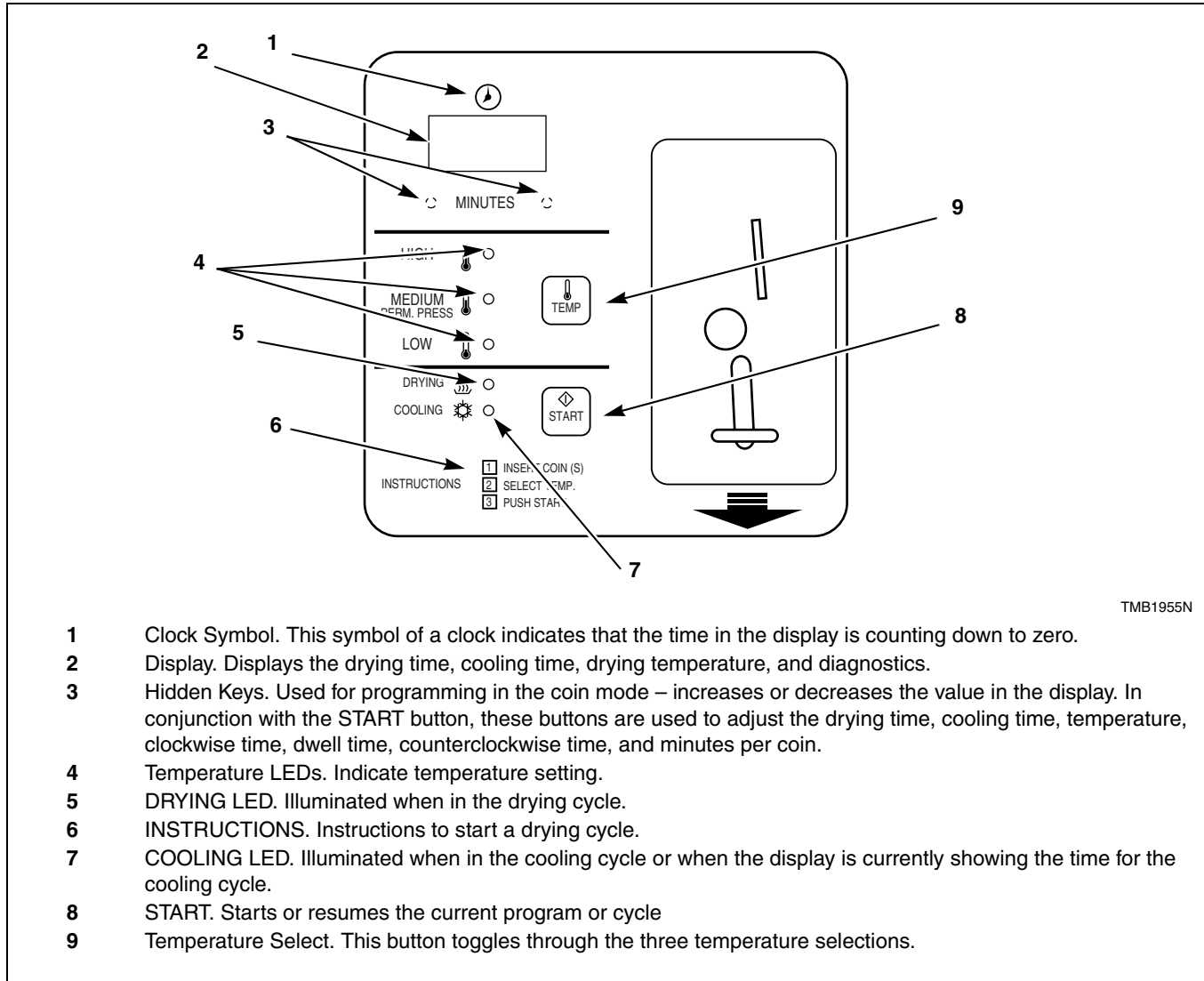

TMB1955N

- 1 Clock Symbol. This symbol of a clock indicates that the time in the display is counting down to zero.
- 2 Display. Displays the drying time, cooling time, drying temperature, and diagnostics.
- 3 Hidden Keys. Used for programming in the coin mode – increases or decreases the value in the display. In conjunction with the START button, these buttons are used to adjust the drying time, cooling time, temperature, clockwise time, dwell time, counterclockwise time, and minutes per coin.
- 4 Temperature LEDs. Indicate temperature setting.
- 5 DRYING LED. Illuminated when in the drying cycle.
- 6 INSTRUCTIONS. Instructions to start a drying cycle.
- 7 COOLING LED. Illuminated when in the cooling cycle or when the display is currently showing the time for the cooling cycle.
- 8 START. Starts or resumes the current program or cycle
- 9 Temperature Select. This button toggles through the three temperature selections.

Figure 5

Operating Instructions

DMP Coin Features

Coin Keypad Interface

- START button to start or resume a cycle.
- TEMP button to select HIGH, MEDIUM, or LOW temperature.
- Two hidden buttons to increment or decrement the programmable time and temperature options.

Power-Up

Upon applying power to the tumbler, the display will show “PAy” and the DRYING and COOLING LEDs will be off until coins are deposited to increase the tumbler run time. When time is displayed, the default (LOW) temperature setting LED will be on until a different temperature setting is selected.

Power Failure

If a power loss occurs during operation, a cycle will not resume until the START button is pressed. To cancel the remaining cycle, press the internal CLEAR button.

Coin Operation

The tumbler run time is determined by the pre-programmed run time per coin and the number of coins deposited into the tumbler. The maximum time that can be accumulated and displayed is 99 minutes. The drying time is the difference between the run time and the cooling time. The cooling time is pre-programmed to be 2 to 5 minutes. The drying temperature can be selected from LOW, MEDIUM, or HIGH temperature settings by pressing the TEMP button.

Coin Programming

The Coin board programming mode can only be entered when “PAy” is displayed. DIP switch #7 must be in the OFF position.

Programming is enabled by setting DIP switch #8 to the ON position.

The programming mode is entered by pressing and holding the CLEAR button for three seconds.

The programming follows the following parameter order:

1. Tumbler run time per coin (DRYING), COOLING time, HIGH temperature setpoint, MEDIUM temperature setpoint, LOW temperature setpoint.
2. An LED will be on to indicate which parameter is flashing on the display.
3. The hidden front panel increment and decrement keys are used to change the value.
4. The CLEAR button is used to recall the default value.
5. The START button is used to step to the next parameter.
6. After the last parameter, “End” will be flashing.
7. Press the START button one last time to store the settings and exit the program mode.
8. “PAy” will be displayed.
9. If it is determined that the data did not program correctly, the error message “E2F” will flash for 4 seconds, and then the default coin parameters will be used.

The tumbler run time per coin is programmable for 1 to 20 minutes with the default preset to 10 minutes.

The cooling run time is programmable from 2 to 5 minutes with the default preset to 2 minutes.

The three temperatures setpoints are programmable for 100°F (38°C) to 185°/195°F (85°/90°C) with the following default settings:

- HIGH equal to 185°F (85°C)
- MEDIUM equal to 150°F (66°C)
- LOW equal to 135°F (57°C)

Stop

When in the Coin mode, the tumbler will stop if the tumbler door is opened while the tumbler is running. If the CLEAR button, located behind the board, is pressed, the tumbler will stop, the tumbler time will be zeroed and the display will show “PAy.”

Coin Count

The unit will count the number of coins deposited.

Setting DIP switch #7 to the ON position will display the coin count since it was the last reset.

To reset the count, press the CLEAR button and “00” will be displayed.

If the coin count is greater than “999,” the display will flash “999.”

Setting DIP switch #7 to the OFF position will return the display to “PAy.”

DMP OPL Models

DO Control Suffix

Description of the OPL Control Panel

Refer to *Figure 6*.

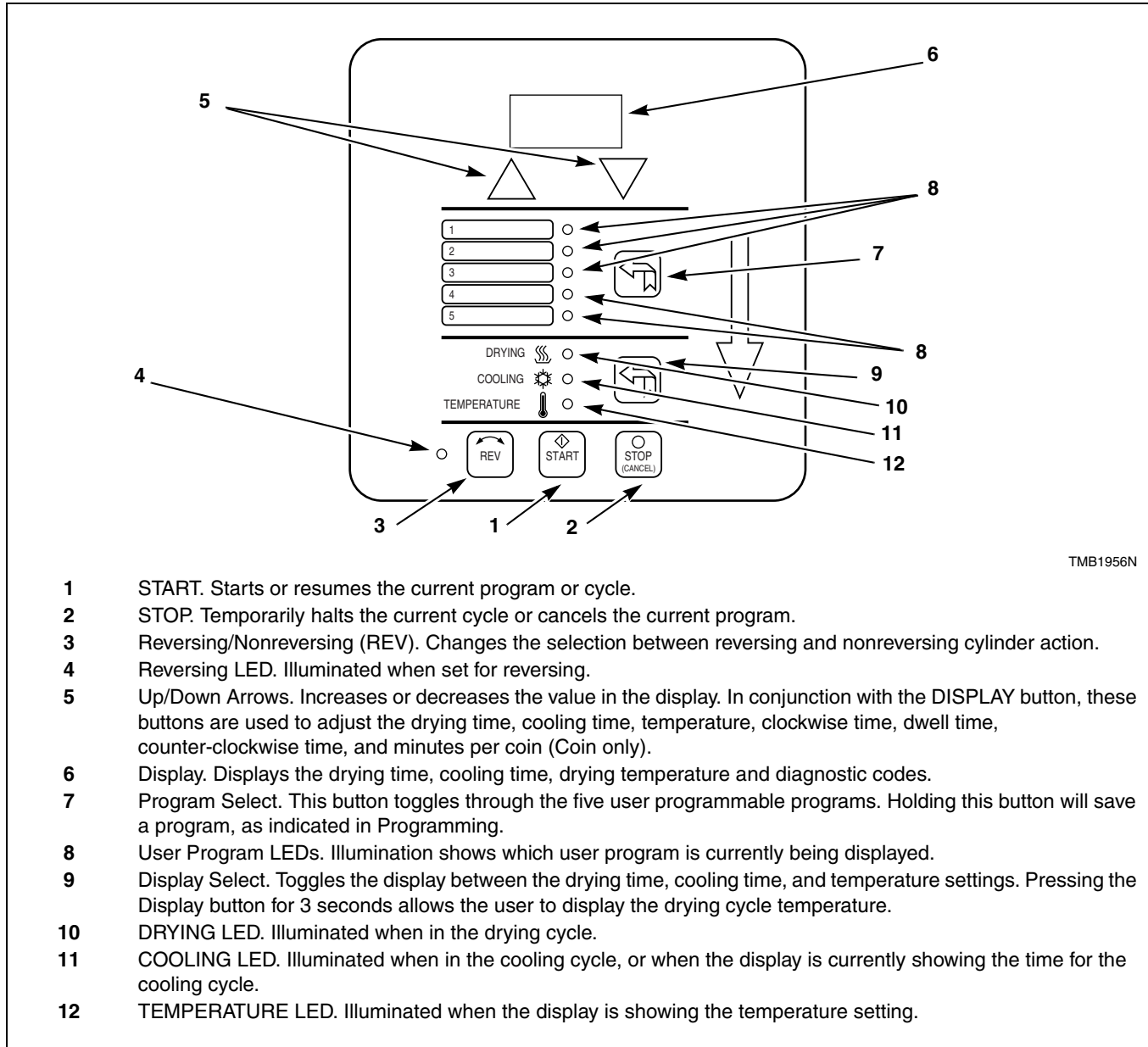

TMB1956N

- 1 START. Starts or resumes the current program or cycle.
- 2 STOP. Temporarily halts the current cycle or cancels the current program.
- 3 Reversing/Nonreversing (REV). Changes the selection between reversing and nonreversing cylinder action.
- 4 Reversing LED. Illuminated when set for reversing.
- 5 Up/Down Arrows. Increases or decreases the value in the display. In conjunction with the DISPLAY button, these buttons are used to adjust the drying time, cooling time, temperature, clockwise time, dwell time, counter-clockwise time, and minutes per coin (Coin only).
- 6 Display. Displays the drying time, cooling time, drying temperature and diagnostic codes.
- 7 Program Select. This button toggles through the five user programmable programs. Holding this button will save a program, as indicated in Programming.
- 8 User Program LEDs. Illumination shows which user program is currently being displayed.
- 9 Display Select. Toggles the display between the drying time, cooling time, and temperature settings. Pressing the Display button for 3 seconds allows the user to display the drying cycle temperature.
- 10 DRYING LED. Illuminated when in the drying cycle.
- 11 COOLING LED. Illuminated when in the cooling cycle, or when the display is currently showing the time for the cooling cycle.
- 12 TEMPERATURE LED. Illuminated when the display is showing the temperature setting.

Figure 6

Operating Instructions

DMP OPL Features

DIP Switch Settings

The DMP has an 8 position DIP switch bank that is accessible from the back of the control board. By switching these DIP switches, it is possible for the operator to customize the display and some of the operating features of the tumbler.

Function	OPL	Coin				
1	Tumbler Type	OFF	ON	OPL=Off; Coin=On		
2	Temperature Units	OFF	OFF	°F=Off; °C=On		
3	Local/Remote Reversing	ON	ON	Local=On; Remote=Off		
4	Empty	ON	ON	Always ON		
5	Empty	ON	ON	Always ON		
6	Buzzer Timer	ON	ON	5 Sec=Off; Continuous=On		
7	Safety Tumble (OPL) or Coin Count/Pay (Coin)	ON	OFF	#1	#7	DIP SWITCH
				OFF	ON	SAFETY TUMBLE
				OFF	OFF	NO SAFETY TUMBLE
				ON	ON	COIN COUNT
ON	OFF	PAY				
8	Programming	OFF	OFF	Disable=Off; Enable=On		

Table 2

DIP Switch Functions Explained

1. Tumbler Type: This DIP switch selects the type of tumbler, i.e., OPL or Coin.
2. Temperature Units: Selects °F or °C for the temperature display. Factory setting is for °F.
3. Local/Remote Reversing: Preset at the factory; usually for local reversing. Remote reversing for use with Reversing Timer Board only.
4. Empty: Preset at the factory; always ON.
5. Empty: Preset at the factory; always ON.
6. Buzzer Timer: This DIP switch determines the length of time that the end of cycle buzzer will remain on. "OFF" indicates that the buzzer will sound for 5 seconds when the drying cycle is completed. "ON" indicates that the buzzer will sound continuously until the STOP button is pressed or the loading door is opened.
7. Safety Tumble (OPL) or Coin count/Pay (Coin): If DIP switch #1 is set for OPL, then DIP switch #7 in the ON position enables the safety tumble. If DIP switch #1 is set for Coin, then DIP switch #7 in the ON position enables the display of the coin count. DIP switch #7 in the OFF position enables the display of "PAY," to indicate that coins are needed to run the tumbler.
8. Programming: This switch enables or disables the programming feature and should normally be in the OFF position.

Programming

1. Set DIP switch #8 to the ON position.
2. Select the desired program number to change. The LED should be flashing.
3. Select DRY TIME. Set the time with the Up/Down arrows.
4. Select COOL TIME. Set the time with the Up/Down arrows.
5. Select TEMPERATURE. Set the temperature with the Up/Down arrows.
6. Select reversing REV (illuminated) or nonreversing REV (not illuminated). To change basket direction and dwell time, see *Reversing Operation*.
7. Press and hold the Program Select button about 3 seconds until the LED stops flashing. The selected program number is now programmed. If the Program button is pressed for less than 3 seconds, the controller will cancel the program and display the next program's settings. If not programmed correctly, the display will flash "E2F" for 4 seconds, and the default settings will be used. Follow steps 4 through 7 to reprogram any program number. When finished, set DIP switch #8 to OFF. The programs are now stored.
8. During the Program Mode, if the Up/Down arrows, REV, or Display button is not pressed within 10 seconds, the default program settings will be used.
9. Temporary Reprogramming of Current Programs (OPL ONLY)
10. The Drying Time, Cooling Time, Temperature, and Reversing Mode of a program currently in use may be modified simply by adjusting any or all of the program parameters for that program, as needed. Once a modification has been made, the current program LED will flash indicating that it has been modified.
11. Use the Up/Down arrows to adjust program time.
12. Use the Display Select button to choose between Drying Time, Cooling Time, and Temperature. Then use the Up/Down arrows to adjust the times and temperature.
13. Toggle between reversing REV (illuminated) or nonreversing REV (not illuminated). (Only for tumblers with the reversing option.)
14. To cancel this temporary programming mode push the STOP button once to stop the current cycle and once more to cancel the modified program settings. The program will revert back to its original settings.

Reversing Operation

1. When the LOCAL reversing operation is selected, the reversing times are stored in the EEPROM which is located on the controller board. If the values stored are determined to be invalid, the clockwise and counterclockwise times will default to 60 seconds, and the dwell time will default to 4 seconds.
2. The reversing time program has the following sequence: (1) clockwise time, (2) dwell time, and (3) counterclockwise time.
3. To program new reversing times DIP switches #3 and #8 must be on.
4. Press and hold the reverse button (REV) for 3 seconds to display the clockwise time.
5. Use the Up/Down arrows to set the clockwise time within the range of 30-120 seconds.
6. Press REV to display the dwell time.
7. Use the Up/Down arrows to change the dwell time within the range of 3-10 seconds.
8. Press the REV button to display the counterclockwise time.
9. Use the Up/Down arrows to change the counterclockwise time within the range of 30-120 seconds.
10. Press the REV button to save these settings and leave DIP switch #3 in the ON position and flip DIP switch #8 to the OFF position.

When the DMP controller is retrofitted to an existing tumbler with the reversing feature, off board reversing will be required and DIP switch #3 on the DMP must be in the OFF position and the DMP must be connected to the Reversing Timer Board for proper operation. The DMP settings for clockwise, dwell, and counterclockwise times are no longer valid when used with the Reversing Board. Instead these settings are made on the Reversing Timer Board.

Operating Instructions

Rotation Sensor

The rotation sensor must “read” the key on the basket shaft or pulley. The sensor must be set approximately 1/4 inch from the key or pulley. Look for the light on the sensor to come on as the key passes the sensor; this is a correctly operating sensor. If no light appears, either the sensor is out of range or the key/pulley or the sensor is bad. In addition, if the light stays on continuously, then the sensor is too close to the component or the sensor is bad.

Safety Tumble/Anti-Wrinkle

At the end of the cool down cycle, the tumbler will stop and display “END.” The DMP control will automatically rotate the basket for 5 seconds every 2 minutes for a total of 20 minutes, until some function of the tumbler is activated/deactivated by the user.

Operational Check for the Board Diagnostics

1. “dor” indicates that the loading or lint door is open.
2. Cycle the tumbler to check if the buzzer activates.
3. “P-F” indicates that the thermistor is short circuited or open circuited.
4. “bbt” indicates a broken belt condition or a faulty rotation sensor. (Only available on tumblers with the rotation sensor.)
5. Hold the START button to display the drum RPM’s; the display will read “r##” where ## are the RPM’s. (Only available on tumblers with the rotation sensor.)

Maintenance



WARNING

To reduce the risk of electric shock, fire, explosion, serious injury or death:

- Disconnect electric power to the tumbler before servicing.
- Close gas shut-off valve to gas tumbler before servicing.
- Close steam valve to steam tumbler before servicing.
- Never start the tumbler with any guards/panels removed.
- Whenever ground wires are removed during servicing, these ground wires must be reconnected to ensure that the tumbler is properly grounded.

W002

Daily

1. Inspect the area surrounding tumblers, remove all combustible materials, including lint, before operating the machines.
2. Check cylinder for foreign objects to avoid damage to clothing and equipment.
3. Clean lint from lint compartment and screen to maintain proper airflow and avoid overheating.
 - a. Open the lint panel or pull out lint drawer.
 - b. Remove all accumulated lint in the lint compartment area. Lightly brush any lint that may be left on the lint screen. Lint left in the lint compartment is drawn back onto the lint screen and will restrict proper air circulation.
 - c. Be sure the lint screen is not torn. If it is, replace immediately. A torn lint screen allows lint to pass from the tumbler to the ductwork system, thus creating a restriction to air circulation.
 - d. The lint screen is designed to completely cover the entire opening in the lint screen panel. Be sure that it does so. Excessive gaps between the lint screen and the lint screen panel allow lint to pass into the ductwork system.
 - e. Carefully wipe any accumulated lint off of the cabinet high limit thermostat and thermistor. Failure to do so will allow a buildup of lint in this area to act as an insulator, causing the tumbler to overheat. Refer to *Figure 7*.
 - f. Replace the lint compartment panel on the tumbler ensuring a tight fit, and lock if applicable.



WARNING

To reduce the risk of serious injury, do not open the lint panel while the tumbler is in operation. Before cleaning the lint screen, open tumbler door and allow cylinder to completely stop.

W410



WARNING

To reduce the risk of electric shock, fire, explosion, serious injury or death:

- Disconnect electric power to the tumbler before servicing.
- Close gas shut-off valve to gas tumbler before servicing.
- Close steam valve to steam tumbler before servicing.
- Never start the tumbler with any guards/panels removed.
- Whenever ground wires are removed during servicing, these ground wires must be reconnected to ensure that the tumbler is properly grounded.

W002

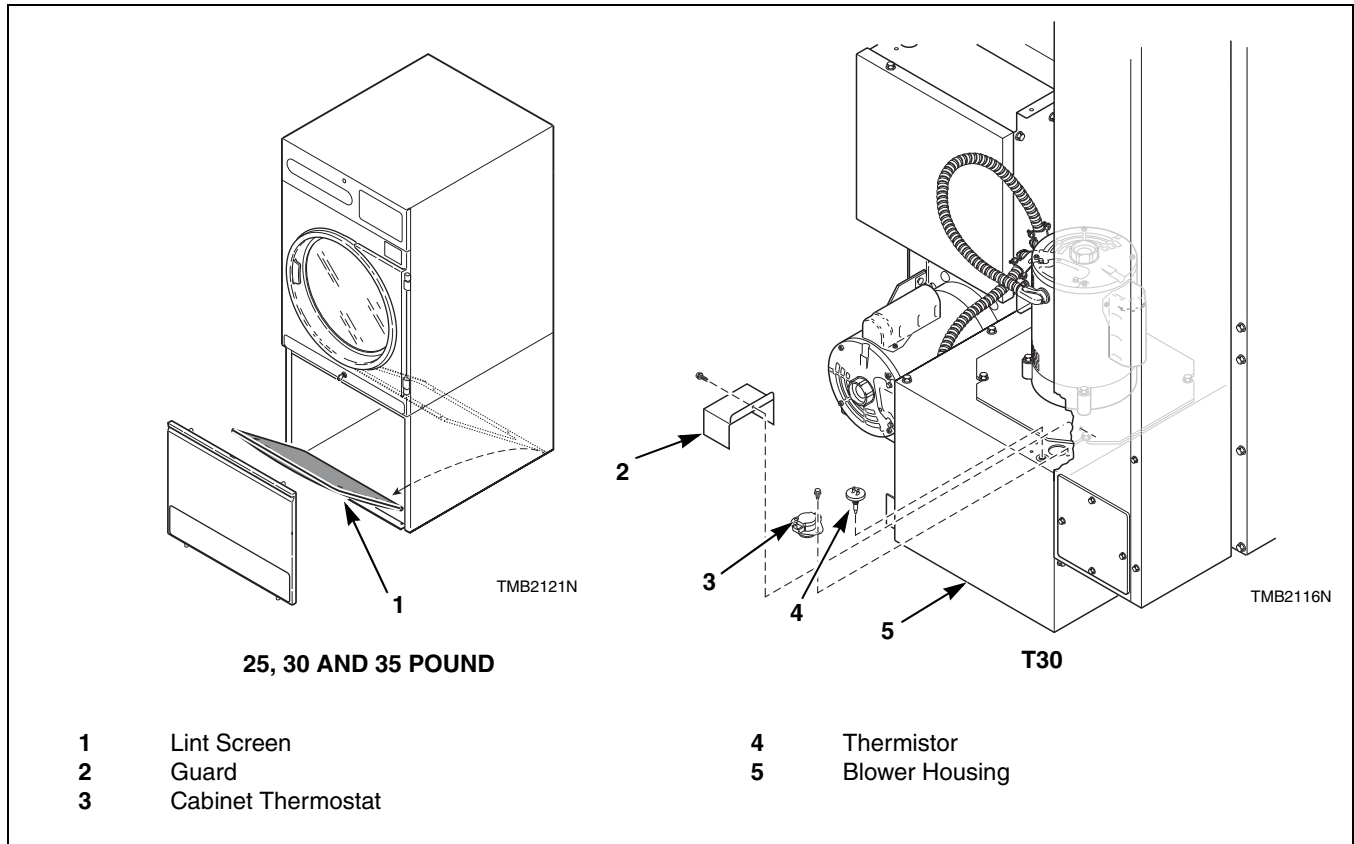

Figure 7



WARNING

To reduce the risk of electric shock, fire, explosion, serious injury or death:

- Disconnect electric power to the tumbler before servicing.
- Close gas shut-off valve to gas tumbler before servicing.
- Close steam valve to steam tumbler before servicing.
- Never start the tumbler with any guards/panels removed.
- Whenever ground wires are removed during servicing, these ground wires must be reconnected to ensure that the tumbler is properly grounded.

W002

Monthly

1. Remove lint and debris from inside exhaust duct to maintain proper airflow and avoid overheating.
 - a. Remove external duct and duct access covers, if present.
 - b. Clean inside of duct with a vacuum.
 - c. Clean dampers and make sure they operate freely.
 - d. Replace duct and all access covers before returning to operation.
2. Ensure even lint distribution over lint screen, replace if distribution of lint is uneven to maintain proper airflow and avoid overheating.
3. Carefully wipe any accumulated lint off the cabinet high limit thermostat and thermistor, including perforated cover. Lint buildup will act as an insulator, causing machine to overheat.
4. Clean lint and debris buildup from blower to maintain proper airflow, to avoid overheating and prevent possible vibration.

Bi-Annually

1. Check mounting hardware for any loose nuts, bolts or screws.
2. Check gas connections for leakage.
3. Check for loose electrical connections.
4. Check steam connections for looseness and leakage.
5. Remove all front panels and vacuum, including coin drop mechanisms.
6. Check cylinder and front panel seals.
7. Inspect cabinet and inner panels for any damage, replace or repair as needed.
8. Clean burner tubes of any lint buildup.

Quarterly

1. Use a vacuum to clean air vents on drive motors.
2. Use a vacuum to clean lint from rear limit thermostat cover.
3. Refer to Service Manual on how to check and clean steam coils, if applicable.
4. Check flow of combustion and ventilation air.
5. Check belt tension and condition. Replace worn or cracked belts.

	WARNING
<p>To reduce the risk of electric shock, fire, explosion, serious injury or death:</p> <ul style="list-style-type: none"> • Disconnect electric power to the tumbler before servicing. • Close gas shut-off valve to gas tumbler before servicing. • Close steam valve to steam tumbler before servicing. • Never start the tumbler with any guards/panels removed. • Whenever ground wires are removed during servicing, these ground wires must be reconnected to ensure that the tumbler is properly grounded. 	
W002	

Daily Maintenance

Inspect the area surrounding tumblers, remove all combustible materials, including lint, before operating the machine.								
Check cylinder for foreign objects to avoid damage to clothing and equipment.								
Clean lint from lint compartment and screen to maintain proper airflow and avoid overheating.								

Monthly Maintenance

Remove lint and debris from inside exhaust duct to maintain proper airflow and avoid overheating.								
Ensure even lint distribution over lint screen. Replace if distribution of lint is uneven to maintain proper airflow and avoid overheating.								
Carefully wipe any accumulated lint off the cabinet high limit thermostat and thermistor, including perforated cover. Lint buildup will act as an insulator, causing machine to overheat.								
Clean lint and debris buildup from blower to maintain proper airflow, to avoid overheating and prevent possible vibration.								

	WARNING
<p>To reduce the risk of electric shock, fire, explosion, serious injury or death:</p> <ul style="list-style-type: none"> • Disconnect electric power to the tumbler before servicing. • Close gas shut-off valve to gas tumbler before servicing. • Close steam valve to steam tumbler before servicing. • Never start the tumbler with any guards/panels removed. • Whenever ground wires are removed during servicing, these ground wires must be reconnected to ensure that the tumbler is properly grounded. 	
W002	

Quarterly Maintenance

Use a vacuum to clean air vents on drive motors.									
Use a vacuum to clean lint from rear limit thermostat cover.									
Refer to Service Manual on how to check and clean steam coils.									
Check flow of combustion and ventilation air.									
Check belt tension and condition. Replace worn or cracked belts.									

Bi-Annually Maintenance

Check mounting hardware for any loose nuts, bolts or screws.									
Check gas connections for leakage.									
Check for loose electrical connections.									
Check steam connections for looseness and leakage.									
Remove all front panels and vacuum, including coin drop mechanisms.									
Check cylinder and front panel seals.									
Inspect cabinet and inner panels for any damage, replace or repair as needed.									
Clean burner tubes of any lint buildup.									

Before You Call for Service

Won't Start	Won't Heat	Clothes Not Dry	Possible Reason – Corrective Actions
•			Insert correct coin(s) or valid card if applicable.
•			Close the loading door tightly.
•			Close lint panel tightly.
•			Press the PUSH TO START button.
•			Be sure power cord is plugged all the way into the electrical outlet.
•			Drying timer is in OFF position.
•			Check the main fuse and circuit breaker.
•			Check fuses located in the machine.
	•		Insufficient airflow.
	•		Gas shut-off valve in OFF position.
	•		Are controls properly set?
	•		Broken drive belt. Call the service person.
	•	•	Tumbler is in Cool Down Mode.
	•	•	Lint screen clogged. Clean lint screen.
	•	•	Exhaust duct to outside is blocked. Clean out.

Customer Service

If literature or replacement parts are required, contact the source from which the machine was purchased or contact Alliance Laundry Systems at (920) 748-3950 for the name and address of the nearest authorized parts distributor.

For technical assistance, call (920) 748-3121.

Free Manuals Download Website

<http://myh66.com>

<http://usermanuals.us>

<http://www.somanuals.com>

<http://www.4manuals.cc>

<http://www.manual-lib.com>

<http://www.404manual.com>

<http://www.luxmanual.com>

<http://aubethermostatmanual.com>

Golf course search by state

<http://golfingnear.com>

Email search by domain

<http://emailbydomain.com>

Auto manuals search

<http://auto.somanuals.com>

TV manuals search

<http://tv.somanuals.com>