

**ALTO SHAAM®**

**Catering Warmer  
Electric**



*500-E*

**Models:**

**500-E  
500-E/Deluxe**



*500-E/Deluxe*

- **INSTALLATION**
- **OPERATION**
- **MAINTENANCE**

**HALO  
HEAT®**

**24•7**  
Your Service Hotline  
1-800-558-8744

**W164 N9221 Water Street • P.O. Box 450 • Menomonee Falls, Wisconsin 53052-0450 USA**  
PHONE: 262.251.3800 • 800.558.8744 USA/CANADA FAX: 262.251.7067 • 800.329.8744 U.S.A. ONLY  
WEBSITE: [www.alto-shaam.com](http://www.alto-shaam.com)

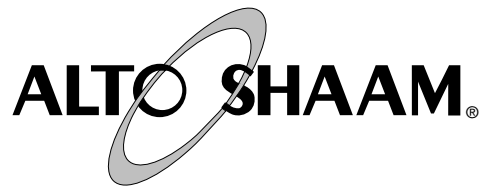

## DELIVERY

This Alto-Shaam appliance has been thoroughly tested and inspected to insure only the highest quality unit is provided. Upon receipt, check for any possible shipping damage and report it at once to the delivering carrier. See *Transportation Damage and Claims section located in this manual.*

This appliance, complete with unattached items and accessories, may have been delivered in one or more packages. Check to ensure that all standard items and options have been received with each model as ordered.

Save all the information and instructions packed with the appliance. Complete and return the warranty card to the factory as soon as possible to assure prompt service in the event of a warranty parts and labor claim.

This manual must be read and understood by all people using or installing the equipment model. Contact the Alto-Shaam service department if you have any questions concerning installation, operation, or maintenance.

**NOTE:** All claims for warranty must include the full model number and serial number of the unit.

## UNPACKING

1. Carefully remove the appliance from the carton or crate.

**NOTE:** Do not discard the carton and other packaging material until you have inspected the unit for hidden damage and tested it for proper operation.

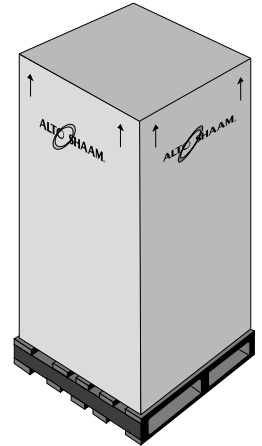

2. Read all instructions in this manual carefully before initiating the installation of this appliance.

### **DO NOT DISCARD THIS MANUAL.**

This manual is considered to be part of the appliance and is to be provided to the owner or manager of the business or to the person responsible for training operators. *Additional manuals are available from the Alto-Shaam service department.*

3. Remove all protective plastic film, packaging materials, and accessories from the appliance before connecting electrical power. Store any accessories in a convenient place for future use.

## SAFETY PROCEDURES AND PRECAUTIONS

Knowledge of proper procedures is essential to the safe operation of electrically and/or gas energized equipment. In accordance with generally accepted product safety labeling guidelines for potential hazards, the following signal words and symbols may be used throughout this manual.

**! DANGER** Used to indicate the presence of a hazard that **will** cause severe personal injury, death, or substantial property damage if the warning included with this symbol is ignored.

**! WARNING** Used to indicate the presence of a hazard that **can** cause personal injury, possible death, or major property damage if the warning included with this symbol is ignored.

**! CAUTION** Used to indicate the presence of a hazard that can or will cause minor or moderate personal injury or property damage if the warning included with this symbol is ignored.

**CAUTION** Used to indicate the presence of a hazard that can or will cause minor personal injury, property damage, or a potential unsafe practice if the warning included with this symbol is ignored.

**NOTE:** Used to notify personnel of installation, operation, or maintenance information that is important but not hazard related.

1. This appliance is intended to cook, hold or process foods for the purpose of human consumption. No other use for this appliance is authorized or recommended.
2. This appliance is intended for use in commercial establishments where all operators are familiar with the purpose, limitations, and associated hazards of this appliance. Operating instructions and warnings must be read and understood by all operators and users.
3. Any troubleshooting guides, component views, and parts lists included in this manual are for general reference only and are intended for use by qualified technical personnel.
4. This manual should be considered a permanent part of this appliance. This manual and all supplied instructions, diagrams, schematics, parts lists, notices, and labels must remain with the appliance if the item is sold or moved to another location.

| <b>NOTE</b>  |  |
|--|--|
|  | <p>For equipment delivered for use in any location regulated by the following directive:<br/><b>DO NOT DISPOSE OF ELECTRICAL OR ELECTRONIC EQUIPMENT WITH OTHER MUNICIPAL WASTE.</b></p> |

# INSTALLATION

## Site Installation

This appliance, complete with unattached items and accessories, may be delivered in one or more packages. Check to insure that all accessories that were ordered have been received with the unit.

Alto-Shaam holding cabinets are designed for the purpose of maintaining hot food at a temperature for safe consumption. The unit must be installed on a level surface in a location that will permit the equipment to function for its intended purpose and allow adequate access for proper cleaning and maintenance.

The appliance must not be used in any area where it will be affected by steam, grease, dripping water, high temperatures, or any other severely adverse conditions.

### CLEARANCE REQUIREMENTS

3 inches (76mm)  
top, bottom, right and left

### NET WEIGHT

500-E: 59 lb. (27 kg)  
500-E/Deluxe: 76 lb. (34 kg)

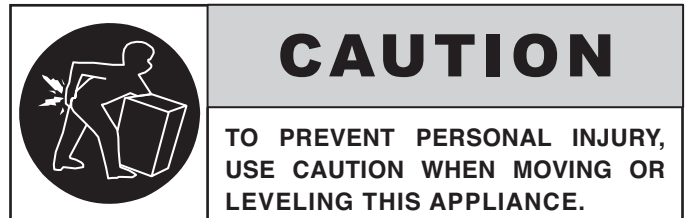
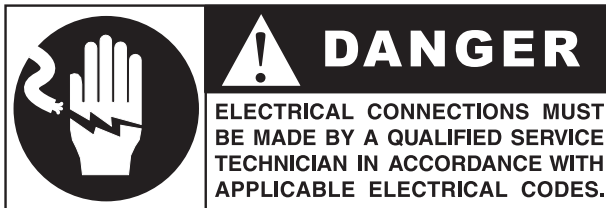

# INSTALLATION

## Site Installation

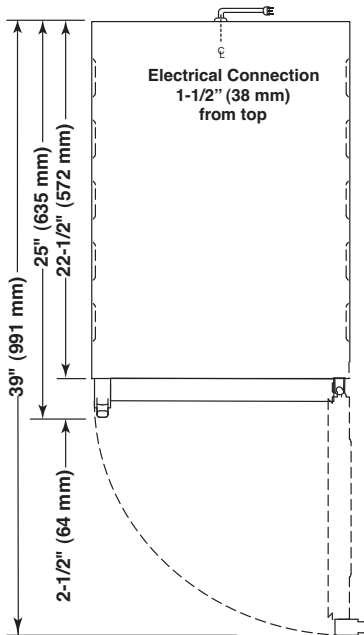

### Outside Dimensions

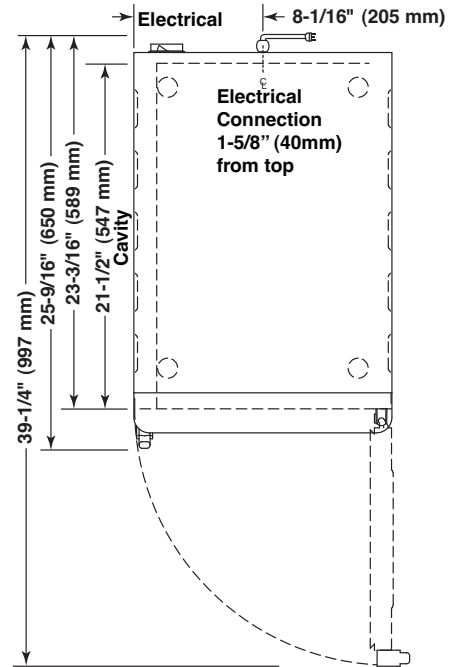

**500-E**

**500-E/Deluxe**

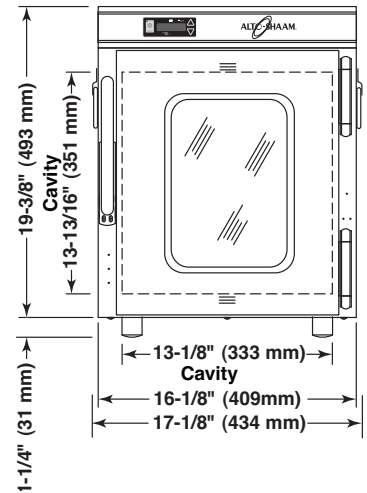
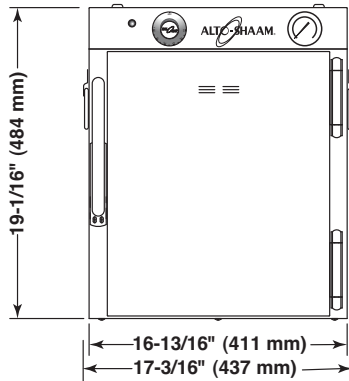

### OPTIONS & ACCESSORIES

|   | 500-E   | 500-E/Deluxe |
|---|---------|--------------|
| Casters*, 3" (76mm) (4)                           |         | 14227*       |
| Casters*, 5" (127mm) (4)                          |         | 4007*        |
| Caster Stand Assembly with 5" (127mm) casters (4) | 15377   |              |
| Legs*, 6" (152mm) (4)                             |         | 5205*        |
| Leg Stand Assembly, with 6" (152mm) legs (4)      | 15378   |              |
| Pan Slide Support (2 REQUIRED)                    | 11002   |              |
| Shelf, chrome plated wire                         | SH-2107 |              |
| Stand Base Assembly                               |         | E-5089*      |
| Stacking Hardware (CENTER SUPPORT, BETWEEN UNITS) |         | E-5091       |
| Transport Door Latches (FACTORY INSTALLATION)     | LT-2035 |              |

\*stand base assembly must be ordered when ordering casters or legs

Cabinets can be stacked in multiples. There are four (4) 3/16" (5mm) rounded projections on the top and bottom of each cabinet to permit stacking. A center support stacking hardware kit (E-5091) must be used to stack the deluxe cabinets.

**500-E stacked height: 38-1/8" (968mm)**

**500-E/ Deluxe stacked height: 40-1/16" (1018mm)**

# INSTALLATION

## Electrical Installation

1. An identification tag is permanently mounted on the cabinet.

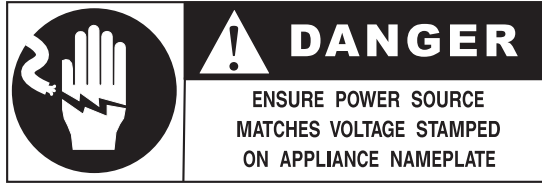





### 230V:

To prevent an electrical shock hazard between the appliance and other appliances or metal parts in close vicinity, an equalization-bonding stud is provided. An equalization bonding lead must be connected to this stud and the other appliances / metal parts to provide sufficient protection against potential difference. The terminal is marked with the following symbol. 

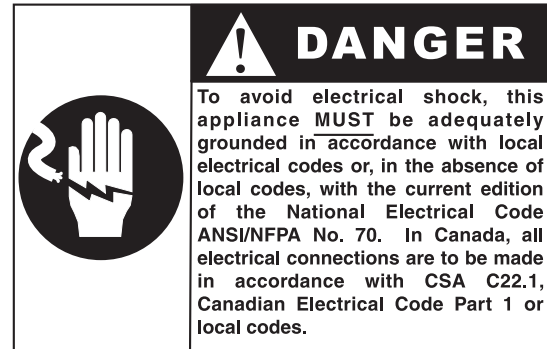
**NOTE:** The appliance must be connected to an electrical circuit that is protected by an external GFCI outlet.

2. Plug the unit into a properly grounded receptacle ONLY. Arcing will occur when connecting or disconnecting the unit unless all controls are in the "OFF" position.
3. Position the unit so the cord is easily accessible in case of any emergencies. If necessary, a proper receptacle or outlet configuration, as required for the unit, must be installed by a licensed electrician in accordance with applicable, local electrical codes.



| ELECTRICAL          |         |       |          |      |      |   |
|---------------------|---------|-------|----------|------|------|---|
|                     | VOLTAGE | PHASE | CYCLE/HZ | AMPS | kW   |   |
|                     | 125     | 1     | 50/60    | 4.0  | .50  |  NEMA 5-15P, 15A-125V PLUG |
|                     | 208-240 | 1     | 50/60    | 4.4  | 1.10 |  NEMA 6-15P, 15A-250V PLUG |
| <b>500-E</b>        | 230     | 1     | 50/60    | 4.3  | 1.0  |  CEE 7/7, 220-230V PLUG    |
| <b>500-E/Deluxe</b> | 230     | 1     | 50/60    | 3.3  | .75  |   |

# OPERATION

## User Safety Information

This appliance is intended for use in commercial establishments where all operators are familiar with the purpose, limitations, and associated hazards of this appliance. Operating instructions and warnings must be read and understood by all operators and users.

### Make sure the unit is connected to the appropriate power source.

1. Use hand protection when handling hot items.
2. Be certain only hot foods are placed into the cabinet.
3. To avoid personal injury and damage to the unit, treat glass with care.  
Remember — glass can shatter.

### HEATING CHARACTERISTICS

The cabinet is equipped with a special, low heat density, heating cable. Through the Halo Heat concept, the heating cable is mounted against the walls of the warming compartment to provide an evenly applied, thermostat controlled, heat source. The design and operational characteristics of the cabinet eliminate the need for a moisture pan or a heat circulating fan. Through even heat application, the quality of a food product is maintained up to several hours.

### CAPACITY

Up to approximately 87 lbs. (39.45 kg)

#### STANDARD:

|   |   |
|---|---|
| FULL SIZE PANS:<br>— Three (3) 12" x 20" x 4"   | GASTRONORM:<br>(1/1: 530 x 325 x 100mm) |
| ONE-HALF SIZE PANS:<br>— Six (6) 12" x 10" x 4" | (1/2: 265 x 325 x 100mm)                |

#### OPTION:

|   |  |
|---|--|
| FULL SIZE PANS:<br>— Four (4) 12" x 20" x 2-1/2"      | GASTRONORM:<br>(1/1: 530 x 325 x 65mm) |
| ONE-HALF SIZE PANS:<br>— Eight (8) 12" x 10" x 2-1/2" | (1/2: 265 x 325 x 65mm)                |

For the option to accommodate 2-1/2" (65mm) deep pans, one set of (2) #11002 Pan Slide Supports are required.

Remove the two (2) #1220 Pan Slides Supports from the center pan position inside the cabinet, and replace with the two (2) #11002 Pan Slide Supports using the same Pan Slide Mounting Screws (SC-2268).

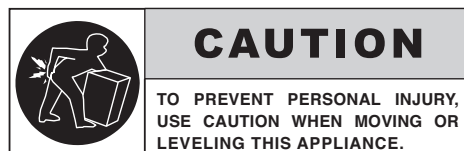
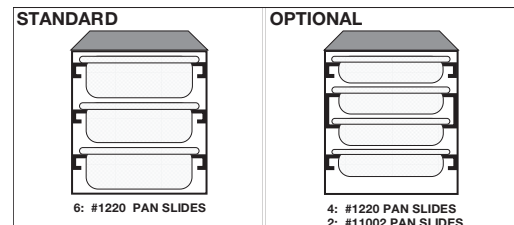

# OPERATION

## Manual Control

### Before Initial Use:

Clean appliance with a clean, damp cloth and mild soap solution. Clean and install the pans, shelves and side racks.

#### 1. Turn thermostat to 200°F (93°C) and preheat for 30 minutes.

When the thermostat is turned clockwise to an "ON" position, the indicator light will illuminate and will remain lit as long as the unit is calling for heat. Close the ventilation openings inside the door to accelerate heating.

The indicator light will go OUT when the air temperature inside the unit reaches the temperature set by the operator. It will then cycle "ON/OFF" at this holding point. Verify the full preheated temperature with the holding temperature gauge located on the control panel of the cabinet.

#### 2. Load the cabinet with hot food only.

The purpose of the holding cabinet is to maintain hot food at proper serving temperature. Before loading the cabinet with food, use a food thermometer to make certain all products are at an internal temperature range of 140° to 160°F (60° to 71°C). Any food product not within the proper temperature range should be heated before loading into the holding cabinet.

Some foods (ribs, fish, potatoes, etc.) will create humidity inside the warmer. Allow the surface of these foods to stabilize for a short period of time before placing the warm food inside the unit. Do not add water to the unit.

#### 3. Reset the thermostat to 160°F (71°C). For potatoes - 180°F (82°C).

Check to make certain the cabinet door is securely closed, and reset the thermostat to 160°F (71°C). THIS WILL NOT NECESSARILY BE THE FINAL SETTING. The proper temperature range for the products being held will depend on the type and quantity of product. When holding food for prolonged periods, it is advisable to periodically check the internal temperature of each item with a food thermometer to assure maintenance of the proper temperature range of 140° to 160°F (60° to 71°C).

Verify that the fan in the back of the unit is operating and turning without any visual restrictions.

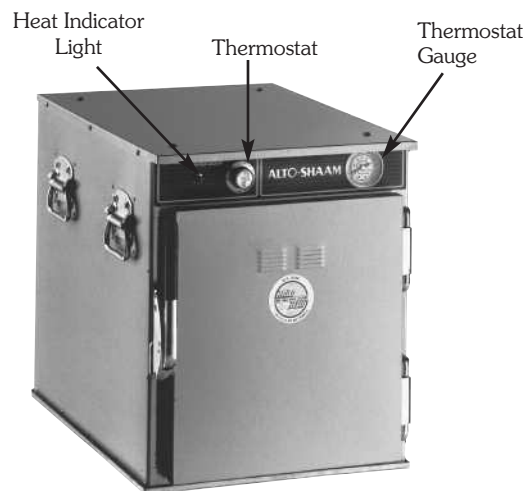



# OPERATION

## Electronic Control



### **ON/OFF Key**

 Press the ON/OFF key once and the power indicator light will illuminate. Press and hold the ON/OFF key until the LED display turns off (at least three seconds) and power indicator light goes out.

### **UP/DOWN Arrow Key**

 The UP and DOWN arrow keys are used for a variety of settings when selecting the holding temperature. If an arrow key is pressed and released, the display will show the current set temperature for two seconds. If an arrow key is held (at least eight seconds), the value will change at a rapid rate. If the arrow key is pressed and released in rapid succession, the set temperature will change by increments of one degree.

### **ENABLE/DISABLE BEEPER**

 A beeper sounds when an error code is displayed. To choose between beeper on and beeper off mode, the control must be off, then press and hold the DOWN arrow key until either "ON" or "OFF" is shown in the LED display. Release arrow key when desired mode is displayed.

### **FAHRENHEIT/CELSIUS**

 With the control off, to choose between Fahrenheit and Celsius, press and hold the UP arrow key until either °F or °C is shown in LED display. Release key when desired setting is displayed.

The control has a four-digit LED display. When the display is on, it will show current holding temperature, as well as diagnostic information.

### **CONTROL LOCK**

The warmer controls can be locked so that no changes can be made to the set temperature.

To lock the display, press and hold the ON/OFF key and the Up Arrow key at the same time. The lock LED will illuminate. When the lock LED is illuminated, additional programming will not be functional other than the key sequence required to unlock the panel.

To unlock the display, press and hold the ON/OFF key and the Down Arrow key at the same time. The lock LED will extinguish. The panel keys will resume normal function.

### **Before Initial Use:**

Clean appliance with a clean, damp cloth and mild soap solution. Glass cleaner or distilled vinegar can be used on any glass. Clean and install the pans, shelves and side racks.

### **1. Preheat at 200°F (93°C) for 30 minutes.**

Press the ON key, and set the temperature to 200°F (93°) by using the UP/DOWN arrow keys. Allow a minimum of 30 minutes preheating time before loading the holding cabinet with food. Closing the vents on the inside of the door will speed the preheating process. The LED heat indicator light will go "Out" after approximately 30 minutes preheat time, or when the air temperature inside the unit reaches the temperature set by the operator. The Set indicator will light up anytime the temperature is set or reset.

### **2. Load with hot food only.**

The purpose of the holding cabinet is to maintain hot food at proper serving temperature. Only hot food should be placed into the cabinet. Before loading the cabinet with food, use a food thermometer to make certain all products are at an internal temperature range of 140° to 160°F (60° to 71°C). Any food product not within the proper temperature range should be heated before loading into the holding cabinet.

### **3. Reset the control to 160°F (71°C).**

Check to make certain the cabinet door is securely closed, and reset to 160°F (71°C) by using the UP/DOWN keys. THIS WILL NOT NECESSARILY BE THE FINAL SETTING. The proper temperature range--or closing or opening the door vents--will depend on the type and quantity of product. When holding food for prolonged periods, it is advisable to periodically check the internal temperature of each item with a food thermometer to assure maintenance of the proper temperature range of 140° to 160°F (60° to 71°C).

# OPERATION

## General Holding Guidelines

Chefs, cooks and other specialized food service personnel employ varied methods of cooking. Proper holding temperatures for a specific food product must be based on the moisture content of the product, product density, volume, and proper serving temperatures. Safe holding temperatures must also be correlated with palatability in determining the length of holding time for a specific product.

Halo Heat maintains the maximum amount of product moisture content without the addition of water, water vapor, or steam. Maintaining maximum natural product moisture preserves the natural flavor of the product and provides a more genuine taste. In addition to product moisture retention, the gentle properties of Halo Heat maintain a consistent temperature throughout the cabinet without the necessity of a heat distribution fan, thereby preventing further moisture loss due to evaporation or dehydration.

When product is removed from a high temperature cooking environment for immediate transfer into equipment with the lower temperature required for hot food holding, condensation can form on the outside of the product and on the inside of plastic containers used in self-service applications. Allowing the product to release the initial steam and heat produced by high temperature cooking can alleviate this condition. To preserve the safety and quality of freshly cooked foods however, a maximum of 1 to 2 minutes must be the only time period allowed for the initial heat to be released from the product.

This unit is equipped with a thermostat control between 60° and 200°F (16° and 93°C). If the unit is equipped with vents, close the vents for moist holding and open the vents for crisp holding. Use a metal-stemmed thermometer to measure the internal temperature of the product being held. Adjust the thermostat setting to achieve the best overall setting based on internal product temperature.

| HOLDING TEMPERATURE RANGE                                      |              |            |
|--|--------------|------------|
|  | FAHRENHEIT   | CELSIUS    |
| <b>MEAT</b>  |              |            |
| BEEF ROAST — Rare  | 140°F        | 60°C       |
| BEEF ROAST — Med/Well Done                                     | 160°F        | 71°C       |
| BEEF BRISKET   | 160° — 175°F | 71° — 79°C |
| CORN BEEF  | 160° — 175°F | 71° — 79°C |
| PASTRAMI   | 160° — 175°F | 71° — 79°C |
| PRIME RIB — Rare   | 140°F        | 60°C       |
| STEAKS — Broiled/Fried   | 140° — 160°F | 60° — 71°C |
| RIBS — Beef or Pork  | 160°F        | 71°C       |
| VEAL   | 160° — 175°F | 71° — 79°C |
| HAM  | 160° — 175°F | 71° — 79°C |
| PORK   | 160° — 175°F | 71° — 79°C |
| LAMB   | 160° — 175°F | 71° — 79°C |
| <b>POULTRY</b>   |              |            |
| CHICKEN — Fried/Baked  | 160° — 175°F | 71° — 79°C |
| DUCK   | 160° — 175°F | 71° — 79°C |
| TURKEY   | 160° — 175°F | 71° — 79°C |
| GENERAL  | 160° — 175°F | 71° — 79°C |
| <b>FISH/ SEAFOOD</b>   |              |            |
| FISH — Baked/Fried   | 160° — 175°F | 71° — 79°C |
| LOBSTER  | 160° — 175°F | 71° — 79°C |
| SHRIMP — Fried   | 160° — 175°F | 71° — 79°C |
| <b>BAKED GOODS</b>   |              |            |
| BREADS/ROLLS   | 120° — 140°F | 49° — 60°C |
| <b>MISCELLANEOUS</b>   |              |            |
| CASSEROLES   | 160° — 175°F | 71° — 79°C |
| DOUGH — Proofing   | 80° — 100°F  | 27° — 38°C |
| EGGS — Fried   | 150° — 160°F | 66° — 71°C |
| FROZEN ENTREES   | 160° — 175°F | 71° — 79°C |
| HORS D'OEUVRES   | 160° — 180°F | 71° — 82°C |
| PASTA  | 160° — 180°F | 71° — 82°C |
| PIZZA  | 160° — 180°F | 71° — 82°C |
| POTATOES   | 180°F        | 82°C       |
| PLATED MEALS   | 180°F        | 82°C       |
| SAUCES   | 140° — 200°F | 60° — 93°C |
| SOUP   | 140° — 200°F | 60° — 93°C |
| VEGETABLES   | 160° — 175°F | 71° — 79°C |
| The holding temperatures listed are suggested guidelines only. |              |            |

## CLEANING AND PREVENTIVE MAINTENANCE

### PROTECTING STAINLESS STEEL SURFACES



It is important to guard against corrosion in the care of stainless steel surfaces. Harsh, corrosive, or inappropriate chemicals can completely destroy the protective surface layer of stainless steel. Abrasive pads, steel wool, or metal implements will abrade surfaces causing damage to this protective coating and will eventually result in areas of corrosion. Even water, particularly hard water that contains high to moderate concentrations of chloride, will cause oxidation and pitting that result in rust and corrosion. In addition, many acidic foods spilled and left to remain on metal surfaces are contributing factors that will corrode surfaces.

Proper cleaning agents, materials, and methods are vital to maintaining the appearance and life of this appliance. Spilled foods should be removed and the area wiped as soon as possible but at the very least, a minimum of once a day. Always thoroughly rinse surfaces after using a cleaning agent and wipe standing water as quickly as possible after rinsing.

### CLEANING AGENTS

Use non-abrasive cleaning products designed for use on stainless steel surfaces. Cleaning agents must be chloride-free compounds and must not contain quaternary salts. Never use hydrochloric acid (muriatic acid) on stainless steel surfaces. Always use the proper cleaning agent at the manufacturer's recommended strength. Contact your local cleaning supplier for product recommendations.

### CLEANING MATERIALS

The cleaning function can usually be accomplished with the proper cleaning agent and a soft, clean cloth. When more aggressive methods must be employed, use a non-abrasive scouring pad on difficult areas and make certain to scrub with the visible grain of surface metal to avoid surface scratches. Never use wire brushes, metal scouring pads, or scrapers to remove food residue.

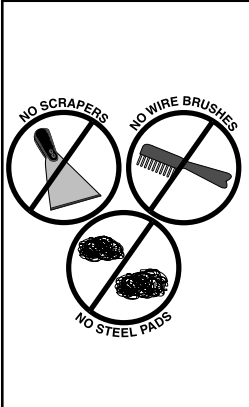
|   |  |
|---|--|
|  | <p><b>CAUTION</b></p> <p><b>TO PROTECT STAINLESS STEEL SURFACES, COMPLETELY AVOID THE USE OF ABRASIVE CLEANING COMPOUNDS, CHLORIDE BASED CLEANERS, OR CLEANERS CONTAINING QUATERNARY SALTS. NEVER USE HYDROCHLORIC ACID (MURIATIC ACID) ON STAINLESS STEEL. NEVER USE WIRE BRUSHES, METAL SCOURING PADS OR SCRAPERS.</b></p> |
|---|--|

## CARE AND CLEANING

The cleanliness and appearance of this unit will contribute considerably to operating efficiency and savory, appetizing food. Good equipment that is kept clean works better and lasts longer.



### CLEAN THE UNIT THOROUGHLY AFTER EACH USE

1. Disconnect unit from power source, and let cool.
2. Remove, cover or wrap, and store unused products under refrigeration.
3. Remove all detachable items such as wire shelves, side racks, and any drip pan. Clean these items separately.
4. Clean interior with a damp cloth or sponge and any good commercial detergent at the recommended strength.
5. Spray heavily soiled areas with a water soluble degreaser and let stand for 10 minutes, then remove soil with a plastic scouring pad.



**NOTE:** Avoid the use of abrasive cleaning compounds, chloride based cleaners, or cleaners containing quaternary salts. **Never** use hydrochloric acid (muriatic acid) on stainless steel.

6. Clean control panel, door vents, door handles, and door gaskets thoroughly since these areas harbor food debris.
7. Rinse surfaces by wiping with sponge and clean warm water.
8. Remove excess water with sponge and wipe dry with a clean cloth or air dry. Leave door open until interior is completely dry. Replace shelves.
9. Interior can be wiped with a sanitizing solution after cleaning and rinsing. This solution must be approved for use on stainless steel food contact surfaces.
10. To help maintain the protective film coating on polished stainless steel, clean the exterior of the cabinet with a cleaner recommended for stainless steel surfaces. Spray the cleaning agent on a clean cloth and wipe with the grain of the stainless steel.
11. Clean glass with a window cleaner.

Always follow appropriate state or local health (hygiene) regulations regarding all applicable cleaning and sanitation requirements for foodservice equipment.



# SANITATION

Food flavor and aroma are usually so closely related that it is difficult, if not impossible, to separate them. There is also an important, inseparable relationship between cleanliness and food flavor. Cleanliness, top operating efficiency, and appearance of equipment contribute considerably to savory, appetizing foods. Good equipment that is kept clean, works better and lasts longer.

Most food imparts its own particular aroma and many foods also absorb existing odors. Unfortunately, during this absorption, there is no distinction between GOOD and BAD odors. The majority of objectionable flavors and odors troubling food service operations are caused by bacteria growth. Sourness, rancidity, mustiness, stale or other OFF flavors are usually the result of germ activity.

The easiest way to insure full, natural food flavor is through comprehensive cleanliness. This means good control of both visible soil (dirt) and invisible soil (germs). A thorough approach to sanitation will provide essential cleanliness. It will assure an attractive appearance of equipment, along with maximum efficiency and utility. More importantly, a good sanitation program provides one of the key elements in the prevention of food-borne illnesses.

A controlled holding environment for prepared foods is just one of the important factors involved in the prevention of food-borne illnesses. Temperature monitoring and control during receiving, storage, preparation, and the service of foods are of equal importance.

The most accurate method of measuring safe temperatures of both hot and cold foods is by internal product temperature. A quality thermometer is an effective tool for this purpose, and should be routinely used on all products that require holding at a specific temperature.

A comprehensive sanitation program should focus on the training of staff in basic sanitation procedures. This includes personal hygiene, proper handling of raw foods, cooking to a safe internal product temperature, and the routine monitoring of internal temperatures from receiving through service.

Most food-borne illnesses can be prevented through proper temperature control and a comprehensive program of sanitation. Both these factors are important to build quality service as the foundation of customer satisfaction. Safe food handling practices to prevent food-borne illness is of critical importance to the health and safety of your customers. HACCP, an acronym for Hazard Analysis (at) Critical Control Points, is a quality control program of operating procedures to assure food integrity, quality, and safety. Taking steps necessary to augment food safety practices are both cost effective and relatively simple. While HACCP guidelines go far beyond the scope of this manual, additional information is available by contacting:

**Center for Food Safety and Applied Nutrition  
Food and Drug Administration  
1-888-SAFEFOOD**

| INTERNAL FOOD PRODUCT TEMPERATURES |               |                  |
|------------------------------------|---------------|------------------|
| <b>HOT FOODS</b>                   |               |                  |
| DANGER ZONE                        | 40° TO 140°F  | (4° TO 60°C)     |
| CRITICAL ZONE                      | 70° TO 120°F  | (21° TO 49°C)    |
| SAFE ZONE                          | 140° TO 165°F | (60° TO 74°C)    |
| <b>COLD FOODS</b>                  |               |                  |
| DANGER ZONE                        | ABOVE 40°F    | (ABOVE 4°C)      |
| SAFE ZONE                          | 36°F TO 40°F  | (2°C TO 4°C)     |
| <b>FROZEN FOODS</b>                |               |                  |
| DANGER ZONE                        | ABOVE 32°F    | (ABOVE 0°C)      |
| CRITICAL ZONE                      | 0° TO 32°F    | (-18° TO 0°C)    |
| SAFE ZONE                          | 0°F OR BELOW  | (-18°C OR BELOW) |

## SERVICE • MANUAL CONTROL

### THERMOSTAT & INDICATOR LIGHT SEQUENCE

Whenever the thermostat is turned "ON," the indicator light will indicate the power ON/OFF condition of the heating cable, and consequently, the cycling of the cabinet as it maintains the dialed cavity temperature. If this light does not illuminate after normal start-up, the main power source, thermostat, and/or indicator light must be checked.

If the warming cabinet does not hold the temperature as dialed, the calibration of the thermostat must be checked. If the warming cabinet fails to heat or heats continuously with the thermostat "OFF," the thermostat must be initially checked for proper operation. If these items are checked and found to be in order, a continuity and resistance check of the heating cable should be made. SEE CIRCUIT DIAGRAM.

### THERMOSTAT CALIBRATION

The thermostat is precision calibrated at the factory. Normally, no adjustment or recalibration is necessary unless the thermostat has been mishandled in transit, changed or abused while in service. A thermostat with a sensing bulb operates on hydraulic pressure, consequently, any bending of the bulb results in a change in its volume, and alters the accuracy of the thermostat calibration.

A thermostat should be checked or recalibrated by placing a quality, thermal indicator at the center of an empty holding cavity. **DO NOT CALIBRATE WITH ANY FOOD PRODUCT IN THE CABINET.** The thermostat should be set, and should be allowed to stabilize at that setting for a minimum of one hour. The center of the thermal swing of the air temperature within the cabinet should approximately coincide with the thermostat setting.

If calibration is necessary, the calibration screw should be adjusted with great care. The calibration screw of the thermostat is located in the thermostat dial shaft. With the shaft held stationary, a minute, clockwise motion of the calibration screw appreciably lowers the thermostat setting. A reverse, or counter-clockwise motion appreciably raises the thermostat setting. After achieving the desired cycling of the thermostat, the calibration screw must be sealed. Place a few drops of enamel sealant directly on the calibration screw.

*(Red nail polish or equivalent is acceptable.)*



# SERVICE • ELECTRONIC CONTROL

## TROUBLE SHOOTING

| Error Code | Description/Results  | Possible Cause<br>Service Required  |
|------------|--|---|
| E-10       | Air Sensor Fault (shorted)<br><i>Inoperative unit</i>      | Air sensor defective? See following page for air sensor test.   |
| E-11       | Air Sensor Fault (open)<br><i>Inoperative unit</i>         |   |
| E-30       | Under temperature<br><i>Unit will shut down</i>            | Door closed? Door gasket need replacement? Preheat skipped? Unit overloaded or has frozen product? Defective air sensor or probe? Defective solid state relay? Bad wire connections or open heating cable?  |
| E-31       | Over temperature<br><i>Unit will shut down</i>             | Shorted cable? Defective solid state relay? Defective air sensor? If none of the above, call service.   |
| E-60       | Real time clock error<br><i>Inoperative unit</i>           | Appliance has probably been unplugged for more than 30 days. If this is the case, it should be plugged in with the circuit breaker ON, and the appliance displaying the E-60 on the front panel for more than 30 minutes. Once this has been accomplished, the circuit breaker should be turned OFF, or the appliance unplugged for approximately 10 seconds after which the appliance should be turned ON again. |
| E-70       | Configuration connector error<br><i>Inoperative unit</i>   | Check control connections for loose wires. If none, control must be replaced.   |
| E-78       | Voltage low<br><i>Inoperative unit</i>                     | If 125 VAC unit, voltage is below 90 VAC. Correct.<br>If 208-240 VAC voltage is below 190 VAC. Correct.   |
| E-79       | Voltage high<br><i>Inoperative unit</i>                    | If 125 VAC unit, voltage is over 130 VAC. Correct.<br>If 208-240 VAC, voltage is over 250 VAC. Correct.   |
| E-80       | EEPROM - Function data error<br><i>Inoperative unit</i>    | Contact Alto-Shaam service.   |
| E-82       | EEPROM - Calibration data error<br><i>Inoperative unit</i> | Contact Alto-Shaam service.   |
| E-84       | EEPROM - Unit ID error<br><i>Inoperative unit</i>          | Contact Alto-Shaam service.   |
| E-86       | EEPROM - Preset data error<br><i>Inoperative unit</i>      | Contact Alto-Shaam service.   |

### CAUTION

THIS SECTION IS PROVIDED FOR THE ASSISTANCE OF QUALIFIED SERVICE TECHNICIANS ONLY AND IS NOT INTENDED FOR USE BY UNTRAINED OR UNAUTHORIZED SERVICE PERSONNEL.



### DANGER

DISCONNECT UNIT FROM POWER SOURCE BEFORE CLEANING OR SERVICING.

## TROUBLE SHOOTING INTERNAL ELECTRICAL COMPONENTS

### A. No power. Display will not light.

1. Verify that power is available at the outlet or junction box.
2. Verify that the circuit breaker switch on the back of the unit is turned on.
3. Verify that the power cord is not open. Check continuity with a VOM meter.
4. If none of the above steps help, call a qualified service technician or refer to the Service Manual for this particular oven.

### B. To test air sensor:

Test air sensor by placing sensor in ice water bath and using an ohmmeter set on the ohm scale. The reading should be 100 ohms resistance. If it is more than 2 ohms higher or lower, sensor needs to be replaced.



*This section is provided for the assistance of qualified technicians only and is not intended for use by untrained or unauthorized service personnel. If your Alto-Shaam® unit is not operating properly, check the following before calling your Authorized Alto-Shaam® Service Agent:*

- Check the power flow to the unit. Plug in outlet? Circuit breaker switch at back of unit turned on? **Do not attempt to repair or service the unit beyond this point. Contact Alto-Shaam® for the nearest authorized service agent. Repairs made by any other service agents without prior authorization by Alto-Shaam® will void the warranty on the unit.**



# MANUAL CONTROL • SERVICE

## MODEL 500-E • Manual Control

3/18/04

| PART DESCRIPTION                         | QTY. ALTO-SHAAM |           | PART DESCRIPTION                        | QTY. ALTO-SHAAM |          |
|--|-----------------|-----------|---|-----------------|----------|
|  | PER UNIT        | PART NO.  |   | PER UNIT        | PART NO. |
| 1. TOP                                   | 1               | 4986      | 12. THERMOSTAT                          | 1               | TT-3057  |
| 2. TOP MOUNTING SCREWS                   | 9               | SC-2425   | THERMOSTAT KNOB (Fahrenheit)            | 1               | KN-3469  |
| 3. CORD AND PLUG SET (125V)              | 1               | CD-3029   | THERMOSTAT KNOB (Celsius)               | 1               | KN-3474  |
| CORSET: 230V, INTL (TYPE HO7 RN-F)       | 1               | CD-3984   | 13. HEAT INDICATOR LIGHT (125V)         | 1               | LI-3027  |
| CORSET: 208-240V                         | 1               | CD-3858   | HEAT INDICATOR (230V and 208-240V)      | 1               | LI-3951  |
| 4. INLET (125V)                          | 1               | IT-3001   | 14. INTERIOR AMBIENT TEMP. GAUGE        | 1               | GU-3273  |
| INLET (208-240V)                         | 1               | IT-3857   | 15. CONTROL PANEL OVERLAY               | 1               | PE-2882  |
| INLET (230V)                             | 1               | IT-33173  | 16. DOOR ASSEMBLY, RIGHT-HAND           | 1               | 15016    |
| 5. CASING, BOTTOM                        | 1               | 1360/1355 | DOOR ASSEMBLY, LEFT-HAND                | 1               | 5125     |
| 6. CASING, BOTTOM, MOUNTING RIVETS       | 10              | RI-2100   | 17. HINGE SET (1 pair of 2 hinges)      | 1               | HG-2015  |
| 7. FAN, 125V                             | 1               | FA-3485   | HINGE MOUNTING SCREWS (not shown)       | 12              | SC-2072  |
| FAN, 208-240V, 230V                      | 1               | FA-3342   | 18. DOOR HANDLE                         | 1               | HD-2007  |
| FAN BLADE                                | 1               | FA-33073  | DOOR HANDLE MOUNTING SCREWS             | 3               | SC-2073  |
| 8. INSULATION:                           |                 |           | DOOR STRIKER MOUNTING SCREWS            | 3               | SC-2071  |
| 25" x 54" (635mm x 1372mm)               | 1               | IN-22364  | 19. DOOR GASKET (length): 5.1' (1555mm) | 1               | GS-2398  |
| 25" x 54" (635mm x 1372mm) 125V          | 1               | IN-2381   | 20. PAN SLIDES                          | 6               | 1220     |
| 9. CABLE CONNECTION HARDWARE (not shown) |                 |           | PAN SLIDE MOUNTING SCREWS               | 12              | SC-2268  |
| 10. HEATING CABLE:                       |                 |           | 21. CARRYING HANDLE, CHROME             | 4               | HD-2532  |
| (125V)—51' (15545mm) length              | 1               | CB-3044   | MOUNTING SCREWS                         | 16              | SC-2070  |
| (208-240V, 230V)—72' (21946mm) length    | 1               | CB-3045   |   |                 |          |
| 11. HI-LIMIT THERMOSTAT (230V)           | 1               | TT-3859   |   |                 |          |

**SERVICE VIEW on following page.**

### HEAT CABLE REPLACEMENT SERVICE KIT

**#4873    #4878    #4879**  
**125 V   208/240V   230V**

| includes: |                       | #4873   | #4878   | #4879    |
|-----------|-----------------------|---------|---------|----------|
| CB-3045   | Cable Heating Element | --      | 85 feet | 112 feet |
| CB-3044   | Cable Heating Element | 52 feet | --      | --       |
| CR-3226   | Ring Connector        | 4       | 4       | 6        |
| IN-3488   | Insulation Corner     | 1 foot  | 1 foot  | 1 foot   |
| BU-3105   | Shoulder Bushing      | 4       | 4       | 6        |
| BU-3106   | Cup Bushing           | 4       | 4       | 6        |
| ST-2439   | Stud                  | 4       | 4       | 6        |
| NU-2215   | Hex Nut               | 8       | 8       | 12       |
| SL-3063   | Insulating Sleeve     | 4       | 4       | 6        |
| TA-3540   | Electrical Tape       | 1 roll  | 1 roll  | 1 roll   |

500-E

SERVICE VIEW 3/32"=1"

03/08/94

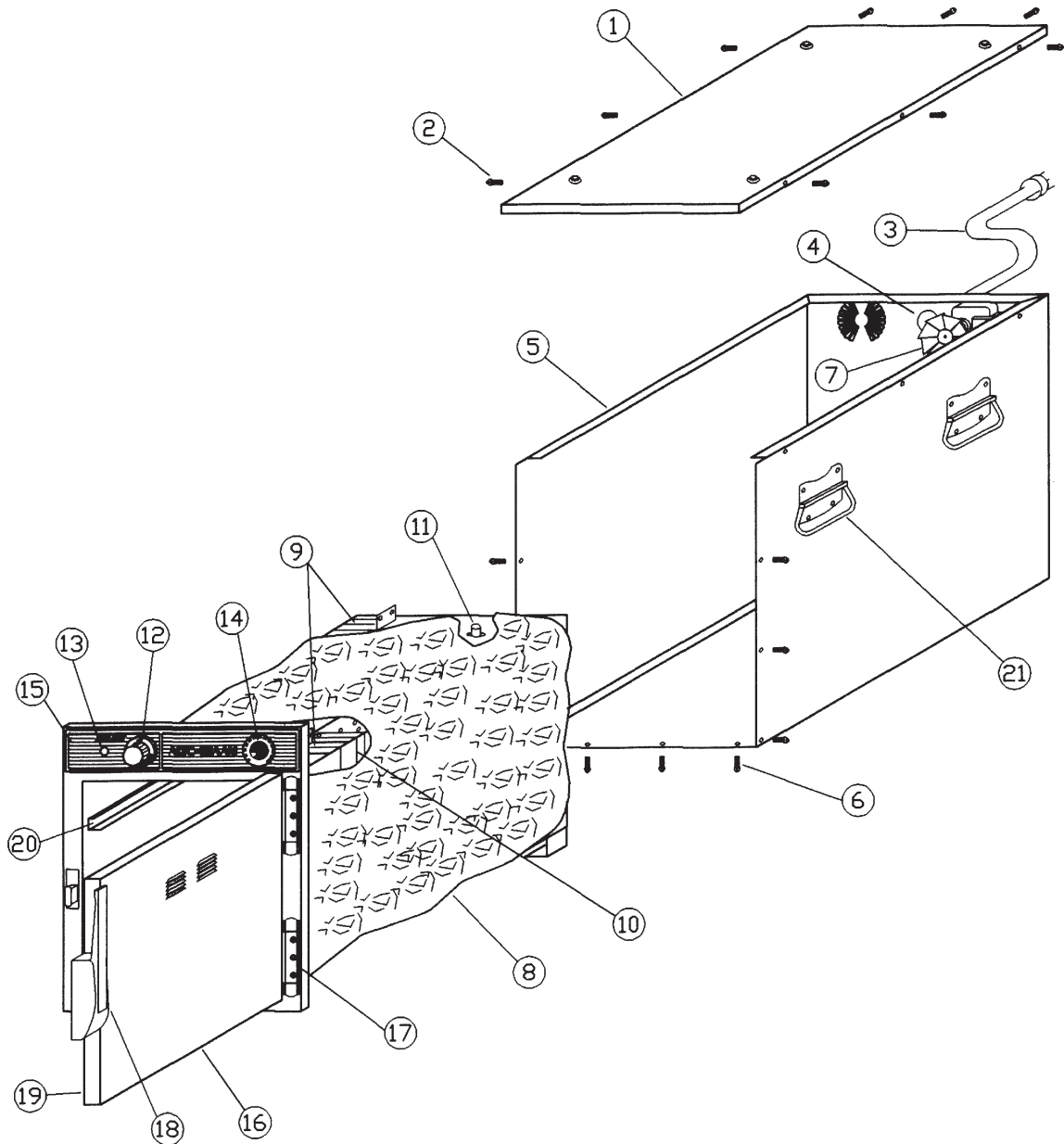

# Deluxe Model • Electronic Control • Service Views

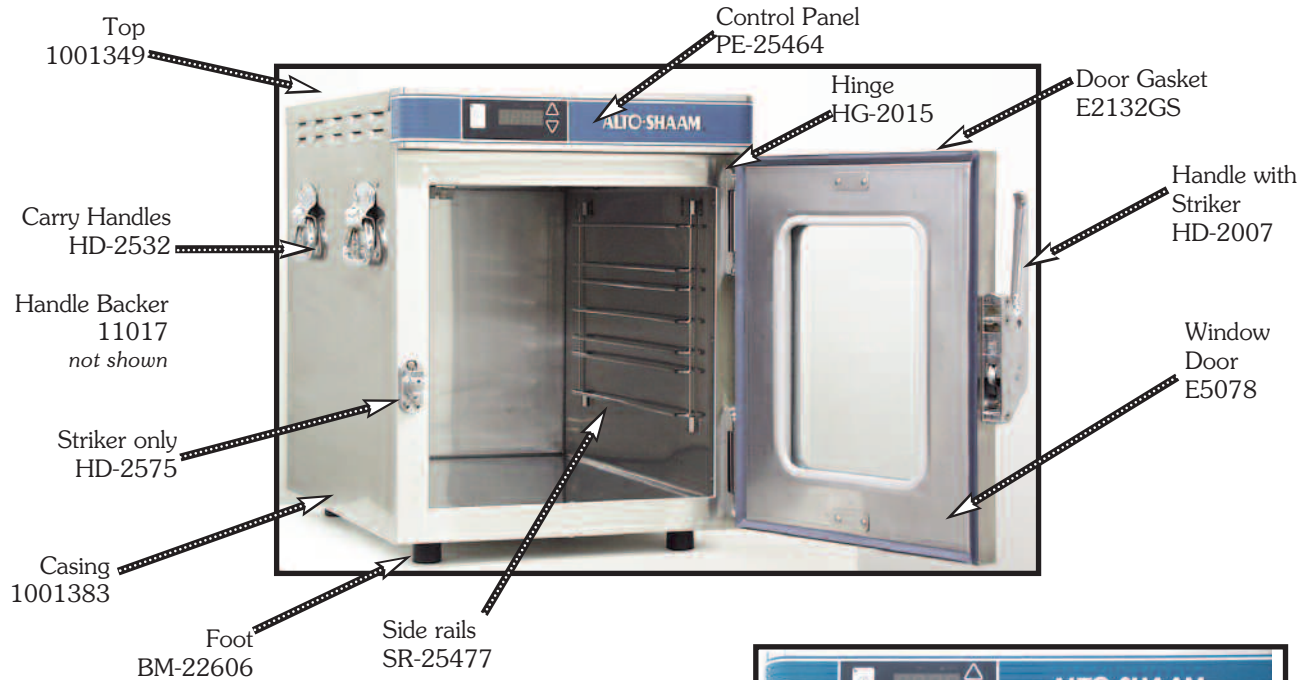

## Cabinet Front

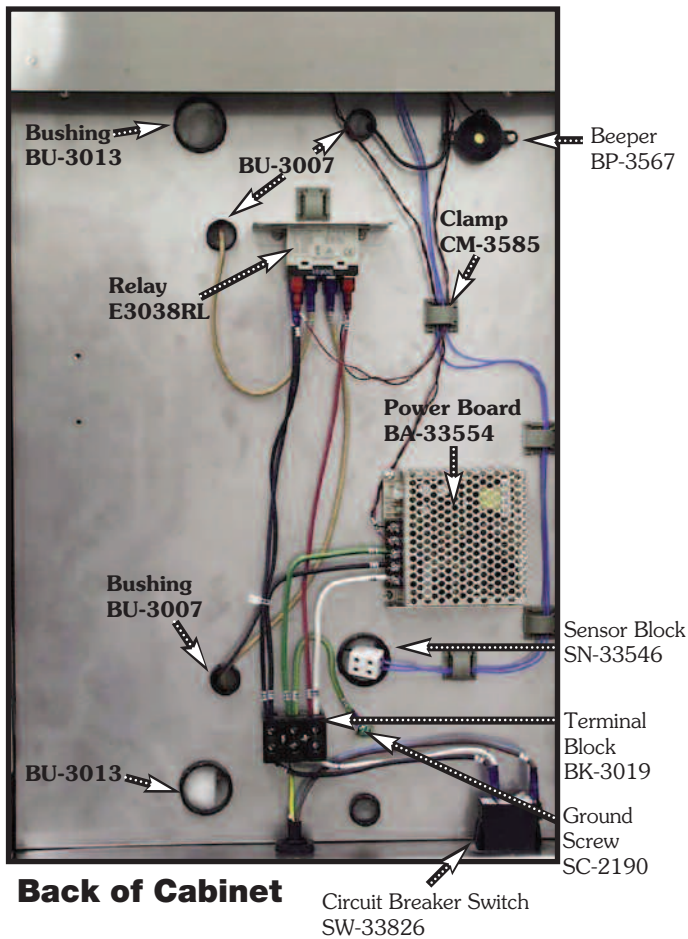

## Back of Cabinet

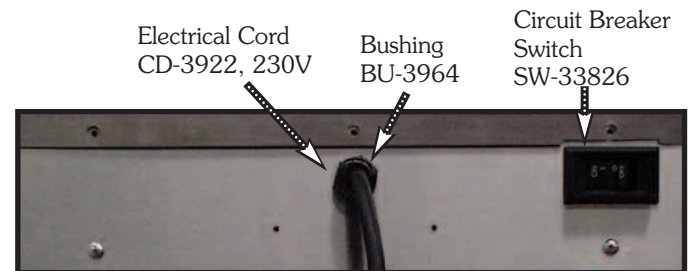
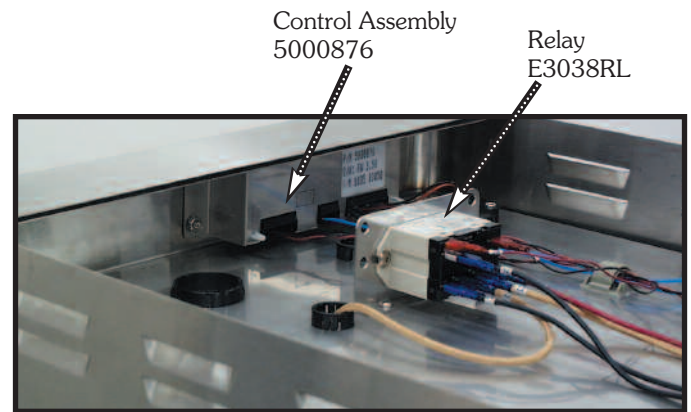

## Top Rear View

125V-60HZ  
500W-4.0A

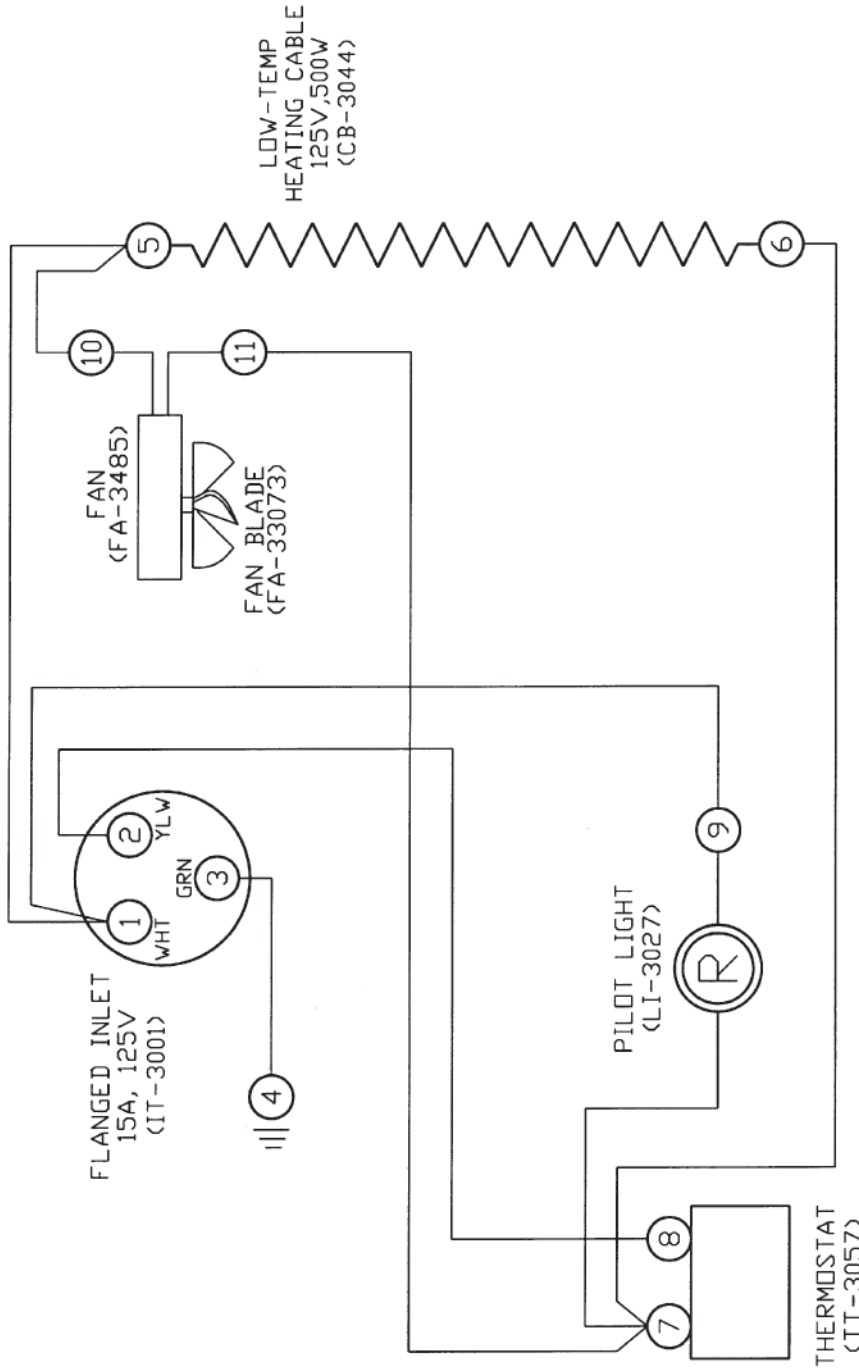

| REVISIONS |          | 500-E |  | (125V) |  |
|-----------|----------|-------|--|--------|--|
| NO.       | DATE     | BY    |  |        |  |
| 1         | 03-08-94 | RS    |  |        |  |
| 2         |          |       |  |        |  |
| 3         |          |       |  |        |  |
| 4         |          |       |  |        |  |
| 5         |          |       |  |        |  |

WIRING DIAGRAM

ALTO-SHAAM INC.  
MENDOTA FALLS, WISCONSIN

DRAWN BY ALD SCALE 1"=1' DWG. NO. A-7055  
APP'D DAR DATE 3-17-77

NOTE #1: ALL NUMBERS IN ( ) =  
ALTO-SHAAM PART NUMBERS

NOTE #2: SEE DRW. #B-8084 FOR  
WIRE ASSEMBLIES



NOTE #1: ALL NUMBERS IN ( > ) =  
ALTO-SHAAM PART NUMBERS

NOTE #2: SEE DRW. #B-8214 FOR  
WIRE ASSEMBLIES

230V, 5A, 1150W  
50/60Hz

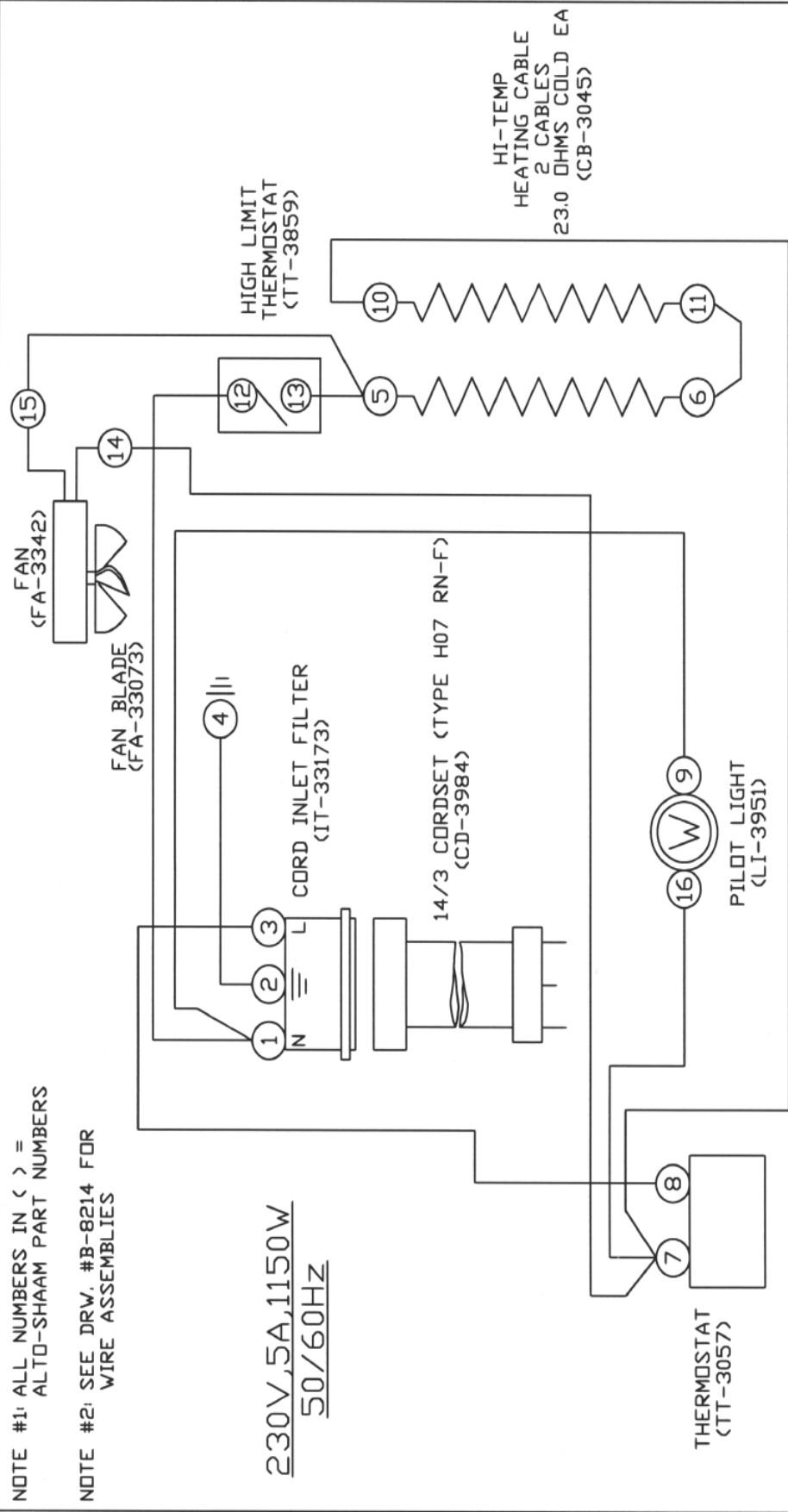

HI-TEMP  
HEATING CABLE  
2 CABLES  
23.0 OHMS COLD EA  
(CB-3045)

HIGH LIMIT  
THERMOSTAT  
(TT-3859)

STANDARD TOLERANCE (±.015") UNLESS OTHERWISE SPECIFIED

# WIRING DIAGRAM

|                                  |              |
|----------------------------------|--------------|
| MODELS: 500-E (INT. UNIT)        | 230V         |
| <b>ALTO-SHAAM.</b>               |              |
| MENOMONEE FALLS, WISC. 53052-450 |              |
| SCALE: 1" = 1'                   | DWG: 7140    |
| BY: ALD                          | DATE: 1-9-79 |

| NO. | REVISION | BY  |
|-----|----------|-----|
| 1   | 4/4/79   | DAR |
| 2   | 8/27/86  | ALD |
| 3   | 12/3/91  | ALD |
| 4   | 9/13/91  | LRW |
| 5   | 1/4/94   | LRP |
| 6   | 3/8/9    | RS  |
| 7   | 5/23/9   | RS  |
| 8   | 8/14/02  | CB  |
| 9   | 10/29/03 | DDF |

DAR



## TRANSPORTATION DAMAGE and CLAIMS



All Alto-Shaam equipment is sold F.O.B. shipping point, and when accepted by the carrier, such shipments become the property of the consignee.

Should damage occur in shipment, it is a matter between the carrier and the consignee. In such cases, the carrier is assumed to be responsible for the safe delivery of the merchandise, unless negligence can be established on the part of the shipper.

1. Make an immediate inspection while the equipment is still in the truck or immediately after it is moved to the receiving area. Do not wait until after the material is moved to a storage area.
2. Do not sign a delivery receipt or a freight bill until you have made a proper count and inspection of all merchandise received.
3. Note all damage to packages directly on the carrier's delivery receipt.
4. Make certain the driver signs this receipt. If he refuses to sign, make a notation of this refusal on the receipt.
5. If the driver refuses to allow inspection, write the following on the delivery receipt:  
*Driver refuses to allow inspection of containers for visible damage.*
6. Telephone the carrier's office immediately upon finding damage, and request an inspection. Mail a written confirmation of the time, date, and the person called.
7. Save any packages and packing material for further inspection by the carrier.
8. Promptly file a written claim with the carrier and attach copies of all supporting paperwork.

We will continue our policy of assisting our customers in collecting claims which have been properly filed and actively pursued. We cannot, however, file any damage claims for you, assume the responsibility of any claims, or accept deductions in payment for such claims.

## ALTO SHAAM. LIMITED WARRANTY

Alto-Shaam, Inc. warrants to the original purchaser that any original part that is found to be defective in material or workmanship will, at Alto-Shaam's option, subject to provisions hereinafter stated, be replaced with a new or rebuilt part.

The labor warranty remains in effect one (1) year from installation or fifteen (15) months from the shipping date, whichever occurs first. Alto-Shaam will bear normal labor charges performed during standard business hours, and excluding overtime, holiday rates or any additional fees.

The parts warranty remains in effect for one (1) year from installation or fifteen (15) months from the shipping date, whichever occurs first.

However, the heating element on Halo Heat<sup>®</sup> cook/hold ovens and the refrigeration compressor on Alto-Shaam Quickchillers<sup>™</sup> are warranted for a period of five (5) years from installation. The labor warranty is the same as stated above; namely, for one (1) year from installation or fifteen (15) months from the shipping date, whichever occurs first.

### THIS WARRANTY DOES NOT APPLY TO:

1. Calibration.
2. Replacement of light bulbs and/or the replacement of display case glass due to damage of any kind.
3. Equipment damage caused by accident, shipping, improper installation or alteration.
4. Equipment used under conditions of abuse, misuse, carelessness or abnormal conditions including, but not limited to, equipment subjected to harsh or inappropriate chemicals including, but not limited to, compounds containing chloride or quaternary salts, poor water quality, or equipment with missing or altered serial numbers.
5. Damage incurred as a direct result of poor water quality, inadequate maintenance of steam generators and/or surfaces affected by water quality. Water quality and required maintenance of steam generating equipment is the responsibility of the owner/operator.
6. Damage caused by use of any cleaning agent other than Alto-Shaam's Combitherm<sup>®</sup> Cleaner including, but not limited to, damage due to chlorine or other harmful chemicals. Use of Alto-Shaam's Combitherm<sup>®</sup> Cleaner on Combitherm<sup>®</sup> ovens is highly recommended.
7. Any losses or damage resulting from malfunction, including loss of product or consequential or incidental damages of any kind.
8. Equipment modified in any manner from original model, substitution of parts other than factory authorized parts, removal of any parts including legs, or addition of any parts.

This warranty is exclusive and is in lieu of all other warranties, expressed or implied, including the implied warranties of merchantability and fitness for a particular purpose. In no event shall Alto-Shaam be liable for loss of use, loss of revenue or profit, or loss of product, or for any indirect or consequential damages. No person except an officer of Alto-Shaam, Inc. is authorized to modify this warranty or to incur on behalf of Alto-Shaam any other obligation or liability in connection with Alto-Shaam equipment.

**ALTO-SHAAM, INC.**

RECORD THE MODEL AND SERIAL NUMBER OF THE APPLIANCE FOR EASY REFERENCE.  
ALWAYS REFER TO BOTH MODEL AND SERIAL NUMBER IN ANY CONTACT WITH ALTO-SHAAM REGARDING THIS APPLIANCE.

Model: \_\_\_\_\_ Date Installed: \_\_\_\_\_  
Voltage: \_\_\_\_\_ Purchased From: \_\_\_\_\_  
Serial Number: \_\_\_\_\_

**W164 N9221 Water Street • P.O. Box 450 • Menomonee Falls, Wisconsin 53052-0450 • U.S.A.**  
PHONE: 262.251.3800 • 800.558-8744 USA/CANADA FAX: 262.251.7067 • 800.329.8744 U.S.A. ONLY  
WEBSITE: [www.alto-shaam.com](http://www.alto-shaam.com)

PRINTED IN U.S.A.



## Free Manuals Download Website

<http://myh66.com>

<http://usermanuals.us>

<http://www.somanuals.com>

<http://www.4manuals.cc>

<http://www.manual-lib.com>

<http://www.404manual.com>

<http://www.luxmanual.com>

<http://aubethermostatmanual.com>

Golf course search by state

<http://golfingnear.com>

Email search by domain

<http://emailbydomain.com>

Auto manuals search

<http://auto.somanuals.com>

TV manuals search

<http://tv.somanuals.com>