

AMERICAN AUDIO

M1624FX



User Guide and Reference Manual

AMERICAN AUDIO
6122 S. Eastern Ave
Los Angeles, CA 90040
www.AmericanAudio.us

MAIN FEATURES.....	2
ELECTRICAL PRECAUTIONS.....	3
SAFETY PRECAUTIONS.....	5
INTRODUCTION.....	6
SET-UP PRECAUTIONS.....	6
UNPACKING.....	7
QUICK START.....	7
CONTROLS AND FUNCTIONS	
CHANNEL CONTROL.....	8
MAIN CONTROL.....	11
INPUT & OUTPUT CONNECTIONS.....	14
CONNECTORS.....	16
HOME/STUDIO RECORDING SET-UP.....	18
LIVE PERFORMANCE SET UP.....	19
EFFECTS LIST.....	20
CLEANING.....	22
TROUBLESHOOTING.....	22
WARRANTY.....	23
SPECIFICATIONS.....	24

- 8 Mono & 4 Stereo Channel Inputs
- Stereo Main Outputs & ALT 3/4 Output
- 3-Band EQ, 1 Aux with Pre/Post Switch, 1 EFX, BAL, Mute, & PFL for Stereo Input
- Trim With Peak LED, HPF, 3-Band EQ, 1 Aux With Pre/Post Switch, 1 EFX, Pan, Mute, & PFL Switch for Mono Input
- Trim With Peak LED, HPF (CH 9-12)
- Main L/R With AFL Switch, ALT 3/4 With AFL, To Main Switch, AUX & EFX Send, AUX & EFX Return
- Tape With PFL Switch, HP/Control Room & Phantom Power
- 24-Bit DSP Effect, 100 Presets, EFX On/Off & EFX Level
- Tape With PFL Switch, HP/Control Room & Phantom Power
- 10 XLR Mic/Inputs
- XLR & 1/4" Phone Jack Balanced & 1/4" Phone Jack for Mono Input
- XLR & 1/4" Phone Jack For Stereo (Ch 9-12) & 1/4" Phone & Phono Jack For Stereo Input
- 1/4" Phone Jack For Stereo Return & Phono Jack For Tape In
- 1/4" Phone Jack For Main, ALT 3/4, Aux Send, EFX Send, Control Room & Headphone
- Phono Jack For Tape & 1/4" Phone Jack For Footswitch

WARNING: TO PREVENT FIRE OR ELECTRIC SHOCK HAZARD, DO NOT EXPOSE THIS UNIT TO RAIN, LIQUIDS, OR MOISTURE

CAUTION: TO PREVENT ELECTRIC SHOCK DO NOT USE THIS (POLARIZED) PLUG WITH AN EXTENSION CORD, RECEPTACLE, OR OTHER TYPE OF ELECTRICAL OUTLET UNLESS THE WIDE BLADES CAN BE CAREFULLY INSERTED INTO A MATCHING WIDE SLOT.

ATTENTION: POUR PREVENIR LES CHOCS ELECTRIQUES NE PAS UTILISER CETTE FICHE POLARISEE AVEC UN PROLONGATEUR, UNE PRISE DE COURANT OU UNE AUTRE SORTIE DE COURANT, SAUF SI LES LAMES PEUVENT ETRE INSEREES A FOND SANS EN LAISSER AUCUNE PARTIE A DECOUVERT.



NOTE: This product satisfies FCC regulations when shielded cables and connectors are used to connect the unit to other equipment. To prevent electromagnetic interference with electrical appliances such as radios and televisions, use shielded cables and connectors for connections.

The serial and model number for this unit is located on the rear panel. Please write down the numbers here and retain for future reference.

Model No. _____

Serial No. _____

Purchase Notes:

Date of Purchase _____

Dealer Name _____

Dealer Address _____

Dealer Phone _____

ELECTRICAL PRECAUTIONS



The lightning flash with arrowhead symbol, within an equilateral triangle, is intended to alert the user to the presence of uninsulated "dangerous voltage" within the product's enclosure that may be of sufficient magnitude to constitute a risk of electric shock to persons.

CAUTION
RISK OF ELECTRIC SHOCK
DO NOT OPEN

CAUTION: TO REDUCE THE RISK OF ELECTRIC SHOCK, DO NOT REMOVE THE COVER (OR BACK). THERE ARE NO USER SERVICEABLE PARTS INSIDE. REFER SERVICE TO YOUR AUTHORIZED AMERICAN AUDIO® SERVICE TECHNICIAN.



The exclamation point within an equilateral triangle is intended to alert the user to the presence of important operating and maintenance (servicing) instructions in the literature accompanying the appliance.

IMPORTANT SAFETY INSTRUCTIONS

READ INSTRUCTIONS — All the safety and operating instructions should be read before the product is operated.

RETAIN INSTRUCTIONS — The safety and operating instructions should be retained for future reference.

HEED WARNINGS — All warnings on the product and in the operating instructions should be adhered to.

FOLLOW INSTRUCTIONS — All operating and use instructions should be followed.

CLEANING — The product should be cleaned only with a polishing cloth or a soft dry cloth. Never clean with furniture wax, benzine, insecticides or other volatile liquids since they may corrode the cabinet.

ATTACHMENTS — Do not use attachments not recommended by the product manufacturer as they may cause hazards.

WATER AND MOISTURE — Do not use this product near water — for example, near a bathtub, wash bowl, kitchen sink, or laundry tub; in a wet basement; or near a swimming pool; and the like.

ACCESSORIES — Do not place this product on an unstable cart, stand, tripod, bracket, or table. The product may fall, causing serious injury to a child or adult, and serious damage to the product. Use only with a cart, stand, tripod, bracket, or table recommended by the manufacturer, or sold with the product. Any mounting of the product should follow the manufacturer's instructions, and should use a mounting accessory recommended by the manufacturer.

CART — A product and cart combination should be moved with care. Quick stops, excessive force, and uneven surfaces may cause the product and cart combination to overturn.



VENTILATION — Slots and openings in the cabinet are provided for ventilation and to ensure reliable operation of the product and to protect it from overheating, and these openings must not be blocked or covered. The openings should never be blocked by placing the product on a bed, sofa, rug, or other similar surface. This product should not be placed in a built-in installation such as a bookcase or rack unless proper ventilation is provided or the manufacturer's instructions have been adhered to.

POWER SOURCES — This product should be operated only from the type of power source indicated on the marking label. If you are not sure of the type of power supply to your home, consult your product dealer or local power company.

LOCATION — The appliance should be installed in a stable location.

NONUSE PERIODS — The power cord of the appliance should be unplugged from the outlet when left unused for a long period of time.

GROUNDING OR POLARIZATION

- If this product is equipped with a polarized alternating current line plug (a plug having one blade wider than the other), it will fit into the outlet only one way. This is a safety feature. If you are unable to insert the plug fully into the outlet, try reversing the plug. If the plug should still fail to fit, contact your electrician to replace your obsolete outlet. Do not defeat the safety purpose of the polarized plug.

- If this product is equipped with a three-wire grounding type plug, a plug having a third (grounding) pin, it will only fit into a grounding type power outlet. This is a safety feature. If you are unable to insert the plug into the outlet, contact your electrician to replace your obsolete outlet. Do not defeat the safety purpose of the grounding type plug.

POWER-CORD PROTECTION - Power-supply cords should be routed so that they are not likely to be walked on or pinched by items placed upon or against them, paying particular attention to cords at plugs, convenience receptacles, and the point where they exit from the product.

OUTDOOR ANTENNA GROUNDING — If an outside antenna or cable system is connected to the product, be sure the antenna or cable system is grounded so as to provide some protection against voltage surges and built-up static charges. Article 810 of the National Electrical Code, ANSI/NFPA 70, provides information with regard to proper grounding of the mast and supporting structure, grounding of the lead-in wire to an antenna discharge unit, size of grounding conductors, location of antenna-discharge unit, connection to grounding electrodes, and requirements for the grounding electrode. See Figure A.

LIGHTNING — For added protection for this product during a lightning storm, or when it is left unattended and unused for long periods of time, unplug it from the wall outlet and disconnect the antenna or cable system. This will prevent damage to the product due to lightning and power-line surges.

POWER LINES — An outside antenna system should not be located in the vicinity of overhead power lines or other electric light or power circuits, or where it can fall into such power lines or circuits. When installing an outside antenna system, extreme care should be taken to keep from touching such power lines or circuits as contact with them might be fatal.

OVERLOADING — Do not overload wall outlets, extension cords, or integral convenience receptacles as this can result in a risk of fire or electric shock.

OBJECT AND LIQUID ENTRY - Never push objects of any kind into this product through openings as they may touch dangerous voltage points or short-out parts that could result in a fire or electric shock. Never spill liquid of any kind on the product.

SERVICING — Do not attempt to service this product yourself as opening or removing covers may expose you to dangerous voltage or other hazards. Refer all servicing to qualified service personnel.

DAMAGE REQUIRING SERVICE - Unplug this product from the wall outlet and refer servicing to qualified service personnel under the following conditions:

- When the power-supply cord or plug is damaged.
- If liquid has been spilled, or objects have fallen into the product.
- If the product has been exposed to rain or water.
- If the product does not operate normally by following the operating instructions. Adjust only those controls that are covered by the operating instructions as an improper adjustment of other controls may result in damage and will often require extensive work by a qualified technician to restore the product to its normal operation.
- If the product has been dropped or damaged in any way.
- When the product exhibits a distinct change in performance — this indicates a need for service.

REPLACEMENT PARTS — When replacement parts are required, be sure the service technician has used replacement parts specified by the manufacturer or have the same characteristics as the original part. Unauthorized substitutions may result in fire, electric shock, or other hazards.

SAFETY CHECK - Upon completion of any service or repairs to this product, ask the service technician to perform safety checks to determine that the product is in proper operating condition.

WALL OR CEILING MOUNTING — The product should not be mounted to a wall or ceiling.

HEAT — The product should be situated away from heat sources such as radiators, heat registers, stoves, or other products (including amplifiers) that produce heat.

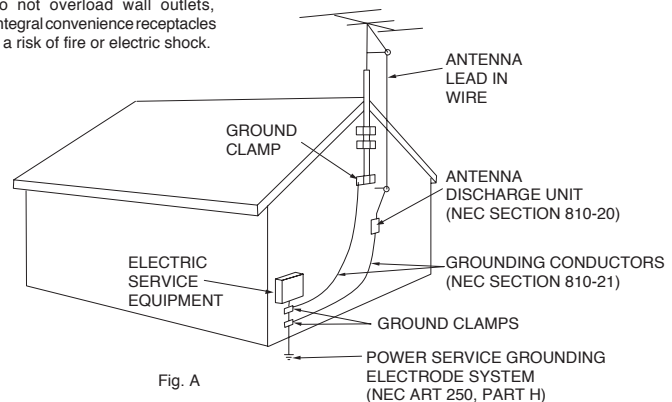

Fig. A

NEC — NATIONAL ELECTRICAL CODE

1. For adult use only - Keep out of the reach of children.
2. Water and Moisture - The player should not be used near water - for example, near a bath tub, kitchen sink, laundry tub, in a wet basement or near a swimming pool, etc. Do not spill water or other liquids in to or on to your mixer.
3. Ventilation - The Mixer should be situated so that its location or position does not interfere with its proper ventilation. For example, the Mixer should not be situated on a bed, sofa, rug, or similar surface that may block the ventilation openings; or, placed in a built-in installation, such as a bookcase or cabinet that may impede the flow of air through the ventilation openings.
4. Heat - The Mixer should be situated away from heat sources such as radiators, heat registers, stoves, or other appliances (including amplifiers) that produce heat.
5. Power Sources - The Mixer should be connected to a power supply (wall outlet) only of the type described in the operating instructions or as marked on the Mixer.
6. Servicing -The user should not attempt to service the Mixer beyond that described in the operating instructions. There are no user serviceable parts inside. All other servicing should be referred to qualified service personnel. The Player should be serviced by qualified service personnel when:
 - A. The power-supply cord or the plug has been damaged.
 - B. Objects have fallen, or liquid has been spilled into the Mixer.
 - C. The Mixer has been exposed to rain or water.
 - D. The Mixer does not appear to operate normally or exhibits a marked change in performance.
7. Never disassemble or modify your unit in any way, doing so will void your manufacturer's warranty.
8. Never plug this mixer in to a dimmer pack.
9. Do not let insecticides, benzene, or thinner come in contact with the surface of the unit.
10. This unit is intended for indoor use only, use of this product outdoors voids all warranties.
11. Always mount this unit in safe and stable matter.
12. Disconnect from main power before making any type of connection.
13. Cleaning - The mixer should be cleaned only as recommended by the manufacturer. Use a soft cloth to wipe down the outside of the unit. For stubborn stains moisten a soft cloth with glass cleaner or other mild detergent to wipe away any stains. Use a soft cloth to wipe any residual cleaner. Never use volatile cleaners such as benzene, solvent, or thinner to clean your unit, these cleaners will damage the unit's surface.
14. Handle the power supply cord carefully. Do not damage or deform; it may cause electric shock or malfunction when used. Hold plug attachment when removing from wall outlet. Do not pull on the cord.
15. To avoid electric shock, do not open the top cover when the unit is plugged in. If problems occur with the unit, call American Audio® customer support.
16. Do not place metal objects or spill any liquids inside or on the mixer. Electric shock or malfunction may occur.
17. Power Cord Protection - Power supply cords should be routed so that they are not likely to be walked on or pinched by items placed upon or against them, paying particular attention to cords at plugs, convenience receptacles, and the point where they exit from the mixer. Route your power cord out of the way of foot traffic.
18. Always have the trim controls set to their lowest level during initial power-up to prevent speaker damage.

Introductions: Congratulations and thank you for purchasing the American Audio® M1624FX mixing console. This mixing console is a representation of American Audio's continuing commitment to produce the best and highest quality audio products possible at an affordable price. Please read and understand this manual completely before attempting to operate your new mixer. Please carefully read and understand the instructions in this manual thoroughly before attempting to operate this unit. These instructions contain important safety information regarding the use and maintenance of this unit. Take special care to follow all warning symbols and labels both on the unit and printed in this manual. Also, Please keep this manual with the unit, for future reference.

Customer Support:

American Audio® provides a toll free customer support line, to provide set up help and answer any question should you encounter problems during your initial set up or operation. You may also visit us on the web at www.americanaudio.us for any comments or suggestions. Service Hours are Monday through Friday 9:00 a.m. to 5:30 p.m. Pacific Standard Time.

Voice: (800) 322-6337
Fax: (323) 582-2941
E-mail: support@americandj.com

To purchase parts online visit <http://parts.americandj.com>

Caution! There are no user serviceable parts inside this mixer. Do not attempt any repairs yourself, without being instructed to do so by an authorized American Audio service technician. Doing so will void your manufactures warranty. In the unlikely event your mixer may require service, please contact American Audio® customer support.

Do not discard the packing carton in the trash. Please recycle when ever possible.

Please be sure to make any connections before plugging the mixer in to an electrical outlet. All fader and volume controls should be set to zero or minimum position, before the mixer is switched on. If the mixer has been exposed to drastic temperature fluctuation (e.g. after transportation), do not switch on the mixer immediately. The arising condensation of water might damage your device. Leave the device switched off until it has reached room temperature.

Operating Determinations:

- When installing this mixer, please make sure that the device is not exposed or will not be exposed to extreme heat, moisture or dust!
- Do not operate the mixer in extremely hot (more than 30°/100°F) or extremely cold (less than 5°C/40°F) surroundings.
- Keep the unit out of direct sunlight and away from heaters.
- Operate the mixer only after becoming familiar with its functions. Do not permit operation by persons not qualified for operating the mixer. Most damages are the result of unprofessional operation!
- Do not attempt to operate this mixer if the power cord has been frayed or damaged.
- Disconnect from main power before making any type of connection.
- Do not attempt to operate this mixer, if it becomes damaged in any way.
- Never operate this mixer when it's covers are removed.
- To reduce the risk of electrical shock or fire, do not expose this mixer to rain or moisture.
- This mixer is intended for indoor use only, use of this product outdoors voids all warranties.
- During long periods of non-use, disconnect the mixer's main power.

M1624FX

UNPACKING

Every M1624FX has been thoroughly tested and has been shipped in perfect operating condition. Carefully check the shipping carton for damage that may have occurred during shipping. If the carton appears to be damaged, carefully inspect your mixer for any damage and be sure all equipment necessary to operate the mixer has arrived intact. In the event damage has been found or parts are missing, please contact our toll free customer support number for further instructions. Please do not return the mixer to your dealer without first contacting customer support.

M1624FX

FRONT & REAR PANEL

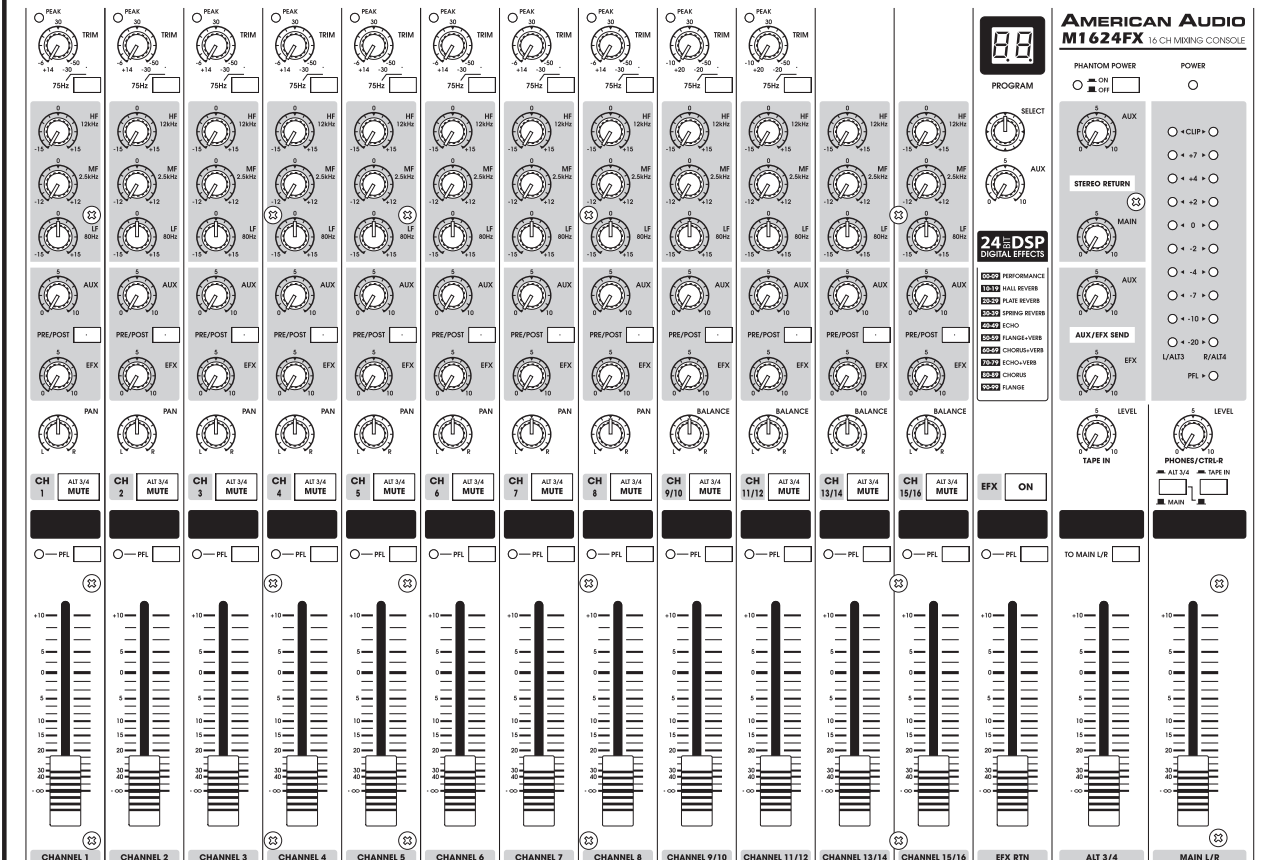
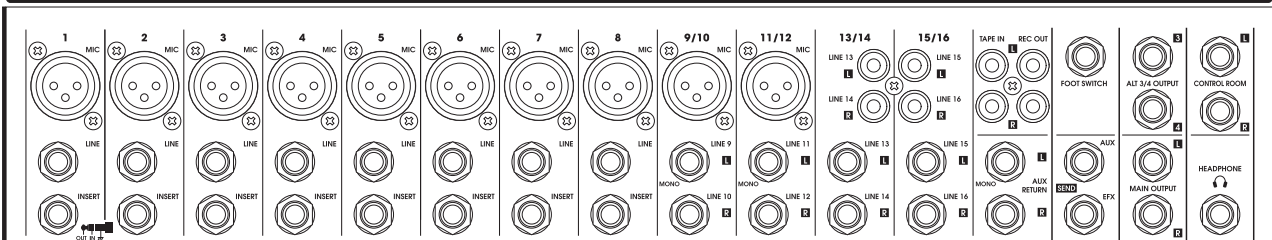
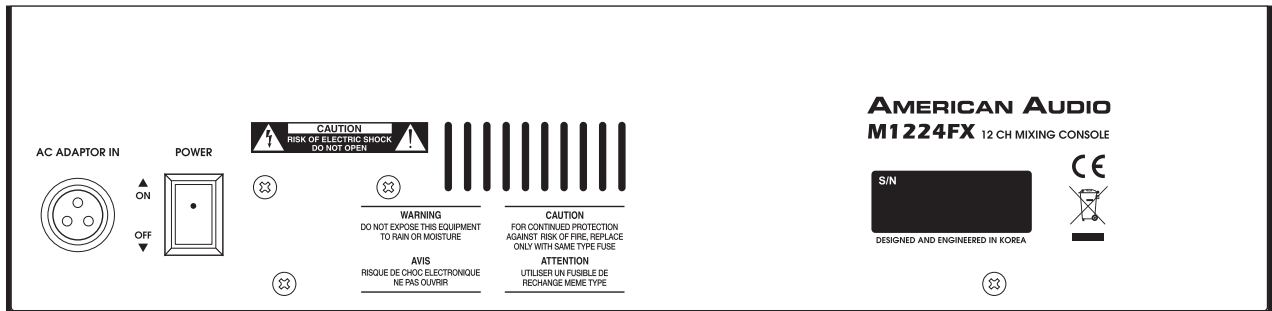

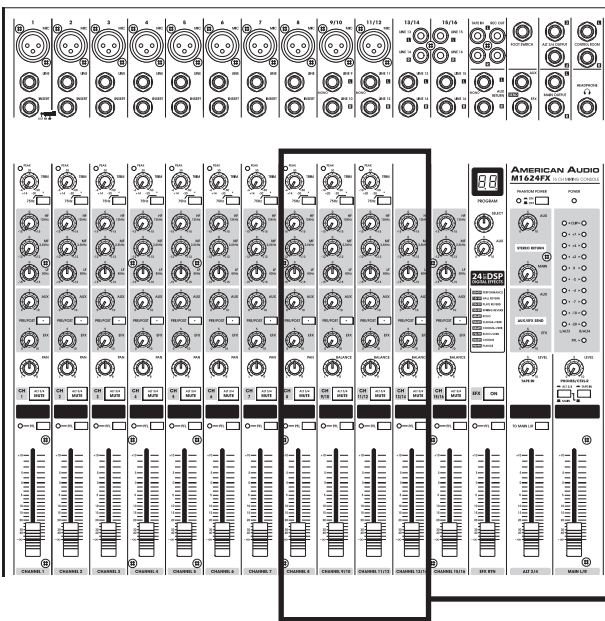

CHANNEL CONTROL SECTION

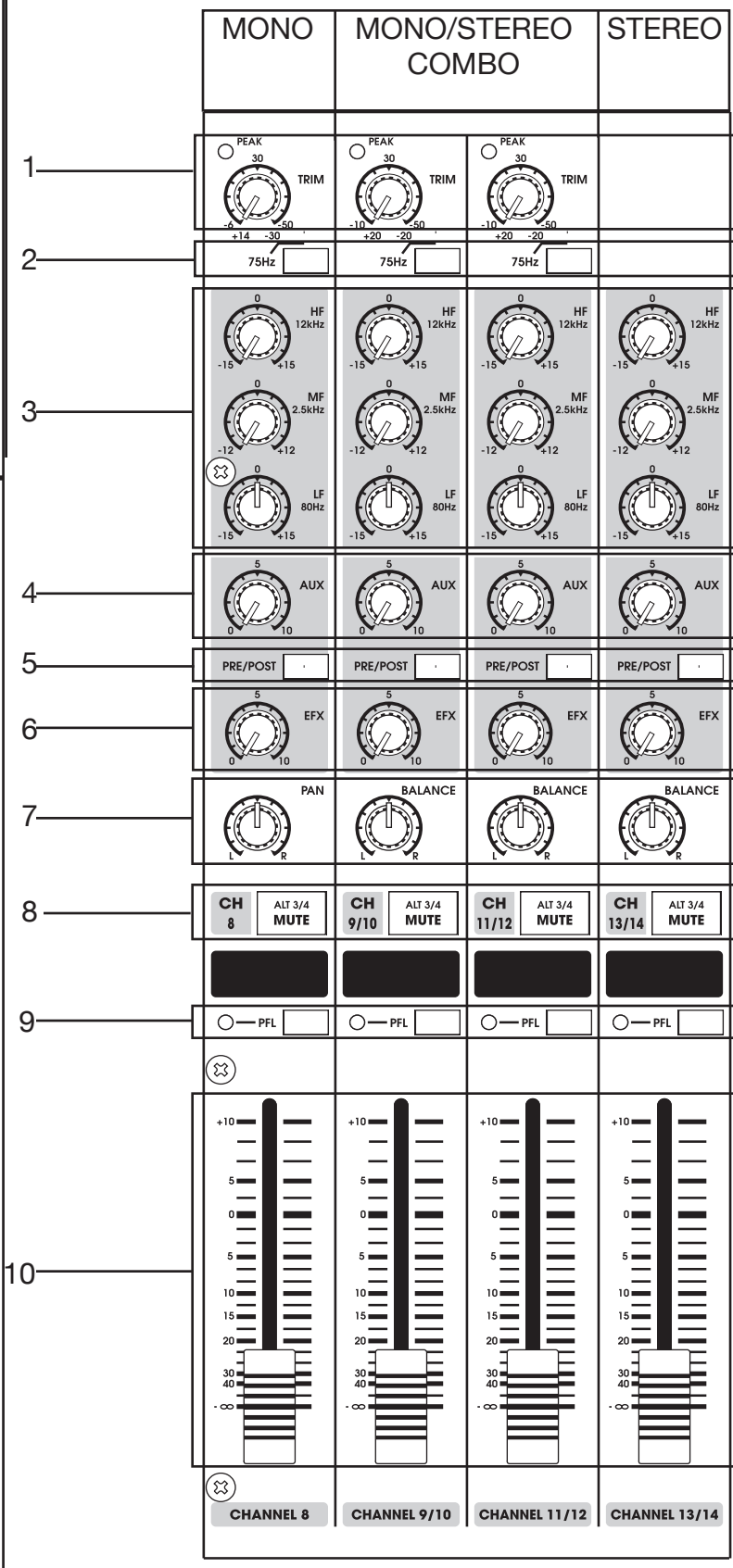

CHANNEL CONTROL SECTION:**1. PEAK LED INDICATORS & TRIM CONTROL -**

PEAK INDICATORS - These LED indicators will “light” when the input signal reaches 5dB below the channel’s clipping point. If the LED “lights” more then usual, you should use the *TRIM CONTROL* to decrease the input level of the channel. If this does not work, reduce the output level of the connected source.

TRIM CONTROL - This adjustment is used to adjust the audio source signal input gain for a channel. The best S/N and dynamic range balance will be reached if you adjust the TRIM CONTROL so that the PEAK INDICATORS “light” occasionally.

Channel Sensitivity”

MIC input sensitivity is between +6dB and -50dB.

Line input sensitivity is between +14dB and -30dB.

The Mono/Stereo Combo input channel sensitivity is between +20dB and -20dB.

2. HPF (HIGH PASS FILTER) BUTTON - This button toggles the HPF (Hight Pass Filter) on or off. To turn the HPF on press the button in. The HPF cuts frequencies below 75Hz.

3. EQUALIZER - Please see the chart below for the Max. Boost/Cut for each control.

CHANNEL HIGH CONTROL - This knob is used to adjust the high (treble) frequency levels of the channel. Turning the knob in a counter-clockwise direction will decrease the amount of treble applied to a channel signal, turning the knob in a clockwise direction will increase the amount of treble applied to a channel signal.

CHANNEL MID CONTROL - This knob is used to adjust the midrange levels of the channel. Turning the knob in a counter-clockwise direction will decrease the amount of midrange applied to a channel signal, turning the knob in a clockwise direction will increase the amount of midrange applied to a channel signal.

CHANNEL LOW CONTROL - This knob is used to adjust the low frequency levels of the channel. Turning the knob in a counter-clockwise direction will decrease the amount of bass applied to a channel signal, turning the knob in a clockwise direction will increase the amount of bass applied to a channel signal.

CONTROL	MAX. BOOST/CUT	FREQUENCY	TYPE
HIGH	±15dB	12kHz	Shelving
MID	±12dB	2.5kHz	Peaking
LOW	±15dB	80Hz	Shelving

4. AUX CONTROLS - The AUX knobs control the signal level that the channel sends to AUX bus.

5. PRE/POST BUTTON - This button determines if the AUX signal is Pre Fader (signal level is not affected by fader position) or Post Fader (signal level is affected by the fader position).

6. EFX CONTROL - These knobs control the signal levels sent to the EFX bus. The channel signals mixed by this bus have their overall level set by the MASTER EFX SEND control to the EFX jack located on the front top panel. **Since the control is place after the channel fader, the signal level will be affected by the channel fader’s setting.**

NOTE: The Effect bus signal is also fed into the internal DSP (digital signal processor).

7. PAN/BALANCE CONTROL -

PAN (Mono Control) - This control pans the channel signal across the master L and R buses, therefore determining the ideal position of the sound from that channel.

EXAMPLE: If the PAN control is set all the way to the left, the sound from that channel will only be projected from the left speaker only. Same goes for the control being set all the way to the right, only from the right speaker.

BALANCE (Stereo Control) - This control lets you adjust the balance of the L/R position, of the stereo input signal. Turning this knob to the left moves the source signal towards the MAIN MIX L bus, turning the knob to the right sends the signal towards the MAIN MIX R bus.

8. MUTE/ALT 3/4 BUTTON - When the corresponding channels MUTE/ALT 3/4 button is not active (depressed) the channel output will be sent to the ALT 3/4 output, and **not** the MAIN L/R output. The ALT 3/4 bus gives you a second independent stereo sub mix with its own sub master stereo fader.

9. PFL BUTTONS - This button allows you to monitor the PRE FADER LEVEL input signal through headphones or the control room outputs. When the button is NOT pressed the channel signal will be sent to the PFL bus.

10. CHANNEL FADERS - These faders are channel's main level control. These fader's control the signal level sent from the channel to the master mixing, group outs, and effect buses. The settings of the input channel faders affect the mix or the sound level balance between the instruments or other sources connected to the inputs. When a channel is not being used, the fader should be set at the minimum position to prevent any unwanted noise added to the main signal.

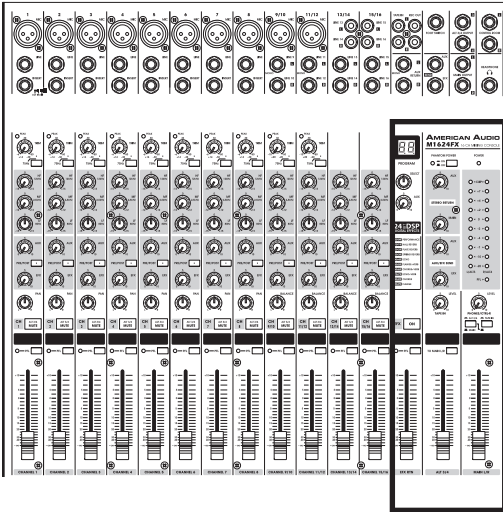

MAIN CONTROL SECTION

AMERICAN AUDIO
M1624FX 16 CH MIXING CONSOLE

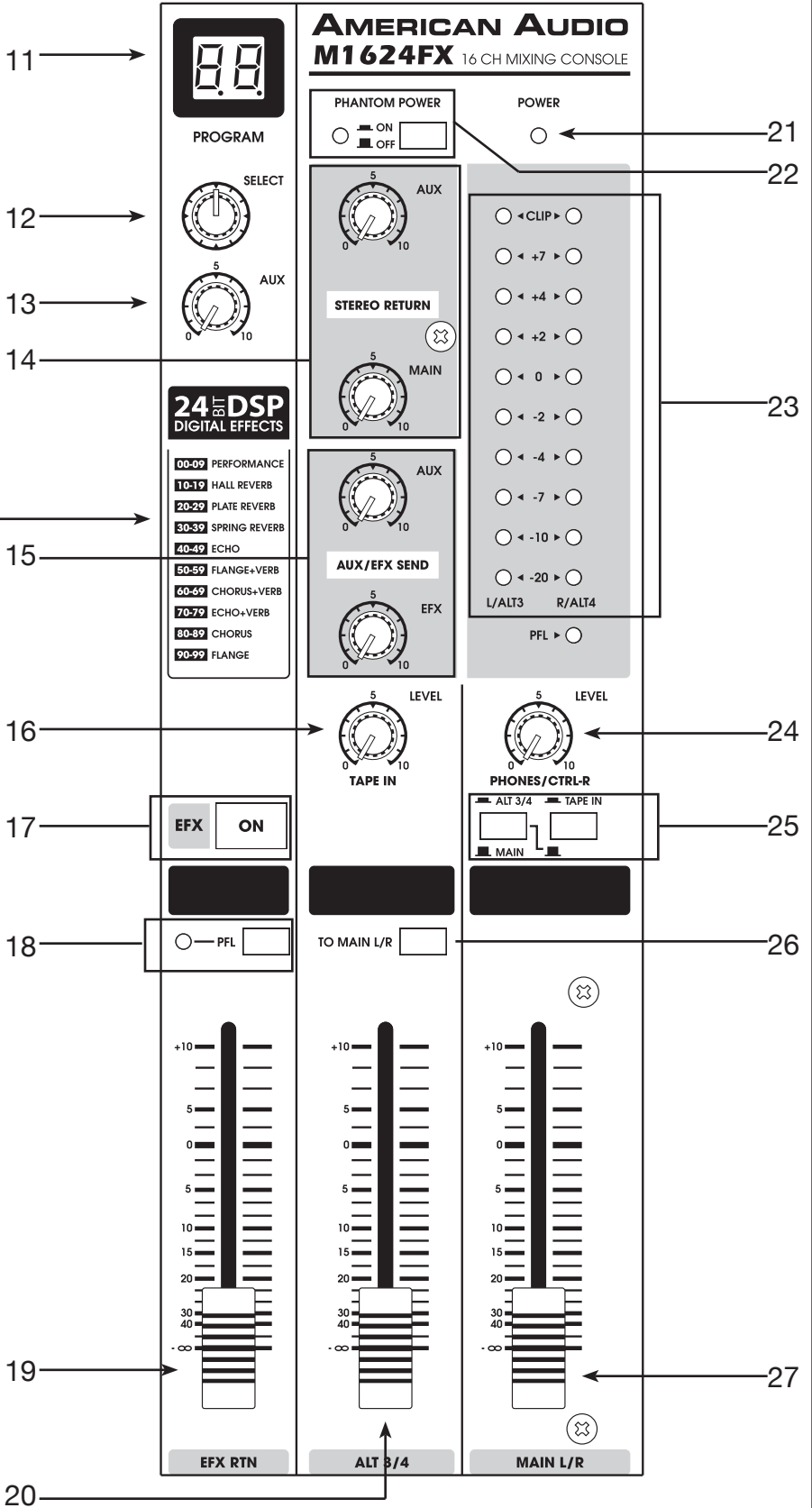

MAIN CONTROL SECTION:

11. DSP PROGRAM DISPLAY - This displays shows the number of the selected effect. Please see the effect list located on the MAIN CONTROL SECTION of the mixing console.

12. DSP PROGRAM SELECT KNOB - The program knob will allow you to select one of the 100 built-in digital effects. This control board has a 24 Bit digital high quality effect processor.

13. AUX PRE CONTROL - Use this control to adjust the signal level sent from the internal digital effect to the AUX bus.

14. STEREO RETURN CONTROL - Use the corresponding control knobs to adjust the signal level of the mixed L/R signal sent from the RETURN jack (L & R MONO) to the AUX bus.

15. MASTER SEND CONTROLS -

AUX CONTROL KNOBS - Use this control knob to adjust the signal level sent to the AUX output jack.

MASTER EFFECT CONTROLS - Use this knob to adjust the signal level of the EFFECT bus sent to the EFFECT output jack.

16. TAPE IN CONTROL - This knob controls the playback signal level from the component that is connected to the TAPE IN RCA JACKS located on at the top panel of the mixing board.

17. DSP ON/OFF BUTTON - This button turns the internal effect program on/off.

18. PFL BUTTON - Pressing this button "In" will allow you to send the effect signal to the PFL bus.

19. EFX RTN FADER - With this fader you can adjust the signal level sent from the digital effect to the MAIN bus.

20. ALT 3/4 FADER - With this fader you can adjust the final combined stereo signal level that is sent to the ALT 3/4 output jacks.

21. POWER INDICATOR - This indicator will light when mixer power switch is turned on.

22. PHANTOM POWER BUTTON - When this button is pressed "In", the mixer will supply power to all channels that provide XLR MIC input jacks. Use this function when using one or more condenser microphones.

Note: When this function is active, the mixer supplies DC +48V power to pins 2 and 3 of all XLR type MIC input jacks.

- Leave this switch off if you do not need phantom power.
- When you turn this function on, make sure that only condenser MICs are connected to the XLR input jacks. Devices other than condenser MICs may be damaged if connected to the phantom power supply.
- The switch may be left on when connecting to balanced dynamic microphones.
- To avoid damage to speakers, be sure to turn off the amplifier (on powered speakers) before turning this function on or off. Also, to avoid loud noises that could cause hearing loss or device damage, we recommend that you turn all out controls (MAIN, master fader, ALT 3/4 fader etc.) to the minimum settings before activating this function.

23. LEVEL METER - This LED displays the signal level of the selected LEVEL METER SIGNAL BUTTON. When the meter lights up RED then the output is hitting the clipping level.

24. CONTROL ROOM/HEADPHONE CONTROL - This controls the signal level that is sent to the

CONTROL ROOM JACKS or HEADPHONE JACK.

25. LEVEL-METER SIGNAL BUTTONS - Use these buttons to select the signal that is sent to the CONTROL ROOM outputs and/or HEADPHONE output. The output level will be shown in the LEVEL METER. Please see the illustration below to see how the button settings correspond to the signal selection.

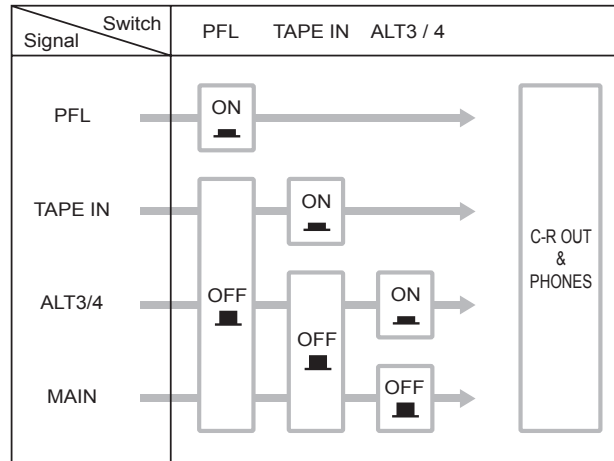

26. TO MAIN BUTTON - When this button is pressed “In” (On), the mixer will send the signal from the ALT 3/4 to the MAIN L/R outputs.

27. MAIN L/R FADERS - This fader adjusts the final signal level sent to the MAIN L/R output.

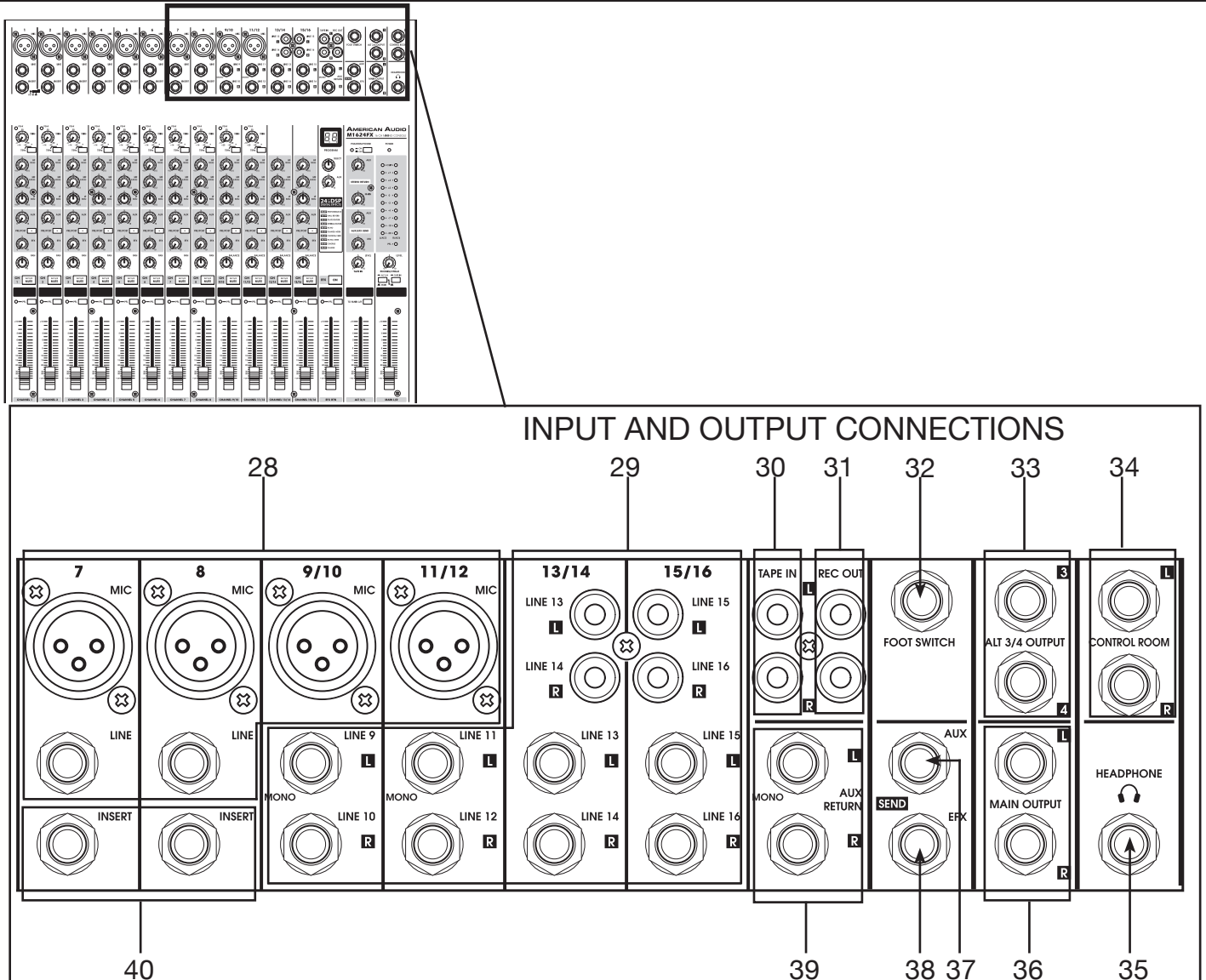

INPUT AND OUTPUT CONNECTIONS:

28. CHANNEL INPUT JACKS -

MIC JACKS - These are balanced 3-pin XLR-type input jacks.

BALANCED LINE IN JACKS - These standard 1/4" TRS phone jack are used for balanced or unbalanced line level signals. Some examples of line level equipment include most electronic keyboards, synthesizers, turntables (with appropriate pre-amps), tape decks and line outputs from other mixers.

29. CHANNEL STEREO INPUT JACKS - These are unbalanced stereo line input jacks. The two jacks provided are 1/4" and RCA.

30. TAPE INPUT JACKS - These RCA jacks are used to connect a stereo sound source. Use these jacks when you want to connect a CD, cassette, or DAT, directly to the mixer for monitoring. Use the TAPE IN CONTROL to adjust the signal level.

31. REC OUT JACKS - These jacks send the PRE FADER signal from the master bus to a tape deck for recording.

32. FOOT SWITCH JACK - You can connect a foot switch to this jack, and use the foot jack to toggle the digital effects on/off.

33. ALT 3/4 OUPUT JACKS - These unbalanced 1/4" phone type jacks output the ALT 3/4 signal to the input of a MTR, external mixer, or other device.

34. CONTROL ROOM OUTPUT JACKS - These stereo 1/4" phone type output jacks send the mixed signal to a monitoring system. Use the CONTROL ROOM/HEADPHONE CONTROL to adjust the output signal level. The signal monitored by these jacks is select by the using the LEVEL METER SIGNAL BUTTONS.

35. HEADPHONE JACK - Use this jack to connect headphones to the mixing board.

NOTE: The signal monitored by these jacks is select by the using the LEVEL METER SIGNAL BUTTONS, the TAPE IN CONTROL and the PFL BUTTON on the input channels.

36. MAIN L/R OUTPUT JACKS - These jacks deliver a stereo output signal to a amplifier or powered speakers. You can also use these outputs to send a signal you wish to record. You can control the signal level control using the MAIN FADER located in the MASTER CONTROL section.

37. AUX OUTPUT JACK - This 1/4" output jack send a signal from the AUX bus to a cue box, effector, or other monitoring system.

38. EFX OUTPUT JACK - This unbalanced phone output jack sends a signal to an external effect machine.

39. STEREO RETURN L (MONO) - These are unbalanced 1/4" TRS phone-type line input jacks. The signal received by these jacks is sent to the MAIN bus and AUX bus. These jacks are typically used to receive a return signal from an external effector (reverb, delay, etc.)

40. CHANNEL INSERT I/O JACK - These are 1/4" TRS (tip, ring, sleeve) phone jacks that support bi-directional operation. These input/output jacks are located between the head-amplifier and the high pass filter. These jacks can be used to independently connect these channels to devices such as graphic equalizers, compressors, and noise filters.

NOTE: Connection to an I/O jack requires a special separately-sold insertion cable. Please see the illustration below.

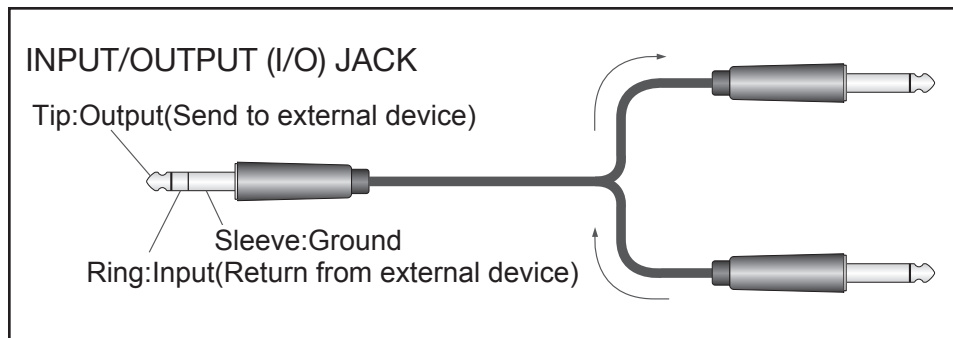

- Always use good quality twin screened audio cable. Check for instability at the output.
- Always connect both conductors at both ends, and make sure that the screen is connected only at one end.
- Do not disconnect the mains earth from each piece of equipment. This is needed to provide both safety and screen returns to the system star point.
- Equipment which has balanced inputs and outputs may need to be electrically isolated from the equipment rack and/or other equipment, to avoid earth loops.

It is important to remember that all equipment which is connected to the mains is a potential source of hum and interference and may radiate both electrostatic or electromagnetic radiation. In addition, the mains will also act as a carrier for many forms of RF interference generated by electric motors, air-conditioning units, thyristor light dimmers etc. Unless the earth system is clean, all attempts to improve hum noise levels will be ineffective. In extreme cases there will be no alternative but to provide a completely separate and independent 'technical earth' to replace the incoming 'noisy earth'. However, always consult your local electricity supply authority to ensure that safety regulations are not being infringed.

American Audio products are manufactured and wired to accept wiring practices used throughout the world.

Balanced XLR connections are wired as described, please see the diagram shown below:

- Pin #1 Shield
- Pin #2 Positive
- Pin #3 Negative

Balanced 1/4" TRS connections are wired as described, please see the diagram shown below:

- Tip is Positive
- Ring is Negative
- Sleeve is Shield

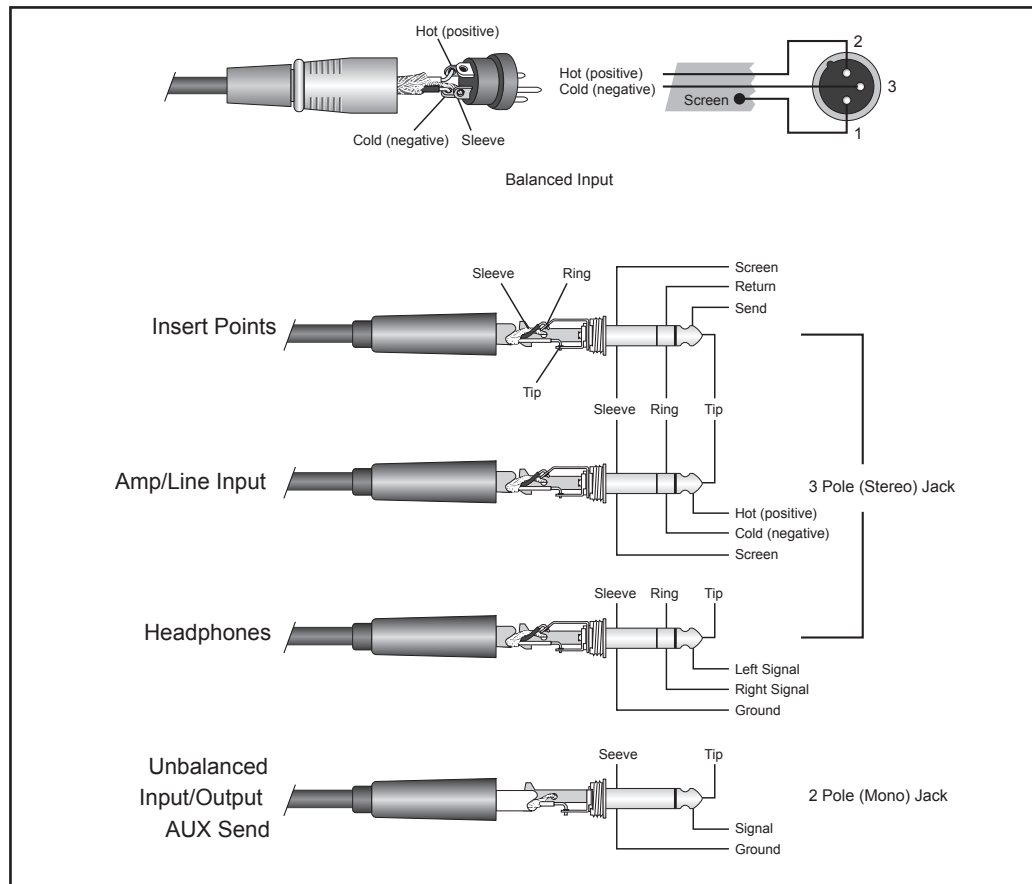

Connector and Cable Configurations

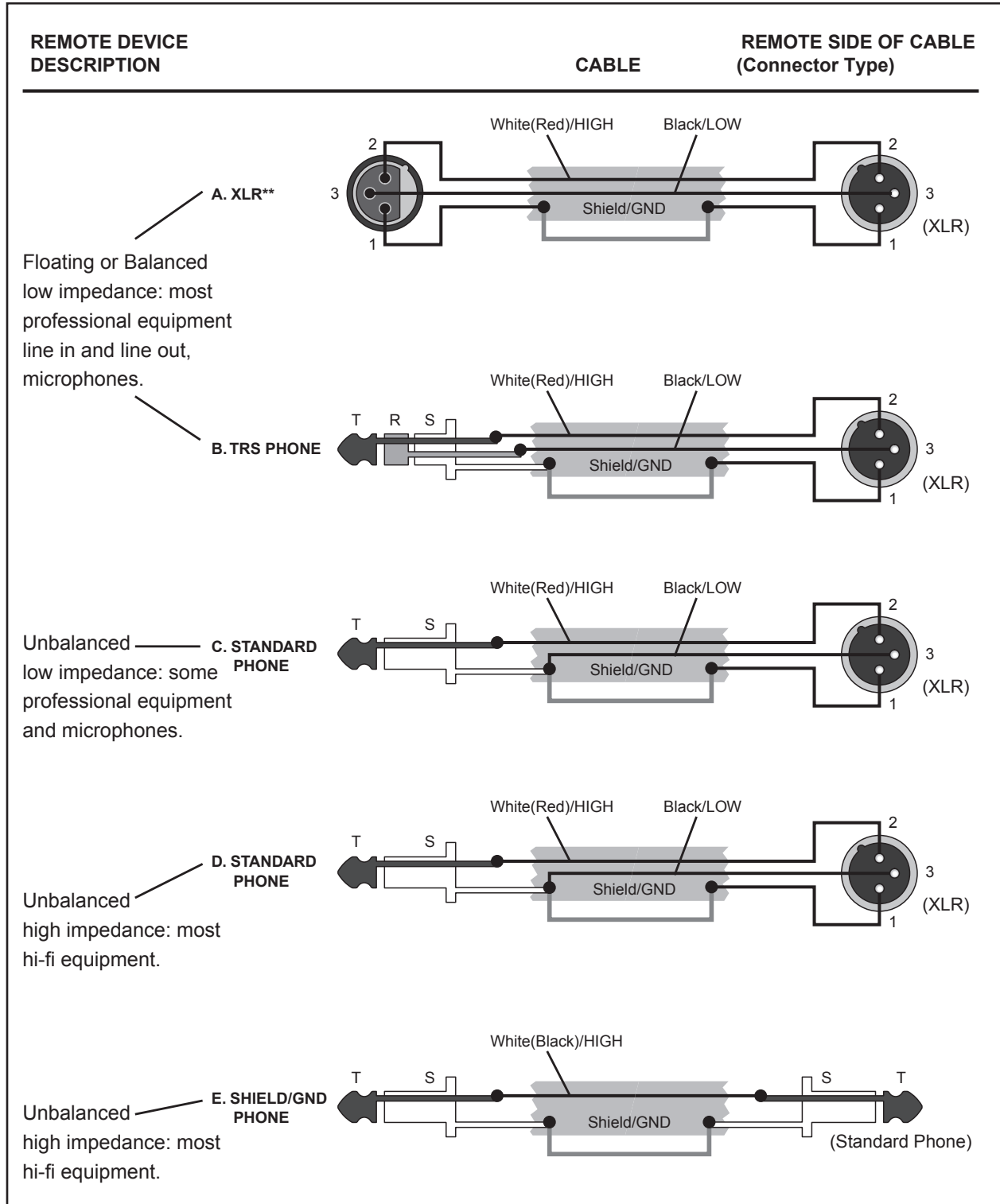

Connector and cable configurations are recommended for use with the M 4 bus series. These cables are based on the use of auxiliary equipment that is isolated from the AC power mains.

SETUP PROCEDURE:

1. Before connecting to microphones and instruments, be sure that all devices are turned off. Also be sure that all of the mixer's channel fader and master control faders are set all the way down.
2. For each connection, connect one end of the cable to the relevant microphone or instrument and connect the other end to the appropriate input jack on the mixer.

NOTE: Where an input channel provides both a MIC INPUT jack and a LINE INPUT jack, you may use either one of these jack but you may not use both at the same time. Please connect to only one of these jacks on each channel.

3. To avoid causing damage to speaker, power up the devices in the following order: Peripheral devices mixer power amps (or powered speakers).

NOTE: When shutting the system down, turn off the power in the opposite order: Power amps (powered speakers) mixer Peripheral devices.

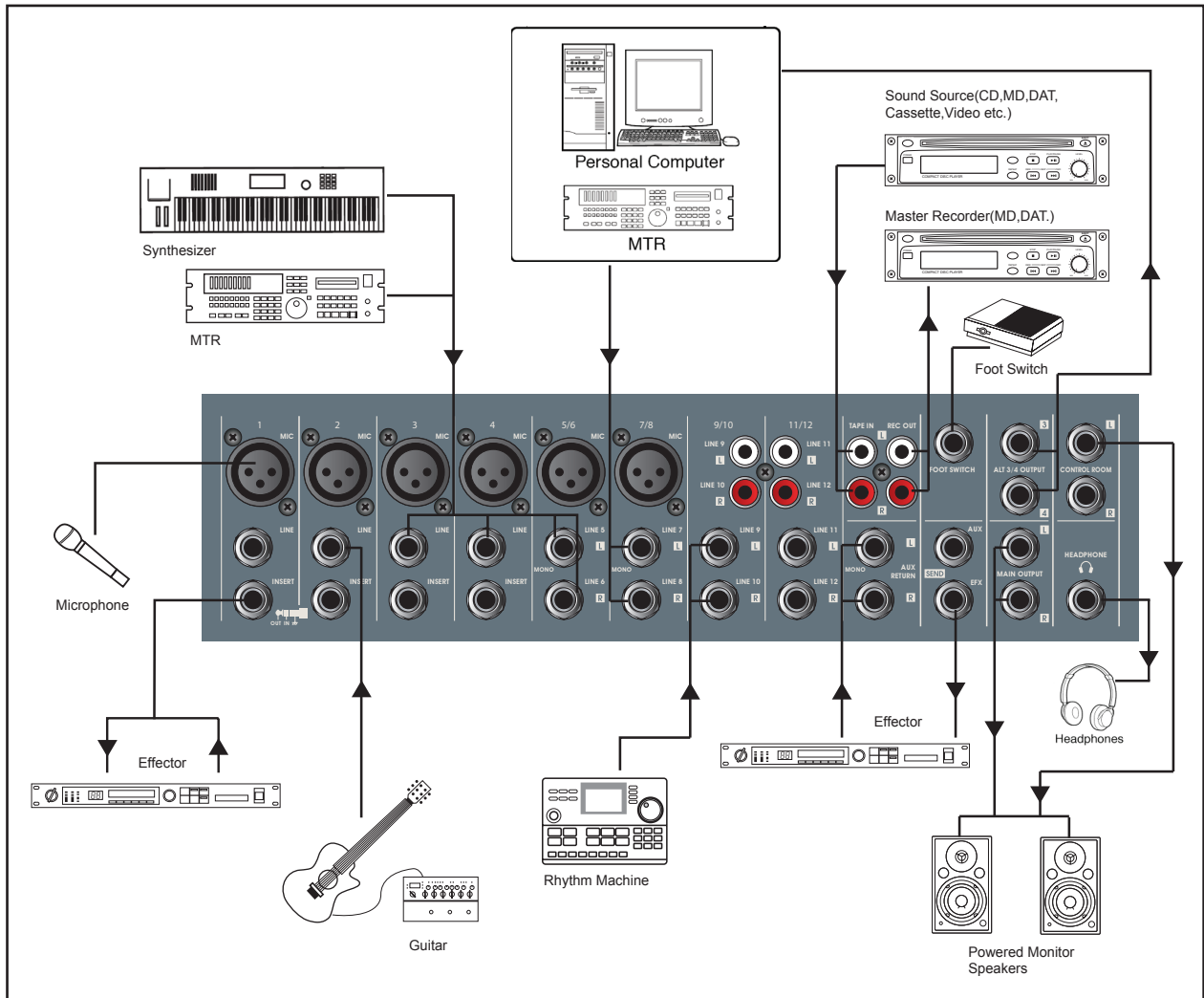

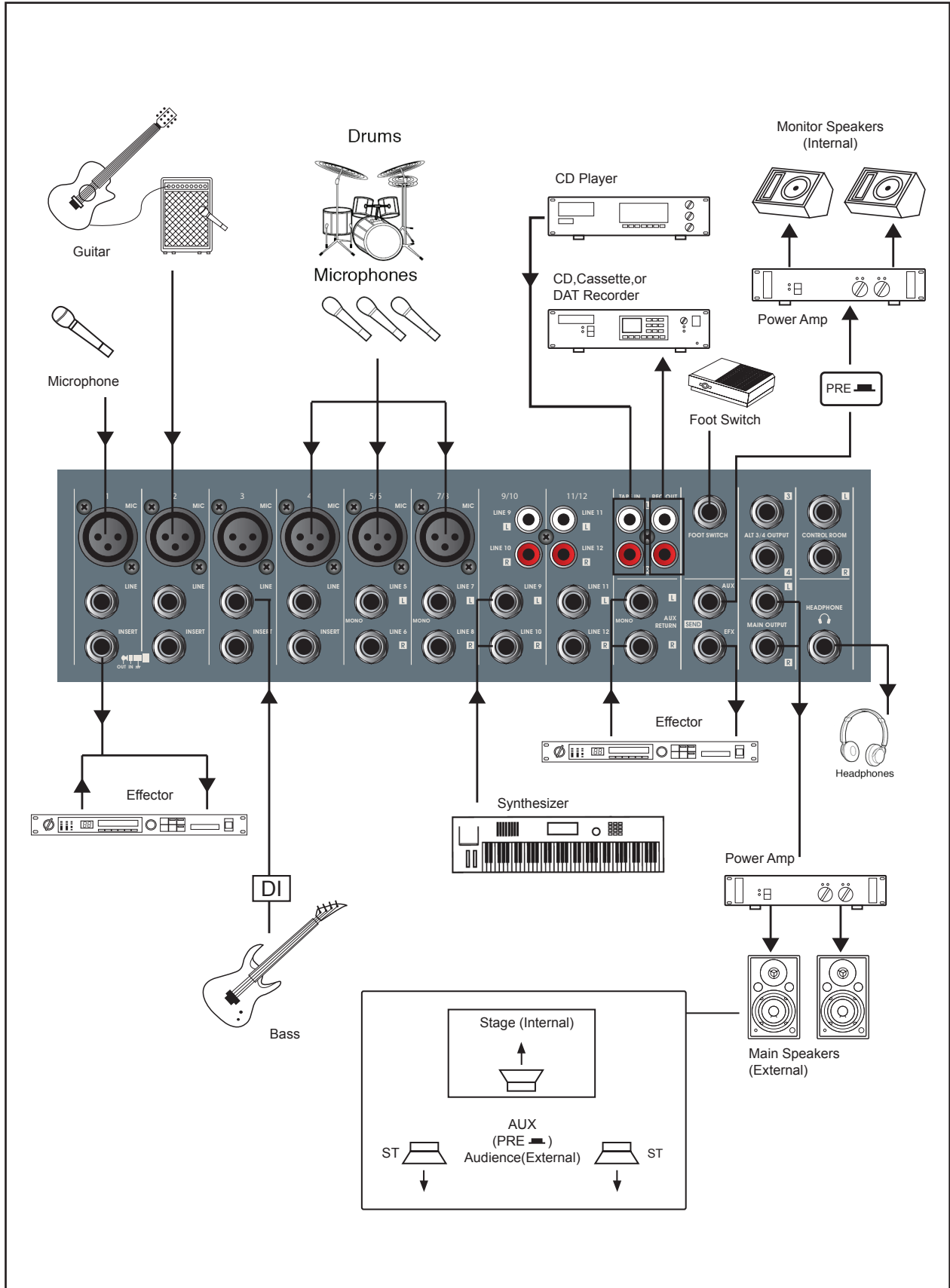

Program No.(Hex)	Effect Name	Effect Description	Efx Level	Room Size
00h	Performance	Medium Bright Plate	78.00%	8.00mc
01h		Best Plate	63.00%	36.78mc
02h		Medium Dark Spring	13.00%	9.00mc
03h		Short Plate	78.00%	8.00mc
04h		Long Bright Spring	13.00%	9.00mc
05h		Slapback 2	100.00%	8.00mc
06h		Slapback w verb	91.00%	8.00mc
07h		Echo-Verb echo long verb	28.00%	30.61mc
08h		Slow st chor	100.00%	12.11mc
09h		Hall best hall 2	78.00%	35.75mc
10h		Hall	Short Hall	44.00%
11h	Short Dark Hall		35.00%	9.00mc
12h	Short Bright Hall		35.00%	8.00mc
13h	Medium Hall		27.00%	9.00mc
14h	Medium Dark Hall		21.00%	8.00mc
15h	Medium Bright Hall		27.00%	9.00mc
16h	Long Hall		13.00%	9.00mc
17h	Long Dark Hall		21.00%	9.00mc
18h	Long Brigh Hall		27.00%	9.00mc
19h	Best Hall		58.00%	9.00mc
20h	Plate	Short Plate	78.00%	8.00mc
21h		Short Dark Plate	78.00%	8.00mc
22h		Short Bright Plate	78.00%	8.00mc
23h		Long Bright Plate	26.00%	45.00mc
24h		Medium Dark Plate	78.00%	45.00mc
25h		Medium Bright Plate	78.00%	8.00mc
26h		Medium Plate	78.00%	8.00mc
27h		Long Plate	78.00%	45.00mc
28h		Long Dark Plate	52.00%	45.00mc
29h		Best Plate	63.00%	36.78mc
30h	Spring	Short Spring	13.00%	9.00mc
31h		Short Dark Spring	13.00%	8.00mc
32h		Short Bright Spring	13.00%	8.00mc
33h		Medium Spring	13.00%	9.00mc
34h		Medium Dark Spring	13.00%	9.00mc
35h		Medium Bright Spring	13.00%	9.00mc
36h		Long Spring	13.00%	9.00mc
37h		Long Dark Spring	13.00%	9.00mc
38h		Long Bright Spring	13.00%	9.00mc
39h		Best Spring	13.00%	9.00mc
40h	Echo	Slapback 2	100.00%	8.00mc
41h		Short Echo	80.00%	8.00mc
42h		420ms Delay High Feedback	100.00%	8.00mc
43h		420ms Delay Low Feedback	100.00%	8.00mc
44h		550-275ms Delay cross Feedback	100.00%	8.00mc
45h		550ms Delay High Feedback	100.00%	8.00mc
46h		550ms Delay Low Feedback	100.00%	8.00mc
47h		650-375ms Delay cross Feedback	100.00%	8.00mc
48h		650ms Delay High Feedback	100.00%	8.00mc

50h	Flanger+Verb	Flanger Reverb	100.00%	34.72mc
51h		Flanger Short reverb	100.00%	34.72mc
52h		It Flanger Medium Reverb	99.00%	29.58mc
53h		Medium Flanger Medium Reverb	100.00%	18.28mc
54h		Slow Flanger Long Reverb	100.00%	29.58mc
55h		Flanger Long Reverb	100.00%	29.58mc
56h		Stereo Flanger Medium Reverb	100.00%	29.58mc
57h		Stereo Flanger Long Reverb	100.00%	29.58mc
58h		Whip Flanger Short Reverb	100.00%	21.36mc
59h		Whip Flanger Long Reverb	100.00%	29.58mc
60h		Chorus+Verb	Slow Chorus Short Reverb	100.00%
61h	Slow Chorus Medium Reverb		100.00%	36.78mc
62h	Slow Chorus Long Reverb		100.00%	36.78mc
63h	Medium Chorus Medium Reverb		79.00%	29.58mc
64h	Medium Chorus Long Reverb		79.00%	29.58mc
65h	Fast Chorus Short Reverb		100.00%	30.61mc
66h	Fast Chorus Long Reverb		100.00%	29.58mc
67h	Trem Chorus Medium Reverb		100.00%	31.64mc
68h	Trem Chorus Long Reverb		100.00%	36.78mc
69h	Big Chorus Medium Reverb		100.00%	29.58mc
70h	Echo+Verb	Echo-Verb 1	33.00%	17.25mc
71h		Hard echo Medium verb	32.00%	26.50mc
72h		Echo-Verb 2	53.00%	40.89mc
73h		Echo-Verb 4	37.00%	28.56mc
74h		Echo-Verb 3	23.00%	45.00mc
75h		Pre delay serial	48.00%	29.58mc
76h		Cross echo	72.00%	8.00mc
77h		Echo long verb	28.00%	30.61mc
78h		Echo cross verb	29.00%	30.61mc
79h		Echoverb	18.00%	37.81mc
80h	Chorus	Chorus 1	100.00%	8.00mc
81h		Chorus 2	100.00%	11.08mc
82h		Chorus fast	100.00%	8.00mc
83h		Deep slow chorus	100.00%	8.00mc
84h		Deep fast chorus	72.00%	8.00mc
85h		Medium slow chorus	100.00%	8.00mc
86h		Slow stereo chorus	100.00%	8.00mc
87h		Leslie	100.00%	8.00mc
88h		Medium leslie	100.00%	8.00mc
89h		Stereo chorus	100.00%	8.00mc
90h	Flanger	Slow It Flange	100.00%	41.92mc
91h		It Flanger	100.00%	8.00mc
92h		Deep slow flanger	100.00%	41.92mc
93h		Deep It flanger	100.00%	41.92mc
94h		Deep lazer flanger	100.00%	41.92mc
95h		Jet flanger 1	100.00%	41.92mc
96h		Jet flanger 2	100.00%	41.92mc
97h		Medium flanger	100.00%	8.00mc
98h		Medium lazer flanger	100.00%	41.92mc
99h		Strong flanger	100.00%	41.92mc

Dust will settle in the fader track overtime dust can cause a popping noise on the fader. To prevent this cover you mixer. If the mixer has been unused for over a month or more move you faders up and down a couple of times this will move most of the settle dust from the fader track. Do not eat, drink, or smoke over you over or near the mixer.

Don't use spray cleaners. Use compressed air or a vacuum with a brush accessory.

Cleaning frequency depends on the environment in which the mixer operates (i.e. smoke, fog residue, dust, dew).

Trouble Shooting: Listed below are common problems you may encounter, and solutions.

I can't hear the source from a channel thru the main mix

Check the trim knob, fader, and output volume on your source.

Check the Mute button, or make sure your sub groups are assigned to the mains.

Check you connection from the source to the mixer.

Try the same connection on a different channel with the same settings.

I hear noise in mix

Check your power a 60Hz hum, could come from ungrounded equipment.

Turn all the faders down one at a time and the stereo return knob. If the noise goes away it's that channel or the source. Disconnect the source from the mixer bring up that fader if the noise is gone it your source, If it is the source try bringing down its out put volume.

I have no power

Make sure your power supply is properly hooked up to the unit.

I can't hear the mix on my headphones or my control room monitors

Check the phones / control room knob, Select the proper source.

The M1624FX carries a one year limited warranty. We recommend you fill out the enclosed warranty card to validate your purchase. All returned service items whether under warranty or not, must be freight pre-paid and accompany a R.A. (return authorization) number. If the mixer is under warranty, you must provide a proof of purchase invoice. You may obtain a R.A. number by contacting our customer support team on our toll free number. Please contact American Audio® customer support at (800) 322-6337 for a R.A. number. All package not displaying a R.A. number on the outside of the package will be returned to the shipper.

1-YEAR LIMITED WARRANTY

A. American Audio® hereby warrants, to the original purchaser, American Audio® products to be free of manufacturing defects in material and workmanship for a period of 1 Year (365 days) from the date of purchase. This warranty shall be valid only if the product is purchased within the United States of America, including possessions and territories. It is the owner's responsibility to establish the date and place of purchase by acceptable evidence, at the time service is sought.

B. For warranty service, send the product only to the American Audio® factory. All shipping charges must be pre-paid. If the requested repairs or service (including parts replacement) are within the terms of this warranty, American Audio® will pay return shipping charges only to a designated point within the United States. If the entire instrument is sent, it must be shipped in its original package. No accessories should be shipped with the product. If any accessories are shipped with the product, American Audio® shall have no liability whatsoever for loss of or damage to any such accessories, nor for the safe return thereof.

C. This warranty is void if the serial number has been altered or removed; if the product is modified in any manner which American Audio® concludes, after inspection, affects the reliability of the product; if the product has been repaired or serviced by anyone other than the American Audio® factory unless prior written authorization was issued to purchaser by American Audio®; if the product is damaged because not properly maintained as set forth in the instruction manual.

D. This is not a service contract, and this warranty does not include maintenance, cleaning or periodic check-up. During the period specified above, American Audio® will replace defective parts at its expense, and will absorb all expenses for warranty service and repair labor by reason of defects in material or workmanship. The sole responsibility of American Audio® under this warranty shall be limited to the repair of the product, or replacement thereof, including parts, at the sole discretion of American Audio®. All products covered by this warranty were manufactured after January 1, 1990, and bear identifying marks to that effect.

E. American Audio® reserves the right to make changes in design and/or improvements upon its products without any obligation to include these changes in any products theretofore manufactured.

F. No warranty, whether expressed or implied, is given or made with respect to any accessory supplied with products described above. Except to the extent prohibited by applicable law, all implied warranties made by American Audio® in connection with this product, including warranties of merchantability or fitness, are limited in duration to the warranty period set forth above. And no warranties, whether expressed or implied, including warranties of merchantability or fitness, shall apply to this product after said period has expired. The consumer's and or Dealer's sole remedy shall be such repair or replacement as is expressly provided above; and under no circumstances shall American Audio® be liable for any loss or damage, direct or consequential, arising out of the use of, or inability to use, this product.

G. This warranty is the only written warranty applicable to American Audio® Products and supersedes all prior warranties and written descriptions of warranty terms and conditions heretofore published.

Model: M1624FX**POWER SUPPLY:**

AC 115v~60Hz/230v~50Hz

Single Voltage:

AC 100V, 50/60Hz (Japan);

AC 110V, 60Hz (Colombia)

AC 120V, 60Hz (U.S.A. and Canada);

AC 127V, 60Hz (Mexico)

AC 220V, 50Hz (Chile and Argentina);

AC 240V, 50Hz (Australia)

AC 220V, 60Hz (Philippines and Korea)

AC 230V, 50Hz (Europe, U.K., New Zealand, South Africa, and Singapore)

DIMENSIONS:

420mm (W) x 436mm (D) x 90mm (H)

16.5" (W) x 12.9" (D) x 3.54" (H)

WEIGHT:

10.1 Lbs. / 4.6 Kgs.

POWER CONSUMPTION:

36W

OPERATING TEMPERATURE:

5 to 35 deg. C; Humidity: 25 to 85% RH

(non-condensing); Storage Temperature: -20 to 60 deg. C

MAXIMUM OUTPUT LEVEL (0.5% T.H.D. AT 1kHz):

+26dB (Main L/R), +20dB (ALT 3/4, Aux/EFX, & Control Room)

+20dB (Insert), More than 100mW (Headphones) @ 33Ω

FREQUENCY RESPONSE:

20Hz ~ 20kHz, +1/-2dB (Mix L/R, ALT 3/4, Aux/EFX Send, & Control Room)

T.H.D. (Total Harmonic Distortion):

<0.1% @ +14dB 20Hz ~ 20kHz (Mix L/R, ALT 3/4, Aux/EFX Send, & Control Room)

MAXIMUM VOLTAGE GAIN:**MIC IN to MAIN L/R:**

74dB

MIC IN to ALT 3/4:

74dB

MIC IN to AUX (PRE):

66dB

MIC IN to AUX (POST):

76dB

MIC IN to EFX (REV):

76dB

MIC IN to CONTROL ROOM L/R:

80dB

MIC IN to REC L/R:

52.2dB

LINE IN to MAIN L/R:

54dB

LINE IN to ALT 3/4:

54dB

LINE IN to AUX (PRE):

46dB

LINE IN to AUX (POST):

56dB

LINE IN to EFX (REV):

56dB

LINE IN to CONTROL ROOM L/R:

60dB

STEREO IN to MAIN L/R:

44dB

STEREO IN to ALT 3/4:

44dB

AUX RETURN IN to MAIN L/R:

16dB

TAPE IN to MAIN L/R:

20dB

HUM AND NOISE [(AVERAGE RS = 150Ω) (Master Fader At Nominal Level & All Channel Faders At Minimum)]:**MIX L/R, ALT 3/4, AUX/EFX SEND, CONTROL ROOM OUT:** -127dB Equivalent Input Noise, -95dB Residual Noise**MIX L/R, ALT 3/4, AUX/EFX SEND, CONTROL ROOM OUT:** -88dB**CHANNEL INDICATORS:****PEAK:** An indicator for each channel turns on when the pre-channel fader signal is 5dB below clipping.**INTERNAL DIGITAL EFFECT:**

100 Selectable Presets/Foot Switch Controlable

LED METERS:

10-Segment LEDx2, Main L/R, ALT 3/4, PFL, & Tape IN

INPUT CHANNEL EQ:

HIGH: 12kHz Shelving
MID: 2.5kHz Peeking
LOW: 80Hz Shelving
TURNOVER/ROLL OFF FREQUENCIES: Located 3dB Below Maximum Boost/Cut

GAIN CONTROL (MONO/STEREO COMBINATION INPUT CHANNEL): 40dB Variable (-20dB ~ +20dB)

GAIN CONTROL (MONO INPUT CHANNEL): 44dB Variable (-50dB ~ +6dB), (-30dB ~ +14dB)

CROSSTALK (at 1kHz): -70dB Between Input Channels,
 -70dB Between Input/Output Channels

-INPUT

Input Connector	Input Impedance	Nominal Impedance	Rated Input Level	Connector Type
CH Mic	4kΩ	50 ~ 600Ω	-50dB	XLR 3-31 Type Balanced
CH Line	10kΩ	600Ω	-30dB	Phone Jack (TRS) T = Hot R = Cold S = GND
Stereo Input Mic	3kΩ	600Ω	-44dB	XLR 3-31 Type Balanced
Stereo Input	5kΩ	600Ω	-20dB	Unbalanced Phone Jack
Mono Channel Insert Input	10kΩ	600Ω	0dB	Phone Jack (TRS) T = Out R = In S = GND
Tape In	10kΩ	600Ω	-10dBV	RCA pin Jack

-OUTPUT

Output Connector	Output Impedance	Nominal Impedance	Rated Output Level	Connector type
MIX Out L/R	240Ω	20KΩ	+4dB	Balanced Phone Jack
ALT 3/4	75Ω	10KΩ	+4dB	Unbalanced Phone Jack
CTRL Room Out	75Ω	10KΩ	+4dB	Unbalanced Phone Jack
Aux Send	75Ω	600Ω	+4dB	Unbalanced Phone Jack
Mono Channel Insert Input	600Ω	10kΩ	0dB	Phone Jack (TRS)T = Out R = In S = GND
Rec Out	600Ω	10kΩ	-10dBV	RCA pin Jack
Phones Out	100Ω	33Ω	3mW	Stereo Phone Jack

©American Audio® World Headquarters:
6122 S. Eastern Ave. Los Angeles, CA 90040 USA
Tel: 323-582-3322 Fax: 323-582-2941
Web: www.americanaudio.us E-mail: info@americandj.com

American DJ Europe
Junostraat 2
6468 EW Kerkrade
Netherlands
service@americandjeurope.com / www.americandjeurope.com
Tel: +31 45 546 85 00 / Fax: +31 45 546 85 99

Free Manuals Download Website

<http://myh66.com>

<http://usermanuals.us>

<http://www.somanuals.com>

<http://www.4manuals.cc>

<http://www.manual-lib.com>

<http://www.404manual.com>

<http://www.luxmanual.com>

<http://aubethermostatmanual.com>

Golf course search by state

<http://golfingnear.com>

Email search by domain

<http://emailbydomain.com>

Auto manuals search

<http://auto.somanuals.com>

TV manuals search

<http://tv.somanuals.com>