

H S 3 1 5

# **User Manual**

## **HS315**

### **Digital Enhanced Cordless Communications**

Depending on different models, not all features may be available in this general manual.

## Contents

---

Introduction.....	3
Physical Details.....	5
What the symbols mean.....	7
Setting up your telephone.....	8
Installation.....	9
Important safety information .....	12
Making and Answering Calls .....	13
Call Waiting .....	15
Conference Calling.....	16
Phone Book.....	17
Call Lists .....	19
Settings .....	21
Extra Setting.....	28
Skype Function .....	29
Resetting the system.....	30
Intercom and transfer.....	30
Troubleshooting .....	31
Technical details.....	35
Declaration of conformity .....	36

# Introduction

---

## Overview

Thank you for purchasing our Skype DECT product. We hope that you spend many happy hours using it and chatting with Skype! With the HS315 you can make ordinary telephone call and Internet calls using Skype™ and SkypeOut.

- An ordinary telephone call is a call between two telephone line subscribers.
- A Skype™ call is between two registered Skype™ users. These calls are free of charge.
- A SkypeOut call is made via the Internet to an ordinary telephone number anywhere in the world using the Skype™ software.

This user manual will help you get the most out of handling the different calls and learning how to navigate the handset menu.

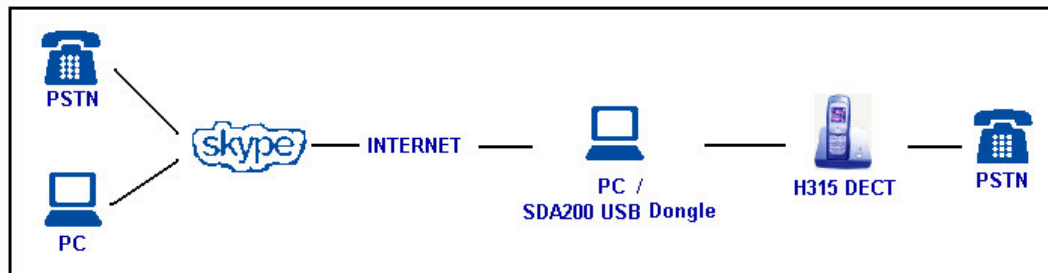

## Minimum System Requirements

Before continuing any further with the installation please make sure you have the minimum system requirements as specified here:

- Broadband Service
- PC with the following minimum specifications:

Pentium 400Mhz processor (CPU) or above  
PC running **Microsoft Windows® 2000® or XP®**  
Available USB Port (USB2.0 or USB1.1)  
Skype® version 1.2 or higher (visit [www.skype.com](http://www.skype.com))  
128Mb RAM, 256Mb RAM recommended  
10Mb Hard Disk space  
CD drive for software Driver

## Package Content

The contents of your product should contain the following items. For any missing items, please contact your dealer immediately.



**USB Dongle**



**DECT**



**CD Installation**



**Power adapter  
(AC 7.5V, 350mA)**



**Telephone Cable (RJ-11)**



**Battery Cell  
(1.2 x 2V 750 mAh)**



**Quick Start Guide**



**Note:** To make Internet calls your PC must be turned on and the Skype™ software must be activated.

## Physical Details

### The Handset and Base Unit

#### Left Key

Press to enter menu and sub-menu mode;  
Press to confirm selection;  
With the key “\*” to lock or unlock the keypad;  
Press during a call to mute the mouthpiece.

#### Call / Recall Key

Press to begin and answer a telephone call.  
You can activate Recall function if your phone is connected to a PABX, or if you use Select Services.  
Press to transfer an outside call to another phone.

#### Scrolling Button

Press during programming to move through the menu;  
Press during a call to change the volume in the earpiece.

#### Speakerphone Key

Press to turn the speakerphone ON/OFF

#### Right Key

Press to enter phonebook menu;  
Press during programming to go back to the previous option; Press to clear digits from the display.

#### End /On-Off Key

Press to end a telephone call.  
Press and hold 2-3 seconds to switch the handset on / off ;

#### INT Key

Press to make an intercom call (if you have more than one handset).

#### In Use Light

The IN USE light comes on when you have a connection to the telephone line.

#### Charge Light

The CHARGE light comes on when the handset's batteries are being charged.

#### Handset Locator Button

Press this to make the handset ring, if you cannot remember where you put it, press it again to stop the handset ringing.

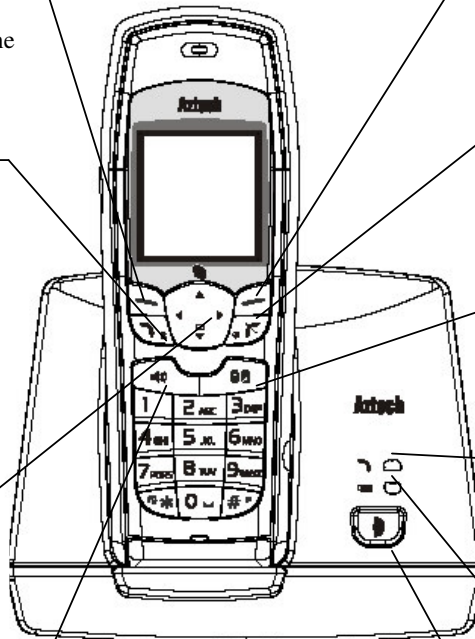

Note: Before you can use the handset to make calls for the first time, you will need to fit and fully charge the batteries for 15 hours.

## The USB dongle

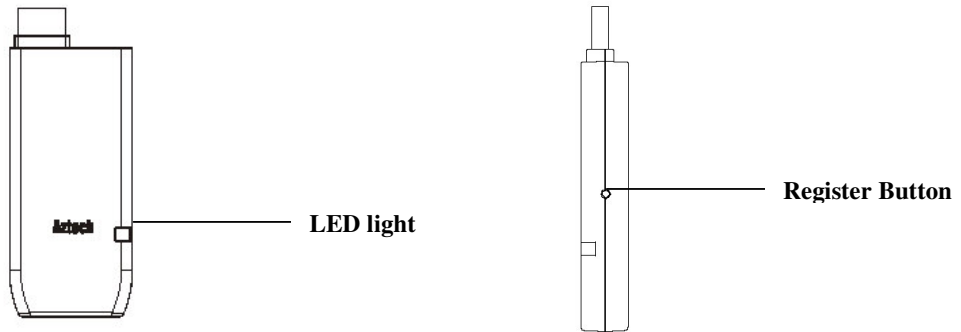

## What the symbols mean

---

### **Batteries Charge Level**

Whenever this shows 'nearly empty' () , put the handset on the base unit to charge the batteries. While the batteries are being charged, the level shown will keep changing.

### **Mute**

Your handset's microphone is muted.

### **Signal Level**

Shows the signal between the handset and base unit, and disappear when you are out of range of the base unit.

### **Speakerphone**

Your handset's loudspeaker is on.

### **Lock**

Your handset's keypad is locked.

## Setting up your telephone

---

### Connection and conditions for use

You can connect your HS315 to a direct exchange line (DEL), a line connected to a local exchange, with its own phone number; to an extension socket connected to a DEL; or to an extension on an approved compatible PBX. Do not connect the HS315 as an extension to a payphone.

### How many phones can you connect?

The ringer equivalence numbers (RENs) of all instruments (phones, fax machines, etc.) connected to an exchange line must not add up to more than 4, otherwise, one or more of them may not ring and/or answer calls correctly. The HS315 has a REN of 1, and most other telephones have a REN of 1 unless marked otherwise.

### Radio signals between handset and base unit

To use your handset and base unit together, you must be able to establish a radio link between them. Be aware that:

- Sitting the base unit as high as possible will give better results, in a two-storey house, the best position may be on the first-floor landing.
- Any large metal object, like a fridge, a mirror or a filing cabinet, between the handset and base unit may block the radio signal.
- Other solid structures, like walls, may reduce the signal strength.

### Choosing a site for the base unit

The base unit should be placed on a level surface, in a position where:

- The mains adapter plug will reach a 230 V AC switched mains supply socket; never try to lengthen the mains power cable.
- The telephone cable will reach your telephone line socket or extension socket.
- It is not close to another telephone, this can cause radio interference.
- It is not close to a sink, bath or shower, or anywhere else where it might get wet.
- It is not close to other electrical equipment, fridges, washing machines, microwave ovens, TVs, fluorescent lights, etc.



## Installation

### 1. Choose a suitable site for the base unit

Make sure it is not near to another telephone, nor to other electrical equipment.

### 2. Plug the mains power lead and the telephone line cord into the bottom of the

### 3. Plug the mains adapter into a 230 V AC, 50 Hz mains socket with the switch on the socket set to OFF.

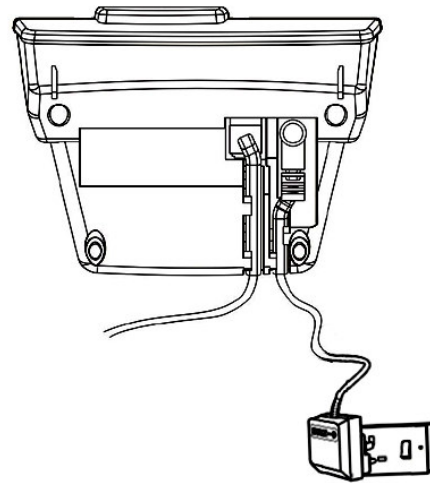

*Note: The illustration of adaptor may vary from country to country.*

### 4. Switch on mains power at the socket

### 5. Fit the batteries in the handset(s)

Insert the batteries cell following the batteries polarity indication.

Push the latch inwards, and then slide the cover until it clicks firmly into position.

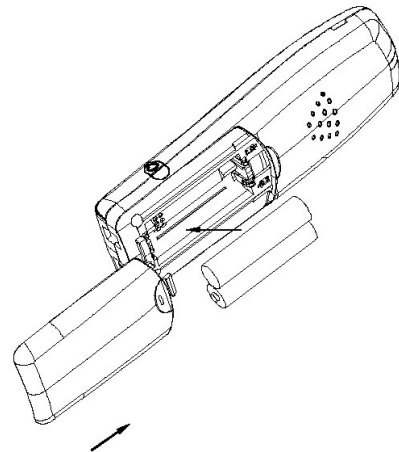

**6. Connect the base unit to telephone wall socket by a telephone line**

**7. Plug the USB dongle into your PC USB socket**

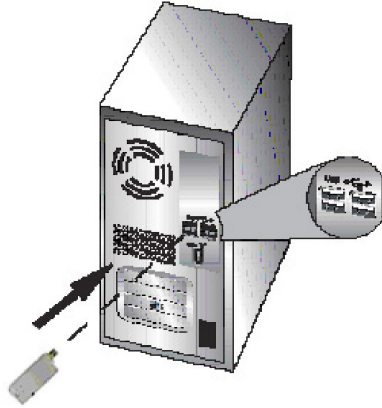

 **Note:** Your HS315 is supplied with the handset and USB dongle already registered to the base unit; you shouldn't need to register them. Refer to Settings section of this manual for the information on how to register.

**8. Download the latest version of Skype from [www.skype.com](http://www.skype.com)**

This is a Windows-based installation. If you have previously installed the Skype software, proceed to the next step.

**9. Mount the CD-ROM provided into your PC CD ROM Drive and install the program**

First insert the CD ROM into your PC CD ROM Drive the setup should now start automatically, the installation CD Graphic User Interface will appear on your screen. The system will prompt you to follow the screen instructions to start and process the installation.

After a successful install, you will find an icon namely **Aztech Skype DECT** saved onto the location you choose to save the file and a short cut icon appears on the desktop.





**Note:** The Skype software must be activated manually on your PC before you place SkypeOut and Skype™ calls every time.

Recommended disable your PC from entering sleep mode to ensure the availability of Skype communication.

**Congratulations! The installation procedure is now complete. If you experience any problems on using this phone, refer to the Troubleshooting section elsewhere in this guide.**

## Important safety information

---

This equipment is not designed for making emergency calls in the event of a power failure. Alternative arrangements should be made for access to emergency services. (This means that you should also have a basic phone that does not need mains power, connected to your line so that you can make calls during a power failure)

People with a heart pacemaker should consult their doctor before using the telephone.

If you wear a hearing aid, you should note HS315 works by transmitting radio waves between base and handset that may cause a humming noise.

1. **DO NOT** clean any part of your phone with benzene, thinner or other solvent chemicals, which may cause permanent damage to your phone. This damage is not covered by the Guarantee. When necessary, clean it with a damp cloth. Cleaning it with a wet cloth may give you an electric shock.

2. **DO NOT** use this equipment in places where volatile or explosive materials may be present.

3. **DO NOT** let the base unit get wet. Electrical equipment can cause serious injury if used while you are wet or standing in water. NEVER use your phone during a thunderstorm. Unplug the base unit from the telephone line and the mains socket when there are storms in your area. Damage caused by lightning is not covered by the Guarantee.

4. The HS315 will produce a certain amount of heat during operation. For this reason it is recommended that this equipment is **NOT** placed in direct contact with antique, veneered or delicate furniture surfaces.

5. **DO NOT** dispose batteries with normal household waste, never burn them, or put them where they could get punctured.

6. The HS315 DECT phone emits radio signals which could interfere with other electronic equipment, computers, radio, TV set, clock radio alarms, etc. A distance of at least one meter should be maintained between HS315 base station and other equipment. This will minimize the risk of such interference.



7. When you do not need to carry your handsets around, leave them on the base unit or charger pod, to keep the batteries charged.

8. If you hear a warning tone as move around during a call, and/ or the sound in the earpiece becomes faint or distorted; you may be going out of range of the base unit. Move nearer to the base unit within 20 seconds, until the tone stops. Otherwise your call may be cut off.

## Making and Answering Calls

 **Note:** In standby mode, press any button on keypad except “Talk” button to make the backlight come on before enabling any function. (It means 1<sup>st</sup> press to turn on the backlight, 2<sup>nd</sup> press to activate the function button. This is correct for all buttons except for “Talk” button.)

### To Make an Ordinary Call

- Enter the telephone number and press Call  key to place call;
- If you make a mistake, press Right  key to delete incorrect digits, before you press Call  key.

### To Make a SkypeOut Call

SkypeOut allows you to use your Internet connection to call ordinary telephones and mobile telephones worldwide. Requires the Skype Out service from Service Provider for landline calls first.

- Enter the telephone number you wish to call and the symbol “**SkypeOut**” appears on the left bottom of display, then press Left  key to place call.



 **Note:** The Skype software must be activated on your PC in order to perform SkypeOut and Skype™ calls. To perform SkypeOut calls you also need to set up a user account and top up with call credit at [www.skype.com](http://www.skype.com)

 **Note:** For SkypeOut Calls, there is no prefix required, such as “+” or “00”. The country or area code is dialed first, followed by the phone number. For example, to call the number “97246744” in Singapore, where the country code is “65”, you can dial 65 9724 6744 directly.

User can also make SkypeOut call from **Call List**, **Phonebook** and **Skype**. For the further operation, refer to Call List, Phonebook and Skype sections elsewhere of this manual.

## To Call a Skype™ User

Make sure the Skype™ user is available in your Skype net Contact list and is online. Otherwise, add the online Skype™ user name you wish to call to the Contacts list of Skype net fist. It will automatically appear in your phone's Skype list. To call a Skype™ user:

1. Press Scrolling  button up to enter Skype mode directly, the display shows the stored names;
2. Press Scrolling  button up / down to select the name you wish to contact;
3. Press Call  key to make call;



## To Answer a Call

1. When the handset and base unit ring, press the Call  key to answer call.
2. When the AUTO TALK is turned on, you can simply answer the call by lifting the handset from the base unit (see *AUTO TALK part*).



## To End a Call

- Press End  key to hang up.

## To Dial a Number from Call Logs

1. Select <Missed Calls>, <Received Calls> or <Dialed Calls> under *CALL LISTS* mode;
2. Press Left  key, the display shows these calls;
3. Select the telephone number you want to call, then press the Call  key to make call



## To Redial a Call

- In standby mode, press and hold the Call  key to enter the dial list, and press the Scrolling  button to scroll through the number you want to dial, then press the Call  key to redial.

## Earpiece Volume

- During a call, you just press Scrolling  button up/down to adjust the volume of the earpiece (0-9 level).

### To Mute the Mouthpiece



1. During a call, press Left  key once to mute the mouthpiece;
2. While the mouthpiece is muted, you cannot press any number key to send digits down the line;
3. Press Left  key again to get back to the Call.

## Call Waiting





---





HS315 DECT has a Call Waiting feature that works with Caller ID service from your telephone service operator. When you're engaged on a PSTN ongoing call, if you receive a second Skype call, your phone will use a call waiting signal to let you know another call is ringing in. This way, you can switch between Skype and PSTN callers, hook down Skype call or even make Skype conference call together.

### To Hook down / up the Second Call (Skype Call)







1. When you already engaged on an ongoing call, if another Skype call is received, press Right  key to enter option menu;
2. Then press Scrolling  button to select *Hook up / Hook down*;
3. Press Left  key to confirm.

### To Toggle between Skype call and PSTN call

1. When you already engaged on an ongoing call, if another Skype call is received, press Right  key to enter option menu;
2. Then press Scrolling  button to select *Hook up* and press Left  key;
3. Press Right  key to enter option menu again;
4. Press Scrolling  button to select *Switch*;

5. Press Left  key to toggle the phone connection. (If you want to hook down the Skype call, press Right  key to enter option and Scrolling  button to select *Hook down*, then press Left  key)

### **To Make a Skype Conference Call:**

1. When you already engaged on an ongoing call, if another Skype call is received, press Right  key to enter option menu;
2. Then press Scrolling  button to select *Hook up* and press Left  key;
3. Press Right  key to enter option menu again;
4. Press Scrolling  button to select *Conference Call*;
5. Press Left  key to connect the three parties together.

 **Note:** You cannot host a conference call by yourself but can be invited to participate in a conference call opened by the other Skype users.

## **Conference Calling**

You need to register with your fixed line network operator for conference calling service. It is dependant on service availability and subscription.

### **To Make an Ordinary Conference Call:**

1. Connect the first party;
2. Press INT  key, and the first party is put on hold;
3. Dial second party's phone number;
4. When connected, press and hold “#” button to connect the three parties together.

 **Note:** Refer to Call Waiting section for how to make Skype Conference Call.



## Phone Book

---





Up to 50 records could be stored in each handset's Phone Book. Each record can store up to 20 digits, and names of up to 10 characters. In standby mode, press Right  key, and the display shows phonebook list.

### To Enter Phone Book mode:

There are two ways to enter Phone Book mode as following:





- Select *Phonebook* under menu mode.
- Press Right  key to enter *Phonebook* mode directly.

### To Store New Number into Phonebook









1. In standby mode, press Right  key, the display shows the stored number;
2. Press Left  key, and goes to the location *New Entry*;
3. Then press Left  key again, and key in the name;
4. Press Left  key to confirm, and key in the number;
5. Now press Left  key to store it.

### To Delete a Number or All Numbers from Phonebook

1. Under Phonebook mode, press Scrolling  button to scroll through the stored numbers;





2. Select the number you want to delete, then press Left  key, then Scrolling  button till to the location *Delete*;
3. Now press Left  key to delete current number or all numbers; the display shows *Delete?* ;
4. Press Left  key to delete the number/numbers.

### To Modify (Change) a Number in Phonebook

1. Under Phonebook mode, press Scrolling  button to scroll through the stored numbers;
2. Select the number you want to modify, then press Left  key, then Scrolling  button to the location *Edit Entry*;
3. Press Left  key to confirm, and Right  key to clear the old name, then key in the new name;
4. Press Left  key to save the edit, also goes to the stored number; press Right  key to clear the old number and key in the new number;
5. Then press Left  key to save the change



### To Check Memory

You can use this feature to see how many of your Phone Book's 50 locations have been not used.

1. In standby mode, press Right  key, enter Phonebook mode, the display shows the stored numbers;
2. Press Left  key and Scrolling  button to the location *memory*;
3. Press Left  key, the display shows “ **n** Free”.

### To Make Skype Out Call from Phonebook

1. Under Phonebook mode, press Scrolling  button to select the call number you wish to call;

2. Press Left  key to enter *Option* menu, then Scrolling  button to the location *Skype out*;
3. Press Left  key to place Skype Out call.







## Call Lists

---



**You must subscribe to Caller ID service from your service provider to use this feature.**

Call Logs store information related to Received calls, Missed calls and Dialed calls. HS315 can store up to a maximum of 30 calls, consisting of 10 Received, Missed and Dialed calls respectively.

### To Check Call Records





1. Select *Call list* under menu mode;
2. Press Left  key again, the display shows *Received Calls, Dialed calls, Missed Calls, and Notifications*;
3. Select the calls type you wish to check by Scrolling  button, then press Left  key, the display shows these calls numbers;
4. Select one number, then press left  key, and Scrolling  button to the location *Show Details*;
5. Press Left  key, then the display shows the details of the call, including the call number, and the date and time the call is received, dialed or missed.

### To Save Call

1. See steps 1-3 above;
2. Select one number, then press Left  key and goes to the location *Save*
3. Press Left  key, and key in the name;
4. Press Left  key to confirm, and key in the number;



5. Press Left  key to store it.

### To Delete Call Records







1. See steps 1-3 above;
2. Select one number, then press Left  key and Scrolling  button to the location *Delete Current* or *Delete All*
3. Press Left  key, the display shows “Delete?”
4. Press Left  key to confirm.

### To Check Notification Alert

**You must subscribe to Notification service from your service provider to use this feature.**

1. Select *Call list* under menu mode;
2. Press Left  key again, the display shows *Received Calls*, *Dialed calls*, *Missed Calls*, and *Notifications*;
3. Press Scrolling  button to select *Notifications*, then press Left  key, the display shows the alert;

### To Make SkypeOut Call from Call List

1. Select *Call list* under menu mode;
2. Press Left  key again, the display shows *Received Calls*, *Dialed calls*, *Missed Calls*, and *Notifications*;
3. Select the calls-type from *Received Calls*, *Dialed calls*, *Missed Calls* by Scrolling  button, then press Left  key, the display shows these calls numbers;
4. Select one number you wish to call, then press left  key, and Scrolling  button to the location *Skype Out*;
5. Press Left  key to place Skype Out call.



## Settings

---





### To Enter Handset Settings Mode

1. Select *Settings* under *menu* mode;
2. Press Left  key, select *Handset set* under *Setting* mode; the display shows *Wall Paper, Ringer Set, Auto-talk, Handset Name and Language*;





### To Set Wall Paper

1. Select *< Wall Paper >* under *Handset Set* mode;
2. Press Left  key to confirm, and press Scrolling  button to scroll through the pictures;
3. Choose the picture you prefer, and then press Left  key to confirm, now the picture is set to the wallpaper of the handset.

### To Set External/Internal Ringer Volume (1 -5 level)





1. Select *< Ringer Set >* under *Handset Set* mode;
2. Press Left  key to confirm, then Scrolling  button to the location *ExternalVo/InternalVol*;
3. Press Left  key and Scrolling  button to choose the volume level you want to set;
4. Then press Left  key to confirm the choice.

### To Set External/Internal Ringer Melody (1-9 melody)



1. Select *< Ringer Set >* under *Handset Set* mode;
2. Press Left  key to confirm, then Scrolling  button to the location *ExternalRing / InternalRing*;
3. Press Left  key and Scrolling  button to choose the ring melody you want to set;
4. Then press Left  key to confirm the choice.

## To Set Key Tone On/Off



Each time you press a key on your handset, you hear a tone. You can turn this off if needed.



1. Select <Ringer Set> under *Handset Set* mode;
2. Press Left  key to confirm, then Scrolling  button to the location *Key Beep*;
3. Press Left  key and Scrolling  button to set the key beep ON/OFF;
4. Press Left  key to confirm.

## Auto Talk Function



Normally, you need to press the Call  button to answer an incoming call. But with *AUTOTALK* function turned on, when your handset is ringing for an incoming call, you can answer the call by simply lifting the handset from the base unit without pressing the Call  button.

## To Set Auto-Talk Function ON/OFF



1. Select <Auto-talk> under *Handset Set* mode;
2. Press Left  key, and Scrolling  button to set Auto-talk ON/OFF;
3. Then press Left  key to confirm;

 **Note:** If you have turned Auto-talk on, do not press the Call  button after you've answered a call by lifting the handset, otherwise, you'll disconnect the call.

## To Set Handset Name



1. Select <Handset Name> under *Handset Set* mode;;
2. Press Left  key to confirm;
3. Key in your chosen name;
4. Then press Left  key to confirm;

## To change Handset Name

1. Select <Handset Name> under *Handset Set* mode;;
2. Press Left  key to confirm, the display shows the current name;
3. Press and hold the Right  key to clear the old name, then key in the new name;
4. Press Left  key to confirm to the change.

## To Set Language

You can select the language from the menu up to your preference.

1. Select <Language> under *Handset Set* mode;
2. Press Left  key and Scrolling  button to choose the language you prefer;
3. Then press Left  key to confirm the setting



## To Lock /Unlock the Keypad

- Press Left  key and “ \* “ button consecutively to lock/unlock the keypad.



## To Enter Base Settings Mode

1. Select *Settings* under *menu* mode;
2. Press left  key select *Base Settings* and the display shows *Ringer Settings*, *Dial Settings*, *Call Barring*, *LCR*, *PIN* and *Default Settings*.

## To Set Base Volume (0-4 volume level)



1. Select <Ringer Settings> under *Base Settings* mode;
2. Select <Ringer Volume> under *Ringer Settings*;
3. Press Left  key and Scrolling  button to set the volume you like;
4. Press Left  key to confirm.

## To Set Base Melody (1-9 melody)

1. Select < *Ringer Settings* > under *Base Settings* mode;
2. Select < *Ringer Melody* > under *Ringer Settings*;
3. Press Left  key Scrolling  button to set the melody you prefer;
4. Press Left  key to confirm.



## To Set Flash Time

You can change flash time to short or long.

1. Select < *Dial Settings* > under *Base Settings* mode;
2. Select < *Flash Time* > under *Dial Settings*;
3. Press Left  key and Scrolling  button to change Flash Time to Long or Short;
4. Press Left  key to confirm

## To Set Auto Pause

When you call a number with a pause, the phone waits a few seconds before transmitting the next digits in the dialing sequence. This is useful when you have to dial a number for access to an outside line, or for going into a voicemail system. You are allowed to set one number in Auto Pause



1. Select < *Dial Settings* > under *Base Settings* mode;
2. Select < *Auto Pause* > under *Dial Settings*;
3. Press Left  key, then key in PIN (default 0000)
4. Press Left  key, then key in the number you want to set auto pause;
5. Press Left  key to confirm.

## To Set Dial Mode

You can change dial mode to TONE or PULSE dialing.

1. Select < *Dial Settings* > under *Base Settings* mode;





2. Select <Dial Mode> under *Dial Settings*;
3. Press Left  key and Scrolling  button to change dial mode as TONE or PULSE;
4. Press Left  key to confirm.





## Call Barring Function

Call barring enables you to restrict or bar certain types of calls from your phone.

### To Set Call Barring Number

1. Select < Call Barring> under *Base Settings* mode;
2. Select <Barring Number> under *Call Barring*;
3. Press Left  key, then key in the PIN (the default PIN is 0000);  
The display shows the numbers from 1 to 5 (the maximum call barring numbers you can set)
4. Press Left  key and then key in the telephone number you want to set call barring.
5. Press Left  key to confirm.





### To Delete Call Barring Number

1. See 1-3 step above, press the Scrolling  button to select the call barring number you want to delete;
2. Then press Left  key, the display shows the call barring number you set;
3. Press and hold Right  key to clear the number;
4. Press Left  key to confirm.





## Least cost route (LCR) function (Optional)

With the LCR function, the phone will automatically replace a long number with a comparative short number, to simplify the process of dialing a long number. For example, if the user program to replace "00" with "1790900", then when he dials "006567417211", then the phone will automatically replace the number to be dialed out as "17909006567417211".



## To Set LCR

1. Select <LCR> under *Base Settings* mode;
2. Press Left  key, and key in the PIN;
3. Press Left  key, then key in the SHORT number that you want to replace the long number;
4. Press Left  key to confirm, then key in the LONG number;
5. Press Left  key to confirm.

## To Change Base PIN

1. Select <PIN> under *Base Settings* mode;
2. Press Left  key, and key in the original PIN (default PIN:0000) number;
3. Then press Left  key to confirm, and key in New PIN;
4. Press Left  key, then key in New PIN again;
5. Press Left  key to confirm.

## Default Settings

1. Select <Default settings> under *Base Settings* mode;
2. Press Left  key, and key in the current PIN number;
3. Press Left  key to confirm, you will hear a beep, then all features will return to their default settings.

The following default settings are for you reference:

- 1). Reset Flash time to Long,
- 2). Delete call barring number.
- 3). Reset master pin number to 0000.
- 4). Reset ringer melody and volume.
- 5). Dial mode reset to Tone.
- 6). Remove Auto Pause number.
- 7). Remove LCR (if available).





## Registration

Your HS315 is supplied with the handset and USB dongle already registered to the base unit; you shouldn't need to register them. But if you've bought extra handset, you'll need to register each one to your original base unit. Maximum 3 handsets can be registered to one base.

### To Enter Registration Mode



1. Select *Settings* under *menu* mode;
2. Press Left  key, select *Registration* and the display shows *Select Base, Base Sub* and *De-register*.

### To register a handset

1. Press and hold the **Handset locator** button on the base unit for a while, until you hear "beep" sound twice continuously;
2. Select *Base Sub* under *Registration* mode;
3. Press Left  key again  
The display shows *BASE 1; BASE 2; BASE 3; BASE 4*;
4. Press Scrolling  button to scroll through the base, and press Left  key, then enter base PIN, and press Left  key to confirm;
5. After a while, when the handset finds the base unit, it goes back to the standby mode.

### To de-register a handset

You may need to do this if you have more than one handset registered to your base unit and you need to replace a faulty handset.

1. Select *<de-register>* under *REGISTRATION* mode.
2. Press Left  key, then key in the PIN (default 0000).
3. Press Left  key, then key in the number of the handset you want to de-register.
4. Press Left  key to confirm.



**Note:** You cannot de-register the handset you are currently using.





## To register a USB dongle

1. Press and hold the **Handset locator** button on the base unit for a while, until you hear "beep" sound twice continuously;
2. Insert the USB dongle into your PC USB port;
3. Use a paper clip or a pencil tip to depress and hold the register button of dongle for 2~3 seconds, then release and you will hear a confirmation tone from Base unit.



## Extra Setting

---

### To Set Alarm Time



1. Select *EXTRA* under menu mode;
2. Select *< Alarm Set >* under *EXTRA* mode;
3. Press Left  key, then press Scrolling  button to goes to location *ON*;
4. Press Left  key, then key in the time;
5. Press Left  key to save;

### To Set Clock Time

1. Select *< Clock Set >* under *EXTRA* mode;
2. Press Left  key, then key in the time;
3. Press Left  key to save;



### To Set Date

1. Select *< Date Set >* under *EXTRA* mode;

2. Press Left  key, then key in the date;
3. Press Left  key to save;

## Skype Function

### To Make Skype Call from Contact List







1. Select *Skype* under menu mode;
2. Select < *Contact List* > under *Skype* mode;
3. Press Left  key, then the display shows the Skype online user list;
4. Press Scrolling  button to select the record you wish to call;
5. Press Call  key to place a Skype call.





**Note:** Press shortcut key Up-button in the scrollbar to enter the Skype contact list directly or use above steps.

**Quick Search:** This function enables you to speed search the list by inputting the initial letter or number of the list you look for. For example, if you would like to search a user namely “Linda” in your contact list, press “5” key, and then “J K L j k l 5” box will be displayed on the screen. Press “5” key continuously until you select “L”. Then it would perform search for you.

### To Make Skype Call from Skype Calllogs

1. Select *Skype* under menu mode;
2. Select < *Skype Calllogs* > under *Skype* mode;
3. Press Left  key, then the display shows the Skype Calllogs indicating the Online Status of these users. Received Skype call marked with “”, Dialed call marked with “”, and Miss call marked with “”.
4. Press Scrolling  button to select the record you wish to call;
5. Press Call  key to place a Skype call.

## To Set User Status

1. Select *Skype* under menu mode;
2. Select *< User Status >* under *Skype* mode;
3. Press Left  key, then the display shows the selection status;
4. Press Scrolling  button to select the status you wish to set;
5. Press Left  key to save.

## Resetting the system

---

If you have set a PIN and forgotten it, you need to reset the system. The PIN will be reset to 0000. If you reset the system, you will lose all stored information (including numbers in memory) and all features will return to their default settings. You need to register the handset to the base unit again.

While you are resetting the system, you should disconnect the telephone line cord from the back of the base unit, so you won't be interrupted by incoming calls. To reset the system without the PIN:

1. Disconnect the power lead from the back of the base unit
2. Press and hold the **HANDSET LOCATOR**  button in the base unit, at the same time connect the power lead into the back of base unit. Release the **LOCATOR** button after you hear “beep” sound for five times. The IN USE light on base unit lights during this whole process.
3. After 2~3 seconds, you can hear “beep” sound for two times again and the IN USE light goes off;
4. Disconnect the power lead from base. Reconnect and you will hear a confirmation tone from the base unit.

## Intercom and transfer

---

### To Make an Intercom Call



1. Press the INT  key. You hear Dial tone

2. Key in the number of the other handset

On the other handset's display, your number appears, and the **INT** symbol flashes. Then the other handset user presses the Call  key to connect the call.

For details of how to change the ringing melody and volume for intercom calls, see "INT MELODY" and "INT VOLUME" under "HANDSET SETTING" part.

## To End an Intercom Call



- Press the Call  key on your handset. The other person will hear Busy tone, and also need to press the End  key to hand up.

## To Transfer a Call

**To transfer the outside call to another handset** (if you have two or more handsets):

1. Press the INT  key and key in the number of the other handset.
2. The outside call is put on hold. When the other handset answers, you can speak to the user. If the other handset does not answer, you can get back to the outside call by pressing the INT button again.

**To transfer the outside call to another outside phone (Network Depending):**

1. Press the Recall  key and key in the call number you want to transfer.
2. The outside call is put on hold. When the call answers, you can speak to the user, then press the End  key to hang up and transfer the call.

## Troubleshooting

---

### Always check first that:

- You have followed the steps listed on pages to install and set up your HS315.
- All connects are firmly inserted in their sockets.
- Mains power is switched on at the socket.
- The handset's batteries are correctly and securely installed, and are not run down.

If you experience difficulties with the working of your HS315, refer to the advice given below.

**After mount the CD-ROM provided into your PC CD ROM Drive, the installation does not auto run.**

Look for the CD-ROM icon namely **HS-315** under PC “My computer” and double click to enter the installation interface manually and select the setup icon.

Click My computer > HS-315 > setup

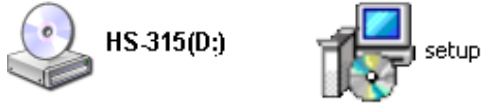

The installation CD Graphic User Interface will appear on your screen as following:

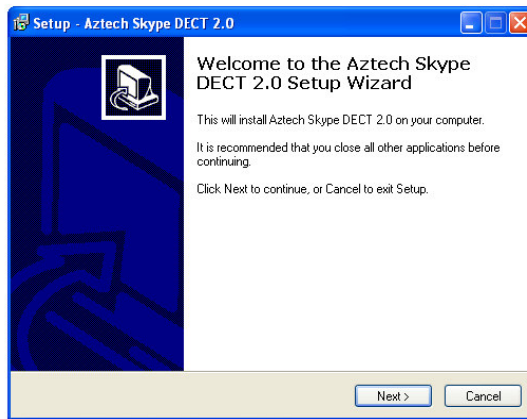

Please follow the setup in the wizard and the driver should be able to install successfully.

If you still can't enter the installation interface, please check whether the CD-ROM or PC CD ROM Drive is broken. If yes, contact your supplier immediately.

**I cannot make or answer calls.**

Check that the base unit's mains power adapter is plugged in and power is switched on. The base unit needs mains power for normal operation of the phone-not just charging the batteries.

Make sure you are using the telephone line cable that was supplied with your HS315. Other telephone line cables might not work.

Move the handset closer to the base unit.

Check the batteries level symbol on the display. If it is low, replace the handset on the base unit or charger pod to recharge the batteries.

Switch off power at the mains socket, wait for a few seconds and then switch back on. This may solve the problem.



If you still can't make calls, try re-registering the handset.

**When I place Skype call, there is no sound.**

Check the network.

Check Skype interface by following way. Click Tools at the Skype interface menu bar and select <Options>. Then select <Sound Device> to enter configuration page. Select SDA200 in <Audio In>, <Audio Out> and <Ringing> dropdown menu. (After setting, headset cannot be use for communication).

**I cannot enter Skype Contact List**

Make sure Skype software is activated in your PC. If so, restart.

Check the connection between USB dongle and your PC and try to plug the USB dongle again.

**When I press keys on the handset, nothing happens.**

Make sure the batteries are fitted in your handset. If the batteries level symbol on the display shows "low", recharge the batteries.

Check whether there's a key symbol on the display. If so, the keypad is locked. Turn to the user manual to find out how to unlock it.

**When I press keys on the handset, digits appear on the display, but I can't make an outside call.**

Call barring may have been set, see the user manual for more information.

Try moving the handset closer to the base unit.

Try a different position for the base unit-perhaps higher, or further from other electrical equipment.

**The phone does not ring**

Check that the base unit's mains power adapter is plugged in and power is switched on. The base unit needs mains power for normal operation of the phone-not just charging the batteries.

Make sure you are using the telephone line cable that was supplied with your HS315. Other telephone line cables might not work.

Check that you have set the ringer volume to off. See the user manual for more information.

Check that the total REN value of all equipment connected to your telephone line is no more than 3. Disconnect one or more telephones and see whether that helps.

**The base does not ring.**

Check that the base power is ON, and the base ringer is set ON.

Check that the line cord is correctly fitted and undamaged.

**The PC Sound comes out from incorrect Sound Card.**

It only happens if the PC installed two or more Sound Cards.

You can re-map the sound card devices by following way. Enter the <Control Panel> and select <Sounds and Audio Devices>. Choose the <Audio> Tab. And then you can re-map your sound card setting on the Sound playback and Sound recording.

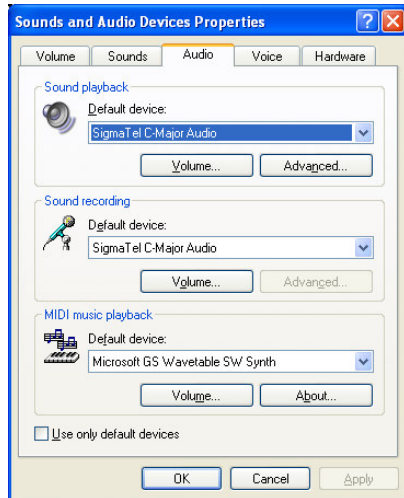

**The CHARGE light on the base unit does not come on."**

Check the handset is properly stationed.

Check the connections between the base unit and mains power socket.

Clean the batteries charging contacts with a dry cloth.

**When I press the CALL button, I hear a loud noise.**

The strange noise is caused by interference. Disconnect the mains power lead from the back of the base unit, and then wait for 30 seconds before reconnecting it.

**There is 'beep' sound while I am on a call.**

You may be going out of range of the base unit. Move closer, or your call may be cut off.

Check the Batteries Level symbol on the display. If it is low, recharge the batteries.

**The Caller Display feature isn't working.**

You need to subscribe to the Caller Display feature from your service provider.

The caller may have withheld their number, or they may be calling from a network that does not transmit the Caller ID (for example, it may be an international call).

**The handset's batteries are running low within an hour or two.**

Before you used the handset for the first time, you should have left it on the base unit for up to 15 hours to charge the batteries fully.

You may need to replace the batteries.

**I cannot transfer a call.**

Make sure the other handset is within range of the base unit, and is not busy on a call.

Make sure you are keying in the correct number for the other handset.

**No display on LCD screen.**

Make sure the batteries have power.

**I cannot register handset to base**

Make sure the number of handset registered to base is less than 3.

Check that the base unit is not near other electrical equipment, such as TV or computer

## **Technical details**

---

Full DECT GAP Compatible system

Standard

Frequency range	1.88 to 1.9 GHz
Channel bandwidth	1.728 MHz
Modulation	GMSK
Operating range	Up to 300 m outdoors; Up to 50 m indoors
	Standby time: 90 hours Talking time: 10 hours

## Operating time

### Temperature range

Operating 0<sup>0</sup>C to 40<sup>0</sup>C  
Storage -20<sup>0</sup>C to 60<sup>0</sup>C

### Electrical power

Handset---one 1.2 x 2 V 750 mAh Ni-MH,  
Rechargeable battery cell  
Base unit---input 230 V AC, 50 Hz;  
output AC 7.5 V, 350 mA.

### PABX compatibility

Timed break recall: 100 ms for short flash;  
250 ms for long flash  
Pause length: 3 seconds.  
Signaling type: DTMF (dual-tone multifrequency)  
Pulse dialing

## Declaration of conformity

---

The HS315 complies with the essential protective requirements and objectives of:

- EC R& TTE Directive 1999/5/EC
- EC Low Voltage Directive 73/23/EEC
- EC EMC Directive 89/336/EEC

And conforms to the following relevant harmonized standards:

- TBR 10:1999
- TBR 22:1997
- TBR 38:1998
- EN 301406 V1.5.1:2003
- EN 301437 V1.1.1:1999
- EN 301489-01 V1.4.1:2002
- EN 301489-06 V1.2.1:2002
- EN 60950-1:2001



## Free Manuals Download Website

<http://myh66.com>

<http://usermanuals.us>

<http://www.somanuals.com>

<http://www.4manuals.cc>

<http://www.manual-lib.com>

<http://www.404manual.com>

<http://www.luxmanual.com>

<http://aubethermostatmanual.com>

Golf course search by state

<http://golfingnear.com>

Email search by domain

<http://emailbydomain.com>

Auto manuals search

<http://auto.somanuals.com>

TV manuals search

<http://tv.somanuals.com>