

Arcam AVR200 surround sound receiver
Ampli-tuner audiovidéo Arcam AVR200
Arcam AVR200 Surround-Sound-Empfänger

English

Français

Deutsch



ARCAM

Safety guidelines

Safety instructions

This product is designed and manufactured to meet strict quality and safety standards. However, you should be aware of the following installation and operation precautions:

1. Take heed of warnings and instructions

You should read all the safety and operating instructions before operating this appliance. Retain this handbook for future reference and adhere to all warnings in the handbook or on the appliance.

2. Water and moisture

The presence of electricity near water can be dangerous. Do not use the appliance near water – for example next to a bathtub, washbowl, kitchen sink, in a wet basement or near a swimming pool, etc.

3. Object or liquid entry

Take care that objects do not fall and liquids are not spilled into the enclosure through any openings. Liquid filled objects such as vases should not be placed on the equipment.

4. Ventilation

Do not place the equipment on a bed, sofa, rug or similar soft surface, or in an enclosed bookcase or cabinet, since ventilation may be impeded. We recommend a minimum distance of 50mm (2 inches) around the sides and top of the appliance to provide adequate ventilation.

5. Heat

Locate the appliance away from naked flames or heat producing equipment such as radiators, stoves or other appliances (including other amplifiers) that produce heat.

6. Climate

The appliance has been designed for use in moderate climates.

7. Racks and stands

Only use a rack or stand that is recommended for use with audio equipment. If the equipment is on a portable rack it should be moved with great care, to avoid overturning the combination.

8. Cleaning

Unplug the unit from the mains supply before cleaning.

The case should normally only require a wipe with a soft, damp, lint-free cloth. Do not use paint thinners or other chemical solvents for cleaning.

We do not advise the use of furniture cleaning sprays or polishes as they can cause indelible white marks if the unit is subsequently wiped with a damp cloth.

9. Power sources

Only connect the appliance to a power supply of the type described in the operating instructions or as marked on the appliance.

10. Power-cord protection

Power supply cords should be routed so that they are not likely to be walked on or pinched by items placed upon or against them, paying particular attention to cords and plugs, and the point where they exit from the appliance.

11. Grounding

Ensure that the grounding means of the appliance is not defeated.

12. Power lines

Locate any outdoor antenna/aerial away from power lines.

13. Non-use periods

If the unit has a stand by function, a small amount of current will continue to flow into the equipment in this mode. Unplug the power cord of the appliance from the outlet if left unused for a long period of time.

14. Abnormal smell

If an abnormal smell or smoke is detected from the appliance, turn the power off immediately and unplug the unit from the wall outlet. Contact your dealer immediately.

15. Servicing

You should not attempt to service the appliance beyond that described in this handbook. All other servicing should be referred to qualified service personnel.

16. Damage requiring service

The appliance should be serviced by qualified service personnel when:

- A. the power-supply cord or the plug has been damaged, or
- B. objects have fallen, or liquid has spilled into the appliance, or
- C. the appliance has been exposed to rain, or
- D. the appliance does not appear to operate normally or exhibits a marked change in performance, or
- E. the appliance has been dropped or the enclosure damaged.

Safety compliance

This product has been designed to meet the EN60065 international electrical safety standard.

Using this handbook

This handbook has been designed to give you all the information you need to install, connect, set up and use the Arcam AVR200 surround sound receiver. The remote control handset supplied with the equipment is also described.

It may be that the AVR200 has been installed and set up as part of your system installation by a qualified Arcam dealer. In this case, you may wish to skip the sections of this handbook dealing with installation and setting up the unit. Use the Contents list (on this page) to guide you to the relevant sections.

Safety

Safety guidelines are set out on the inside front cover of this handbook.

Many of these items are common sense precautions, but for your own safety, and to ensure that you do not damage the unit, we strongly recommend that you read them.

Contents

Safety guidelines	2
Safety instructions	2
Safety compliance	2
Using this handbook	3
Safety	3
Installation	4
Positioning the unit	4
Setting up the aerials	4
Connecting inputs	5
AVR200 back panel connections	5
Interconnect cables	5
Connecting outputs	7
Connecting to other equipment	7
Connecting to a power supply	7
Setting up	8
Using the On Screen Display (OSD)	8
Setup page	8
Input settings page	8
Channel balance page	9
Channel delays page	9
Speaker settings page	10
Using the AVR200	12
Front panel controls	12
Input selection	12
Using the tuner	14
Tuning to a station	14
Storing a preset	14
Deleting an unused preset	14
RDS: Radio Data System	14
FM Mute/Mono	14
Using the remote control	15
CR-340 remote control	15
Reference	16
Bi-wiring and bi-amping loudspeakers	16
Before you start	16
Bi-wiring your loudspeakers	16
Bi-amping your system	16
Troubleshooting	17
Technical specifications	18
Guarantee	19
On line registration	19

Manufactured under licence from Dolby Laboratories, Inc.

'Dolby', 'Pro Logic', 'Pro Logic II' and the double-D symbol are trademarks of Dolby Laboratories.

Copyright © 1992–1999 Dolby Laboratories, Inc. All rights reserved.

Manufactured under licence from Digital Theater Systems, Inc.

US Patent Number 5,451,942 and other world-wide patents issued and pending. 'DTS' and 'DTS Digital Surround', are trademarks of Digital Theater Systems, Inc.

Copyright © 1996 Digital Theater Systems, Inc. All rights reserved.

Installation

Installation starts with positioning the unit where it can operate effectively. To use the radio receiver, you will need to install an FM and/or an AM aerial.

Other input signals – from CD, MD, tape, DAT, VCR, DVD, games console or satellite receiver – will need to be connected to sockets on the AVR200's back panel.

Output signals – TV, monitor, projector, preamplifier, loudspeakers, headphones or other audio or digital outputs – also need to be connected to sockets on the back panel.

Positioning the unit

Place your AVR200 on a level, firm surface.

Avoid placing the unit in direct sunlight or near sources of heat or damp.

Ensure adequate ventilation. Do not place the unit in an enclosed space such as a bookcase or cabinet as both of these will impede air flow through the ventilation slots.

Setting up the aerials

FM aerial

An FM aerial is required to receive VHF radio signals. An external FM ribbon aerial is supplied as an accessory with the AVR200.

For optimal FM radio reception a roof or loft mounted aerial is advised. For your own safety it is recommended that a roof top aerial is fitted by an experienced contractor. Your Arcam dealer should be able to put you in contact with an aerial installer.

A contractor will be able to tune your aerial to the nearest FM transmitter. In an apartment building an aerial system may already be installed. If this is the case you should have sockets in your home marked FM or VHF (do not use those marked TV).

The 'T' shaped wire aerial (dipole design) supplied should give reasonably good reception. Mount this aerial as high up as possible on a wall with the elements positioned horizontally. Try each usable wall of the room to see which gives best reception. Use tacks or adhesive tape to secure the aerial in a T shape. The tacks should not come into contact with the internal wire of the aerial.

Whether you decide to get an aerial professionally installed or opt to use the supplied aerial it should be connected to the FM Antenna input on the rear of the unit.

AM aerial

An AM aerial is required to receive AM/Medium Wave radio signals.

An external AM loop aerial is supplied as an accessory with the AVR200. This should be attached to the AM Antenna inputs with one end connected to AM and the other to Ground. It does not matter which way round this aerial is fitted. Rotate the aerial to discover which position gives the best reception.

In areas of weak reception or when the receiver is used inside a steel framed building (such as an apartment building) you can use a wire between 3 and 5 metres long to strengthen reception. Mount this high up outside the building, if possible, and connect one end of this wire to the AM antenna input as well as the loop aerial supplied. DO NOT DISCONNECT THE LOOP AERIAL.

The AM tuning 'step size' needs to be set according to your location. This is done using the switch on the rear panel: set it to 10kHz if you are in North America or 9kHz anywhere else.

Connecting inputs

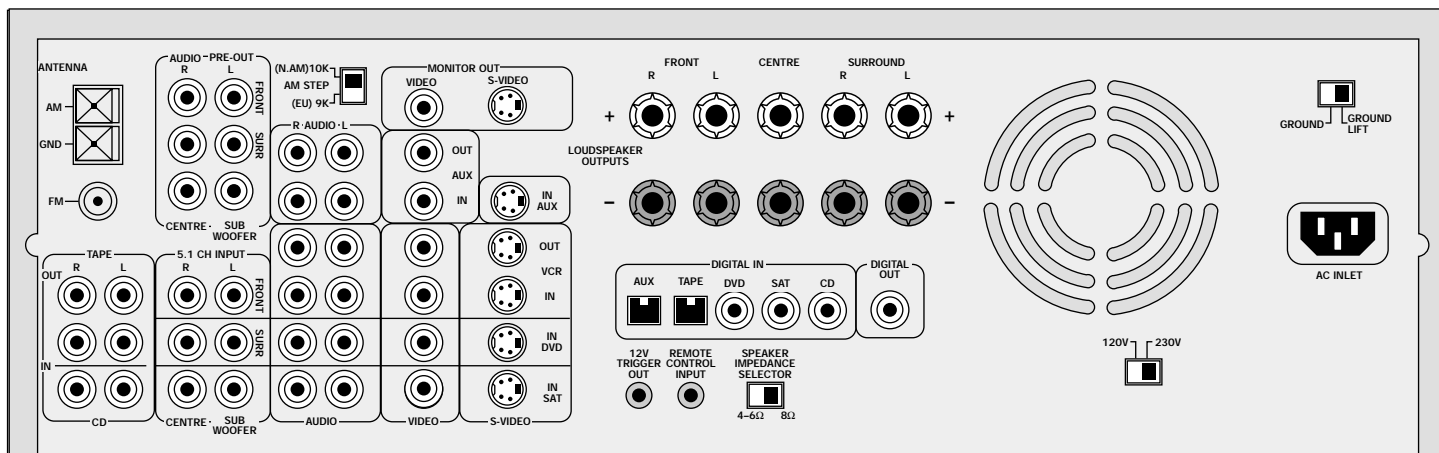

Interconnect cables

The use of high quality interconnect cables to and from your AVR200 is recommended to ensure the best sound and picture quality. Ask your Arcam dealer's advice on cable selection.

This product does not feature a Phono input stage. If you wish to connect a turntable to your AVR200 you will need to use an in-line phono pre-amp. All line level inputs have the same sensitivity so may be used with any line level source equipment, even components other than those labelled. If you need to do so, your Arcam dealer can give you further advice on this.

CD input

Use audio interconnects to attach the left and right audio outputs from your CD player to the **CD IN** inputs on the AVR200. If your CD player has digital output, connect it to the **CD DIGITAL IN** socket on the AVR200.

TAPE loop

This input can be used to connect one of many different recording devices, for example, a tape deck, Mini-Disc or CD-R. Use audio interconnects to attach the left and right audio outputs from your recorder to the corresponding **TAPE** inputs on the AVR200. If your tape source has digital output, connect it to the **TAPE DIGITAL IN** socket on the AVR200.

To complete the record loop, attach the left and right **TAPE** outputs from the AVR200 to the corresponding record inputs on your recorder.

5.1 channel input

This multi-channel input takes up to six (i.e. five channels plus one sub-woofer) discrete channels of audio from a DVD audio player or a DVD player with an integrated decoder. Use audio interconnects to attach the DVD's outputs to the appropriate **5.1 CH INPUT** inputs on the AVR200.

For optimum performance from DVD video, however, it is usually better to use a digital connection to the AVR200's own internal digital surround decoder instead.

SAT input

Use audio interconnects to attach the left and right audio outputs from your satellite or cable receiver (or digibox) to the corresponding **SAT** inputs on the AVR200.

Using either the composite or the S-video output from your satellite receiver, connect it to the corresponding **VIDEO** or **S-VIDEO** input on the AVR200.

If your satellite receiver provides a coaxial digital output, attach it via the **SAT** digital input.

DVD input

In most cases you will achieve the best audio performance from your DVD player by connecting its digital output to the **DVD** digital input of the AVR200, using a suitable 75Ω digital cable. Connect either the composite or S-video output from your DVD player to the corresponding **VIDEO** or **S-VIDEO** inputs on the AVR200.

If you are also using your DVD player to play CDs and prefer to use the stereo audio outputs, connect these to the **CD** inputs of the AVR200.

VCR loop

Use audio interconnects to attach the left and right audio outputs from your video cassette recorder to the **VCR** inputs on the AVR200. For the video signal, use either the composite or the S-video output from your VCR and attach to the corresponding input on the AVR200. If the VCR has a digital output, connect it to the **VCR** digital input on the AVR200.

To complete the record loop, attach the left and right **VCR** audio outputs from the AVR200 to the corresponding record inputs on your VCR. Using the same type of video connection as for the input, connect the **VCR** picture output from the AVR200 to the corresponding input on your VCR.

AUX input and record loop

Use audio interconnects to attach the left and right audio outputs from your auxiliary source (another item of audio equipment or a games console) to the corresponding **AUX** inputs on the AVR200.

Using either the composite or the S-video output from your auxiliary source, connect it to the corresponding **VIDEO** or **S-VIDEO** input of the AVR200.

If your auxiliary source has a digital output, connect it to the **AUX** digital input on the AVR200.

GROUND LIFT switch

If your system only takes audio sources from CD or DVD, set this switch to '**GROUND**'. In more complex setups which involve satellite inputs or radio aerials, grounding the unit may actually increase the level of background hum or buzz in the loudspeakers, in which case set the switch to '**GROUND LIFT**'.

REMOTE CONTROL INPUT

This input is connected to the output of an infrared receiver. The remote control input is usually used in custom installations. Ask your dealer or custom installer for further details.

Connecting outputs

Connecting to other equipment

MONITOR OUT

Both composite and S-video monitor outputs are provided for connection to the 'Video line in' of your TV, monitor, or projector. If you have both Composite and S-video inputs connected to your AVR200 you need only connect the **S-VIDEO** Monitor Output to your TV (provided that your TV accepts an S-video input).

LOUDSPEAKER OUTPUTS

Before connecting loudspeakers to your AVR200 you must set the Impedance switch on the rear to the correct position.

WARNING: Never adjust this switch with the power on or you will damage the AVR200.

If your loudspeakers are rated at 6Ω or lower set the switch to the 4– 6Ω position. If your loudspeakers are rated higher than 6Ω , set the switch to the 8Ω position.

WARNING: This unit should only be used with loudspeakers with an impedance rating between 4Ω and 8Ω .

WARNING: When connecting loudspeakers, ensure that no stray strands of wire are allowed to touch other cables or the AVR200's casing as this can cause a short circuit and damage the amplifier.

Bi-wiring and Bi-amping loudspeakers

Notes on these techniques are given in the Reference section of this handbook.

Preamplifier outputs

If you wish to upgrade your system by adding a power amplifier, always specify an Arcam unit to ensure matching gain.

The AVR200 has six line-level pre-amp outputs that can be connected to Arcam external power amplifiers to bi-amplify ('bi-amp') any of the channels. Alternatively, the AVR200 can be used solely as a preamplifier.

Depending on how your system is configured, the subwoofer **AUDIO PRE-OUT** should be connected using a line level interconnect, to either:

- an active subwoofer, or
- a power amplifier used to drive a passive subwoofer.

DIGITAL OUT

Use this socket to connect to the input of a suitable digital recorder (e.g. a CD-R or minidisc). When using a coaxial digital input, the signal is passed through the AVR200 with no changes. An optical input is restricted to a maximum frequency of 48kHz.

12V TRIGGER OUT

This connection is normally used only with multi-room installations. If you are bi-amping with a power amplifier and wish to power both units on or off simultaneously, see page 15.

PHONES (Headphone output)

A 6.3mm stereo jack socket is provided on the front panel for headphone listening. Inserting the jack automatically mutes (i.e. cuts off) the loudspeakers, and **AUDIO PRE-OUT** outputs. Surround mode settings are ignored: headphone output is in stereo.

Connecting to a power supply

Wrong plug?

Check that the plug supplied with the unit fits your supply and that your mains supply voltage agrees with the voltage setting (120V or 230V) indicated on the rear panel of the unit.

If your mains supply voltage or mains plug is different, consult your Arcam dealer or Arcam Customer Support on +44 (0)1223 203203.

Mains lead

The appliance is normally supplied with a moulded mains plug already fitted to the lead. If for any reason the plug needs to be removed, it must be disposed of immediately and securely, as it is a potential shock hazard when inserted into the mains socket. Should you require a new mains lead, contact your Arcam dealer.

Plugging in

Push the plug (IEC line socket) of the power cable supplied with the unit into the socket (**AC INLET**) in the back of the unit. Make sure it is pushed in firmly.

Put the plug on the other end of the cable into your power supply socket and switch the socket on.

Non-use periods

If the unit is to be left unused for an extended period, we recommend that you switch the unit off from the front panel button, rather than use 'stand by' mode with the remote control.

Setting up

Using the On Screen Display (OSD)

The easiest way to set up the AVR200's multi-channel audio and video options is through its On Screen Display (OSD).

To enter the OSD, ensure that you have a TV connected and press any of the arrows on the remote control's cursor pad.

To navigate from the first (i.e. Setup) page, use the ▼ and ▲ arrows to highlight a line. To enter a highlighted page, press **OK**. To leave the OSD, highlight 'EXIT' and press **OK**.

Once on a page, use the ▼ and ▲ arrows to move to a line and the ► and ◀ arrows to change an option. Once you are happy with the settings, highlight 'SAVE AND EXIT' and press **OK** to keep them in memory. If you are unsure about the changes, or you have entered the page accidentally, highlight 'DO NOT SAVE AND EXIT' and press **OK** and any changes on that page are ignored.

Setup page

The Setup page forms the index to the OSD. To navigate from here, use the cursor pad on your remote control.

Input settings page

AUDIO Identifies the active audio source (e.g. CD)
VIDEO Identifies the active video source (e.g. DVD)
MODE Identifies the surround mode associated with the current input (Dolby Digital, DTS, Dolby Pro Logic II Movie, Dolby Pro Logic II Music, Dolby Pro Logic II Panorama, Dolby Pro Logic II Matrix, Dolby Pro Logic, Hall effect or Stereo)

DYNAMIC RANGE A compressed dynamic range is useful for low level (night time) listening. For Dolby Digital sources, the dynamic range has options of 100%, 75%, 50% or 25%

CENTRE WIDTH (Dolby Pro Logic II Music Mode only)
 Allows centre-channel sounds to be positioned between the centre speaker and the left/right speakers over a range of eight steps. Step '3' uses a combination of all three front speakers to give the best vocal imaging and most seamless soundstage and is recommended for most recordings. Step '0' places all centre sound in the centre speaker. Step '7' places all centre sound equally in the left/right speakers, as in conventional stereo.

Setting options for CENTRE WIDTH	
DISPLAY	EFFECT
Off	No Centre spreading
1	20.8°
2	28°
3	36°
4	54°
5	62°
6	69.8°
7	Phantom Centre

NOTE: In some cases you may find that the OSD is not still or that it 'rolls over' your screen. (You may also notice this effect when the volume bar is shown on screen.) If this is the case, you will need to switch the video system being used by the AVR200.

To do this, first exit the OSD by highlighting **EXIT** and press **OK**. Press and hold the **STORE** button on the front panel of the AVR200 then toggle between the systems shown in the display area by pressing the **SAT** button – NTSC (used in North America) or PAL (used in most of Europe) – until the correct system is selected.

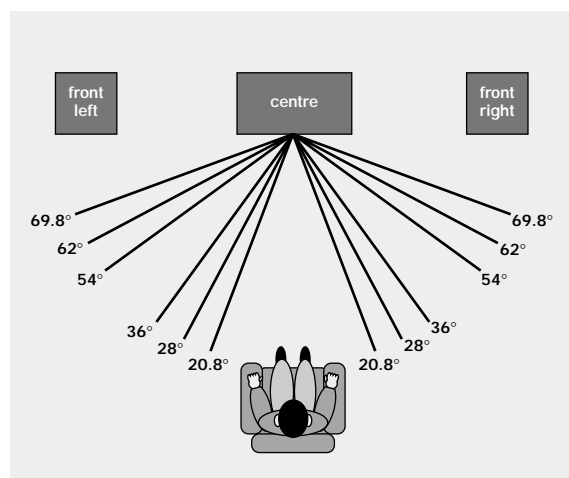
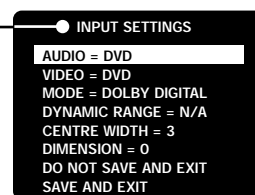
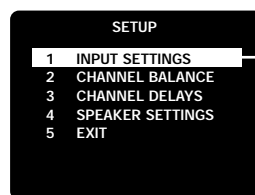
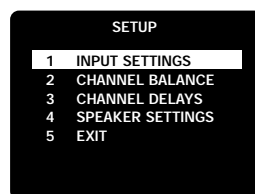

DIMENSION (Dolby Pro Logic II Music Mode only) Allows the gradual adjustment of the soundfield either towards the front or the rear. This can help achieve the desired balance from all the speakers with certain recordings that may contain either too much or too little spatial effect. Step '0' is the recommended setting, which has no effect on the sound. Steps '+1', '+2' and '+3' gradually move the sound forward, and steps '-1', '-2' and '-3' move the sound towards the surrounds.

Setting options for DIMENSIONS	
DISPLAY	EFFECT
-3 MAX SURR	Most surround
-2	
-1	
0	Neutral
+1	
+2	
+3 MAX CENTRE	Most centre

Channel balance page

From the Channel balance page, you can trim the level of each individual loudspeaker connected to the AVR200. Due to the different performance characteristics or positioning of each loudspeaker they may need to be set to different levels to provide a balanced sound from the listening position. To help set this balance, the AVR200 can generate a test tone that plays an identical signal through each channel in turn. Trim the balance of each speaker in turn until they all appear to produce the same volume.

Once the channel balance page is shown in the OSD, press the **TEST** button on the remote control to start the test tone. Make sure that either Dolby Digital, Dolby Pro Logic or Dolby Pro Logic II is selected, and that the volume on the AVR200 is set sufficiently high for the tone to be heard. The test tone automatically cycles through each speaker channel until the **TEST** button is pressed a second time.

Each loudspeaker can be trimmed between +10dB and -10dB. You can return to the Channel balance page at any time (without first entering the OSD) by pressing the **TEST** button on the remote control. Press **TEST** again to exit this page.

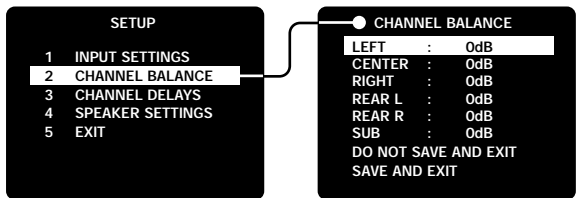

NOTE: The test tone generates a noise which may not be heard through a subwoofer. To set your sub to a suitable level, turn off the test tone and experiment with the trim while playing a piece of music or a movie you are familiar with. There is no right or wrong level for the sub: simply find the balance that is best for you.

Channel delays page

For best results in a surround sound system, the sound from all loudspeakers should reach the listener at the same time. To help achieve this the AVR200 can add slight delays to certain channels when in Dolby Digital or Dolby Pro Logic modes.

When playing a **Dolby Digital** source you can set a delay for the centre channel of between 0 and 5ms and a delay for the rear channels of between 0 and 15ms.

The method of calculating these delay times is described overleaf.

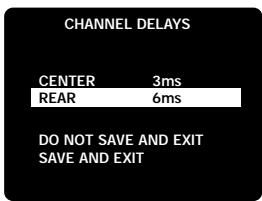
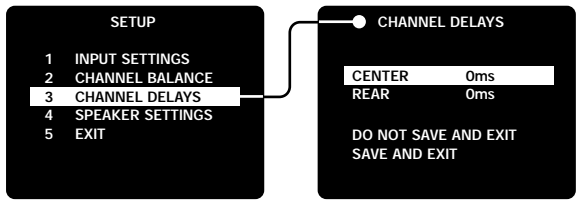

NOTE: It is not necessary to adjust delay times separately for a DTS (Digital Theater Systems) source.

To calculate these delay times, first measure (or estimate) the distances from the listening position to the front, centre and rear speakers. Keep a record of these distances by entering them under the heading 'Your measurement' in the table provided.

The centre channel delay is calculated by subtracting the centre channel distance from the front left (or right) distance. The difference represents the **CENTRE** delay time.

The rear channels' delay time is calculated by subtracting the rear left (or right) distance from the front left (or right) distance. The difference represents the **REAR** delay time. Note that if your rear loudspeakers are further from the listening position than the front loudspeakers, you should set this delay to **0ms**.

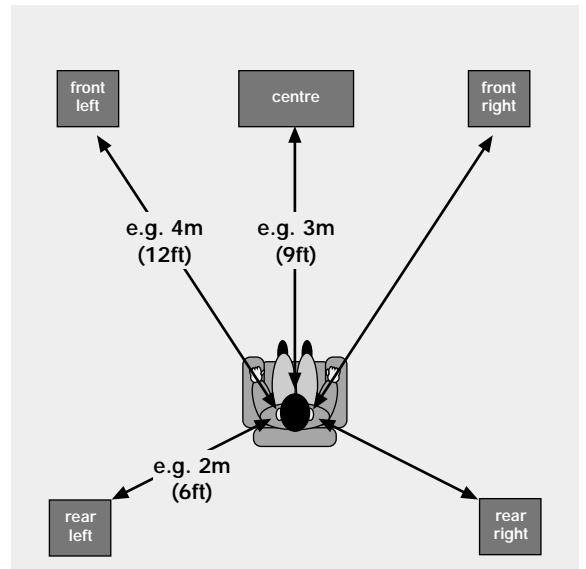

If you have made your measurements in feet, one foot approximates to one millisecond (1ms) delay. If you have made your measurements in metres, one metre approximates to three milliseconds (3ms) delay.

Distance to listening position	e.g.	Your measurement
Front left or right	4m or 12ft
Centre	3m or 9ft
Rear left or right	2m or 6ft
<hr/>		
Difference	e.g.	Delay (ms)
CENTRE delay	(4 – 3m) or (12 – 9ft) = 1m or 3ft	3 milliseconds
REAR delay	(4 – 2m) or (12 – 6ft) = 2m or 6ft	6 milliseconds

When playing a **Dolby Pro Logic** or **Dolby Pro Logic II** source you can set a time delay (in milliseconds) for the rear channels. There is no delay setting for the centre channel.

The rear channel delay in Dolby Pro Logic is calculated by adding 15ms to the rear channel delay calculated for Dolby Digital. In our example, this is 15ms + 6ms = 21ms.

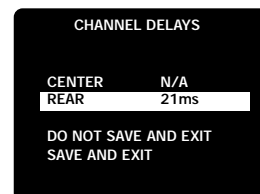

Speaker settings page

The size and number of loudspeakers are defined on this page of the OSD.

- A 'LARGE' speaker is one that is capable of handling a full range signal (i.e. 20Hz–20kHz).
- A 'SMALL' speaker is one that is not capable of reproducing a deep bass signal (i.e. below 100Hz), for example a satellite speaker.
- 'ON' is used when a speaker is present and active and receives the intended audio information.
- 'OFF' is used when a speaker is absent or inactive. Audio signals intended for speakers set to OFF are redirected to the main speakers.

Recommended speaker settings for different systems

To configure a 'Sub/Sat' system (i.e. a set of small speakers with a subwoofer), your speaker settings should be 'SMALL' for all speakers, with Subwoofer turned 'ON'.

Some small but high performance speakers are capable of handling a signal below 100Hz: in this instance, set them to 'LARGE' (despite their small physical size). If in doubt, please check the specifications in your speaker's handbook or ask your dealer.

If you don't have a centre speaker, set CENTER to 'OFF'. This directs the centre speaker information to the front left and right speakers, ensuring that dialogue is clearly reproduced.

The SUBWOOFER STEREO setting is only relevant for music reproduction and does not affect sound reproduction for movies. If you have small speakers on the front, set SUBWOOFER STEREO to 'ON' to give the extra bass reinforcement required for music. If your front speakers are large, or of high quality and performance, you may find music is reproduced more accurately with the Subwoofer turned 'OFF'.

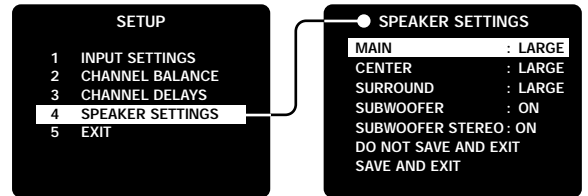

Using the AVR200

Front panel controls



POWER

Press the **POWER** button to turn the AVR200 on. The status LED changes to green on powering up and the display shows the active input. Pressing the **POWER** button again turns the unit and the status LED off.

A red status LED indicates that the AVR200 is in stand by and can be switched on by the remote handset.

Input selection

The input selection buttons are labelled to correspond with the audio and video inputs on the rear panel of the AVR200. To select an input, press the appropriate button on the front panel. The audio signal for that source will then be routed to the speakers. Any picture signal associated with that input is switched to the monitor output.

The name of the selected input is shown in the display: SAT, DVD, VCR or AUX, EXT 5.1, TAPE MONITOR, CD, FM and AM.

EXT 5.1

To select the source connected to the 5.1 channel input, press **EXT 5.1**. When this input is selected, none of the alternative surround modes are available.

SURROUND MODE

When a selected digital input carries a Dolby Digital or DTS signal, the AVR200 automatically detects it and processes the signal accordingly.

For an analogue input or when no Dolby Digital or DTS signal is detected, pressing the **SURROUND MODE** button cycles through the available surround sound modes: STEREO, PRO LOGIC II MOVIE, PRO LOGIC II MUSIC, PRO LOGIC II PANORAMA, PRO LOGIC II MATRIX, PRO LOGIC and HALL.

The selected mode is displayed in the main section of the display for three seconds, before reverting to show the active input. The surround mode continues to be shown in the left hand side of the display. In the case of Dolby Pro Logic II, only 'MUSIC' and 'MOVIE' modes are illuminated.

Dolby Digital, DTS

Both of these formats feature six independent audio channels: Left, Centre, Right, Surround Left, Surround Right and a 'Low Frequency Effects' (LFE) or subwoofer channel.

Dolby Pro Logic

This format decodes the centre and surround sound signals encoded in Dolby Surround or Dolby Stereo movie soundtracks.

Dolby Pro Logic II

This format is the next generation in Dolby Surround decoding. It was designed specifically to decode all existing Dolby Surround programs with improved spatiality and directionality. **Dolby Pro Logic II Movie** is enhanced over Dolby Pro Logic by having stereo surround channels and no frequency filter on the speaker signal.

Dolby Pro Logic II Music is specifically for listening to music, not to movies.

Dolby Pro Logic II Panorama mode extends the front stereo image to include the surround speakers for an exciting 'wraparound' effect with side wall imaging.

Dolby Pro Logic II Matrix is the same as 'Music' mode, except that mono signals are enhanced to make them seem 'larger'.

Hall effect

This format decodes a normal stereo signal to simulate the ambience of a concert hall.

TAPE MONITOR

The **TAPE MONITOR** button selects the audio output from a cassette deck connected to the **TAPE IN** phono sockets of the AVR200. It also enables you to monitor a recording being made on a 3-head cassette deck. Tape monitor status is shown in red on the display.

When the tape monitor is selected, pressing other source buttons changes the signal sent to the recorder.

NOTE: **TAPE MONITOR** is a latching button: you will need to press it again before selecting another source for listening.

CD

The **CD** button selects the source connected to the **CD** phono sockets.

FM, AM

To select the integrated tuner function of the AVR200, press the **FM** or **AM** button. See the section 'Using the tuner'.

VOLUME control

To adjust the volume level of the loudspeakers, pre-amp outputs and headphones use the **VOLUME** control. The volume level is shown in the display while it is being adjusted. Three seconds after the volume is adjusted, the display reverts to show the selected input.

Note that different sources may require different settings of the **VOLUME** control to achieve the same perceived volume level.

The volume can be controlled from 0dB over 80 steps.



 after 3 seconds



BASS and TREBLE controls

Turn the bass and treble controls clockwise to boost response or anticlockwise to cut response. For a flat response leave the controls in the 12 o'clock 'notched' position.

Pressing the **DIRECT** button bypasses the bass and treble controls and gives a small improvement to sound quality. If you do not wish to alter the bass or treble controls, we recommended that you select **DIRECT**.

Using the tuner

The AVR200's radio tuner can be controlled from the upper row of front panel buttons (see diagram, below) or from the remote control handset (see 'Using the remote control').

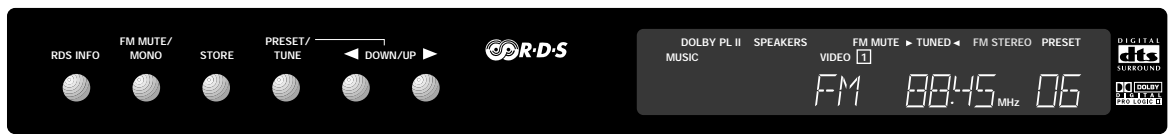

Tuning to a station

Pressing the PRESET/TUNE button toggles between the two tuning modes of the unit – 'Preset' or 'Tune'. The selected mode is briefly shown in the display.

Preset mode

In Preset mode, press the ◀ and ▶ buttons on the front panel (or P- or P+ on the remote control handset) to cycle up and down the preset stations.

See 'Storing a preset' and 'Deleting unused presets', below.

Tune mode

In Tune mode:

- Press the ◀ and ▶ buttons on the front panel (or P- or P+ on the remote control handset) for longer than half-a-second to engage automatic tuning. The tuner searches for a radio station signal of sufficient strength and stops. To skip to the next station, press one of the buttons again. Automatic tuning is available for both the FM and AM bands.
- Tapping the ◀ and ▶ buttons engages manual tuning. This can be used for tuning to a specific frequency. It is also useful if you are trying to select a station that is too weak for the auto search mode.

Regardless of the mode used to tune your AVR200, when it is accurately tuned to a station ▶TUNED◀ lights up in the display.

Storing a preset

To store a preset, tune to the radio station you wish to store. Press the **STORE** button: this causes 'MEMORY' to flash in the display. Now select the preset number you wish to assign to the station using the ◀ and ▶ buttons on the front panel (or P- or P+ on the remote control handset). Press the **STORE** button again.

Once the preset is stored, the display reverts to show the station name (if RDS information is transmitted) or its frequency.

To quit the memory function without storing a preset, leave the tuner controls untouched for ten seconds. It is also possible to overwrite a stored station by saving another in its place. There are thirty presets available for FM use and ten for AM use.

Your presets are retained for several weeks (but not indefinitely), when the AVR200 is disconnected from the mains supply.

Deleting an unused preset

Press the **STORE** button, then select the preset number you want to delete using the ◀ and ▶ buttons (or P- or P+ on the remote control handset), followed by the **FM MUTE/MONO** button.

The display briefly shows 'DELETED' and '- -' is shown in place of the preset number. You can reactivate a deleted preset number by storing a station in the normal way.

RDS: Radio Data System

The Arcam AVR200 supports RDS Programme Service and RDS Radio Text on FM broadcasts.

When a station carrying RDS information is selected 'RDS' lights up in the display and shortly afterwards the station's RDS name (e.g. 'BBC R3') is shown.

Press the **RDS INFO** button to view any RDS text information (if a station is not transmitting text information, the display briefly indicates 'NO TEXT' and reverts to show the station name).

Press **RDS INFO** again to display the station's frequency.

Pressing **RDS INFO** a third time returns you to a display of the station name.

If the **RDS INFO** button is pressed while tuned to a non RDS station, the display shows 'NO NAME' for three seconds before reverting to the default display.

FM Mute/Mono

The AVR200's tuner has an auto-muting circuit that, when engaged, mutes any signal that is of insufficient strength for listening. To engage this circuit press the **FM MUTE/MONO** button on the front panel: 'FM MUTE' is shown in the display. If a signal is muted you will hear no sound through the loudspeakers.

Should you wish to listen to a station that is 'auto muted' press the **FM MUTE/MONO** button again to disengage the muting circuit. The tuner now switches to monoaural reception, cancelling much of the background hiss. 'FM MUTE' is no longer displayed and you are able to continue listening.

Radio interference

All Arcam products have been designed to very high standards of electromagnetic compatibility.

However, both CD players and DACs generate, and can radiate RF (radio frequency) energy. In some cases this can cause interference with FM and AM radio reception. If this is the case, switch the CD player off or keep the CD player and its connecting cables as far from the tuner and its aerials as possible. Connecting the CD player and the tuner/amplifier to different mains sockets can also help to reduce interference.

EC COUNTRIES – These products have been designed to comply with directive 89/336/EEC.

USA – These products comply with FCC requirements.

Using the remote control

CR-340 Remote Control

The CR-340 remote control gives access to all functions available on the front panel, plus some additional functions only available from the remote. It also has controls to operate Arcam CD and DVD players.

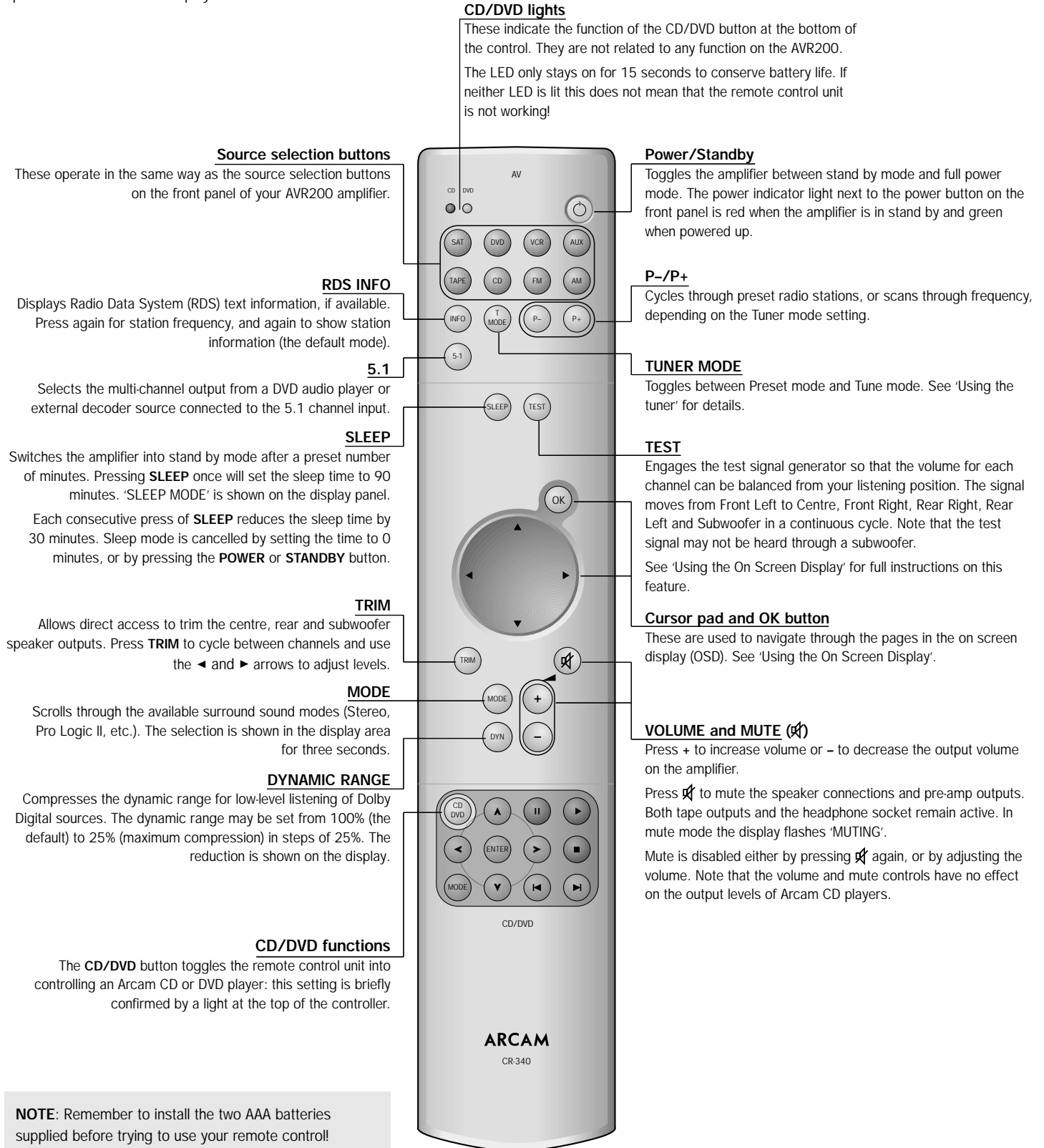

NOTE: Remember to install the two AAA batteries supplied before trying to use your remote control!

Do not place anything in front of the display area on the AVR200 (where the IR receiver is located), or the remote control may not work.

Reference

Bi-wiring and bi-amping loudspeakers

Before you start

WARNING: Do not make any connections to your amplifier while it is switched on or connected to the mains supply.

Before switching on please check all connections thoroughly, making sure bare wires or cables are not touching the amplifier in the wrong places (which could cause short circuits) and you have connected positive (+) to positive and negative (-) to negative.

Always ensure that the volume control on your amplifier is set to minimum before starting these procedures.

Bi-wiring your loudspeakers

Bi-wiring improves the sound of your system because it divides the high and low frequency signal currents into separate speaker cables. This avoids signal distortions arising from the high and low frequency currents interacting with one another within a single cable, as in conventionally wired systems.

You will need:

Speakers – with four input terminals each: these will be marked HF (High Frequency) and LF (Low Frequency).

Loudspeaker cables – two pairs of cables per loudspeaker (which may be joined at the amplifier end if your amplifier has only one pair of output terminals per channel). Or, a suitably terminated cable set (a loom, probably prepared by your dealer and capable of being used for bi-wiring in one length).

How to bi-wire loudspeakers

1. Remove the terminal links on the rear of your loudspeakers

WARNING: This step is essential or damage to your amplifier may result which is not covered under warranty.

2. Connect the cables as shown in the diagram below, ensuring correct polarity at all times.

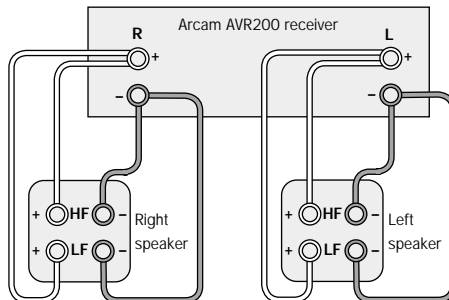

Bi-wiring using one set of connections on amplifier

Bi-amping your system

The performance of your system can be further enhanced over that achieved with bi-wiring, by extending the principle one stage further to include separate amplification for the low and high frequency drive units in each loudspeaker enclosure.

Connect the AVR200 to the high frequency (HF) terminals and connect your power amplifier to the low frequency (LF) terminals.

You will need:

Speakers – with four input terminals each (as with bi-wiring): these will be marked HF (High Frequency) and LF (Low Frequency).

Two amplifiers – one of these would be the AVR200 and the other an Arcam power amplifier (e.g. an P75 or P85).

Loudspeaker cables – one pair of cables per loudspeaker or a suitably terminated cable set (a loom, probably prepared by your dealer and capable of being used for bi-amping in one length).

Interconnect cables – one pair of high quality interconnect cables.

How to set up a bi-amped system

1. Remove the terminal links on the rear of your loudspeakers.

WARNING: This step is essential or damage to your amplifier may result which is not covered under warranty.

2. Connect the cables as shown in the diagram below, ensuring correct polarity at all times.
3. Use the interconnect cables to connect the AUDIO PRE-OUT sockets of the AVR200 to the corresponding PWR AMP IN sockets of the power amplifier.

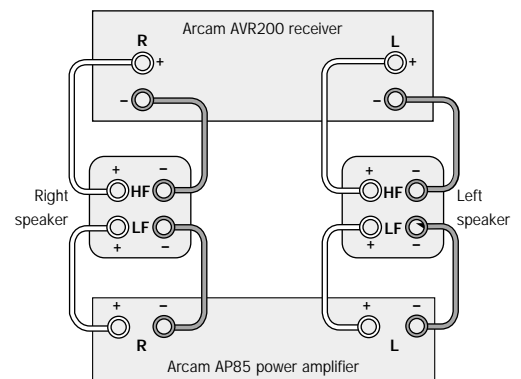

Recommended bi-amping configuration

Troubleshooting

The following table should help you diagnose most problems that may arise when using the AVR200.

Problem	Cause	Solution
No audio	<ol style="list-style-type: none"> 1. Power Lead unplugged or not switched on 2. In stand by mode 3. Mute on 4. Tape monitor selected 	<ol style="list-style-type: none"> 1. Check mains lead is connected to AVR200 and that the wall switch is on 2. Press the POWER/STANDBY button on remote handset 3. Switch mute off 4. Press the TAPE MONITOR button
No sound on one channel	<ol style="list-style-type: none"> 1. Loudspeaker not connected or not connected properly 2. Input not connected or not connected properly 3. Speaker described as 'OFF' in set up page 4. Channel level set too low 	<ol style="list-style-type: none"> 1. Check connections to AVR200 and to loudspeaker 2. Check connections to AVR200 and at source 3. Re-assign speaker settings in on-screen display 4. Re-assign channel balance in on-screen display
Dolby Digital or DTS not auto detected	Digital input not connected	Connect digital output of source to appropriate input on AVR200
Lack of bass or poor stereo image	<ol style="list-style-type: none"> 1. Speakers wired out of phase (i.e. + connected to -, or red to black in error – a polarity error in one speaker) 2. Speakers set as 'SMALL' 	<ol style="list-style-type: none"> 1. Check all connections to AVR200 and to loudspeakers 2. Re-select preset speaker settings in on-screen display
No sound from tuner	<ol style="list-style-type: none"> 1. Aerial not connected properly 2. Weak signal muted by FM Mute 	<ol style="list-style-type: none"> 1. Check aerial connections to AVR200's back panel 2. Switch FM MUTE/MONO off or re-tune station
Remote control not working	<ol style="list-style-type: none"> 1. Batteries in handset fitted the wrong way round or flat 2. IR receiver window on AVR200 is obscured 3. IR receiver window flooded with light 	<ol style="list-style-type: none"> 1. Check orientation of batteries/ replace discharged batteries 2. Remove obstruction 3. Move AVR200 away from light source or shade from intense light source
Picture scrolls around screen, or picture is only in black and white	Wrong video system selected	To toggle between PAL and NTSC video systems, press and hold the STORE button and click the SAT button.
No picture on monitor when video source is selected	<ol style="list-style-type: none"> 1. Source is not playing 2. Video connection between the source and AVR200 is not been made 	<ol style="list-style-type: none"> 1. Check and play source 2. Check system wiring: ensure connection between source
Sound and picture come from different sources	System connections made to wrong inputs of AVR200	Check system wiring: ensure all connections are made to correct input on AVR200
AVR200 switches itself to stand by mode	Circuits have overheated and unit has been switched into protection mode. This may be because airflow around the unit is restricted.	Switch unit off. Remove any restrictions to good airflow. Allow unit to cool down before switching on again.
The red status LED flashes and the AVR200 appears not to work.	The AVR200 has gone into protection mode. This is probably caused by an overload or short circuit on the loudspeaker outputs.	<ol style="list-style-type: none"> 1. Turn the AVR200 off and disconnect the mains cable. 2. Check all the wiring, making sure that no bare loudspeaker cables are touching each other or the chassis. 3. Reconnect the mains cable and switch back on. If this does not cure the problem or the problem persists contact your Arcam dealer.

Technical specifications

AMPLIFIER SPECIFICATION

Output power (20Hz–20kHz at 0.5%THD)

8Ω, five channels 70W

8Ω, two channels 90W

8Ω, single channel 100W

Harmonic distortion, 1W, 8Ω at 1kHz 0.02% typical

Left/right crosstalk 60dB at 1kHz

Frequency response ±1.0dB 20Hz to 20kHz

Inputs

Line inputs

sensitivity 200mV

input impedance >10kΩ

overload margin >20dB

Power amplifier input sensitivity 740mV (normal gain)

Outputs

Preamplifier

nominal output level 200mV

maximum output level 3V

Headphones

output impedance 390Ω

Physical

Dimensions W x D x H 430 x 450 x 150mm

Weight net 11.9kg

Weight packed 14.1kg

Mains voltage 230V ±12%

120V ±12%

Power consumption (maximum) 500VA

Accessories supplied

Mains lead

CR-340 remote control

2 x AAA batteries

AM loop aerial

FM ribbon aerial

RADIO SPECIFICATION

FM section

30 preset stations available

RDS Station Identification, Radio Data Display

FM tuning range 87.5 to 108MHz

FM sensitivity < 6μV

THD

mono < 0.25%

stereo < 0.35%

Signal/noise ratio

mono > 72dB

stereo > 66dB

Pilot tone suppression > 60dB

Alternate channel selectivity IHF > 60dB

Capture ratio < 3dB

AM section

10 preset stations available

AM tuning range

10kHz step 530 to 1710kHz

9kHz step 531 to 1602kHz

Usable sensitivity < 30μV

IF rejection > 36dB

Signal/noise ratio, 5mV input > 38dB

THD, 5mV input < 3%

E&OE

NOTE: All specification values are typical unless otherwise stated.

Continual improvement policy

Arcam has a policy of continual improvement for its products. This means that designs and specifications are subject to change without notice.

Guarantee

Worldwide Guarantee

This entitles you to have the unit repaired free of charge, during the first two years after purchase, at any authorised Arcam distributor provided that it was originally purchased from an authorised Arcam dealer or distributor. The manufacturer can take no responsibility for defects arising from accident, misuse, abuse, wear and tear, neglect or through unauthorised adjustment and/or repair, neither can they accept responsibility for damage or loss occurring during transit to or from the person claiming under the guarantee.

The warranty covers:

Parts and labour costs for two years from the purchase date. After two years you must pay for both parts and labour costs. The warranty does not cover transportation costs at any time.

Claims under guarantee

This equipment should be packed in the original packing and returned to the dealer from whom it was purchased, or failing this, directly to the Arcam distributor in the country of residence.

It should be sent carriage prepaid by a reputable carrier -- NOT by post. No responsibility can be accepted for the unit whilst in transit to the dealer or distributor and customers are therefore advised to insure the unit against loss or damage whilst in transit.

For further details contact Arcam at:

Arcam Customer Support Department,
Pembroke Avenue, Waterbeach, CAMBRIDGE
CB5 9PB, England.

Telephone: +44 (0)1223 203203

Fax: +44 (0)1223 863384

Email: support@arcam.co.uk

Problems?

If your dealer is unable to answer any query regarding this or any other Arcam product please contact Arcam Customer Support on +44 (0) 1223 203203 or write to us at the above address and we will do our best to help you.

On line registration

You can register your Arcam product on line at:

www.arcam.co.uk/reg

Free Manuals Download Website

<http://myh66.com>

<http://usermanuals.us>

<http://www.somanuals.com>

<http://www.4manuals.cc>

<http://www.manual-lib.com>

<http://www.404manual.com>

<http://www.luxmanual.com>

<http://aubethermostatmanual.com>

Golf course search by state

<http://golfingnear.com>

Email search by domain

<http://emailbydomain.com>

Auto manuals search

<http://auto.somanuals.com>

TV manuals search

<http://tv.somanuals.com>