

ASUS[®]

PG278Q series

LCD Monitor

User Guide

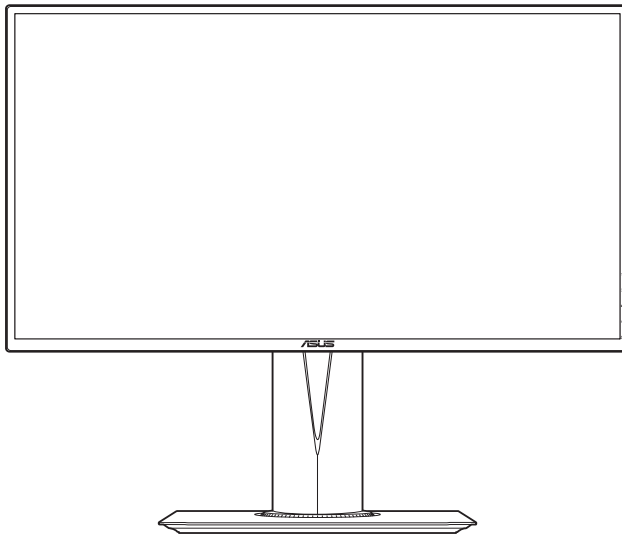

First Edition

June 2014

Copyright © 2014 ASUSTeK COMPUTER INC. All Rights Reserved.

No part of this manual, including the products and software described in it, may be reproduced, transmitted, transcribed, stored in a retrieval system, or translated into any language in any form or by any means, except documentation kept by the purchaser for backup purposes, without the express written permission of ASUSTeK COMPUTER INC. ("ASUS").

Product warranty or service will not be extended if: (1) the product is repaired, modified or altered, unless such repair, modification or alteration is authorized in writing by ASUS; or (2) the serial number of the product is defaced or missing.

ASUS PROVIDES THIS MANUAL "AS IS" WITHOUT WARRANTY OF ANY KIND, EITHER EXPRESS OR IMPLIED, INCLUDING BUT NOT LIMITED TO THE IMPLIED WARRANTIES OR CONDITIONS OF MERCHANTABILITY OR FITNESS FOR A PARTICULAR PURPOSE. IN NO EVENT SHALL ASUS, ITS DIRECTORS, OFFICERS, EMPLOYEES OR AGENTS BE LIABLE FOR ANY INDIRECT, SPECIAL, INCIDENTAL, OR CONSEQUENTIAL DAMAGES (INCLUDING DAMAGES FOR LOSS OF PROFITS, LOSS OF BUSINESS, LOSS OF USE OR DATA, INTERRUPTION OF BUSINESS AND THE LIKE), EVEN IF ASUS HAS BEEN ADVISED OF THE POSSIBILITY OF SUCH DAMAGES ARISING FROM ANY DEFECT OR ERROR IN THIS MANUAL OR PRODUCT.

SPECIFICATIONS AND INFORMATION CONTAINED IN THIS MANUAL ARE FURNISHED FOR INFORMATIONAL USE ONLY, AND ARE SUBJECT TO CHANGE AT ANY TIME WITHOUT NOTICE, AND SHOULD NOT BE CONSTRUED AS A COMMITMENT BY ASUS. ASUS ASSUMES NO RESPONSIBILITY OR LIABILITY FOR ANY ERRORS OR INACCURACIES THAT MAY APPEAR IN THIS MANUAL, INCLUDING THE PRODUCTS AND SOFTWARE DESCRIBED IN IT.

Products and corporate names appearing in this manual may or may not be registered trademarks or copyrights of their respective companies, and are used only for identification or explanation and to the owners' benefit, without intent to infringe.

Contents

Notices.....	iv
Safety information	v
Care & Cleaning.....	vi
Takeback Services.....	vii

Chapter 1: Product introduction

1.1	Welcome!	1-1
1.2	Package contents.....	1-1
1.3	Monitor introduction.....	1-2
1.3.1	Front view	1-2
1.3.2	Back view.....	1-3
1.3.3	GamePlus Function	1-4
1.3.4	TURBO Function.....	1-5

Chapter 2: Setup

2.1	Adjusting the monitor.....	2-1
2.2	Detaching the arm (for VESA wall mount).....	2-2
2.3	Connecting the cables.....	2-2
2.4	Turning on the monitor.....	2-3

Chapter 3: General instructions

3.1	OSD (On-Screen Display) menu	3-1
3.1.1	How to reconfigure.....	3-1
3.1.2	OSD function introduction.....	3-1
3.2	Specifications summary	3-3
3.3	Troubleshooting (FAQ).....	3-4
3.4	Supported operating mode	3-5

Notices

Federal Communications Commission Statement

This device complies with Part 15 of the FCC Rules. Operation is subject to the following two conditions:

- This device may not cause harmful interference, and
- This device must accept any interference received including interference that may cause undesired operation.

This equipment has been tested and found to comply with the limits for a Class B digital device, pursuant to Part 15 of the FCC Rules. These limits are designed to provide reasonable protection against harmful interference in a residential installation. This equipment generates, uses and can radiate radio frequency energy and, if not installed and used in accordance with manufacturer's instructions, may cause harmful interference to radio communications. However, there is no guarantee that interference will not occur in a particular installation. If this equipment does cause harmful interference to radio or television reception, which can be determined by turning the equipment off and on, the user is encouraged to try to correct the interference by one or more of the following measures:

- Reorient or relocate the receiving antenna.
- Increase the separation between the equipment and receiver.
- Connect the equipment to an outlet on a circuit different from that to which the receiver is connected.
- Consult the dealer or an experienced radio/TV technician for help.



The use of shielded cables for connection of the monitor to the graphics card is required to assure compliance with FCC regulations. Changes or modifications to this unit not expressly approved by the party responsible for compliance could void the user's authority to operate this equipment.



As an Energy Star® Partner, our company has determined that this product meets the Energy Star® guidelines for energy efficiency.

Canadian Department of Communications Statement

This digital apparatus does not exceed the Class B limits for radio noise emissions from digital apparatus set out in the Radio Interference Regulations of the Canadian Department of Communications.

This class B digital apparatus complies with Canadian ICES-003.

This Class B digital apparatus meets all requirements of the Canadian Interference - Causing Equipment Regulations.

Cet appareil numérique de la classe B respecte toutes les exigences du Règlement sur le matériel brouilleur du Canada.

Safety information

- Before setting up the monitor, carefully read all the documentation that came with the package.
- To prevent fire or shock hazard, never expose the monitor to rain or moisture.
- Never try to open the monitor cabinet. The dangerous high voltages inside the monitor may result in serious physical injury.
- If the power supply is broken, do not try to fix it by yourself. Contact a qualified service technician or your retailer.
- Before using the product, make sure all cables are correctly connected and the power cables are not damaged. If you detect any damage, contact your dealer immediately.
- Slots and openings on the back or top of the cabinet are provided for ventilation. Do not block these slots. Never place this product near or over a radiator or heat source unless proper ventilation is provided.
- The monitor should be operated only from the type of power source indicated on the label. If you are not sure of the type of power supply to your home, consult your dealer or local power company.
- Use the appropriate power plug which complies with your local power standard.
- Do not overload power strips and extension cords. Overloading can result in fire or electric shock.
- Avoid dust, humidity, and temperature extremes. Do not place the monitor in any area where it may become wet. Place the monitor on a stable surface.
- Unplug the unit during a lightning storm or if it will not be used for a long period of time. This will protect the monitor from damage due to power surges.
- Never push objects or spill liquid of any kind into the slots on the monitor cabinet.
- To ensure satisfactory operation, use the monitor only with UL listed computers which have appropriate configured receptacles marked between 100-240V AC.
- If you encounter technical problems with the monitor, contact a qualified service technician or your retailer.
- The adapter is only used for this monitor, do not use it for other purpose.
Your device uses one of the following power supplies:
 - Manufacturer: Delta Electronics Inc., Model: ADP-90YD BA2
 - Manufacturer: Asian Power Devices Inc., Model: APD 90F19



This symbol of the crossed out wheeled bin indicates that the product (electrical, electronic equipment, and mercury-containing button cell battery) should not be placed in municipal waste. Please check local regulations for disposal of electronic products.

AEEE yönetmeliğine uygundur

Care & Cleaning

- Before you lift or reposition your monitor, it is better to disconnect the cables and power cord. Follow the correct lifting techniques when positioning the monitor. When lifting or carrying the monitor, grasp the edges of the monitor. Do not lift the display by the stand or the cord.
- Cleaning. Turn your monitor off and unplug the power cord. Clean the monitor surface with a lint-free, non-abrasive cloth. Stubborn stains may be removed with a cloth dampened with mild cleaner.
- Avoid using a cleaner containing alcohol or acetone. Use a cleaner intended for use with the monitor. Never spray cleaner directly on the screen, as it may drip inside the monitor and cause an electric shock.

The following symptoms are normal with the monitor:

- The screen may flicker during the initial use due to the nature of the fluorescent light. Turn off the Power Switch and turn it on again to make sure that the flicker disappears.
- You may find slightly uneven brightness on the screen depending on the desktop pattern you use.
- When the same image is displayed for hours, an afterimage of the previous screen may remain after switching the image. The screen will recover slowly or you can turn off the Power Switch for hours.
- When the screen becomes black or flashes, or cannot work anymore, contact your dealer or service center to fix it. Do not repair the screen by yourself!

Conventions used in this guide



WARNING: Information to prevent injury to yourself when trying to complete a task.



CAUTION: Information to prevent damage to the components when trying to complete a task.



IMPORTANT: Information that you **MUST** follow to complete a task.



NOTE: Tips and additional information to aid in completing a task.

Where to find more information

Refer to the following sources for additional information and for product and software updates.

1. **ASUS websites**

The ASUS websites worldwide provide updated information on ASUS hardware and software products. Refer to <http://www.asus.com>

2. **Optional documentation**

Your product package may include optional documentation that may have been added by your dealer. These documents are not part of the standard package.

Takeback Services

ASUS recycling and takeback programs come from our commitment to the highest standards for protecting our environment. We believe in providing solutions for our customers to be able to responsibly recycle our products, batteries and other components as well as the packaging materials.

Please go to <http://csr.asus.com/english/Takeback.htm> for detail recycling information in different region.

1.1 Welcome!

Thank you for purchasing the ASUS® LCD monitor!

The latest widescreen LCD monitor from ASUS provides a broader, brighter and crystal-clear display, plus a host of features that enhance your viewing experience.

With these features, you can enjoy the convenience and delightful visual experience that the monitor brings to you!

1.2 Package contents

Check your package for the following items:

- ✓ LCD monitor
- ✓ Driver and Manual CD
- ✓ Quick start guide
- ✓ Warranty card
- ✓ Power adapter
- ✓ Power cord
- ✓ DP cable
- ✓ USB cable



If any of the above items is damaged or missing, contact your retailer immediately.



Select "ON" when you see the message "LIGHT IN MOTION ON/OFF" appears if you want to turn on the red light on the base. Select "OFF" if you want it to turn off. If you disable this function but later wish to reactivate it, please use the OSD menu to turn it on. The monitor is Energy Star 6.0 compatible when "LIGHT IN MOTION" is "OFF".









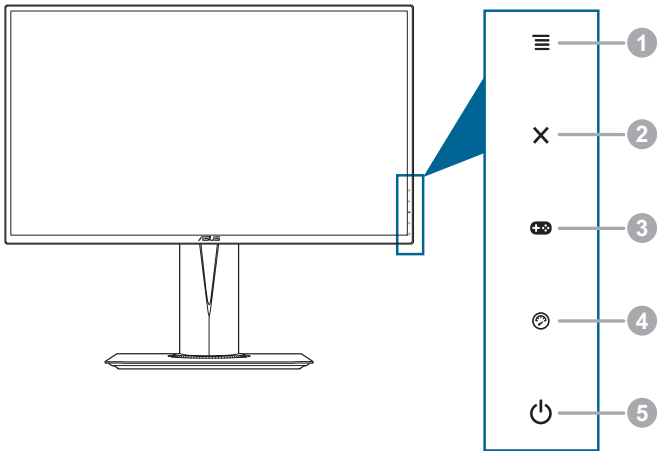



If no signal is detected for 120 seconds, the monitor automatically enters saving mode.

1.3 Monitor introduction

1.3.1 Front view



1.   5-way) button:
 - Turns on the OSD menu. Enacts the selected OSD menu item.
 - Increases/Decreases values or moves your selection up/down/left/right.
2.  button
 - Exits the OSD menu item.
3.  button:
 - GamePlus hotkey. Move the   button up/down to select and press   to confirm the function needed.
4.  button
 - TURBO hotkey. Press the button to select among different refresh rates.
5.  Power button/power indicator
 - Turns the monitor on/off.
 - The color definition of the power indicator is as the below table.

Status	Description
White	ON
Amber	Standby mode/No signal
OFF	OFF
Red	G-SYNC
Green	3D
Yellow	ULMB

1.3.2 Back view

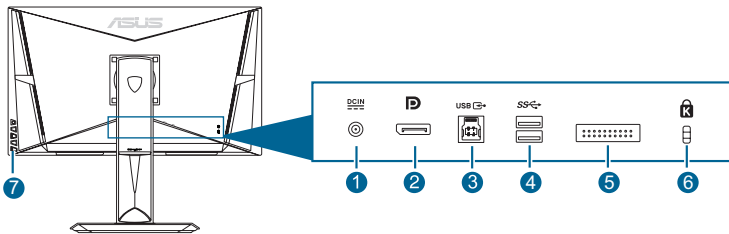

Rear connectors

1. **DC-IN port.** This port connects the power cord.
2. **DisplayPort.** This port is for connection for a DisplayPort compatible device.
3. **USB 3.0 upstream port.** This port is for connection with a USB upstream cable. The connection enables the USB ports on the monitor.
4. **USB 3.0 downstream ports.** These ports are for connection with USB devices, such as USB keyboard/mouse, USB flash drive, etc.
5. For service personnel only.
6. **Kensington lock slot.**
7. **Control buttons.**















DisplayPort supports 3D feature given NVIDIA 3D Vision Kit is available.

1.3.3 GamePlus Function

The GamePlus function provides a toolkit and creates a better gaming environment for users when playing different types of games. In addition, Crosshair function is specially designed for new gamers or beginners interested in First Person Shooter (FPS) games.

To active GamePlus:

1. Press the GamePlus hotkey.
2. Move the  () button up/down to select between Crosshair and Timer function.
3. Press the  () button or move the  () button right to confirm the function you choose, and move the  () button up/down to navigate through the settings.
4. Highlight the desired setting and press the  () button to activate it. Press the  button or move the  () button left to go back, off, and exit.

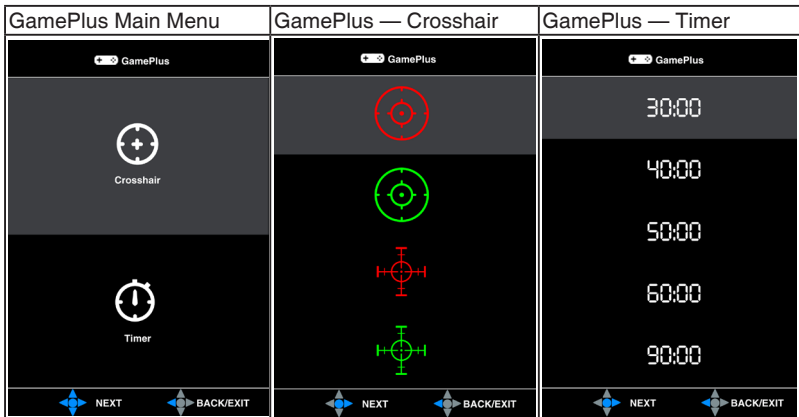

1.3.4 TURBO Function

The TURBO function helps you select among different refresh rates in a convenient way.

To active TURBO:

Press the TURBO hotkey repeatedly to select among 60Hz, 120Hz and 144Hz.

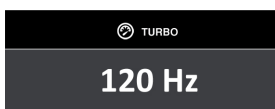
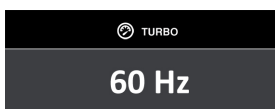

2.1 Adjusting the monitor

- For optimal viewing, we recommend that you look at the full face of the monitor, then adjust the monitor to the angle that is most comfortable for you.
- Hold the stand to prevent the monitor from falling when you change its angle.
- The recommended adjusting angle is $+22^{\circ}$ to -5° (for tilt)/ $+60^{\circ}$ to -60° (for swiveling/ ± 120 mm (for height adjustment)/ 90° (for portrait view).

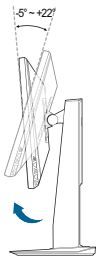

Figure 1

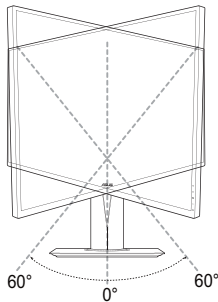

Figure 2

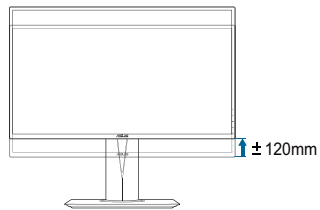

Figure 3



It is normal that the monitor slightly shakes while you adjust the viewing angle.

Pivoting the monitor

1. Lift the monitor to the highest position.
2. Tilt the monitor to its maximum angle.
3. Pivot the monitor clockwise to the angle you need.

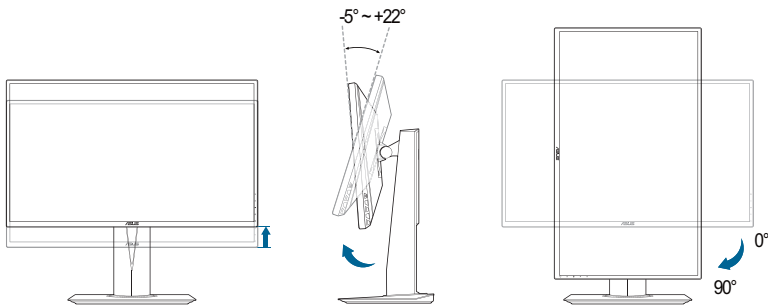

It is normal that the monitor slightly shakes while you adjust the viewing angle.

2.2 Detaching the arm (for VESA wall mount)

The detachable arm of this monitor is specially designed for VESA wall mount.

To detach the arm:

1. Have the front of the monitor face down on a table.
2. Loosen the four screws on the back of the monitor and remove the arm/base.

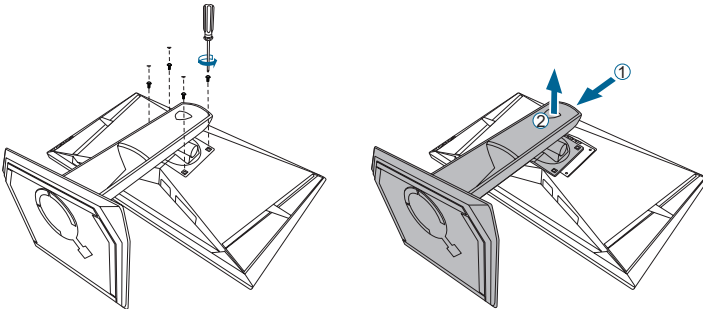

We recommend that you cover the table surface with soft cloth to prevent damage to the monitor.

2.3 Connecting the cables

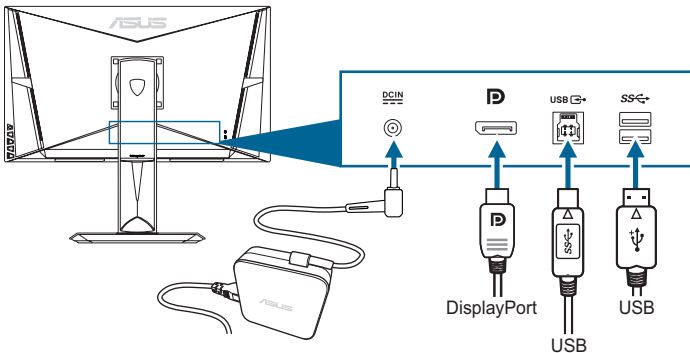

Connect the cables as the following instructions:



- **To connect the power cord:**
 - a. Connect the power adapter securely to the monitor's DC input.

- b. Connect one end of the power cord to the power adapter and the other end to a power outlet.
- **To connect the DisplayPort cable:**
 - a. Plug one end of the DisplayPort cable to the monitor's DisplayPort port.
 - b. Connect the other end of the DisplayPort cable to your computer's DisplayPort port.

2.4 Turning on the monitor

Press the power button . See page 1-2 for the location of the power button. The power indicator  lights up in blue to show that the monitor is ON.

3.1 OSD (On-Screen Display) menu

3.1.1 How to reconfigure

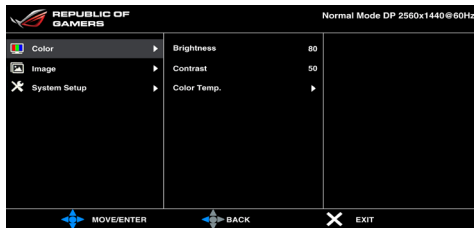

1. Press the () button to activate the OSD menu.
2. Move the () button up/down to navigate through the functions. Highlight the desired function and press the () button to activate it. If the function selected has a sub-menu, move the () button up/down again to navigate through the sub-menu functions. Highlight the desired sub-menu function and press the () button or move the () button right to activate it.
3. Move the () button up/down to change the settings of the selected function.
4. To exit and save the OSD menu, press the button or move the () left repeatedly until the OSD menu disappears. To adjust other functions, repeat steps 1-3.

3.1.2 OSD function introduction

1. Color

You can adjust Brightness, Contrast and Color temperature from this menu.

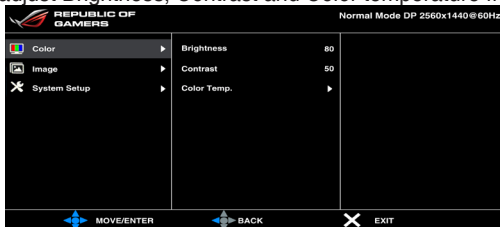

- **Brightness:** the adjusting range is from 0 to 100.
- **Contrast:** the adjusting range is from 0 to 100.
- **Color Temp.:** contains 4 modes including Cool, Normal, Warm, and User Mode.

2. Image

You can adjust OD and ULMB from this menu.



- **OD:** Improves the gray level response time of the LCD panel.
- **ULMB (Ultra Low Motion Blur):** Adjusts the level of motion blur reduction. This function is available when the refresh rate is 85Hz, 100Hz or 120Hz.

3. System Setup

Allows you to adjust the system.

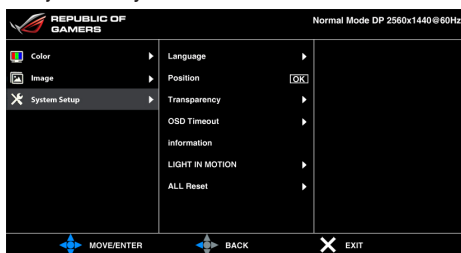

- **Language:** There are 21 languages for your selection, including English, French, German, Italian, Spanish, Dutch, Portuguese, Russian, Czech, Croatian, Polish, Romanian, Hungarian, Turkish, Simplified Chinese, Traditional Chinese, Japanese, Korean, Thai, Indonesia, Persian.
- **Position:** Adjusts the horizontal position (H-Position)/the vertical position (V-Position) of the OSD.
- **Transparency:** Adjusts the OSD background from opaque to transparent.
- **OSD Timeout:** Adjusts the OSD timeout from 10 to 120 seconds.
- **Information:** Shows the monitor information.
- **LIGHT IN MOTION:** Select "ON" if you want to turn on the red light on the base.
- **All Reset:** "Yes" allows you to restore the default settings.

3.2 Specifications summary

Panel Type	TFT LCD
Panel size	27"W (16:9, 68.47 cm) wide screen
Max. Resolution	2560 x 1440
Pixel pitch	0.233 mm
Brightness (Typ.)	350 cd/m ²
Contrast Ratio (Typ.)	1000:1
Viewing angle(H/V) CR>10	170°/160°
Display colors	16.7 M
Response time	1 ms
Color temperature selection	4 color temperatures
Digital input	DisplayPort v1.2 x 1
Colors	Black
Power LED	White (On)/Amber (Standby)
Tilt	+22° ~ -5°
Swivel	+60° ~ -60°
Height adjustment	120 mm
VESA wall mount	100 x 100 mm
Kensington lock	Yes
Voltage rating	AC: 100~240V DC: 19V, 4.74A (AC adapter)
Power consumption	Power On: < 90 W, Standby: < 0.5 W, Power Off: < 0.5 W
Temperature (Operating)	0°C~40°C
Temperature (Non-operating)	-20°C~+60°C
Dimensions (W x H x D)	619.7 mm x 362.9 mm x 237.9 mm (machine) 756 mm x 456 mm x 300 mm (package)
Weight (Esti.)	7 kg (Net); 10.5 kg (Gross)
Multi-languages	21 languages (English, French, German, Italian, Spanish, Dutch, Portuguese, Russian, Czech, Croatian, Polish, Romanian, Hungarian, Turkish, Simplified Chinese, Traditional Chinese, Japanese, Korean, Thai, Indonesia, Persian)
Accessories	DP cable, USB cable, power adapter, power cord, Driver and Manual CD, Quick start guide, warranty card
Regulation approvals	Energy Star®, CB, CE, CU, CCC, UL/cUL, FCC, C-Tick, BSMI, VCCI, RoHS, WEEE, J-MOSS, ErP, PSE, CEL Level 1, Windows 7 WHQL, Windows 8.1 WHQL, KCC, E-Standby

*Specifications are subject to change without notice.

3.3 Troubleshooting (FAQ)

Problem	Possible Solution
Power LED is not ON	<ul style="list-style-type: none"> • Press the ⏻ button to check if the monitor is in the ON mode. • Check if the power cord is properly connected to the monitor and the power outlet.
The power LED lights amber and there is no screen image	<ul style="list-style-type: none"> • Check if the monitor and the computer are in the ON mode. • Make sure the signal cable is properly connected the monitor and the computer. • Inspect the signal cable and make sure none of the pins are bent. • Connect the computer with another available monitor to check if the computer is properly working.
Screen image is too light or dark	<ul style="list-style-type: none"> • Adjust the Contrast and Brightness settings via OSD.
Screen image is not centered or sized properly	<ul style="list-style-type: none"> • Adjust the H-Position or V-Position settings via OSD.
Screen image bounces or a wave pattern is present in the image	<ul style="list-style-type: none"> • Make sure the signal cable is properly connected to the monitor and the computer. • Move electrical devices that may cause electrical interference.
Screen image has color defects (white does not look white)	<ul style="list-style-type: none"> • Inspect the signal cable and make sure that none of the pins are bent. • Perform All Reset via OSD. • Adjust the R/G/B color settings or select the Color Temperature via OSD.

3.4 Supported operating mode

Resolution	Frequency	Refresh Rate
1280x960		60Hz
1280x1024		60Hz
1360x768		60Hz
1366x768		60Hz
1440x900		60Hz
1600x1200		60Hz
1680x1050		60Hz
1920x1080		60Hz
2560x1440		60Hz
2560x1440		85Hz
2560x1440		100Hz
2560x1440		120Hz
2560x1440		144Hz

Note:

G-SYNC supported NVIDIA GPUs: GeForce GTX TITAN Black, GeForce GTX TITAN, GeForce GTX 780 Ti, GeForce GTX 780, GeForce GTX 770, GeForce GTX 760, GeForce GTX 750 Ti, GeForce GTX 750, GeForce GTX 690, GeForce GTX 680, GeForce GTX 670, GeForce GTX 660 Ti, GeForce GTX 660, GeForce GTX 650 Ti BOOST. For other GPUs, please contact the manufactures whether they can support or not.

The monitor is purposely supporting the NVIDIA G-SYNC technology and targeting NVIDIA graphics solutions. The low resolution modes (640x480, 800x600, 1024x768) are not the supported timings of the monitor.

Free Manuals Download Website

<http://myh66.com>

<http://usermanuals.us>

<http://www.somanuals.com>

<http://www.4manuals.cc>

<http://www.manual-lib.com>

<http://www.404manual.com>

<http://www.luxmanual.com>

<http://aubethermostatmanual.com>

Golf course search by state

<http://golfingnear.com>

Email search by domain

<http://emailbydomain.com>

Auto manuals search

<http://auto.somanuals.com>

TV manuals search

<http://tv.somanuals.com>