

E760

ASUS[®] CUV4X-CME
PC133 AGP-4X Motherboard

USER'S MANUAL

Product Name: **ASUS CUV4X-CME**

Manual Revision: **1.02 E760**

Release Date: **April 2001**

FEATURES

Motherboard Components

See opposite page for locations.

	Location
Processor Support Socket 370 for Pentium III/Celeron Processors	2
Chipsets VIA VT82C694X North Bridge	1
VIA VT82C686B South Bridge	9
2Mbit Programmable Flash EEPROM	8
Main Memory 2 DIMM Sockets	4
PC133 SDRAM support up to 1GB	
Expansion Slots 3 PCI Slots	12
1 Accelerated Graphics Port (AGP) 4X Slot	13
System I/O 1 Floppy Disk Drive Connector	6
2 IDE Connectors (UltraDMA66 Support)	5
1 Parallel Port	(Top) 15
2 Serial Ports (COM1/COM 2)	(Bottom) 15
USB Connectors (Port 0 & Port 1)	16
USB Connectors (Port 2 & Port 3)	7
1 PS/2 Mouse Connector	(Top) 17
1 PS/2 Keyboard Connector	(Bottom) 17
Audio Features (on audio models only)	
Creative CT5880 Audio Chipset	10
AC'97 V2.1 Audio Codec	11
1 Game/MIDI Connector	(Top) 14
1 Line Out Connector	(Bottom) 14
1 Line In Connector	(Bottom) 14
1 Microphone Connector	(Bottom) 14
Power Power Supply Connector	3
Form Factor Micro ATX	

FEATURES

Component Locations

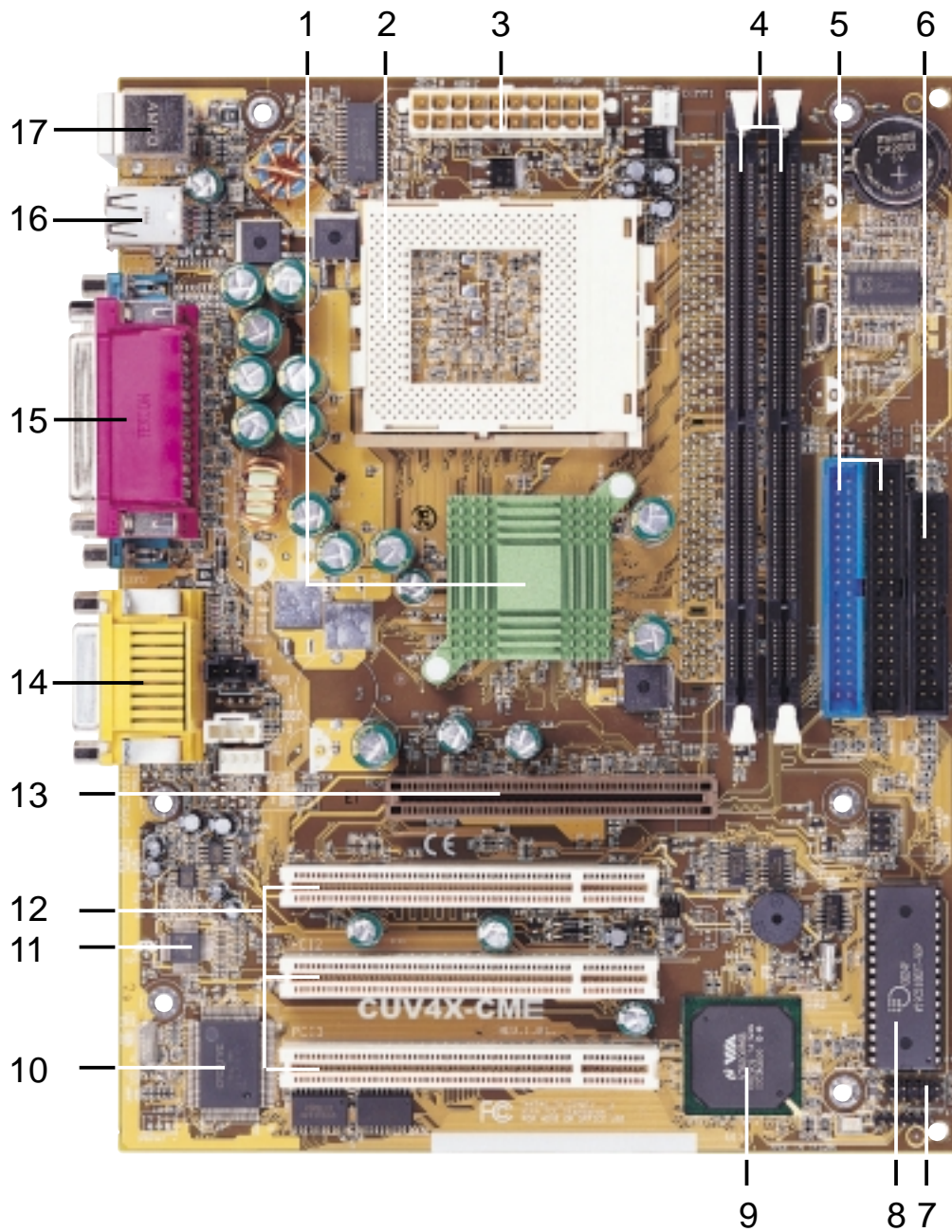

FEATURES

Motherboard Layout

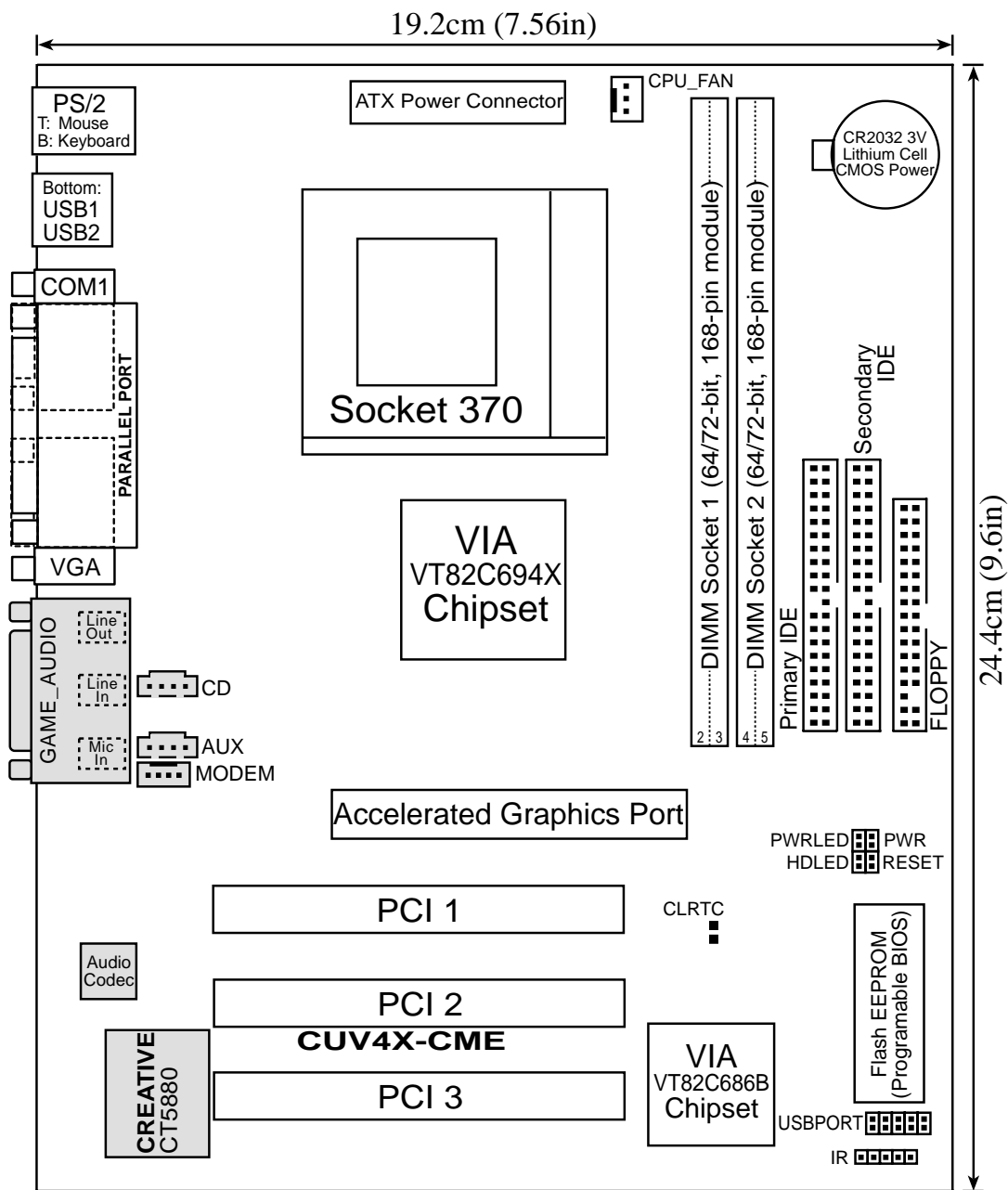

NOTE: The Creative CT5880 audio chipset, external GAME/AUDIO connectors, and internal audio connectors are optional components, and present in audio models only. The components are grayed in the above motherboard layout.

HARDWARE SETUP

Connectors

External Connectors

1) PS/2 Mouse Connector (Green 6-pin PS2KBMS)

This connector is for a standard PS/2 mouse.

PS/2 Mouse (6-pin Female)

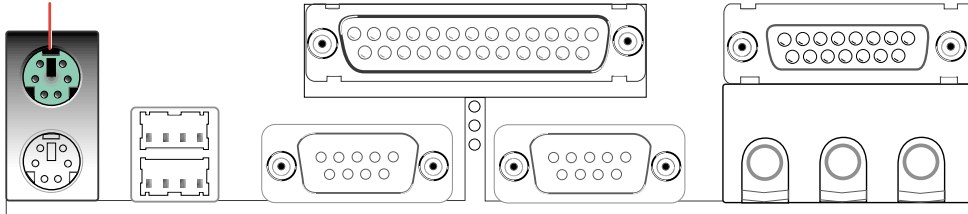

2) PS/2 Keyboard Connector (Purple 6-pin PS2KBMS)

This connector is for a standard keyboard using an PS/2 plug (mini DIN).

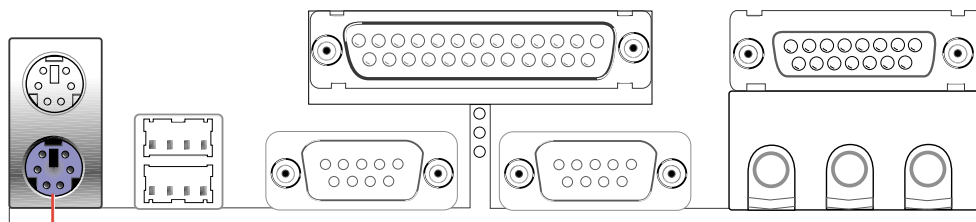

PS/2 Keyboard (6-pin Female)

3) Universal Serial BUS Ports 1 & 2 (Black two 4-pin USB)

Two USB ports are available for connecting USB devices.

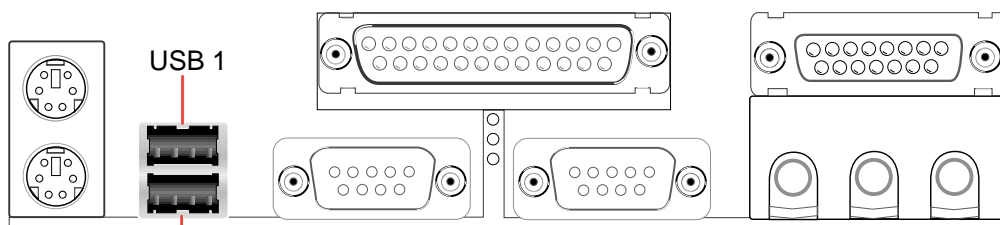

Universal Serial Bus (USB) 2

HARDWARE SETUP

4) Serial Port Connectors (Teal/Turquoise 9-pin COM1 / 9-pin COM2)

Two serial ports are available for pointing devices or other serial devices.

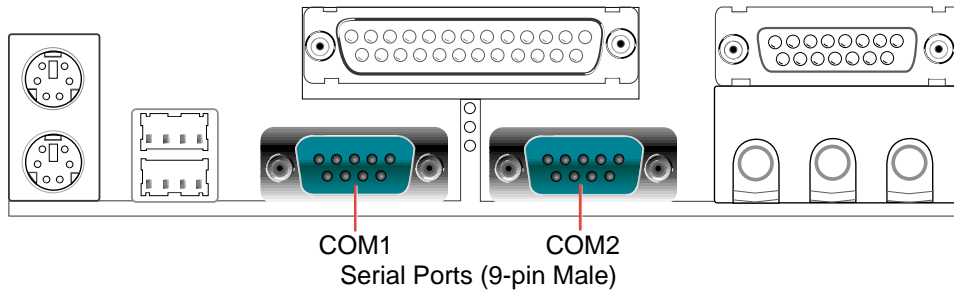

5) Parallel Port Connector (Burgundy 25-pin PRINTER)

A parallel port is available for a parallel printer.

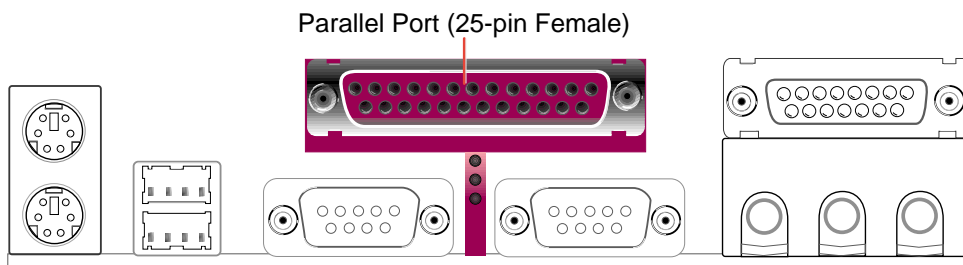

6) Game/MIDI Connector (Gold 15-pin GAME_AUDIO) (optional)

This connector supports a joystick or a game pad for playing games, and MIDI devices for playing or editing audio files.

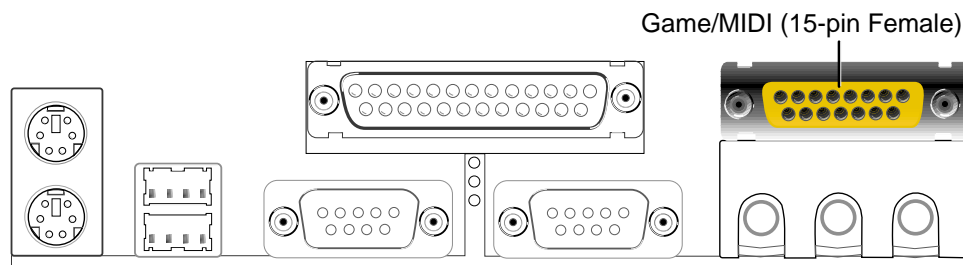

7) Audio Connectors (Three 1/8" AUDIO) (optional)

The **Line Out** (lime) connects a headphone or speakers. The **Line In** (light blue) connects a tape players or other audio sources. The **Mic** (pink) connects a microphone.

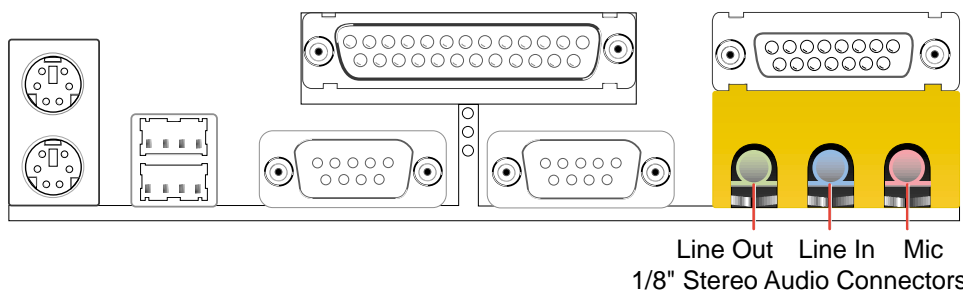

HARDWARE SETUP

Internal Connectors

WARNING! Some pins are used for connectors or power sources. These are clearly distinguished from jumpers in the Motherboard Layout. Placing jumper caps over these connector pins will cause damage to your motherboard.

IMPORTANT: Always connect ribbon cables with the red stripe to Pin 1 on the connectors. Pin 1 is usually on the side closest to the power connector on hard drives and CD-ROM drives, but may be on the opposite side on floppy disk drives.

1) Primary (Blue) / Secondary IDE Connectors (40-pin IDE1/IDE2)

These connectors support the provided UltraDMA/66 IDE hard disk ribbon cable. Connect the cable's blue connector to the primary (recommended) or secondary IDE connector, then connect the gray connector to the UltraDMA/66 slave device (hard disk drive) and the black connector to the UltraDMA/66 master device. It is recommended that non-UltraDMA/66 devices be connected to the secondary IDE connector. If you install two hard disks, you must configure the second drive to Slave mode by setting its jumper accordingly. Refer to the hard disk documentation for the jumper settings.

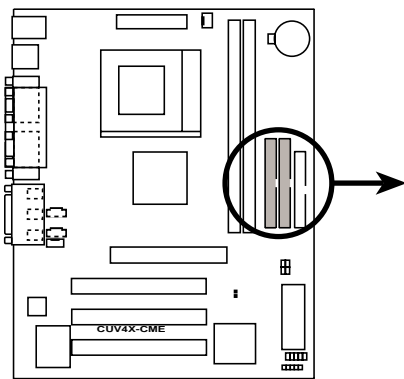

CUV4X-CME IDE Connectors

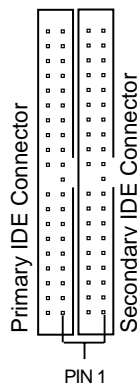

NOTE: Orient the red markings (usually zigzag) on the IDE ribbon cable to PIN 1.

HARDWARE SETUP

2) Floppy Disk Drive Connector (34-1 pin FLOPPY)

This connector supports the provided floppy drive ribbon cable. After connecting the single end to the board, connect the two plugs on the other end to the floppy drives.

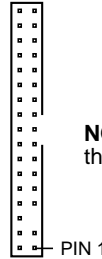
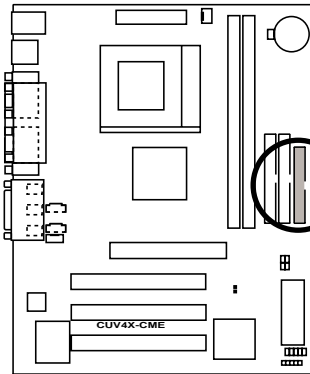

NOTE: Orient the red markings on the floppy ribbon cable to PIN 1

CUV4X-CME Floppy Disk Drive Connector

3) ATX Power Supply Connector (20-pin block ATXPWR)

This connector connects to an ATX power supply. The plug from the power supply fits in only one orientation because of the different hole sizes. Find the proper orientation and push down firmly making sure that the pins are aligned.

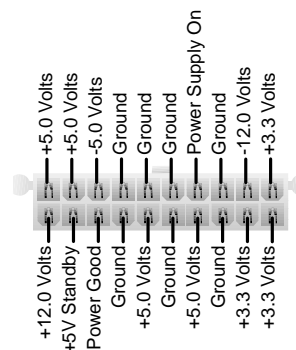
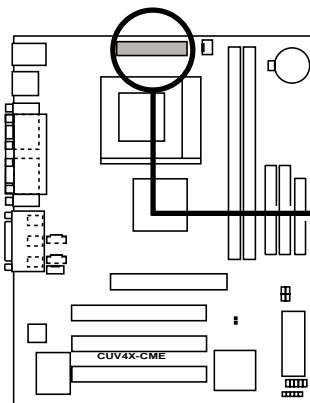

CUV4X-CME ATX Power Connector

HARDWARE SETUP

4) CPU Fan Connector (3-pin CPU_FAN)

The CPU fan connector supports cooling fans of 350mA (4.2 Watts) or less. The fan wiring and plug may vary depending on the fan manufacturer. The red wire should be positive while the black should be ground. Connect the fan plug to the board taking into consideration the polarity of the connector.

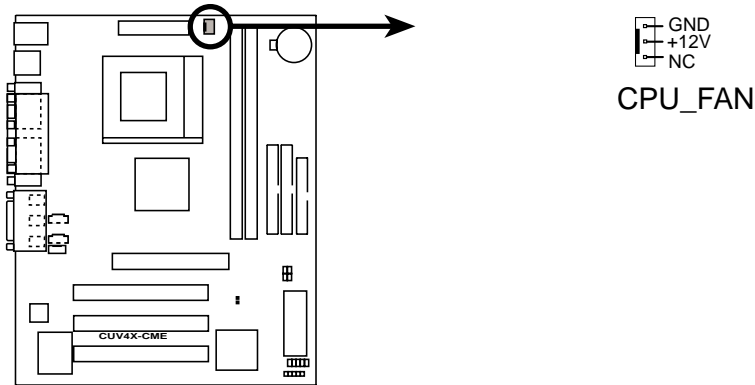

CUV4X-CME 12-Volt Cooling Fan Power

5) USB Header (10-1 pin USBPORT) (*optional*)

If the USB port connectors on the back panel are inadequate, one USB header is available for two additional USB port connectors. Connect the USB header to a 2-port USB connector set and mount the bracket to an open slot on the chassis. (NOTE: The USB connector set does not come with the motherboard package.)

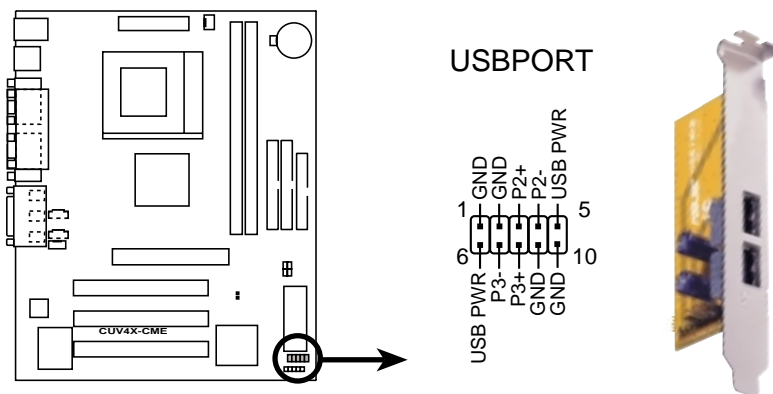

CUV4X-CME Front Panel USB Header

HARDWARE SETUP

6) Standard Infrared Module Connector (5-pin IR)

This connector supports an optional wireless transmitting and receiving infrared module. The infrared module mounts to a small opening on system cases that support this feature. Use the five pins as shown in Back View and connect a ribbon cable from the module to the motherboard SIR connector according to the pin definitions.

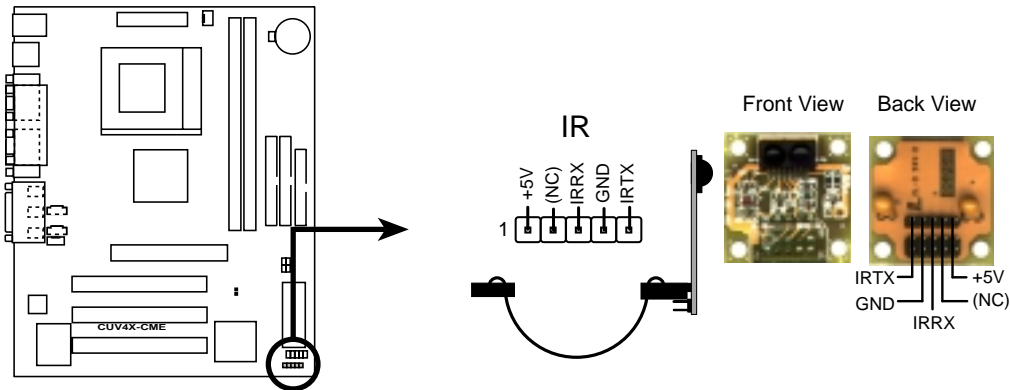

CUV4X-CME Infrared Module Connector

7) Internal Audio Connectors (4-pin CD_IN, AUX, VIDEO, MODEM)

These connectors allow you to receive stereo audio input from sound sources as a CD-ROM, TV tuner, or MPEG card. The MODEM connector allows the onboard audio to interface with a voice modem card with a similar connector. It also allows the sharing of mono_in (such as a phone) and a mono_out (such as a speaker) between the audio and a voice modem card.

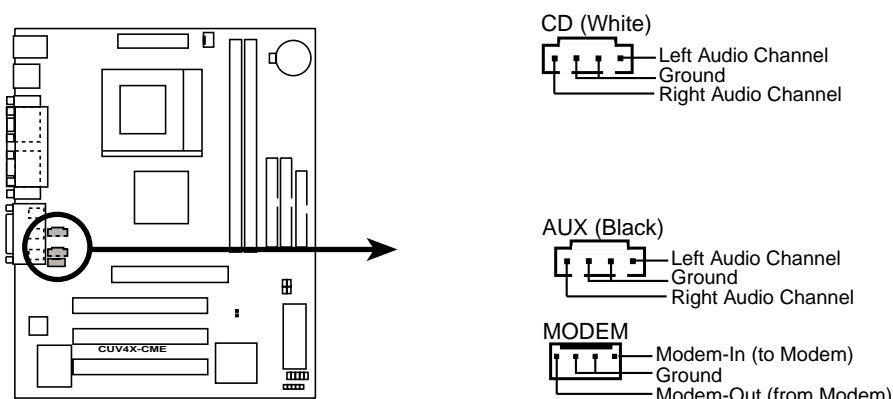

CUV4X-CME Internal Audio Connectors

HARDWARE SETUP

The following PANEL illustration is for items 8-11.

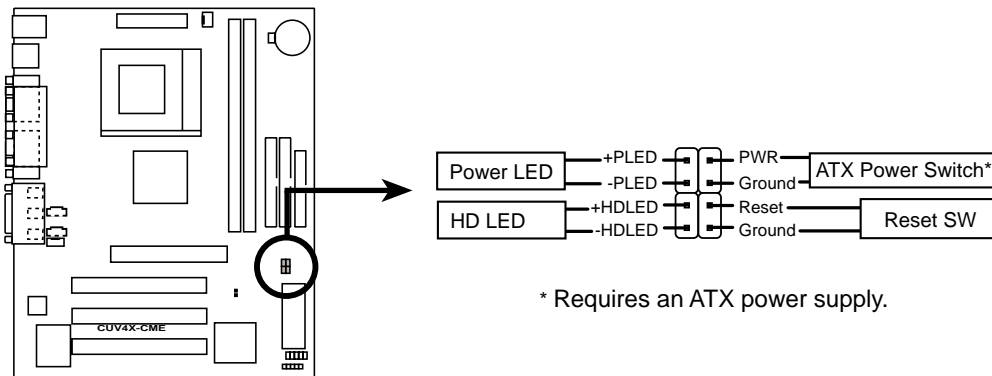

CUV4X-CME System Panel Connectors

8) System Power LED Connector(2-pin PWRLED)

This 3-1 pin connector connects to the system power LED. The LED lights up when you turn on the system power, and blinks when the system is in sleep or soft-off mode.

9) Hard Disk LED Connector (2-pin HDLED)

This 2-pin connector is for the hard disk LED. This LED blinks during hard disk operation.

10) ATX Power Switch Connector (2-pin PWR)

The system power is controlled by a momentary switch attached to this connector.

11) Reset Switch Connector (2-pin RESET)

This 2-pin connector connects to the case-mounted reset switch for rebooting the system without turning off the power switch. This is a preferred method

HARDWARE SETUP

Starting Up the First Time

1. After making all the connections, replace the system case cover.
2. Be sure that all switches are off (in some systems, marked with ○).
3. Connect the power cord to the power connector at the back of the system chassis.
4. Connect the power cord to a power outlet that is equipped with a surge protector.
5. Turn on the devices in the following order:
 - a. Monitor
 - b. External SCSI devices (starting with the last device on the chain)
 - c. System power (For ATX power supplies, you need to switch on the power supply as well as press the ATX power switch on the front of the chassis.)
6. The power LED on the front panel of the system case lights up. For ATX power supplies, the system LED lights up when you press the ATX power switch. If the monitor complies with “green” standards or if it has a power standby feature, the monitor LED may light up or switch between orange and green after the system LED does. The system then runs the power-on tests. While the tests are running, the BIOS beeps or additional messages appear on the screen. If you do not see anything within 30 seconds from the time you turn on the power, the system may have failed a power-on test. Check the jumper settings and connections or call your retailer for assistance.

Award BIOS Beep Codes

Beep	Meaning
One short beep when displaying logo	No error during POST
Long beeps in an endless loop	No DRAM installed or detected
One long beep followed by three short beeps	Video card not found or video card memory bad
High frequency beeps when system is working	CPU overheated System running at a lower frequency

7. At power on, hold down <Delete> to enter BIOS Setup. Follow the instructions in **4. BIOS SETUP**.
- * **Powering Off the computer:** You must first exit or shut down the system before switching off the power switch. For ATX power supplies, you can press the ATX power switch after exiting or shutting down the operating system. If you use Windows 9X, click the **Start** button, click **Shut Down**, then click **Shut down the computer?** The power supply should turn off after Windows shuts down.
NOTE: The message “You can now safely turn off your computer” does not appear when shutting down with ATX power supplies.

HARDWARE SETUP

Managing and Updating Your BIOS

Upon First Use of the Computer System

It is recommended that you save a copy of the original motherboard BIOS along with a Flash Memory Writer utility (AFLASH.EXE) to a bootable floppy disk in case you need to reinstall the BIOS later. **AFLASH.EXE** is a Flash Memory Writer utility that updates the BIOS by uploading a new BIOS file to the programmable flash ROM on the motherboard. This file works only in DOS mode. To determine the BIOS version of your motherboard, check the last four numbers of the code displayed on the upper left-hand corner of your screen during bootup. Larger numbers represent a newer BIOS file.

1. Type **FORMAT A:/S** at the DOS prompt to create a bootable system disk. **DO NOT** copy AUTOEXEC.BAT and CONFIG.SYS to the disk.
2. Type **COPY D:\AFLASH\AFLASH.EXE A:** (assuming D is your CD-ROM drive) to copy AFLASH.EXE to the boot disk you created.
NOTE: AFLASH works only in DOS mode. It does not work in the DOS prompt within Windows and does not work with certain memory drivers that may be loaded when you boot from the hard drive. It is recommended that you reboot using a floppy disk.
3. Reboot the computer from the floppy disk.

- NOTE:** BIOS setup must specify “Floppy” as the first item in the boot sequence.
4. In DOS mode, type **A:\AFLASH <Enter>** to run AFLASH.

```
ASUS ACPI BIOS
FLASH MEMORY WRITER V1.29
Copyright (C) 1994-99, ASUS/TEK COMPUTER INC.

Flash Memory: Winbond W29C020 or SST 25EE820 or Intel B28H20E

Current BIOS Version: ASUS XXX-XX ACPI BIOS Revision 100X
BIOS Model          : XXX-XX
BIOS Built Date     : 00/25/00

Choose one of the followings:
1. Save Current BIOS To File
2. Update BIOS Including Boot Block and ESCD

Enter choice: [1]

Press ESC To Exit
```

IMPORTANT! If the word “unknown” appears after **Flash Memory:**, the memory chip is either not programmable or is not supported by the ACPI BIOS and therefore, cannot be programmed by the Flash Memory Writer utility.

HARDWARE SETUP

5. Select **1. Save Current BIOS to File** from the Main menu and press <Enter>. The **Save Current BIOS To File** screen appears.

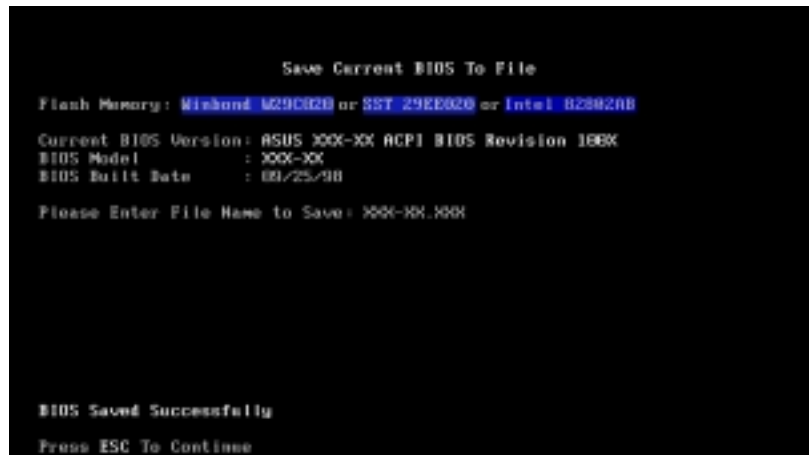

6. Type a filename and the path, for example, **A:\XXX-XX.XXX** and then press <Enter>.

HARDWARE SETUP

Updating BIOS Procedures

WARNING! Update the BIOS only if you have problems with the motherboard and you know that the new BIOS revision will solve your problems. Careless updating can result in your motherboard having more problems!

1. Download an updated ASUS BIOS file from the Internet (WWW or FTP) (see ASUS CONTACT INFORMATION on page 3 for details) and save to the boot floppy disk you created earlier.
2. Boot from the floppy disk.
3. At the "A:\\" prompt, type **AFLASH** and then press <Enter>.
4. At the **Main Menu**, type **2** then press <Enter>. The **Update BIOS Including Boot Block and ESCD** screen appears.
5. Type the filename of your new BIOS and the path, for example, **A:\XXX-XX.XXX**, then press <Enter>.

NOTE: To cancel this operation, press <Enter>.

```
Update BIOS Including Boot Block and ESCD
Flash Memory: Winbond W29C020 or SST 29EE020 or Intel 0280200
Current BIOS Version: ASUS XXX-XX ACPI BIOS Revision 100K
BIOS Model          : XXX-XX
BIOS Built Date     : 05/25/98
Please Enter File Name for NEW BIOS: a:\XXX-XX.XXX
```

6. When prompted to confirm the BIOS update, press **Y** to start the update.

```
Update BIOS Including Boot Block and ESCD
Flash Memory: Winbond W29C020 or SST 29EE020 or Intel 0280200
BIOS Version
[CURRENT ] ASUS 1000-100 ACPI BIOS Revision 100K
[Test.ewd] ASUS 1000-100 ACPI BIOS Revision 100K
BIOS Model
[CURRENT ] 1000-100
[Test.ewd] 1000-100
Date of BIOS Built
[CURRENT ] 05/25/98
[XXXX.XXXX] 05/29/98
Check sum of 1001.010 is F256.
Are you sure (Y/N) ? [Y]
Press ESC To Return to Main Menu
```

HARDWARE SETUP

- The utility starts to program the new BIOS information into the Flash ROM. The boot block is updated automatically only when necessary. This minimizes the possibilities of boot problems in case of update failures. When the programming is done, *Flashed Successfully* appears.

```
Update BIOS Including Boot Block and ESCD
Flash Memory: Winbond W29C020 or SST 29EE020 or Intel B28020B
BIOS Version
(CURRENT) ASUS XXX-XX ACPI BIOS Revision 180X
(Inst. and) ASUS XXX-XX ACPI BIOS Revision 180X
BIOS Model
(CURRENT) XXX-XX
(Inst. and) XXX-XX
Date of BIOS Built
(CURRENT) 09/25/99
(INST. AND) 05/29/98
Check sum of 1001,810 is F266.
Are you sure (Y/N) ? [Y]
Block Erasing -- Done
Programming -- 3FFFF
Flashed Successfully
Press ESC To Continue
```

- Follow the onscreen instructions to continue.

```
ASUS ACPI BIOS
FLASH MEMORY WRITER V1.20
Copyright (C) 1994-99, ASUSTeK COMPUTER INC.
Flash Memory: Winbond W29C020 or SST 29EE020 or Intel B28020B
Current BIOS Version: ASUS XXX-XX ACPI BIOS Revision 180X
BIOS Model : XXX-XX
BIOS Built Date : 05/29/98
Choose one of the following:
1. Save Current BIOS To File
2. Update BIOS Including Boot Block and ESCD
Enter choice: [1]
You have flashed the EPROM. It is recommended that you turn off
the power, enter SETUP and Load Setup Defaults to have CMOS
updated with new BIOS when exits.
Press ESC To Exit
```

WARNING! If you encounter problems while updating the new BIOS, DO NOT turn off the system because this may cause boot problems. Just repeat the process, and if the problem still persists, load the original BIOS file you saved to the boot disk. If the Flash Memory Writer utility is not able to successfully update a complete BIOS file, the system may not boot. If this happens, call the ASUS service center for support.

Free Manuals Download Website

<http://myh66.com>

<http://usermanuals.us>

<http://www.somanuals.com>

<http://www.4manuals.cc>

<http://www.manual-lib.com>

<http://www.404manual.com>

<http://www.luxmanual.com>

<http://aubethermostatmanual.com>

Golf course search by state

<http://golfingnear.com>

Email search by domain

<http://emailbydomain.com>

Auto manuals search

<http://auto.somanuals.com>

TV manuals search

<http://tv.somanuals.com>