

**M3N78-VM**



# Motherboard

E3849

First Edition

May 2008

**Copyright © 2008 ASUSTeK COMPUTER INC. All Rights Reserved.**

No part of this manual, including the products and software described in it, may be reproduced, transmitted, transcribed, stored in a retrieval system, or translated into any language in any form or by any means, except documentation kept by the purchaser for backup purposes, without the express written permission of ASUSTeK COMPUTER INC. ("ASUS").

Product warranty or service will not be extended if: (1) the product is repaired, modified or altered, unless such repair, modification or alteration is authorized in writing by ASUS; or (2) the serial number of the product is defaced or missing.

ASUS PROVIDES THIS MANUAL "AS IS" WITHOUT WARRANTY OF ANY KIND, EITHER EXPRESS OR IMPLIED, INCLUDING BUT NOT LIMITED TO THE IMPLIED WARRANTIES OR CONDITIONS OF MERCHANTABILITY OR FITNESS FOR A PARTICULAR PURPOSE. IN NO EVENT SHALL ASUS, ITS DIRECTORS, OFFICERS, EMPLOYEES OR AGENTS BE LIABLE FOR ANY INDIRECT, SPECIAL, INCIDENTAL, OR CONSEQUENTIAL DAMAGES (INCLUDING DAMAGES FOR LOSS OF PROFITS, LOSS OF BUSINESS, LOSS OF USE OR DATA, INTERRUPTION OF BUSINESS AND THE LIKE), EVEN IF ASUS HAS BEEN ADVISED OF THE POSSIBILITY OF SUCH DAMAGES ARISING FROM ANY DEFECT OR ERROR IN THIS MANUAL OR PRODUCT.

SPECIFICATIONS AND INFORMATION CONTAINED IN THIS MANUAL ARE FURNISHED FOR INFORMATIONAL USE ONLY, AND ARE SUBJECT TO CHANGE AT ANY TIME WITHOUT NOTICE, AND SHOULD NOT BE CONSTRUED AS A COMMITMENT BY ASUS. ASUS ASSUMES NO RESPONSIBILITY OR LIABILITY FOR ANY ERRORS OR INACCURACIES THAT MAY APPEAR IN THIS MANUAL, INCLUDING THE PRODUCTS AND SOFTWARE DESCRIBED IN IT.

Products and corporate names appearing in this manual may or may not be registered trademarks or copyrights of their respective companies, and are used only for identification or explanation and to the owners' benefit, without intent to infringe.

# Contents

Notices.....	vi
Safety information .....	vii
About this guide .....	viii
M3N78-VM specifications summary.....	x
<b>Chapter 1: Product introduction</b>	
<b>1.1 Welcome!</b> .....	<b>1-2</b>
<b>1.2 Package contents</b> .....	<b>1-2</b>
<b>1.3 Special features</b> .....	<b>1-2</b>
1.3.1 Product highlights .....	1-2
1.3.2 Innovative ASUS features .....	1-5
<b>1.4 Before you proceed</b> .....	<b>1-7</b>
<b>1.5 Motherboard overview</b> .....	<b>1-8</b>
1.5.1 Motherboard layout.....	1-8
1.5.2 Placement direction .....	1-9
1.5.3 Screw holes .....	1-9
<b>1.6 Central Processing Unit (CPU)</b> .....	<b>1-10</b>
1.6.1 Installing the CPU .....	1-10
1.6.2 Installing the heatsink and fan .....	1-12
<b>1.7 System memory</b> .....	<b>1-14</b>
1.7.1 Overview .....	1-14
1.7.2 Memory configurations.....	1-14
1.7.3 Installing a DIMM .....	1-18
1.7.4 Removing a DIMM .....	1-18
<b>1.8 Expansion slots</b> .....	<b>1-19</b>
1.8.1 Installing an expansion card .....	1-19
1.8.2 Configuring an expansion card .....	1-19
1.8.3 PCI slots.....	1-22
1.8.4 PCI Express x1 slot.....	1-22
1.8.5 PCI Express x16 slot.....	1-22
<b>1.9 Jumper</b> .....	<b>1-23</b>
<b>1.10 Connectors</b> .....	<b>1-24</b>
1.10.1 Rear panel connectors.....	1-24
1.10.2 Internal connectors .....	1-27

# Contents

## Chapter 2: BIOS setup

<b>2.1</b>	<b>Managing and updating your BIOS .....</b>	<b>2-2</b>
2.1.1	Creating a bootable floppy disk.....	2-2
2.1.2	ASUS EZ Flash 2 utility.....	2-4
2.1.3	AFUDOS utility.....	2-5
2.1.4	ASUS CrashFree BIOS 3 utility .....	2-7
2.1.5	ASUS Update utility .....	2-9
<b>2.2</b>	<b>BIOS setup program .....</b>	<b>2-12</b>
2.2.1	BIOS menu screen.....	2-13
2.2.2	Menu bar.....	2-13
2.2.3	Navigation keys.....	2-14
2.2.4	Menu items .....	2-14
2.2.5	Sub-menu items.....	2-14
2.2.6	Configuration fields .....	2-14
2.2.7	Pop-up window .....	2-14
2.2.8	Scroll bar.....	2-14
2.2.9	General help .....	2-14
<b>2.3</b>	<b>Main menu .....</b>	<b>2-15</b>
2.3.1	System Time .....	2-15
2.3.2	System Date .....	2-15
2.3.3	Legacy Diskette A .....	2-15
2.3.4	Primary IDE Master/Slave, SATA1~3, ESATA.....	2-16
2.3.5	Storage Configuration .....	2-18
2.3.6	System Information.....	2-19
<b>2.4</b>	<b>Advanced menu .....</b>	<b>2-20</b>
2.4.1	JumperFree Configuration .....	2-20
2.4.2	CPU Configuration.....	2-22
2.4.3	Chipset.....	2-23
2.4.4	Onboard Devices Configuration.....	2-27
2.4.5	PCI PnP .....	2-28
2.4.6	USB Configuration .....	2-29
2.4.7	Trusted Computing.....	2-30
<b>2.5</b>	<b>Power menu.....</b>	<b>2-31</b>
2.5.1	Suspend Mode .....	2-31
2.5.2	ACPI 2.0 Support .....	2-31

# Contents

2.5.3	ACPI APIC Support .....	2-31
2.5.4	APM Configuration.....	2-32
2.5.5	Hardware Monitor .....	2-33
<b>2.6</b>	<b>Boot menu .....</b>	<b>2-34</b>
2.6.1	Boot Device Priority .....	2-34
2.6.2	Boot Settings Configuration .....	2-35
2.6.3	Security .....	2-36
<b>2.7</b>	<b>Tools menu .....</b>	<b>2-38</b>
2.7.1	ASUS EZ Flash 2.....	2-38
2.7.2	Express Gate .....	2-39
2.7.3	AI NET 2.....	2-39
<b>2.8</b>	<b>Exit menu .....</b>	<b>2-40</b>

## Chapter 3: Software support

<b>3.1</b>	<b>Installing an operating system .....</b>	<b>3-2</b>
<b>3.2</b>	<b>Support DVD information.....</b>	<b>3-2</b>
3.2.1	Running the support DVD .....	3-2
3.2.2	Drivers menu.....	3-3
3.2.3	Utilities menu .....	3-4
3.2.4	Make Disk menu .....	3-6
3.2.5	Manual menu .....	3-8
3.2.6	ASUS Contact information .....	3-8
3.2.7	Other information .....	3-9
<b>3.3</b>	<b>Creating a RAID driver disk.....</b>	<b>3-11</b>
3.3.1	Creating a RAID driver disk without entering the OS.....	3-11
3.3.2	Creating a RAID driver disk in Windows®.....	3-11

## Chapter 4: NVIDIA® technology support

<b>4.1</b>	<b>NVIDIA® Hybrid SLI® Technology .....</b>	<b>4-2</b>
4.1.1	System requirements .....	4-2
4.1.2	Enabling Hybrid SLI .....	4-3

# Notices

## Federal Communications Commission Statement

This device complies with Part 15 of the FCC Rules. Operation is subject to the following two conditions:

- This device may not cause harmful interference, and
- This device must accept any interference received including interference that may cause undesired operation.

This equipment has been tested and found to comply with the limits for a Class B digital device, pursuant to Part 15 of the FCC Rules. These limits are designed to provide reasonable protection against harmful interference in a residential installation. This equipment generates, uses and can radiate radio frequency energy and, if not installed and used in accordance with manufacturer's instructions, may cause harmful interference to radio communications. However, there is no guarantee that interference will not occur in a particular installation. If this equipment does cause harmful interference to radio or television reception, which can be determined by turning the equipment off and on, the user is encouraged to try to correct the interference by one or more of the following measures:

- Reorient or relocate the receiving antenna.
- Increase the separation between the equipment and receiver.
- Connect the equipment to an outlet on a circuit different from that to which the receiver is connected.
- Consult the dealer or an experienced radio/TV technician for help.



---

The use of shielded cables for connection of the monitor to the graphics card is required to assure compliance with FCC regulations. Changes or modifications to this unit not expressly approved by the party responsible for compliance could void the user's authority to operate this equipment.

---

## Canadian Department of Communications Statement

This digital apparatus does not exceed the Class B limits for radio noise emissions from digital apparatus set out in the Radio Interference Regulations of the Canadian Department of Communications.

This class B digital apparatus complies with Canadian ICES-003.

# Safety information

## Electrical safety

- To prevent electrical shock hazard, disconnect the power cable from the electrical outlet before relocating the system.
- When adding or removing devices to or from the system, ensure that the power cables for the devices are unplugged before the signal cables are connected. If possible, disconnect all power cables from the existing system before you add a device.
- Before connecting or removing signal cables from the motherboard, ensure that all power cables are unplugged.
- Seek professional assistance before using an adapter or extension cord. These devices could interrupt the grounding circuit.
- Ensure that your power supply is set to the correct voltage in your area. If you are not sure about the voltage of the electrical outlet you are using, contact your local power company.
- If the power supply is broken, do not try to fix it by yourself. Contact a qualified service technician or your retailer.

## Operation safety

- Before installing the motherboard and adding devices on it, carefully read all the manuals that came with the package.
- Before using the product, ensure that all cables are correctly connected and the power cables are not damaged. If you detect any damage, contact your dealer immediately.
- To avoid short circuits, keep paper clips, screws, and staples away from connectors, slots, sockets and circuitry.
- Avoid dust, humidity, and temperature extremes. Do not place the product in any area where it may become wet.
- Place the product on a stable surface.
- If you encounter technical problems with the product, contact a qualified service technician or your retailer.



---

The symbol of the crossed out wheeled bin indicates that the product (electrical and electronic equipment, Mercury-containing button cell battery) should not be placed in municipal waste. Please check local regulations for disposal of electronic products.

---

# About this guide

This user guide contains the information you need when installing and configuring the motherboard.

## How this guide is organized

This manual contains the following parts:

- **Chapter 1: Product introduction**  
This chapter describes the features of the motherboard and the new technology it supports. This chapter also lists the hardware setup procedures that you have to perform when installing system components. It includes description of the jumpers and connectors on the motherboard.
- **Chapter 2: BIOS setup**  
This chapter tells how to change system settings through the BIOS Setup menus. Detailed descriptions of the BIOS parameters are also provided.
- **Chapter 3: Software support**  
This chapter describes the contents of the support CD / DVD that comes with the motherboard package.
- **Chapter 4: NVIDIA® technology support**  
This chapter tells how to use the Hybrid SLI® feature.

## Where to find more information

Refer to the following sources for additional information and for product and software updates.

1. **ASUS websites**  
The ASUS website provides updated information on ASUS hardware and software products. Refer to the ASUS contact information.
2. **Optional documentation**  
Your product package may include optional documentation, such as warranty flyers, that may have been added by your dealer. These documents are not part of the standard package.



## Conventions used in this guide

To ensure that you perform certain tasks properly, take note of the following symbols used throughout this manual.



**DANGER/WARNING:** Information to prevent injury to yourself when trying to complete a task.



**CAUTION:** Information to prevent damage to the components when trying to complete a task.



**IMPORTANT:** Instructions that you **MUST** follow to complete a task.



**NOTE:** Tips and additional information to help you complete a task.

## Typography

**Bold text**

Indicates a menu or an item to select.

*Italics*

Used to emphasize a word or a phrase.

<Key>

Keys enclosed in the less-than and greater-than sign means that you must press the enclosed key.

Example: <Enter> means that you must press the Enter or Return key.

<Key1+Key2+Key3>

If you must press two or more keys simultaneously, the key names are linked with a plus sign (+).

Example: <Ctrl+Alt+D>

**Command**

Means that you must type the command exactly as shown, then supply the required item or value enclosed in brackets.

Example: At the DOS prompt, type the command line:

```
a fudos /i [filename]
```

```
a fudos /iM3N78-VM.ROM
```

## M3N78-VM specifications summary

<b>CPU</b>	Supports AMD socket AM2+ / AM2 for AMD Phenom™ FX / Phenom™ / Athlon™ / Sempron™ processors AMD64 architecture enables simultaneous 32-bit and 64-bit computing Supports AMD Cool 'n' Quiet™ Technology
<b>Chipset</b>	NVIDIA® GeForce® 8200 (MCP78S)
<b>System bus</b>	Up to 5200 MT/s HyperTransport™ 3.0 interface for AM2+ CPU
<b>Memory</b>	Dual-channel memory architecture 4 x 240-pin DIMM sockets support up to 8 GB of unbuffered ECC and non-ECC 1066 / 800 / 667 / 533 MHz DDR2 memory modules * Only AM2+ CPU supports DDR2 1066.
<b>Expansion slots</b>	1 x PCI Express™ x16 slot 1 x PCI Express™ x1 slot 2 x PCI slots
<b>Graphics</b>	Integrated NVIDIA® GeForce Series DirectX10 graphics processor Hybrid SLI support (supports Windows® Vista only) Supports HDMI interface with HDCP compliant with max. resolution up to 1920 x 1200 Supports DVI interface with HDCP compliant with max resolution up to 1600 x 1200 Supports D-Sub with max. resolution up to 1920 x 1440 (@75Hz) Supports Microsoft® DirectX 10, OpenGL 2.0, and Pixel Shader 4.0 Supports PCIe 2.0 / 1.0 Architecture Maximum shared memory of 256 MB  Note: The suggested system configuration when playing HD DVD and Blu-ray disc: DDR2 800 1GB x 2 / Athlon 64 x 2 4400+ / Graphic shared memory 256 MB / Purevideo HD support.
<b>Storage</b>	Chipset - 1 x Ultra DMA 133 / 100 interface - 5 x Serial ATA 3 Gb/s hard disk drives supporting RAID 0, RAID 1, RAID 5, RAID 0+1, and JBOD configuration
<b>High Definition Audio</b>	VT1708B High Definition Audio 8-channel CODEC Supports Optical S/PDIF out ports at back I/O Supports Jack-detect, and Multi-streaming

*(continued on the next page)*

## M3N78-VM specifications summary

<b>USB</b>	12 USB 2.0 / 1.1 ports (6 ports at mid-board, 6 ports at rear panel)
<b>LAN</b>	NVIDIA® nForce built-in Gigabit MAC with external Realtek8211CL-GR PHY
<b>ASUS Unique Features</b>	<p>ASUS Quiet Thermal Solution:</p> <ul style="list-style-type: none"> <li>- ASUS Q-Fan</li> </ul> <p>ASUS EZ DIY:</p> <ul style="list-style-type: none"> <li>- ASUS CrashFree BIOS 3</li> <li>- ASUS EZ Flash 2</li> </ul> <p>ASUS Express Gate:</p> <ul style="list-style-type: none"> <li>- Web browser, file downloading and uploading*</li> <li>- Further free features upgradable</li> </ul> <p>Other features:</p> <ul style="list-style-type: none"> <li>- ASUS MyLogo 2™</li> <li>- ASUS AI NET 2</li> </ul> <p>* File downloading and uploading is supported through USB devices only..</p>
<b>ASUS Overclocking Features</b>	<p>GPU Overclocking</p> <p>Stepless Frequency Selection (SFS):</p> <ul style="list-style-type: none"> <li>- HT tuning from 200 MHz to 400MHz at 1MHz increment</li> <li>- Memory tuning from 533 MHz to 1066 MHz</li> <li>- PCIe frequency tuning from 100 MHz to 200 MHz at 1 MHz increment</li> </ul> <p>Overclocking Protection:</p> <ul style="list-style-type: none"> <li>- ASUS CPU Parameter Recall (C.P.R.)</li> </ul>
<b>BIOS features</b>	8 Mb Flash ROM, AMI BIOS, PnP, DMI2.0, WfM2.0, SM BIOS 2.5, ACPI 2.0a
<b>Rear panel I/O</b>	<p>1 x LAN (RJ-45) port</p> <p>1 x HDMI port</p> <p>1 x DVI port</p> <p>1 x VGA port</p> <p>6 x USB 2.0 / 1.1 ports</p> <p>1 x External SATA port</p> <p>1 x PS/2 keyboard / mouse combo port</p> <p>8-channel audio ports</p>

*(continued on the next page)*

<b>Internal I/O connectors</b>	<ul style="list-style-type: none"> <li>1 x High Definition front panel audio connector</li> <li>1 x IDE connector</li> <li>1 x Floppy disk drive connector</li> <li>1 x CD audio-in connector</li> <li>1 x CPU fan connector</li> <li>1 x Chassis fan connector</li> <li>1 x Power fan connector</li> <li>1 x Chassis intrusion connector</li> <li>1 x COM connector</li> <li>1 x LPT connector</li> <li>1 x TPM header</li> <li>5 x SATA connectors</li> <li>1 x S/PDIF Out connector</li> <li>3 x USB 2.0 connectors for 6 additional USB 2.0 ports</li> <li>1 x 24-pin EATX power connector</li> <li>1 x 4-pin x ATX 12V power connector</li> <li>1 x System panel connector</li> </ul>
<b>Support DVD contents</b>	<ul style="list-style-type: none"> <li>Device drivers</li> <li>Express Gate</li> <li>ASUS PC Probe II</li> <li>ASUS Update utility</li> <li>Anti-virus software (OEM version)</li> </ul>
<b>Accessories</b>	<ul style="list-style-type: none"> <li>2 x SATA cables</li> <li>1 x 2-port SATA power cable</li> <li>1 x UltraDMA 133 / 100 / 66 cable</li> <li>1 x Floppy Disk Drive cable</li> <li>1 x I/O Shield</li> <li>User's manual</li> </ul>
<b>Form Factor</b>	MicroATX: 9.6 in. x 9.6 in. (24.4 cm x 24.4 cm)

\*Specifications are subject to change without notice.

This chapter describes the motherboard features and the new technologies it supports.

# 1 Product introduction

## 1.1 Welcome!

Thank you for buying an ASUS® M3N78-VM motherboard!

The motherboard delivers a host of new features and latest technologies, making it another standout in the long line of ASUS quality motherboards!

Before you start installing the motherboard, and hardware devices on it, check the items in your package with the list below.

## 1.2 Package contents

Check your motherboard package for the following items.

Motherboard	ASUS M3N78-VM motherboard
Cables	2 x Serial ATA signal cables 1 x 2-port Serial ATA power cable 1 x Ultra DMA 133 / 100 cable 1 x Floppy disk drive cable
Accessories	I/O shield
Application DVD	ASUS motherboard support DVD
Documentation	User guide



If any of the above items is damaged or missing, contact your retailer.

## 1.3 Special features

### 1.3.1 Product highlights

#### AMD socket AM2+ Phenom FX / Phenom



The motherboard supports AMD socket AM2+ multi-core processors. It features dual-channel DDR2 1066 memory support and accelerates data transfer rate up to 5200 MT/s via HyperTransport 3.0 based system bus. See page 1-10 for details.

#### AMD socket AM2 Athlon 64 / Athlon 64 X2 / Athlon 64 FX / Sempron



The motherboard supports AMD socket AM2 Athlon 64 / Athlon 64 X2 / Athlon 64 FX / Sempron processors with 2MB / 1MB / 512KB L2 cache, which is based on 64-bit architecture. It features 2000 / 1600 MT/s HyperTransport System Bus, dual-channel un-buffered DDR2 memory support and AMD Cool 'n' Quiet Technology. See page 1-10 for details.

## AMD Cool 'n' Quiet Technology



The motherboard supports the AMD Cool 'n' Quiet Technology, which monitors system operation and automatically adjusts CPU voltage and frequency for a cool and quiet operating environment. See page 2-22 for details.

## 64-bit CPU support



64-bit computing, the technology to replace 32-bit architecture, delivers advanced system performance, faster memory access and increased productivity. This motherboard provides excellent compatibility and flexibility by supporting either 64-bit or 32-bit architecture.

## NVIDIA® GeForce 8200



The NVIDIA® GeForce 8200 offers the latest support of Hybrid SLI technology, DirectX10 graphics features, HD video playback with HDMI / DVI output. It also supports HyperTransport™ 3.0 interface, PCI Express™ 2.0 bus architecture, Serial ATA 3 GB/s devices, and is optimized with AMD's latest AM2+ and multi-core CPUs to provide excellent system performance.

## HDMI™ Interface



High-Definition Multimedia Interface (HDMI) is the first and only industry-supported, uncompressed, all digital audio and video interface via a single cable and is HDCP compliant allowing playback of HD DVD, Blu-ray Disc and other protected content. See page 1-25 for details.

## Dual channel DDR2 1066



DDR2 1066 memory provides great performance for 3D graphics and other memory demanding applications on next generation memory technology. See page 1-14 for details.



---

DDR2 1066 is for AM2+ CPU only.

---

## Serial ATA 3Gb/s technology



The motherboard supports SATA hard drives based on the new SATA 3Gb/s storage specification. It allows RAID 0, RAID 1, RAID 5, RAID 0+1, and JBOD configurations for five SATA connectors.



### Gigabit LAN solution

Gigabit LAN is the networking standard for the early future and is ideal for handling large amounts of data such as video, audio, and voice. See page 1-24 for details.



### PCI Express 2.0 support

The motherboard supports the latest PCI Express 2.0 devices for double speed and bandwidth which enhances system performance. See page 1-22 for details.



### High Definition Audio

Enjoy high-end sound quality on your PC! The onboard 8-channel HD audio (High Definition Audio, previously codenamed Azalia) CODEC enables high-quality 192KHz / 24-bit audio output, jack-detect feature. See page 1-24 and 1-25 for details.



### HyperTransport™ 3.0 support

HyperTransport™ 3.0 technology provides 2.6 times more bandwidth than HyperTransport™ 1.0, radically improving system efficiency to create a smoother, faster computing environment.



### Hybrid SLI™

Hybrid SLI™ technology is a unique hybrid multi-GPU technology built upon NVIDIA. Hybrid SLI technology today includes two primary features: GeForce Boost and HybridPower™. GeForce Boost turbo-charges performance of NVIDIA discrete graphics cards when combined with this series motherboard GPUs. HybridPower™ unleashed graphics performance when needed and enabled discrete GeForce GPU(s) to the motherboard GPU for a quiet, low power PC experience.



---

Visit the ASUS website ([www.asus.com](http://www.asus.com)) to download the latest Hybrid SLI driver after NVIDIA get the Hybrid SLI function prepared.

---



### Dual VGA output

This motherboard supports Dual-VGA output (RGB & HDMI / DVI). HDMI / DVI interface is compliant with HDCP.



## 1.3.2 Innovative ASUS features

### ASUS Q-Fan technology



ASUS Q-Fan technology intelligently adjusts CPU fan speeds according to system loading to ensure quiet, cool and efficient operation. See page 2-33 for details.

### ASUS CrashFree BIOS 3



The ASUS CrashFree BIOS 3 allows users to restore corrupted BIOS data from a USB flash disk containing the BIOS file. See page 2-7 for details.

### ASUS EZ Flash 2



EZ Flash 2 is a user-friendly BIOS update utility. Simply press the predefined hotkey to launch the utility and update the BIOS without entering the OS. Update your BIOS easily without preparing a bootable diskette or using an OS-based flash utility. See pages 2-4 and 2-38 for details.

### Express Gate



With five seconds' boot-up, the ASUS Express Gate allows you to instantly surf the Internet without entering Windows or the hard disk. You can now enjoy Skype, IM, YouTube, webmail, and Internet files downloads and sharing whenever and wherever you want. See page 2-39 for details.

### AI NET 2



AI NET 2 is a BIOS-based diagnostic tool that detects and reports Ethernet cable faults and shorts. With this utility, you can easily monitor the condition of the Ethernet cable(s) connected to the LAN (RJ-45) port(s). During the bootup process, AI NET 2 immediately diagnoses the LAN cable(s) and reports shorts and faults up to 100 meters at 1 meter accuracy. See page 2-39 for details.

### ASUS MyLogo 2™



This feature allows you to convert your favorite photo into a 256-color boot logo for a more colorful and vivid image on your screen.

## C.P.R. (CPU Parameter Recall)

The C.P.R. feature of the motherboard BIOS allows automatic re-setting to the BIOS default settings in case the system hangs due to overclocking. When the system hangs due to overclocking, C.P.R. eliminates the need to open the system chassis and clear the RTC data. Simply shut down and reboot the system, and the BIOS automatically restores the CPU default setting for each parameter. See page 1-23 for details.

## Green ASUS



The motherboard and its packaging comply with the European Union's Restriction on the use of Hazardous Substances (RoHS). This is in line with the ASUS vision of creating environment-friendly and recyclable products and packaging to safeguard consumers' health while minimizing the impact on the environment.

## 1.4 Before you proceed

Take note of the following precautions before you install motherboard components or change any motherboard settings.



- Unplug the power cord from the wall socket before touching any component.
- Use a grounded wrist strap or touch a safely grounded object or a metal object, such as the power supply case, before handling components to avoid damaging them due to static electricity
- Hold components by the edges to avoid touching the ICs on them.
- Whenever you uninstall any component, place it on a grounded antistatic pad or in the bag that came with the component.
- Before you install or remove any component, ensure that the ATX power supply is switched off or the power cord is detached from the power supply. Failure to do so may cause severe damage to the motherboard, peripherals, and/or components.

### Onboard LED

The motherboard comes with a standby power LED that lights up to indicate that the system is ON, in sleep mode, or in soft-off mode. This is a reminder that you should shut down the system and unplug the power cable before removing or plugging in any motherboard component. The illustration below shows the location of the onboard LED.

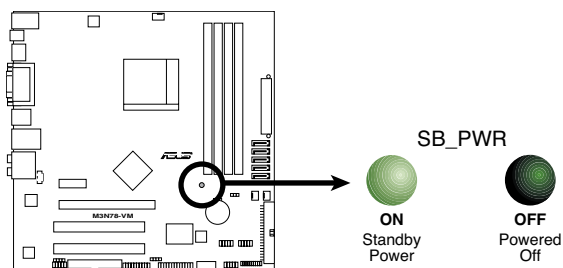

**M3N78-VM Onboard LED**

# 1.5 Motherboard overview

## 1.5.1 Motherboard layout

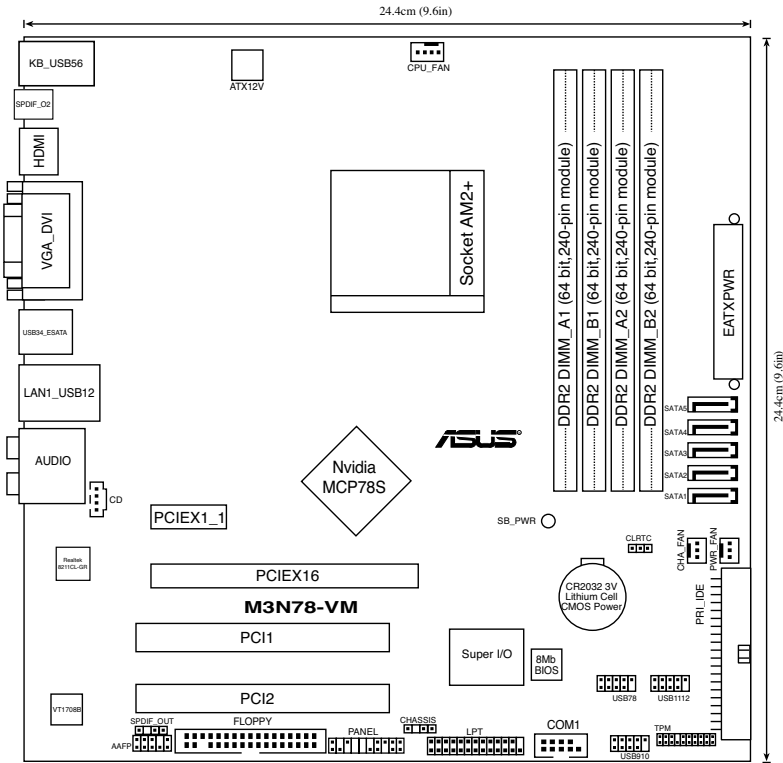

## 1.5.2 Placement direction

When installing the motherboard, ensure that you place it into the chassis in the correct orientation. The edge with external ports goes to the rear part of the chassis as indicated in the image below.

## 1.5.3 Screw holes

Place eight (8) screws into the holes indicated by circles to secure the motherboard to the chassis.



Do not overtighten the screws! Doing so can damage the motherboard.

Place this side towards  
the rear of the chassis

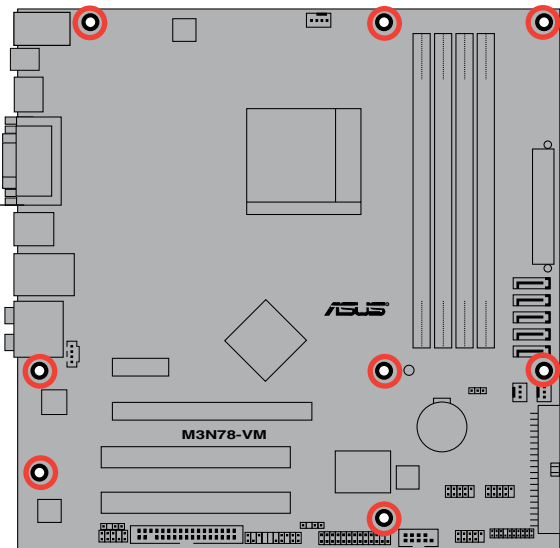

## 1.6 Central Processing Unit (CPU)

The motherboard comes with a 940-pin AM2+ / AM2 socket designed for the AMD Athlon™ 64 / Sempron™ / Athlon™ FX / Athlon™ 64 X2 / AM2+ / Phenom™ FX / Phenom™ processor.



The AM2+ / AM2 socket has a different pinout from the 940-pin socket designed for the AMD Opteron™ processor. Ensure that you use a CPU is designed for the AM2+ / AM2 socket. The CPU fits in only one correct orientation. DO NOT force the CPU into the socket to prevent bending the connectors on the socket and damaging the CPU!

### 1.6.1 Installing the CPU

To install a CPU.

1. Locate the CPU socket on the motherboard.

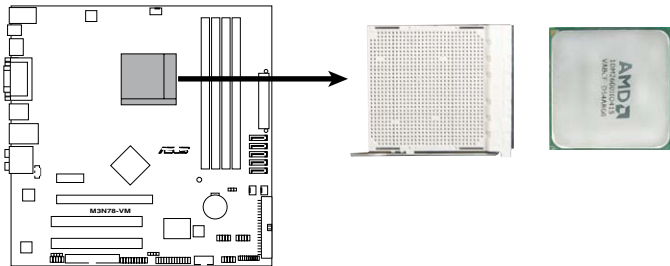

**M3N78-VM CPU Socket 940**

2. Unlock the socket by pressing the lever sideways, then lift it up to a 90°-100° angle.

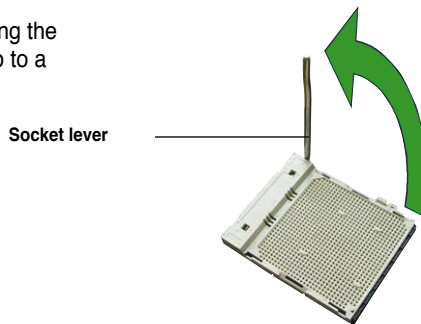

Ensure that the socket lever is lifted up to 90°-100° angle, otherwise the CPU does not fit in completely.

- Position the CPU above the socket such that the CPU corner with the gold triangle matches the socket corner with a small triangle.
- Carefully insert the CPU into the socket until it fits in place.

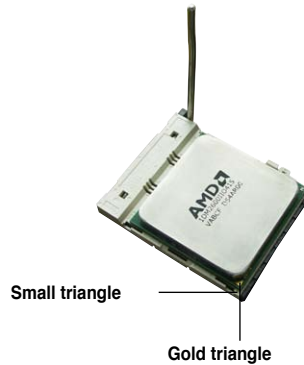

The CPU fits only in one correct orientation. DO NOT force the CPU into the socket to prevent bending the pins and damaging the CPU!

- When the CPU is in place, push down the socket lever to secure the CPU. The lever clicks on the side tab to indicate that it is locked.
- Install a CPU heatsink and fan following the instructions that came with the heatsink package.



- Connect the CPU fan cable to the CPU\_FAN connector on the motherboard.

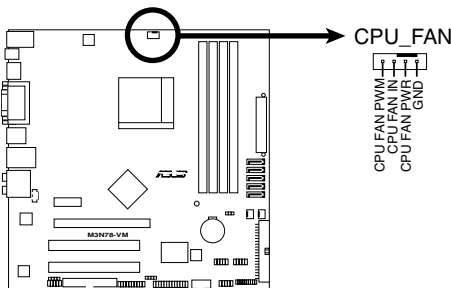

**M3N78-VM CPU Fan Connector**



Do not forget to connect the CPU fan connector! Hardware monitoring errors can occur if you fail to plug this connector.

## 1.6.2 Installing the heatsink and fan

The AMD Athlon™ 64 / Sempron™ / Athlon™ FX / Athlon™ 64 X2 / AM2+ / Phenom™ FX / Phenom™ processor requires a specially designed heatsink and fan assembly to ensure optimum thermal condition and performance.



---

Ensure that you use only qualified heatsink and fan assembly.

---

Follow these steps to install the CPU heatsink and fan.

1. Place the heatsink on top of the installed CPU, ensuring that the heatsink fits properly on the retention module base.



- The retention module base is already installed on the motherboard upon purchase.
  - You do not have to remove the retention module base when installing the CPU or installing other motherboard components.
  - If you purchased a separate CPU heatsink and fan assembly, make sure that a Thermal Interface Material is properly applied to the CPU heatsink or CPU before you install the heatsink and fan assembly.
- 

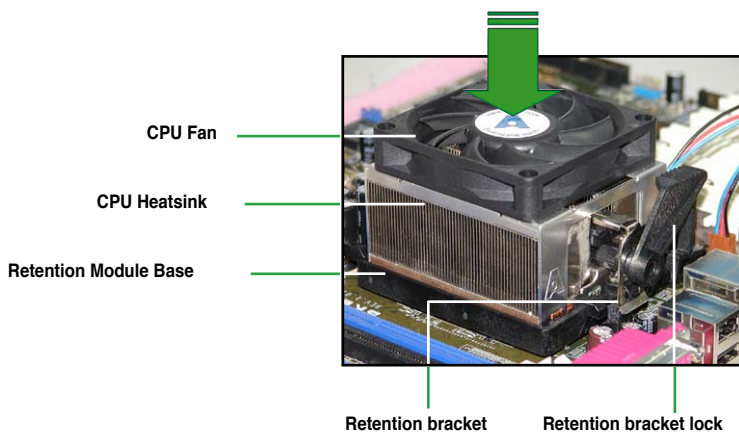

---

Your boxed CPU heatsink and fan assembly should come with installation instructions for the CPU, heatsink, and the retention mechanism. If the instructions in this section do not match the CPU documentation, follow the latter.

---



2. Attach one end of the retention bracket to the retention module base.

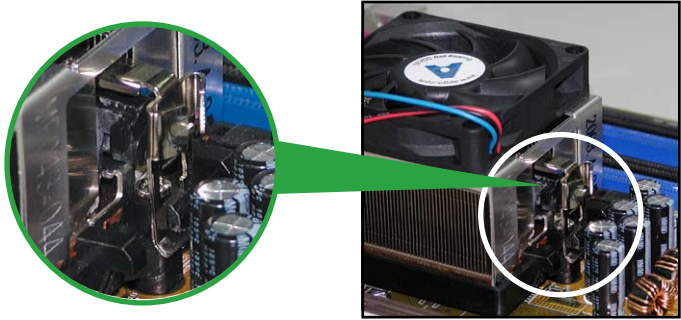

3. Align the other end of the retention bracket (near the retention bracket lock) to the retention module base. A clicking sound denotes that the retention bracket is in place.



Ensure that the fan and heatsink assembly perfectly fits the retention mechanism module base. Otherwise, you cannot snap the retention bracket in place.

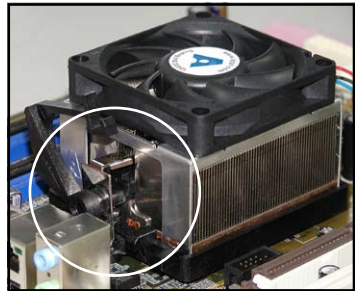

4. Push down the retention bracket lock on the retention mechanism to secure the heatsink and fan to the module base.

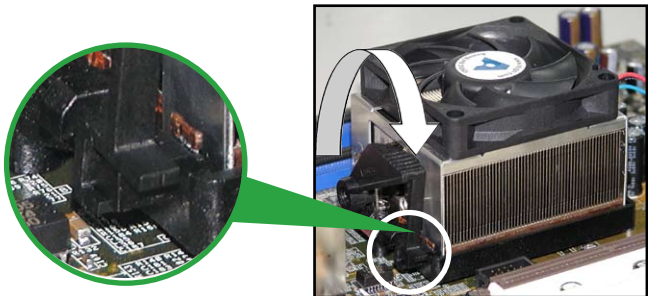

# 1.7 System memory

## 1.7.1 Overview

The motherboard comes with four Double Data Rate 2 (DDR2) Dual Inline Memory Modules (DIMM) sockets.

A DDR2 module has the same physical dimensions as a DDR DIMM but has a 240-pin footprint compared to the 184-pin DDR DIMM. DDR2 DIMMs are notched differently to prevent installation on a DDR DIMM socket.

The figure illustrates the location of the DDR2 DIMM sockets:

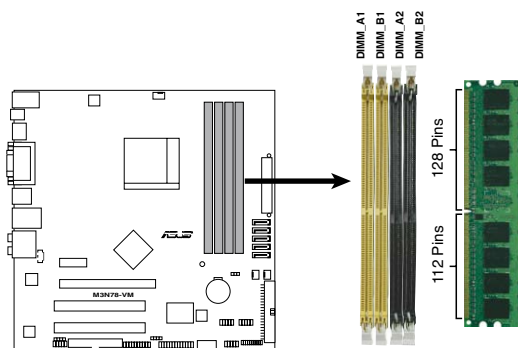

**M3N78-VM 240-pin DDR2 DIMM Sockets**

Channel	Sockets
Channel A	DIMM_A1 and DIMM_A2
Channel B	DIMM_B1 and DIMM_B2

## 1.7.2 Memory configurations

You may install 256 MB, 512 MB, 1 GB, and 2 GB unbuffered ECC / non-ECC DDR2 DIMMs into the DIMM sockets.

### Recommended memory configurations

Mode	Sockets			
	DIMM_A1	DIMM_B1	DIMM_A2	DIMM_B2
Single-Channel	–	Populated	–	–
	Populated	–	–	–
Dual-channel (1)	Populated	Populated	–	–
Dual-channel (2)	Populated	Populated	Populated	Populated



- 
- When using only one memory module, start installing the DDR2 DIMM from slot DIMM\_A1 or DIMM\_B1 for better overclocking capability.
  - For dual-channel configuration (2), you may:
    - install identical DIMMs in all four sockets OR
    - install identical DIMM pair in DIMM\_A1 and DIMM\_B1 (yellow sockets) and another identical DIMM pair in DIMM\_A2 and DIMM\_B2 (black sockets)
  - Due to the chipset's limitation, the 1066 MHz memory modules run at 1066 MHz only when:
    - two 1066 MHz memory modules installed in the same colored-slots (either in the yellow slots or black slots); and
    - one 1066 MHz memory module installed in any of the slots.

In other cases, the 1066 MHz memory modules can only run at 800 MHz.

- Always use identical DDR2 DIMM pairs for dual channel mode. For optimum compatibility, we recommend that you obtain memory modules from the same vendor.
- If you are using a Windows 32-bit version operating system (e.g. 32-bit Windows, 32-bit Vista) without the Physical Address Extension (PAE) support, the system will allocate a certain amount of memory space for system devices.
- We recommend that you install only a maximum of 3GB system memory when using a Windows 32-bit version operating system without the PAE. The excess over 3GB of installed memory will not cause any problem; however, the system can not use this excess memory space and the system will display less than the total size of physical memory installed.



---

The motherboard can support 8 GB physical memory on the operating system listed below. You may install a maximum of 2 GB DIMMs on each slot.

---

**64-bit**

Windows® XP Professional x64 Edition

Windows® Vista x64 Edition

## Qualified Vendors Lists (QVL)

### DDR2-533 MHz capability

Size	Vendor	Model	CL	Brand	SS/ DS	Component	DIMM support		
							A*	B*	C*
512MB	Kingston	KVR533D2N4/512	N/A	Infineon	SS	HYB18T512800AF3733336550	.	.	.
512MB	Samsung	M378T6553BG0-CD5	4	Samsung	SS	K4T51083QB-GCD5	.	.	.
1G	HY	HYMP512U64CP8-C4 AB	4	Hynix	DS	HY5PS12821CFP-C4	.	.	.
512MB	Micron	MT 16HTF6464AG-53EB2	4	Micron	DS	D9BOM	.	.	.
1G	Corsair	VS1GB533D2	N/A	Corsair	DS	64M8CFEGQIB0900718	.	.	.
512MB	Elpida	EBE51UD8ABFA-5C-E	N/A	Elpida	SS	E5108AB-5C-E	.	.	.
512MB	Transcend	512MB ECC	N/A	Micron	SS	6ND22D9GCT(ECC)	.	.	.
512MB	ADATA	M2OAD2G3H3166H1B52	N/A	ADATA	SS	AD29608A8A-37DG20719	.	.	.

### DDR2-667 MHz capability

Size	Vendor	Model	CL	Brand	SS/ DS	Component	DIMM support		
							A*	B*	C*
2G	Kingston	KVR667D2N5/2G	N/A	Micron	DS	7RE22 D9HNL	.	.	.
512MB	Samsung	M378T6553CZ3-CE6	N/A	Samsung	SS	K4T51083QC-ZCE6	.	.	.
2G	Qimonda	HYS64T256020EU-3S-B	5	Qimonda	DS	HTB18T1G800BF-3S3VV10907	.	.	.
1G	Corsair	VS1GB667D2	N/A	Corsair	DS	MID095D62864M8CEC	.	.	.
1G	HY	HYMP512U72AP8-Y5	N/A	Hynix	DS	HY5PS12821AFP-Y5(ECC)	.	.	.
1G	HY	HYMP512U64CP8-Y5 AB	5	Hynix	DS	HY5PS12521CFP-Y5	.	.	.
512MB	Kingmax	KLCC28F-A8KB5	N/A	Kingmax	SS	KKEA88B4LAUG-29DX	.	.	.
512MB	Apacer	AU512E667C5KBGC	5	Apacer	SS	AM4B5708MJS7E0627B	.	.	.
1G	Apacer	AU01GE667C5KBGC	5	Apacer	DS	AM4B5708MJS7E0627B	.	.	.
512MB	ADATA	M20AD5G3H3166H1C52	N/A	ADATA	SS	AD29608A8A-3EG20648	.	.	.
512MB	ADATA	M20AD5G3H3166H1C52	N/A	ADATA	SS	AD29608A8A-3EG20718	.	.	.
512MB	VDATA	M2GVDS5G3H31A41C52	N/A	VDATA	SS	VD29608A8A-3EC20615	.	.	.
1G	VDATA	M2GVDS5G3I41C41C52	N/A	VDATA	DS	VD29608A8A-3EC20620	.	.	.
1G	PSC	AL7E8E63B-6E1K	5	PSC	DS	A3R1E23GEF637BLC5N	.	.	.
1G	PSC	AL7E8F73C-6E1	5	PSC	SS	A3R1GE3CFF734MAA0J	.	.	.
512MB	Nanya	NT512T64U88A1BY-3C	N/A	Nanya	SS	NT5TU64M8AE-3C	.	.	.
1G	Kingtiger	E0736001024667	N/A	Kingtiger	DS	KTG667PS6408N1C8-GBDXT	.	.	.

(continued on the next page)

## Qualified Vendors Lists (QVL)

### DDR2-800 MHz capability

Size	Vendor	Model	CL	Brand	SS/ DS	Component	DIMM support		
							A*	B*	C*
1G	Kingston	KHX6400D2LL1G	N/A	Kingston	DS	Heat-Sink Package	-	-	-
1G	Samsung	KR M378T2953CZ3-CE7	N/A	Samsung	DS	K4T51083QC-ZCE7	-	-	-
1G	Samsung	KR M391T2953CZ3-CE7	N/A	Samsung	DS	K4T51083QC-ZCE7(ECC)	-	-	-
512MB	Qimonda	HYS64T64000EU-2.5-B2	6	Qimonda	SS	HYB18T512800B2F5FSS28380	-	-	-
1G	Micron	MT18HTF12872AY-80ED4	5	Micron	DS	6TD2D9GKX(ECC)	-	-	-
1G	Corsair	XMS2-6400	5	Corsair	DS	Heat-Sink Package	-	-	-
1G	HY	HYP512U64AP8-S6 AA	N/A	Hynix	DS	HY5PS12821AFP-S6	-	-	-
2G	Apacer	78.A1GA0.9K4	5	Apacer	DS	AM4B5808CQJS8E0740E	-	-	-
512MB	ADATA	M20AD6G3H3160I1E58	N/A	ADATA	SS	AD29608A8A-25EG80720	-	-	-
1G	VDATA	M2GVD6G3I4170I1E53	N/A	VDATA	DS	VD29608A8A-25EG30647	-	-	-
1G	PSC	AL7E8F73C-8E1	5	PSC	SS	A3R1GE3CFF734MAA0E	-	-	-

### DDR2-1066 MHz capability

Size	Vendor	Model	CL	Brand	SS/ DS	Component	DIMM support		
							A*	B*	C*
512MB	Kingston	KHX8500D2/512	N/A	Kingston	SS	Heat-Sink Package	-	-	-
512MB	Kingston	KHX8500D2K2/1GN	N/A	Kingston	SS	Heat-Sink Package	-	-	-
1G	Kingston	KHX8500D2K2/2GN	N/A	Kingston	DS	Heat-Sink Package	-	-	-
1G	Qimonda	HYS64T128020EU-19F-C	6	Qimonda	DS	HYB18T512800CF19FFSS24313	-	-	-
1G	Corsair	CM2X1024-8500C5	N/A	Corsair	DS	Heat-Sink Package	-	-	-
1G	Corsair	CM2X1024-8500C5D	5	Corsair	DS	Heat-Sink Package	-	-	-
512MB	ADATA	M2OMIDG3H3160INC5Z	5	ADATA	SS	Heat-Sink Package	-	-	-
1G	ADATA	M2OMIDG314720INC5Z	5	ADATA	DS	Heat-Sink Package	-	-	-
1G	OCZ	OC22N10662GK	N/A	OCZ	DS	Heat-Sink Package	-	-	-
1G	GEIL	M016E2864T2AGXAKT7G330520	5	Micron	DS	7KD22D9GMH	-	-	-



#### SS - Single-sided / DS - Double - sided

##### DIMM support:

- **A\***: Supports one module inserted into any slot as Single-channel memory configuration.
- **B\***: Supports one pair of modules inserted into either the yellow slots or the black slots as one pair of Dual-channel memory configuration.
- **C\***: Supports four modules inserted into both the yellow slots and the black slots as two pairs of Dual-channel memory configuration.



Visit the ASUS website for the latest DDR2-667/800/1066MHz QVL.

### 1.7.3 Installing a DIMM



Ensure to unplug the power supply before adding or removing DIMMs or other system components. Failure to do so may cause severe damage to both the motherboard and the components.

1. Unlock a DIMM socket by pressing the retaining clips outward.
2. Align a DIMM on the socket such that the notch on the DIMM matches the break on the socket.
3. Firmly insert the DIMM into the socket until the retaining clips snap back in place and the DIMM is properly seated.

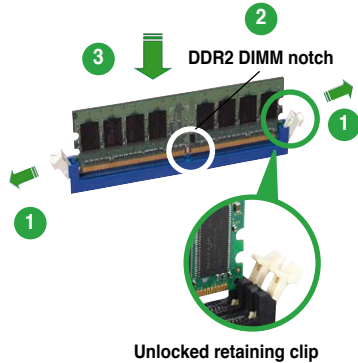

- A DDR2 DIMM is keyed with a notch so that it fits in only one direction. DO NOT force a DIMM into a socket to avoid damaging the DIMM.
- The DDR2 DIMM sockets do not support DDR DIMMs. Do not install DDR DIMMs to the DDR2 DIMM sockets.

### 1.7.4 Removing a DIMM

To remove a DIMM:

1. Simultaneously press the retaining clips outward to unlock the DIMM.

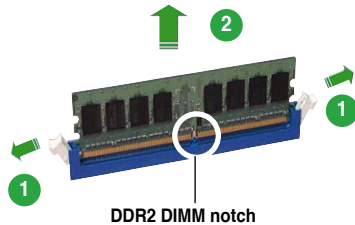

Support the DIMM lightly with your fingers when pressing the retaining clips. The DIMM might get damaged when it flips out with extra force.

2. Remove the DIMM from the socket.

## 1.8 Expansion slots

In the future, you may need to install expansion cards. The following sub-sections describe the slots and the expansion cards that they support.



---

Ensure to unplug the power cord before adding or removing expansion cards. Failure to do so may cause you physical injury and damage motherboard components.

---

### 1.8.1 Installing an expansion card

To install an expansion card:

1. Before installing the expansion card, read the documentation that came with it and make the necessary hardware settings for the card.
2. Remove the system unit cover (if your motherboard is already installed in a chassis).
3. Remove the bracket opposite the slot that you intend to use. Keep the screw for later use.
4. Align the card connector with the slot and press firmly until the card is completely seated on the slot.
5. Secure the card to the chassis with the screw you removed earlier.
6. Replace the system cover.

### 1.8.2 Configuring an expansion card

After installing the expansion card, configure it by adjusting the software settings.

1. Turn on the system and change the necessary BIOS settings, if any. See Chapter 2 for information on BIOS setup.
2. Assign an IRQ to the card. Refer to the tables on the next page.
3. Install the software drivers for the expansion card.

## Interrupt assignments

IRQ	Standard function
0	Standard timer
1	Keyboard
2	High precision event timer
3	IRQ holder for PCI steering
4	COM1
5	IRQ holder for PCI steering
6	Floppy controller
7	Printer port
8	High precision event timer
9	AMD ACPI-Compliant system
10	IRQ holder for PCI steering
11	IRQ holder for PCI steering
12	Microsoft PS/2 mouse
13	Numeric data processor
14	Primary IDE
15	Slave IDE

\* These IRQs are usually available for ISA or PCI devices.



## IRQ assignments for this motherboard

	LNKA	LNKB	LN0A	LN2A	LATA	UB12	UB11	LUB2	LUB0	LPMU	LSMB	LMAC	LSA0	LAZA	SGRU
PCI slot1	shared	-	-	-	-	-	-	-	-	-	-	-	-	-	-
PCI slot2	-	shared	-	-	-	-	-	-	-	-	-	-	-	-	-
PCI EX1 Slot	-	-	-	shared	-	-	-	-	-	-	-	-	-	-	-
PCI EX16 slot	-	-	shared	-	-	-	-	-	-	-	-	-	-	-	-
Onboard USB1.1 (OHCI)	-	-	-	-	-	-	-	-	shared	-	-	-	-	-	-
Onboard USB 1.1 (OHCI)	-	-	-	-	-	-	shared	-	-	-	-	-	-	-	-
Onboard USB2.0 (EHCI)	-	-	-	-	-	shared	-	-	-	-	-	-	-	-	-
Onboard USB2.0 (EHCI)	-	-	-	-	-	-	-	shared	-	-	-	-	-	-	-
Onboard IDE controller	-	-	-	-	shared	-	-	-	-	-	-	-	-	-	-
Onboard SATA controller	-	-	-	-	-	-	-	-	-	-	-	-	shared	-	-
Onboard SMBus controller	-	-	-	-	-	-	-	-	-	-	shared	-	-	-	-
Onboard Azalia controller	-	-	-	-	-	-	-	-	-	-	-	-	-	shared	-
Onboard LAN 8111B	-	-	-	-	-	-	-	-	-	-	-	shared	-	-	-
Onboard PMU device	-	-	-	-	-	-	-	-	-	shared	-	-	-	-	-
IXVE Bus Bridge	-	-	-	-	-	-	-	-	-	-	-	-	-	-	shared
Onboard VGA	-	-	-	-	-	-	-	-	-	-	-	-	-	-	shared



When using PCI cards on shared slots, ensure that the drivers support "Share IRQ" or that the cards do not need IRQ assignments. Otherwise, conflicts will arise between the two PCI groups, making the system unstable and the card inoperable.

### 1.8.3 PCI slots

The PCI slots support cards such as a LAN card, SCSI card, USB card, and other cards that comply with PCI specifications. The figure shows a LAN card installed on a PCI slot.

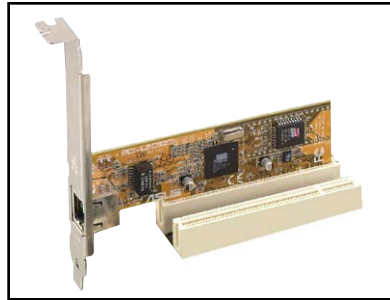

### 1.8.4 PCI Express x1 slot

This motherboard supports PCI Express x1 network cards, SCSI cards and other cards that comply with the PCI Express specifications. The following figure shows a network card installed on the PCI Express x1 slot.

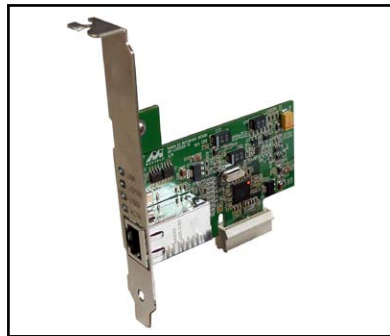

### 1.8.5 PCI Express x16 slot

This motherboard has supports PCI Express x16 graphic cards that comply with PCI Express specifications. The figure shows a graphics card installed on the PCI Express x16 slot.

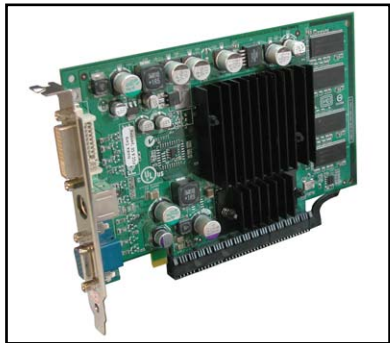

- Currently, only NVIDIA® GeForce® 8500 GT and GeForce 8400 GS graphics cards support GeForce Boost function under Hybrid SLI™ mode.
- Currently, only NVIDIA® GeForce® 9800 GX2 and GeForce 9800 GTX graphics cards support Hybrid Power function under Hybrid SLI™ mode.

# 1.9 Jumper

## 1. Clear RTC RAM (CLRTC)

This jumper allows you to clear the Real Time Clock (RTC) RAM in CMOS. You can clear the CMOS memory of date, time, and system setup parameters by erasing the CMOS RTC RAM data. The onboard button cell battery powers the RAM data in CMOS, which include system setup information such as system passwords.

To erase the RTC RAM:

1. Turn OFF the computer and unplug the power cord.
2. Remove the onboard battery.
3. Move the jumper cap from pins 1-2 (default) to pins 2-3. Keep the cap on pins 2-3 for about 5~10 seconds, then move the cap back to pins 1-2.
4. Reinstall the battery.
5. Plug the power cord and turn ON the computer.
6. Hold down the <Del> key during the boot process and enter BIOS setup to re-enter data.



Except when clearing the RTC RAM, never remove the cap on CLRTC jumper default position. Removing the cap will cause system boot failure!

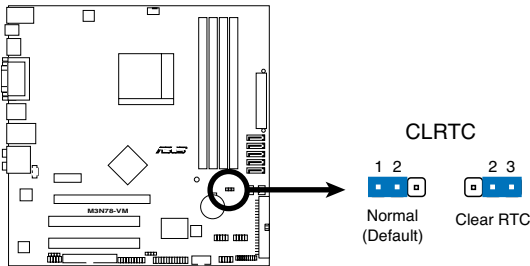

**M3N78-VM Clear RTC RAM**



You do not need to clear the RTC when the system hangs due to overclocking. For system failure due to overclocking, use the C.P.R. (CPU Parameter Recall) feature. Shut down and reboot the system so the BIOS can automatically reset parameter settings to default values.

# 1.10 Connectors

## 1.10.1 Rear panel connectors

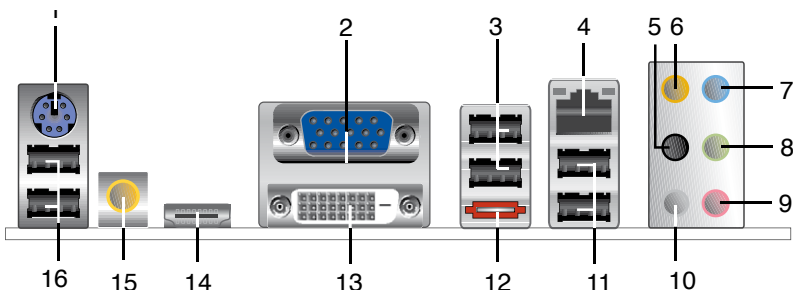

1. **PS/2 keyboard/mouse combo port (purple).** This port is for a PS/2 keyboard or mouse.
2. **Video Graphics Adapter (VGA) port.** This 15-pin port is for a VGA monitor or other VGA-compatible devices.
3. **USB 2.0 ports 3 and 4.** These two 4-pin Universal Serial Bus (USB) ports are available for connecting USB 2.0 devices.
4. **LAN (RJ-45) port.** Supported by Marvell Gigabit LAN controller, this port allows Gigabit connection to a Local Area Network (LAN) through a network hub. Refer to the table below for the LAN port LED indications.

### LAN port LED indications

Activity/Link LED		Speed LED	
Status	Description	Status	Description
OFF	No link	OFF	10 Mbps connection
ORANGE	Linked	ORANGE	100 Mbps connection
BLINKING	Data activity	GREEN	1 Gbps connection

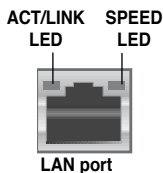

5. **Rear Speaker Out port (black).** This port connects the rear speakers in a 4-channel, 6-channel, or 8-channel audio configuration..
6. **Center / Subwoofer port (orange).** This port connects the center / subwoofer speakers.
7. **Line In port (light blue).** This port connects the tape, CD, DVD player, or other audio sources.
8. **Line Out port (lime).** This port connects a headphone or a speaker. In 4-channel, 6-channel, and 8-channel configuration, the function of this port becomes Front Speaker Out.
9. **Microphone port (pink).** This port connects a microphone.
10. **Side Speaker Out port (gray).** This port connects the side speakers in an 8-channel audio configuration.



Refer to the audio configuration table below for the function of the audio ports in 2, 4, 6 or 8-channel configuration.

## Audio 2, 4, 6, or 8-channel configuration

Port	Headset 2-channel	4-channel	6-channel	8-channel
Light Blue	Line In	Line In	Line In	Line In
Lime	Line Out	Front Speaker Out	Front Speaker Out	Front Speaker Out
Pink	Mic In	Mic In	Mic In	Mic In
Orange	–	–	Center/Subwoofer	Center/Subwoofer
Black	–	Rear Speaker Out	Rear Speaker Out	Rear Speaker Out
Gray	–	–	–	Side Speaker Out

- 11. USB 2.0 ports 1 and 2.** These two 4-pin Universal Serial Bus (USB) ports are available for connecting USB 2.0 devices.
- 12. External SATA port.** These port connect to an external a Serial ATA hard disk drive. To configure a RAID0, RAID1, RAID 0+1, RAID 5, or JBOD set, connect external Serial ATA hard disk drives to the External SATA port.



- To use hot-plug, set the **SATA Mode Select** in the BIOS settings to [AHCI Mode]. See section **2.3.5 Storage Configuration** for details.
- When the AHCI mode is turned on, SATA 1/2/3/5/6 and ESATA are all in AHCI mode, and DOS cannot detect HDD in drivers installation.

- 13. DVI port.** This port is for any DVI-D compatible device. DVI-D can't be converted to output RGB Signal to CRT and isn't compatible with DVI-I.
- 14. HDMI port.** This port is for a High-Definition Multimedia Interface (HDMI) connector, and is HDCP compliant allowing playback of HD DVD, Blu-Ray and other protected content.



- This motherboard comes with dual-VGA output. If you connect 2 monitors to both VGA and DVI-D / HDMI out ports, each controller can drive same or different display contents to different resolutions and refresh rates.
- Due to the chipset limitation, simultaneous output for DVI and HDMI is not supported.
- To play HD DVD or BLU-Ray Disc, ensure to use an HDCP compliant monitor.

## **Playback of HD DVD and Blu-Ray Discs**

The speed and bandwidth of the CPU/Memory, DVD player, and drivers will affect the playback quality. Using the CPU/Memory of higher speed and bandwidth with the higher-version DVD player and drivers will upgrade the playback quality.

15. **Optical S/PDIF Out port.** This port connects an external audio output device via an optical S/PDIF cable.
16. **USB 2.0 ports 5 and 6.** These two 4-pin Universal Serial Bus (USB) ports are available for connecting USB 2.0 devices.

## 1.10.2 Internal connectors

### 1. Floppy disk drive connector (34-1 pin FLOPPY)

This connector is for the provided floppy disk drive (FDD) signal cable. Insert one end of the cable to this connector, then connect the other end to the signal connector at the back of the floppy disk drive.



Pin 5 on the connector is removed to prevent incorrect cable connection when using an FDD cable with a covered Pin 5.

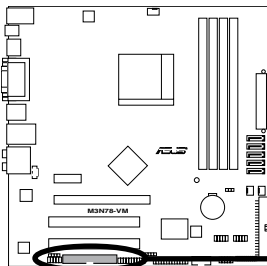

#### FLOPPY



PIN1

**NOTE:** Orient the red markings on the floppy ribbon cable to PIN 1.

#### M3N78-VM Floppy Disk Drive Connector

### 2. TPM connector (20-1 pin TPM)

This connector supports a Trusted Platform Module (TPM) system, which can securely store keys, digital certificates, passwords, and data. A TPM system also helps enhance network security, protects digital identities, and ensures platform integrity.

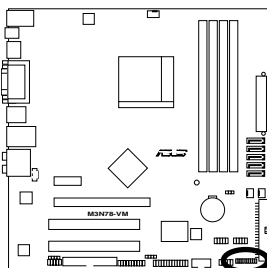

#### TPM

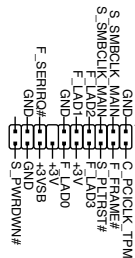

#### M3N78-VM TPM Connector



The TPM model is purchased separately!

### 3. IDE connectors (40-1 pin PRI\_IDE)

The onboard IDE connector is for an Ultra DMA 133/100/66 signal cable. There are three connectors on each Ultra DMA 133/100/66 signal cable: blue, black, and gray. Connect the blue connector to the motherboard's IDE connector, then select one of the following modes to configure your device(s).

	Drive jumper setting	Mode of device(s)	Cable connector
Single device	Cable-Select or Master	-	Black
Two devices	Cable-Select	Master	Black
		Slave	Gray
	Master	Master	Black or gray
		Slave	Slave



- Pin 20 on the IDE connector is removed to match the covered hole on the Ultra DMA cable connector. This prevents incorrect insertion when you connect the IDE cable.
- Use the 80-conductor IDE cable for Ultra DMA 133/100/66 IDE devices.



If any device jumper is set as "Cable-Select," ensure that all other device jumpers have the same setting.

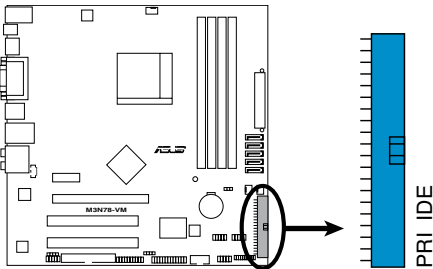

**M3N78-VM IDE Connector**



#### 4. Serial ATA connectors (7-pin SATA1 [red], SATA2 [red], SATA3 [red], SATA4 [black], SATA5 [black])

These connectors are for the Serial ATA signal cables for Serial ATA 3Gb/s hard disk and optical disk drives. The Serial ATA 3Gb/s is backward compatible with Serial ATA 1.5Gb/s specification. The data transfer rate of the Serial ATA 3Gb/s is faster than the standard parallel ATA with 133 MB/s (Ultra DMA133).

If you install Serial ATA hard disk drives, you can create a RAID 0, RAID 1, RAID 5, RAID 0+1, and JBOD configuration through the onboard controller.

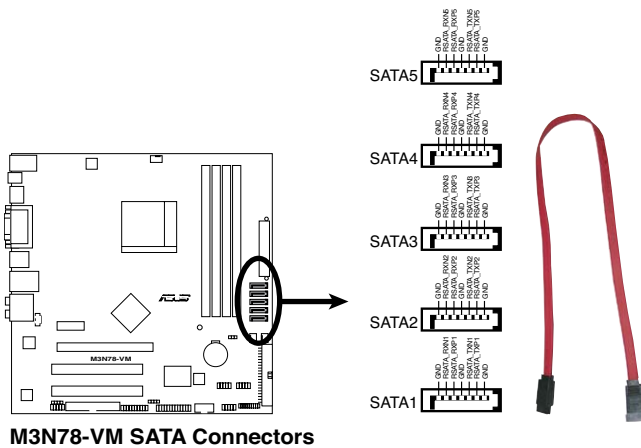

Install the Windows® XP Service Pack 1 before using Serial ATA.



- For detailed instructions on how to configure RAID 0, RAID 1, RAID 5, and RAID 0+1, and JBOD, refer to the RAID manual in the support DVD.
- If you intend to create a Serial ATA RAID set using these connectors, set the **SATA Mode select** item in the BIOS to [RAID Mode]. See the page 2-18 for details.
- Due to the chipset's limitation, SATA 4 and SATA 5 do not support IDE mode, only support AHCI+RAID mode.

**5. CPU, Chassis and Power Fan connectors (4-pin CPU\_FAN, 3-pin CHA\_FAN, 3-pin PWR\_FAN)**

The fan connectors support cooling fans of 350mA~740mA (8.88W max.) or a total of 1A~2.22A (26.64W max.) at +12V. Connect the fan cables to the fan connectors on the motherboard, ensuring that the black wire of each cable matches the ground pin of the connector.



Do not forget to connect the fan cables to the fan connectors. Insufficient air flow inside the system may damage the motherboard components. These are not jumpers! DO NOT place jumper caps on the fan connectors.



Only CPU Fan supports Q-Fan.

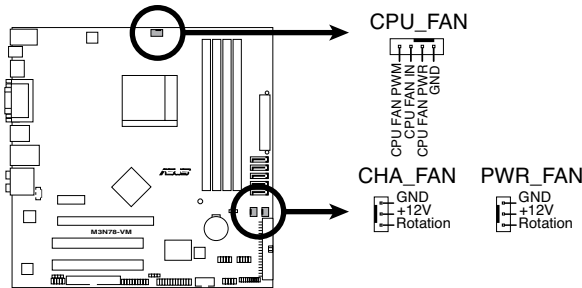

**M3N78-VM Fan Connectors**

**6. Digital audio connector (4-1 pin SPDIF\_OUT)**

This connector is for an additional Sony/Philips Digital Interface (S/PDIF) port(s). Connect the S/PDIF module cable to this connector, then install the module to a slot opening at the back of the system chassis.

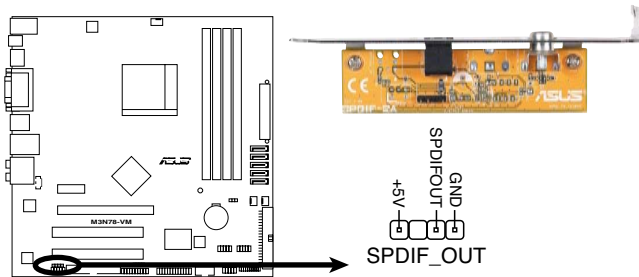

**M3N78-VM Digital Audio Connector**



The S/PDIF module is purchased separately.

## 7. USB connectors (10-1 pin USB78, USB910, USB1112)

These connectors are for USB 2.0 ports. Connect the USB module cable to any of these connectors, then install the module to a slot opening at the back of the system chassis. These USB connectors comply with USB 2.0 specification that supports up to 480 Mbps connection speed.

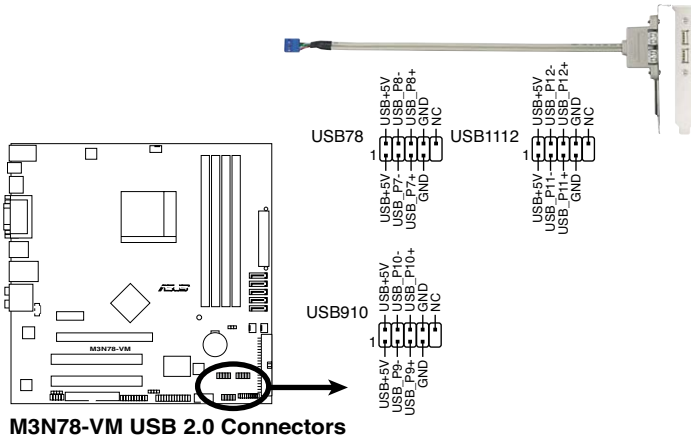

Never connect a 1394 cable to the USB connectors. Doing so will damage the motherboard!



The USB 2.0 module is purchased separately.

## 8. Optical drive audio in connector (4-pin CD)

These connectors allow you to receive stereo audio input from sound sources such as a CD-ROM, TV tuner, or MPEG card.

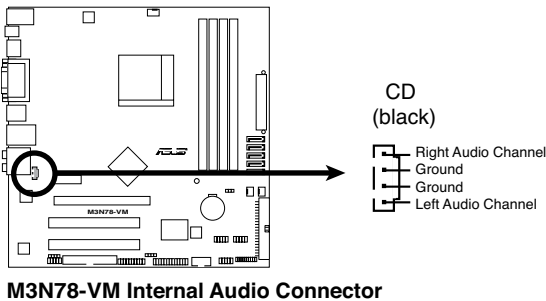

### 9. Serial port connectors (10-1 pin COM1)

The connector is for a serial (COM) port. Connect the serial port module cable to the connector, then install the module to a slot opening at the back of the system chassis.



The serial port bracket (COM1) is purchased separately.

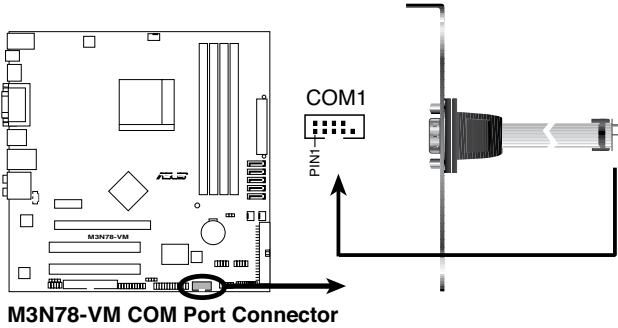

### 10. Front panel audio connector (10-1 pin AAFP)

This connector is for a chassis-mounted front panel audio I/O module that supports either High Definition Audio or AC`97 audio standard. Connect one end of the front panel audio I/O module cable to this connector.

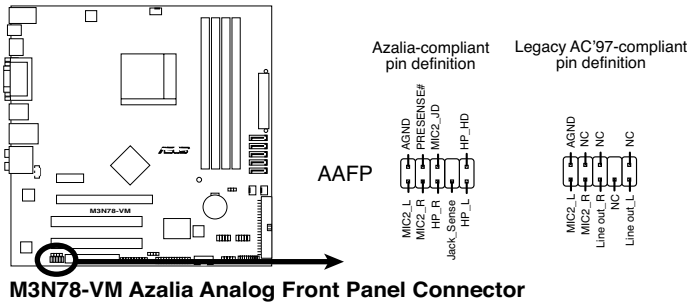

- We recommend that you connect a high-definition front panel audio module to this connector to avail of the motherboard high-definition audio capability.
- If you want to connect a high-definition front panel audio module to this connector, ensure that the **Front Panel Type** item in the BIOS is set to [HD Audio]; if you want to connect an AC`97 front panel audio module to this connector, set the item to [AC97]. See page 2-29 for details.

## 11. Chassis intrusion connector (4-1 pin CHASSIS)

This connector is for a chassis-mounted intrusion detection sensor or switch. Connect one end of the chassis intrusion sensor or switch cable to this connector. The chassis intrusion sensor or switch sends a high-level signal to this connector when a chassis component is removed or replaced. The signal is then generated as a chassis intrusion event.

By default, the pin labeled “Chassis Signal” and “Ground” are shorted with a jumper cap. Remove the jumper caps only when you intend to use the chassis intrusion detection feature.

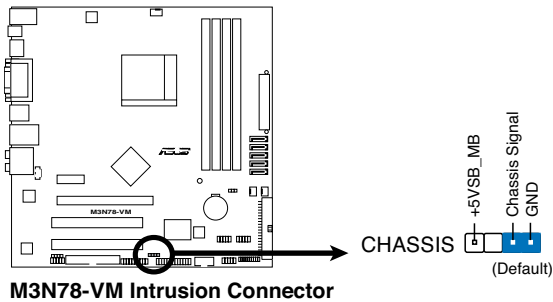

## 12. LPT connector

The LPT (Line Printing Terminal) connector supports devices such as a printer. LPT standardizes as IEEE 1284, which is the parallel port interface on IBM PC-compatible computers.

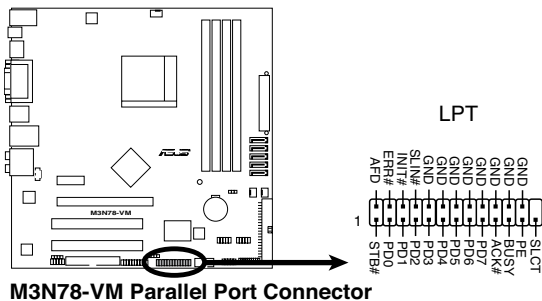

### 13. ATX power connectors (24-pin ATX-PWRGD, 4-pin ATX12V)

These connectors are for an ATX power supply. The plugs from the power supply are designed to fit these connectors in only one orientation. Find the proper orientation and push down firmly until the connectors completely fit.

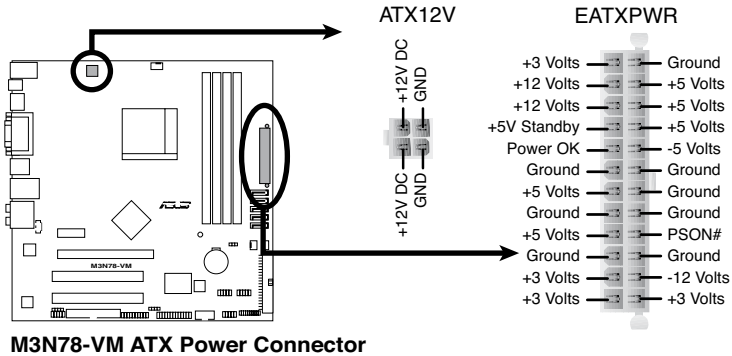

**M3N78-VM ATX Power Connector**



- We recommend that you use an ATX 12 V Specification 2.0-compliant power supply unit (PSU) with a minimum of 300 W power rating. This PSU type has 24-pin and 4-pin power plugs.
- If you intend to use a PSU with 20-pin and 4-pin power plugs, ensure that the 20-pin power plug can provide at least 15 A on +12 V and that the PSU has a minimum power rating of 300 W. The system may become unstable or may not boot up if the power is inadequate.
- Do not forget to connect the 4-pin ATX +12 V power plug. Otherwise, the system will not boot up.
- We recommend that you use a PSU with higher power output when configuring a system with more power-consuming devices. The system may become unstable or may not boot up if the power is inadequate.
- If you are uncertain about the minimum power supply requirement for your system, refer to the Recommended Power Supply Wattage Calculator at <http://support.asus.com/PowerSupplyCalculator/PSCalculator.aspx?SLanguage=en-us> for details.
- You must install a PSU with a higher power rating if you intend to install additional devices.

#### 14. System panel connector (20-8 pin PANEL)

This connector supports several chassis-mounted functions.

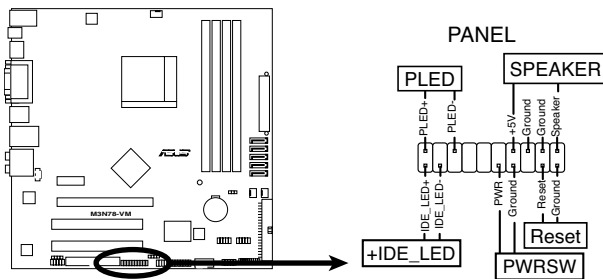

**M3N78-VM System Panel Connector**

- **System power LED (2-pin PLED)**  
This 2-pin connector is for the system power LED. Connect the chassis power LED cable to this connector. The system power LED lights up when you turn on the system power, and blinks when the system is in sleep mode.
- **Hard disk drive activity LED (2-pin +IDE\_LED)**  
This 2-pin connector is for the HDD Activity LED. Connect the HDD Activity LED cable to this connector. The IDE LED lights up or flashes when data is read from or written to the HDD.
- **System warning speaker (4-pin SPEAKER)**  
This 4-pin connector is for the chassis-mounted system warning speaker. The speaker allows you to hear system beeps and warnings.
- **Power/Soft-off button (2-pin PWRSW)**  
This 2-pin connector is for the system power button. Pressing the power button turns the system ON or puts the system in SLEEP or SOFT-OFF mode depending on the BIOS settings. Pressing the power switch for more than four seconds while the system is ON turns the system OFF.
- **Reset button (2-pin Reset)**  
This 2-pin connector is for the chassis-mounted reset button for system reboot without turning off the system power.





This chapter tells how to change the system settings through the BIOS Setup menus. Detailed descriptions of the BIOS parameters are also provided.

# BIOS setup **2**

## 2.1 Managing and updating your BIOS

The following utilities allow you to manage and update the motherboard Basic Input/Output System (BIOS) setup.

1. **ASUS EZ Flash 2:** Updates the BIOS using a floppy disk, USB Flash, or the motherboard support DVD during POST.
2. **ASUS AFUDOS:** Updates the BIOS in DOS mode using a bootable floppy disk.
3. **ASUS CrashFree BIOS 3:** Updates the BIOS using a bootable floppy disk, USB flash disk or the motherboard support DVD when the BIOS file fails or gets corrupted.
4. **ASUS Update:** Updates the BIOS in Windows® environment.

Refer to the corresponding sections for details on these utilities.



---

Save a copy of the original motherboard BIOS file to a bootable floppy disk in case you need to restore the BIOS in the future. Copy the original motherboard BIOS using the ASUS Update or AFUDOS utilities.

---

### 2.1.1 Creating a bootable floppy disk

1. Do either one of the following to create a bootable floppy disk.

#### DOS environment

- a. Insert a 1.44MB floppy disk into the drive.
- b. At the DOS prompt, type **format A:/S** then press <Enter>.

#### Windows® XP environment

- a. Insert a 1.44 MB floppy disk to the floppy disk drive.
- b. Click **Start** from the Windows® desktop, then select **My Computer**.
- c. Select the 3 1/2 Floppy Drive icon.
- d. Click **File** from the menu, then select **Format**. A Format 3 1/2 Floppy Disk window appears.
- e. Windows® XP users: Select **Create an MS-DOS startup disk** from the format options field, then click **Start**.

Windows® Vista environment

- a. Insert a formatted, high density 1.44 MB floppy disk to the floppy disk drive.
  - b. Click  from the Windows® desktop, then select **Computer**.
  - c. Right-click **Floppy Disk Drive** then click **Format** to display the **Format 3 1/2 Floppy** dialog box .
  - d. Select the **Create an MS-DOS startup disk** check box.
  - e. Click **Start**.
2. Copy the original or the latest motherboard BIOS file to the bootable floppy disk.

## 2.1.2 ASUS EZ Flash 2 utility

The ASUS EZ Flash 2 feature allows you to update the BIOS without having to go through the long process of booting from a floppy disk and using a DOS-based utility. The EZ Flash 2 utility is built-in the BIOS chip so it is accessible by pressing <Alt> + <F2> during the Power-On Self-Test (POST).

To update the BIOS using EZ Flash 2:

1. Visit the ASUS website (www.asus.com) to download the latest BIOS file for the motherboard.
2. Save the BIOS file to a floppy disk or a USB flash disk, then restart the system.
3. You can launch the EZ Flash 2 by two methods.
  - (1) Insert the floppy disk / USB flash disk that contains the BIOS file to the floppy disk drive or the USB port.

Press <Alt> + <F2> during POST to display the following.

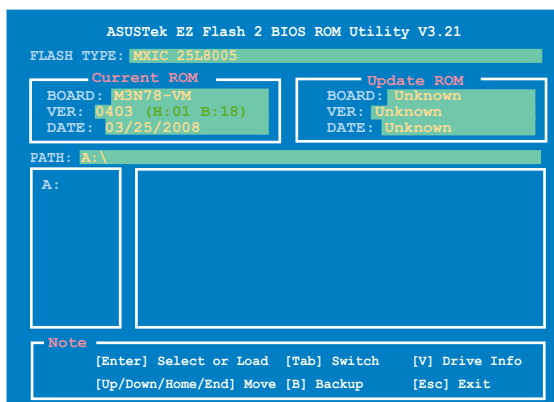

- (2) Enter BIOS setup program. Go to the **Tools** menu to select **EZ Flash 2** and press <Enter> to enable it.

You can switch between drives by pressing <Tab> before the correct file is found. Then press <Enter>.

4. When the correct BIOS file is found, EZ Flash 2 performs the BIOS update process and automatically reboots the system when done.



- This function can support devices such as USB flash disk, or floppy disk with **FAT 32/16** format only.
- Do not shut down or reset the system while updating the BIOS to prevent system boot failure!

### 2.1.3 AFUDOS utility

The AFUDOS utility allows you to update the BIOS file in DOS environment using a bootable floppy disk with the updated BIOS file. This utility also allows you to copy the current BIOS file that you can use as backup when the BIOS fails or gets corrupted during the updating process.

#### Copying the current BIOS

To copy the current BIOS file using the AFUDOS utility:



- Ensure that the floppy disk is not write-protected and has at least 1024KB free space to save the file.
- The succeeding BIOS screens are for reference only. The actual BIOS screen displays may not be same as shown.

1. Copy the AFUDOS utility (afudos.exe) from the motherboard support DVD to the bootable floppy disk you created earlier.
2. Boot the system in DOS mode, then at the prompt type:

```
afudos /o[filename]
```

where the [filename] is any user-assigned filename not more than eight alphanumeric characters for the main filename and three alphanumeric characters for the extension name.

```
A:\>afudos /oOLDBIOS1.rom
```

Main filename      Extension name

3. Press <Enter>. The utility copies the current BIOS file to the floppy disk.

```
A:\>afudos /oOLDBIOS1.rom
AMI Firmware Update Utility - Version 1.19(ASUS V2.29(03.11.24BB))
Copyright (C) 2002 American Megatrends, Inc. All rights reserved.
  Reading flash ..... done
  Write to file..... ok
A:\>
```

The utility returns to the DOS prompt after copying the current BIOS file.

## Updating the BIOS file

To update the BIOS file using the AFUDOS utility:

1. Visit the ASUS website ([www.asus.com](http://www.asus.com)) and download the latest BIOS file for the motherboard. Save the BIOS file to a bootable floppy disk.



---

Write the BIOS filename on a piece of paper. You need to type the exact BIOS filename at the DOS prompt.

---

2. Copy the AFUDOS utility (`afudos.exe`) from the motherboard support DVD to the bootable floppy disk you created earlier.
3. Boot the system in DOS mode, then at the prompt type:

```
afudos /i [filename]
```

where `[filename]` is the latest or the original BIOS file on the bootable floppy disk.

```
A:\>afudos /iM3N78-VM.ROM
```

4. The utility verifies the file and starts updating the BIOS.

```
A:\>afudos /iM3N78-VM.ROM
AMI Firmware Update Utility - Version 1.19 (ASUS V2.36 (03.11.24BB))
Copyright (C) 2002 American Megatrends, Inc. All rights reserved.

WARNING!! Do not turn off power during flash BIOS
Reading file ..... done
Reading flash ..... done

Advance Check .....
Erasing flash ..... done
Writing flash ..... 0x0008CC00 (9%)
```



---

Do not shut down or reset the system while updating the BIOS to prevent system boot failure!

---

5. The utility returns to the DOS prompt after the BIOS update process is completed. Reboot the system from the hard disk drive.

```
A:\>afudos /iM3N78-VM.ROM
AMI Firmware Update Utility - Version 1.19 (ASUS V2.36 (03.11.24BB))
Copyright (C) 2002 American Megatrends, Inc. All rights reserved.

WARNING!! Do not turn off power during flash BIOS
Reading file ..... done
Reading flash ..... done

Advance Check .....
Erasing flash ..... done
Writing flash ..... done
Verifying flash .... done

Please restart your computer

A:\>
```

## 2.1.4 ASUS CrashFree BIOS 3 utility

The ASUS CrashFree BIOS 3 is an auto recovery tool that allows you to restore the BIOS file when it fails or gets corrupted during the updating process. You can update a corrupted BIOS file using the motherboard support DVD, the floppy disk or the USB flash disk that contains the updated BIOS file.



- Prepare the motherboard support DVD, the floppy disk or the USB flash disk containing the updated motherboard BIOS before using this utility.
- Ensure that you rename the original or updated BIOS file in the floppy disk or the USB flash disk to **M3N78-VM.ROM**.

### Recovering the BIOS from a floppy disk

To recover the BIOS from a floppy disk:

1. Turn on the system.
2. Insert the floppy disk with the original or updated BIOS file to the floppy disk drive.
3. The utility displays the following message and automatically checks the floppy disk for the original or updated BIOS file.

```
Bad BIOS checksum. Starting BIOS recovery...
Checking for floppy...
```

When found, the utility reads the BIOS file and starts flashing the corrupted BIOS file.

```
Bad BIOS checksum. Starting BIOS recovery...
Checking for floppy...
Floppy found!
Reading file "M3N78-VM.ROM". Completed.
Start flashing...
```



**DO NOT** shut down or reset the system while updating the BIOS! Doing so can cause system boot failure!

4. Restart the system after the utility completes the updating process.

## Recovering the BIOS from the support DVD

To recover the BIOS from the support DVD:

1. Remove any floppy disk from the floppy disk drive, then turn on the system.
2. Insert the support DVD to the optical drive.
3. The utility displays the following message and automatically checks the floppy disk for the original or updated BIOS file.

```
Bad BIOS checksum. Starting BIOS recovery...
Checking for floppy...
```

When no floppy disk is found, the utility automatically checks the optical drive for the original or updated BIOS file. The utility then updates the corrupted BIOS file.

```
Bad BIOS checksum. Starting BIOS recovery...
Checking for floppy...
Floppy not found!
Checking for DVD-ROM...
DVD-ROM found!
Reading file "M3N78-VM.ROM". Completed.
Start flashing...
```

4. Restart the system after the utility completes the updating process.



---

The recovered BIOS may not be the latest BIOS version for this motherboard. Visit the ASUS website ([www.asus.com](http://www.asus.com)) to download the latest BIOS file.

---

## Recovering the BIOS from the USB flash disk

To recover the BIOS from the USB flash disk:

1. Insert the USB flash disk that contains BIOS file to the USB port.
2. Turn on the system.
3. The utility will automatically checks the devices for the BIOS file. When found, the utility reads the BIOS file and starts flashing the corrupted BIOS file.
4. Restart the system after the utility completes the updating process.



- Only the USB flash disk with FAT 32/16 format and single partition can support ASUS CrashFree BIOS 3. The device size should be smaller than 8GB.
  - DO NOT shut down or reset the system while updating the BIOS! Doing so can cause system boot failure!
-



## 2.1.5 ASUS Update utility

The ASUS Update is a utility that allows you to manage, save, and update the motherboard BIOS in Windows® environment. The ASUS Update utility allows you to:

- Save the current BIOS file
- Download the latest BIOS file from the Internet
- Update the BIOS from an updated BIOS file
- Update the BIOS directly from the Internet, and
- View the BIOS version information.

This utility is available in the support DVD that comes with the motherboard package.



ASUS Update requires an Internet connection either through a network or an Internet Service Provider (ISP).

---

### Installing ASUS Update

To install ASUS Update:

1. Place the support DVD in the optical drive. The **Drivers** menu appears.
2. Click the Utilities tab, then click **Install ASUS Update**. See page 3-4 for the **Utilities** screen menu.
3. The ASUS Update utility is copied to your system.



---

Quit all Windows® applications before you update the BIOS using this utility.

---

## Updating the BIOS through the Internet

To update the BIOS through the Internet:

1. Launch the ASUS Update utility from the Windows® desktop by clicking **Start > Programs > ASUS > ASUSUpdate > ASUSUpdate**. The ASUS Update main window appears.

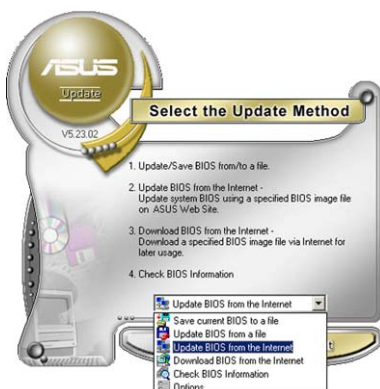
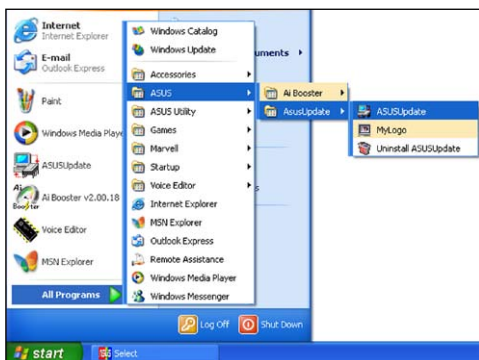

2. Select **Update BIOS from the Internet** option from the drop-down menu, then click **Next**.



3. Select the ASUS FTP site nearest you to avoid network traffic, or click **Auto Select**. Click **Next**.

- From the FTP site, select the BIOS version that you wish to download. Click **Next**.
- Follow the screen instructions to complete the update process.



The ASUS Update utility is capable of updating itself through the Internet. Always update the utility to avail all its features.

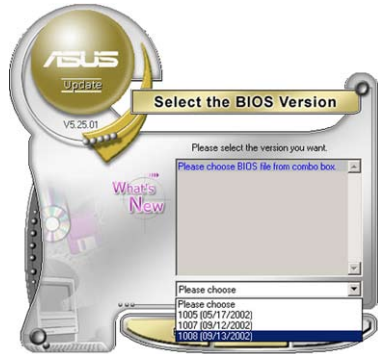

## Updating the BIOS through a BIOS file

To update the BIOS through a BIOS file:

- Launch the ASUS Update utility from the Windows® desktop by clicking Start > Programs > ASUS > ASUSUpdate > ASUSUpdate. The ASUS Update main window appears.
- Select **Update BIOS from a file** option from the drop-down menu, then click **Next**.

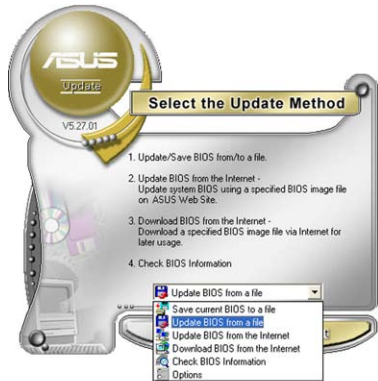

- Locate the BIOS file from the **Open** window, then click **Open**.
- Follow the screen instructions to complete the update process.

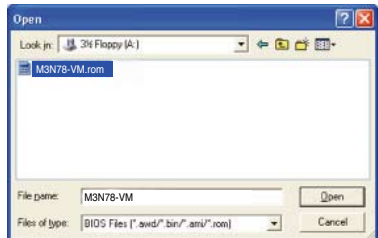

## 2.2 BIOS setup program

This motherboard supports a programmable Serial Peripheral Interface (SPI) chip that you can update using the provided utility described in section “2.1 Managing and updating your BIOS”.

Use the BIOS Setup program when you are installing a motherboard, reconfiguring your system, or prompted to “Run Setup”. This section explains how to configure your system using this utility.

Even if you are not prompted to use the Setup program, you can change the configuration of your computer in the future. For example, you can enable the security password feature or change the power management settings. This requires you to reconfigure your system using the BIOS Setup program so that the computer can recognize these changes and record them in the CMOS RAM of the SPI chip.

The SPI chip on the motherboard stores the Setup utility. When you start up the computer, the system provides you with the opportunity to run this program. Press <Del> during the Power-On Self-Test (POST) to enter the Setup utility. Otherwise, POST continues with its test routines.

If you wish to enter Setup after POST, reboot the system by doing any of the following procedures:

- Restart using the OS standard shut-down procedure.
- Press <Ctrl>+<Alt>+<Del> simultaneously.
- Press the reset button on the system chassis.
- Press the power button to turn the system off then back on.



---

Using the **power button**, **reset button**, or the **<Ctrl>+<Alt>+<Del>** keys to force reset from a running operating system can cause damage to your data or system. We recommend to always shut-down the system properly from the operating system.

---

The Setup program is designed to make it as easy to use as possible. Being a menu-driven program, it lets you scroll through the various sub-menus and make your selections from the available options using the navigation keys.



- 
- The default BIOS settings for this motherboard apply for most conditions to ensure optimum performance. If the system becomes unstable after changing any BIOS settings, load the default settings to ensure system compatibility and stability. Select the **Load Default Settings** item under the Exit Menu. See section “2.8 Exit Menu.”
  - The BIOS setup screens shown in this section are for reference purposes only, and may not exactly match what you see on your screen.
  - Visit the ASUS website ([www.asus.com](http://www.asus.com)) to download the latest BIOS file for this motherboard.
-

## 2.2.1 BIOS menu screen

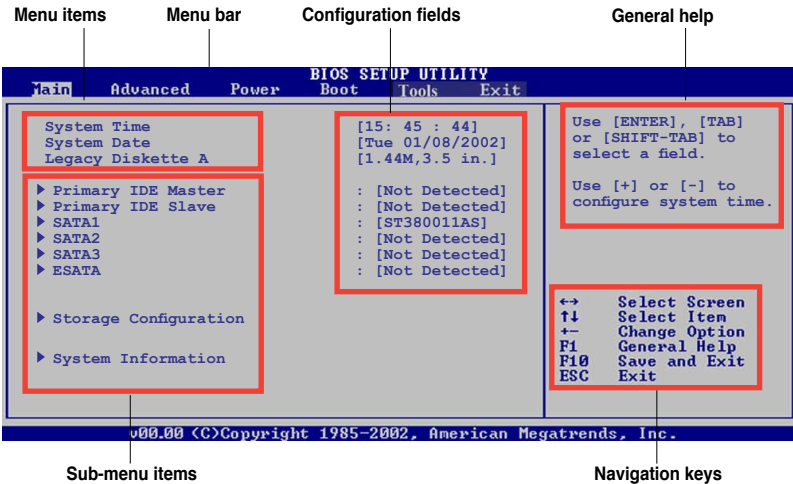

## 2.2.2 Menu bar

The menu bar on top of the screen has the following main items:

- Main** For changing the basic system configuration
- Advanced** For changing the advanced system settings
- Power** For changing the advanced power management (APM) configuration
- Boot** For changing the system boot configuration
- Tools** For setting EZ Flash 2
- Exit** For selecting the exit options and loading default settings

To select an item on the menu bar, press the right or left arrow key on the keyboard until the desired item is highlighted.



- The BIOS setup screens shown in this chapter are for reference purposes only, and may not exactly match what you see on your screen.
- Visit the ASUS website ([www.asus.com](http://www.asus.com)) to download the latest BIOS information.

### 2.2.3 Navigation keys

At the bottom right corner of a menu screen are the navigation keys for that particular menu. Use the navigation keys to select items in the menu and change the settings.



Some of the navigation keys differ from one screen to another.

### 2.2.4 Menu items

The highlighted item on the menu bar displays the specific items for that menu. For example, selecting Main shows the Main menu items.

The other items (Advanced, Power, Boot, and Exit) on the menu bar have their respective menu items.

### 2.2.5 Sub-menu items

A solid triangle before each item on any menu screen means that the item has a sub-menu. To display the sub-menu, select the item and press <Enter>.

### 2.2.6 Configuration fields

These fields show the values for the menu items. If an item is user-configurable, you can change the value of the field opposite the item. You cannot select an item that is not user-configurable.

A configurable field is enclosed in brackets, and is highlighted when selected. To change the value of a field, select it then press <Enter> to display a list of options. Refer to “2.2.7 Pop-up window.”

### 2.2.7 Pop-up window

Select a menu item then press <Enter> to display a pop-up window with the configuration options for that item.

### 2.2.8 Scroll bar

A scroll bar appears on the right side of a menu screen when there are items that do not fit on the screen. Press the Up/Down arrow keys or <Page Up> /<Page Down> keys to display the other items on the screen.

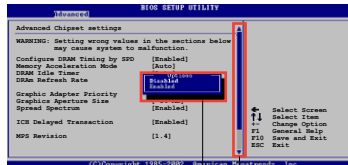

Pop-up window

Scroll bar

### 2.2.9 General help

At the top right corner of the menu screen is a brief description of the selected item.

## 2.3 Main menu

When you enter the BIOS Setup program, the Main menu screen appears, giving you an overview of the basic system information.



Refer to section “2.2.1 BIOS menu screen” for information on the menu screen items and how to navigate through them.

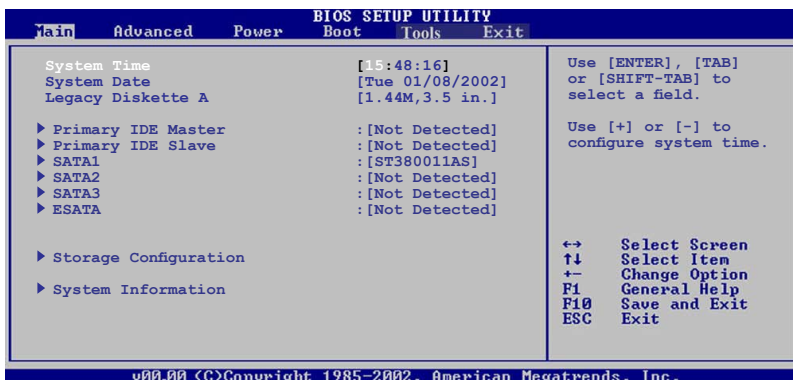

### 2.3.1 System Time [xx:xx:xx]

Allows you to set the system time.

### 2.3.2 System Date [Day xx/xx/xxxx]

Allows you to set the system date.

### 2.3.3 Legacy Diskette A [1.44M, 3.5 in.]

Sets the type of floppy drive installed. Configuration options: [Disabled] [360K, 5.25 in.] [1.2M, 5.25 in.] [720K, 3.5 in.] [1.44M 3.5 in.] [2.88M, 3.5 in.]

## 2.3.4 Primary IDE Master/Slave, SATA1~3, ESATA

While entering Setup, the BIOS automatically detects the presence of IDE devices. There is a separate sub-menu for each IDE device. Select a device item then press <Enter> to display the IDE device information.

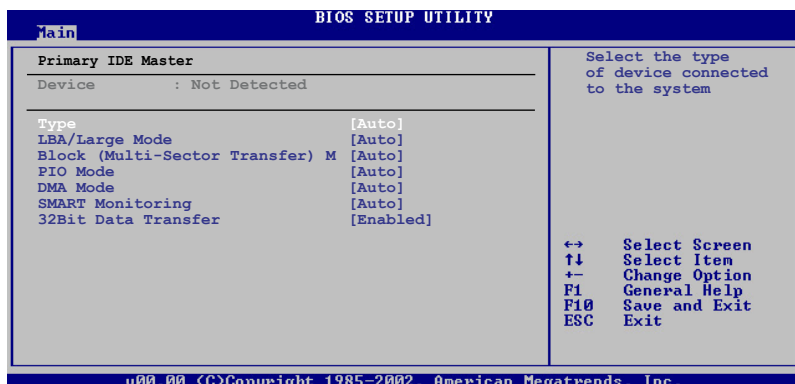

The BIOS automatically detects the values opposite the dimmed items (Device, Vendor, Size, LBA Mode, Block Mode, PIO Mode, Async DMA, Ultra DMA, and SMART monitoring). These values are not user-configurable. These items show N/A if no IDE device is installed in the system.

### Type [Auto]

Selects the type of IDE drive. Setting to Auto allows automatic selection of the appropriate IDE device type. Select CDROM if you are specifically configuring a CD-ROM drive. Select ARMD (ATAPI Removable Media Device) if your device is either a ZIP, LS-120, or MO drive. Configuration options: [Not Installed] [Auto] [CDROM] [ARMD]



This item does not appear when you select **SATA1/SATA2/SATA3/ESATA** devices.

### LBA/Large Mode [Auto]

Enables or disables the LBA mode. Setting to Auto enables the LBA mode if the device supports this mode, and if the device was not previously formatted with LBA mode disabled. Configuration options: [Disabled] [Auto]



### **Block (Multi-Sector Transfer) M [Auto]**

Enables or disables data multi-sectors transfers. When set to Auto, the data transfer from and to the device occurs multiple sectors at a time if the device supports multi-sector transfer feature. When set to [Disabled], the data transfer from and to the device occurs one sector at a time.

Configuration options: [Disabled] [Auto]

### **PIO Mode [Auto]**

Selects the PIO mode. Configuration options: [Auto] [0] [1] [2] [3] [4]

### **DMA Mode [Auto]**

Selects the DMA mode. Configuration options: [Auto]

### **SMART Monitoring [Auto]**

Enables or disables the S.M.A.R.T. (Self Monitoring and Reporting Technology) capability of your hard drive. This features allows your system to report read/write errors of the hard drive and to issue warnings when a third party hardware monitor utility is installed. Configuration options: [Auto] [Disabled] [Enabled]

### **32Bit Data Transfer [Enabled]**

Enables or disables 32-bit data transfer. Configuration options: [Disabled] [Enabled]

## 2.3.5 Storage Configuration

The items in this menu allow you to set or change the configurations for the IDE devices installed in the system. Select an item then press <Enter> if you wish to configure the item.

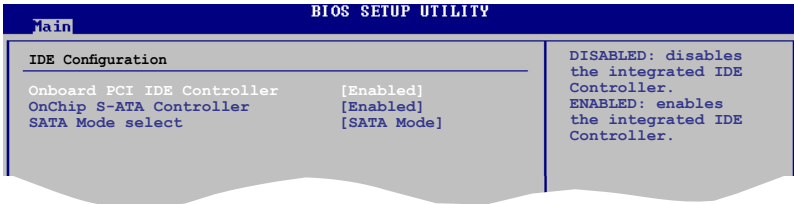

### Onboard PCI IDE Controller [Enabled]

Allows you to enable or disable the onboard PCI IDE controller.  
Configuration options: [Enabled] [Disabled]

### OnChip S-ATA Controller [Enabled]

Allows you to disable or set the OnChip S-ATA devices.  
Configuration options: [Enabled] [Disabled]

### SATA Mode select [SATA Mode]

Allows you to select the SATA Mode. Configuration options: [SATA Mode] [RAID Mode] [AHCI Mode]



---

The following items appears only when the **SATA Mode select** item is set to [RAID Mode].

---

### SATA1/2/3/5/6 [Enabled]

Allows you to disable or enable the SATA1/2/3/5/6.  
Configuration options: [Disabled] [Enabled]

### ESATA [Enabled]

Allows you to disable or enable the ESATA.  
Configuration options: [Disabled] [Enabled]

## 2.3.6 System Information

This menu gives you an overview of the general system specifications. The BIOS automatically detects the items in this menu.

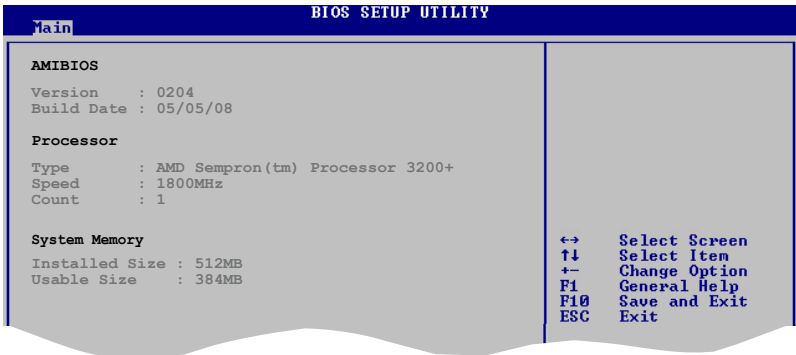

### AMI BIOS

Displays the auto-detected BIOS information

### Processor

Displays the auto-detected CPU specification

### System Memory

Displays the auto-detected system memory

## 2.4 Advanced menu

The Advanced menu items allow you to change the settings for the CPU and other system devices.



Take caution when changing the settings of the Advanced menu items. Incorrect field values can cause the system to malfunction.

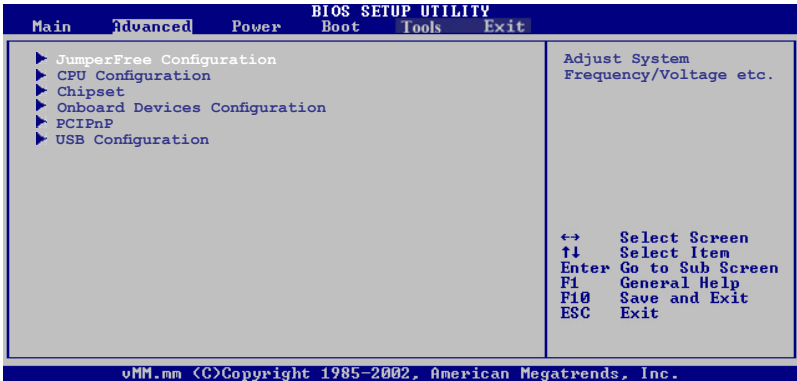

### 2.4.1 JumperFree Configuration

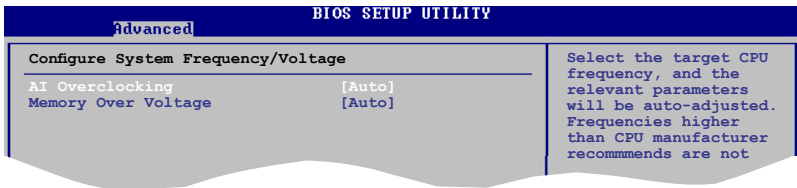

#### AI Overclocking [Auto]

Allows selection of CPU overclocking options to achieve desired CPU internal frequency. Select either one of the preset overclocking configuration options:

[Auto] - allows you to set overclocking parameters automatically.

[Manual] - allows you to individually set overclocking parameters.

[Overclock Profile] - loads overclocking profiles with optimal parameters for stability when overclocking.



---

The following two items appear only when the **AI Overclocking** item is set to [Manual].

---

### **CPU Frequency, MHz [200]**

Allows you to enter an integer value to over clock for CPU.

Configuration options: [Min.=200] [Max.=400]

### **MCP PCI-Express Frequency, MHz [100]**

Allows you to enter an integer value to over clock for PCIE.

Configuration options: [Min.=100] [Max.=150]

### **iGPU OverClock [500]**

Allows you to enter an integer value to over clock for iGPU.

Configuration options: [Min.=500] [Max.=999]

### **Shader OverClock [1200]**

Allows you to enter an integer value to over clock for shader.

Configuration options: [Min.=1000] [Max.=2000]



---

The following two items appear only when the **AI Overclocking** item is set to [Overclock Profile].

---

### **Overclock Options [Auto]**

Allows you to select the overclock options. Configuration options: [Auto] [Overclock 3%] [Overclock 5%] [Overclock 7%] [Test Mode]

### **Memory Over Voltage [Auto]**

Allows you to adjust the Memory Over Voltage. Configuration options: [Auto]

[20mV] [40mV] [60mV] [80mV] ~ [1280mV]

## 2.4.2 CPU Configuration

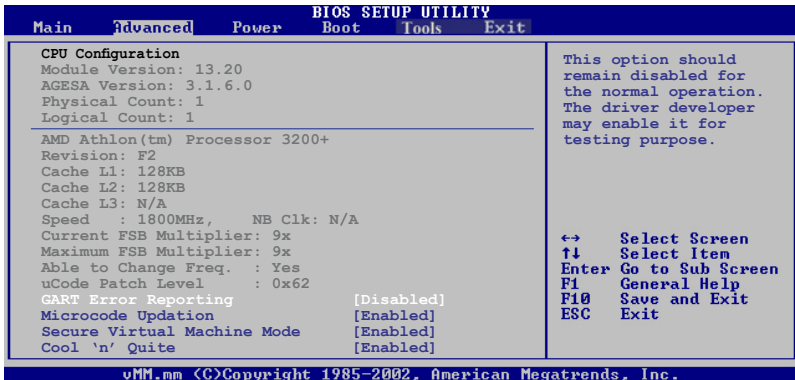

### GART Error Reporting [Disabled]

This option should remain disabled for the normal operation. The driver developer may enable it for testing purpose. Configuration options: [Disabled] [Enabled]

### Microcode Updation [Enabled]

Allows you to enable or disable the microcode updation. Configuration options: [Disabled] [Enabled]

### Secure Virtual Machine Mode [Enabled]

Allows you to enable or disable the AMD Secure Virtual Machine mode. Configuration options: [Disabled] [Enabled]

### Cool 'n' Quiet [Enabled]

Allows you to enable or disable the generation of ACPI\_PPC, \_PSS, and \_PCT objects. Configuration options: [Disabled] [Enabled]

### ACPI SRAT Table [Enabled]

Allows you to enable or disable the ACPI SRAT table. Configuration options: [Disabled] [Enabled]

## 2.4.3 Chipset

The Chipset menu allows you to change the advanced chipset settings. Select an item then press <Enter> to display the sub-menu.

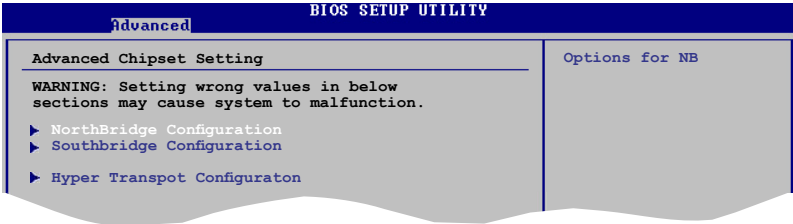

### NorthBridge Configuration

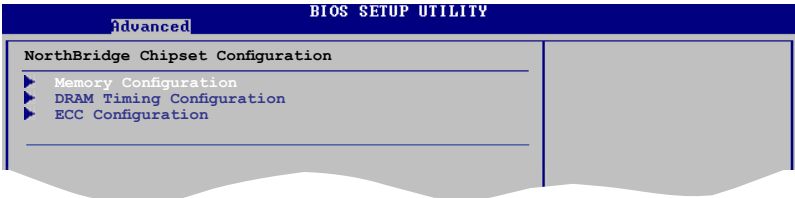

### Memory Configuration



#### Bank Interleaving [Auto]

Allows you to enable the bank memory interleaving.

Configuration options: [Disabled] [Auto]

Channel Interleaving [Disabled]

Allows you to enable the channel memory interleaving.  
Configuration options: [Disabled] [Address bits 6] [Address bits 12] [XOR of Address bits [20:16,6] ] [XOR of Address bits [20:16,9] ]

Enable Clock to All DIMMs [Disabled]

Enables or disables clock to all DIMMs. Configuration options: [Disabled] [Enabled]

MemClk Tristate C3/ALTVID [Disabled]

Enables or disables the MemClk Tristate C3/ALTVID.  
Configuration options: [Disabled] [Enabled]

Memory Hole Remapping [Enabled]

Enables or disables the memory remapping around memory hole.  
Configuration options: [Disabled] [Enabled]

DCT Unganged Mode [Always]

Allow you to enable or disable Unganged mode.  
Configuration options: [Auto] [Always]

Power Down Enable [Enabled]

Enables or disables the DDR power down mode.  
Configuration options: [Disabled] [Enabled]

## DRAM Timing Configuration

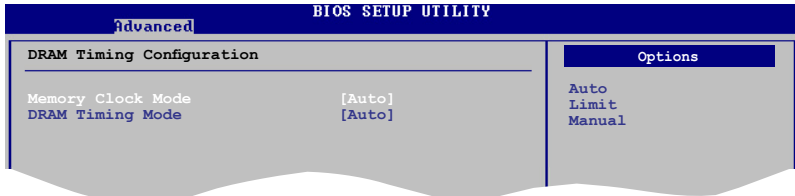

Memory Clock Mode[Auto]

Allows you to set the memoery clock mode. Configuration options: [Auto] [Limit] [Manual]

DRAM Timing Mode [Auto]

Allows you to set the DRAM timing mode. Configuration options: [Auto] [DCT 0]



## ECC Configuration

Advanced		BIOS SETUP UTILITY
<b>ECC Configuration</b>		DRAM ECC allows hardware to report and correct memory errors automatically maintaining system integrity.
ECC Mode	[Disabled]	
DRAM ECC Enable	[Disabled]	
DRAM SCRUB REDIRECT	[Disabled]	
4-Bit ECC Mode	[Disabled]	
DRAM BG Scrub	[Disabled]	
Data Cache BG Scrub	[Disabled]	
L2 Cache BG Scrub	[Disabled]	
L3 Cache BG Scrub	[Disabled]	

### ECC Mode [Disabled]

Enables or disables the DRAM ECC that allows the hardware to report and correct memory errors automatically. Configuration options: [Disabled] [Basic] [Good] [Super] [Max] [User]

### **DRAM ECC Enable [Disabled]**

Enables or disables the DRAM ECC. Configuration options: [Disabled] [Enabled]

### **DRAM SCRUB REDIRECT [Disabled]**

Enables or disables the DRAM SCRUB REDIRECT feature that allows the system to correct the DRAM ECC errors immediately when they occur. Configuration options: [Disabled] [Enabled]

### **4-Bit ECC Mode [Disabled]**

Enables or disables the ECC chip kill feature. Configuration options: [Disabled] [Enabled]

### **DRAM BG Scrub [Disabled]**

Disables or sets the DRAM BG Scrub. Configuration options: [Disabled] [40ns] [80ns] [160ns] [320ns] [640ns] [1.28us] [2.56us] [5.12us] [10.2us] [20.5us] [41.0us] [81.9us] [163.8us] [327.7us] [655.4us] [1.31ms] [2.62ms] [5.24ms] [10.49ms] [20.97ms] [42.00ms] [84.00ms]

### **Data/L2/L3 Cache BG Scrub [Disabled]**

Disables or sets the Data/L2/L3 Cache BG Scrub. This item allows the cache RAM to be corrected when idle. Configuration options: [Disabled] [40ns] [80ns] [160ns] [320ns] [640ns] [1.28us] [2.56us] [5.12us] [10.2us] [20.5us] [41.0us] [81.9us] [163.8us] [327.7us] [655.4us] [1.31ms] [2.62ms] [5.24ms] [10.49ms] [20.97ms] [42.00ms] [84.00ms]

# SouthBridge Configuration

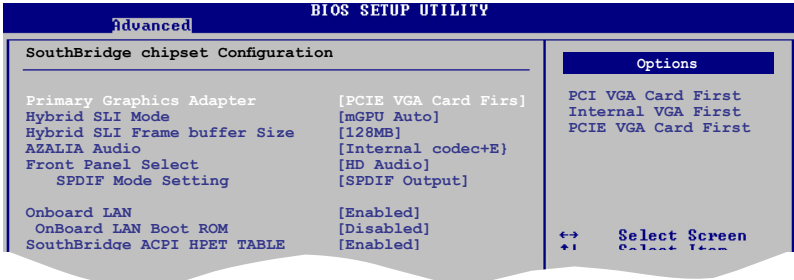

## Primary Graphics Adapter [PCIE VGA Card First]

Display Device Priority, from high to low. Configuration options: [PCIE VGA Card First] [Internal VGA First] [PCIE VGA Card First]

## Hybrid SLI Mode [mGPU Auto]

Allows you to set the Hybrid SLI mode.  
Configuration options: [mGPU Auto] [mGPU always enable]

## Hybrid SLI Frame buffer Size [128 MB]

Allows you to set the iGPU Frame Buffer Size.  
Configuration options: [32 MB] [64 MB] [128 MB] [256 MB]

## AZALIA Audio [Internal codec+External codec]

Allows you to set HD Audio mode. Configuration options: [Disabled] [Internal codec+External codec] [Internal codec] [External codec]

## Front Panel Select [HD Audio]

Allows you to set HD Audio mode. Configuration options: [AC97] [HD Audio]

### SPDIF Mode Setting [SPDIF Output]

Allows you to select the audio output mode.  
Configuration options: [HDMI Output] [SPDIF Output]

## Onboard LAN [Auto]

Allows you to set or disable the Onboard LAN. Configuration options: [Auto] [Disabled]

### OnBoard LAN Boot ROM [Disabled]

Allows you to enable or disable the OnBoard LAN Boot ROM.  
Configuration options: [Enabled] [Disabled]

## SouthBridge ACPI HPET TABLE [Enabled]

Allows you to enable or disable SouthBridge ACPI HPET TABLE.  
Configuration options: [Disabled] [Enabled]

# Hyper Transport Configuration

Advanced		BIOS SETUP UTILITY
Hyper Transport Configuration		SouthBridge to K8(CPU) frequency selection by CPU capability
SB to K8(CPU) Freq Auto	[Enabled]	

## SB to K8(CPU) Freq Auto [Enabled]

Allows you to enable or disable southbridge to K8(CPU) frequency selection by CPU capability. Configuration options: [Enabled] [Disabled]



The following two items appear only when the **SB to K8(CPU) Freq Auto** item is set to [Disabled].

## SB to K8(CPU) Frequency [1000 MHz]

Allows you to select southbridge to K8(CPU) frequency. Configuration options: [200 MHz] [400 MHz] [600 MHz] [800 MHz] [1000 MHz] [1200 MHz] [1400 MHz] [1600 MHz] [1800 MHz] [2000 MHz] [2200 MHz] [2400 MHz] [2600 MHz]

## SB to K8(CPU) LinkWidth [16 ↓ 16 ↑]

Allows you to select southbridge to K8(CPU) link width. Configuration options: [4 ↓ 4 ↑] [8 ↓ 8 ↑] [16 ↓ 16 ↑]

## 2.4.4 Onboard Devices Configuration

Advanced		BIOS SETUP UTILITY
Configure ITE8712 Super IO Chipset		Allows BIOS to select Serial Port1 Base Address.
Serial Port1 Address	[3F8/IRQ4]	
Serial Port1 Mode	[Normal]	
Parallel Port Address	[378]	
Parallel Port Mode	[Normal]	

### Serial Port1 Address [3F8/IRQ4]

Allows you to select the Serial Port1 base address. Configuration options: [Disabled] [3F8/IRQ4][2F8/IRQ3] [3E8/IRQ4] [2E8/IRQ3]

#### Serial Port1 Mode [Normal]

Allows you to select mode for Serial Port1. Configuration options: [Normal] [IrDA] [ASK IR]

### Parallel Port Address [378]

Allows you to select the Parallel Port base addresses. Configuration options: [Disabled] [378] [278] [3BC]

### Parallel Port Mode [Normal]

Allows you to select the Parallel Port mode. Configuration options: [Normal] [EPP] [ECP] [EPP+ECP]

## 2.4.5 PCI PnP

The PCI PnP menu items allow you to change the advanced settings for PCI/PnP devices. The menu includes setting IRQ and DMA channel resources for either PCI/PnP or legacy ISA devices, and setting the memory size block for legacy ISA devices.



Take caution when changing the settings of the PCI PnP menu items. Incorrect field values can cause the system to malfunction.

Advanced		BIOS SETUP UTILITY	
<b>Advanced PCI/PnP Settings</b>			
<b>WARNING:</b> Setting wrong values in below sections may cause system to malfunction.		No: lets the BIOS configure all the devices in the system. Yes: lets the operating system configure Plug and Play (PnP) devices not required for boot if your system has a Plug and Play operating system.	
Plug And Play O/S	[No]	↔	Select Screen
PCI Latency Timer	[64]	↑↓	Select Item
Allocate IRQ to PCI VGA	[Yes]	+ -	Change Option
Palette Snooping	[Disabled]	F1	General Help
IRQ-3 assigned to	[PCI Device]	F10	Save and Exit
IRQ-4 assigned to	[PCI Device]	ESC	Exit
IRQ-5 assigned to	[PCI Device]		
IRQ-7 assigned to	[PCI Device]		
IRQ-9 assigned to	[PCI Device]		
IRQ-10 assigned to	[PCI Device]		
IRQ-11 assigned to	[PCI Device]		
IRQ-14 assigned to	[PCI Device]		
IRQ-15 assigned to	[PCI Device]		
vMM.mm <C>Copyright 1985-2002, American Megatrends, Inc.			

### Plug and Play O/S [No]

When set to [No], BIOS configures all the devices in the system. When set to [Yes] and if you install a Plug and Play operating system, the operating system configures the Plug and Play devices not required for boot.

Configuration options: [No] [Yes]

### PCI Latency Timer [64]

Allows you to select the value in units of PCI clocks for the PCI device latency timer register. Configuration options: [32] [64] [96] [128] [160] [192] [224] [248]

### Allocate IRQ to PCI VGA [Yes]

When set to [Yes], BIOS assigns an IRQ to PCI VGA card if the card requests for an IRQ. When set to [No], BIOS does not assign an IRQ to the PCI VGA card even if requested. Configuration options: [Yes] [No]

### Palette Snooping [Disabled]

When set to [Enabled], the palette snooping feature informs the PCI devices that an ISA graphics device is installed in the system so that the latter can function correctly. Configuration options: [Disabled] [Enabled]

## IRQ-xx assigned to [PCI Device]

When set to [PCI Device], the specific IRQ is free for use of PCI/PnP devices.

When set to [Reserved], the IRQ is reserved for legacy ISA devices.

Configuration options: [PCI Device] [Reserved]

## 2.4.6 USB Configuration

The items in this menu allows you to change the USB-related features. Select an item then press <Enter> to display the configuration options.

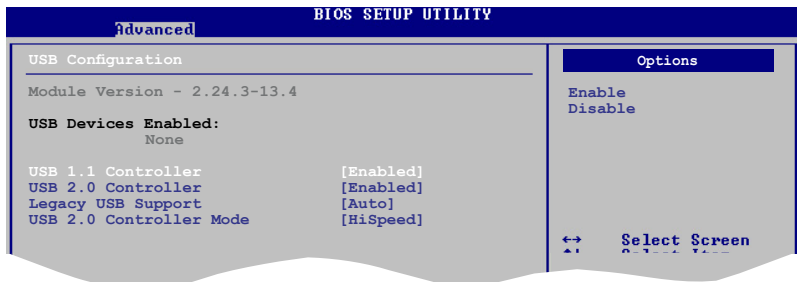

The Module Version and USB Devices Enabled items show the auto-detected values. If no USB device is detected, the item shows None.

### USB 1.1 Controller [Enabled]

Enables or disables the USB 1.1 Controller. Configuration options: [Enabled] [Disabled]

### USB 2.0 Controller [Enabled]

Enables or disables the USB 2.0 Controller. Configuration options: [Enabled] [Disabled]

### Legacy USB Support [Enabled]

Allows you to enable or disable support for Legacy USB storage devices, including USB flash drives and USB hard drives. Setting to Auto allows the system to detect the presence of USB devices at startup. If detected, the USB controller legacy mode is enabled. If no USB device is detected, the legacy USB support is disabled. Configuration options: [Disabled] [Enabled] [Auto]

### USB 2.0 Controller Mode [HiSpeed]

Allows you to configure the USB 2.0 controller in HiSpeed (480 Mbps) or Full Speed (12 Mbps). Configuration options: [Full Speed] [HiSpeed]

## 2.4.7 Trusted Computing

The items in this menu allows you to configure Trusted Computing related settings. Select an item then press <Enter> to display the configuration options.

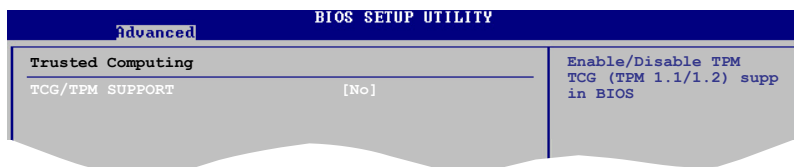

### TCG/TPM SUPPORT [No]

Allows you to enable or disable the TPM/TCG (TPM 1.1/1.2) support in BIOS.  
Configuration options: [No] [Yes]



---

The following two items appear only when the **TCG/TPM SUPPORT** item is set to [Yes].

---

#### *TPM Enable/Disable Status [No State]*

Display the TPM enable/disable status.

#### *TPM Owner Status [No State]*

Display the TPM owner status.

## 2.5 Power menu

The Power menu items allow you to change the settings for the Advanced Configuration and Power Interface (ACPI) and the Advanced Power Management (APM). Select an item then press <Enter> to display the configuration options.

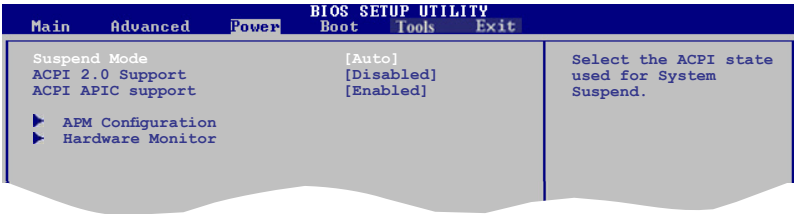

### 2.5.1 Suspend Mode [Auto]

Allows you to select the Advanced Configuration and Power Interface (ACPI) state to be used for system suspend. Configuration options: [S1 (POS) Only] [S3 Only] [Auto]

[S1 (POS) Only] - Enables the system to enter the ACPI S1 (Power on Suspend) sleep state. In S1 sleep state, the system appears suspended and stays in a low power mode. The system can be resumed at any time.

[S3 Only] - Enables the system to enter the ACPI S3 (Suspend to RAM) sleep state (default). In S3 sleep state, the system appears to be off and consumes less power than in the S1 state. When signaled by a wake-up device or event, the system resumes to its working state exactly where it was left off.

[Auto] - Detected by OS.

### 2.5.2 ACPI 2.0 Support [Disabled]

Allows you to add additional tables as per Advanced Configuration and Power Interface (ACPI) 2.0 specifications. Configuration options: [Disabled] [Enabled]

### 2.5.3 ACPI APIC Support [Enabled]

Allows you to enable or disable the Advanced Configuration and Power Interface (ACPI) support in the Application-Specific Integrated Circuit (ASIC). When set to Enabled, the ACPI APIC table pointer is included in the RSDT pointer list. Configuration options: [Disabled] [Enabled]

## 2.5.4 APM Configuration

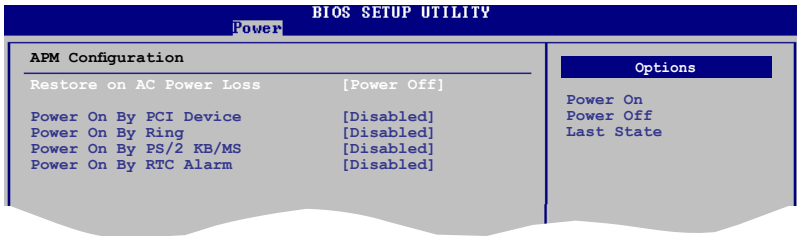

### Restore on AC Power Loss [Power Off]

When set to Power Off, the system goes into off state after an AC power loss.

When set to Power On, the system goes on after an AC power loss.

Configuration options: [Power On] [Power Off] [Last State]

### Power On By PCI Device [Disabled]

When set to [Enabled], this parameter allows you to turn on the system through a PCI LAN or modem card. This feature requires an ATX power supply that provides at least 1A on the +5VSB lead. Configuration options: [Disabled] [Enabled]

### Power On By Ring [Disabled]

Enable or disable RI to generate a wake event. Configuration options: [Disabled] [Enabled]

### Power On By PS/2 KB/MS [Disabled]

Enable or disable PS/2 Keyboard/Mouse to generate a wake event.

Configuration options: [Disabled] [Enabled]

### Power On By RTC Alarm [Disabled]

Allows you to enable or disable RTC to generate a wake event. When this item is set to Enabled, the items RTC Alarm Date, RTC Alarm Hour, RTC Alarm Minute, and RTC Alarm Second appear with set values. Configuration options: [Disabled] [Enabled]



## 2.5.5 Hardware Monitor

BIOS SETUP UTILITY	
Power	
<b>Hardware Monitor</b>	
CPU Temperature	[46°C/114.5°F]
MB Temperature	[34°C/93°F]
CPU Fan Speed	[3276RPM]
Chassis Fan Speed	[N/A]
Power Fsn Speed	[N/A]
VCORE Voltage	[ 1.232V]
3.3V Voltage	[ 3.328V]
5V Voltage	[ 4.915V]
12V Voltage	[11.916V]
Smart Q-FAN Function	[Disabled]

CPU Temperature	
↔	Select Screen
↑↓	Select Item
+−	Change Option
F1	General Help
F10	Save and Exit
ESC	Exit

uMM.mm <C>Copyright 1985-2002, American Megatrends, Inc.

### CPU Temperature [xxx°C/xxx°F]

### MB Temperature [xxx°C/xxx°F]

The onboard hardware monitor automatically detects and displays the motherboard and CPU temperatures. Select Ignored if you do not wish to display the detected temperatures.

### CPU Fan Speed [xxxxRPM] or [Ignored]

The onboard hardware monitor automatically detects and displays the CPU fan speed in rotations per minute (RPM). If the fan is not connected to the motherboard, the field shows N/A. Select Ignored if you do not wish to display the detected speed.

### Chassis/Power Fan Speed [xxxxRPM] or [N/A] or [Ignored]

The onboard hardware monitor automatically detects and displays the chassis/power fan speed in rotations per minute (RPM). If the fan is not connected to the chassis, the specific field shows N/A. Select Ignored if you do not wish to display the detected speed.

### VCORE Voltage, 3.3V Voltage, 5V Voltage, 12V Voltage

The onboard hardware monitor automatically detects the voltage output through the onboard voltage regulators.

### Smart Q-Fan Function [Disabled]

Allows you to enable or disable the ASUS Q-Fan feature that smartly adjusts the fan speeds for more efficient system operation. Configuration options: [Disabled] [Enabled]

## 2.6 Boot menu

The Boot menu items allow you to change the system boot options. Select an item then press <Enter> to display the sub-menu.

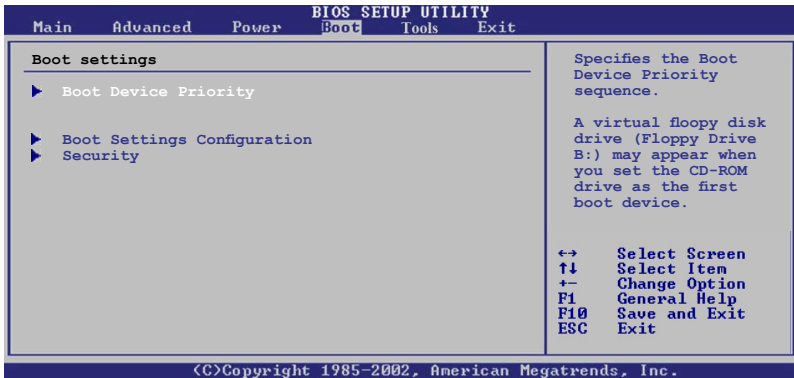

### 2.6.1 Boot Device Priority

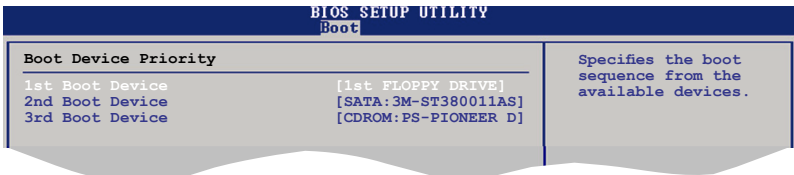

#### 1st ~ xxth Boot Device [1st Floppy Drive]

These items specify the boot device priority sequence from the available devices. The number of device items that appears on the screen depends on the number of devices installed in the system. Configuration options: [xxth Drive] [Hard Drive] [ATAPI CD-ROM ] [Disabled]

## 2.6.2 Boot Settings Configuration

BIOS SETUP UTILITY	
Boot	
Boot Settings Configuration	
Quick Boot	[Enabled]
Full Screen Logo	[Enabled]
AddOn ROM Display Mode	[Force BIOS]
Bootup Num-Lock	[On]
PS/2 Mouse Support	[Auto]
Wait For 'F1' If Error	[Enabled]
Hit 'DEL' Message Display	[Enabled]
Interrupt 19 Capture	[Disabled]

Allows BIOS to skip certain tests while booting. This will decrease the time needed to boot the system.

### Quick Boot [Enabled]

Enabling this item allows the BIOS to skip some power on self tests (POST) while booting to decrease the time needed to boot the system. When set to [Disabled], BIOS performs all the POST items. Configuration options: [Disabled] [Enabled]

### Full Screen Logo [Enabled]

This allows you to enable or disable the full screen logo display feature. Configuration options: [Disabled] [Enabled]



Set this item to [Enabled] to use the ASUS MyLogo 2™ feature.

### Add On ROM Display Mode [Force BIOS]

Sets the display mode for option ROM. Configuration options: [Force BIOS] [Keep Current]

### Bootup Num-Lock [On]

Allows you to select the power-on state for the NumLock. Configuration options: [Off] [On]

### PS/2 Mouse Support [Auto]

Allows you to enable or disable support for PS/2 mouse. Configuration options: [Disabled] [Enabled] [Auto]

### Wait for 'F1' If Error [Enabled]

When set to Enabled, the system waits for the F1 key to be pressed when error occurs. Configuration options: [Disabled] [Enabled]

### Hit 'DEL' Message Display [Enabled]

When set to Enabled, the system displays the message "Press DEL to run Setup" during POST. Configuration options: [Disabled] [Enabled]

## Interrupt 19 Capture [Disabled]

When set to [Enabled], this function allows the option ROMs to trap Interrupt 19.  
Configuration options: [Disabled] [Enabled]

### 2.6.3 Security

The Security menu items allow you to change the system security settings. Select an item then press <Enter> to display the configuration options.

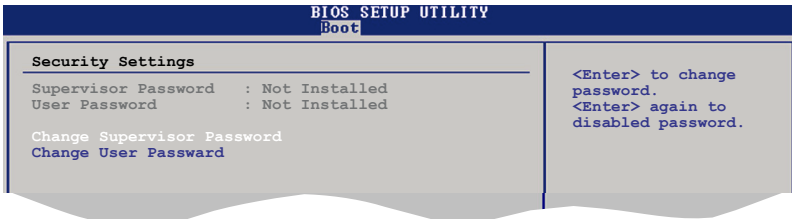

#### Change Supervisor Password

Select this item to set or change the supervisor password. The Supervisor Password item on top of the screen shows the default Not Installed. After you set a password, this item shows Installed.

To set a Supervisor Password:

1. Select the Change Supervisor Password item and press <Enter>.
2. From the password box, type a password composed of at least six letters and/or numbers, then press <Enter>.
3. Confirm the password when prompted.

The message "Password Installed" appears after you successfully set your password.

To change the supervisor password, follow the same steps as in setting a user password.

To clear the supervisor password, select the Change Supervisor Password then press <Enter>. The message "Password Uninstalled" appears.



If you forget your BIOS password, you can clear it by erasing the CMOS Real Time Clock (RTC) RAM. See section "1.9 Jumper" for information on how to erase the RTC RAM.

After you have set a supervisor password, the other items appear to allow you to change other security settings.

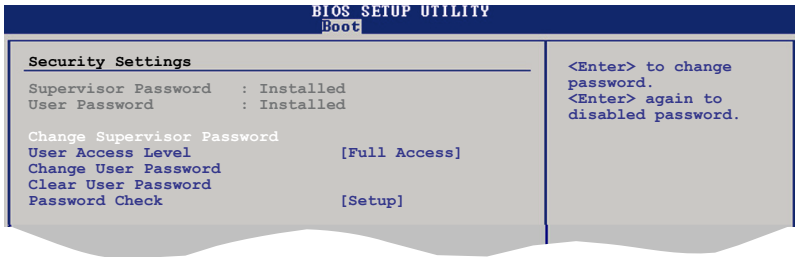

## User Access Level [Full Access]

This item allows you to select the access restriction to the Setup items.  
Configuration options: [No Access] [View Only] [Limited] [Full Access]

No Access prevents user access to the Setup utility.

View Only allows access but does not allow change to any field.

Limited allows changes only to selected fields, such as Date and Time.

Full Access allows viewing and changing all the fields in the Setup utility.

## Change User Password

Select this item to set or change the user password. The User Password item on top of the screen shows the default Not Installed. After you set a password, this item shows Installed.

To set a User Password:

1. Select the Change User Password item and press <Enter>.
2. On the password box that appears, type a password composed of at least six letters and/or numbers, then press <Enter>.
3. Confirm the password when prompted.

The message "Password Installed" appears after you set your password successfully.

To change the user password, follow the same steps as in setting a user password.

## Clear User Password

Select this item to clear the user password.

## Password Check [Setup]

When set to [Setup], BIOS checks for user password when accessing the Setup utility. When set to [Always], BIOS checks for user password both when accessing Setup and booting the system. Configuration options: [Setup] [Always]

## 2.7 Tools menu

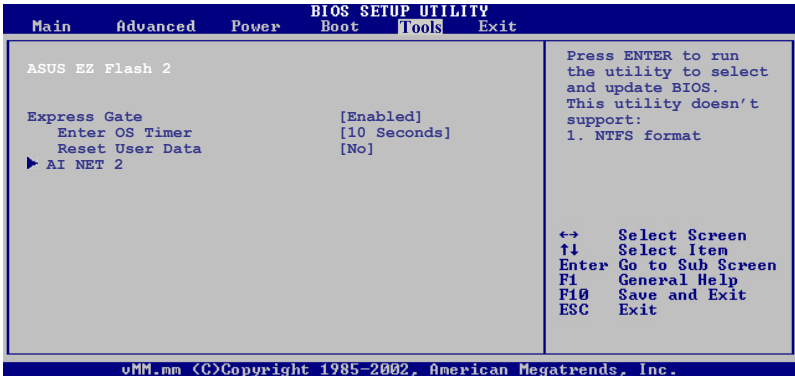

### 2.7.1 ASUS EZ Flash 2

Allows you to run ASUS EZ Flash 2. When you press <Ok>, a confirmation message appears. Use the left/right arrow key to select between [Yes] or [No], then press <Ok> to confirm your choice.

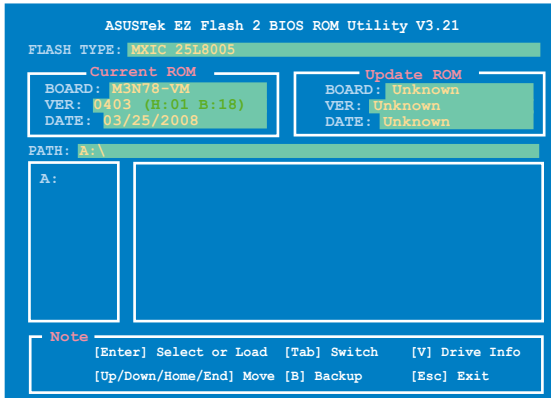

## 2.7.2 Express Gate [Enabled]

Allows you to enable or disable Express Gate. Configuration options: [Disabled] [Enabled]

### Enter OS Timer [10 Seconds]

Allows you to set the countdown duration that the system waits at the Express Gate's first screen before starting Windows or other installed OS.

Configuration options: [Prompr User] [1 Second] [3 Seconds] [5 Seconds] [10 Seconds] [15 Seconds] [20 Seconds] [30 Seconds]

### Reset User Data [No]

Allows you reset user date. When set to [Reset], user data will be cleared, and reboot to Express Gate. Configuration options: [No] [Reset]

## 2.7.3 AI NET 2

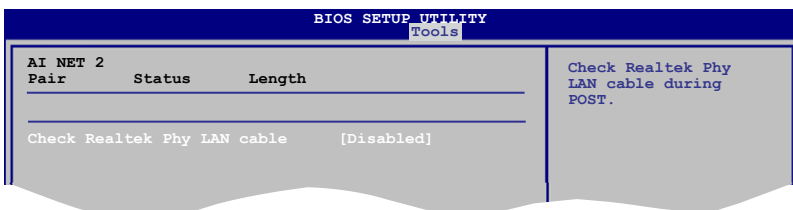

### Check Realtek Phy LAN cable [Disabled]

Allows you enable or disable checking Realtek Phy LAN cable during POST. Configuration options: [Disabled] [Enabled]

## 2.8 Exit menu

The Exit menu items allow you to load the optimal or failsafe default values for the BIOS items, and save or discard your changes to the BIOS items.

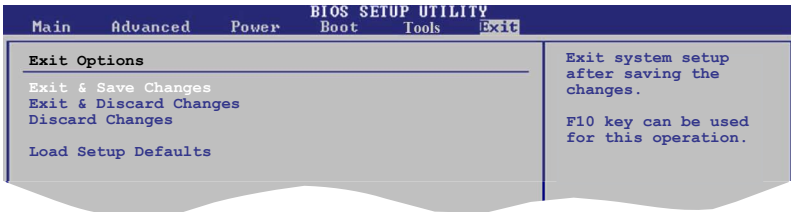

Pressing <Esc> does not immediately exit this menu. Select one of the options from this menu or <F10> from the legend bar to exit.

### Exit & Save Changes

Once you are finished making your selections, choose this option from the Exit menu to ensure the values you selected are saved to the CMOS RAM. An onboard backup battery sustains the CMOS RAM so it stays on even when the PC is turned off. When you select this option, a confirmation window appears. Select **OK** to save changes and exit.



If you attempt to exit the Setup program without saving your changes, the program prompts you with a message asking if you want to save your changes before exiting. Press <Enter> to save the changes while exiting.

### Exit & Discard Changes

Select this option only if you do not want to save the changes that you made to the Setup program. If you made changes to fields other than System Date, System Time, and Password, the BIOS asks for a confirmation before exiting.

### Discard Changes

This option allows you to discard the selections you made and restore the previously saved values. After selecting this option, a confirmation appears. Select **OK** to discard any changes and load the previously saved values.

### Load Setup Defaults

This option allows you to load the default values for each of the parameters on the Setup menus. When you select this option or if you press <F5>, a confirmation window appears. Select **OK** to load default values. Select **Exit & Save Changes** or make other changes before saving the values to the non-volatile RAM.



This chapter describes the contents of the support DVD that comes with the motherboard package.

# 3 Software support

### 3.1 Installing an operating system

This motherboard supports Windows® 32-bit XP / 32-bit Vista / 64-bit XP / 64-bit Vista operating systems (OS). Always install the latest OS version and corresponding updates to maximize the features of your hardware.



- Motherboard settings and hardware options vary. Use the setup procedures presented in this chapter for reference only. Refer to your OS documentation for detailed information.
- Ensure that you install the Windows® XP Service Pack 2 or later versions before installing the drivers for better compatibility and system stability.

### 3.2 Support DVD information

The support DVD that comes with the motherboard package contains the drivers, software applications, and utilities that you can install to avail all motherboard features.



The contents of the support DVD are subject to change at any time without notice. Visit the ASUS website (<http://www.asus.com>) for updates.

#### 3.2.1 Running the support DVD

Place the support DVD in the optical drive. The DVD automatically displays the Drivers menu if Autorun is enabled in your computer.

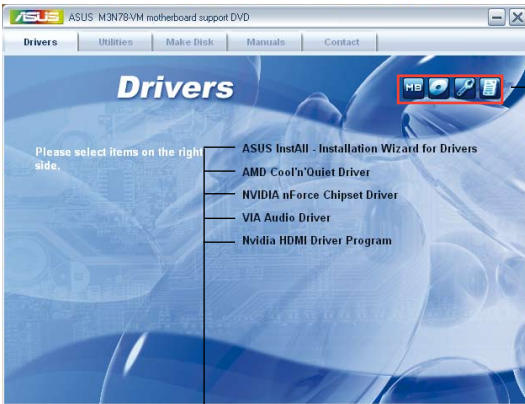

Click an icon to display support DVD/ motherboard information

Click an item to install



If Autorun is NOT enabled in your computer, browse the contents of the support DVD to locate the file ASSETUP.EXE from the BIN folder. Double-click the ASSETUP.EXE to run the DVD.

## 3.2.2 Drivers menu

The drivers menu shows the available device drivers if the system detects installed devices. Install the necessary drivers to activate the devices.



### **ASUS InstAll - Installation Wizard for Drivers**

Launches the ASUS InstAll installation wizard for drivers.

### **AMD Cool 'n' Quiet Driver**

Installs the AMD Cool 'n' Quiet driver.

### **NVIDIA nForce Chipset Driver**

Installs the NVIDIA nForce chipset driver.

### **VIA Audio Driver**

Installs the VIA audio driver and application.

### **Nvidia HDMI Driver Program**

Installs the Nvidia HDMI driver program.



---

The screen display and driver options may vary depending on the operating system version.

---

### 3.2.3 Utilities menu

The Utilities menu shows the applications and other software that the motherboard supports.

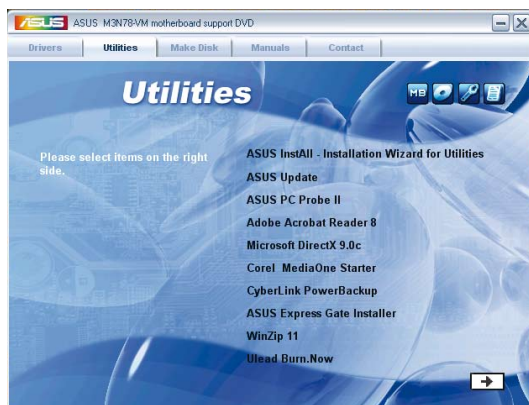

#### **ASUS InstAll - Installation Wizard for Utilities**

Launches the ASUS InstallAll installation wizard for utilities.

#### **ASUS Update**

The ASUS Update utility allows you to update the motherboard BIOS in a Windows® environment. This utility requires an Internet connection either through a network or an Internet Service Provider (ISP).

#### **ASUS PC Probe II**

This smart utility monitors the fan speed, CPU temperature, and system voltages, and alerts you of any detected problems. This utility helps you keep your computer in healthy operating condition.

#### **ASUS AI Suite**

Installs the ASUS AI Suite.

#### **ADOBE Acrobat Reader V8**

Installs the Adobe® Acrobat® Reader V8.0 that allows you to open, view, and print documents in Portable Document Format (PDF).

#### **Microsoft DirectX 9.0c**

Installs the Microsoft® DirectX 9.0c driver. The Microsoft DirectX® 9.0c is a multimedia technology that enhances computer graphics and sound. DirectX® improves the multimedia features of your computer so you can enjoy watching TV and movies, capturing videos, or playing games in your computer. Visit the Microsoft website (<http://www.microsoft.com>) for updates.

### **Corel MediaOne Starter**

Installs the Corel MediaOne Starter.

### **CyberLink PowerBackup**

Installs the CyberLink PowerBackup.

### **ASUS Express Gate Installer**

Installs the ASUS Express Gate.

### **WinZip 11**

Installs the WinZip 11.

### **Ulead Burn. Now**

Installs the Ulead Burn.Now.



Click  to show the succeeding Utilities menu below.

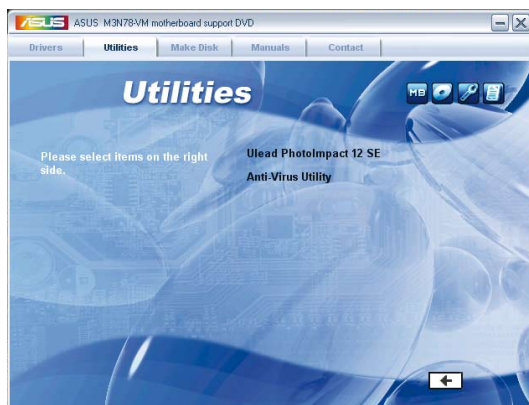

### **Ulead PhotoImpact 12 SE**

Installs the Ulead PhotoImpact 12 SE.

### **Anti-Virus Utility**

Installs the anti-virus utility.

### 3.2.4 Make Disk menu

The Make Disk menu allows you to make a RAID driver disk.



#### **NVIDIA 32/64bit XP SATA RAID Driver (Disk1/2)**

Allows you to create the NVIDIA 32/64-bit XP SATA RAID Driver disks for Windows® XP Operating System (OS).

#### **NVIDIA 32/64bit Vista SATA RAID Driver**

Allows you to create the NVIDIA 32/64-bit Vista SATA RAID Driver disk for Windows® Vista Operating System (OS).

#### **NVIDIA 32/64bit XP AHCI Driver (Disk1/2)**

Allows you to create the NVIDIA 32/64-bit XP AHCI Driver disk for Windows® XP Operating System (OS).



---

Click  to show the succeeding Make Disk menu on the next page.

---



## NVIDIA 32/64bit Vista AHCI Driver

Allows you to create the NVIDIA 32/64-bit Vista AHCI Driver disk for Windows® Vista Operating System (OS).



---

Due to floppy disk capacity limitation, when creating a RAID configuration under Windows® Vista, install the AHCI / RAID driver through the motherboard support DVD or a USB device.

Find RAID driver in the support DVD through the path below:

**Drivers\Chipset\Disk\RAID**

Find AHCI driver in the support DVD through the path below:

**Drivers\Chipset\Disk\AHCI**

---

### 3.2.5 Manual menu

The Manual menu contains a list of supplementary user manuals. Click an item to open the folder of the user manual.



Most user manual files are in Portable Document Format (PDF). Install the Adobe® Acrobat® Reader from the Utilities menu before opening a user manual file.

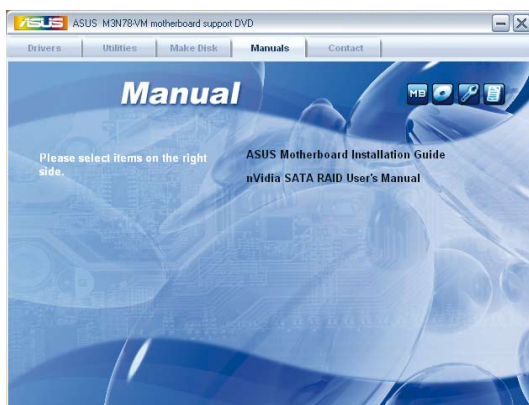

### 3.2.6 ASUS Contact information

Click the Contact tab to display the ASUS contact information. You can also find this information on the inside front cover of this user guide.





### 3.2.7 Other information

The icons on the top right corner of the screen give additional information on the motherboard and the contents of the support DVD. Click an icon to display the specified information.

#### Motherboard Info

Displays the general specifications of the motherboard.

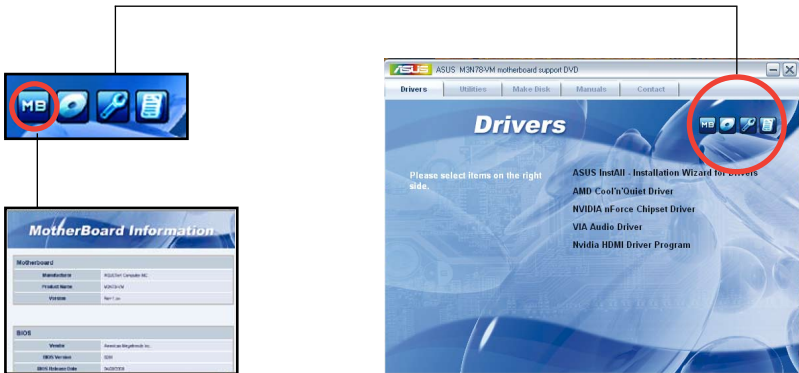

#### Browse this DVD

Displays the support DVD contents in graphical format.

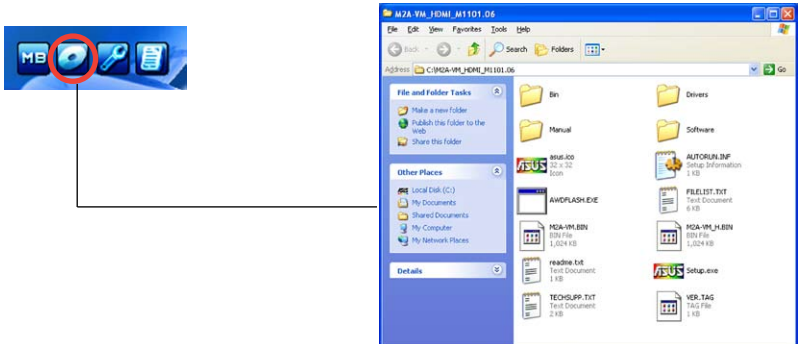



## 3.3 Creating a RAID driver disk

A floppy disk with the RAID driver is required when installing Windows® XP operating system on a hard disk drive that is included in a RAID set. For Windows® Vista™ operating system, use either the motherboard support DVD or a USB device with the RAID driver.

### 3.3.1 Creating a RAID driver disk without entering the OS

To create a RAID driver disk without entering the OS:

1. Boot your computer.
2. Press <Del> during POST to enter the BIOS setup utility.
3. Set the optical drive as the primary boot device.
4. Insert the support DVD into the optical drive.
5. Save changes and exit BIOS.
6. Press any key when the system prompts "Press any key to boot from the optical drive."
7. When the menu appears, press <1> to create a RAID driver disk.
8. Insert a formatted floppy disk into the floppy drive then press <Enter>.
9. Follow succeeding screen instructions to complete the process.

### 3.3.2 Creating a RAID driver disk in Windows®

To create a RAID driver disk in Windows®:

1. Start Windows®.
2. Place the motherboard support DVD into the optical drive.
3. Go to the Make Disk menu, then click **NVIDIA 32 / 64bit XP SATA RAID Driver** to create a NVIDIA® 32 / 64 bit XP SATA RAID driver disk.
4. Insert a floppy disk / USB device into the floppy disk drive / USB port.
5. Follow the succeeding screen instructions to complete the process.



---

Write-protect the floppy disk to avoid computer virus infection.

---

To install the RAID driver in Windows® XP:

1. During the OS installation, the system prompts you to press the F6 key to install third-party SCSI or RAID driver.
2. Press <F6> then insert the floppy disk with RAID driver into the floppy disk drive.
3. Follow the succeeding screen instructions to complete the installation.



---

**Using the driver disks you created:**

- Insert Disk1 when you see the following instruction in Windows Setup. DO NOT remove Disk1 until you are asked to insert Disk2.

```
Windows Setup
-----

Please insert the disk labeled
Manufacturer-supplied hardware support disk
into Drive A:
* Press ENTER when ready.

ENTER=Continue  ESC=Cancel  F3=Exit
```

- Remove Disk1, and insert Disk2 when you see the following instruction in Windows XP Setup.

```
Windows XP Professional Setup
-----

Insert the disk labeled:
NVIDIA RAID DRIVER <SCSI> disk 2
into Drive A:
* Press ENTER when ready.

F3=Exit  ENTER=Continue
```

- Follow the succeeding screen instructions to complete the setup.
-

To install the RAID driver in Windows® Vista™:

1. Insert the motherboard support DVD or a USB device with RAID driver into the optical drive / USB port.

Find RAID driver in the support DVD through the path below:

**Drivers\Chipset\Disk\RAID**

Find AHCI driver in the support DVD through the path below:

**Drivers\Chipset\Disk\AHCI**

2. Follow the succeeding screen instructions to complete the installation.



---

Due to chipset limitation, the Serial ATA ports supported by the NVIDIA chipset does not support Serial Optical Disk Drives (Serial ODD) under DOS.

---



This chapter tells how to use the Hybrid  
SLI® feature.

# **NVIDIA® technology** **support**

A large, light gray number '4' is positioned behind the main title text, partially overlapping the words 'technology' and 'support'.

## 4.1 NVIDIA® Hybrid SLI® Technology

The motherboard supports the NVIDIA® Hybrid SLI® technology that includes two primary features: GeForce® Boost and HybridPower™. GeForce® Boost enhances the performance of NVIDIA discrete Graphics Process Units (dGPU) when they work with the onboard motherboard GPU (mGPU). HybridPower™ unleashes the graphics performance of the dGPU and enables low-power operation when the performance of the dGPU is not needed. You can switch from the dGPU(s) to the mGPU for a quiet, power-saving computer environment.



- Hybrid SLI technology is supported by Windows® Vista™ only.
- GeForce Boost supports up to two displays simultaneously (both connected to either the mGPU or the dGPU).
- When two or more displays are connected to both the mGPU and the dGPU, the Hybrid SLI mode is disabled and the multi-display mode is enabled. In the multi-display mode, up to four displays could be connected (up to two displays driven by the mGPU and up to two displays by the dGPU).
- HybridPower requires displays to be connected to the mGPU. HybridPower cannot be enabled when displays are driven through the dGPU.
- HybridPower and GeForce Boost are supported by certain set of dGPUs. Go to [www.nvidia.com/hybridсли](http://www.nvidia.com/hybridсли) to learn the supported GPUs.

### 4.1.1 System requirements

Before using Hybrid SLI, ensure if your system meets the following requirements:

#### For best GeForce Boost performance

- AMD Phenom 9600 CPU (operating at 1800Mhz or higher)
- 2 x 1024MB of DDR2-800 DRAM
- Discrete GPU recommended for GeForce Boost
- At least 256MB of Frame Buffer carve out for the motherboard GPU

#### For best HybridPower benefits

- AMD Athlon X2 3800+ CPU (operating at 1800Mhz or higher)
- 2 x 1024MB of DDR2-667 DRAM
- Discrete GPU recommended for HybridPower
- At least 256MB of Frame Buffer carve out for the motherboard GPU



## 4.1.2 Enabling Hybrid SLI



- Before enabling GeForce Boost and HybridPower, ensure that you have installed a dGPU recommended for GeForce Boost on your motherboard.
- Ensure that you have connected your display to the dGPU. Otherwise, the motherboard cannot detect your display and no image appears.

### To enable Hybrid SLI

1. Turn on the system and press <Del> during the Power-On Self-Test (POST) to enter the BIOS Setup Utility.
2. Go to **Advanced > Chipset > SouthBridge Configuration**. Set the **Primary Graphics Adapter** item to [Internal VGA First], and **Hybrid SLI Mode** item to [mGPU always enable]. See section 2.4.3 **Chipset** for details.

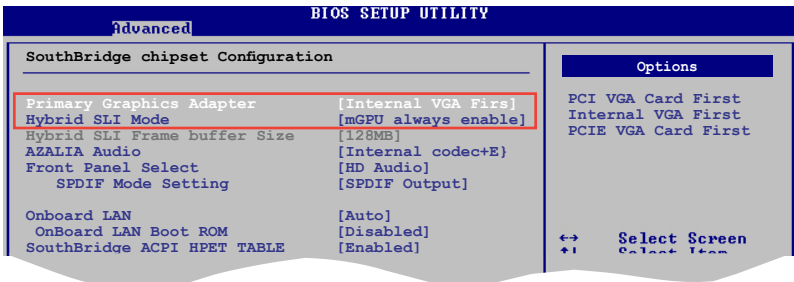

3. Save your changes and Exit Setup.
4. Turn off the system, disconnect your display from the dGPU, and connect your display to the onboard VGA port at the rear panel.
5. Turn on the system and press <Del> during the Power-On Self-Test (POST) to enter the BIOS Setup Utility.
6. Go to **Advanced > Chipset > SouthBridge Configuration**. Set the **Hybrid SLI Frame buffer Size** item to [256MB]. See section 2.4.3 **Chipset** for details.

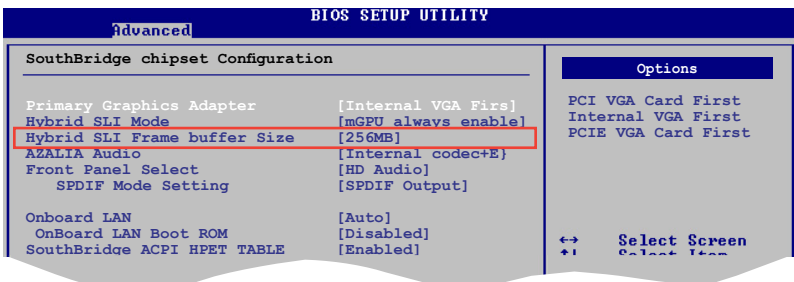



7. Save your changes and Exit Setup.
8. From the Windows® desktop, go to **Start > Control Panel > User Accounts and Family Safety** to turn off **User Account Control**.
9. Place the support DVD into the optical drive, and go to the **Drivers** menu to install the **NVIDIA Chipset Driver Program**.
10. Restart the system.

11. If the driver is correctly installed, you will find the Hybrid SLI icon on the taskbar.

The Hybrid SLI icon indicates that the system is in Performance mode and that GeForce Boost is enabled. The onboard GPU will share the rendering load with the dGPU and boost the performance of the dGPU.



12. Click the Hybrid SLI icon and select **Save Power** item.
13. The icon will change state (from  to ) to indicate that the system is in Power Saving mode, which means that the dGPU is turned off and the mGPU is both rendering and displaying.



14. When the Power Saving mode is enabled, the dGPU does not show in the Windows® Device Manager.

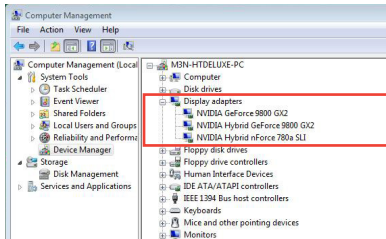

**Power Saving mode is disabled.**

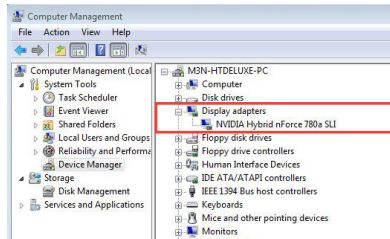

**When the Power Saving mode is enabled, the dGPU is turned off and does not appear in the Device Manager.**

## Free Manuals Download Website

<http://myh66.com>

<http://usermanuals.us>

<http://www.somanuals.com>

<http://www.4manuals.cc>

<http://www.manual-lib.com>

<http://www.404manual.com>

<http://www.luxmanual.com>

<http://aubethermostatmanual.com>

Golf course search by state

<http://golfingnear.com>

Email search by domain

<http://emailbydomain.com>

Auto manuals search

<http://auto.somanuals.com>

TV manuals search

<http://tv.somanuals.com>