

**ASUS<sup>®</sup>**

# **M Series LCD Monitor**

## *User Guide*

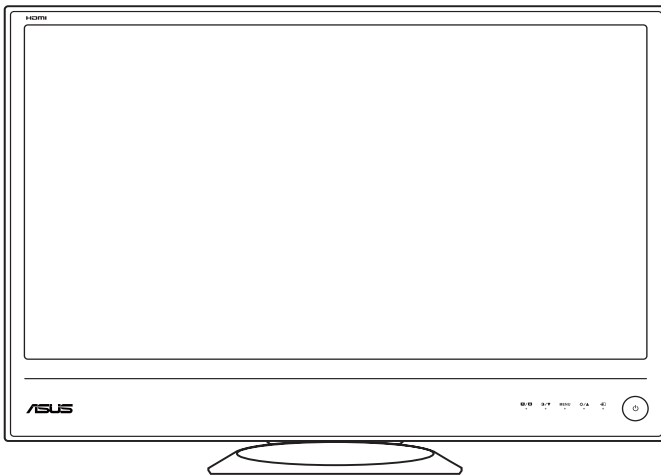

# Contents

Notices.....	iii
Safety information .....	iv
Care & Cleaning.....	v
<b>Chapter 1: Product introduction</b>	
1.1 Welcome! .....	1-1
1.2 Package contents.....	1-1
1.3 Monitor introduction.....	1-2
1.3.1 Front view .....	1-2
1.3.2 Back view.....	1-3
<b>Chapter 2: Setup</b>	
2.1 Assembling the monitor base.....	2-1
2.2 Adjusting the monitor.....	2-2
2.3 Connecting the cables.....	2-3
2.4 Turning on the monitor.....	2-3
<b>Chapter 3: General instructions</b>	
3.1 OSD (On-Screen Display) menu .....	3-1
3.1.1 How to reconfigure.....	3-1
3.1.2 OSD function introduction .....	3-1
3.2 Specifications summary (M Series).....	3-4
3.3 Troubleshooting (FAQ).....	3-5
3.4 Supported operating modes .....	3-6

# Notices

## Federal Communications Commission Statement

This device complies with Part 15 of the FCC Rules. Operation is subject to the following two conditions:

- This device may not cause harmful interference, and
- This device must accept any interference received including interference that may cause undesired operation.

This equipment has been tested and found to comply with the limits for a Class B digital device, pursuant to Part 15 of the FCC Rules. These limits are designed to provide reasonable protection against harmful interference in a residential installation. This equipment generates, uses and can radiate radio frequency energy and, if not installed and used in accordance with manufacturer's instructions, may cause harmful interference to radio communications. However, there is no guarantee that interference will not occur in a particular installation. If this equipment does cause harmful interference to radio or television reception, which can be determined by turning the equipment off and on, the user is encouraged to try to correct the interference by one or more of the following measures:

- Reorient or relocate the receiving antenna.
- Increase the separation between the equipment and receiver.
- Connect the equipment to an outlet on a circuit different from that to which the receiver is connected.
- Consult the dealer or an experienced radio/TV technician for help.



---

The use of shielded cables for connection of the monitor to the graphics card is required to assure compliance with FCC regulations. Changes or modifications to this unit not expressly approved by the party responsible for compliance could void the user's authority to operate this equipment.

---

As an Energy Star® Partner, our company has determined that this product meets the Energy Star® guidelines for energy efficiency.

## Canadian Department of Communications Statement

This digital apparatus does not exceed the Class B limits for radio noise emissions from digital apparatus set out in the Radio Interference Regulations of the Canadian Department of Communications.

This class B digital apparatus complies with Canadian ICES-003.

**This Class B digital apparatus meets all requirements of the Canadian Interference - Causing Equipment Regulations.**

**Cet appareil numérique de la classe B respecte toutes les exigences du Règlement sur le matériel brouiller du Canada.**

## Safety information

- Before setting up the monitor, carefully read all the documentation that came with the package.
- To prevent fire or shock hazard, never expose the monitor to rain or moisture.
- Never try to open the monitor cabinet. The dangerous high voltages inside the monitor may result in serious physical injury.
- If the power supply is broken, do not try to fix it by yourself. Contact a qualified service technician or your retailer.
- Before using the product, make sure all cables are correctly connected and the power cables are not damaged. If you detect any damage, contact your dealer immediately.
- Slots and openings on the back or top of the cabinet are provided for ventilation. Do not block these slots. Never place this product near or over a radiator or heat source unless proper ventilation is provided.
- The monitor should be operated only from the type of power source indicated on the label. If you are not sure of the type of power supply to your home, consult your dealer or local power company.
- Use the appropriate power plug which complies with your local power standard.
- Do not overload power strips and extension cords. Overloading can result in fire or electric shock.
- Avoid dust, humidity, and temperature extremes. Do not place the monitor in any area where it may become wet. Place the monitor on a stable surface.
- Unplug the unit during a lightning storm or if it will not be used for a long period of time. This will protect the monitor from damage due to power surges.
- Never push objects or spill liquid of any kind into the slots on the monitor cabinet.
- To ensure satisfactory operation, use the monitor only with UL listed computers which have appropriate configured receptacles marked between 100-240V AC.
- If you encounter technical problems with the monitor, contact a qualified service technician or your retailer.



---

This symbol of the crossed out wheeled bin indicates that the product (electrical, electronic equipment, and mercury-containing button cell battery) should not be placed in municipal waste. Please check local regulations for disposal of electronic products.

---

## Care & Cleaning

- Before you lift or reposition your monitor, it is better to disconnect the cables and power cord. Follow the correct lifting techniques when positioning the monitor. When lifting or carrying the monitor, grasp the edges of the monitor. Do not lift the display by the stand or the cord.
- Cleaning. Turn your monitor off and unplug the power cord. Clean the monitor surface with a lint-free, non-abrasive cloth. Stubborn stains may be removed with a cloth dampened with mild cleaner.
- Avoid using a cleaner containing alcohol or acetone. Use a cleaner intended for use with the monitor. Never spray cleaner directly on the screen, as it may drip inside the monitor and cause an electric shock.

### The following symptoms are normal with the monitor:

- The screen may flicker during the initial use due to the nature of the fluorescent light. Turn off the Power Switch and turn it on again to make sure that the flicker disappears.
- You may find slightly uneven brightness on the screen depending on the desktop pattern you use.
- When the same image is displayed for hours, an afterimage of the previous screen may remain after switching the image. The screen will recover slowly or you can turn off the Power Switch for hours.
- When the screen becomes black or flashes, or cannot work anymore, contact your dealer or service center to fix it. Do not repair the screen by yourself!

### Conventions used in this guide



**WARNING:** Information to prevent injury to yourself when trying to complete a task.



**CAUTION:** Information to prevent damage to the components when trying to complete a task.



**IMPORTANT:** Information that you **MUST** follow to complete a task.



**NOTE:** Tips and additional information to aid in completing a task.

## **Where to find more information**

Refer to the following sources for additional information and for product and software updates.

### **1. ASUS websites**

The ASUS websites worldwide provide updated information on ASUS hardware and software products. Refer to <http://www.asus.com>

### **2. Optional documentation**

Your product package may include optional documentation that may have been added by your dealer. These documents are not part of the standard package.

## 1.1 Welcome!

Thank you for purchasing the ASUS® LCD monitor!

The latest widescreen LCD monitor from ASUS provides a crisper, broader, and brighter display, plus a host of features that enhance your viewing experience.

With these features, you can enjoy the convenience and delightful visual experience that the monitor brings to you!

## 1.2 Package contents

Check your package for the following items:

- ✓ LCD monitor
- ✓ Quick start guide
- ✓ Warranty card
- ✓ Power cord + power adapter
- ✓ VGA cable
- ✓ HDMI-DVI cable (MS236/MS238/MS246/MS248/ML238/ML239) only for H SKU
- ✓ DVI cable (MS202N/MS208N)



---

If any of the above items is damaged or missing, contact your retailer immediately.

---

# 1.3 Monitor introduction

## 1.3.1 Front view

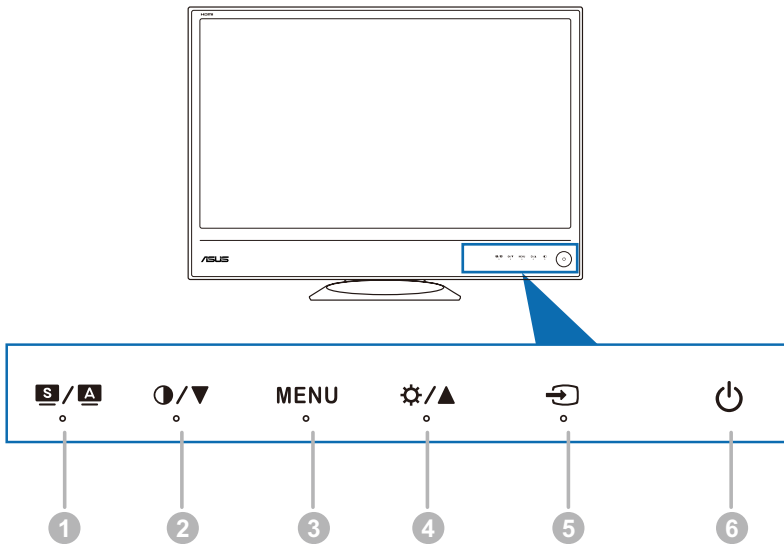

1. **S / A** button:
  - Selects a desired preset mode.
  - Exits the OSD menu or goes back to the previous menu when the OSD menu is active.
  - Automatically adjusts the image to its optimized position, clock, and phase by touching this button for 2-4 seconds (for VGA mode only).
2. **● / ▼**
  - Decreases values or moves your selection left/down.
  - Contrast hotkey
3. **MENU** button:
  - Turns on the OSD menu. Enacts the selected OSD menu item.



4. ☀ / ▲
  - Increases values or moves your selection right/up.
  - Brightness hotkey
5. ↻ button:
  - Selects an available input source.
6. ⏻ Power button/power indicator
  - Turns the monitor on/off.
  - The color definition of the power indicator is as the below table.

Status	Description
White	ON
White (fifful)	Standby mode
OFF	OFF

### 1.3.2 Back view

ML Series(ML238/ML239) only for H SKU

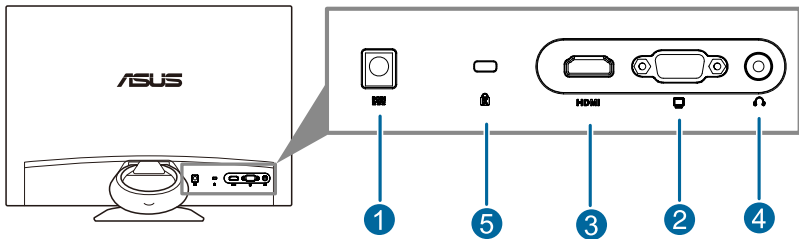

MS Series(MS236/MS238/MS246/MS248) only for H SKU

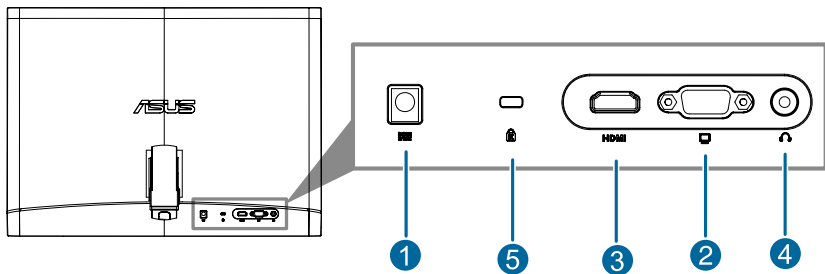

M Series (20" only of D SKU)

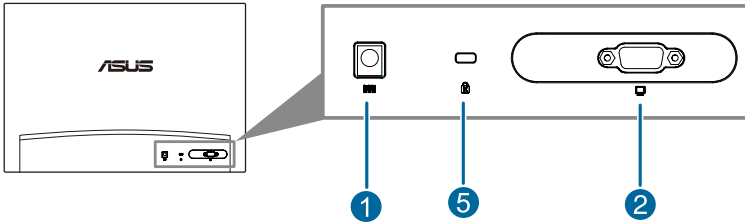

M Series (20" only of N SKU)

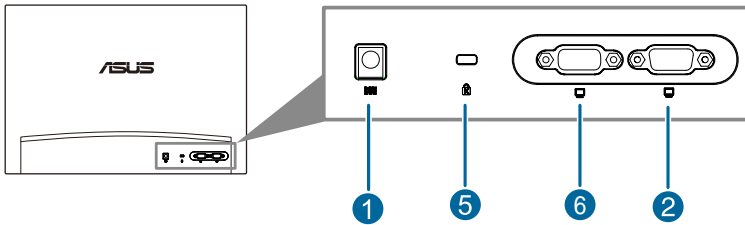

## Rear connectors

1. **DC-IN port.** This port connects the power cord.
2. **VGA port.** This 15-pin port is for PC VGA connection.
3. **HDMI port.** This port is for connection with an HDMI compatible device.
4. **Earphone jack.** This port is only available when an HDMI cable is connected.
5. **Kensington lock slot.**
6. **DVI port.** This port is for PC DVI connection.

## 2.1 Assembling the monitor arm/base

To assemble the monitor arm/base:

1. Have the front of the monitor face down on a table.
2. Place the circular arm on the back of the monitor by aligning the pins on the arm with the slots on the monitor. Use a coin or the like to turn the screw until the circular arm is securely attached to the monitor. Put the screw cover on the screw.
3. Attach the circular base to the arm by using a coin or the like to turn the screw until the circular base is securely attached to the arm.
4. The arm/base installation is complete.



We recommend that you cover the table surface with soft cloth to prevent damage to the monitor.

### ML Series

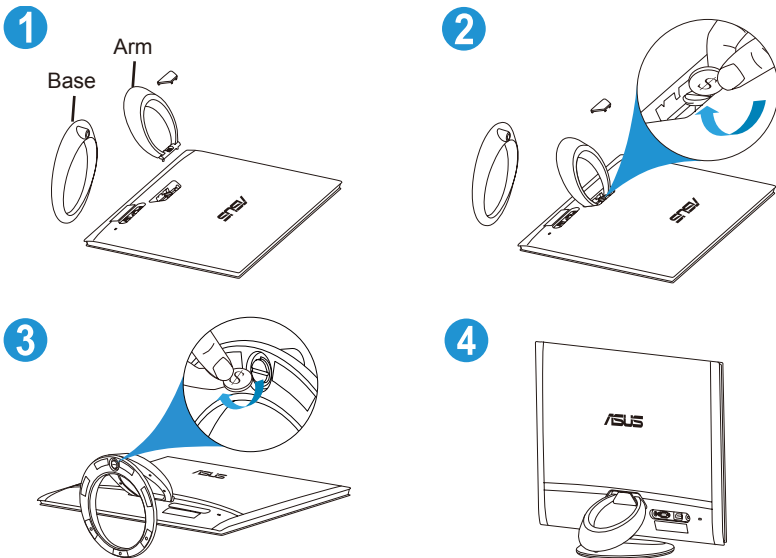

## MS Series

1

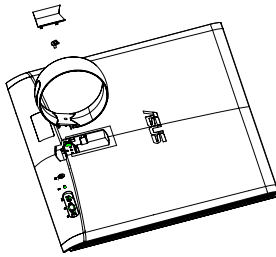

2

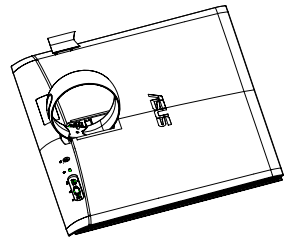

3

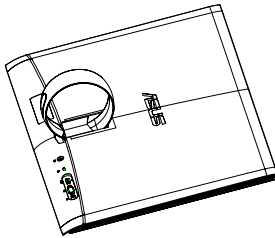

## 2.2 Adjusting the monitor

- For optimal viewing, we recommend that you look at the full face of the monitor, then adjust the monitor to the angle that is most comfortable for you.
- Hold the stand to prevent the monitor from falling when you change its angle.
- You can adjust the ML Series monitor's angle from  $+20^\circ$  to  $-5^\circ$  and it allows  $20^\circ$  swivel adjustment from either left or right.

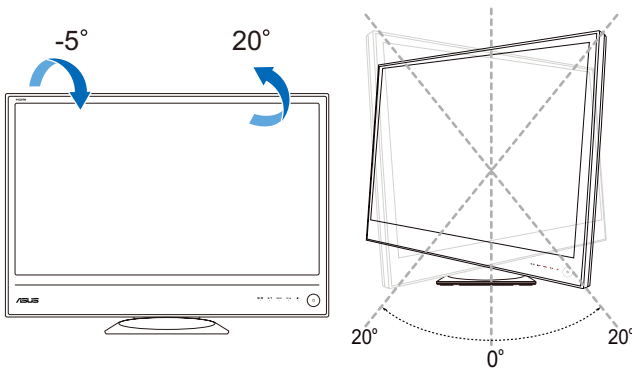

It is normal that the monitor slightly shakes while you adjust the viewing angle.

## 2.3 Connecting the cables

1. Connect the cables as the following instructions:

ML Series(ML238/ML239) only for H SKU

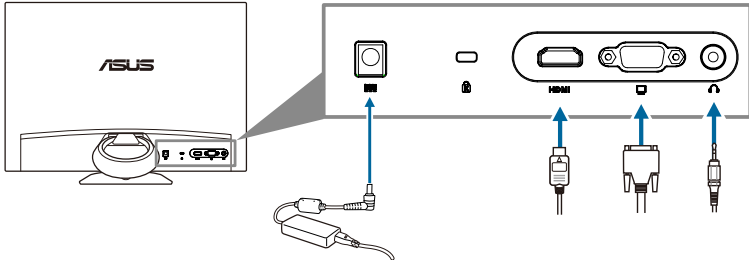

MS Series(MS236/MS238/MS246/MS248) only for H SKU

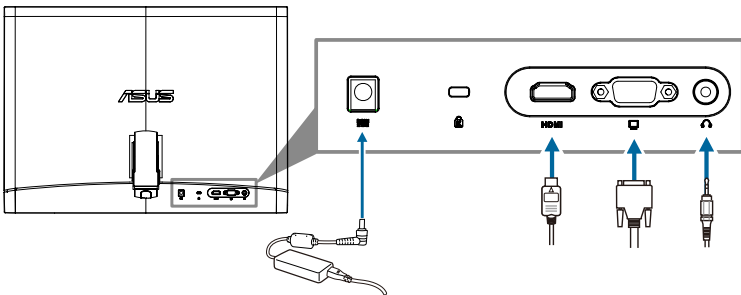

M Series (20" only of D SKU)

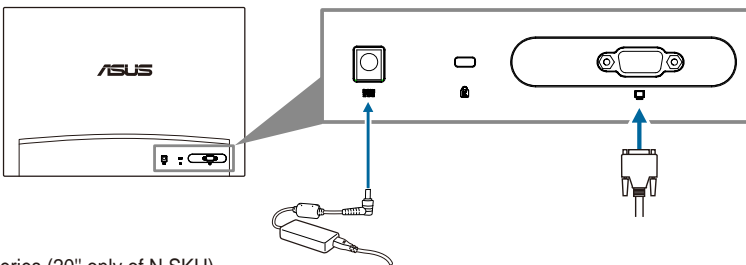

M Series (20" only of N SKU)

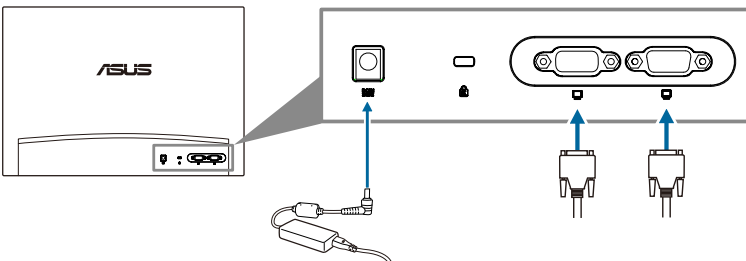

- **To connect the power cord:**
  - a. Connect the power adapter securely to the monitor's DC input port.
  - b. Connect one end of the power cord to the power adapter and the other end to a power outlet.
- **To connect the VGA/HDMI-DVI cable:**
  - a. Plug one end of the VGA/HDMI-DVI cable to the monitor's VGA/HDMI port.
  - b. Connect the other end of the VGA/HDMI-DVI cable to your computer's VGA/DVI port.
  - c. Tighten the two screws to secure the VGA/DVI connector.
- **To use the earphone (only when an HDMI cable, not the supplied HDMI-DVI cable, is connected):** connect the end with plug type to the monitor's earphone jack.





---

When these cables are connected, you can choose the desired signal from the Input Select item in the OSD menu.













---

## 2.4 Turning on the monitor

Tap the power button . See page 1-2 for the location of the power button. The power indicator  lights up in white to show that the monitor is ON.

## 3.1 OSD (On-Screen Display) menu

### 3.1.1 How to reconfigure

1. Tap the MENU button to activate the OSD menu.
2. Tap  / , and  /  to navigate through the functions. Highlight the desired function and tap the MENU button to activate it. If the function selected has a sub-menu, tap  /  and  /  again to navigate through the sub-menu functions. Highlight the desired sub-menu function and tap the MENU button to activate it.
3. Tap  / , and  /  to change the settings of the selected function.
4. To exit and save the OSD menu, tap the  button repeatedly until the OSD menu disappears. To adjust other functions, repeat steps 1-3.

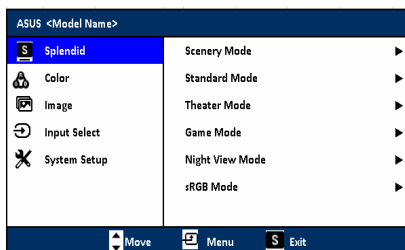

### 3.1.2 OSD function introduction

#### 1. Splendid

This function contains six sub-functions you can select for your preference. Each mode has the Reset selection, allowing you to maintain your setting or return to the preset mode.

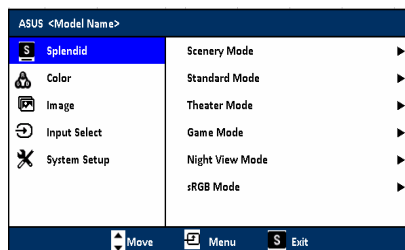

- **Standard Mode:** best choice for document editing with SPLENDID™ Video Enhancement.
- **Theater Mode:** best choice for movies with SPLENDID™ Video Enhancement.
- **Game Mode:** best choice for games playing with SPLENDID™ Video Enhancement.
- **Scenery Mode:** best choice for scenery photo display with SPLENDID™ Video Enhancement.
- **Night View Mode:** best choice for dark-scene games or movies with SPLENDID™ Video Enhancement.
- **sRGB Mode:** best choice for viewing photos and graphics from PCs.



In the Standard Mode, the ASCR, Saturation and Sharpness functions are not user-configurable.

## 2. Color

You can adjust brightness, contrast, sharpness, saturation, position (VGA only), and focus (VGA only) from this menu.

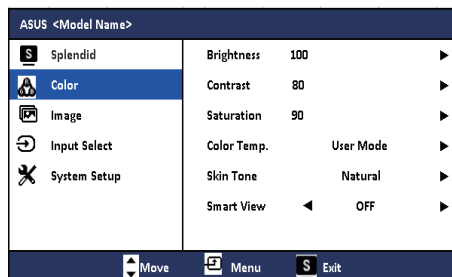

- **Brightness:** the adjusting range is from 0 to 100. ☀️ / ▲ is a hotkey to activate this function.
- **Contrast:** the adjusting range is from 0 to 100. 🌑 / ▼ is a hotkey to activate this function.
- **Saturation:** the adjusting range is from 0 to 100.
- **Color Temp.:** contains four color modes including Cool, Normal, Warm, and User Mode.
- **Skin Tone:** contains three color modes including Reddish, Natural, and Yellowish.
- **Smart View:** provides better display quality under big viewing angle.



In the User mode, colors of R (Red), G (Green), and B (Blue) are user-configurable; the adjusting range is from 0-100.

Smart View function do not use ML239 (wide view angle panel)

## 3. Image

Select the image color you like from this function.

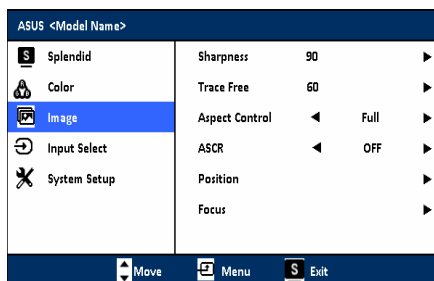

- **Sharpness:** the adjusting range is from 0 to 100.
- **Trace Free:** adjusts the response time of the monitor.
- **Aspect Control:** adjusts the aspect ratio to full, 4:3, or overscan (only available for the HDMI input).
- **ASCR:** turns on/off the ASCR (ASUS Smart Contrast Ratio) function.
- **Position:** adjusts the horizontal position (H-Position) and the vertical position (V-Position) of the image. The adjusting range is from 0 to 100.
- **Focus:** reduces Horizontal-line noise and Vertical-line noise of the image by adjusting (Phase) and (Clock) separately. The adjusting range is from 0 to 100.



- Phase adjusts the phase of the pixel clock signal. With a wrong phase adjustment, the screen shows horizontal disturbances.
- Clock (pixel frequency) controls the number of pixels scanned by one horizontal sweep. If the frequency is not correct, the screen shows vertical stripes and the image is not proportional.
- Trace Free: MS202&MS208 have no this function



#### 4. Input Select

In this function, you can select your desired input source.

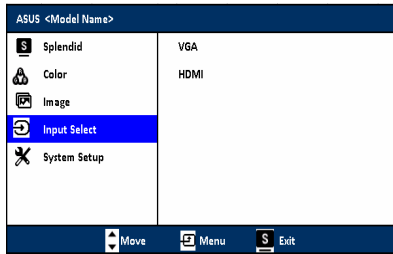

#### 5. System Setup

Allows you to adjust the system.

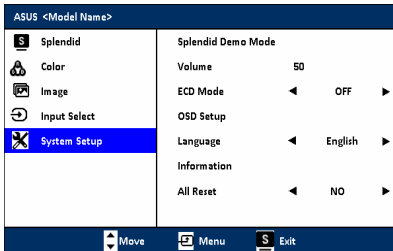





- **Splendid Demo Mode:** splits the screen into two for Splendid modes comparison.
- **Volume:** the adjusting range is from 0 to 100.
- **ECO Mode:** reduces power consumption.
- **OSD Setup:**
  - \* Adjusts the horizontal position (H-Position)/the vertical position (V-Position) of the OSD from 0 to 100.
  - \* Adjusts the OSD timeout from 10 to 120 seconds.
  - \* Enables or disables the DDC/CI function.
- **Information:** shows the monitor information.
- **Language:** there are 11 languages for your selection, including English, German, Italian, French, Dutch, Spanish, Russian, Traditional Chinese, Simplified Chinese, Japanese, and Korean.
- **All Reset:** “Yes” allows you to restore the default settings.

## 3.2 Specifications summary (M Series)

<b>Panel Type</b>	TFT LCD
<b>Panel size</b>	20",23",23.6"(16:9) wide screen
<b>Max. Resolution</b>	1920 x 1080 (MS236/MS238/MS246/MS248/ML238/ML239) 1600 x 900 (MS202/MS208)
<b>Pixel pitch</b>	0.2715 mm (MS202/MS248/MS246) 0.2768 mm (MS208) 0.2655mm (MS236, ML239) 0.2652mm (MS238/ML238)
<b>Brightness (Max.)</b>	250 cd/m <sup>2</sup>
<b>Contrast Ratio (Typ.)</b>	1000:1
<b>Contrast Ratio (Max.)</b>	50,000:1 (MS202/MS236/MS246) 10,000,000:1 (MS208/MS238/MS246/ML238) 50,000,000:1 (ML239)
<b>Viewing angle(H/V) CR&gt;10</b>	170°/160°(Typ.,)MS202/MS208) 170°/170°(Min.,)178°/178°(Typ.,)ML239) 150°/140°(Min.,)170°/160°(Typ.,)MS236/MS238/MS246/ML238)
<b>Display colors</b>	16.7 M
<b>Response time</b>	2 ms (MS236/MS238/MS246/MS248/ML238) 5 ms (MS202/MS208/ML239)
<b>SPLendid™ Video Enhancement</b>	Yes
<b>SPLendid™ selection</b>	6 video preset modes (by hotkey)
<b>Auto adjustment</b>	Yes (by hotkey)
<b>Color temperature selection</b>	4 color temperatures
<b>Skin-Tone selection</b>	3 skin-tones
<b>Digital input</b>	HDMI v1.3 (MS236/MS238/MS246/MS248/ML238/ML239)
<b>Analog input</b>	D-Sub
<b>Earphone jack</b>	Yes (Only for HDMI)
<b>Colors</b>	Black(front&back side)(MS208/MS238/MS248/ML239) Black(front side)/White(back side)(MS202/MS236/MS246/ML238)
<b>Power LED</b>	White (On)/White (Standby)
<b>Tilt</b>	+20° ~ -5°
<b>Swivel</b>	+20° ~ -20° (ML238/ML239)
<b>Kensington lock</b>	Yes
<b>AC/DC adaptor input voltage</b>	AC: 100~240V  For use only with power supply via Asus ADP-40PH AB
<b>Power consumption</b>	Power On: < 30 W, Standby: < 1 W, Power Off: < 1 W
<b>Temperature (Operating)</b>	0°C~40°C
<b>Temperature (Non-operating)</b>	-20°C~+60°C
<b>Dimension (W x H x D)</b>	497mm*362mm*151mm (machine) 568mm*414mm*151mm(machine) 555mm*415mm*129mm(package) MS202/MS208 640*mm510mm*145mm(package)MS246/MS248 566mm*407mm*151mm(machine) 561mm*429mm*220mm(machine) 640mm*482mm*126mm(package) MS236/MS238 640mm*482mm*126mm(package) ML238/ML239
<b>Weight (Esti.)</b>	2.95±0.5Kg (Net)(MS202) 2.64±0.5Kg (Net)(MS208) 3.9±0.5Kg(Net)(MS236) 3.4±0.5Kg(Net)(MS238) 4.85±0.5 Kg (Gross) 4.54±0.5 Kg(Gross) 6.0±0.5 Kg(Gross) 5.2±0.5 Kg(Gross) 3.9±0.5Kg(Net)(MS246) 3.9±0.5Kg(Net)(MS248) 3.8±0.5Kg(Net)(ML238) 3.5±0.5Kg(Net)(ML239) 6.3±0.5 Kg(Gross) 6.3±0.5 Kg(Gross) 6.0±0.5 Kg(Gross) 5.7±0.5 Kg(Gross)
<b>Multi-languages</b>	11 languages (English, German, Italian, French, Dutch, Spanish, Russian, Traditional Chinese, Simplified Chinese, Japanese, Korean)
<b>Accessories</b>	VGA cabel, HDMI-DVI cabel ,Power cord,Power adapter, Quick start guide,Warranty card (MS236/MS238/MS246/MS248/ML238/ML239) VGA cabel,DVI cabel ,Power cord,Power adapter, Quick start guide,Warranty card (MS202/MS208)
<b>Regulation approvals</b>	Energy Star®, CB, CE, Gost-R, CCC, UL/cUL, FCC, C-Tick, BSMI, VCCI, RoHS, WEEE, J-MOSS, PSB, PSE, Windows Vista, Windows 7 WHQL
<b>Back light system</b>	2CCFL (MS202/MS236/MS246) LED (MS208/MS238/MS248/ML238/ML239)

### 3.3 Troubleshooting (FAQ)

Problem	Possible Solution
Power LED is not ON	<ul style="list-style-type: none"> <li>• Tap the  button to check if the monitor is in the ON mode.</li> <li>• Check if the power cord is properly connected to the monitor and the power outlet.</li> </ul>
The power LED lights amber and there is no screen image	<ul style="list-style-type: none"> <li>• Check if the monitor and the computer are in the ON mode.</li> <li>• Make sure the signal cable is properly connected the monitor and the computer.</li> <li>• Inspect the signal cable and make sure none of the pins are bent.</li> <li>• Connect the computer with another available monitor to check if the computer is properly working.</li> </ul>
Screen image is too light or dark	<ul style="list-style-type: none"> <li>• Adjust the Contrast and Brightness settings via OSD.</li> </ul>
Screen image is not centered or sized properly	<ul style="list-style-type: none"> <li>• Touch the  /  button for 2-4 seconds to automatically adjust the image (for VGA mode only).</li> <li>• Adjust the H-Position or V-Position settings via OSD.</li> </ul>
Screen image bounces or a wave pattern is present in the image	<ul style="list-style-type: none"> <li>• Make sure the signal cable is properly connected to the monitor and the computer.</li> <li>• Move electrical devices that may cause electrical interference.</li> </ul>
Screen image has color defects (white does not look white)	<ul style="list-style-type: none"> <li>• Inspect the signal cable and make sure that none of the pins are bent.</li> <li>• Perform All Reset via OSD.</li> <li>• Adjust the R/G/B color settings or select the Color Temperature via OSD.</li> </ul>
Screen image is blurry or fuzzy	<ul style="list-style-type: none"> <li>• Touch the  /  button for 2-4 seconds to automatically adjust the image (for VGA mode only).</li> <li>• Adjust the Phase and Clock settings via OSD.</li> </ul>
No sound or sound is low	<ul style="list-style-type: none"> <li>• Ensure that the HDMI cable is properly connected to the monitor and the computer.</li> <li>• Adjust the volume settings of both your monitor and HDMI device.</li> <li>• Ensure that the computer sound card driver is properly installed and activated.</li> </ul>

## 3.4 Supported operating modes

Resolution Frequency	Horizontal Frequency (KHz)	Vertical Frequency (Hz)	Pixel (MHz)
720 x 400	31.47	70.08	28.32
640 x 480	31.47	59.94	25.18
640 x 480	35.00	66.66	30.24
640 x 480	37.87	72.82	31.50
640 x 480	37.50	75.00	31.50
800 x 600	35.16	56.25	36.00
800 x 600	37.88	60.32	40.00
800 x 600	48.08	72.12	50.00
800 x 600	46.86	75.00	49.50
832 x 624	49.72	74.55	57.28
1024 x 768	48.36	60.00	65.00
1024 x 768	56.476	70.069	75.00
1024 x 768	60.02	75.00	78.75
1152 x 864	67.50	75.00	108.00
1280 x 960	60.00	60.00	108.00
1280 x 1024	63.98	60.02	108.00
1280 x 1024	79.98	75.02	135.00
1366 x 768	47.712	59.79	85.50
1440 x 900	55.94	59.89	106.50
1600 x 1200	75.00	60.00	162.00
1680 x 1050	65.29	60.00	146.25
1920 x 1080	67.50	60.00	148.50
1600 x 900	55.90	60.00	144.00

\* Modes not listed in the table may not be supported. For optimal resolution, we recommend that you choose a mode listed in the table above.

\* This monitor supports full HD (480p, 576p, 720p, 1080i/p) video content from game consoles, DVD players and other consumer video devices via HDMI.

## Free Manuals Download Website

<http://myh66.com>

<http://usermanuals.us>

<http://www.somanuals.com>

<http://www.4manuals.cc>

<http://www.manual-lib.com>

<http://www.404manual.com>

<http://www.luxmanual.com>

<http://aubethermostatmanual.com>

Golf course search by state

<http://golfingnear.com>

Email search by domain

<http://emailbydomain.com>

Auto manuals search

<http://auto.somanuals.com>

TV manuals search

<http://tv.somanuals.com>