

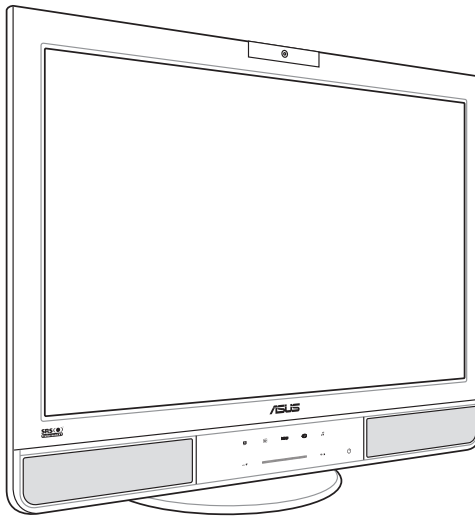

PG221 LCD Monitor

User Guide



E3121

First Edition V1

March 2007

Copyright © 2007 ASUSTeK COMPUTER INC. All Rights Reserved.

No part of this manual, including the products and software described in it, may be reproduced, transmitted, transcribed, stored in a retrieval system, or translated into any language in any form or by any means, except documentation kept by the purchaser for backup purposes, without the express written permission of ASUSTeK COMPUTER INC. ("ASUS").

Product warranty or service will not be extended if: (1) the product is repaired, modified or altered, unless such repair, modification or alteration is authorized in writing by ASUS; or (2) the serial number of the product is defaced or missing.

ASUS PROVIDES THIS MANUAL "AS IS" WITHOUT WARRANTY OF ANY KIND, EITHER EXPRESS OR IMPLIED, INCLUDING BUT NOT LIMITED TO THE IMPLIED WARRANTIES OR CONDITIONS OF MERCHANTABILITY OR FITNESS FOR A PARTICULAR PURPOSE. IN NO EVENT SHALL ASUS, ITS DIRECTORS, OFFICERS, EMPLOYEES OR AGENTS BE LIABLE FOR ANY INDIRECT, SPECIAL, INCIDENTAL, OR CONSEQUENTIAL DAMAGES (INCLUDING DAMAGES FOR LOSS OF PROFITS, LOSS OF BUSINESS, LOSS OF USE OR DATA, INTERRUPTION OF BUSINESS AND THE LIKE), EVEN IF ASUS HAS BEEN ADVISED OF THE POSSIBILITY OF SUCH DAMAGES ARISING FROM ANY DEFECT OR ERROR IN THIS MANUAL OR PRODUCT.

SPECIFICATIONS AND INFORMATION CONTAINED IN THIS MANUAL ARE FURNISHED FOR INFORMATIONAL USE ONLY, AND ARE SUBJECT TO CHANGE AT ANY TIME WITHOUT NOTICE, AND SHOULD NOT BE CONSTRUED AS A COMMITMENT BY ASUS. ASUS ASSUMES NO RESPONSIBILITY OR LIABILITY FOR ANY ERRORS OR INACCURACIES THAT MAY APPEAR IN THIS MANUAL, INCLUDING THE PRODUCTS AND SOFTWARE DESCRIBED IN IT.

Products and corporate names appearing in this manual may or may not be registered trademarks or copyrights of their respective companies, and are used only for identification or explanation and to the owners' benefit, without intent to infringe.

Table of contents

Notices.....	v
Safety information	vi
Care and cleaning	vii
Package contents	ix
Chapter 1: Product introduction	
1.1 Welcome!	1-1
1.2 Features	1-1
1.3 Monitor introduction	1-2
Front view.....	1-2
Side view.....	1-4
Rear view	1-5
Chapter 2: Setup	
2.1 Connecting the cables.....	2-1
2.1.1 Connecting to a computer with VGA/DVI ports.....	2-2
2.1.2 Connecting to a video equipment with YPbPr (component) output ports	2-2
2.1.3 Connecting to a video equipment with video (composite) output ports:	2-2
2.1.4 Connecting to a video equipment with S-Video (composite) output ports:	2-2
2.1.5 Connecting to an MP3 player or any other audio device with Line-out/Headphone ports:	2-3
2.2 Turning on the monitor	2-3
2.3 Adjusting the tilt.....	2-3
Chapter 3: General Instruction	
3.1 OSD (On-Screen Display) menu	3-1
3.1.1 How to reconfigure.....	3-1
3.1.2 OSD function introduction	3-1
3.2 Using the built-in webcam	3-3
3.2.1 Hardware	3-3
3.2.2 Software	3-3

Chapter 4: Appendix

4.1	SRS TurSurround XT™	4-1
4.2	Troubleshooting (FAQ)	4-2
4.3	PG221 specification summary	4-3
4.4	Supported operating modes	4-4

Notices

Federal Communications Commission Statement

This device complies with Part 15 of the FCC Rules. Operation is subject to the following two conditions:

- This device may not cause harmful interference, and
- This device must accept any interference received including interference that may cause undesired operation.

This equipment has been tested and found to comply with the limits for a Class B digital device, pursuant to Part 15 of the FCC Rules. These limits are designed to provide reasonable protection against harmful interference in a residential installation. This equipment generates, uses and can radiate radio frequency energy and, if not installed and used in accordance with manufacturer's instructions, may cause harmful interference to radio communications. However, there is no guarantee that interference will not occur in a particular installation. If this equipment does cause harmful interference to radio or television reception, which can be determined by turning the equipment off and on, the user is encouraged to try to correct the interference by one or more of the following measures:

- Reorient or relocate the receiving antenna.
- Increase the separation between the equipment and receiver.
- Connect the equipment to an outlet on a circuit different from that to which the receiver is connected.
- Consult the dealer or an experienced radio/TV technician for help.



The use of shielded cables for connection of the monitor to the graphics card is required to assure compliance with FCC regulations. Changes or modifications to this unit not expressly approved by the party responsible for compliance could void the user's authority to operate this equipment.

As an Energy Star® Partner, our company has determined that this product meets the Energy Star® guidelines for energy efficiency.

Canadian Department of Communications Statement

This digital apparatus does not exceed the Class B limits for radio noise emissions from digital apparatus set out in the Radio Interference Regulations of the Canadian Department of Communications.

This class B digital apparatus complies with Canadian ICES-003.

Safety information

- Before setting up the monitor, carefully read all the documentation that came with the package.
- To prevent fire or shock hazard, never expose the monitor to rain or moisture.
- Never try to open the monitor cabinet. The dangerous high voltages inside the monitor may result in serious physical injury.
- If the power supply is broken, do not try to fix it by yourself. Contact a qualified service technician or your retailer.
- Before using the product, make sure all cables are correctly connected and the power cables are not damaged. If you detect any damage, contact your dealer immediately.
- Slots and openings on the back or top of the cabinet are provided for ventilation. Do not block these slots. Never place this product near or over a radiator or heat source unless proper ventilation is provided.
- The monitor should be operated only from the type of power source indicated on the label. If you are not sure of the type of power supply to your home, consult your dealer or local power company.
- Use the appropriate power plug which complies with your local power standard.
- Do not overload power strips and extension cords. Overloading can result in fire or electric shock.
- Avoid dust, humidity, and temperature extremes. Do not place the monitor in any area where it may become wet. Place the monitor on a stable surface.
- Unplug the unit during a lightning storm or if it will not be used for a long period of time. This will protect the monitor from damage due to power surges.
- Never push objects or spill liquid of any kind into the slots on the monitor cabinet.
- To ensure satisfactory operation, use the monitor only with UL listed computers which have appropriate configured receptacles marked between 100-240V AC.
- If you encounter technical problems with the monitor, contact a qualified service technician or your retailer.



This symbol of the crossed out wheeled bin indicates that the product (electrical and electronic equipment) should not be placed in municipal waste. Please check local regulations for disposal of electronic products.

Care & Cleaning

- Before you lift or reposition your monitor, it is better to disconnect the cables and power cord. Follow the correct lifting techniques when positioning the monitor. When lifting or carrying the monitor, grasp the edges of the monitor. Do not lift the display by the stand or the cord.
- Cleaning. Turn your monitor off and unplug the power cord. Clean the monitor surface with a lint-free, non-abrasive cloth. Stubborn stains may be removed with a cloth dampened with mild cleaner.
- Avoid using a cleaner containing alcohol or acetone. Use a cleaner intended for use with the LCD. Never spray cleaner directly on the screen, as it may drip inside the monitor and cause an electric shock.

The following symptoms are normal with the monitor:

- The screen may flicker during the initial use due to the nature of the fluorescent light. Turn off the Power Switch and turn it on again to make sure that the flicker disappears.
- You may find slightly uneven brightness on the screen depending on the desktop pattern you use.
- When the same image is displayed for hours, an afterimage of the previous screen may remain after switching the image. The screen will recover slowly or you can turn off the Power Switch for hours.
- When the screen becomes black or flashes, or cannot work anymore, contact your dealer or service center to fix it. Do not repair the screen by yourself!

Conventions used in this guide



WARNING: Information to prevent injury to yourself when trying to complete a task.



CAUTION: Information to prevent damage to the components when trying to complete a task.



IMPORTANT: Information that you **MUST** follow to complete a task.



NOTE: Tips and additional information to aid in completing a task.

Where to find more information

Refer to the following sources for additional information and for product and software updates.

1. ASUS websites

The ASUS websites worldwide provide updated information on ASUS hardware and software products. Refer to <http://www.asus.com>

2. Optional documentation

Your product package may include optional documentation that may have been added by your dealer. These documents are not part of the standard package.

Package contents

Check your PG221 LCD monitor package for the following items:

- ✓ LCD monitor
- ✓ Support CD
- ✓ Quick Start Guide
- ✓ Warranty card
- ✓ 1 x Power cord
- ✓ 1 x VGA-Audio-Microphone-USB 4-in-1 cable
- ✓ 1 x DVI cable
- ✓ 1 x RCA cable
- ✓ 1 x Rear connector cover



If any of the above items is damaged or missing, contact your retailer immediately.

1.1 Welcome!

Thank you for purchasing the ASUS® PG221 LCD monitor!

The LCD monitor features high-quality audio technology, including a 15W ASUS Power Bass System and the most advanced SRS TruSurround XT™ sound effect which help provide vivid melody, enhancing your audio enjoyment while you watch movies, play games, or listen to music! The widescreen design provides a crisper, broader, and brighter display. The built-in 1.3 megapixel webcam on top of the LCD panel has both video recording and snapshot functions, allowing you to capture images, create videos, or hold a video conference! Besides, a host of user-friendly functions such as the rotating swivel, adjustable tilt, and smart touch sensor buttons facilitate the usage of the monitor, upgrading your work efficiency.

With these features, you enjoy the convenience and delightful audio-visual experience that the PG221 brings you!

1.2 Features

- 22" widescreen TFT LCD Monitor
- True resolution: 1680 X 1050 (WSXGA+)
- Anti-reflection glare type panel
- 2ms (gray-to-gray) quick response time
- 5W x2 stereo speakers
- 15W Power Bass System
- SRS TruSurround XT™ sound effect (See Appendix I)
- 3 USB 2.0 ports
- Built-in 1.3 megapixel webcam
- SPLENDID™ Video Intelligence Technology
- 5 SPLENDID™ video preset modes switched by hotkey
- 3 skin-tone selections
- 5 sound preset modes switched by hotkey
- Touch sensor controls
- VGA/DVI-D(HDCP)/Composite(Video)/S-Video/YPbPr(up to 1080i/p) inputs
- Headphone output & microphone input
- Tilt/Swivel adjustment
- Microsoft® Windows® 2000/XP/Vista compliance
- EPA ENERGY STAR® and ergonomic design
- RoHS compliance



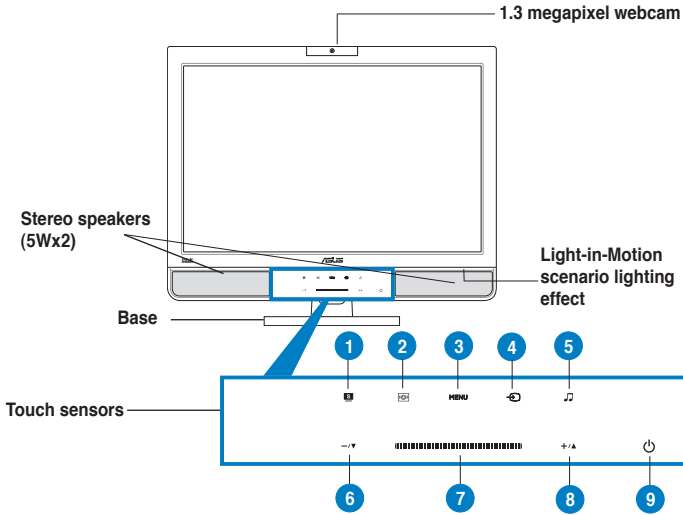

1.3 Monitor introduction

Front view





The touch sensors are sensitive. Slightly touch the item you want to enable. Do not press the front panel too hard to prevent damage to the panel and the sensors.

- S** Sensor:
 - Use this hotkey to switch to any of the five video preset modes (Standard Mode, Theater Mode, Game Mode, Night View Mode, Scenery Mode) with **SPLENDID™** Video Intelligence Technology.
 - Exit the OSD menu or go back to the previous menu as the OSD menu is active.
 - Automatically adjust the image to its optimized position, clock and phase by touching the sensor for 2-3 seconds.
- Speaker** Sensor:
 - Touch this sensor to adjust the True Bass function. This function is adjustable only when the SRS TSXT function is activated.
- MENU** Sensor:
 - Touch this sensor to activate the OSD (On-Screen Display) main menu.
 - Touch this sensor to enter/select the item (function) highlighted while the OSD menu is activated.

4.  Sensor:
 - Use this hotkey to switch to any of the six input sources (VGA, DVI, Video, S-Video, YPbPr, Music).
5.  Sensor:
 - Use this hotkey to switch to any of the five sound preset modes (Standard Mode, Fighting Game Mode, Strategic Game Mode, Theater Mode, Music Mode).
6.  Sensor:
 - Touch this sensor to decrease the value of the function selected or move to the previous function.
 - This is also a hotkey for Light-in-Motion adjustment.
7.  (Scroll-Bar) Sensor:
 - **Move your finger along this sensor to increase or decrease the value of the function selected.**
 - This is also a hotkey for Volume adjustment.
 - You can quickly access to a certain value of the function selected by **double-clicking one of the five highlighted points on the Scroll-Bar sensor** (as the following figure shows).



8.  Sensor:
 - Touch this sensor to increase the value of the function selected or move to the next function.
 - This is also a hotkey for Brightness adjustment.
9.  Power sensor/LED indicator
 - Touch this sensor to turn the monitor on/off.

Status	Description
Blue	ON
Amber	Standby mode
OFF	OFF

Side view

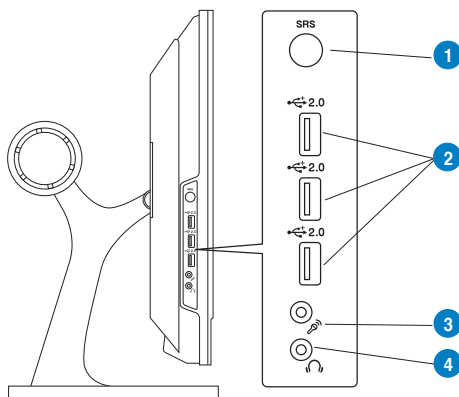

- 1 SRS On/Off button. Press this button to turn on/off the SRS sound effect.
2. USB 2.0 ports. These three Universal Serial Bus (USB) ports are available for connecting USB 2.0 devices.
3. Microphone port. This port connects a microphone with a stereo mini-plug (3.5mm).
4. Headphone port. This port connects a headphone with a stereo mini-plug (3.5 mm).



The headphone and the microphone are purchased separately.

Rear view

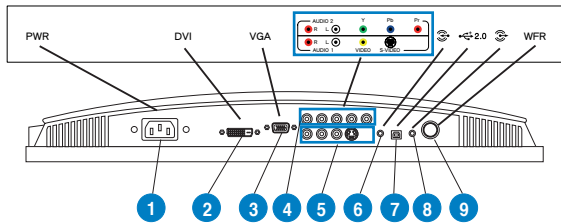
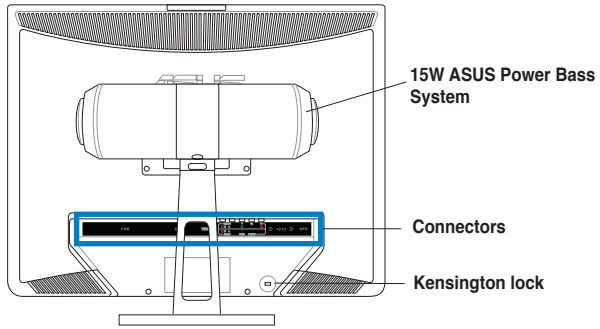

- | |
|--|
| 1. AC-in port |
| 2. DVI port |
| 3. VGA port |
| 4. L/R Audio ports + YPbPr ports |
| 5. L/R Audio ports + Video port + S-Video port |
| 6. Line-in port |
| 7. USB port (Upstream) |
| 8. Microphone-output port |
| 9. Woofer port |

2.1 Connecting the cables

Connect the cables as shown:

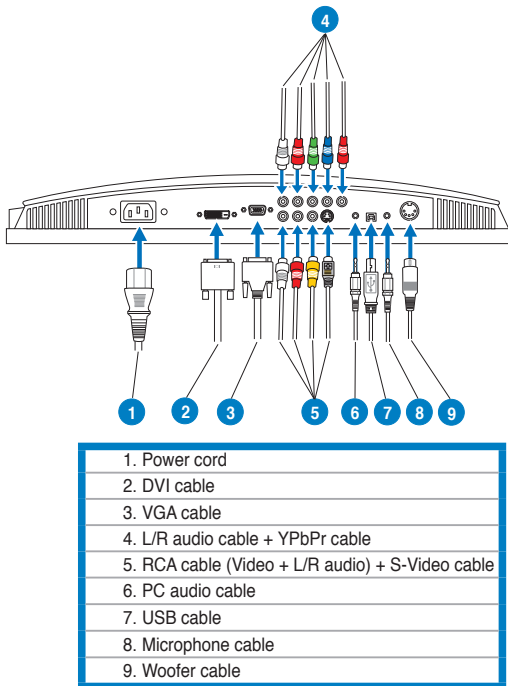

- **To connect the signal cables:** connect one end of the signal cables to the monitor, the other end to your computer or any other video equipment. Refer to section 2.1.1-2.1.5 for details.
- **To connect the woofer cable:** connect the woofer cable to the monitor's woofer port.
- **To connect the power cord:** connect one end of the power cord securely to the monitor's AC input port, the other end to a power outlet.
- **To close the rear connector cover:** Align the cover to the six slots near the ports and close the cover carefully. A click indicates that the cover has been closed successfully.



The supplied VGA-audio-microphone-USB 4-in-1 cable combines the VGA cable, audio cable, microphone cable, and USB cable.



Before you connect the cables, ensure that your PC is switched off or the power cord is unplugged from the wall socket.

2.1.1 Connecting to a computer with VGA/DVI ports:

1. Connect one end (VGA/audio(gray)/microphone(red)/USB connectors) of the supplied 4-in-1 cable to the LCD monitor's corresponding ports (VGA/Line-in(gray)/microphone-out(red)/USB ports).
2. Connect the other end of the supplied 4-in-1 cable to your computer's corresponding ports (VGA/Line-out(green)/microphone-in(red)ports).
3. Connect one end of the supplied DVI cable to the LCD monitor, then connect the other end to your computer's DVI port.



When both the VGA and the DVI cables are connected, you can choose either VGA mode or DVI mode from the Input Select item of the OSD functions, or by using the hotkey  on the front panel. See pages 1-3 and 3-2 for details.

2.1.2 Connecting to a video equipment with YPbPr (component) output ports:

1. Connect one end of the YPbPr cable to the YPbPr ports of the LCD monitor, then connect the other end to the YPbPr output ports of your video equipment.
2. Plug the red and white connectors of the supplied RCA cable or an L/R audio cable to the LCD monitor's L/R audio ports (the ports in item **4** on page 1-5), then connect the other end to the L/R audio ports of your video equipment.

2.1.3 Connecting to a video equipment with video (composite) output ports:

1. Connect one end of the supplied RCA cable to the video and L/R audio ports (the ports in item **5** on page 1-5) of the LCD monitor, then connect the other end to the video and L/R audio ports of your video equipment.

2.1.4 Connecting to a video equipment with S-Video (composite) output ports:

1. Connect one end of the S-Video cable to the LCD monitor's S-Video port, then connect the other end to the S-Video port of your video equipment.
2. Plug the red and white connectors of the supplied RCA cable or an L/R audio cable to the LCD monitor's L/R audio ports (the ports in item **5** on page 1-5), then connect the other end to the L/R audio ports of your video equipment.



2.1.5 Connecting to an MP3 player or any other audio device with Line-out/Headphone ports:

- Connect one end of an audio cable to the Line-in port of the LCD monitor, then connect the other end to the Line-out/headphone port of your MP3 player or an audio device.



The YPbPr, S-Video, and L/R audio cables are purchased separately.

2.2 Turning on the monitor

Gently touch the power sensor . See page 1-2 for the location of the power sensor. The power indicator  lights up in blue to show that the monitor is ON.

2.3 Adjusting the tilt

This monitor can be adjusted within the angles as shown:



We recommend that you adjust the viewing angle of the monitor based on the height of your desk and chair to prevent the light from reflecting to your eyes.

1. Grasp the top of the monitor and adjust the tilt within -5° to 20° .

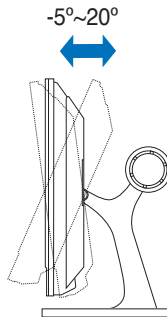

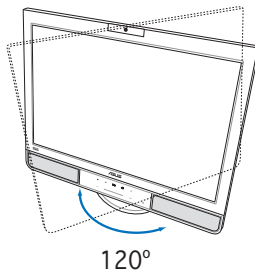

2. The swivel base allows you to turn the monitor left/right up to 120° .



3.1 OSD (On-Screen Display) menu

3.1.1 How to reconfigure

1. Touch the MENU sensor to activate the OSD menu.
2. Touch +/▲ and -/▼ to navigate through the functions. Highlight and activate the desired function by touching the MENU sensor. If the function selected has a sub-menu, touch +/▲ and -/▼ again to navigate through the sub-menu functions. Highlight and activate the desired sub-menu function by touching the MENU sensor.
3. Change the settings of the selected function by touching +/▲ and -/▼ or moving your finger along the  (Scroll-Bar) sensor.
4. To exit the OSD menu, touch the  sensor. Repeat step 2 and step 3 to adjust any other function.

3.1.2 OSD function introduction

See the table on the next page for details.



- Phase adjusts the phase of the pixel clock signal. With a wrong phase adjustment, the screen shows horizontal disturbances.
- Clock (pixel frequency) controls the number of pixels scanned by one horizontal sweep. If the frequency is not correct, the screen shows vertical stripes and the image is not proportional.
- ASCR (ASUS Smart Contrast Ratio) function allows the monitor to enhance dynamic contrast ratio during video playback.

OSD menu table:

Main	Sub-menu 1	Sub-menu 2	Description	
Splendid	Scenery Mode	Reset (NO/YES)	Video preset mode for viewing scenery	
	Standard Mode	Reset (NO/YES)	Video preset mode for generic windows use	
	Theater Mode	Reset (NO/YES)	Video preset mode for watching movies	
	Game Mode	Reset (NO/YES)	Video preset mode for playing games	
	Night View Mode	Reset (NO/YES)	Video preset mode for displaying night views	
Image	Brightness	0~100	Adjusts brightness of the image	
	Contrast	0~100	Adjusts contrast of the image	
	ASCR*	ON/OFF	Enables/disables the ASCR function	
	Sharpness*	0~100	Adjusts sharpness of the image	
	Satuation*	0~100	Adjusts saturation of the image	
	Position** (For VGA only)	H-Position		Adjusts horizontal position of the image
		V-Position		Adjusts vertical position of the image
Focus** (For VGA only)	Phase		Reduces the horizontal-line noise of the image	
	Clock		Reduces the vertical-line noise of the image	
Color	Color Temp	Cool	The image appears bluer	
		Normal	Normal image color	
		Warm	The image appears redder	
		sRGB***	The image appears sRGB standard color for multimedia designers	
	User Mode	Adjusts Red/Green/Blue levels of the image		
	Skin Tone*	Reddish	Selects reddish skin stone	
		Natural	Selects natural skin stone	
Yellowish		Selects yellowish skin stone		
Sound	Preset Mode	Standard Mode	Sound preset mode for generic windows use	
		Fighting Game Mode	Sound preset mode for playing fighting games	
		Strategic Game Mode	Sound preset mode for playing strategic games	
		Theater Mode	Sound preset mode for watching movies	
		Music Mode	Sound preset mode for listen to music	
	SRS TSXT	ON/OFF	Enables/disables the SRS TSXT sound effect	
	TruBass****	0~10	Adjusts the TruBass bass level while SRS TSXT is on	
	Balance	-10~+10	Adjusts the balance between right and left channel sounds	
	Equalizer	100/300/1K/3K/10K Hz	Adjusts 5 bands (100Hz, 300Hz, 1KHz, 3KHz, 10KHz)	
	Melody	ON/OFF	Enables/disables the melody function	
		Power Key*****	Selects 1 of 4 power on/off melodies	
Function Key*****		Selects 1 of 6 function key tones		
Input Select	VGA/DVI/Video/S-Video/YPbPr/Music	Selects a preferred input source		
System Setup	Aspect Control (AV only)	Full/4:3/Panorama/Zoom	Adjusts the aspect ratio while in Video/S-Video/YPbPr mode	
	Aspect Control (PC only)	Full/4:3/1:1	Adjusts the aspect ratio while in VGA/DVI mode	
	Light-in-Motion	0~4	Adjusts the luminance of the Light-in-Motion lighting effect	
	OSD Setup	H-Position	Adjusts horizontal position of the OSD	
		V-Position	Adjusts vertical position of the OSD	
		OSD Timeout	Adjusts OSD timeout	
	Language	Selects a preferred language among 11 languages		
	Information	Shows the resolution,HV frequency and input port of current input timing		
All Reset	NO/YES	Returns to default setting		

*: the function is disabled only when the "Standard Mode" of Spendid is selected.

** : the function is enabled only when the VGA input is selected.

***: the function is enabled only when the "Standard Mode" of Spendid is selected.

****: the function is enabled only when the SRS TSXT function is activated.

*****: the function is enabled only when the Melody function is activated.

3.2 Using the built-in webcam

This built-in webcam allows you to take photos and make videos; while talking to friends via Internet-based communication tools, you can use the webcam to show your vivid image.

3.2.1 Hardware

- The 1.3 megapixel webcam transmits images to your PC through the USB ports. Therefore, make sure that the USB connectors of the supplied 4-in-1 cable are connected to both the LCD monitor and your PC before you use the webcam. Refer to page 2-1 for the USB connectors.
- The webcam is adjustable upward and downward as shown.

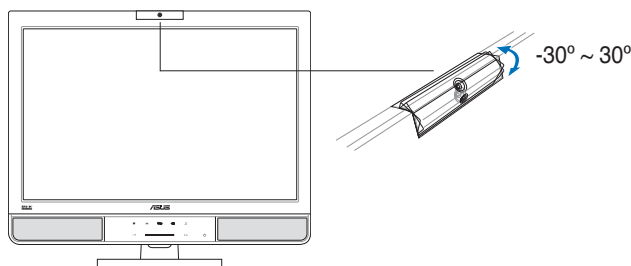

Warning: Do not turn the webcam upward or downward over 30° ; doing so might damage the webcam.

3.2.2 Software

To install the webcam driver:

1. Close all other applications first.
2. Insert the support CD into the optical drive and run the ASUS USB2.0 Webcam program.

The default webcam resolution is 640 x 480. If you want to change the default resolution to meet different kinds of application programs, go to C:\WINDOWS\ASUS USB2.0 Webcam and activate the program named LiveCam to modify the settings based on your needs.



- The default webcam captured video format is VGA (640 x 480) mode in order to increase the transmission efficiency via all kinds of Internet communication tools.
- Before using the webcam, you need to install the webcam driver into your PC.
- The webcam driver only supports Microsoft® Windows 2000/XP/Vista operating system with Microsoft® Direct X.

4.1 SRS TurSurround XT™

SRS TruSurround XT is a novel audio technology which provides an enhanced listening experience. Utilizing proprietary algorithms from SRS Labs, TruSurround is intended to regenerate a realistic audio environment, where users feel like being surrounded by sound.

TruSurround XT is a combination of four distinct and patented processing techniques from SRS Labs:

- Dialog Clarity™: the special SRS algorithms solves the signal disturbance derived from multichannel and improves the dialog clarity of movies, PC games, on-line chats, etc.
- TruSurround™: this core technology is compatible with all multichannel formats, allowing you to enjoy virtual surrounding sound experience.
- TruBass™: Developed with the proprietary psychoacoustic techniques, the TruBass technology restores low-frequency tones by augmenting harmonics.
- WOW™: WOW is a stereo enhancement technology that extends the sound space in both the horizontal and vertical planes, trully providing a 3D stereo experience.

SRS TruSurround XT™ stereo surround sound effect





SRS
TruSurround XT

is a trademark of SRS Labs, Inc.

Trusurround technology is incorporated under lincense from SRS Labs, Inc.

4.2 Troubleshooting (FAQ)

Problem	Possible Solution
Power LED is not ON	<ul style="list-style-type: none"> Touch the  sensor to check if the monitor is in the ON mode. Check if the power cord is properly connected to the monitor and the power outlet.
The power LED lights amber and there is no screen image	<ul style="list-style-type: none"> Check if the monitor and the computer are in the ON mode. Make sure the signal cable is properly connected the monitor and the computer. Inspect the signal cable and make sure none of the pins are bent. Connect the computer with another available monitor to check if the computer is properly working.
Screen image is too light or dark	<ul style="list-style-type: none"> Adjust the Contrast and Brightness settings via OSD.
Screen image is not centered or sized properly	<ul style="list-style-type: none"> Touch the  sensor for 2~3 seconds to automatically adjust the image. Adjust the H-Position or V-Position settings via OSD.
Screen image bounces or a wave pattern is present in the image	<ul style="list-style-type: none"> Make sure the signal cable is properly connected to the monitor and the computer. Move electrical devices that may cause electrical interference.
Screen image has color defects (white does not look white)	<ul style="list-style-type: none"> Inspect the signal cable and make sure that none of the pins are bent. Perform Reset via OSD. Adjust the R/G/B color settings or select the Color Temperature via OSD.
Screen image is blurry or fuzzy	<ul style="list-style-type: none"> Touch the  sensor for two seconds to automatically adjust the image (for VGA mode only). Adjust the Phase and Clock settings via OSD.
No sound or sound is low	<ul style="list-style-type: none"> Ensure that the audio cable is properly connected to the monitor and the computer Adjust the volume settings of both your monitor and computer. Ensure that the computer sound card driver is properly installed and activated.
Webcam is not working	<ul style="list-style-type: none"> Ensure that you install the webcam driver which is in the support CD. Make sure that you connect the USB plugs of the supplied 4-in-1 cable to both the LCD monitor and your computer.
USB devices work abnormally	<ul style="list-style-type: none"> Make sure that you connect the USB plugs of the supplied 4-in-1 cable to both the LCD monitor and your computer. Check with your PC manufacturer whether your PC supports USB2.0 or USB1.1. If your PC only supports USB1.1, the image transmission is much slower.
ASUS Power Bass System is not working	<ul style="list-style-type: none"> Make sure that the woofer cable is securely connected to the monitor.

4.3 PG221 specification summary

Panel size	22" Widescreen panel
Panel type	TFT LCD (anti-reflection glare type)
Max. resolution	WSXGA+ 1680 x 1050
Pixel pitch	0.282 mm
Brightness	300 cd/m ² (typ.)/ 350 cd/m ² (max.)
Contrast ratio (typ.)	1000:1 (ASCR OFF) / 2000:1 (ASCR ON)
Viewing angle(H/V)	170°/160°
Display colors	16.7 M
Response time	2 ms (GTG)
SPLENDID™ Video Intelligence Technology	Yes
SPLENDID™ selection	5 video preset modes (by hotkey)
Auto image adjustment	Yes (by hotkey)
Color temperature selection	5 color temperatures
Skin-tone selection	3 skin-tones
PC digital input	DVI-D with HDCP
PC analog input	VGA (D-Sub)
Video inputs	Composite (video) x1, S-Video x1, YPbPr (Component, up to1080i/p) x1
AV Audio inputs	RCA (R/L) x2
USB 2.0 ports	Upstream x1, Downstream x3
Line-in port	3.5 mm Mini-jack
Headphone port	3.5 mm Mini-jack
Colors	Black + Silver
Speaker (Built-in)	5W x 2 Stereo + 15W Power Bass System
Power LED	Blue (On)/ Amber (Standby)
Swivel	+60°~-60°
Tilt	+20°~-5°
Kensington lock	Yes
Voltage rating	AC: 100~240V, 50~60Hz
Power consumption	Power On : < 100W, Standby: < 2W
Dimension (W x H x D)	527 mm x 445 mm x 244 mm
Net weight	10.7 kg (approx.)
Accessories	VGA-Audio-Microphone-USB 4-in-1 cable, DVI cable, RCA cable, power cord, rear connector cover, quick start guide, support CD (LifeFrame bundled), warranty card
Regulation approvals	Energy Star®, CB, CE, Gost-R, CCC, UL/cUL, FCC, PSB, C-Tick, BSMI, VCCI, RoHS, MIC, Microsoft® Windows® Vista compliance

* Specifications are subject to change without notice.

4.4 Supported operating modes

Standard	Resolution Frequency	Vertical Frequency	Horizontal Frequency	Pixel
DOS	720 x 400	70Hz	31.47KHz	28.32MHz
VGA	640 x 480	60Hz	31.47KHz	25.18MHz
	640 x 480	72Hz	37.90KHz	31.50MHz
	640 x 480	75Hz	37.50KHz	31.50MHz
SVGA	800 x 600	56Hz	35.16KHz	36.00MHz
	800 x 600	60Hz	37.90KHz	40.00MHz
	800 x 600	72Hz	48.10KHz	50.00MHz
	800 x 600	75Hz	46.90KHz	49.50MHz
WVGA	848 x 480	60Hz	31.02KHz	33.75MHz
XGA	1024 x 768	60Hz	48.40KHz	65.00MHz
	1024 x 768	70Hz	56.50KHz	75.00MHz
	1024 x 768	75Hz	60.02KHz	78.75MHz
XGA+	1152 x 864	75Hz	67.50KHz	108.00MHz
WXGA	1280 x 768	60Hz	47.78KHz	79.50MHz
	1280 x 768	75Hz	60.29KHz	102.25MHz
QVGA	1280 x 960	60Hz	60.00KHz	108.00MHz
SXGA	1280 x 1024	60Hz	64.00KHz	108.00MHz
	1280 x 1024	75Hz	80.00KHz	135.00MHz
WXGA	1360 x 768	60Hz	47.71KHz	85.50MHz
WXGA+	1440 x 900	60Hz	55.94KHz	106.00MHz
	1440 x 900	75Hz	70.64KHz	136.75MHz
WSXGA+ (Primary)	1680 x 1050	60Hz	65.29KHz	146.25MHz

* Modes not listed in the table may not be supported. For optimal resolution, we recommend that you choose a mode listed in the table above.

Free Manuals Download Website

<http://myh66.com>

<http://usermanuals.us>

<http://www.somanuals.com>

<http://www.4manuals.cc>

<http://www.manual-lib.com>

<http://www.404manual.com>

<http://www.luxmanual.com>

<http://aubethermostatmanual.com>

Golf course search by state

<http://golfingnear.com>

Email search by domain

<http://emailbydomain.com>

Auto manuals search

<http://auto.somanuals.com>

TV manuals search

<http://tv.somanuals.com>