

**ASUS<sup>®</sup> DiGiMatrix**

**Digital Entertainment PC  
(AB-V100)**

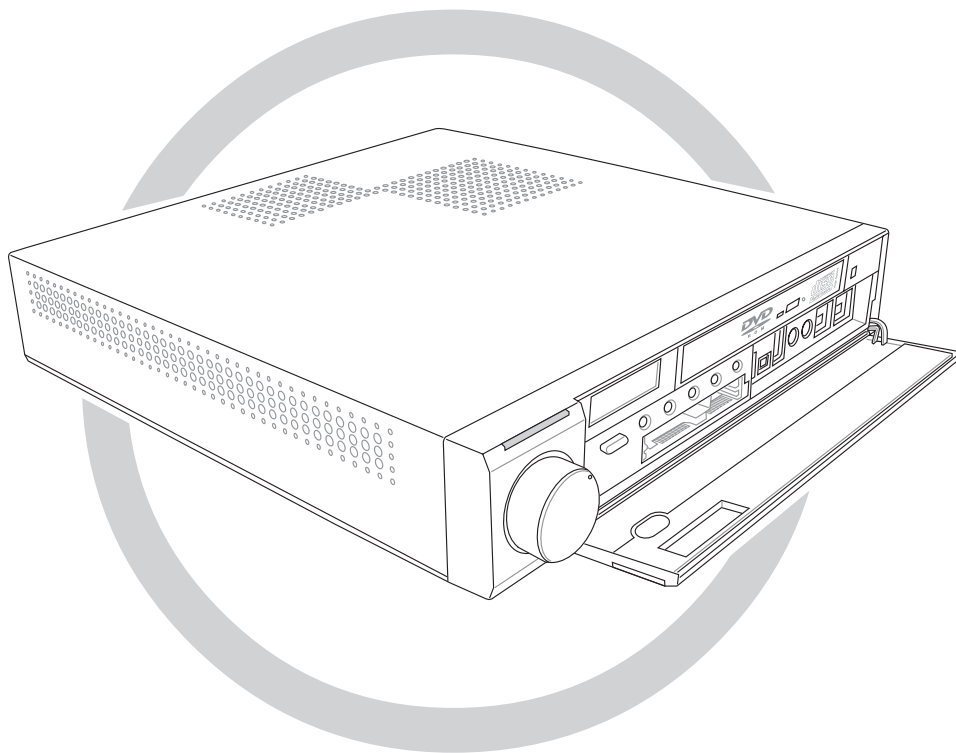

**User Handbook**

**E1468**

**Revised Edition V2**

**November 2003**

**Copyright © 2003 ASUSTeK COMPUTER INC. All Rights Reserved.**

No part of this manual, including the products and software described in it, may be reproduced, transmitted, transcribed, stored in a retrieval system, or translated into any language in any form or by any means, except documentation kept by the purchaser for backup purposes, without the express written permission of ASUSTeK COMPUTER INC. ("ASUS").

Product warranty or service will not be extended if: (1) the product is repaired, modified or altered, unless such repair, modification or alteration is authorized in writing by ASUS; or (2) the serial number of the product is defaced or missing.

ASUS PROVIDES THIS MANUAL "AS IS" WITHOUT WARRANTY OF ANY KIND, EITHER EXPRESS OR IMPLIED, INCLUDING BUT NOT LIMITED TO THE IMPLIED WARRANTIES OR CONDITIONS OF MERCHANTABILITY OR FITNESS FOR A PARTICULAR PURPOSE. IN NO EVENT SHALL ASUS, ITS DIRECTORS, OFFICERS, EMPLOYEES OR AGENTS BE LIABLE FOR ANY INDIRECT, SPECIAL, INCIDENTAL, OR CONSEQUENTIAL DAMAGES (INCLUDING DAMAGES FOR LOSS OF PROFITS, LOSS OF BUSINESS, LOSS OF USE OR DATA, INTERRUPTION OF BUSINESS AND THE LIKE), EVEN IF ASUS HAS BEEN ADVISED OF THE POSSIBILITY OF SUCH DAMAGES ARISING FROM ANY DEFECT OR ERROR IN THIS MANUAL OR PRODUCT.

SPECIFICATIONS AND INFORMATION CONTAINED IN THIS MANUAL ARE FURNISHED FOR INFORMATIONAL USE ONLY, AND ARE SUBJECT TO CHANGE AT ANY TIME WITHOUT NOTICE, AND SHOULD NOT BE CONSTRUED AS A COMMITMENT BY ASUS. ASUS ASSUMES NO RESPONSIBILITY OR LIABILITY FOR ANY ERRORS OR INACCURACIES THAT MAY APPEAR IN THIS MANUAL, INCLUDING THE PRODUCTS AND SOFTWARE DESCRIBED IN IT.

Products and corporate names appearing in this manual may or may not be registered trademarks or copyrights of their respective companies, and are used only for identification or explanation and to the owners' benefit, without intent to infringe.

# Table of contents

Table of contents .....	3
Notices .....	6
Safety information .....	7
About this handbook .....	8
System package contents .....	10
<b>Chapter 1: System Introduction</b>	
1.1 Welcome! .....	12
1.2 Front panel (external) .....	12
1.3 Front panel (internal) .....	14
1.4 Rear panel .....	16
1.5 LED panel.....	18
<b>Chapter 2: Connections</b>	
2.1 Preparation .....	20
2.2 Connecting cables .....	20
2.2.1 Power adapter and cable .....	20
2.2.2 Radio antenna .....	21
2.2.3 Audio/Video cable .....	21
2.2.4 Video out cable .....	21
2.2.5 HDTV cable .....	22
2.2.6 Audio out cable .....	22
2.3 Connecting external devices .....	23
<b>Chapter 3: Using DiGiMatrix</b>	
3.1 Installing an operating system .....	26
3.2 Powering up .....	26
3.3 Optical drive operation .....	26
3.3.1 Loading a disc .....	26
3.3.2 Ejecting a disc from the drive .....	28
3.3.3 Using the emergency eject pinhole .....	28
3.4 Using the 4-slot storage card reader .....	29

# Table of contents

## Chapter 4: Software support

4.1	Support CD information .....	32
4.1.1	Running the support CD .....	32
4.1.2	Drivers menu .....	33
4.1.3	Utilities menu .....	34
4.1.4	ASUS contact information .....	35
4.1.5	Other information .....	35
4.2	Software information .....	36
4.2.1	ASUS Update .....	36
4.2.2	ASUS PC Probe .....	38
4.2.3	Multi-channel audio feature .....	42
4.2.4	Music Wizard .....	45
4.3	Audio DJ .....	48
4.3.1	Selecting an audio source .....	49
4.3.2	Playing MP3 files from the hard disk drive .....	49
4.3.3	Playing an audio CD/DVD .....	49
4.3.4	Tuning into an FM radio station .....	50
4.3.5	Presetting a station .....	51
4.3.6	Adjusting the volume .....	51
4.4	ASUS Home Theater .....	51
4.4.1	Installing ASUS Home Theater .....	51
4.4.2	Using ASUS Home Theater .....	53
4.4.3	Entertainment modes .....	55
4.5	ASUS Wireless LAN adapter .....	64
4.5.1	Installing the WLAN Card utilities and driver .....	65
4.5.2	Setting the Windows® XP wireless options .....	65
4.5.3	Other support CD options .....	65
4.5.4	Setup Wizard .....	66
4.5.5	The Control Center utility .....	79
4.5.6	Configuring the wireless LAN adapter by Wireless Settings utility .....	89

# Table of contents

## Appendix

A.1	Subsystem .....	2
A.1.1	Front and rear panel features .....	2
A.1.2	Removing the top cover .....	3
A.1.3	Installing a hard disk drive .....	3
A.1.4	Connecting the Subsystem to DiGiMatrix .....	4
A.2	DiGiMatrix remote controller .....	5
A.2.1	Specifications .....	5
A.2.2	Remote control layout .....	5
A.2.3	Remote control functions in Audio DJ .....	6
A.2.4	Remote control functions in Home Theater .....	7
A.3	Optical drive technical specifications .....	9
A.4	Wireless LAN adapter channels .....	10

# Notices

## Federal Communications Commission Statement

This device complies with FCC Rules Part 15. Operation is subject to the following two conditions:

- This device may not cause harmful interference, and
- This device must accept any interference received including interference that may cause undesired operation.

This equipment has been tested and found to comply with the limits for a Class B digital device, pursuant to Part 15 of the FCC Rules. These limits are designed to provide reasonable protection against harmful interference in a residential installation. This equipment generates, uses and can radiate radio frequency energy and, if not installed and used in accordance with manufacturer's instructions, may cause harmful interference to radio communications. However, there is no guarantee that interference will not occur in a particular installation. If this equipment does cause harmful interference to radio or television reception, which can be determined by turning the equipment off and on, the user is encouraged to try to correct the interference by one or more of the following measures:

- Reorient or relocate the receiving antenna.
- Increase the separation between the equipment and receiver.
- Connect the equipment to an outlet on a circuit different from that to which the receiver is connected.
- Consult the dealer or an experienced radio/TV technician for help.



---

### **WARNING!**

The use of shielded cables for connection of the monitor to the graphics card is required to assure compliance with FCC regulations. Changes or modifications to this unit not expressly approved by the party responsible for compliance could void the user's authority to operate this equipment.

---

## Canadian Department of Communications Statement

This digital apparatus does not exceed the Class B limits for radio noise emissions from digital apparatus set out in the Radio Interference Regulations of the Canadian Department of Communications.

**This class B digital apparatus complies with Canadian ICES-003.**

# Safety information

## Electrical safety

- To prevent electrical shock hazard, disconnect the power cable from the electrical outlet before relocating the system.
- When adding or removing devices to or from the system, ensure that the power cables for the devices are unplugged before the signal cables are connected.
- If the power supply is broken, do not try to fix it by yourself. Contact a qualified service technician or your retailer.

## Operation safety

- Before installing devices into the system, carefully read all the documentation that came with the package.
- Before using the product, make sure all cables are correctly connected and the power cables are not damaged. If you detect any damage, contact your dealer immediately.
- To avoid short circuits, keep paper clips, screws, and staples away from connectors, slots, sockets and circuitry.
- Avoid dust, humidity, and temperature extremes. Do not place the product in any area where it may become wet. Place the product on a stable surface.
- If you encounter technical problems with the product, contact a qualified service technician or your retailer.

### Lithium-Ion Battery Warning

**CAUTION:** Danger of explosion if battery is incorrectly replaced. Replace only with the same or equivalent type recommended by the manufacturer. Dispose of used batteries according to the manufacturer's instructions.

**VORSICHT:** Explosionsgefahr bei unsachgemäßen Austausch der Batterie. Ersatz nur durch denselben oder einem vom Hersteller empfohlenem ähnlichen Typ. Entsorgung gebrauchter Batterien nach Angaben des Herstellers.

### LASER PRODUCT WARNING

**CLASS 1 LASER PRODUCT**

# About this handbook

## Audience

This handbook provides general information about the ASUS DiGiMatrix system and is intended for users with general knowledge of personal computers.

## How this handbook is organized

This handbook contains the following parts:

### 1. **Chapter 1: System Introduction**

This chapter gives a general description of the ASUS DiGiMatrix. The chapter lists the system features including introduction on the front and rear panel, and internal components.

### 2. **Chapter 2: Connections**

This chapter provides step-by-step instructions on how to connect devices and accessories to the DiGiMatrix system.

### 3. **Chapter 3: Using DiGiMatrix**

This chapter provides information on powering up the DiGiMatrix system and using the optical drive and storage card reader.

### 4. **Chapter 4: Software support**

This chapter helps you install the drivers and utilities from the support CD.

### 5. **Appendix**

The Appendix provides information on the DiGiMatrix Subsystem, remote controller, optical drive technical specifications, and IEEE 802.11b channels for the wireless LAN adapter.



## Conventions used in this handbook



**WARNING:** Information to prevent injury to yourself when trying to complete a task.



**CAUTION:** Information to prevent damage to the components when trying to complete a task.



**IMPORTANT:** Information that you **MUST** follow to complete a task.



**NOTE:** Tips and additional information to aid in completing a task.

## Where to find more information

Refer to the following sources for additional information and for product and software updates.

### 1. **ASUS Websites**

The ASUS websites worldwide provide updated information on ASUS hardware and software products. Refer to the ASUS contact information.

### 2. **Optional Documentation**

Your product package may include optional documentation, such as warranty flyers, that may have been added by your dealer. These documents are not part of the standard package.

# System package contents

Check your ASUS DiGiMatrix package for the following items.

1. ASUS DiGiMatrix Digital Entertainment System with:
  - ASUS P4SQ motherboard
  - Intel® Pentium® 4 (2.4GHz) or Celeron (2.0GHz) processor
  - 80GB or 160 GB 7200RPM IDE hard disk drive
  - 256MB PC2700 DDR DIMM
  - DVD-ROM/CD-RW Combo or DVD-ROM drive
  - 7-in-1 storage card reader
2. Cables
  - Universal power adapter and cable (100V-240V)
  - HDTV cable
  - Audio/video cable
  - Video out cable
  - Audio out cable
3. Accessories
  - Radio antenna
  - Remote controller
4. DiGiMatrix support CD
5. User Handbook



---

If any of the above items is damaged or missing, contact your retailer immediately.

---



---

Component specifications are subject to change without notice.

---

# Chapter 1

## System introduction

- ▶ This chapter gives a general description of the ASUS DiGiMatrix. The chapter lists the system features including introduction on the front and rear panel, and internal components.

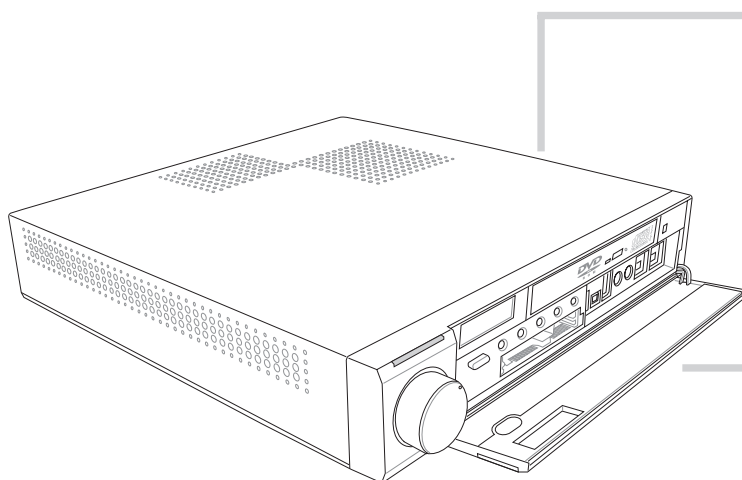

digital **entertainment PC**

# 1.1 Welcome!

Thank you for choosing the **ASUS DiGiMatrix!**

The ASUS DiGiMatrix is a smart personal computer and a versatile home entertainment system in one. Powered by the ASUS P4SQ motherboard, DiGiMatrix delivers the cutting edge technology for your computing and multimedia entertainment needs. DiGiMatrix comes with an Intel® Pentium® 4 (2.4GHz)/Celeron (2.0GHz) processor, 256MB PC2700 system memory and 80GB/160GB IDE hard disk drive to give you a dependable PC platform. The DiGiMatrix also comes with a slim optical drive, 4-slot storage card reader, and 6-channel digital audio in a compact and stylish casing.

Providing the best connectivity for external devices and peripherals are eight (8) USB 2.0 ports, fast Ethernet and Gigabit LAN ports, IEEE 1394 port, and S/PDIF interface. The DiGiMatrix includes a TV/FM tuner and an IEEE 802.11b-compliant wireless network adapter to support your wireless networking needs.

The DiGiMatrix features the most silent multimedia system to give you pure acoustic enjoyment. With the ASUS DiGiMatrix, you don't need anything else!

## 1.2 Front panel (external)

The DiGiMatrix front panel includes the system and audio control buttons, system LEDs and LED panel.

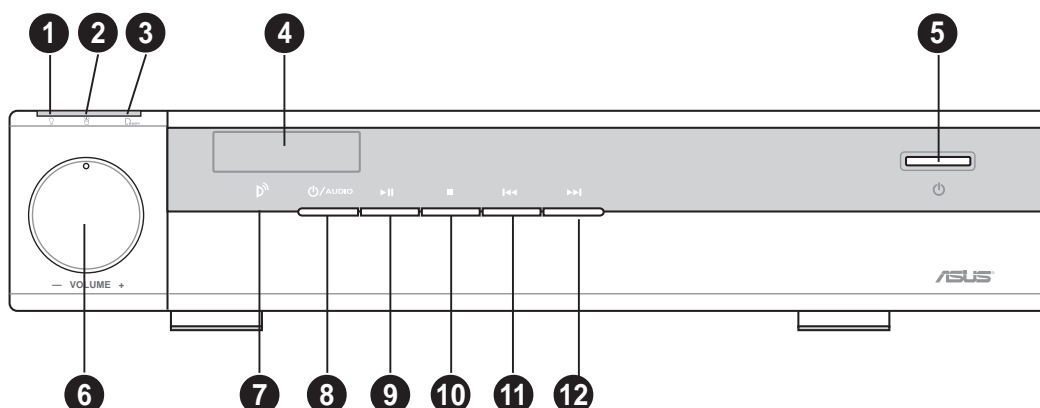

1. **Power LED.** When lit, this LED indicates that the system is ON.
2. **HDD LED.** This LED lights up when data is being read from or written to the hard disk drive.

3. **Card LED.** This LED lights up when data is being read from or written to a storage card inserted in any of the card reader slots.
4. **LED panel.** The LED panel displays the audio medium (HD/CD/FM), radio frequency, player status (▶/||), real time clock, track number and time, and CPU temperature. See page 18 for details.
5. **System power button.** Press this button to turn the system on and enter the DiGiMatrix operating system.
6. **System volume dial.** Turn this dial clockwise to increase the system volume or counterclockwise to decrease the system volume. In Audio DJ mode, press the system volume dial to mute sound.
7. **Remote sensor.** This sensor receives signals from the DiGiMatrix remote controller. See page A-5 for details on the remote controller.
8. **Audio DJ power button.** Press this button to turn on the DiGiMatrix Audio DJ. The Audio DJ feature allows you to play CD/DVD audio tracks and MP3 files on your hard disk drive, or tune into an FM radio station without entering the DiGiMatrix operating system. See page 48 for details.



---

The following front panel buttons are activated only when DiGiMatrix is in **Audio DJ mode**.

---

9. **PLAY/PAUSE button.** Press this button to perform various functions in different modes.  
  
In **CD mode**, plays the first track of the audio CD/DVD in the optical drive. When playing an audio track, pauses the track being played.  
In **Hard Disk (HD) mode**, plays the first MP3 file of a selected playlist. When playing an audio track/file, pauses the track/file being played.  
In **Radio mode**, scans the available FM stations.
10. **STOP button.** Press this button to perform various functions in different modes.  
  
In **CD/HD mode**, (pressed once) stops the audio track/file being played, or (pressed twice) sets the Audio DJ in **Playlist mode**.  
In **Radio mode**, sets the Audio DJ in **Playlist mode**.

**11. PREVIOUS button.** Press this button to perform various functions in different modes.

In **CD/HD mode**, selects the previous audio track/file.

In **Radio mode**, selects the previous preset station.

In **Playlist mode**, selects the previous available audio source.

**12. NEXT button.** Press this button to perform various functions in different modes.

In **CD/HD mode**, selects the next audio track/file.

In **Radio mode**, selects the next preset station.

In **Playlist mode**, selects the next available audio source.

## 1.3 Front panel (internal)

The optical drive, storage card slots, and several I/O ports are located inside the front panel door.

Flip down the front panel door to open. Refer to the illustration on the right.



You can not close the front panel door if a flash memory card is inserted into any of the card slots.

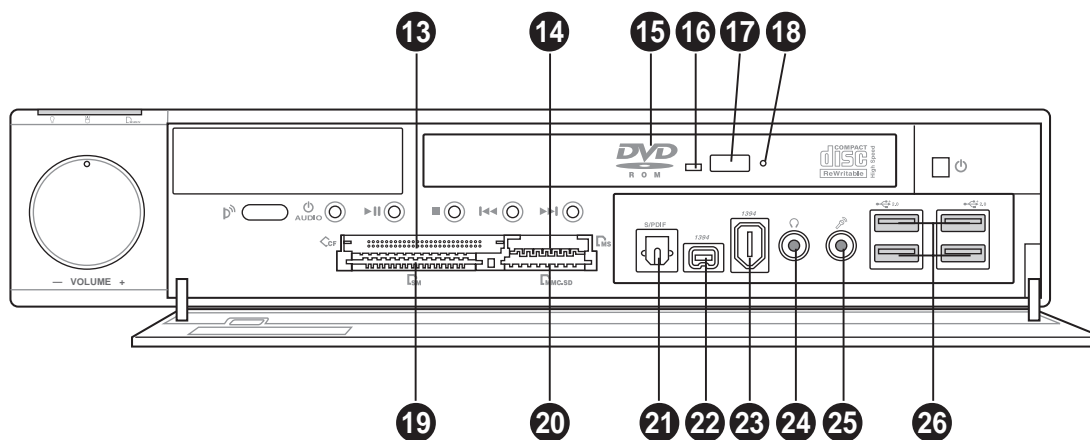
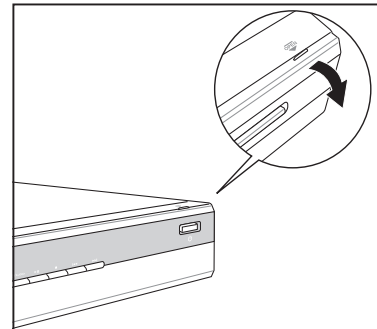

FRONT PANEL (OPEN)

13. **CompactFlash®/Microdrive™ card slot.** This slot is for a CompactFlash®/Microdrive™ storage card.
14. **Memory Stick®/Memory Stick Pro™ card slot.** This slot is for a Memory Stick®/Memory Stick Pro™ storage card.
15. **DVD-ROM/CD-RW Combo or DVD-ROM drive.** This is a slim DVD-ROM/CD-RW Combo or DVD-ROM drive.
16. **Drive activity LED.** This LED lights up when you place a disc on the drive tray, and turns off when you remove the disc. The LED flashes when data is being read from or written to the disc.
17. **STOP/EJECT button.** Press this button to eject the disc loading tray.
18. **Emergency eject pinhole.** The emergency eject pinhole allows you to manually eject a disc when the STOP button does not work due to power failure or software problems. Insert the emergency eject pin or a paper clip into this hole to manually eject the tray and the disc.
19. **SmartMedia® card slot.** This slot is for a SmartMedia® storage card.
20. **Secure Digital™/MultimediaCard slot.** This slot is for a Secure Digital™/MultimediaCard storage card.
21. **Optical S/PDIF port.** This port connects your audio system for 5.1-channel surround sound and enhanced 3D audio.
22. **4-pin IEEE 1394 port.** This port provides high-speed connectivity for IEEE 1394-compliant audio/video devices, storage peripherals, and other PC devices.
23. **6-pin IEEE 1394 port.** This port provides high-speed connectivity for IEEE 1394-compliant audio/video devices, storage peripherals, and other PC devices.
24. **Headphone port.** This port connects a headphone with a stereo mini-plug.
25. **Microphone port.** This Mic (pink) port connects a microphone.
26. **USB 2.0 ports.** These Universal Serial Bus 2.0 (USB 2.0) ports are available for connecting USB 2.0 devices such as a mouse, printer, scanner, camera, PDA, and others.

## 1.4 Rear panel

The DiGiMatrix rear panel includes the power socket and several I/O ports that allow convenient connection of devices.

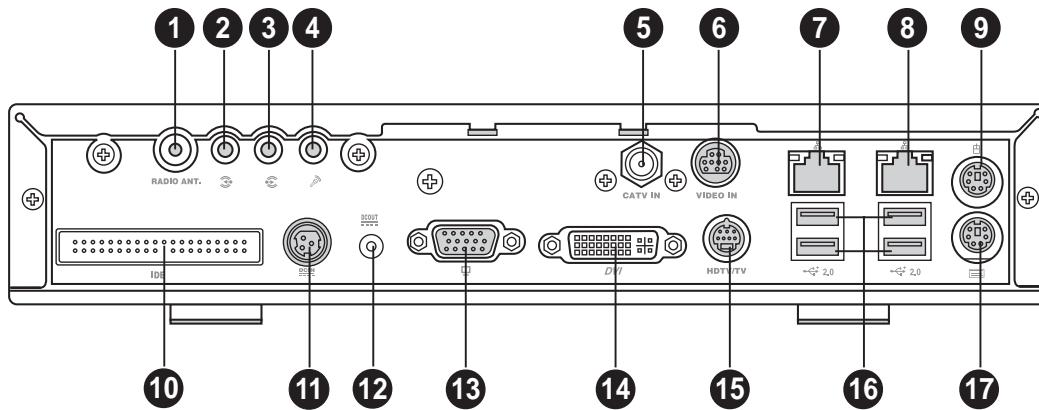

1. **Radio antenna port.** This port connects the FM antenna.
2. **Line In port.** This Line In (light blue) port connects a tape player or other audio sources. In 6-channel mode, the function of this port becomes Low Frequency Enhanced Output/Center.
3. **Line Out port.** This Line Out (lime) port connects a headphone or a speaker. In 4/6-channel mode, the function of this port becomes Front Speaker Out.
4. **Microphone port.** This Microphone (pink) port connects a microphone. In 4/6-channel mode, the function of this port becomes Surround Speaker.
5. **Cable TV connector.** This connects a cable TV twist-on connector.
6. **Video In port.** This port connects a television or a video cassette recorder.
7. **Ethernet LAN port.** This port allows connection to a Local Area Network (LAN) through a network hub.
8. **Gigabit LAN port.** This port allows high speed connection to the Internet via a DSL or cable modem.
9. **PS/2 mouse port.** This green 6-pin connector is for a PS/2 mouse.
10. **Secondary IDE connector.** This interface connects the optional DiGiMatrix subsystem. See page A-2.
11. **DC IN socket.** This socket connects the power adapter and plug.



12. **DC OUT socket.** This socket connects the DC power cable that supplies power to the optional DiGiMatrix Subsystem. See page A-4 for details.
13. **VGA port.** This port connects a VGA monitor.
14. **DVI port.** This port connects a DVI-enabled flat screen or LCD monitor using a DVI cable.
15. **HDTV/TV port.** This port connects a high-definition television (HDTV) or a regular TV set using the supplied HDTV, audio/video, or video out cable.
16. **USB 2.0 ports.** These Universal Serial Bus 2.0 (USB 2.0) ports are available for connecting USB 2.0 devices such as a mouse, printer, scanner, camera, PDA, and others.
17. **PS/2 keyboard port.** This purple 6-pin connector is for a PS/2 keyboard.

## 1.5 LED panel

The DiGiMatrix LED panel displays different system information depending on the system mode.

**Time** - The LED panel displays the system time in 24-hour format when DiGiMatrix is in soft-off or stand-by mode, S3 (Suspend-to-RAM), or S4 (Suspend-to-Disk) state. Enter the BIOS setup or the DiGiMatrix operating system to adjust the time.

**CPU Temperature** - The LED panel displays the CPU temperature when DiGiMatrix is in Windows® mode.

### Audio DJ

The LED panel displays the playlist number when Audio DJ is set to HD mode. In play status, the LED panel displays the play icon, track number, and track duration.

In DVD/CD mode, the LED panel displays the audio mode. In play status, the LED panel displays the play icon, track number and track duration.

The LED panel displays the station preset number and station frequency when Audio DJ is in radio mode.

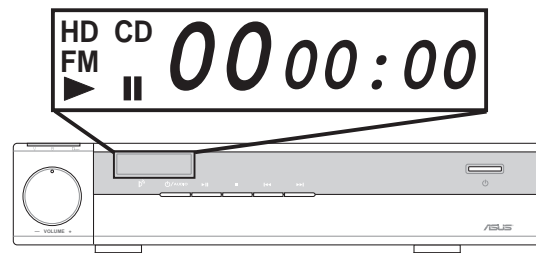

HD mode, standby/stopped status



HD mode, play/paused status

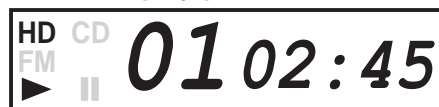

DVD/CD mode, standby/stopped status



DVD/CD mode, play/paused status

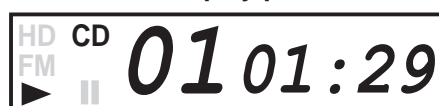

FM radio mode

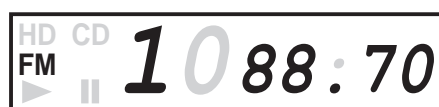

Refer to page 50 on how to preset a radio station.

## Chapter 2 Connections

- ▶ This chapter provides step-by-step instructions on how to connect devices and accessories to the DiGiMatrix system.

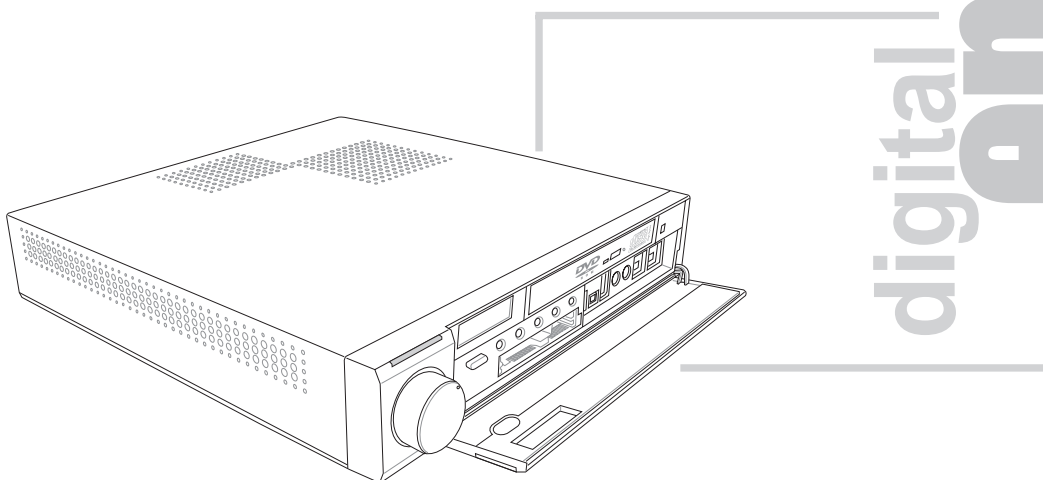

## 2.1 Preparation

Before you proceed, make sure that you have all the devices that you plan to connect to the DiGiMatrix system.

## 2.2 Connecting cables

The DiGiMatrix package includes a universal power adapter (100V - 240V) and various other cables to connect devices such as television, video recorder, and audio system. The following sections describe how to connect these cables.

### 2.2.1 Power adapter and cable

The power adapter and cable lets you to use your DiGiMatrix anywhere you are regardless of the power voltage in your area.

To connect the power adapter and power cable:

1. Connect the power cable (female plug) to the power adapter.
2. Connect the other end of the power cable (male plug) to a power outlet.
3. Check the power adapter LED. The LED lights up to indicate that the power from the source is within the operating range.
4. Connect the DC IN power plug to the DiGiMatrix DC IN socket.

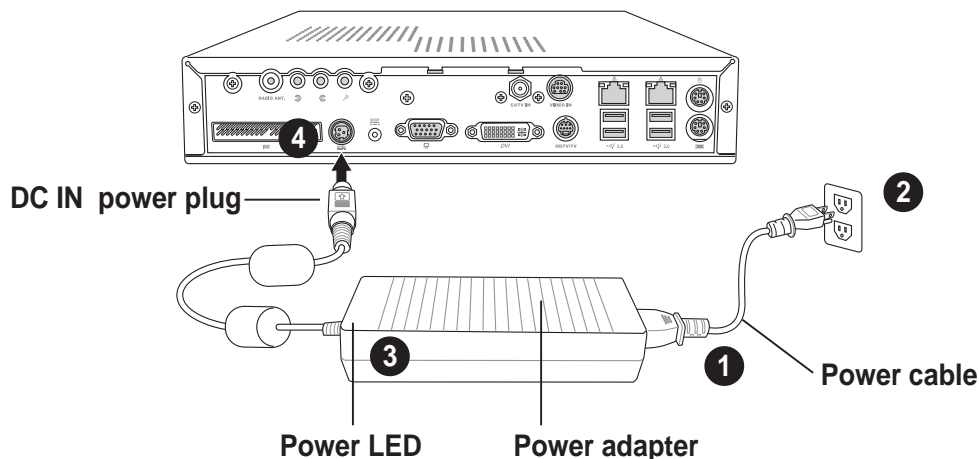

Use an outlet adapter if the power plug does not fit the power outlet in your area.

## 2.2.2 Radio antenna

Connect the radio antenna plug to the DiGiMatrix antenna port.



Place the radio antenna at an elevated location to achieve better reception.

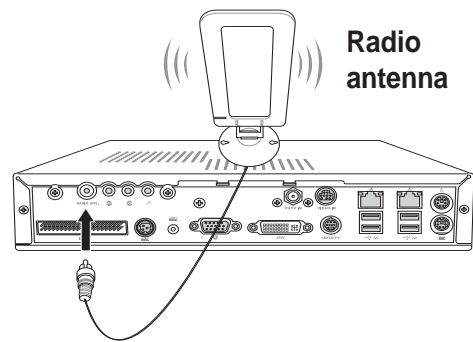

## 2.2.3 Audio/Video cable

This cable connects a video cassette recorder (VCR).

To connect the Audio/Video cable:

1. Connect the Audio/Video cable plug to the S-Video port.
2. Connect the Audio/Video cable S-Video output plug to the S-Video port of your video cassette recorder. Connect the Audio/Video audio output plugs to the audio input ports of your video cassette recorder.

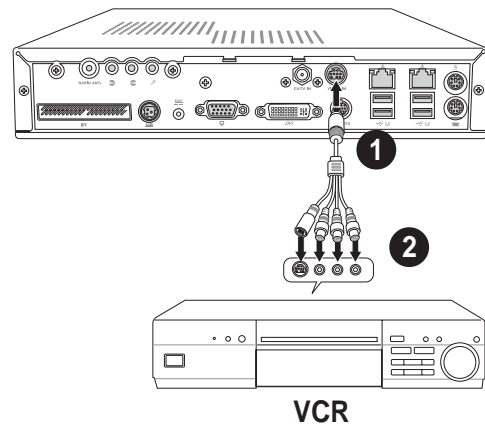

## 2.2.4 Video out cable

The video out cable connects a television set with an S-Video feature. Insert one end of the video out cable to the HDTV port. Connect the other end to the S-Video port on your TV.

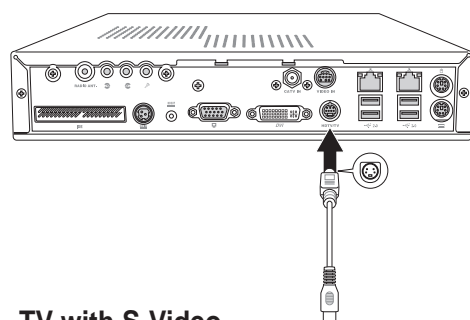

TV with S-Video

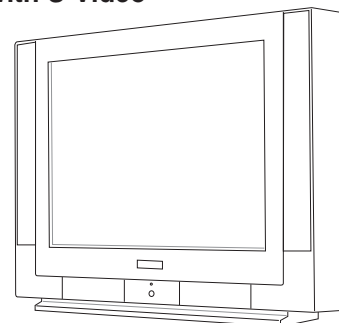

## 2.2.5 HDTV cable

This cable connects a high-definition TV (HDTV).

To connect a high-definition TV:

1. Insert the HDTV cable plug to the HDTV port.
2. Connect the HDTV cable red, green, and blue jacks to the HDTV RCA input ports.



You may also connect a regular TV set using the HDTV cable by connecting the blue jack to the video input port of the TV set. The TV set receives only video signals from the DiGiMatrix system.

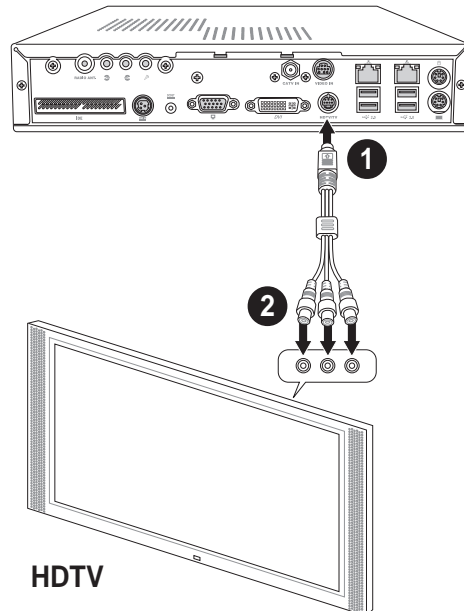

## 2.2.6 Audio out cable

The audio out cable connects a 6-channel audio system.

To connect a 6-channel audio system:

1. Insert the Line In, Line Out, and Mic plugs of the audio out cable to the audio I/O ports.
2. Insert the input/output jacks of the audio out cable to the sound system input ports. Refer to the table below for the functions of the audio I/O ports in 2, 4, and 6-channel configurations.

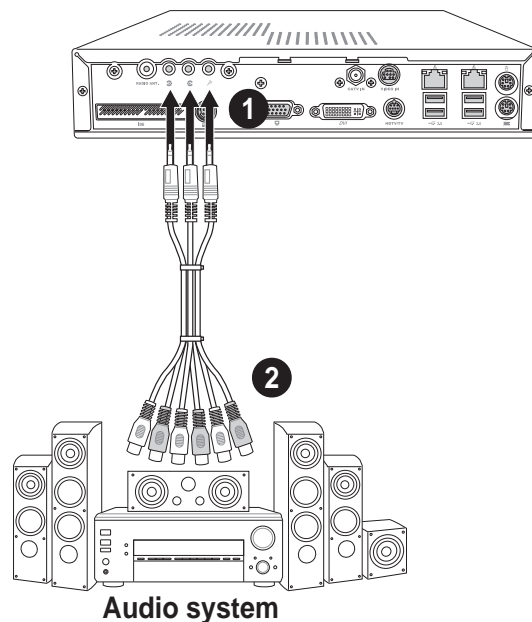

### Audio ports function variation

Audio port	Headphone/2-Channel	4-Channel	6-Channel
Light Blue	Line In	No function	LFE Output*/Center
Lime	Line Out	Front Speaker Out	Front Speaker Out
Pink	Mic In	Surround	Surround

\* Low Frequency Enhanced Output

## 2.3 Connecting external devices

### To the front panel

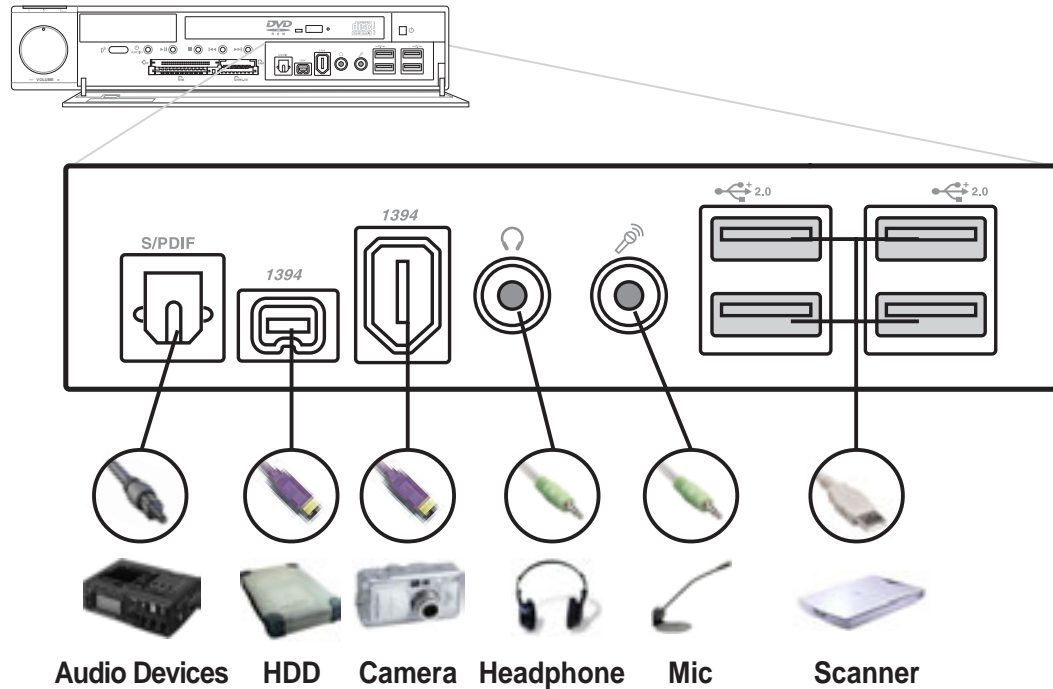

### To the rear panel

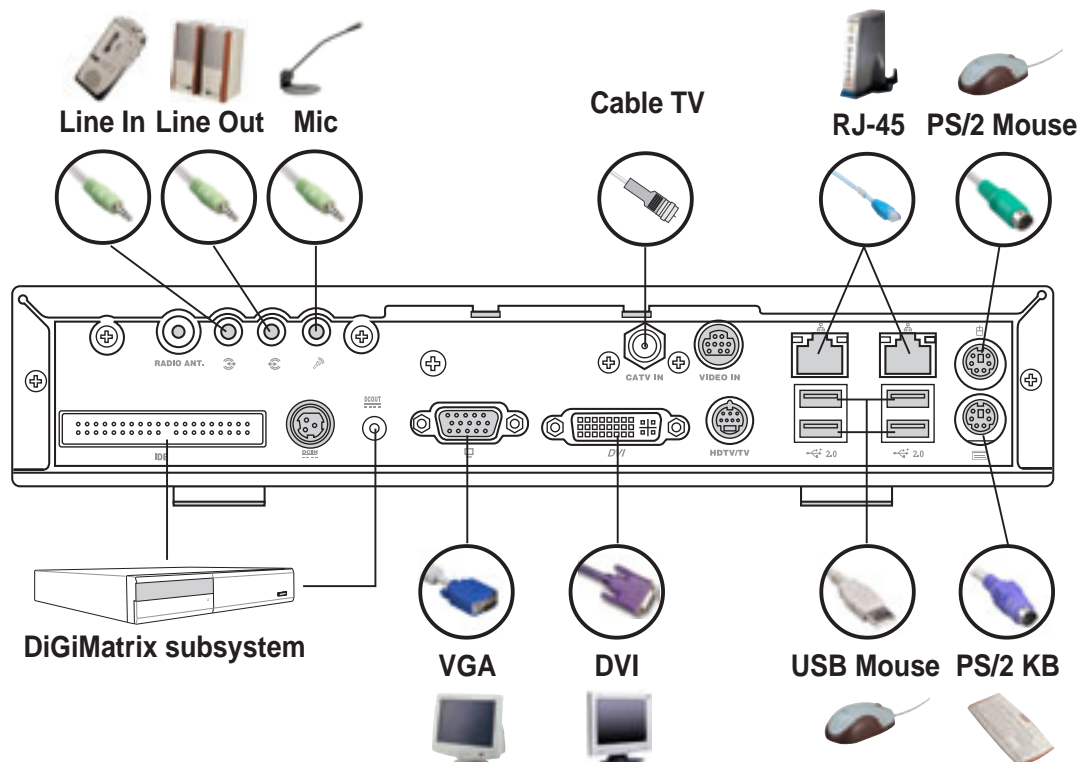





## Chapter 3

# Using DiGiMatrix

- ▶ This chapter provides information on powering up the DiGiMatrix system and using the optical drive and storage card reader.

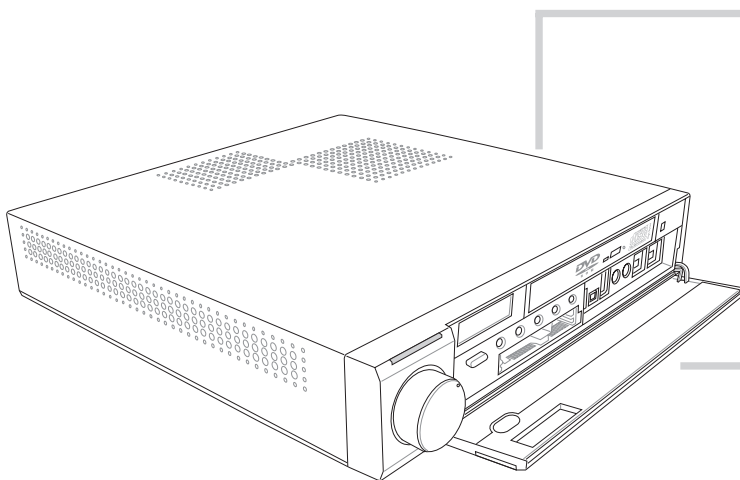

digital **entertainment PC**

## 3.1 Installing an operating system

The DiGiMatrix system supports Windows® 2000/XP operating systems (OS). Always install the latest OS version and corresponding updates so you can maximize the features of your hardware.

## 3.2 Powering up

DiGiMatrix has two power buttons located in the front panel. Press the system power button (⏻) to enter the DiGiMatrix operating system (OS). Press the Audio DJ power button (⏻/AUDIO) to turn on the DiGiMatrix Audio DJ feature.

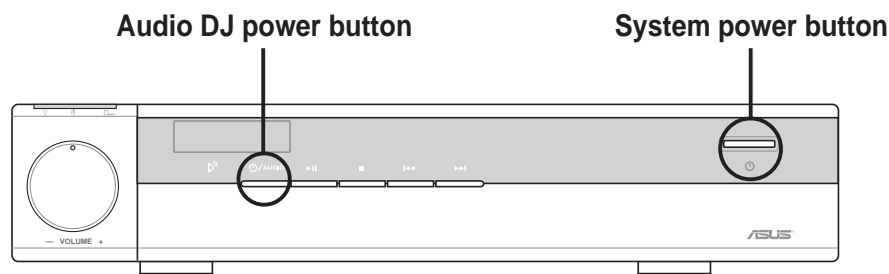

## 3.3 Optical drive operation

### 3.3.1 Loading a disc

To load a disc:

1. Press the EJECT button of the optical drive.

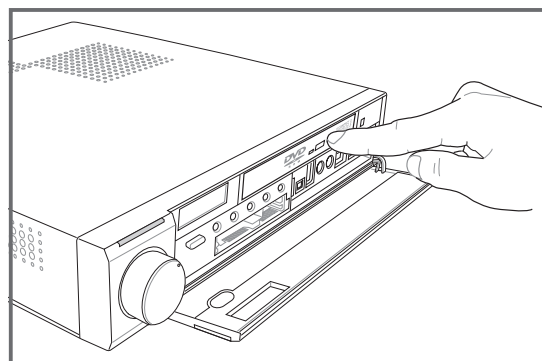

2. When the drive tray ejects, carefully pull it out.

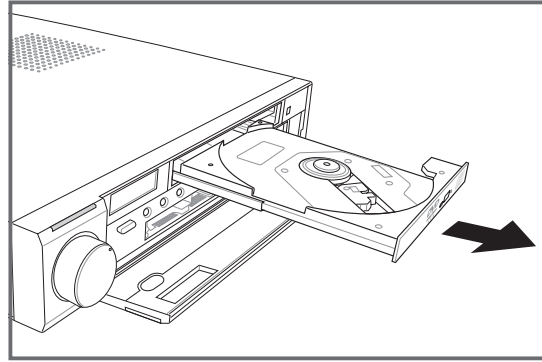

Avoid touching the optical drive lens. This may damage the drive.

3. Place a CD/DVD on the drive tray.

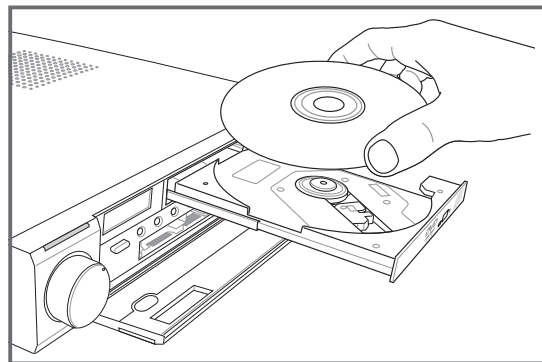

Hold a CD/DVD by the edges. Avoid touching the disc surface.

4. With one hand supporting the loading tray, push the CD/DVD hole into the drive spindle. The spindle clips snap into the hole indicating that the disc is in place.

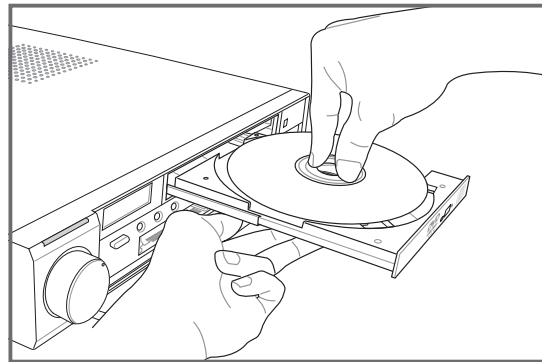

5. Push the drive tray until it clicks in place.

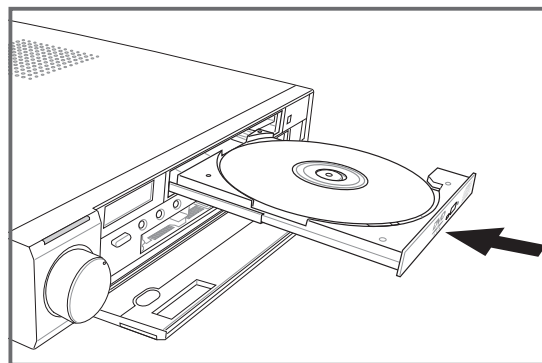

### 3.3.2 Ejecting a disc from the drive

1. Press the EJECT button on the front of the drive to eject the tray.
2. With your thumb on the drive spindle, lift one side of the disc with your fingers until it is disengaged from the drive spindle.
3. Remove the disc from the drive tray.
4. Push the drive tray until it clicks in place.

### 3.3.3 Using the emergency eject pinhole

The emergency eject pinhole on the front panel of the drive allows you to manually eject the drive tray and remove a disc from the drive in case:

- the supply of power to the computer is cut due to electrical power outage, or
- the drive malfunctions.



---

Use the manual method only when the EJECT button does not work. Turn off your computer before manually ejecting the drive tray.

---

Follow these steps to eject the drive tray using the emergency pinhole.

1. Insert a paper clip or any pointed rod small enough to fit into the emergency eject pinhole. The drive tray ejects.

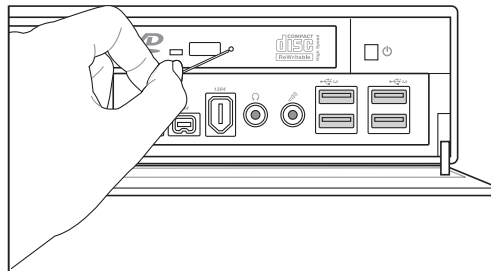

2. Carefully pull the drive tray out and remove the disc.



---

Do not force the tray open. Wait until the eject pin has dislodged the tray to avoid breaking the tray panel.

---



---

Refer to page A-9 for the optical drive technical specification.

---

## 3.4 Using the 4-slot storage card reader

The DiGiMatrix front panel comes with a 4-slot storage card reader that supports the following storage cards.

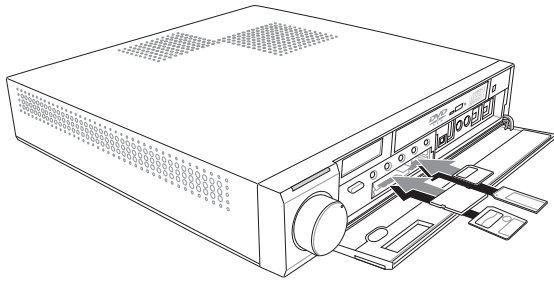

- CompactFlash®
- Microdrive™
- Secure Digital™
- MultimediaCard
- SmartMedia®
- Memory Stick®
- Memory Stick Pro™

Follow these instructions to access files from storage cards using the DiGiMatrix card reader.

1. Install the **USB Card Reader Tool** from the support CD. Refer to page 33 for details.
2. Select the appropriate slot for your storage card. Insert the storage card firmly into the slot.
3. Open **My Computer** or **Windows Explorer**. A green arrow anchored on a **Removable Disk** icon indicates that the slot is in use. An idle slot is indicated by a red square.

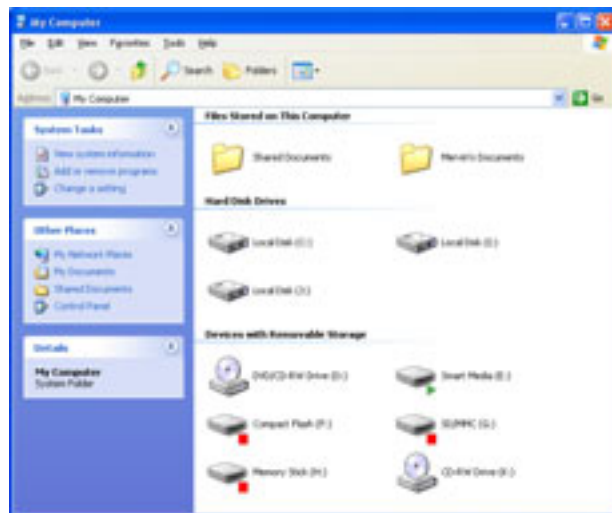

4. Double click on a **Removable Disk** icon.
5. Access files or images from your storage cards as you would open, copy, move or delete files or images from your hard disk or floppy disk.



Do not remove a memory card when the card activity LED is lit or blinking. This may result to data loss.

## Important note on the storage card reader



---

The storage card reader drivers are not included in the **Recovery CD**. If you recover your DiGiMatrix system using the Recovery CD, you must re-install the **USB Card Reader Tool** from the support CD before using the storage card reader.

---

## Chapter 4

# Software support

- ▶ This chapter helps you install the drivers and utilities from the support CD.

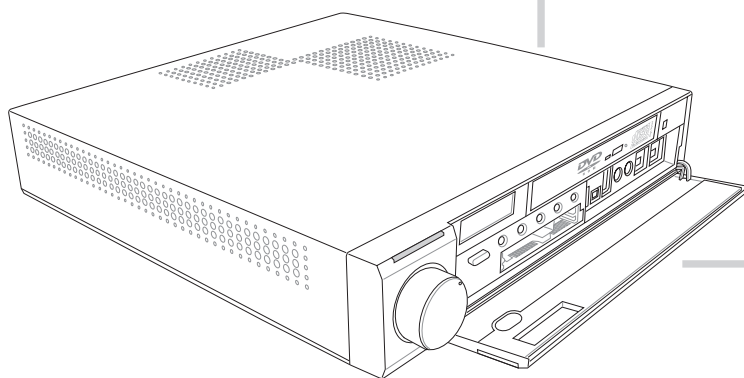

## 4.1 Support CD information

The support CD that came with the DiGiMatrix system contains useful software and several utility drivers that enhance the motherboard features.

- Screen display and driver options may not be the same for other operating system versions.
- The contents of the support CD are subject to change at any time without notice. Visit the ASUS website for updates.

### 4.1.1 Running the support CD

To begin using the support CD, place the CD in the optical drive. The CD automatically displays the **Drivers** menu if Autorun is enabled in your computer.

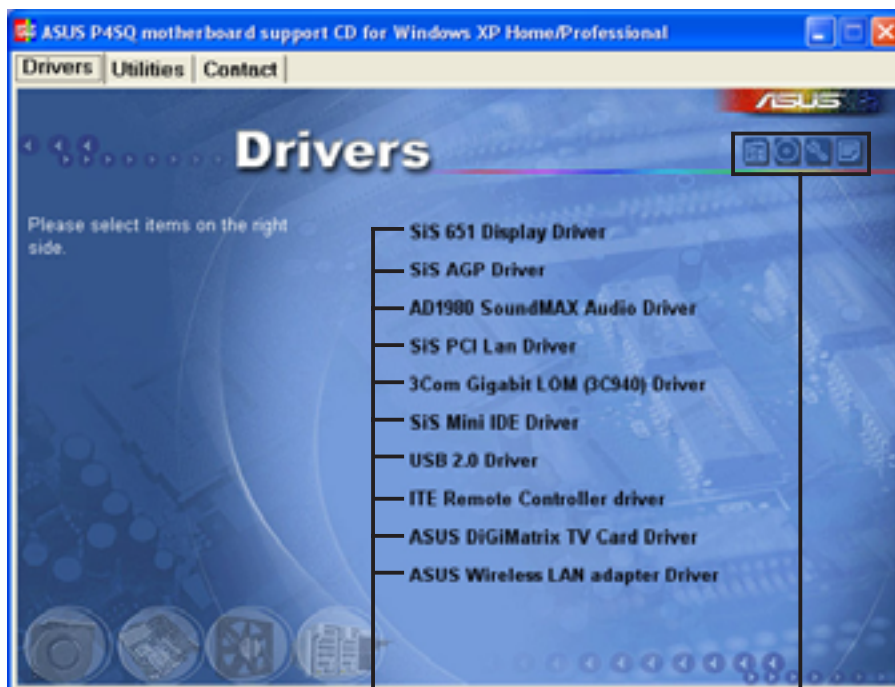

Click an item to install

Click an icon to display other information

If **Autorun** is NOT enabled in your computer, browse the contents of the support CD to locate the file **ASSETUP.EXE** from the **BIN** folder. Double-click the **ASSETUP.EXE** to run the CD.



## 4.1.2 Drivers menu

The drivers menu shows the available device drivers if the system detects installed devices. Install the necessary drivers to activate the devices.

### **SiS 651 Display Driver**

Click this item to load the installation wizard and install the SiS 651 display driver.

### **SiS AGP Driver**

Click this item to load the installation wizard and install the SiS AGP driver.

### **AD1980 SoundMAX® Audio Driver**

This item installs the AD1980 audio driver and the SoundMax® application. See page 42 for details.

### **SiS PCI LAN Driver**

This item installs the SiS PCI LAN driver.

### **3Com Gigabit LAN (3C940) Driver**

This item installs the 3Com Gigabit LAN driver.

### **SiS Mini IDE Driver**

This item installs the SiS Mini IDE driver.

### **USB 2.0 Driver**

Click this item to install the USB 2.0 driver.

### **ITE Remote Controller driver**

This item installs the driver for the DiGiMatrix remote controller.

### **ASUS DiGiMatrix TV Card Driver**

Click this item to install the driver for the DiGiMatrix TV Card.

### **ASUS Wireless LAN Adapter Driver**

This item installs the ASUS wireless LAN driver. See page 64 for details.

## 4.1.3 Utilities menu

The Utilities menu displays the applications and other softwares available for installation.

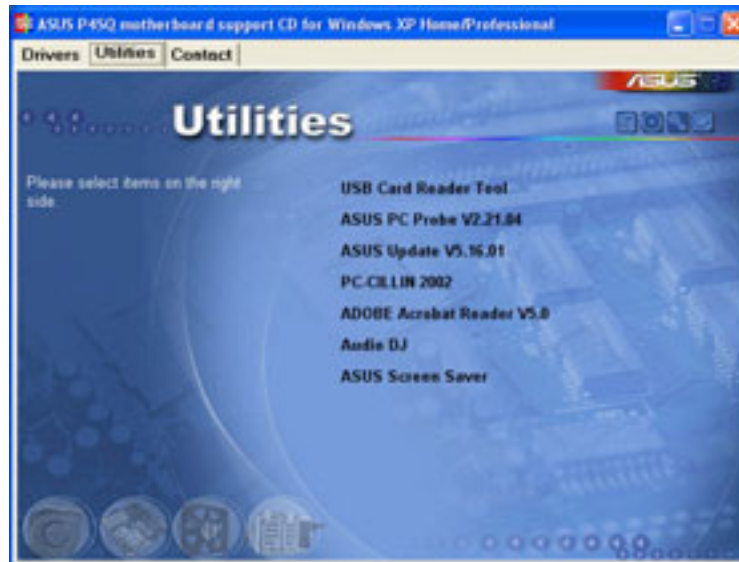

### USB Card Reader Tool

This item installs the driver for the DiGiMatrix 4-slot card reader.

### ASUS PC Probe

This utility continuously monitors vital system information such as fan rotations, CPU temperature, and system voltages, and alerts you on any detected problems. This utility helps you keep your computer in a healthy operating condition. See page 38 for details.

### ASUS Update

This item installs the ASUS Update that allows you to update the motherboard BIOS in Windows® environment. This utility requires an Internet connection either through a network or an Internet Service Provider (ISP). See page 36 for details.

### PC-CILLIN 2002

This item installs the PC-cillin 2002 anti-virus program. View the PC-cillin online help for detailed information.

### Adobe® Acrobat Reader®

This item installs the Adobe® Acrobat Reader®. The Acrobat Reader® software is for viewing files saved in Portable Document Format (PDF).

## Audio DJ

This item installs the Audio DJ feature and Music Wizard utility. The Music Wizard utility allows you to save MP3 playlists to your HDD and play them using the Audio DJ feature. See page 45 for details on Music Wizard and page 48 for details on Audio DJ.

## ASUS Screensaver

This item installs the ASUS screensaver.

### 4.1.4 ASUS contact information

Click the Contact tab to display the ASUS contact information.



### 4.1.5 Other information

The icons on the top right side of the screen give additional information on the motherboard and the contents of the support CD.



## 4.2 Software information

Most of the applications in the support CD have wizards that will conveniently guide you through the installation. View the online help or readme file that came with the software for more information.

### 4.2.1 ASUS Update

The ASUS Update is a utility that allows you to update the motherboard BIOS and drivers. This utility requires an Internet connection either through a network or an Internet Service Provider (ISP).

Follow these steps to use the ASUS Update.

1. Launch the utility from your Windows Start menu:  
**Programs/AsusUpdate Vx.xx.xx/AsusUpdate**

The ASUS Update initial screen appears.

2. Select your desired update method, then click **Next**.



3. If you selected updating/downloading from the Internet, select the ASUS FTP site nearest you to avoid network traffic, or choose Auto Select. Click Next.



- From the FTP site, select the BIOS version that you wish to download. Click **Next**.



- The BIOS ROM information is displayed. Click **Flash** to update the BIOS.



If you selected the option to update the BIOS from a file, a window pops up prompting you to locate the file. Select the file, click **Save**, then follow the screen instructions to complete the update process.

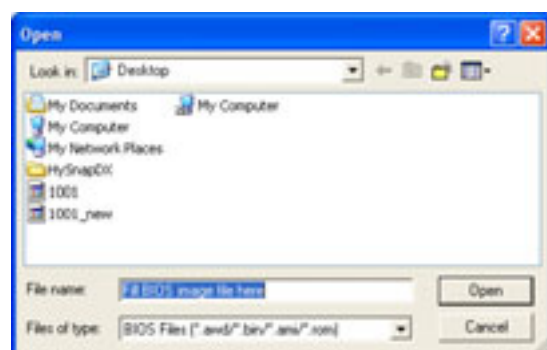

## 4.2.2 ASUS PC Probe

ASUS PC Probe is a monitoring utility that continuously keeps track of vital system information such as fan rotations, voltages, and temperatures. This utility also allows you to check other information about your computer, including hard disk space, memory usage, and CPU type, CPU speed, and internal/external frequencies through the DMI Explorer.

### Starting ASUS PC Probe

When ASUS PC Probe starts, a splash screen appears allowing you to select whether to show the screen again when you open PC Probe or not. To bypass this startup screen, clear the **Show up in next execution** check box.

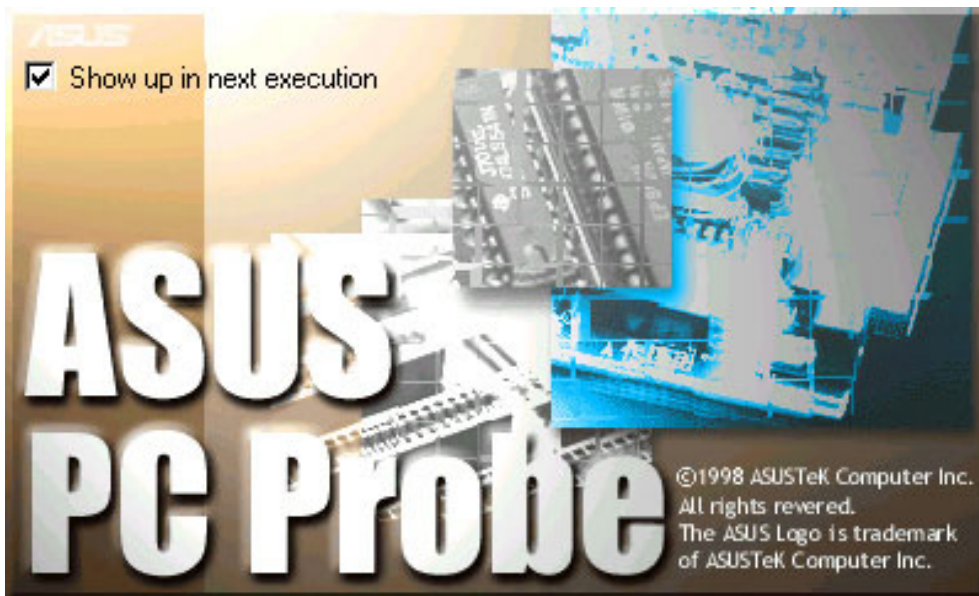

To launch **ASUS PC Probe**, click the Windows **Start** button, point to **Programs**, and then **ASUS Utility**, and then click **Probe Vx.xx**.

The PC Probe icon  in the taskbar system tray indicates that ASUS PC Probe is running. Clicking the icon allows you to see the status of your PC.

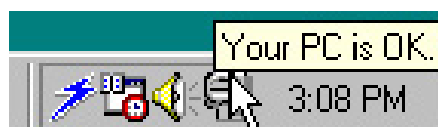

## Using ASUS PC Probe

### Monitoring tab

#### Monitor Summary

Shows a summary of the items being monitored.



#### Temperature Monitor

Shows the system temperature (for supported processors only).

##### Temperature Warning threshold adjustment

(Move the slider up to increase the threshold level or down to decrease the threshold level)

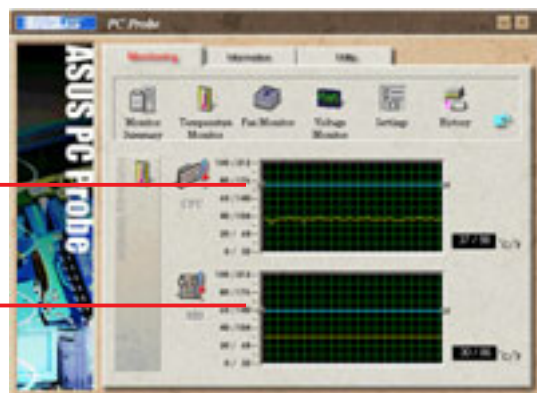

#### Fan Monitor

Shows the system's fan rotations.

##### Fan Warning threshold adjustment

(Move the slider up to increase the threshold level or down to decrease the threshold level)

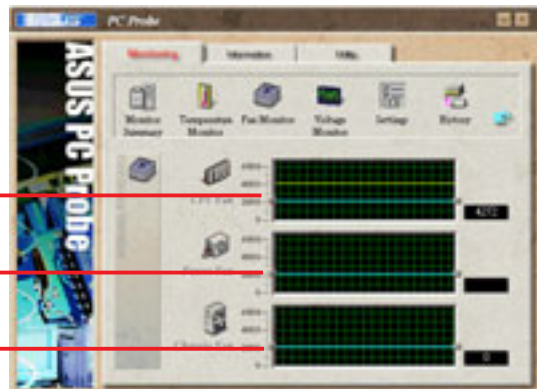

#### Voltage Monitor

Shows the system voltages.



## Settings

Lets you set threshold levels and polling intervals or refresh times of the DiGiMatrix temperature, fan rotation, and voltages.



## History

Lets you record the monitoring activity of a certain component of your DiGiMatrix for future reference.



## Information tab

### Hard Drive

Shows the used and free space of the DiGiMatrix' hard disk drive and the file allocation table or file system used.

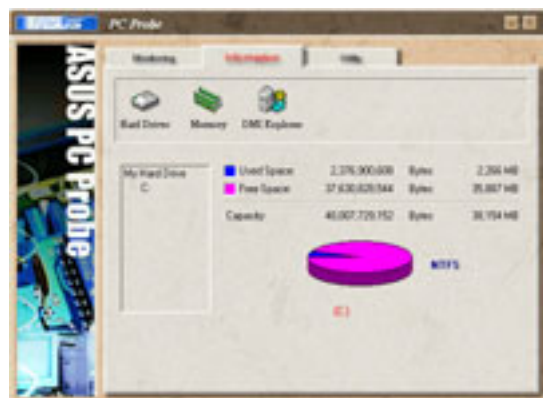

### Memory

Shows the DiGiMatrix memory load, memory usage, and paging file usage.

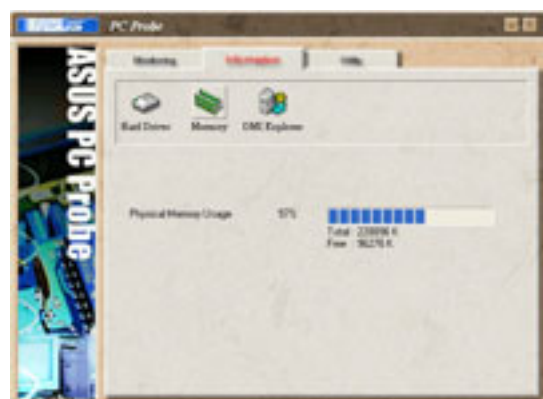



## DMI Explorer

Shows information pertinent to the DiGiMatrix, such as CPU type, CPU speed, and internal/external frequencies, and memory size.



## Utility tab

### Utility

Lets you run programs outside of the ASUS Probe modules. To run a program, click **Execute Program**. **NOTE:** This feature is currently unavailable.



## ASUS PC Probe Task Bar Icon

Right clicking the PC Probe icon brings up a menu to open or exit ASUS PC Probe and pause or resume all system monitoring.



When the ASUS PC Probe senses a problem with your PC, portions of the ASUS PC Probe icon change to red, the PC speaker beeps, and the ASUS PC Probe monitor appears.



## 4.2.3 Multi-channel audio feature

The ADI AD1980 AC '97 audio CODEC provides 6-channel audio capability. Install the **SoundMAX Audio Driver and Application** from the support CD that came with the motherboard package to activate the 6-channel audio feature.



You must use 4-channel or 6-channel speakers for this setup.

### Setting to multi-channel audio

After installing the audio driver, follow these instructions to adjust the audio settings and avail the onboard 6-channel audio feature.

1. From the taskbar, double-click on the **SoundMAX Digital Integrated Audio** icon to display the **SoundMAX Control Panel**.



2. The **Listening Environment** tab allows you to set to multi-channel speakers, enable or disable the **Virtual Theater Surround**, and select **Acoustic Environments** and **Virtual Ear**.



3. The default setting is **Stereo Speakers** (2-channel). To set to a 6-channel speaker system, click the arrow under **Speaker Setup** to display a list of options.

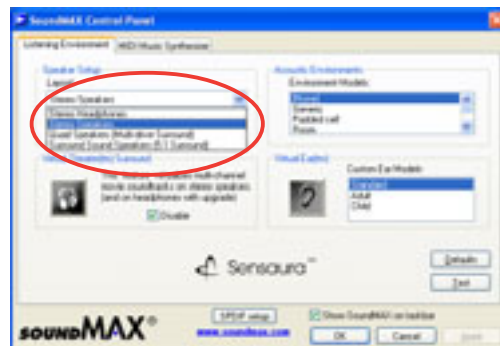

4. Select the option **Surround Sound Speakers (5.1 Surround)**.
5. Click the **Apply** button.
6. Click the **Test** button to display the **Test Listening Environment** window.
7. Select the audio test path from the drop-down menu.



8. After selecting an option, test your setting by clicking the **Play Test Noise** button. While testing, you will see a black circle moving on the screen indicating the audio path.

The **Play Test Noise** button becomes **Stop Playing** button. Click this button at any time to stop playing.

9. Click the **Close** button when done.

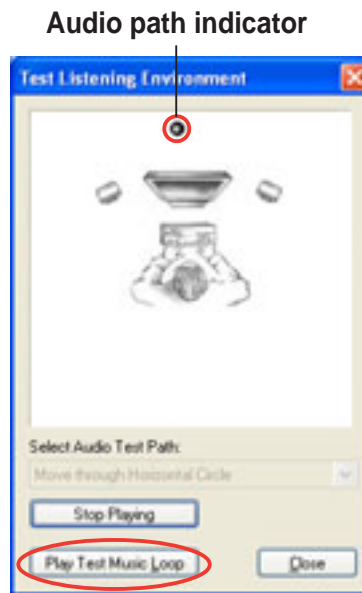

10. The **MIDI Music Synthesizer** tab allows you to select a setting for the MIDI.



11. Click the **Synthesizer Default Set** drop-down menu to display a list of options. Choose the desired setting.

12. Click **Apply**, then click **OK** when finished.

13. Reboot the computer.



## Adjusting the volume settings

1. After rebooting the system, click on the volume control icon on the Windows® taskbar to display the **Volume Control** window.

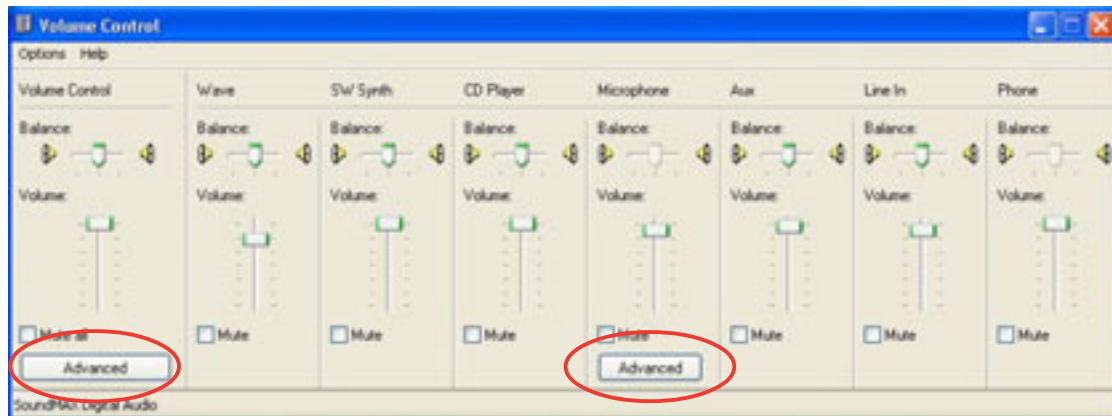

2. Click the Volume Control **Advanced** button. The **Advanced Controls for Volume Control** window appears.

To achieve 6-channel audio capability when playing DVDs, check the boxes opposite **AC3 SPDIF** and **PCM SPDIF**. Click **Close**.

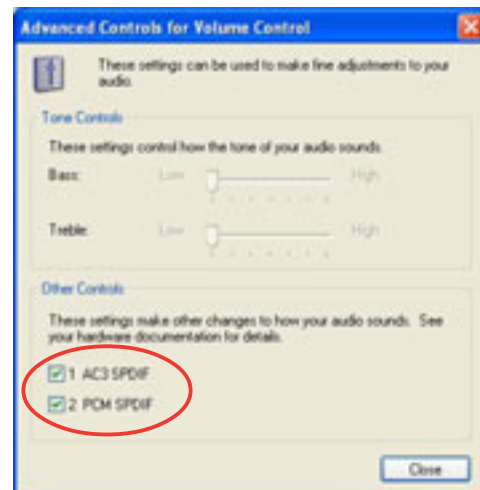

## Adjusting the microphone settings

1. Click on the Microphone **Advanced** button to display the **Advanced Controls for Microphone** window.
2. Check the box opposite **Mic2 Select** to enable the front panel microphone.
3. Click **Close** for the new settings to take effect.

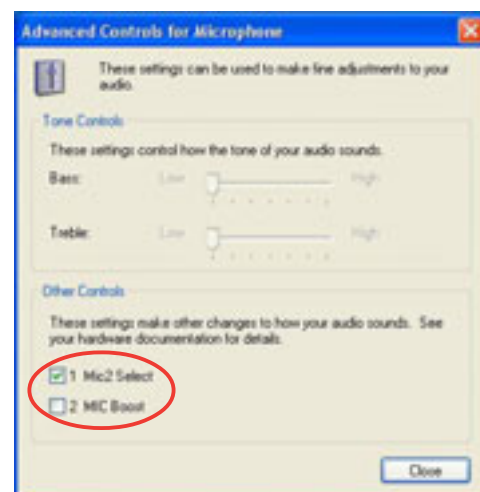

The rear panel Mic port is automatically disabled when you enable the front panel Mic port. Only one Mic port works at a time.

## 4.2.4 Music Wizard

The Music Wizard allows you to create and save MP3 playlists to your hard disk drive and lets you play them using the Audio DJ feature. See next section for the Audio DJ feature.

The Music Wizard utility is included in the support CD that came with the DiGiMatrix package. Refer page 35 to install Music Wizard.

### Launching Music Wizard

Launch the Music Wizard utility from the Windows® desktop by clicking **Start > All Programs > O2Micro Music Wizard > Music Wizard**.

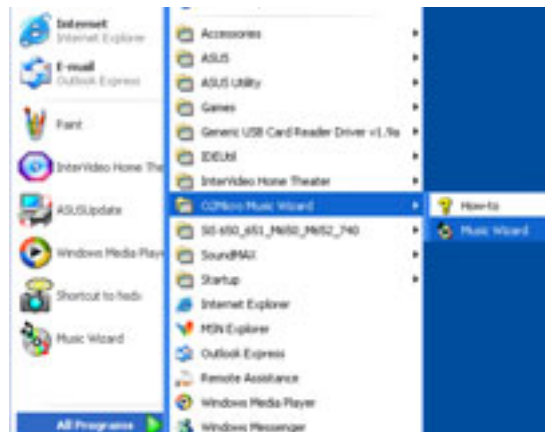

The Music Wizard window displays the playlists or folders (P1 to P9) and command buttons located at the bottom of the window.



#### Creating a Playlist or Folder

Click **Add** to create a playlist or folder. A New Playlist or New Folder window appears.

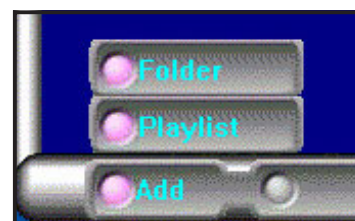

To create a playlist:

1. Locate the MP3 files you wish to add to the playlist.
2. Select the MP3 file, then click **Select** to add the file.
3. Click **OK** when done.

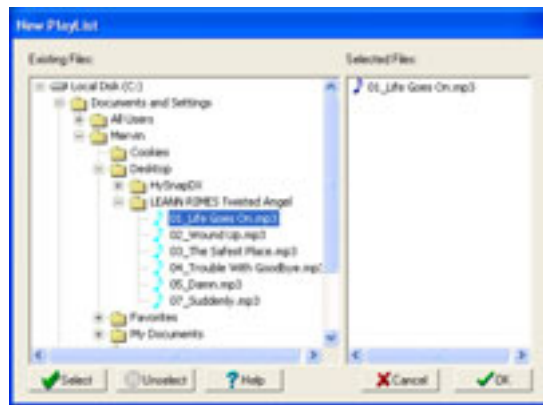

To create a folder:

1. Locate the folder with the MP3 files.
2. Select the folder, then click **Select**. Click **Unselect** to remove the folder.
3. Click **OK** when done.

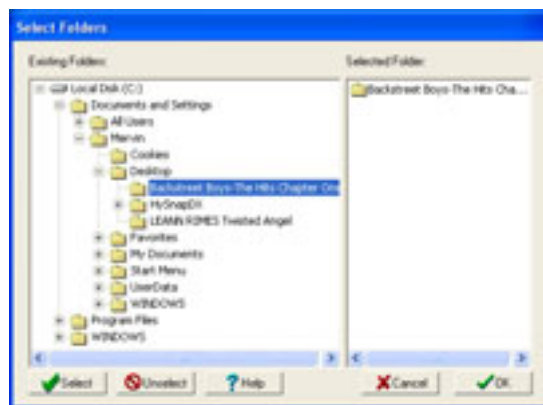

You may also drag and drop MP3 files to the **Selected Files** window to add more files to the playlist.

### Saving your playlist or folder

When prompted, save the playlist or the folder. Type a file name, then click **Save**.



The Music Wizard window displays the created playlist and folder.

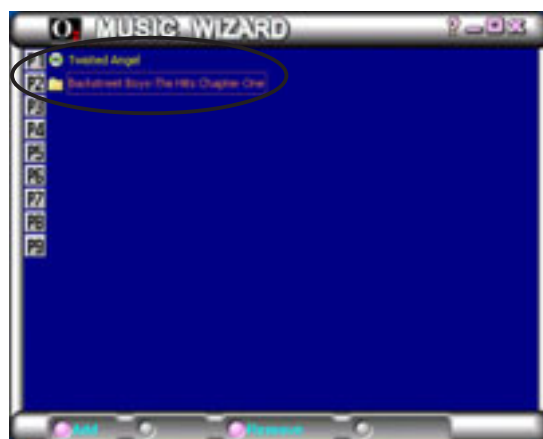

Click a playlist icon to view all MP3 files saved on that playlist or folder.



### Editing your playlist or folder

To add/remove a file to/from a playlist:

1. Select a playlist, then click **Edit**.



2. Select the file you wish to add from the **Existing Files** window, then click **Select**. Click **OK** when done.

To remove a file, select the file from the **Selected Files** window, then click **Unselect**.

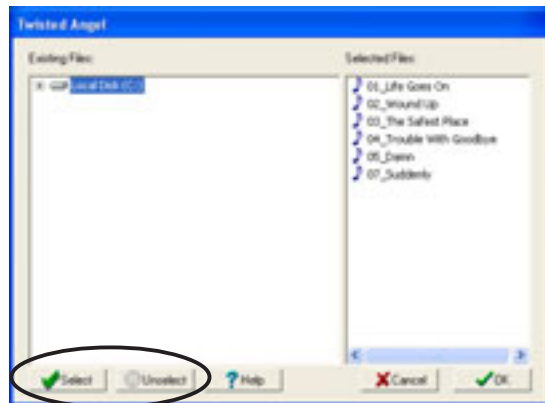

A confirmation window appears. Click **OK** to remove the file from the playlist.



## 4.3 Audio DJ

Audio DJ is an application that allows you to play MP3 files from your hard disk drive, audio CD/DVD, or tune into a FM radio station without entering the DiGiMatrix operating system. Use the audio buttons in the front panel or the remote controller to navigate through the Audio DJ window.



You must install Audio DJ from the support CD to use this feature. See page 35.

To turn on the Audio DJ feature, press the Audio DJ power button (🔊/AUDIO) located on the front panel or press the  button of the remote controller.

See page A-6 for the remote controller functions in Audio DJ mode.

The Audio DJ window appears.

```
Copyright (C) 2003, 2002, 2001, 02Micro International Ltd., All Rights Reserved.
O2MiniOS Version 4.11.0 Player Version 4.10.9

Hard Disk:
P1 : Twisted Angel
P2 : Backstreet Boys - The Hits Chapter One
P3 :
P4 :
P5 :
P6 :
P7 :
P8 :
P9 :

CD/DVD Device 1
Radio FM Device

play media : hdd mp3
Track 0001
Player Status : Playing
```



The Audio DJ feature is disabled when you disconnect the power plug and cable from the DiGiMatrix system. To enable the Audio DJ feature:

1. Connect the power plug and cable.
2. Press the system power button to turn on the system.
3. Use the Windows® shutdown procedures to turn off the system.
4. Press the Audio DJ power button to put DiGiMatrix in Audio DJ mode.



### 4.3.1 Selecting an audio source

The Audio DJ window displays the audio sources (Hard Disk, CD/DVD Device 1, and Radio FM Device), play medium, and player status.

To select an audio source:

1. Press the **STOP** (■) button until the Player Status displays **Playlist Mode**.
2. Press the **STOP** (■) button again, or the  button on the remote controller to select another audio source.

### 4.3.2 Playing MP3 files from the hard disk drive

Audio DJ displays the playlists you created using the Music Wizard utility (see page 45). If you selected **Hard Disk** as audio source, the first playlist is automatically selected.

To play an MP3 playlist:

1. Press the **STOP** (■) button, or the  button on the remote controller to select a playlist.
2. Press the **PLAY/PAUSE** button to start playing the first MP3 file on the playlist.

### 4.3.3 Playing an audio CD/DVD

To play an audio CD/DVD:



1. Insert an audio CD/DVD to the optical drive.
2. Select CD/DVD Device 1 as your audio source.
3. Press the **PLAY/PAUSE** button to start playing the first track of the audio CD/DVD.
4. Press the **NEXT** or the **PREVIOUS** button to skip to the next track or to return to the previous track.
5. Press **STOP** to stop playing an audio track.

```
CD/DVD Device 1  
Radio FM Device
```

```
play media : audio cd  
Track 0001  
Player Status : Playing
```

## 4.3.4 Tuning into an FM radio station

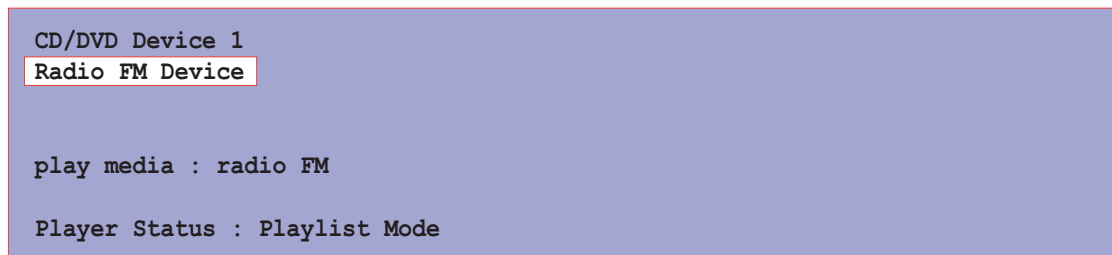

To tune into an FM station:

1. Select Radio FM Device as your audio source.
2. Scan the radio frequency by pressing the **PLAY/PAUSE** button. The scanning stops when a station is detected. The LED panel displays the radio frequency.
3. Press the **NEXT** or **PREVIOUS** button or the   buttons on the remote controller to select a preset station, if any.





## 4.3.5 Presetting a station

To preset a station:

1. Press the **PLAY** button to scan available radio stations.
2. After you have selected a radio station, press the **PLAY/PAUSE** button for at least 2 seconds until a preset number blinks on the LED panel. You may also press the  button on the remote controller.
3. Press the **NEXT** or **PREVIOUS** button or the   buttons on the remote controller to select a preset number (1-9) for the selected station.
4. Press the **PLAY** button to confirm the preset station.

## 4.3.6 Adjusting the volume

You may adjust the volume by turning the Volume Dial clockwise (volume up) or counterclockwise (volume down). You may also press the  or  on the remote controller. Press the volume dial to **MUTE** sound.

## 4.4 ASUS Home Theater

The ASUS Home Theater allows you to maximize the DiGiMatrix multimedia features. The following sections provide information on installing and using the ASUS Home Theater.

### 4.4.1 Installing ASUS Home Theater

Place the ASUS Home Theater CD into the optical drive to start installation.

The initial installation window appears. Click **Next**.



Read the License Agreement, then click **Yes**.

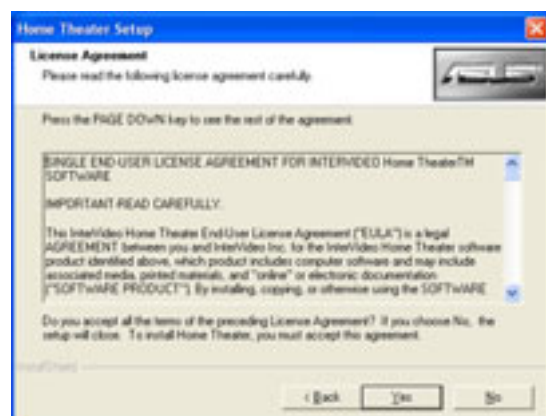

When prompted, select the program folder where you intend to save the ASUS Home Theater program icons. Click **Next**.

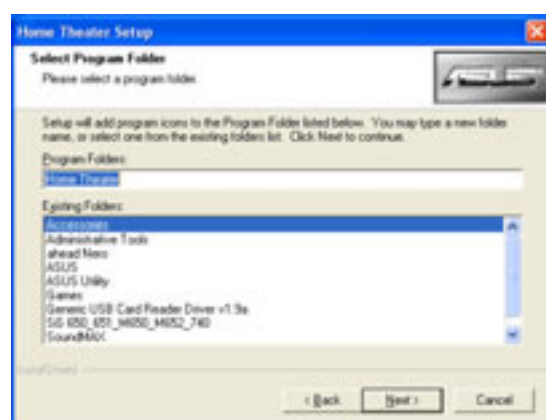

The Home Theater application is copied into your system. Restart your computer after installation is completed.



To launch the ASUS Home Theater, click **Start > All Programs > Home Theater > Home Theater**.

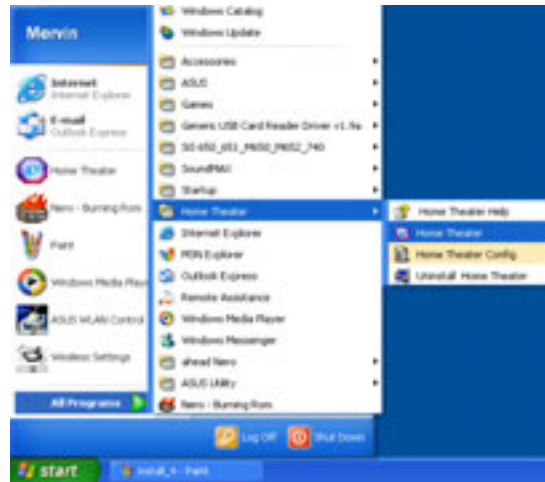

## Configuring Home Theater in Windows®

To configure Home Theater settings in Windows®:

1. From the Windows® desktop, click **Start > All Programs > Home Theater > Home Theater Config**. A **Configuration** window appears.
2. Change the Home Theater **General**, **Pictures**, **Television**, and **DVD** settings by clicking their respective tabbed property sheets.
3. Click **OK** when done.

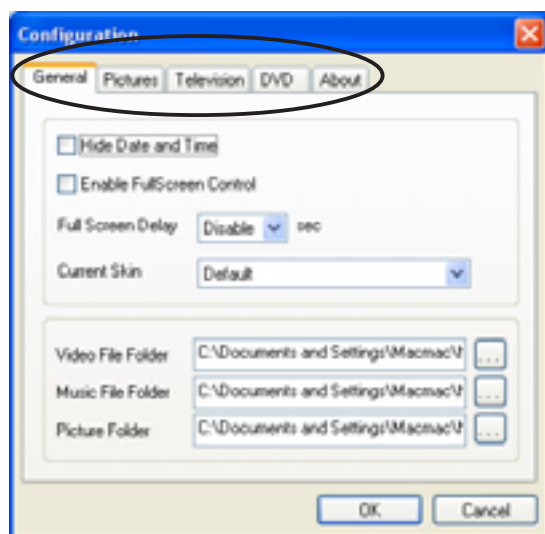

You may also change the Home Theater settings using the **Setup** button in the Home Theater main window. See pages 53, 62, and 63 for details.

## 4.4.2 Using ASUS Home Theater

The ASUS Home Theater features a user-friendly interface that integrates all the multimedia functions of the DiGiMatrix. Home Theater lets you watch TV, play a DVD or video clip, tune into an FM radio station, listen to audio files or browse pictures from the same interface. This flexibility allows you to switch from one entertainment mode to another without opening different entertainment applications. Below is the ASUS Home Theater main window.



**Mode display** - Displays the current or last entertainment mode used.

**Entertainment mode buttons** - Click on a button to launch an entertainment mode.

**Setup** - Click this button to display the setup window.

**WWW** - Click this button to open the ASUS website.





**Window control buttons** - Controls the Home Theater window.

Click  to return to the previous window.

Click  to minimize the window.

Click  to maximize the window.

Click  to exit Home Theater, put the computer in standby mode, or shutdown the DiGiMatrix system.

Use the control panel buttons or navigation buttons on the remote controller (     ) to navigate through the Home Theater windows.

---

Refer to page A-7 for the remote controller functions in Home Theater.

---

### The control panel

Each Home Theater window is equipped with a control panel to control the entertainment modes. The control panel buttons and functions are illustrated below.

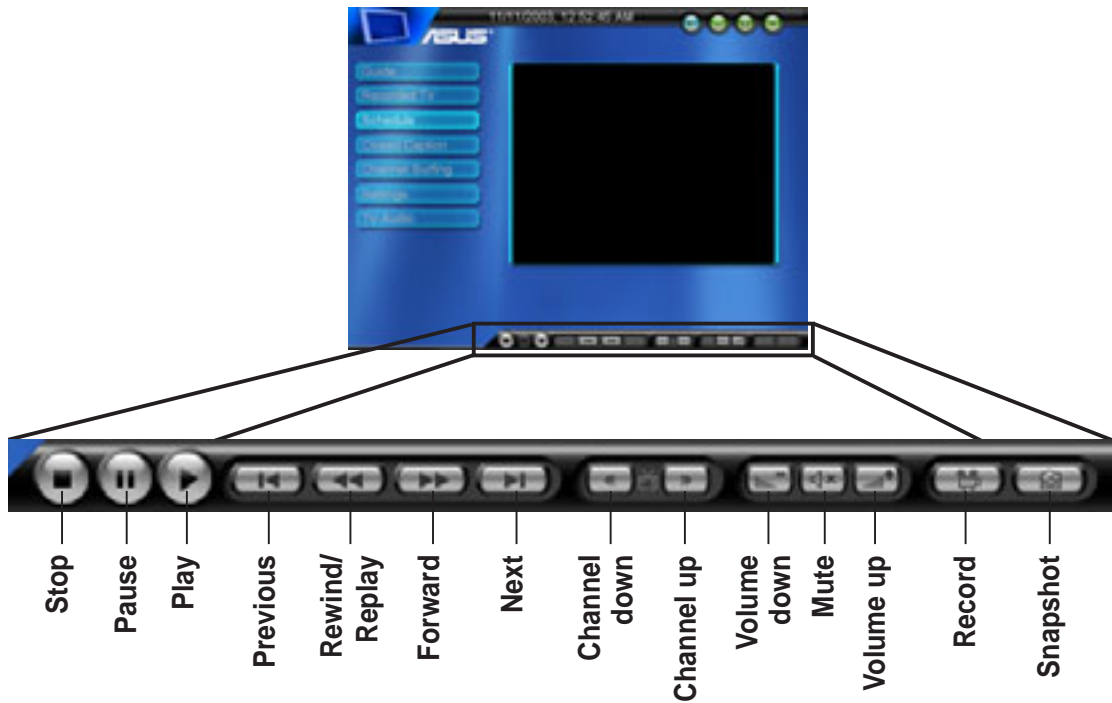



---

Some control panel buttons change from one entertainment system to another.

---

## 4.4.3 Entertainment modes

### TV

Home Theater lets you to watch TV on your DiGiMatrix system. The TV window has six sub-menus. Change the TV channel by clicking the **Channel** buttons on the control panel or the  or  on the remote controller.



---

On initial use, Home Theater instructs you to autoscanner available TV channels. Click the **Settings** button, then click **Autoscan** to view the available channels. See “**Settings**” on page 58 for details.

---

#### TV features

The ASUS Home Theater comes with several features that support playing, recording, and replaying TV programs.

#### Simultaneous playing and recording

Home Theater allows you to watch a recorded TV program while in the middle of a recording. For example, you recorded a TV program that runs from 1:00 p.m. to 2:00 p.m. There is no need to wait for recording to finish. Click the **PLAY** button anytime between the recording schedule to watch the program being recorded. Home Theater continues to record the rest of the program.

## Timeshifting

Timeshifting allows you to pause and record a TV program for temporary leave so you do not miss anything. Click the **PAUSE** button to activate timeshifting. Home Theater pauses and starts recording the TV program. Click **STOP** to watch the program where you left it. Click **PLAY** to return to real-time TV.

## Instant Replay

The Home Theater TV has an instant replay capability that lets you replay a portion of a recorded program. Click the **REWIND/REPLAY** button to activate the instant replay feature.

---

You may only use this feature when watching a recorded program or while recording a TV program.

---

## Guide

Click the **Guide** button to open the TitanTV website. TitanTV is an Electronic Program Guide (EPG) that allows users to record and watch TV right from the guide. Visit the Titan TV website for details.



## Recorded TV

The **Recorded TV** option lets you view, play, and organize recorded TV programs.

Select a recorded program from the list, then click the **Play** button to start playing.

Organize your recorded programs by clicking the **Sort By Name/Date** buttons.

The **Recorded TV** window also displays recorded TV file information.





Click the **View** button to preview a recorded program. A window displays a snapshot of each recorded program. Click the **View** button again to return to the recorded program list.



### Schedule

The Schedule option allows you to set a schedule to record a TV program. To add a recording schedule, click .

---

Home Theater automatically saves a recorded program in the Windows® **My Videos** folder. Home Theater records TV programs in MPEG file format.

---



**Add schedule**

To create a recording schedule:

1. Select the recording settings including the channel, frequency, start date/hour/minute, duration and record quality.
2. Click **Finish** when done.





---

The TV recording feature requires a higher capacity HDD if you save a recorded program in high quality.



---

- Home Theater displays the recording schedule.

To edit a recording schedule, select the schedule from the list, then click .

To delete a recording schedule, select the schedule from the list, then click .



 Delete a schedule  
 Edit a schedule  
 Add a schedule

### Channel Surfing

To surf for available channels in your location:

- Click the **Channel Surfing** button.
- Click a channel to preview in the mode display.
- Double-click a channel to display.



### Settings

To change the TV settings:

- Click the **Settings** button.
- Select the TV source (Cable/Antenna), input source (TV/S-Video/Composite), and record quality (Good/Better/Best). Click the side arrows to view available options.
- Click the  to return to the TV main window.



Click to select other options

### TV Audio

The TV Audio button allows you to set the TV audio output to Stereo, Mono or SAP.

## Radio

Home Theater lets you tune in and listen to an FM radio station.

Click **Radio** on the Home Theater main window. The Radio window appears.

Click **Autoscan** to view available FM stations in your location. Select a station from the list to start listening.

Organize the FM stations by name or frequency using the **Sort By Name/Frequency** buttons.

You may also customize your station list using the the **Add/Remove Station** buttons.



Click to record

### Radio recording

Home Theater allows you to make a radio recording using the control panel **Record** button. Click the **Stop** button to stop recording.

Home Theater automatically saves your radio recording in the Windows® **My Music** folder. Use the Home Theater **Music** window to view and/or listen to your recordings.

## Music

Home Theater lets you play audio CD/DVD tracks, MP3 files and radio recordings using the **Music** window. The **Music** window lists the title, album, artist, and genre of available audio tracks.

Select **My Music** to view and play audio files and radio recordings saved to your hard disk drive. Click **My Music** to display audio CD/DVD tracks. Control the audio playback using the control panel buttons.

Click the **Rewind/Replay** or **Forward** button to change the media browser ambience.



Ambience Click to change media browser ambience

---

Home Theater only lists the audio files saved in the Windows® **My Music** folder.

---

## Pictures

The **Pictures** window lets you view and print pictures saved in the Windows® **My Pictures** folder.

Sort your pictures by clicking the **Sort By Name/Date** buttons.

Click **Print Picture** to print a selected picture.

You may also zoom or rotate the pictures using the control panel buttons.

Click the **PLAY** button to start a slideshow.





Click to start slideshow

Rotate Right  
Rotate Left  
Zoom Out  
Zoom In

### Customizing slideshows

To customize your picture slideshow:

1. Click the **Settings** button.
2. Adjust the slideshow properties from this window.
3. Click  to return to the Pictures window, then click the **PLAY** button to start the slideshow
4. Click the  button to view a full screen slideshow.



## Video Clips

View, play and organize your video clips using the **Video Clips** window.

The **Video Clips** window displays the title and length of video clips saved in the Windows® **My Videos** folder. It also displays video clips information including the file name, file size, and date of recording.



The **Video Clips** window only lists video clips saved in the Windows® **My Videos** folder.

Click **View** to display a snapshot of the video clips. Sort your video clips by clicking the **Sort By Name/Date** buttons.



## DVD/VCD

Watch a movie with the DVD/VCD player. Place a DVD/VCD in the optical drive, then click the **Play** button.

---

The **Settings** button is enabled only when a DVD/VCD is inserted to the optical drive.

---

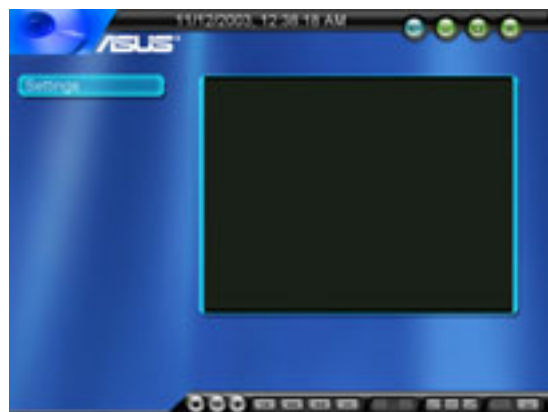

Click **Settings** to adjust the DVD/VCD player properties.

**Audio Language.** Select the DVD audio language. You may select an audio language if the DVD supports multilanguage audio.

**Subtitle Language.** Allows you to select an available DVD subtitle language.

**Auto Resume.** Allows you to resume watching a movie from the beginning or from where you stopped.

**Source.** Displays the video input source.

**Audio output.** Allows you to set your audio output to analog or digital (S/PDIF).

**Speaker configuration.** Home Theater automatically detects your speaker configuration. Change the speaker configuration using the **SoundMAX** application. Refer to page 42 for details.



## Setup

The **Setup** window lets you configure the Home Theater multimedia windows.

### Home Theater settings

This window lets you configure general Home Theater settings.

**Hide Date and Time.** Allows you to display or hide the date and time.

**Full Screen Control.** Allows you to select full screen control.

**Full Screen Delay.** Allows you to set the time for full screen delay.

Click **Next** to display the TV settings window or **Close** to return to the main window.



### TV settings

Use this window to adjust the Home Theater TV properties.

**TV Source.** This item allows you to select Cable or Antenna as the TV signal source.

**Country.** This item allows you to select the country. Home Theater automatically fills in the correct **Video Standard** for the selected country.

**Video Capture Device.** This item allows you to select the video capture device for TV recording. Home Theater automatically detects the installed video capture device.

**Input Source.** This item lets you set your video input source to TV, Composite, or S-Video.

**Video Standard.** Home Theater automatically sets the Video Standard when you select a country.

**Audio Device.** Home Theater automatically detects and displays the installed audio device.

**Audio Source.** This item allows you to set your audio source to CD Player, Microphone, Aux, Line In, Phone, or Mono Out.

**Record Quality.** Set your recording quality to Good, Better, or Best.

Click **Next** to display the Picture settings window or **Close** to return to the main window.



### Picture settings

Allows you to customize your picture viewing and to setup a slideshow.

Click **Next** to display the DVD settings window or **Close** to return to the main window.

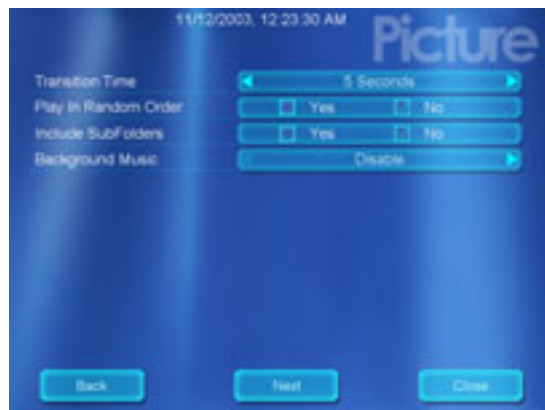

### DVD/VCD settings

Adjust the DVD/VCD player settings on this window. See page 61 for DVD/VCD settings.

Click **Finish** to return to the main window.



## **Closing Home Theater**

Click the  button anytime to display the close window.

**Close** - Click this button to exit Home Theater and return to the Windows® desktop.

**Stand By** - Click this option to put the DiGiMatrix in a stand-by mode.

**Shutdown** - Click this button to shut down the DiGiMatrix system.

**Cancel** - Click this button to return to the Home Theater main window.

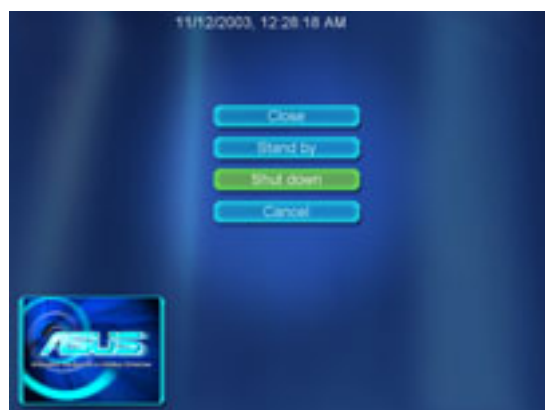

## 4.5 ASUS Wireless LAN adapter

The DiGiMatrix system comes with an IEEE 802.11b-compliant wireless LAN adapter for wireless local area network (WLAN). The wireless LAN adapter allows you to share a single Internet connection with other computers making it a perfect solution for your home or small office network.

### Features

The wireless LAN adapter gives you freedom to connect to a wired or wireless local area network and the Internet without the wires and cables. Employing the Direct Sequence Spread Spectrum (DSSS) technology, the wireless LAN adapter is capable of transmitting and receiving signals through radio waves on the 2.4 GHz band. Below are other wireless LAN adapter features:

- Reliable data transfer rates of up to 11Mbps with automatic fallback to 5.5, 2, and 1Mbps
- Secure data transmission via Wired Equivalent Privacy (WEP) encryption
- Operating distance of up to 100 ft (30 m) indoors
- Easy installation and full software support
- Soft access point function supports up to 31 wireless clients (Windows® XP only)
- Supports infrastructure (wireless LAN adapter to access point) and Ad-hoc (wireless LAN adapter to other wireless clients) network types
- Windows® 2000/XP compatible

---

The wireless LAN adapter operating distance may be shorter if there are walls, barriers, or interferences in the home layout or operating environment.

---



## 4.5.1 Installing the WLAN Card utilities and driver

To install the Wireless LAN adapter driver and the Control Center utility in your DiGiMatrix system:

1. Insert the DiGiMatrix support CD to the optical drive.
2. In the **Drivers** window, Click the **ASUS Wireless LAN Adapter Driver** item. An installation window appears.
3. Click **Install ASUS WLAN Card Utilities/Driver** to begin installation.



## 4.5.2 Setting the Windows® XP wireless options

After installing the wireless LAN adapter in Windows® XP OS, the **Wireless Option** window appears. Select “**Only use ASUS utilities and disable XP wireless function**” to avail all wireless LAN adapter features. Click **OK**.

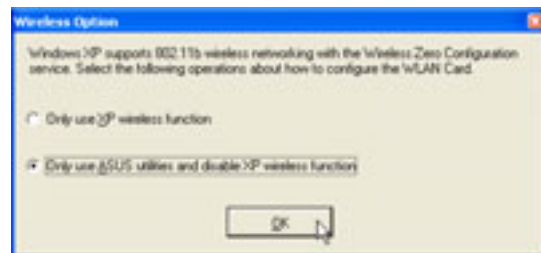

## 4.5.3 Other support CD options

**Uninstall ASUS WLAN Card Utilities/ Driver.** Click this option to uninstall the WLAN Card utilities and driver from your system.

**Read/Install User Documentation.** Click to view the user handbook, installation, and quick setup guides in PDF format.

**Install Screen Savers.** Click this option to install the WiFi@HOME screen savers in your DiGiMatrix system.

**Explore this CD.** Click this option to explore the support CD contents.

**Browse our Web Site.** Click this option to visit the ASUS website.

**Installation Language.** This option allows you to change the installation language. Click the arrow to display available installation languages.

Click **EXIT** to close the installation window.

## 4.5.4 Setup Wizard

After configuring the wireless option, the Setup Wizard window appears. Click **Next**.

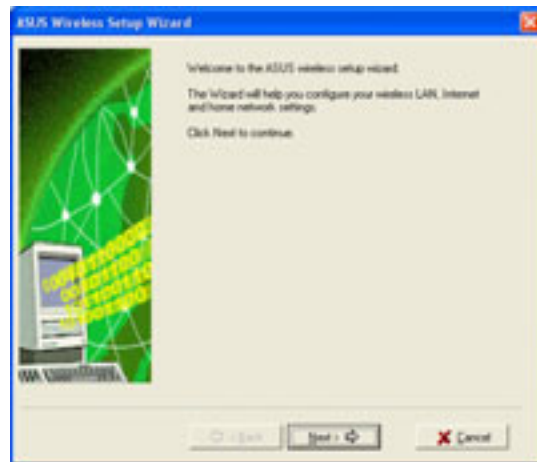

The setup wizard windows may vary on different operating systems.

### Selecting the wireless LAN adapter operating mode

The default setting of the wireless LAN adapter is Station Mode in an Infrastructure type network. The first time you run the setup wizard, it scans for available access points (AP) in your location and automatically selects the AP with the best signal. The wizard also allows you to connect to any of the available APs.

If you want to set your wireless LAN adapter in soft access point mode or in Ad-hoc network setting, check **My Configuration**, then click **Next**. See “My Configuration” section on page 68 for details.

### Station Mode

Follow these instructions to set your wireless LAN adapter in station (STA) mode.

Select a wireless network from the table, then click **Next**. The wireless LAN adapter connects to the selected network.

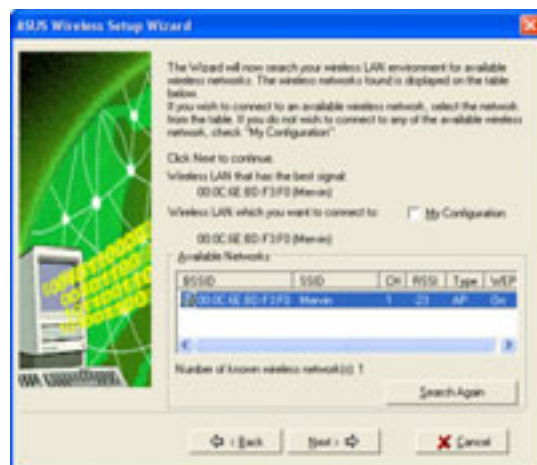

Click the **Search Again** button to re-scan available access points in your location.

If the AP you wish to access has an enabled Wired Equivalent Privacy (WEP) encryption, the setup wizard prompts you to enter the WEP keys.

Refer to “Config-Encryption Tab” on page 83 for WEP encryption settings.

Click **Next** when done.

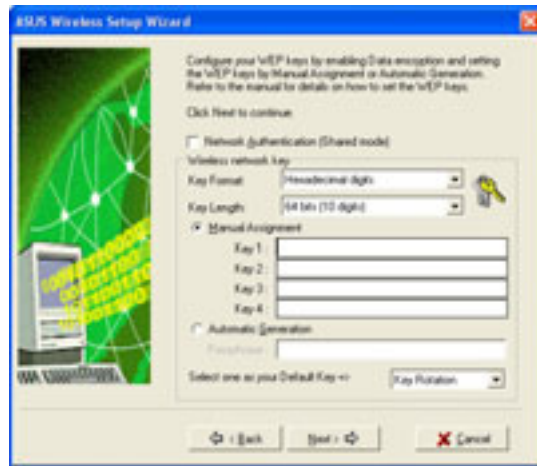

Obtain the WEP keys from the network administrator. The WEP keys of the wireless LAN adapter and the selected AP must be identical to establish connection.

When connected, the wizard displays information on the wireless network to which the adapter is associated.

Click **Next** to configure the TCP/IP settings.

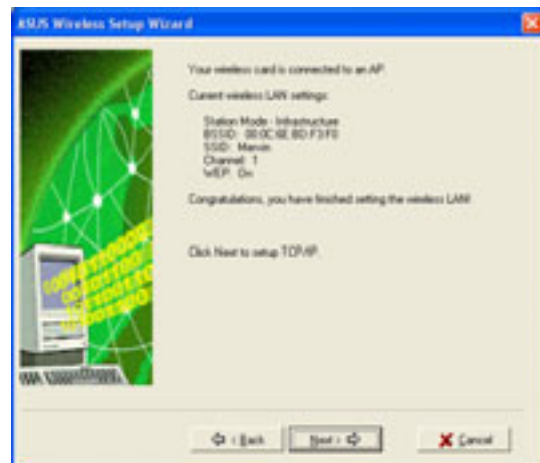

The wizard prompts you to return to the previous window and select another wireless network if the wireless LAN adapter is not connected to the selected network.

Select automatic IP settings if your network supports automatic IP address assignment. If not, obtain the IP settings from your network administrator, then enter the IP address manually.

Click **Next** when done.

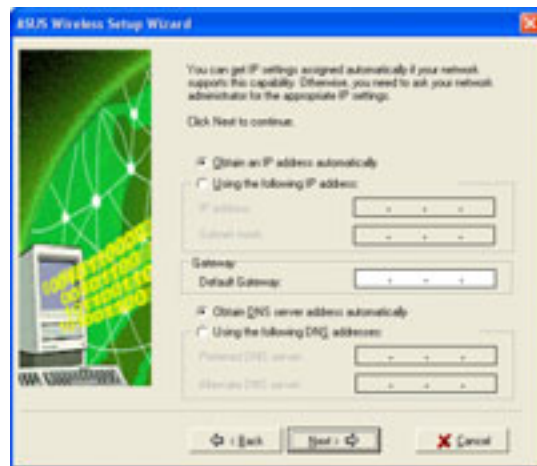

The TCP/IP configuration window appears when you run the setup wizard on Windows® 98SE/ME/2000. The window also appears in Windows® XP OS if the wireless LAN adapter is not bridged to other network connections and has a disabled ICS function.

The wireless LAN adapter setup is complete. Click **Finish** to close the setup wizard.

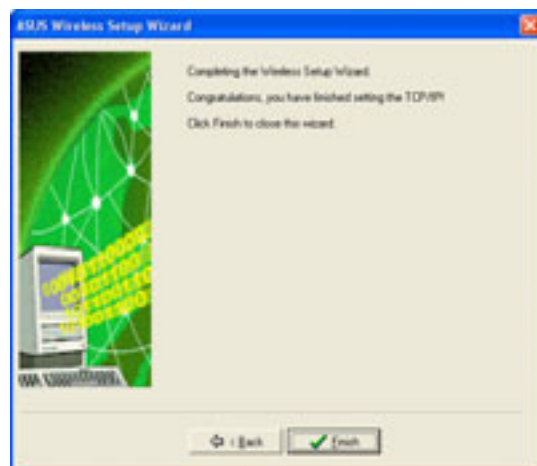

## My Configuration

The setup wizard allows you to set the wireless LAN adapter in various operating modes when you selected **My Configuration**. Select an operation mode, then click **Next**.



## Creating your own wireless LAN (Soft AP and Ad-hoc modes)

When prompted, assign an **SSID** (Network Name) to the soft access point (AP) or wireless LAN network (Ad-hoc) you wish to create, then select a radio channel that you wish to use in communicating with other wireless devices.

Click **Next** to continue.

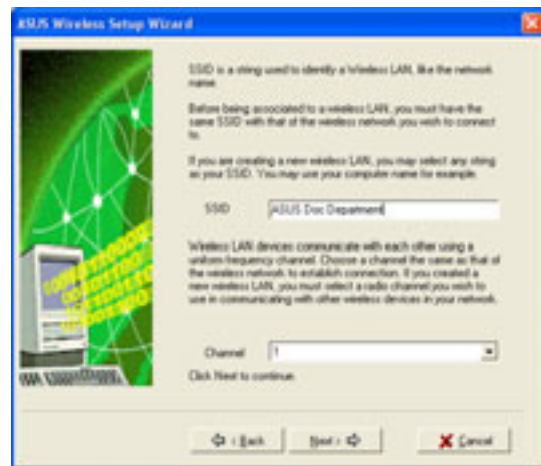

Check **Data encryption (WEP enabled)** to secure your soft AP or wireless LAN network with a Wired Equivalent Privacy (WEP) encryption. Click **Next**.



Enabling data encryption prevents unauthorized access by other wireless networks in your location.

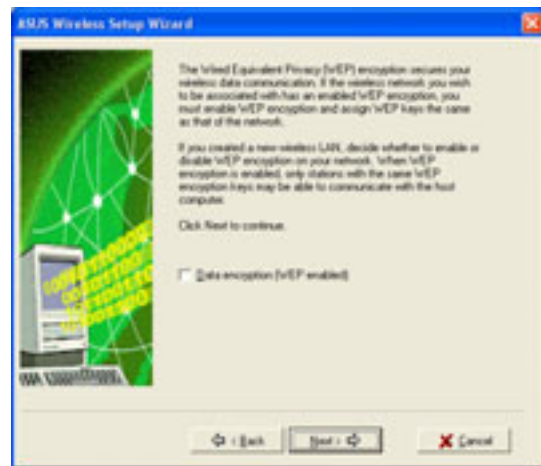

Assign WEP encryption keys to your soft AP or wireless LAN network. Refer to "Config-Encryption Tab" on page 83 for WEP encryption settings.

Click **Next**.

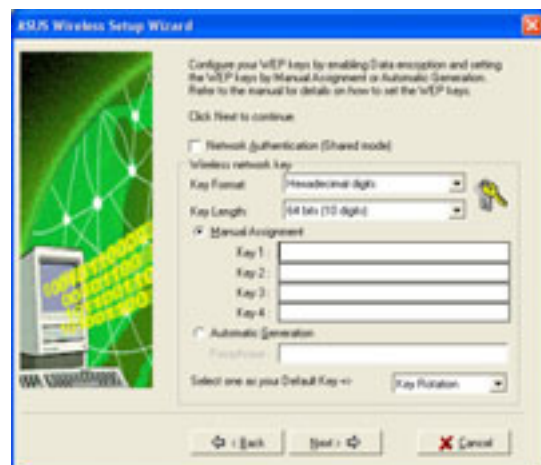

Keep a record of the WEP keys. Wireless clients in your network must have the same WEP keys to establish connection with the soft AP or the wireless LAN network.

The wizard displays the settings of the created soft AP or wireless LAN network including the operating mode, SSID, channel, and WEP encryption information.

If you created a Soft AP, click **Next** to set up Internet Connection Sharing (ICS). See “Internet Connection Sharing” section on page 73.

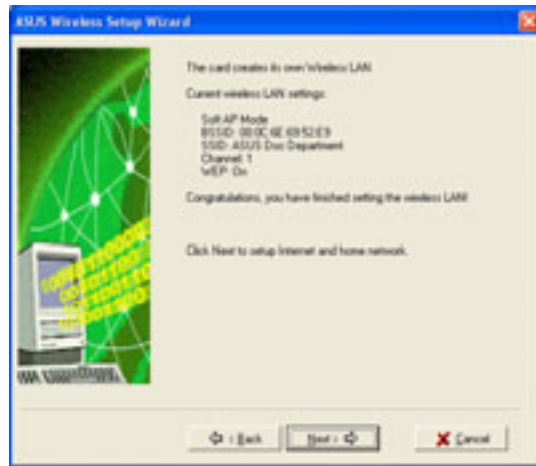

When the wireless LAN adapter is set to Ad-hoc mode, click **Next** to configure the TCP/IP settings. Refer to the “Station Mode” section on page 66 for TCP/IP configuration.

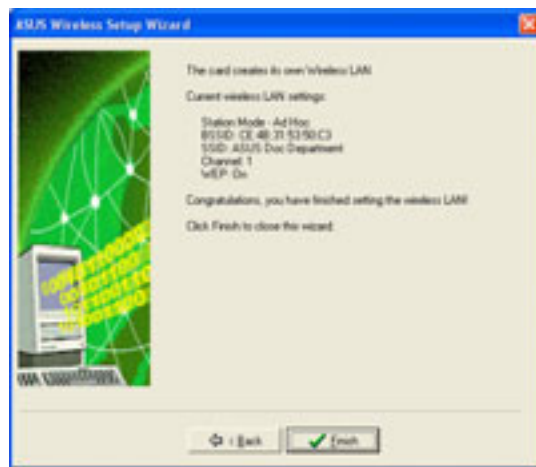

### ***Connecting to a hidden wireless LAN***

Some access points disable their SSID broadcasting to prevent a wireless device from finding and accessing their networks. Obtain the SSID of the hidden wireless LAN from the network administrator. To connect to a hidden wireless LAN:

Select **Connect to a hidden wireless LAN**, then click **Next**.



When prompted, enter the SSID of the hidden wireless LAN you obtained from the network administrator. Click **Next**.

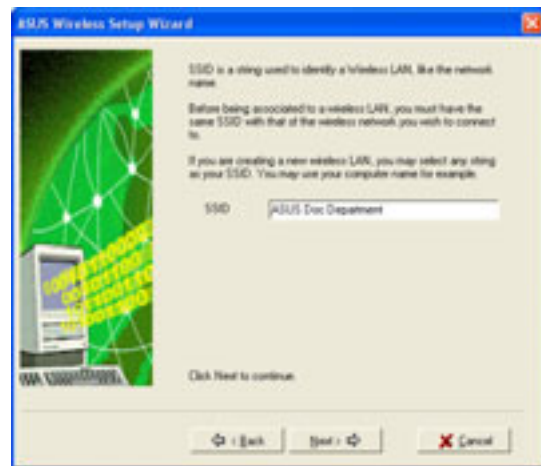

If the hidden wireless LAN you wish to access has an enabled Wired Equivalent Privacy (WEP) encryption, the setup wizard prompts you to enable data encryption. Check the **Data encryption** box, then click next.



Obtain the WEP keys from the network administrator. The wireless LAN adapter and the hidden wireless LAN WEP keys must be identical to establish connection.

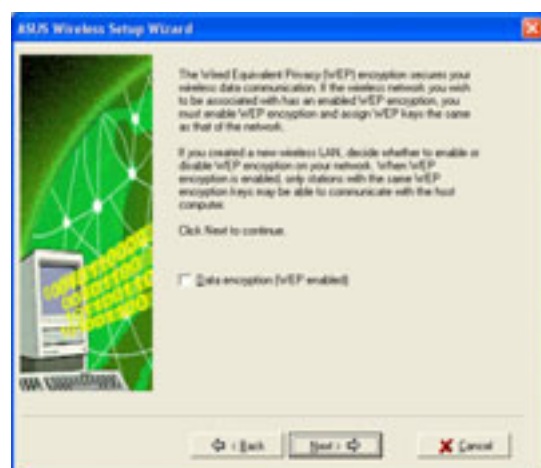

Enter the WEP encryption keys that you obtained from the network administrator. Refer to “Config-Encryption Tab” section on page 83 for WEP encryption settings. Click **Next**.

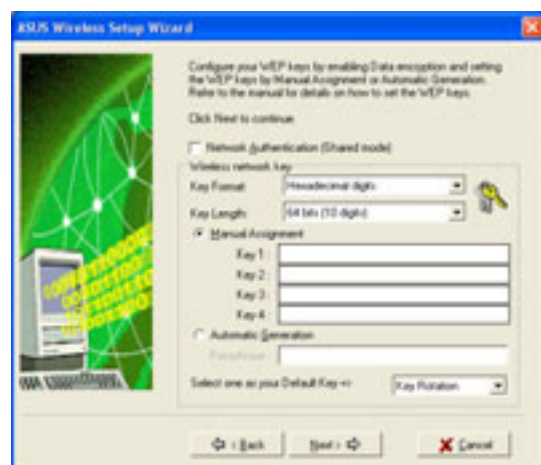

The wizard displays the hidden wireless network information where the wireless LAN adapter is associated.

Click **Next** to set the TCP/IP settings.

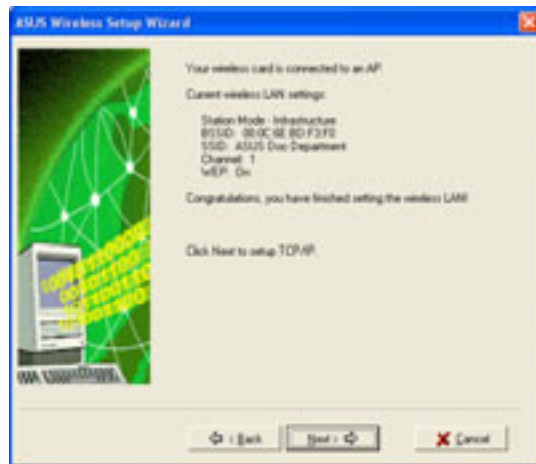

Select automatic IP settings if your network supports automatic assignment of IP address. If not, obtain the IP settings from your network administrator, then enter the IP address manually.

Click **Next** when done.

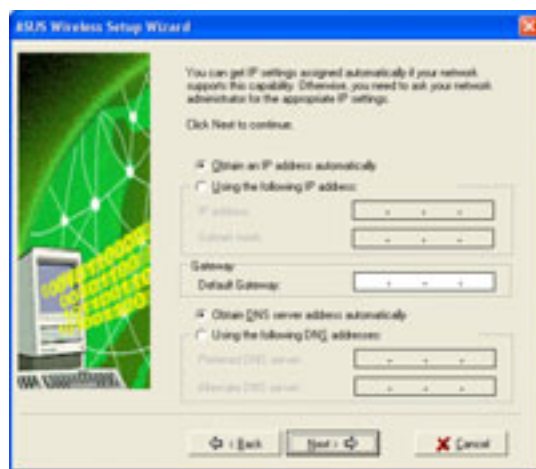

The wireless LAN adapter setup is complete. Click **Finish** to close the setup wizard.

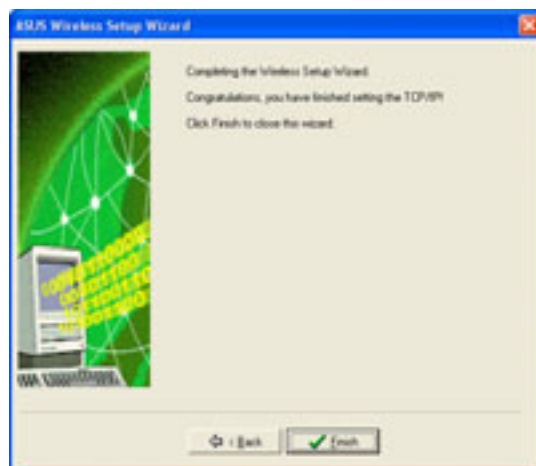



## Internet Connection Sharing (ICS)

After setting the wireless LAN adapter in Soft AP mode, the wizard prompts you to set up Internet Connection Sharing (ICS). ICS is a networking feature that allows several computers in a wired or wireless network to share a single Internet connection. To setup ICS:

1. Select whether your computer connects to the Internet or not. Click **Next**.



The wizard will require you to create a home network connection if your computer is not connected to the Internet.

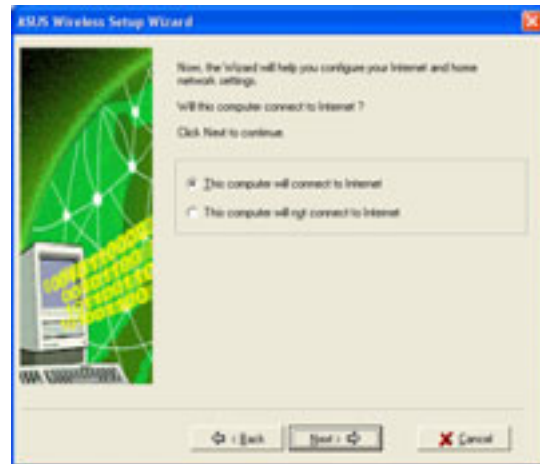

2. Select the Internet connection mode of your computer from the list, then click **Next**.

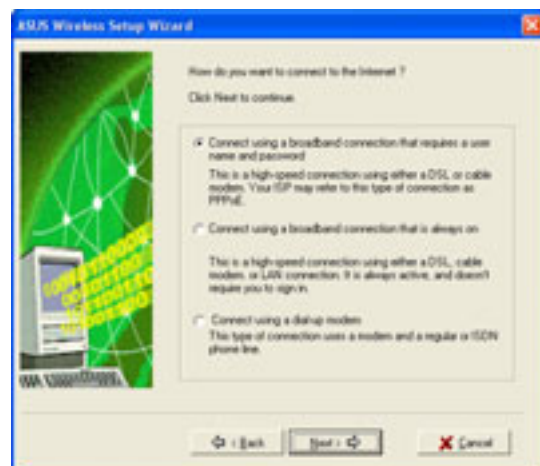

### ***Broadband connection that requires an account***

Follow these instructions to enable ICS if you have an existing broadband network connection that requires a username and password.

1. Select the broadband network connection from the drop-down list. Click **Next**.



If you do not have a broadband network connection, the wizard instructs you to create one using the Windows® interface or the support CD from your Internet Service Provider (ISP).



2. When prompted, select whether your computer connects to the Internet directly or through another computer or residential gateway. Click **Next**.



### Internet connection via another computer or residential gateway

If your computer connects to the Internet through another computer or residential gateway:

1. Select the network adapter you are using to connect to the host computer or residential gateway. Click **Next**.

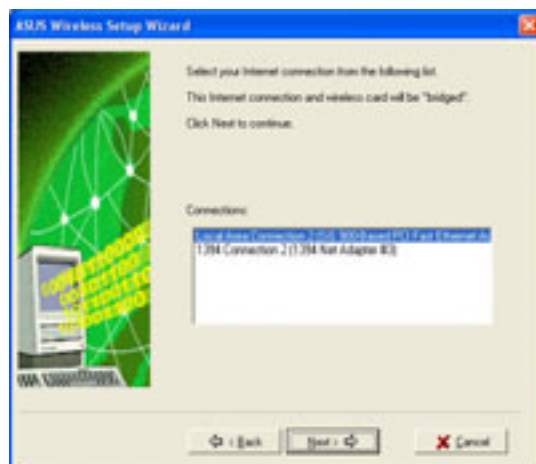

2. Select the network adapters that connect to other computers in your home network, if any. The wizard will bridge these networks with the wireless LAN adapter. Click **Next**.

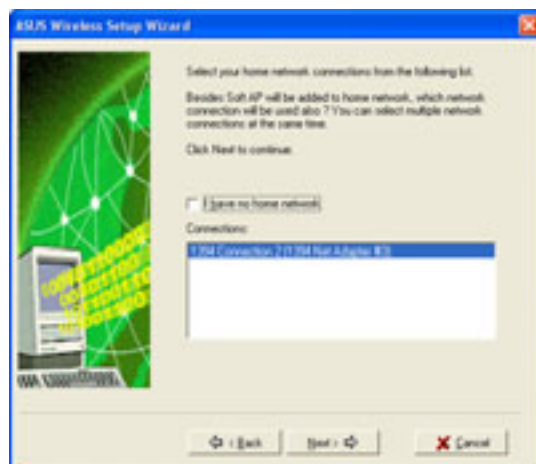

- The wizard creates a network bridge between your wired (LAN) and wireless (wireless LAN adapter) network connections. Click **Next**.



Network bridge is a process of connecting several wired or wireless LAN segments. See page 99 for details.

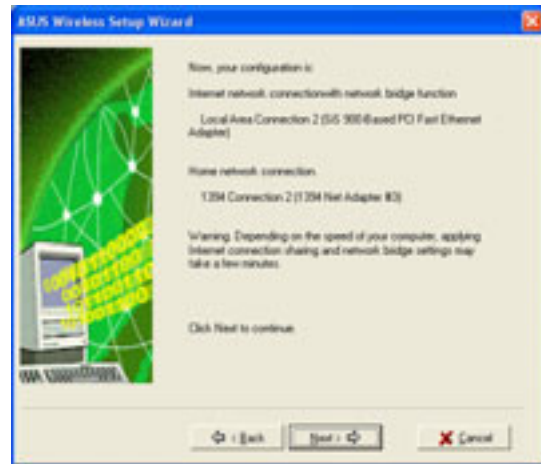

- Click **Yes** when an Internet Sharing Configuration dialog box appear.

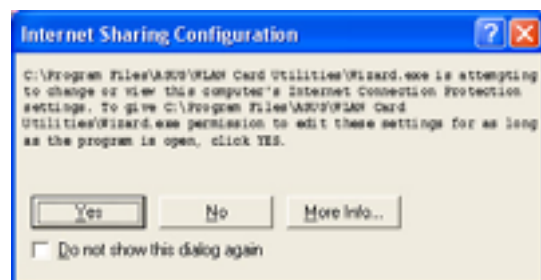

- A warning dialog box appears. Click **OK**.

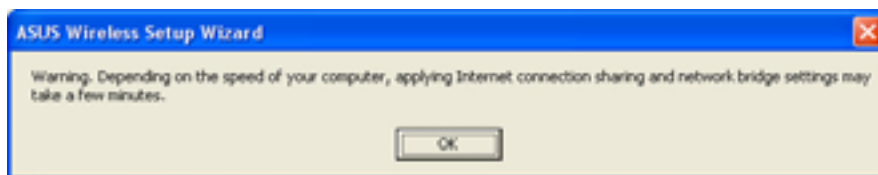

- The wizard displays the wired and wireless network connections to be added in a network bridge based on your configuration. Write down these network connections in a piece of paper. Click **OK**.

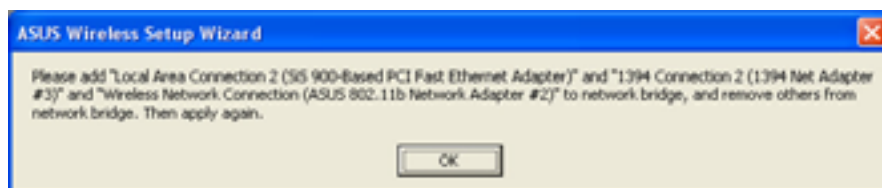

7. The **Network Connections** window appears. Select the network connections to be bridged.

Press the <Ctrl> key while clicking the network connections icons to select multiple connections. Right-click on any selected network icon to open a drop-down menu. Select **Bridge Connections**.

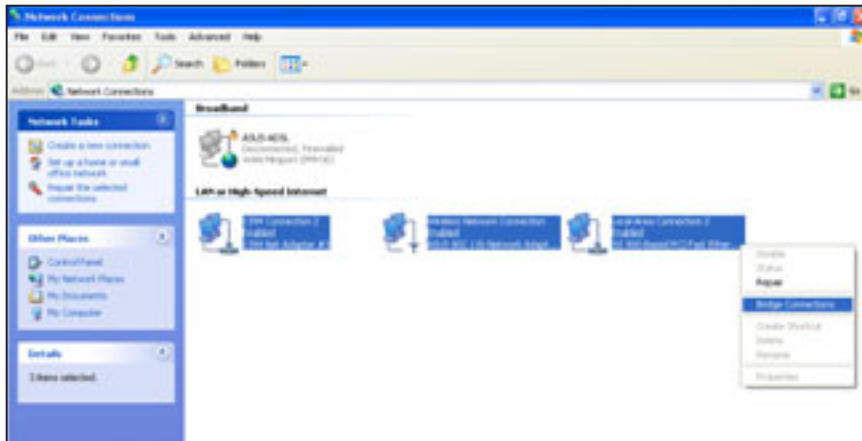

8. The selected network connections are bridged.

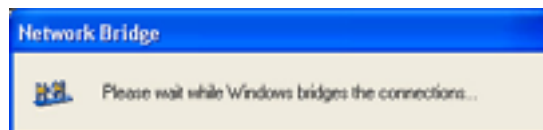

9. The **Network Connections** window displays the bridged network connections.

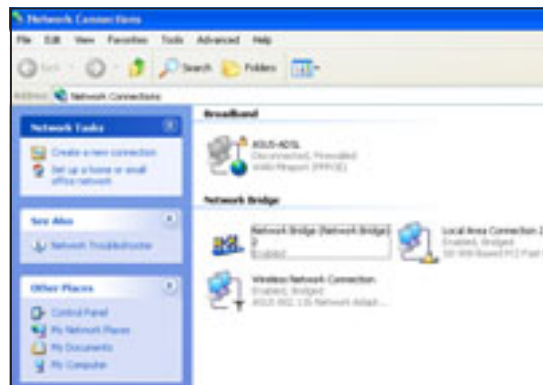

10. Click **Finish** to close the setup wizard.



Refer to Windows® XP Help and Support Center for articles and help files on the Network Bridge function.

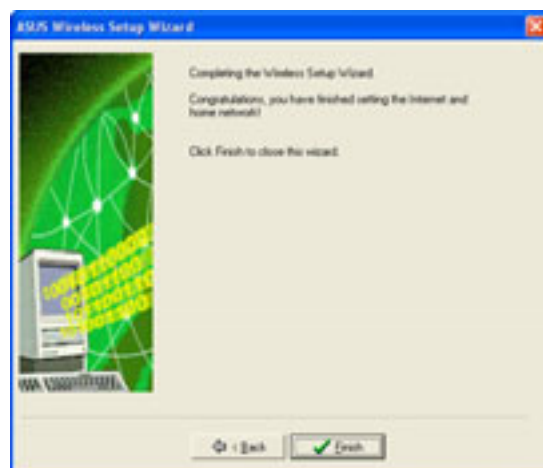

### Direct internet connection

To enable ICS if your computer connects directly to the Internet:

1. Select the number of IP address assigned to you by your Internet Service Provider (ISP).

Click **Next**.



The wizard will instruct you to enable ICS or create a network bridge if you are assigned two or more IP addresses.

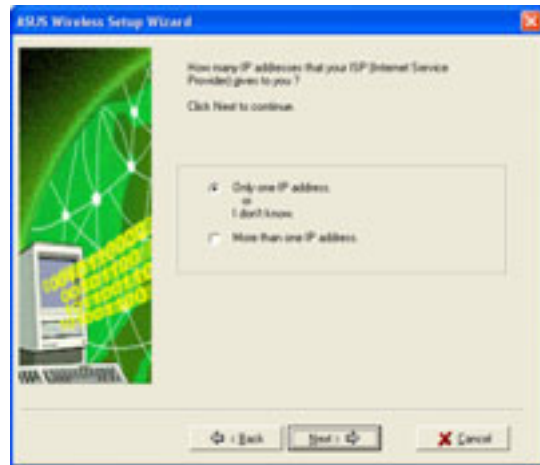

2. The setup wizard automatically selects your broadband network connection. Check **Enable Firewall** to secure your network from unauthorized access.

Click **Next**.

3. Enable ICS following steps 2 to 10 in the section "Internet connection via another computer or residential gateway".

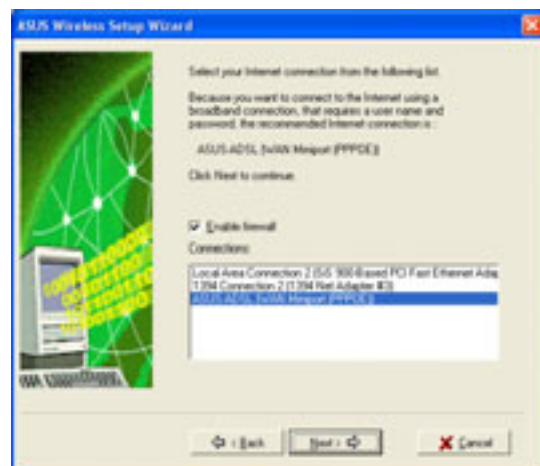

### ***Broadband connection that is always on***

To enable ICS if you have an existing broadband network that is always on (DSL, cable modem, or LAN):

1. Select whether your computer directly connects to the Internet or through another computer or residential gateway.

Click **Next**.



2. If your computer connects to the internet via another computer or residential gateway, follow steps 2 to 10 of the “**Internet connection via another computer or residential gateway**” section on pages 74-76.

Follow the steps in the “**Direct Internet connection**” section on page 77 if your computer directly connects to the Internet.

### ***Dial-up modem***

Follow these instructions to enable ICS if you are using a modem and a regular or ISDN phone line.

1. Select the dial-up connection from the drop-down list.

Click **Next**.



If you do not have a dial-up connection, the wizard will instruct you to create one using the Windows® interface or the support CD from your Internet Service Provider (ISP).

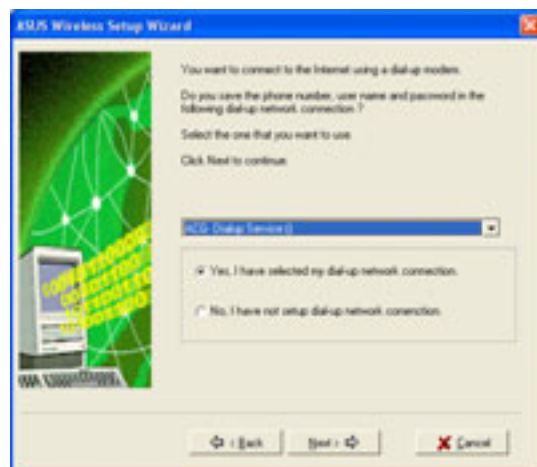

2. Select whether your computer directly connects to the Internet or through another computer or residential gateway. Click **Next**.



3. If your computer connects to the internet via another computer or residential gateway, follow steps 2 to 10 of the “**Internet connection via another computer or residential gateway**” section on pages 74-76.

Follow the steps in the “**Direct Internet connection**” section on page 77 if your computer directly connects to the Internet.

## 4.5.5 The Control Center utility

The Control Center utility is a management software that launches applications and configures network settings. The Control Center













Utility starts automatically when the system boots and displays the Control Center icon in the Windows® taskbar. The Control Center icon serves as an application launcher, and indicator of signal quality and Internet connection.

### Control Center icons



The Control Center icon indicates the quality of link to the access point and connection to the Internet. Refer to the table below for icon indications.

#### Station Mode

##### Infrastructure Network Mode (wireless LAN adapter to an access point)

 Excellent link quality and connected to the Internet	 Excellent link quality but not connected to the Internet
 Good link quality and connected to the Internet	 Good link quality but not connected to the Internet
 Fair link quality and connected to the Internet	 Fair link quality but not connected to the Internet
 Poor link quality but connected to the Internet	 Poor link quality and not connected to the Internet
 Not linked but connected to the Internet	 Not linked and not connected to the Internet

##### Ad-hoc Network Mode (wireless LAN adapter to other Wi-Fi device)

 Linked
 Not Linked
 Connected to the Internet

#### Soft Access Point Mode

 Wireless LAN adapter is in soft access point (Soft AP) mode.
--

### Control Center right-click menu

Right-clicking the Control Center icon displays the right-click menu. The following sections describe the right-click menu items.

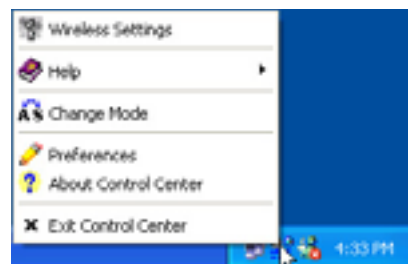

## Wireless LAN Card Settings

The Wireless LAN Card Settings is the main interface that allows you to control the ASUS wireless LAN adapter. Use the Wireless Settings to view the operational and connection status, or to modify the wireless LAN adapter configuration.

The Wireless Settings window is composed of the property window and tabbed property sheets. Click the icons in the property window to display their tabbed property sheets.

### Status - Status Tab

The Status Tab provides general information on the wireless LAN adapter.

**Association State.** This field displays the connection status and MAC address of the network where the system is connected.

**Service Set Identifier (SSID).** This field displays the SSID of the network to which the card is associated or is intending to join. The **SSID** is a group name shared by every member of a wireless network. Only client PCs with the same SSID are allowed to establish a connection.

The **MAC Address** field displays the hardware address of a device connected to a network.

The **Current Channel** field displays the radio channel that the card is currently tuned. The channel changes as wireless LAN adapter scans the available channels. See the Appendix for channel information.

The **Current Data Rate** field displays the data transfer rate between the wireless LAN adapter and the access point.

The **Radio State** field displays the radio communication status. Click the **Disable Radio** button if you wish to disable radio communication with an access point or a Wi-Fi device.





**Rescan** button - Click to allow wireless LAN adapter to scan available wireless networks and to connect to the network with the best signal quality.

**Change SSID** button - Click to change the SSID. Clicking this button opens the Config-Basic window. See “Config-Basic Tab” on the next page.

**Search and Connect** button - Click to view all wireless networks within the range of your system. Clicking this button opens the Site Survey window. See page 86.

### Status - Connection Tab

The Connection Tab provides real-time information on connection throughput, frame errors, signal strength, link quality and overall connection quality in graph representation.



On Soft AP mode, only the Throughput and Frame Error fields appear.

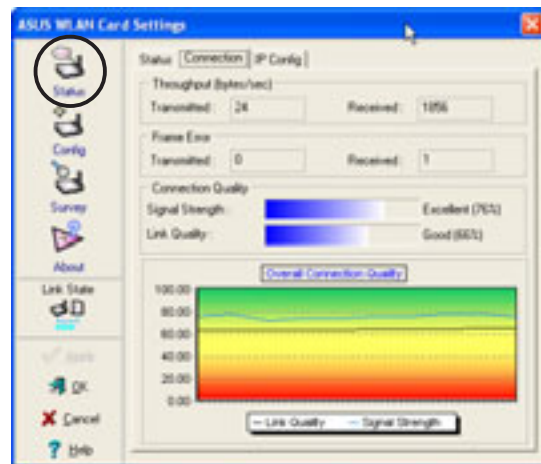

### Status - IP Config Tab

The IP Config tab displays the current host and Ethernet adapter configurations. IP Config displays TCP/IP information including the IP address, subnet mask, default gateway, DNS and Windows Internet Naming Service (WINS) configurations.

Use the IP Config Tab to verify your network settings.



**IP Release.** Click to release the DHCP IP address for the wireless LAN adapter.

**IP Renew.** Click to renew the DHCP IP address for the wireless LAN adapter.

**Ping.** Click to display the Ping tab. Use ping to verify a connection to a particular host name or IP address.



The IP Release and IP Renew buttons may only be used on a DHCP-configured wireless LAN adapter.

### Status - Ping Tab

The Ping tab allows you to verify the connection of the host computer with another computer in the network. To ping a connection:

1. Type the IP address of the connection you want to verify in the **IP Address** field.
2. Configure the ping session by assigning the size and count of packet to send, and the time limit for a ping session to continue (in milliseconds).
3. Click the **Ping** button.



During the ping session, the **Ping** button toggles into a **Stop** button. Click **Stop** anytime to cancel the ping session.

The session field displays information on the verified connection including the roundtrip time (minimum, maximum, and average) and packets sent, received, and lost after a ping session.

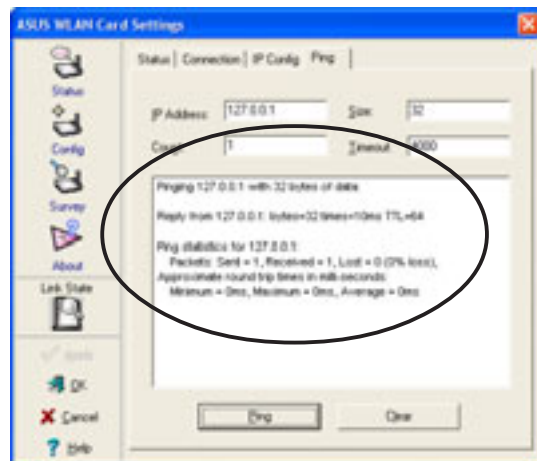

Click the **Clear** button to clear the session field.

### Config - Basic Tab

The **Basic** tab provides general information on network types and other configurations.

**Network Type.** Select the type of network that you wish to use. Select *Infrastructure* mode to establish a connection with an access point (AP). In this mode, your system can access wireless LAN and wired LAN (Ethernet) via the AP. Select the *Ad Hoc* mode to communicate directly with other mobile clients within the wireless LAN adapter range.

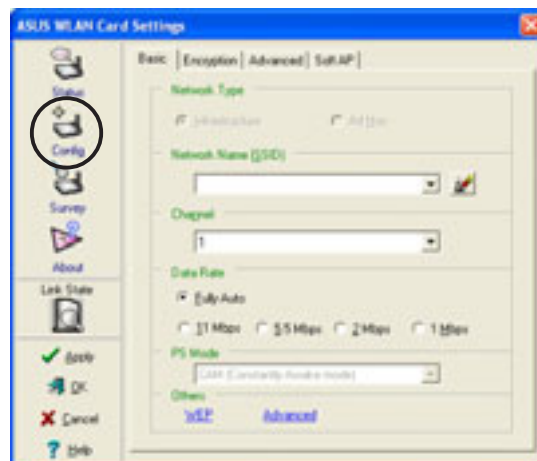

**Network Name** - Displays the network SSID. The network SSID is a string use to identify a wireless LAN. Assign different SSIDs to segment the wireless LAN and increase network security. Set the SSID to a null string to allow your station to connect to any available access point. Null string may not be used in Ad-hoc mode.

**Channel.** In Infrastructure mode, wireless LAN adapter automatically tunes in to the access point channel. In Ad-hoc mode, select a channel that is allowed for use in your country/region. See the Appendix for channel information.

**Data Rate.** Select *Fully Auto* to allow the wireless LAN adapter to adjust to the most suitable connection. You may also fix data transfer rates to 11, 5.5, 2 and 1 Mbps.

**PS Mode.** This field allows control of the wireless LAN adapter power saving features. The *CAM (Constantly Awake mode)* is recommended for systems running on AC power. Other options include *MAX\_PSP (Maximum Power Savings)* and *Fast\_PSP (Fast power-saving mode)*

**Others.** Click the *WEP* or *Advanced* link to open the Encryption or Advanced property tab sheet.

### Config - Encryption Tab

Wireless data transmissions between your wireless LAN adapter and the AP are secured using the Wired Equivalent Privacy (WEP) encryption. Check the *Data encryption (WEP enabled)* option to assign the WEP keys.

Check the *Network Authentication (Shared Mode)* option if you wish to use a network key to authenticate a preferred wireless network.

Unchecking this option allows the network to operate on an Open System mode.

**Key Format** allows you to set a hexadecimal digit or ASCII character WEP key.

**Key Length** allows you to choose a 64-bit or a 128-bit WEP key. A 64-bit encryption contains 10 hexadecimal digits or 5 ASCII characters. A 128-bit encryption contains 26 hexadecimal digits or 13 ASCII characters.

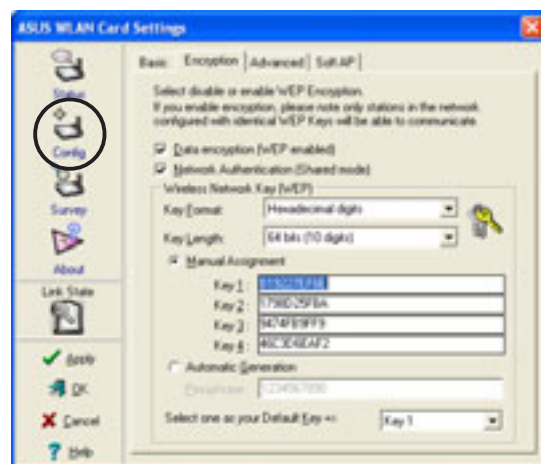



All wireless clients in a network must have identical WEP keys to communicate with each other or with an access point.

## Two ways to assign WEP keys

**Manual Assignment.** For a 64-bit encryption, enter 10 hexadecimal digits (0~9, a~f, A~F) or 5 ASCII characters in each of the four WEP keys. For 128-bit encryption enter 26 hexadecimal digits (0~9, a~f, A~F) or 13 ASCII characters in each of the four WEP keys.

**Automatic Generation.** Type a combination of up to 64 letters, numbers, or symbols in the Passphrase field. The Wireless Settings utility uses an algorithm to generate four WEP keys based on the typed combination.



- 64-bit and 40-bit WEP keys use the same encryption method and can interoperate on wireless networks. This lower level of WEP encryption uses a 40-bit (10 hexadecimal digits assigned by the user) secret key and a 24-bit Initialization Vector assigned by the wireless LAN adapter. 104-bit and 128-bit WEP keys use the same encryption method.
- After assigning the WEP keys, click **APPLY** to save and activate the encryption. Manually assigned encryptions are more secure than automatically generated encryptions.
- Use Manual Assignment instead of Automatic Generation if you are not sure whether other wireless clients use the same algorithm as that of wireless LAN adapter.
- Keep a record of the WEP encryption keys.

### Config - Advanced

The **Advanced** tab displays the wireless LAN adapter advanced settings. We recommended that you keep the default settings.

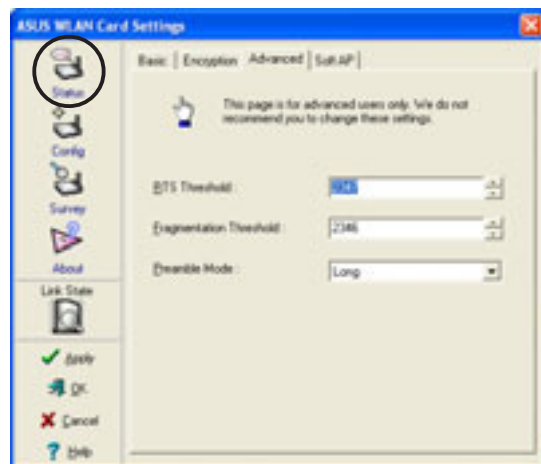

## Config - Soft AP

The **Soft AP** tab displays the Internet Connection Sharing (ICS) and bridge features of the wireless LAN adapter.



The Soft AP tab appears only on systems running on Windows® XP.



**SoftAP/STA Mode.** This field allows you to select the wireless LAN adapter mode. Select Station Mode if you wish to connect to an access point or to other wireless devices (Ad-hoc mode). Select Soft AP Mode to configure your computer as a soft access point. Fields in the network diagram are enabled when Soft AP mode is selected.

**Enable ICS.** This option activates after an available network connection is placed in the Internet field. Check this option if you want to share a single Internet connection with other computers in a wireless network. See page 95 for details. When disabled, the available Internet connection is bridged with the wireless LAN adapter. Refer to page 99 to setup a network bridge.

**Enable Firewall.** This option is active when ICS is enabled. Check this item to activate the firewall and prevent unauthorized access to your home or small office network.

### Available Network Connections.

This field displays all available network connections in the host computer. To enable Internet Connection Sharing (ICS), drag the network connection to the Internet box, then click **Apply**.



See “Soft Access Point (Soft AP) Mode” section on page 92 for details.

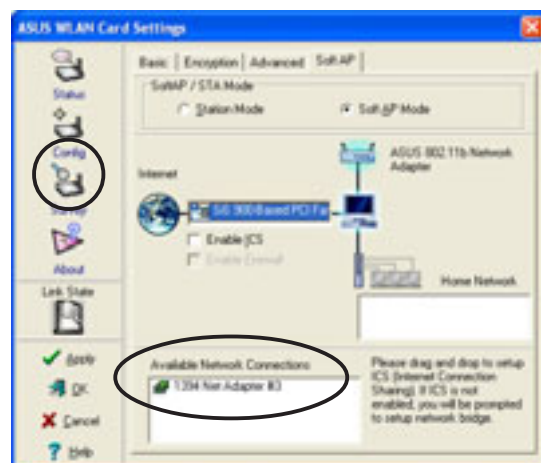

### Site Survey

The **Site Survey** window displays the available networks within the wireless LAN adapter range and the following network settings:

**BSSID** - The IEEE MAC address of the available wireless networks.

**SSID** - SSID (service set identifier) of the network.

**CH** - Direct sequence channel used by the network.

**RSSI** - Received Signal Strength Indicator (RSSI) in dBm.

**Type** - wireless network mode. AP indicates an Infrastructure network type. STA indicates an Ad-hoc network type.

**WEP** - shows whether a network has an enabled (On) or disabled (Off) WEP encryption.

Select an available network and click **Connect** to establish connection. Click **Search** to rescan available networks.

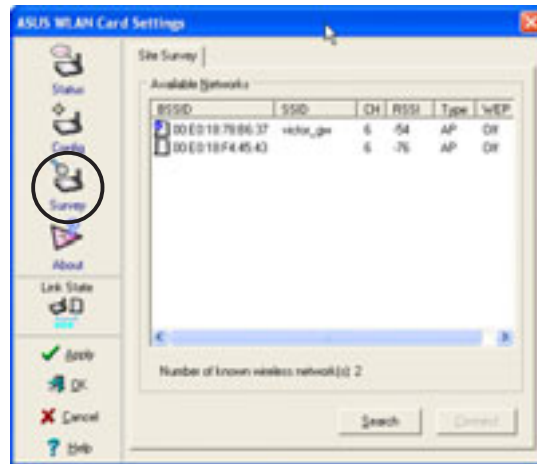

### About

Click the **About** icon to view the software version, driver version, and copyright information.

### Link State

Displays the current connection status of the wireless LAN adapter to the AP or to other Wi-Fi devices. An icon represents the Link State for easy identification. Refer to the table below for icon indications.

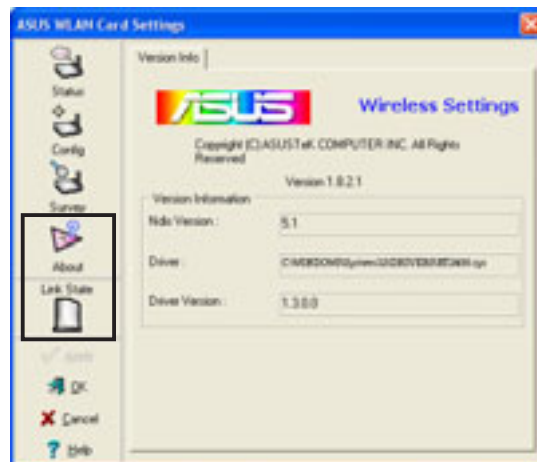

### **Table of Icon Indications**

	Excellent link quality (Infrastructure)		Not linked (Infrastructure)
	Good link quality (Infrastructure)		Linked (Ad-hoc)
	Fair link quality (Infrastructure)		Not linked (Ad-hoc)
	Poor link quality (Infrastructure)		

### Command icons

**Apply.** Click to apply the changes made on wireless LAN adapter configuration and settings.

**OK.** Click to close the Wireless Settings utility window.

**Cancel.** Click to cancel any changes made on wireless LAN adapter configuration or settings. Clicking Cancel closes the Wireless Settings utility window.

**Help.** Click to display the help menu.

### **Help Menu**

The Control Center utility has a Help menu to guide you in using the Control Center and Wireless Settings utilities.

Right-click the Control Center icon, then select **Help**. Select the utility you wish to view the help files.

### **Change Mode**

The Change Mode menu allows you to set the wireless LAN adapter in a Station (STA) or soft Access Point (AP) mode.



See “**Soft Access Point (Soft AP) Mode**” on page 92 for details on the wireless LAN adapter soft AP function.

### **Preferences**

The **Preferences** window allows you to customize the Control Center Utility settings.

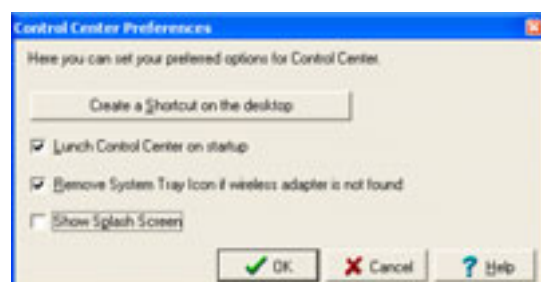
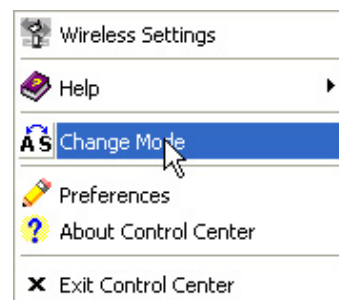
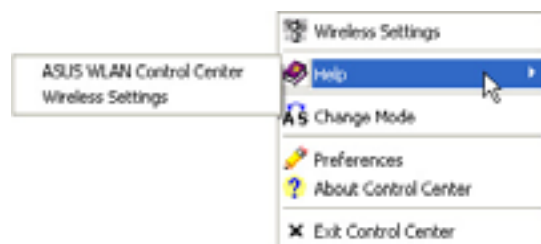
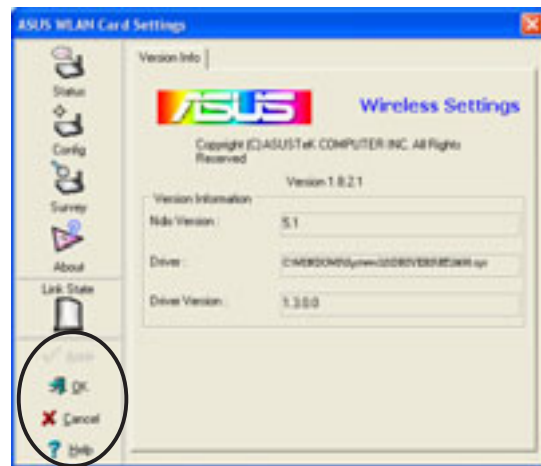

## About Control Center

The **About Control Center** menu displays the software copyright and version information.



## Control Center left-click menu

Left-clicking the Control Center icon displays the left-click Menu. The options are described below.

**Wireless Radio On** – Turns the wireless LAN adapter radio ON.

**Wireless Radio Off** – Turns the wireless LAN adapter radio OFF.

**Search & Connect** – View available wireless networks within range.

**Wireless Option** – Sets your Windows® XP wireless networking environment. See page 65 for details.

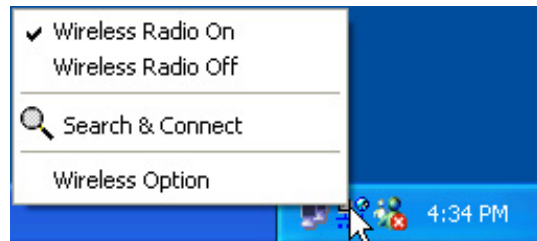

---

The Control Center left-click menu is available only when wireless LAN adapter is set to Station Mode (STA).

---



## 4.5.6 Configuring the wireless LAN adapter by Wireless Settings utility

The Wireless Settings utility allows you to set your wireless LAN adapter in Station (STA) or Soft Access Point (Soft AP) mode. In STA mode, your wireless LAN adapter connects to an access point to access a wireless network or the Internet. In Soft AP mode, your wireless LAN adapter transmits and receives signals to and from other Wi-Fi devices in a wireless network. The Soft AP feature is available only on systems running on Windows® XP.

### Station Mode (STA)

Follow these instructions to set your wireless LAN adapter in Station (STA) mode.

#### Windows® 98SE/ME/2000 OS

1. Launch the Wireless Settings utility by double-clicking the **Control Center** icon in the Windows taskbar.
2. Click the **Survey** icon from the property window to display the available access points or other Wi-Fi device.
3. Select the AP with the best signal quality by referring to the RSSI column. The higher the RSSI, the better the signal quality.
4. Click the **Config** icon, then select the **Basic** tab to configure your network. Select **Infrastructure**, then click **Apply**.



5. Set the wireless LAN adapter Network Name (SSID). The wireless LAN adapter SSID must be identical with the SSID of the selected AP.



Setting the SSID to a null string allows your wireless LAN adapter to connect to any available access point.

6. Click the **Encryption** tab to set the wireless LAN adapter encryption if the selected AP has an enabled WEP encryption.

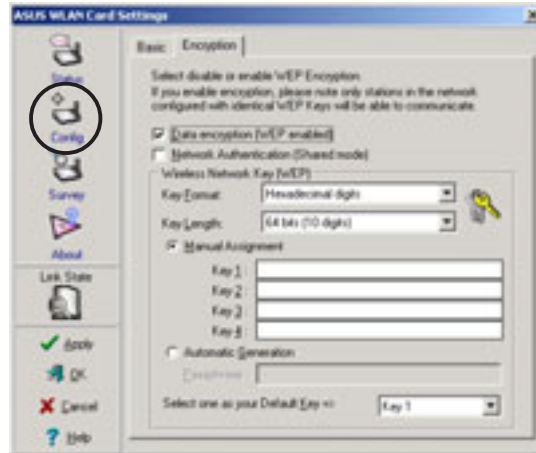

Refer to the **Site Survey** window to determine whether the selected AP has an enabled (ON) or disabled (OFF) WEP encryption. Refer to page 83 on how to configure WEP encryptions.

7. To check if wireless LAN adapter is associated with the selected AP, click the **Status** icon in the property window, then select the **Status** tab. Look for the Associated State field to confirm.

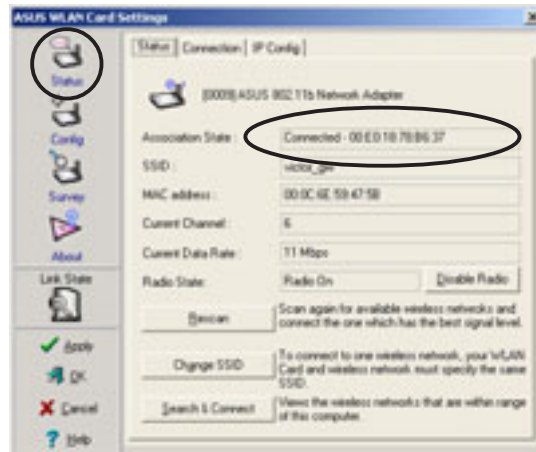

## Windows® XP OS

Do any of the following to set your wireless LAN adapter in station mode.

### Enter the Wireless Settings utility

1. Double-click the **Control Center** icon in the Windows taskbar to open the Wireless Settings utility.
2. Click the **Config** icon in the property window, then select the **Soft AP** tab. Select **Station Mode**.

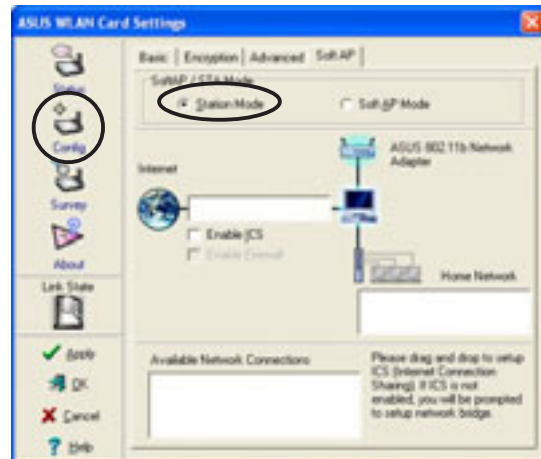

3. The following confirmation dialog box appears when you switch from Soft AP mode to Station Mode. Click **Yes**.
4. Follow steps 2 to 7 of the previous section to set the wireless LAN adapter in STA mode.

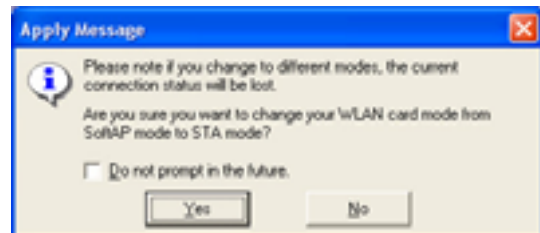

### Use the Change Mode menu

1. Right-click the **Control Center** icon in the Windows taskbar to display the right-click menus. Select **Change Mode**.
2. Select **Station Mode** when the Change Mode window appears. Click **OK**.
3. Follow steps 2 to 7 of the previous section to set the wireless LAN adapter in STA mode.

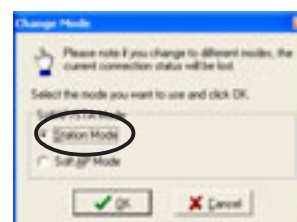
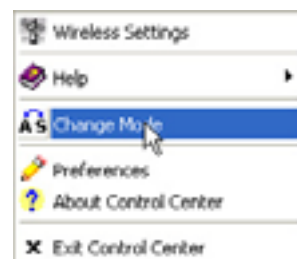

## Soft Access Point Mode (Soft AP)

You may set the wireless LAN adapter card in soft access point mode. In soft AP, wireless LAN adapter can support up to 31 wireless clients in a home or small office network.

### System requirements

Before setting your wireless LAN adapter as soft AP, make sure your system meets the following requirements:

- Windows® XP operating system

Wireless clients in home or small office network must have:

- An installed IEEE 802.11b compliant network interface card
- Windows® 98SE/ME/2000/XP operating system

### Setting your wireless LAN adapter in Soft AP mode

Do any of the following to set your wireless LAN adapter in soft AP mode:

#### Enter the Wireless Settings utility

1. Double-click the **Control Center** icon in the Windows taskbar to open the Wireless Settings utility.



2. Click the **Config** icon in the property window of the Wireless Settings utility, then select the **Soft AP** tab. Select **Soft AP Mode**, then click **Apply**.

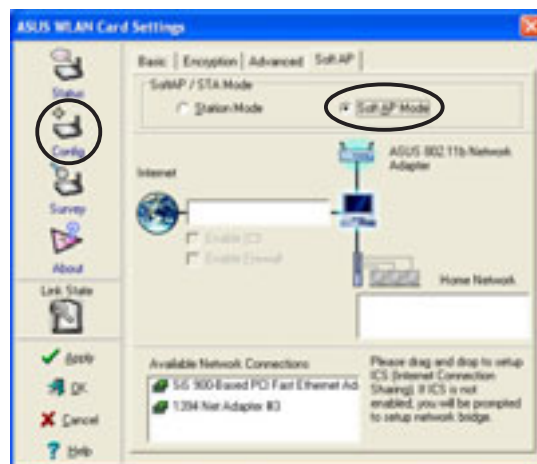

3. A confirmation window appears click **Yes**.



### Use the Change Mode menu

1. Right-click the **Control Center** icon in the Windows taskbar to display the right-click menus. Select **Change Mode**.
2. Select **Soft AP Mode** when the Change Mode window appears. Click **OK**.
3. The Soft AP icon replaces the Control Center utility icon in the Windows® taskbar.

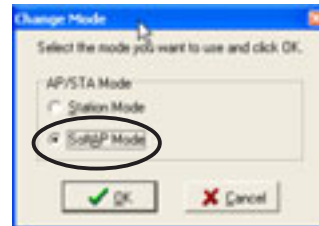
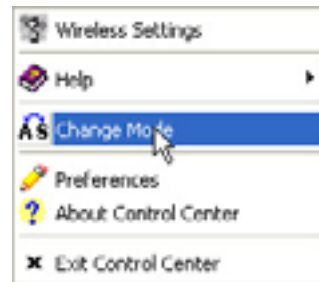

## Other Soft AP settings

When in Soft AP mode, two additional tabbed property sheets are added to the **Status** settings of the Wireless Settings utility.

### MAC Table

The **MAC Table** tab displays the MAC address of a wireless device connected to the soft AP.

**AID** - shows the Association ID of a wireless device connected to the soft AP.

**Power Saving Mode** - displays the Power Saving Mode used by the wireless device connected to the soft AP.

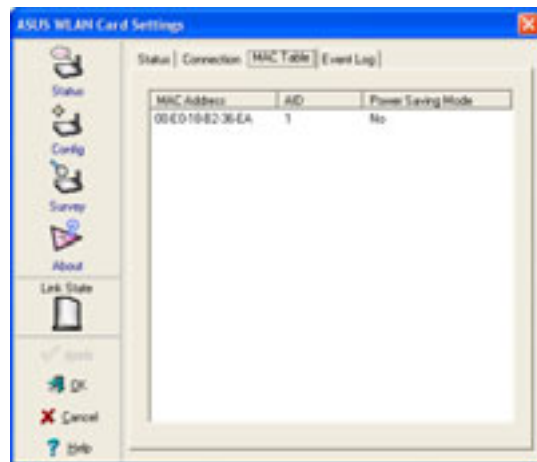

### Event Log

The **Event Log** tab displays detected system events including the date and time of the event and event type. Click **Clear Log** to clear the event log window.

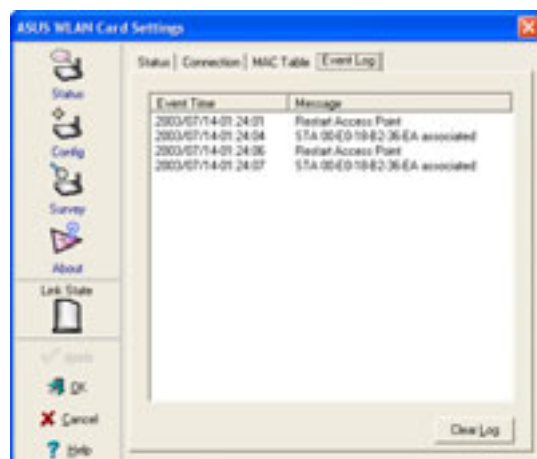

## Internet Connection Sharing (ICS)

ICS is a Windows® XP feature allowing several computers in a wired or wireless network to share a single Internet connection. With ICS, other wireless clients in a home or small office network rely on the wireless LAN adapter for Internet access. Enable Internet Connection Sharing (ICS) after setting the wireless LAN adapter on Soft AP mode.

### ***Connect to the Internet using a broadband connection that is always on***

To enable ICS if your computer connects to the Internet using a broadband that is always on:

1. Open the Wireless Settings utility. Select **Config** from the property window, then select the **Soft AP** tab.
2. Select the built-in 3Com Gigabit LAN connection from the **Available Network Connections** field, then drag it to the **Internet** field.
3. Check **Enable ICS** and **Enable Firewall**, then click **Apply**.
4. Click **OK** when this dialog box appears.
5. An **Internet Sharing Configuration** dialog box appears. Click **Yes**. The Internet network connection and the wireless LAN adapter is bridged. See “**Network Bridge**” section on page 99 for details.

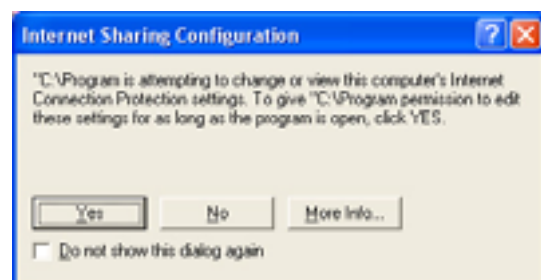
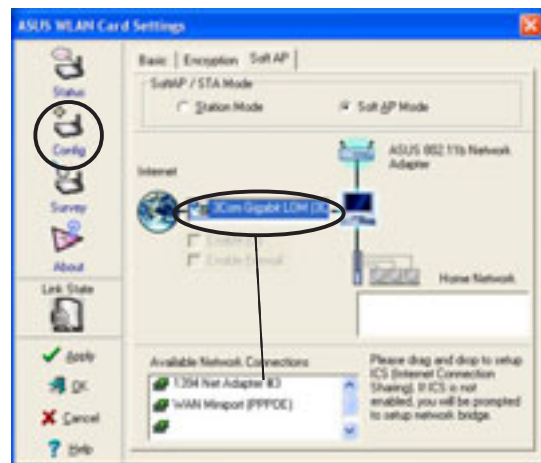

Wireless clients must be set to Infrastructure network type and STA (station) mode to connect to the Internet via the soft AP. The SSID and WEP keys of client computers must be identical with that of the soft AP.

## ***Connect to the Internet using a broadband or a dial-up connection that requires an account***

If the host computer with the wireless LAN adapter connects to the Internet using a broadband or dial-up connection that requires an account, create a broadband (PPPoE) or dial-up network connection using the Windows® XP interface before enabling ICS.

To create a broadband connection:

1. Open the Network Connections window by clicking **Start > Connect To > Show all connections** from the Windows® desktop.
2. Click **File** from the menu, then select **New Connection**.
3. A **New Connection Wizard** appears. Click **Next**.
4. When prompted, select the Network connection type. Select **Connect to the Internet**, then click **Next**.

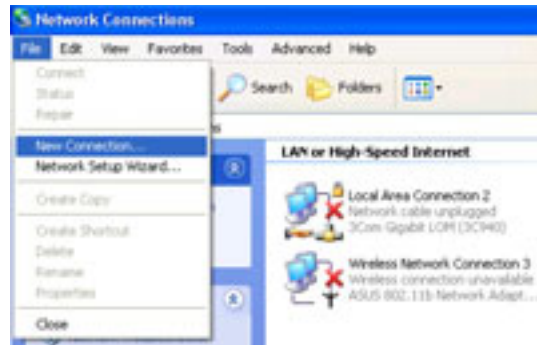



5. Select **Set up my connection manually**, then click **Next**.



6. Depending on your network setup, select **Connect using a broadband connection that requires a user name and password** or **Connect using a dial-up modem**, then click **Next**.

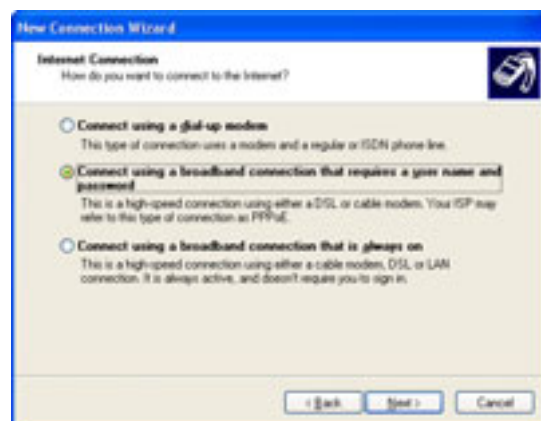

7. Enter the ISP name, then click **Next**.



8. Enter the user name and password assigned by your ISP, then check all settings below the user name and password fields. Click **Next**.



9. Click **Finish** when the wizard completes creating the connection.



10. The **Network Connections** window displays the created connection. Return to the **Wireless Settings** utility. Select the created connection from the Available Network Connections, then drag it to the Internet field. Refer to the steps on page 95 to enable ICS.

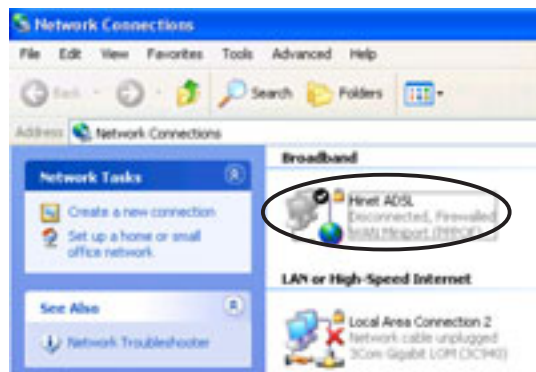

## Network Bridge

Host computers with multiple network adapters may use the network bridge function to connect several LAN segments. A LAN segment is a physical connection between a host computer and a client computer. Network bridging is a cost-effective method of connecting LAN segments since it does not require expensive hardware such as routers and technical expertise for configuring Internet protocol (IP) addresses. Network bridge is essential in enabling ICS among wireless clients in a home network.



You must have Administrator privileges before you can create a network bridge.

To bridge a wired network connection to the wireless LAN adapter:

1. Open the Wireless Settings utility. Select **Config** from the property window, then select the **Soft AP** tab.
2. Select a network connection from the Available Network Connections box, then drag the connection to the Internet field. Click **Apply**.

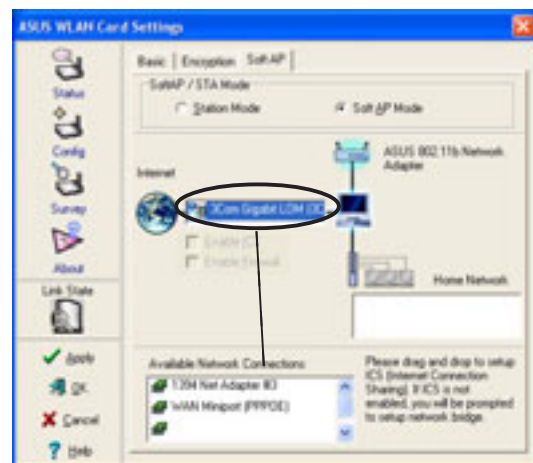

3. A warning message appears. Click **OK**.

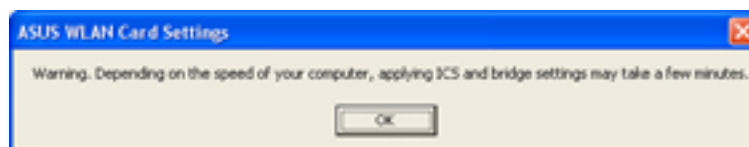

4. The Wireless Settings utility displays the wired and wireless network connections to be added in a network bridge based on your configuration. Write down these network connections in a piece of paper and keep it in a safe place. Click **OK**.

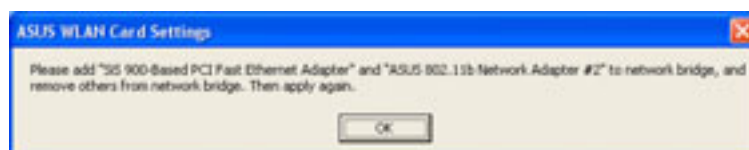

5. Select the network connections to be bridged. Press the Control key while clicking the network connection icons to select. Right-click on any selected network icon to open a drop-down menu. Select **Bridge Connections**.

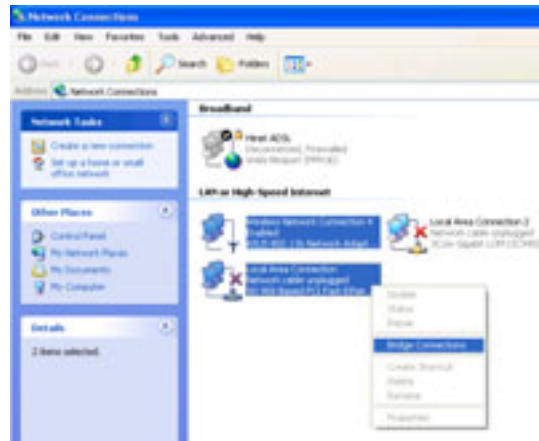

6. Wait while the selected network connections are bridged.

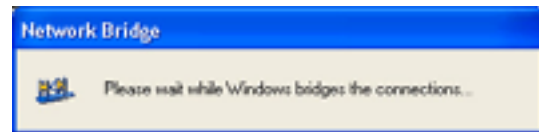

7. The **Network Connections** window displays the bridged network connections.

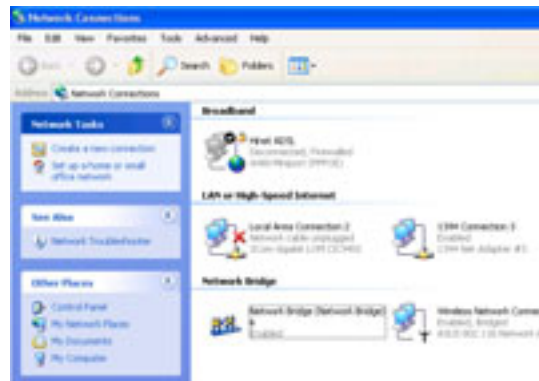

Only LAN connections may be bridged with the wireless LAN adapter. The Wireless Settings utility will instruct you to change your settings if you bridge a non-LAN connection with the wireless LAN adapter.

## Appendix

- ▶ The appendix includes information on the DiGiMatrix remote controller and the optional Subsystem. This part also includes the DVD-RW/DVD-ROM/CD-RW technical specifications and the available wireless LAN adapter channels.

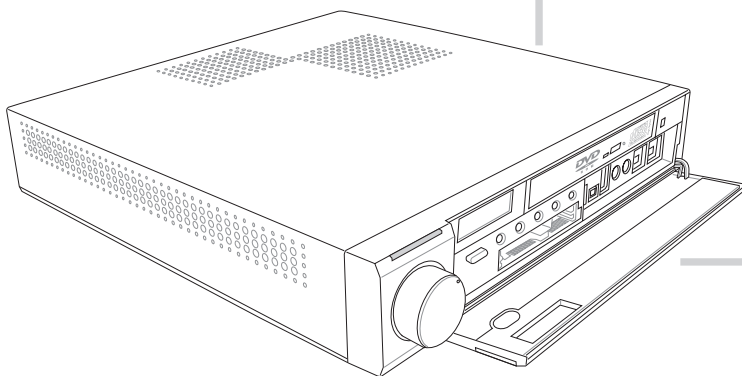

digital **entertainment PC**

# A.1 Subsystem

The Subsystem is designed to provide additional storage and an extra optical drive to the DiGiMatrix.

The Subsystem package includes the following:

- CD-RW drive
- IDE cable
- DC power cable

The following sections describe the Subsystem features, installation, and connection to the DiGiMatrix system.

---

The Subsystem is purchased separately.

---

## A.1.1 Front and rear panel features

### Front panel

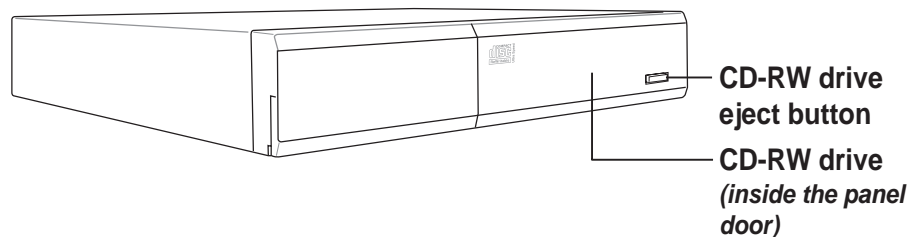

### Rear panel

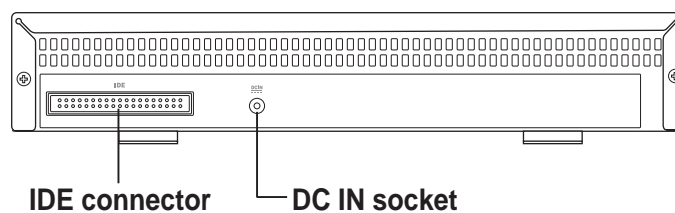

## A.1.2 Removing the top cover

To remove the top cover:

1. On the Subsystem rear panel, locate the two screws that secure the top cover to the chassis.

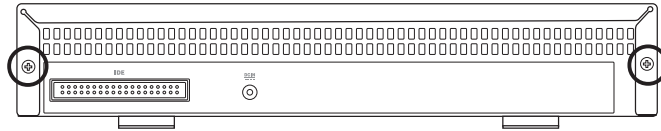

2. Use a Phillips (cross) screw driver to remove the top cover screws. Keep the screws for later use.
3. Pull the top cover slightly toward the rear panel until the side tabs are disengaged from the chassis.
4. Hold the center edge of the top cover, then lift it up from the chassis. Set the top cover aside.

## A.1.3 Installing a hard disk drive



Set your hard disk drive as Slave device before connecting the IDE cable and power plug. Refer to the HDD documentation on how to set the drive as a slave device.

To install a hard disk drive:

1. Connect the 40-pin IDE cable to the IDE connector on the drive.
2. Connect the 4-pin power plug to the HDD power connector.
3. Place the drive on the tray.
4. Secure the drive with two side screws.
5. Replace the top cover.

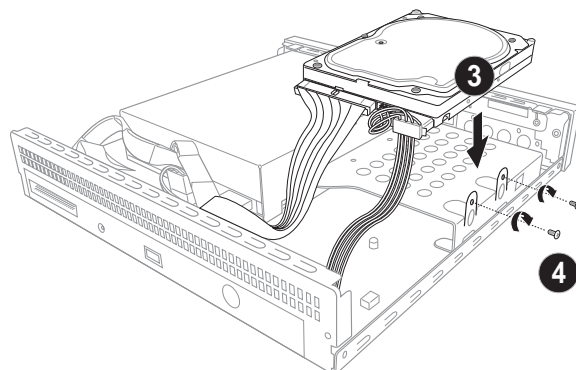
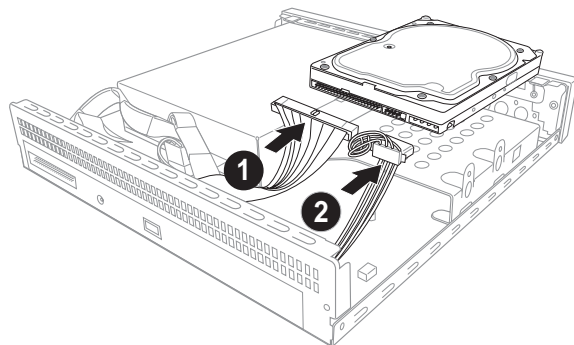

## A.1.4 Connecting the Subsystem to DiGiMatrix

Follow these instructions to connect the Subsystem to the DiGiMatrix.

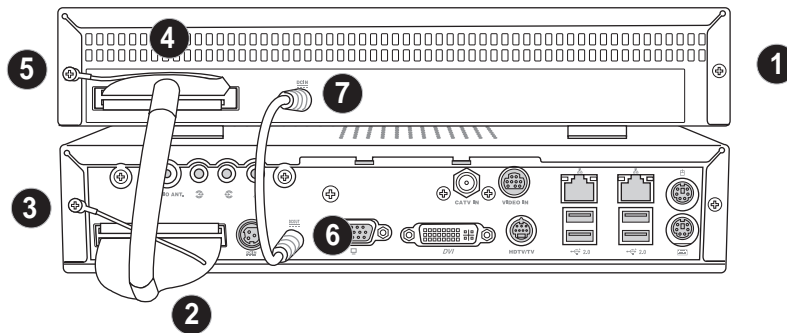

1. Place the Subsystem on top of the DiGiMatrix.
2. Connect one end of the IDE cable to the DiGiMatrix IDE connector.
3. Loosen one top cover screw on the DiGiMatrix, then insert the IDE cable ground terminal into the screw. Tighten the screw.
4. Connect the other end of the IDE cable to the Subsystem IDE connector.
5. Loosen one top cover screw on the Subsystem, then insert the IDE cable ground terminal into the screw. Tighten the screw.
6. Connect one end of the DC power cable to the DiGiMatrix DC OUT socket.
7. Connect the other end of the DC power cable to the Subsystem DC IN socket.



## A.2 DiGiMatrix remote controller

The DiGiMatrix remote controller allows you to control DiGiMatrix from a distance. Use the remote controller to navigate through the Audio DJ and ASUS Home Theater windows.







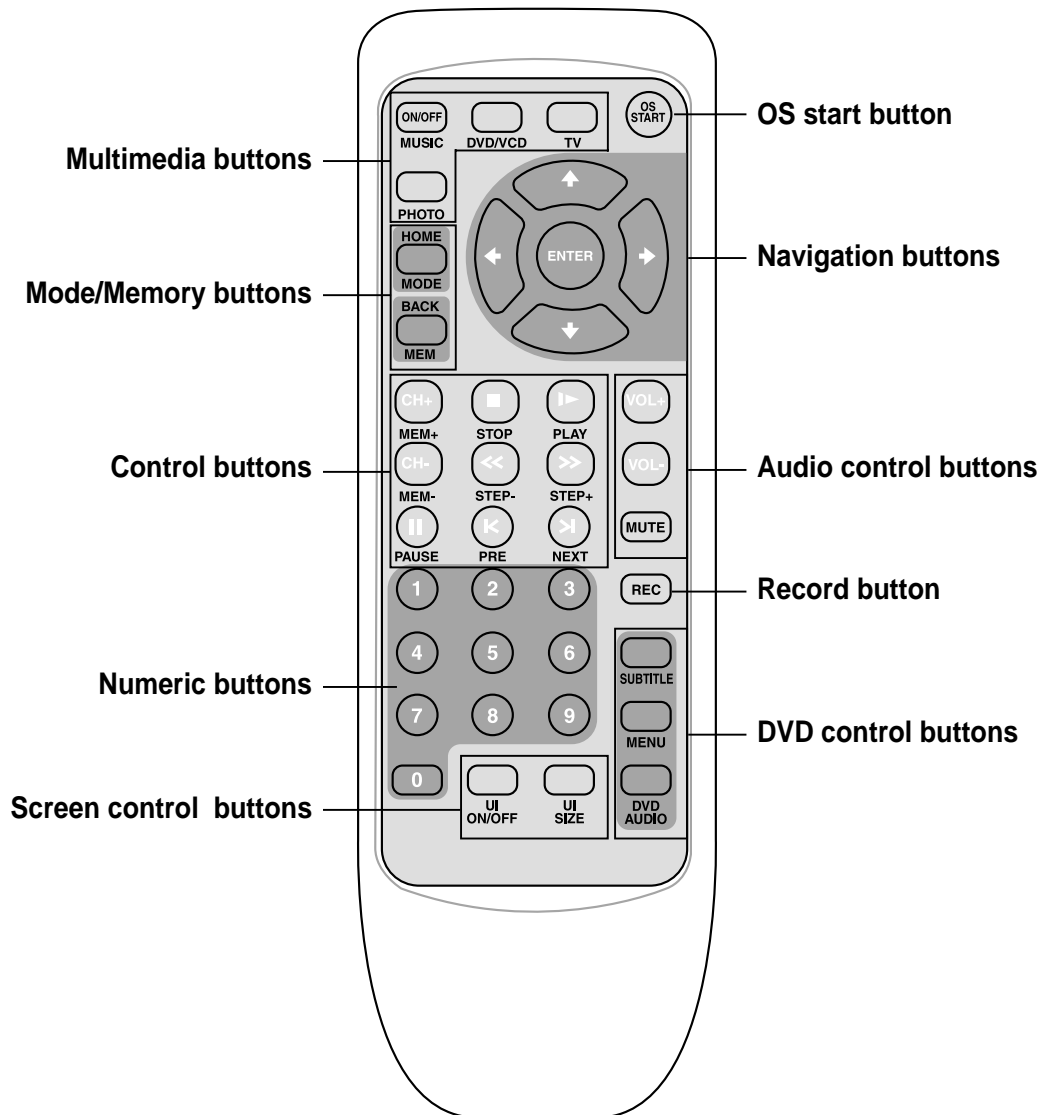









### A.2.1 Specifications

Operating range	5 meters (max)
Power Source	2 x "AA" batteries
Receiver	Built-in infrared receiver

### A.2.2 Remote control layout















## A.2.3 Remote control functions in Audio DJ

Buttons	CD/DVD	Hard Disk	FM Radio
	Turns the Audio DJ system on		
	—	—	To next radio preset
	—	—	To previous radio preset
	Pause	Pause	—
	Stop	Stop	—
	Play	Play	Scan frequency
	Rewind	Rewind	Fine tuning (-)
	Fast forward	Fast forward	Fine tuning (+)
	Skip to next track	Skip to next MP3 file	Scan the frequency up
	Skip to previous track	Skip to previous MP3 file	Scan the frequency down
	Volume up	Volume up	Volume up
	Volume down	Volume down	Volume down
	Mute	Mute	Mute
	Switch mode	Switch mode	Switch mode
	—	—	Select radio preset
0 ~ 9	Select track number	Select track number	—
	Confirm selected track	Confirm selected track	—
	Turns the DiGiMatrix operating system on		

















You may turn on the operating system using the OS START () button only when DiGiMatrix is in Audio DJ mode.

In soft-off state, the remote controller  can turn on or off the Audio DJ feature.

## A.2.4 Remote control functions in Home Theater

Button	ASUS Home Theater						
	TV	Radio	Music	Pictures	Video Clips	DVD	
	—	—	Open Music mode	—	—	—	
	—	—	—	—	—	Open DVD/VCD mode	
	Open TV mode	—	—	—	—	—	
	—	—	—	Open Pictures mode	—	—	
	Channel up	Next preset station	—	—	—	—	
	Channel down	Previous preset station	—	—	—	—	
	Pause + Record TV	—	Pause	Pause slideshow	Pause	Pause	
	Stop recording	—	Stop	Stop slideshow	Stop	Stop	
	Play recorded TV	—	Play	Start slideshow	Stop	Stop	
	—	Fine tuning (-)	Change ambience	—	Rewind	Rewind	
	—	Fine tuning (+)	Change ambience	—	Fast forward	Fast forward	
	—	Scan frequency down	Previous track	Previous pic	—	Previous chap	
	—	Scan frequency up	Next track	Next pic	—	Next chap	
	Volume up	Volume up	Volume up	Volume up	Volume up	Volume up	
	Volume down	Volume down	Volume down	Volume down	Volume down	Volume down	

You may use the OS START () button to wake up the DiGiMatrix system from S4 mode (suspend-to-disk/hibernate).

Button	ASUS Home Theater					
	TV	Radio	Music	Pictures	Video Clips	DVD
	Mute	Mute	Mute	Mute	Mute	Mute
	Record	Record	—	—	—	—
	—	—	—	—	—	Change subtitle
	—	—	—	—	—	Show menu
	—	—	—	—	—	Select audio language
	Open/Close Home Theater					
	Full screen	—	—	Full screen	Full screen	Full screen
	Move right	Move right	Move right	Move right	Move right	Move right
	Move left	Move left	Move left	Move left	Move left	Move left
	Move up	Move up	Move up	Move up	Move up	Move up
	Move down	Move down	Move down	Move down	Move down	Move down
	Enter	Enter	Enter	Enter	Enter	Enter
0 - 9	Select channel	—	Select track	—	—	Select chapter
 	Open Home Theater / Return to the Home Theater main window					
 	Return to the entertainment mode main window					

## A.3 Optical drive technical specifications

Specification	DVD-ROM/CD-RW Combination Drive	DVD-ROM Drive
<b>Write Speed</b> CD-R CD-RW	24X PCAV 12X PCAV	— —
<b>Read Speed</b> DVD-ROM DVD-ROM Dual Layer CD-R CD-RW	8X CAV 5X CAV 24X CAV 24X CAV	8X CAV — 24X CAV —
<b>Random Access Time</b> DVD-ROM CD-ROM	120ms 100ms	100 ms 90ms
<b>Burst</b> PIO Mode MultiWord DMA Ultra DMA	16.6MB/s 16.6MB/s 33.3MB/s	16.6MB/s 16.6MB/s 33.3MB/s
<b>Interface</b>	ATAPI (EIDE)	IDE/ATAPI
<b>MTBF</b>	60,000 POH	60,000 POH
<b>Buffer Memory Size</b>	2MB	512KB
<b>Disk Size</b>	12cm / 8cm	12cm / 8cm

## A.4 Wireless LAN adapter channels

The IEEE 802.11b standard for Wireless LAN allocated the 2.4 GHz frequency band into 14 overlapping operating **channels**. Each channel corresponds to a different set of frequencies. The table below shows the center frequencies of each channel.

Channel	Center Frequency	Channel	Center Frequency
1	2.412 GHz	8	2.447 GHz
2	2.417 GHz	9	2.452 GHz
3	2.422 GHz	10	2.457 GHz
4	2.427 GHz	11	2.462 GHz
5	2.432 GHz	12	2.467 GHz
6	2.437 GHz	13	2.472 GHz
7	2.442 GHz	14	2.484 GHz



If several Wi-Fi devices are operating in the same vicinity, the distance between the center frequencies of channels used must be at least 25MHz to avoid interference.

The number of channels available for the wireless LAN adapter varies by country/region. Refer to the table below to determine the number of channels available in your location.

Country/Region (Regulating Body)	Available Channels
Australia (ACA)	Channels 1 to 13
Belgium (RTT&E/EMC/LVD)	Channels 1 to 13
Bulgaria (RTT&E/EMC/LVD)	Channels 1 to 13
Canada (CSA/cUL 950 3rd Edition)	Channels 1 to 11
China (MII)	Channels 1 to 11
Cyprus (RTT&E/EMC/LVD)	Channels 1 to 13
Czech Republic (RTT&E/EMC/LVD)	Channels 1 to 13
Denmark (RTT&E/EMC/LVD)	Channels 1 to 13
Finland (RTT&E/EMC/LVD)	Channels 1 to 13
France (RTT&E/EMC/LVD)	Channels 1 to 13
Germany (RTT&E/EMC/LVD)	Channels 1 to 13
Greece (RTT&E/EMC/LVD)	Channels 1 to 13
Hong Kong (OFTA)	Channels 1 to 13
Hungary (RTT&E/EMC/LVD)	Channels 1 to 13
Iceland (RTT&E/EMC/LVD)	Channels 1 to 13

*(continued next page)*

Country/Region (Regulating Body)	Available Channels
Ireland (RTT&E/EMC/LVD)	Channels 1 to 13
Italy (RTT&E/EMC/LVD)	Channels 1 to 13
Japan (TELEC)	Channels 1 to 14*
Luxembourg (RTT&E/EMC/LVD)	Channels 1 to 13
Malaysia (SIRIM/CMC)	Channels 1 to 13
Mexico	Channels 9 to 11
Netherlands Antilles (RTT&E/EMC/LVD)	Channels 1 to 13
Netherlands/Holland (RTT&E/EMC/LVD)	Channels 1 to 13
New Zealand (PTC)	Channels 1 to 13
Norway (RTT&E/EMC/LVD)	Channels 1 to 13
Portugal (RTT&E/EMC/LVD)	Channels 1 to 13
Saudi Arabia	Channels 1 to 13
Singapore	Channels 1 to 13
South Korea (KS)	Channels 1 to 13
Spain (RTT&E/EMC/LVD)	Channels 1 to 13
Sweden (RTT&E/EMC/LVD)	Channels 1 to 13
Switzerland (RTT&E/EMC/LVD)	Channels 1 to 13
Taiwan (DGT)	Channels 1 to 11
Turkey (TTAS)	Channels 1 to 13
United Kingdom (RTT&E/EMC/LVD)	Channels 1 to 13
United States (FCC)	Channels 1 to 11

*\*Channel 14 only allows 1 to 2 Mbps data transmission rate.*



Channels 1, 6 and 11 are independent and do not overlap each other. We recommended that you tune your wireless LAN adapter to these channels.





## Free Manuals Download Website

<http://myh66.com>

<http://usermanuals.us>

<http://www.somanuals.com>

<http://www.4manuals.cc>

<http://www.manual-lib.com>

<http://www.404manual.com>

<http://www.luxmanual.com>

<http://aubethermostatmanual.com>

Golf course search by state

<http://golfingnear.com>

Email search by domain

<http://emailbydomain.com>

Auto manuals search

<http://auto.somanuals.com>

TV manuals search

<http://tv.somanuals.com>