

INSTALLATION

This thermostat has been designed to control a RESISTIVE load not exceeding 3500 W @ 240 VAC or 1750 W @ 120 VAC, such as electric baseboards, convectors, radiant ceilings, floor heating systems, etc.

It is not compatible with a low voltage controller used by a central heating system or systems using a contactor or a relay whose current is under 2 A.

⚠️ TURN OFF POWER TO THE HEATING SYSTEM AT THE MAIN POWER PANEL TO AVOID ELECTRICAL SHOCK. Installation should be carried out by an electrician.

This thermostat is designed to be used with a self-protected heating system equipped with linear limit control and circuit breaker.

- ▶ For a new installation, choose a location about 5 ft. (1.5 m) above the floor, facing the heating system and on an inside wall.
- ▶ Avoid locations where there are air drafts (top of staircase, air outlet), dead air spots (behind a door), direct sunlight or concealed chimneys or stove pipes.
- ▶ All cables and connections must conform to the local electrical code.
- ▶ Special CO/ALR solderless connectors must be used when connecting with aluminum conductors.
- ▶ The wires are not polarized, therefore the connections can be made on either terminal.

PROVIDED PARTS

- ❶ One (1) TH104 thermostat
- ❷ Two (2) 6-32 mounting screws
- ❸ Two (2) solderless connectors

1) Connect the thermostat

Connect the rear wires to the power and load using solderless connectors for copper wires.

2 WIRES

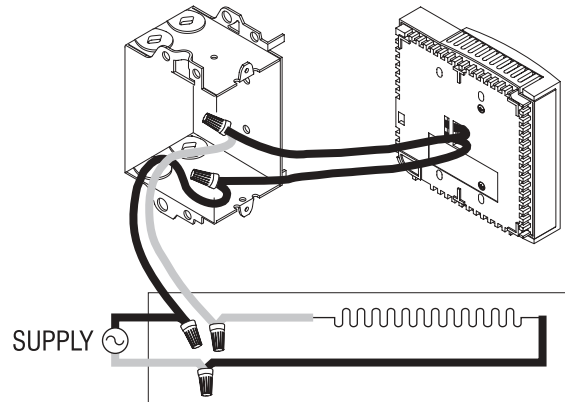

4 WIRES

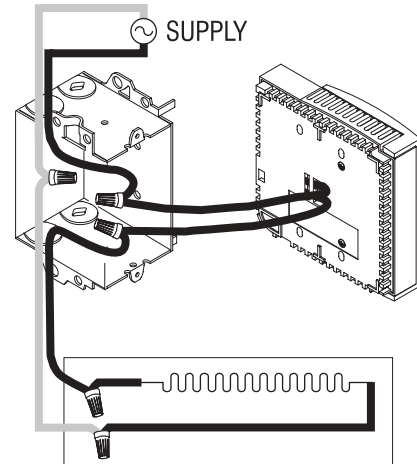

2) Secure the thermostat

 Push the excess wire into the electrical box to prevent interference with the thermostat.

Secure the base to the electrical box using the provided screws.

The base can be secured on the left or right hand side of the electrical box.

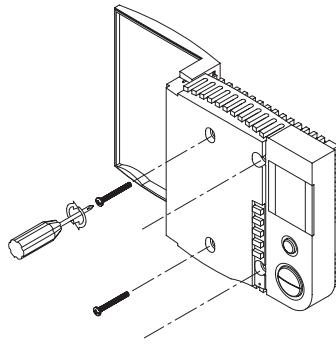

3) Complete the installation

Once the thermostat is configured and installed, return power to heating system.

Keep the thermostat's air vents clean and free from obstructions.

FIRST POWER ON

To view the ambient temperature, peel the lower-right section of the sticker and remove it from the display.

When you first power on the thermostat, the display indicates: 0:00, MO (Monday), the ambient temperature and the MANUAL mode is selected (framed). The default setpoint is preset to 20°C.

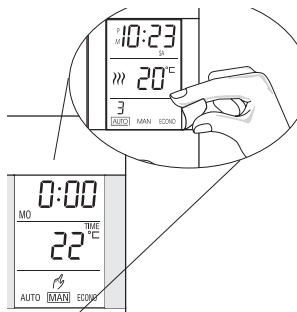

Protected memory

During a power failure, all programs are protected. The thermostat display remains on for approximately 15 minutes after which the LP indicator is displayed (low power). Only the time must be reset if the power failure exceeds 6 hours. The thermostat will automatically return to the previous mode when power returns.

OPTIONS SELECTION

The TH104 offers the following options:

Temperature display	°C	°F
Time display	24 h	12 h
Temperature control	Proportional	Conventional

Highlighted options are factory pre-set. If these options fit your requirements, go to the next menu.

Temperature display

To change the temperature display from °C to °F and vice-versa:

- ▶ Press and hold **Day**, do not release.
- ▶ Reset the thermostat using a pointed object (e.g. paperclip).
- ▶ Release the **Day** button.

Time display

To change the time display format from 12 to 24 hours and vice-versa:

- ▶ Press and hold **Hour**; do not release.
- ▶ Reset the thermostat using a pointed object (e.g. paperclip).
- ▶ Release the **Hour** button.

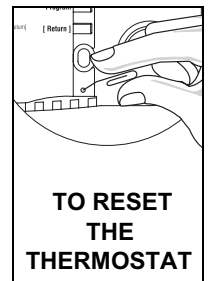

Temperature control type

The TH104 is factory-set to use the proportional temperature control type (15-second cycles).

Since this temperature control type uses a fast commutation rate, it is not compatible with fan-equipped systems. Also, it can also cause light flickering, especially in rural regions.

If you have a fan-equipped system, use the conventional temperature control type (15-minute cycles). To change the type:

- ▶ Press and maintain **Minute**, do not release.
- ▶ Reset the thermostat using a pointed object (e.g. paperclip).
- ▶ Release the **Minute** button.

Following the change, the FAN indicator is displayed on the screen. To revert to proportional control, repeat above steps.

ADJUST THE TIME AND DAY

NOTE: You should select the options before you adjust the clock and day settings because using the reset button when selecting options will reset the clock.

The TIME icon flashes to indicate that the clock needs to be adjusted.

- 1 Press **Day** to set the day.
- 2 Use the **Hour** and **Minute** buttons to set the clock.
- 3 Press **Return** to exit.

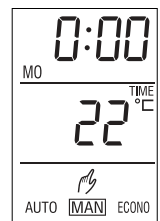

OPERATING MODES

The TH104 has three operating modes:

AUTOMATIC

This mode automatically runs your programs.

Press MODE until AUTO is outlined. The current program number is displayed above the AUTO icon. To temporarily bypass the current program, simply select the desired temperature using the temperature adjustment buttons. The new setpoint will be maintained until the beginning of the next program.

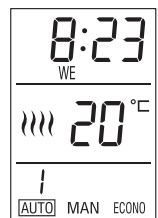

MANUAL

Maintains a constant temperature setpoint.

Press MODE until MAN is outlined and select the desired temperature using the temperature adjustment buttons.

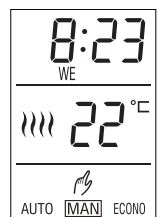

ECONO

This mode automatically runs the programs of the Econo schedule.

Press MODE until ECONO is outlined.

The current program number is displayed above the ECONO icon.



ECONO SCHEDULE

Ideal for cottages, chalets or weekend residences, this schedule enables the user to enter 2 settings.

The first setting lets the user enter a time (i.e. shortly before expected arrival) at which the thermostat commands the heating system to warm to comfort setpoint. The second setting commands a temperature decrease.

	Programs	Day	Time	Setpoint
1	Arrival (start heating)	Friday	3:00 p.m.	21°C
2	End of heating period	Friday	8:00 p.m.	15°C

Using the Econo Mode

At your arrival, switch to Automatic mode. The thermostat will run your programs of the automatic schedule, keeping a comfortable temperature during the day and decrease the temperature during the night.

When you leave, switch to Econo mode. The thermostat will automatically maintain the setpoint of the last program (e.g. 2) until the beginning of the next program.

Programming the Econo Mode

Before you start programming your thermostat, press MODE until ECONO is selected (outlined).

- 1 Press **Program**. The program number is displayed (1).

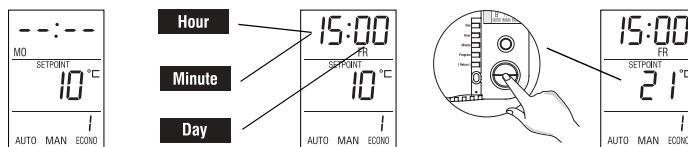

- 2 Press **Day** to select the expected arrival day.
- 3 Use **Hour** and **Minute** to set the time.
- 4 Use the temperature adjustment buttons to define the setpoint.
- 5 Press **Program** to select the next program (2).

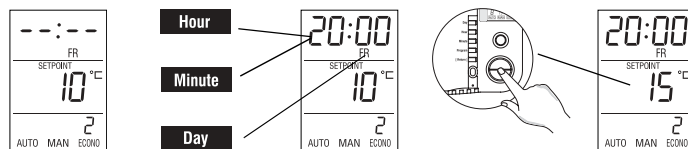

To program this schedule

Before you start programming your thermostat, press MODE until AUTO is selected (outlined).

- 1 Press **Program**. The program number is displayed. Weekdays are displayed (MOTUWETHFR).

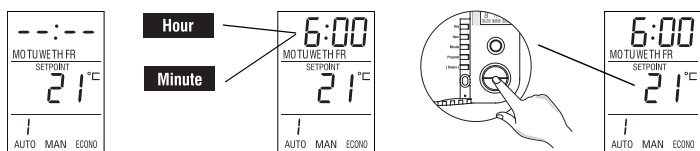

- 2 Use HOUR and MINUTE to set the time. To skip a program (inactive --:--), do not set the time.
- 3 Use the temperature adjustment buttons to define the setpoint.
- 4 Repeat steps 1 to 3 for remaining programs.

For the weekend programs:

- 5 Press **Program**. The program number is displayed (1). Weekend days are also displayed (SU and SA).
- 6 Repeat steps 2 to 4.
- 7 Press **[Return]** to exit programming mode.

TECHNICAL SPECIFICATIONS

Model: TH104

Supply: 120/240 VAC, 50/60 Hz

Power consumption (off): 860 mW

Load: 14.6 A maximum (resistive only), 2 A minimum

Power: 1750 W @ 120 VCA / 3500 W @ 240 VCA

Temperature display range: 0°C to 99°C (0°F to 99°F)

Temperature setting range: 5°C to 27 °C (40°F to 80°F)

Display resolution: 1°

Storage temperature: -20°C to 50°C (-4°F to 120°F)

Accuracy: proportional: ± 0.15°C (0.27°F) from the setpoint
conventional: ± 0.5°C (0.9°F) from the setpoint

Approval: CSA / UL

Dimensions: 120 x 115 x 26 mm (4.8 x 4.5 x 1 inch)

TECHNICAL SUPPORT

If you have any questions concerning the installation of the TH104 thermostat, contact our technical support team at:

Tel.: (450) 358-4600

1-800-831-AUBE (2823)

Fax: (450) 358-4650

Email: service@aubetech.com

Monday to Friday from 8:30 AM to 5:00 PM EST

For more information on our products, visit us at
www.aubetech.com

WARRANTY

AUBE TECHNOLOGIES INC. ONE (1) YEAR LIMITED WARRANTY

This product is guaranteed against workmanship defects for a one year period following the initial date of purchase. During this period, AUBE Technologies Inc. will repair or replace, at our option and without charge, any defective product which has been used under normal conditions. The warranty does not cover delivery costs and does not apply to products poorly installed or randomly damaged following installation. This warranty cancels and replaces any other manufacturer's express or implied warranty as well as any other company commitment. AUBE Technologies Inc. cannot be held liable for related or random damages following the installation of this product. The defective product as well as the purchase invoice must be returned to the place of purchase or mailed, prepaid and insured, to the following address:

Aube Technologies Inc.

705 Montrichard

Saint-Jean-sur-Richelieu, Quebec, Canada J2X 5K8

ABOUT TEMPERATURE CONTROL

The TH104 works differently than conventional electromechanical thermostats which can have a temperature differential up to 4°C and 5°C. The TH104 has a temperature differential of ± 0.15°C from the setpoint. This slight oscillation eliminates the discomfort often found with conventional electromechanic thermostats.

For each cycle, the proportional controller determines the "On" operating time required by the heating system to maintain the setpoint temperature. The following table displays the percentage of the "On" operating time for the heating cycle:

1	2	3	4
1 to 25%	26 to 50%	51 to 75%	76 to 100%

If you are using the conventional control (fan-forced heater), the screen will show the FAN indicator as well as all flame icons (4) when the system is activated. In this case, the thermostat differential is ± 0.5°C from the setpoint.

NOTE: The temperature display resolution is 1°C, but the temperature is internally controlled at 0.01°C.

PROBLEM	POSSIBLE CAUSE	SOLUTION
No display	Circuit breaker is open Power failure	Verify voltage presence at the thermostat
Thermostat is hot	In normal use, at full capacity (3000 W), the thermostat housing may reach a temperature of 35°C to 40°C	This state is normal and does not affect temperature control
Displayed temperature is wrong	<ul style="list-style-type: none"> A draft is near the thermostat The sticker is still on the thermostat display 	<ul style="list-style-type: none"> Eliminate the draft Remove the sticker
The lights are flickering	Fast current switching in the baseboards, mainly in rural regions	<ul style="list-style-type: none"> Use conventional control mode See Options selection section
System is always on	Bad installation	<ul style="list-style-type: none"> Verify installation Reset the thermostat: press PROGRAM while resetting the unit, release PROGRAM (see Options selection section)
Screen shows the heating icon, but the system is not heating	<ul style="list-style-type: none"> Bad installation Power failure (LP indicator is displayed) 	<ul style="list-style-type: none"> Verify installation

TH104-SW PROCEDURE LOCKED KEYBOARD

MAINTAINING THE TEMPERATURE AROUND THE CLOCK

- 1- Press the MODE button to place the thermostat in ECONOMY mode.
- 2- Press the PGM button to select ECONO 1 or ECONO 2.
- 3- Choose the desired temperature. It is not necessary to specify a time or day.
- 4- Press on the RET button to end the programming. Wait a minimum of 30 seconds for the program to be saved.
- 5- To prevent access to the thermostat keyboard, start by turning off the heating system to avoid electrical shocks.
- 6- Remove the thermostat from the electrical box and set the appropriate switches as follows:

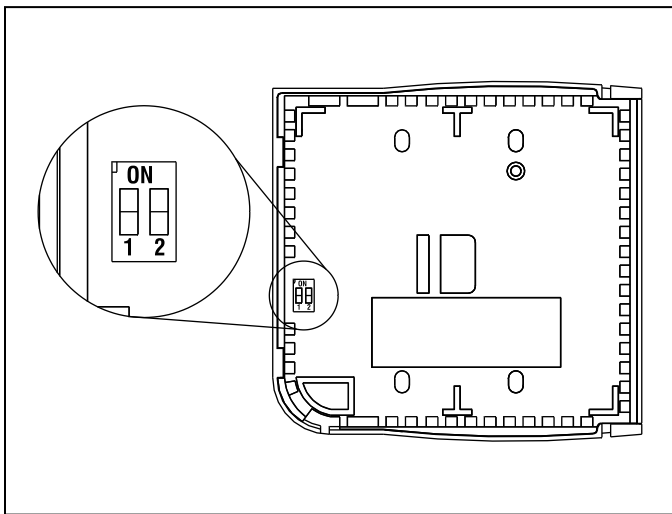

ECONO 1: Switches #1 and #2 ON

ECONO 2: Switches #1 OFF and #2 ON

- 7- Put the thermostat back on the electrical box and turn the heating system back on.

The word REMOTE as well as the program number will show on the screen. The buttons are now disabled.

- 8- If you wish to change the programmed temperature, turn the heating system off again to avoid electrical shocks.
- 9- Next, set all switches to OFF and repeat the above steps.

LOCKED IN AUTO MODE

- 1- Press the MODE button to place the thermostat in AUTO mode.
- 2- Press on the PGM button and enter the desired programming (see the Suggested Typical Programming section in the instruction sheets).
- 3- Press on the RET button to end the programming. Wait a minimum of 30 seconds for the program to be saved.

To prevent access to the thermostat keyboard:

- 1- Start by turning off the heating system to avoid electrical shocks.
- 2- Remove the thermostat from the electrical box and set the appropriate switches as follows:

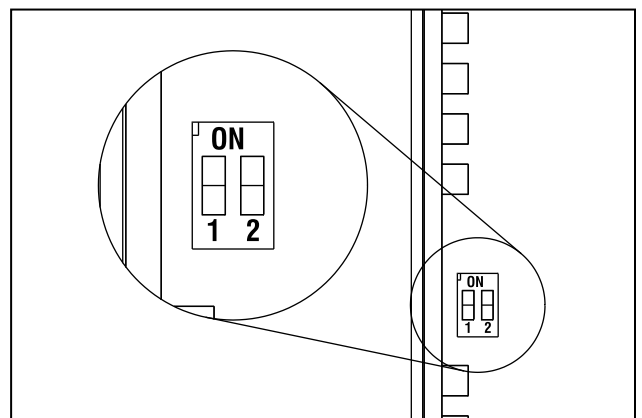

AUTO MODE: Switches #1 ON and #2 OFF

- 3- Put the thermostat back on the electrical box and turn the heating system back on.

The word REMOTE as well as the program number will show on the screen. The buttons are now disabled.

- 4- If you wish to modify your programming, turn the heating system off again to avoid electrical shocks.
- 5- Next, set all switches to OFF and repeat the above steps.

Free Manuals Download Website

<http://myh66.com>

<http://usermanuals.us>

<http://www.somanuals.com>

<http://www.4manuals.cc>

<http://www.manual-lib.com>

<http://www.404manual.com>

<http://www.luxmanual.com>

<http://aubethermostatmanual.com>

Golf course search by state

<http://golfingnear.com>

Email search by domain

<http://emailbydomain.com>

Auto manuals search

<http://auto.somanuals.com>

TV manuals search

<http://tv.somanuals.com>