

A4 S4



**In this instance,
first impressions are accurate.**

If the bold, assertive stance of the Audi A4 looks familiar, it should. Like every model in the family, the A4 shares the distinctive Audi DNA not just in performance, but also design. From the sweeping hood and the provocative available long-life LED daytime running lights bracketing the singleframe® grille, to the luminous available LED taillights integrated into the deck-lid on the sedan, the Audi A4 embodies a commitment to progressive design, luxury and performance.



**A firm belief that the driver
should get preferential treatment.**

The impeccably crafted, driver-oriented cockpit represents a dedication to performance and luxury. The experience begins with the fine craftsmanship of the standard leather seats and the radiance of the decorative Aluminum Hologram inlays. Angled slightly toward the driver, the A4 cockpit places a host of intuitive technology at the driver's fingertips. From the multifunction steering wheel and driver information system, to the latest generation of MMI[®], important details and entertainment options are always within reach.



It does a lot of things quickly, including reminding you of why you like to drive.

However you judge engine performance, the Audi A4, with the award-winning 2.0 liter TFSI[®], delivers. Thanks to quattro[®] all-wheel drive, 258 lb-ft. of torque and 211 hp, the A4 yields exceptional power. Not to mention, a best-in-class 0-60 MPH time of 6.4 seconds. In fact, the 2.0 liter turbocharged engine delivers power that outperforms most of the competition's six-cylinder engines. Plus, with a standout 30 MPG, the A4 adds best-in-class in fuel economy* to its impressive list of feats.



The design is pure progress.

Beautifully proportioned, the A4 is designed to emanate not just distinction, but also poise. Starting with the elegant roofline and sculpted contours, the A4 marks an unwavering testament to progressive style. Its pronounced design is also a result of the wheel placement. By positioning the wheels closer to the corners of the car, the A4 yields a wider, sportier stance, adding to its striking symmetry. Add the available 18" or 19" wheels and the ultimate package of style and sophistication is complete.



**There is room for everything
but compromise.**

Inside and out, the A4 Avant fluidly integrates sophistication with utility. This is affirmed the moment the available powerful LED daytime running lights spring to life. In the front, the distinctive singleframe® grille marks the Avant as pure Audi. Overhead, the chrome roofrails, sweeping roofline and sporty rear spoiler gracefully cascade to a tailgate that offers surprising functionality without diminishing any of its luxury or performance.





Luxury that knows how to multitask.

The A4 Avant is extremely adept at fulfilling a number of roles effortlessly. Regardless of what they are, you can be certain luxury, comfort and thoughtful innovation are always part of the experience. For instance, the A4 Avant features numerous functionality aspects, including 60/40 split folding rear seats and a multipurpose luggage cover, which can be used as a partition to maximize versatility. As for passengers in the back seat, they can enjoy considerable leg room, while everyone gets to experience the standard Open Sky panorama sunroof.





**It does more in a single turn
than most cars do in a lifetime.**

The Audi A4 features the latest version of quattro® all-wheel drive that offers a rear torque bias of 40:60. It gives the A4 sportscar-like handling with the confidence of all-wheel drive traction.

Additionally, the available Audi drive select enhances handling performance by offering 27 distinct driving configurations, which provide a balance between performance and comfort driving. Audi drive select manages the adaptive suspension, dynamic steering, transmission shift characteristics and throttle response according to the driver's choice of Comfort, Automatic, Dynamic or Individual settings. Combine all of that with the innovative Servotronic® speed-sensitive steering and you have a driving experience that is truly exclusive.



**Its innovative technology
reveals itself around every corner.**

As progressive as the A4 looks on the exterior, it is no less so once you slide behind the wheel. With the use of MMI® control logic, the driver can access everything from the available 3D navigation, to satellite radio, to an iPod® with the Audi music interface and a Bluetooth®-enabled phone. Additional convenience comes from the multifunction steering wheel and available voice control, which means your hands can stay safely on the wheel.

Innovative technologies like available Audi side assist help keep you out of harm's way by warning you of rapidly approaching vehicles from the rear as well as alerting you to vehicles that may be in your blind spot. The available Audi adaptive cruise control also keeps an eye out by ensuring the driver is aware of vehicles ahead. You will experience an initial warning, and if necessary, the system will even begin to slow the A4 to help avoid a collision.

Making the unpredictable uneventful.

By examining the causes and effects of accidents, Audi has developed a number of systems designed to help prevent an accident in the first place. For example, the A4 features an automatic brake disc wiping system as part of the Electronic Stabilization Program [ESP®]. By gently pulsing the brakes to dissipate water buildup, the system helps the brake discs stay as dry as possible. Simply put: Minimize what is between the pad and the disc, and your braking effectiveness increases significantly.

But when an accident does prove unavoidable, the A4 steps up to deliver state-of-the-art protection by way of a high-strength-steel body and a standard complement of six airbags*, including front, side and side-curtain airbags.



*Airbags are supplemental restraints only and do not deploy in all crash circumstances. Always use safety belts and seat children in the rear, using restraint systems appropriate for their size and age. This is a dramatization and does not depict what will happen in an accident. All bags will not inflate in real-world accidents, and if multiple bags deploy, they will be in various stages of inflating/deflating and will never all be inflated at the same time.

Audi A4 Avant 2.0T Prestige

**Surpasses everything.
Especially your expectations.**

When it comes to the Audi S4, nothing is left to chance. It is purposeful and powerful, and it turns heads – moving or parked. There are numerous design cues to back up its legendary performance. Among them are the striking Aluminum Optic mirrors, quad exhaust tailpipes, standard 18" wheels and exclusive S4 front and rear bumpers. Just a few indications of the power that lies beneath the hood.





**Everything is at your fingertips,
including innovation.**

The Audi S4 incorporates as much innovation as it does performance. For starters, the S4 features the intuitive MMI® operating system, allowing you to easily integrate your Bluetooth®-enabled phone, enjoy SIRIUS® Satellite Radio and take advantage of the convenience of navigation with real-time traffic.

With Audi advanced key, the S4 can be unlocked and started without removing the key from a pocket or purse. Enter the car and the steering wheel is released and the ignition is turned on with the press of a button – all without inserting the key into the ignition.



Fast? How fast can you count to 0.2?

With the powerful 333 hp 3.0 liter supercharged V6 waiting to launch you with 325 lb-ft. of torque, the last thing you want to do is spend time between gears. The new seven-speed S tronic® dual-clutch automatic transmission delivers on-the-spot gear changes, which is especially exhilarating during the 4.9 seconds it takes to reach 60 MPH.

Perhaps most impressive, the S4 delivers all of its exceptional power and performance without compromising fuel economy. The 3.0 liter supercharged V6 delivers V8 power with remarkable fuel efficiency.



* EPA estimate not available at time of printing. Your mileage will vary.

This is where it becomes visceral.

If the standard for pure performance is the Audi S4, then the latest version of quattro® all-wheel drive with available Sport Rear Differential is the pinnacle. Alongside the performance-oriented feel of the 40:60 rear-biased torque split, handling is further improved due to the variable torque distribution between the rear wheels. The result is exactly what you expect: Performance car handling and incomparable traction.

The handling experience is further enhanced through the innovative Servotronic® speed-sensitive steering. The premise is simple. As speed increases, the steering becomes more responsive for superior handling. While driving at slower speeds, Servotronic® provides greater steering assistance, allowing you to easily park and maneuver in tight places.



**Enhancing the
experience of performance.**

There is no mistaking the superior fit and finish of an Audi S4 interior. The unique hand-stitched S design sport seats in available Silk Nappa leather offer a distinct driving experience as well as an unmistakable look. The prominent side bolsters and integrated headrests have been specifically designed to support you during spirited driving.



The sum of inspired engineering.

The unmistakable power of the Audi S4 is the result of not just innovation, but also the pedigree of legendary Audi performance. The new S4 continues this tradition with a series of features that change not just how you see the road, but also how you experience it. From the unmistakable deep, rousing sound of the powerful yet efficient supercharged V6 to the lightning-fast, seven-speed S tronic® transmission and the supreme confidence of quattro® all-wheel drive traction with Sport Rear Differential, the S4 delivers on a legacy of performance like never before.





1 Sunroof | The sunroof provides the Audi A4 Sedan with natural light and a continuous flow of fresh air within the cabin. The A4 Avant is equipped with the Open Sky system. This large, two-piece panorama sunroof offers a refreshingly airy driving experience.

2 Audi concert radio with SIRIUS® Satellite Radio | Audi concert radio features the Audi Sound System with 180 watts of power and ten total speakers, including two in each door, a subwoofer and a center fill speaker. It also offers a CD player, auxiliary input and an SD® card slot with MP3 capability. The Radio Data System [RDS] on the color screen displays several types of FM radio information, as well as SIRIUS® Satellite Radio information. And the Graduated Audio Level Adjustment [GALA] ensures optimal volume levels as cabin noise increases with speed.

3 17" seven-spoke wheels with 225/50 all-season tires | The 17" seven-spoke wheel is a refined design that complements the sport-inspired style of the A4. All-season tires offer responsive handling on a variety of surfaces.

4 Leather seating surfaces | The superior quality of leather and impeccable craftsmanship add to the elegant, dynamic and versatile driving experience of the A4.

+ Automatic climate control | The climate is easily controlled through the center console, while a light sensor on the dashboard adjusts the system based on the sun's intensity.

+ Halogen headlights with daytime running lights | Halogen headlights enhance safety by illuminating a wide section of the road.

Features listed are standard on the Premium model unless otherwise noted.

+ FEATURE NOT SHOWN

5 Multifunction, leather-wrapped steering wheel | The unique steering wheel roller-interface controls let the driver operate volume, radio stations and CD tracks without taking their hands off of the wheel.

6 Power adjustable, heated exterior mirrors with integrated LED turn signals | The exterior rearview mirrors are electronically adjustable, heated to prevent fogging and house integrated LED turn signals.

7 Electronic cruise control | The Audi A4 comes equipped with electronic cruise control with coast, resume and accelerate features, conveniently located on a stalk on the steering column.

8 Power front seats with electric driver lumbar | The power front seats allow the driver and passenger to adjust the seats' forward/backward position, height, driver lumbar support and angle of seat cushion and seatback.

+ Backlit instrument cluster | The backlit instrument cluster gives the driver convenient and easily accessible information vital to the driving experience. Functions include tachometer, speedometer, digital clock with date, fuel gauge and coolant temperature gauge.

+ Tire pressure monitoring system | The tire pressure monitoring system notifies the driver when tire pressure is above or below acceptable levels. It oversees the pressure in all four tires while the car is being driven and warns the driver in the event of pressure loss with symbols in the driver information system.



Features listed are standard on the Premium model unless otherwise noted.

+ FEATURE NOT SHOWN



- 1 **Audi xenon plus headlights with LED daytime running lights** | Audi xenon plus headlights produce a bright arc that serves as an excellent light source to illuminate the road. LED daytime running lights provide visibility and can be switched off manually if necessary.
- 2 **HomeLink® and Bluetooth®** | HomeLink® is integrated into the overhead controls and uses a simple three-button system that controls garage doors, gates and even lights in the home. The Bluetooth® hands-free phone interface allows the pairing of a Bluetooth®-enabled mobile phone with the vehicle, and includes access to the phonebook within the driver information display of the instrument panel. For specific compatibility and operation, refer to audiusa.com/bluetooth or contact your local Audi dealer for the latest listing of compatible phones.
- 3 **Three-zone automatic climate control** | Both driver and front passenger, as well as the occupants of the rear seats, can select their required temperature and distribution of air individually for their particular seating area.
- 4 **LED taillights** | LED lights are superior to conventional bulbs, with their activation speed and their long service life. They can last an entire vehicle lifetime, consume up to 50 percent less energy and take up less space. [A4/S4 Sedan only]
- + **Rain/light sensor** | An embedded sensor detects the level of light and automatically turns on the headlights if needed. The rain sensor offers the same convenience in wet conditions by automatically adjusting the rate of the wiper sweep to the amount of rain.

Features listed are standard on the Premium Plus model unless otherwise noted.

+ FEATURE NOT SHOWN

5 18" five-parallel-spoke S design wheels with 245/40 summer performance tires* | The bold yet classic style of the 18" five-parallel-spoke S design wheel is standard on the S4. The wheels come equipped with summer performance tires, which help to improve handling and driving dynamics. [S4 only]

6 Dual exhaust quad tailpipes | Unique chrome quad oval tailpipes create a rich exhaust note and leave no doubt about the power contained under the hood. [S4 only]

7 Audi music interface | The Audi music interface offers intelligent integration with the iPod®. Any iPod® Generation 4 and higher (iPod®, iPod® nano, iPod® photo) may be connected through the glove box, and full iPod® controls are available through the MMI® screen.

8 Heated front seats | The seat-heating system is designed to heat the entire surface of the seat; warming is initiated with a convenient button.

+ S4 sport seats | The sport seats offer greater lateral support, thanks to the more prominent side bolsters. The seat functions include electric lumbar support and integrated head restraints. With standard leather and integrated Alcantara® inserts or available Silk Nappa leather, the S4 sport seats add to the elegant, dynamic and sporty driving experience. The stylish contrast stitching adds to the performance style. [S4 only]



Features listed are standard on the Premium Plus model unless otherwise noted.
 * See page 40 for important safety information regarding summer performance tires.

+ FEATURE NOT SHOWN



- 1 **18" five-spoke wheels with 245/40 all-season tires** | The five-spoke wheels' progressive design is matched to the dynamic elegance of the A4. The lightweight alloy also helps to improve driving dynamics. [A4 only]
- 2 **Audi MMI® Navigation plus** | Audi MMI® Navigation plus features a 7", full-color LCD screen and MMI® control logic. The A4 and S4 come equipped with the latest generation of MMI®, powered by a 40-GB hard drive and an NVIDIA® processor to enhance graphics. This generation MMI® offers 3D topography, including the buildings in many cities. The package includes a color driver information system, real-time traffic and navigation through audible route guidance and graphics. Also includes voice control of navigation, telephone and entertainment functions.
- 3 **Auto-dimming interior mirror with compass** | The rearview mirror with automatic dimming recognizes glaringly bright beams behind the car and darkens the mirror automatically. An electronic control unit varies the darkening effect quickly and continuously according to actual ambient light conditions. Vehicle direction is digitally displayed in the corner of the mirror.
- 4 **Audi advanced key** | With Audi advanced key, the car can be unlocked and started without removing the key from a pocket or purse. At the same time, the steering is released and the ignition can be turned on electronically – all without inserting the key into the ignition.
- 5 **Driver seat memory** | The driver seat memory remembers the occupant's seat position and recalls it with the push of a button for added comfort.
- + **Bang & Olufsen® Sound System** | This unrivaled sound system combines state-of-the-art technologies that include proprietary Digital Signal Processing [DSP] and ICEpower digital amplification with a detailed study of the Audi interior. The system boasts 14 speakers for an output of 505 watts. More than a sound system built into a car, the system is the ultimate driving and listening experience, a virtual concert hall on wheels.
- + **Auto-dimming, power-adjustable, heated exterior mirrors** | The exterior mirrors with automatic dimming recognize glaringly bright headlight beams behind the car and darken the mirror glass automatically. The mirrors are electronically adjustable and heated to prevent fogging and house integrated LED turn signals. The S4 mirrors come in a unique Aluminum Optic finish, giving the S4 a dramatic, distinctive look.

Features listed are standard on the Prestige model unless otherwise noted.

+ FEATURE NOT SHOWN

6. S line, multifunction, sport steering wheel with shift paddles |

The race-inspired perforated S line, multifunction steering wheel has a performance look and feel while providing easy access to CD, radio, navigation and voice control functions. [Shift paddles only available with Tiptronic*]

7. S line interior |

The quality of materials and craftsmanship of the Audi A4 interior are highlighted by elegant and sporty Brushed Aluminum decorative inlays extending across the center console and doors as well as S line badges on the steering wheel and doorsills.

8. S line sport seats |

The leather and perforated Alcantara® sport seats offer greater lateral support, thanks to the prominent side bolsters. The seat functions include electric lumbar support for both front seats, forward/backward position, height, and angle of seat cushion and seatback.

9. S line front and rear bumpers |

Some of the most distinguishing factors of the A4 are its unique exterior elements. The S line bumpers add a stylish and sporty quality, complementing the powerful lines and stance of the vehicle.

10. 19" seven-twin-spoke wheels with 255/35 summer performance tires* |

This aggressive, sport-inspired wheel option complements the exterior of the A4 from top to bottom.

+ Sport suspension |

For those who plan to drive in a more sporty fashion, the S line Package includes a specially tuned, firmer suspension.



* See page 40 for important safety information regarding summer performance tires.



1 Bang & Olufsen® Sound System | This unrivaled sound system combines state-of-the-art technologies that include proprietary Digital Signal Processing [DSP] and ICEpower digital amplification with a detailed study of the Audi interior. The system boasts 14 speakers for an output of 505 watts. More than a sound system built into a car, the system is the ultimate driving and listening experience, a virtual concert hall on wheels.
[A4/S4 Premium Plus only]

2 Heated front seats | The seat-heating system is designed to heat the entire surface of the seat; warming is initiated with a convenient button.
[A4 Premium only]

3 Audi music interface | The Audi music interface offers intelligent integration with the iPod®. Any iPod® Generation 4 and higher [iPod®, iPod® nano, iPod® photo] may be connected through the glove box, and full iPod® controls are available through the MMI® screen. [A4 Premium only]

4 Silk Nappa Leather Package | The use of high-quality Silk Nappa leather in the interior of the S4 adds to the elegant, dynamic and sporty driving experience. [S4 only]

+ Audi adaptive cruise control | Adaptive cruise control monitors distance to the vehicle in front via radar sensors and automatically reduces speed, as well as resumes speed, to maintain the driver-selected safe distance.
[A4/S4 Prestige only]

+ Rear side airbags* | Rear side airbags offer the second-row outboard occupants enhanced impact protection.

+ quattro® with Sport Rear Differential | quattro® with Sport Rear Differential dynamically varies torque between the rear wheels for enhanced cornering agility. [S4 only]

* Airbags are supplemental restraints only and do not deploy in all crash circumstances. Always use safety belts and seat children in the rear, using restraint systems appropriate for their size and age.

+ FEATURE NOT SHOWN

5 18" Sport Package | For those who plan to drive in a more sporty fashion, the 18" Sport Package includes a specially tuned, firmer suspension and sport seats that offer greater lateral support. The 18" sport design wheels have a bold, aggressive design and come equipped with 245/40 summer performance tires*. Tiptronic® models equipped with the Sport Package have shift paddles that allow effortless, race-inspired gear shifting that keeps the driver's hands on the three-spoke steering wheel. [A4 Premium and Premium Plus only]

6 19" Sport Package | Includes the same suspension, seats, shift paddles and steering wheel as the 18" Sport Package, but comes equipped with the 19" seven-twin-spoke wheels, which are dynamic in stance and striking in design. These wheels come equipped with 255/35 summer performance tires*. [A4 Prestige only]

7 Driver Assist Package | Audi side assist monitors the blind spot areas, as well as fast-approaching vehicles, at a range of about 150 ft. to the rear of the car. If Audi side assist identifies another vehicle, it informs the driver via LED lights in the exterior mirror. The rearview camera offers a real-time view of the rear parking area, while the rear ultrasonic parking sensors measure the distance to the nearest object while the vehicle is in reverse. [A4/S4 Prestige only]

+ Audi Navigation plus Package | The Audi Navigation plus Package features a 7" full-color LCD screen and MMI® control logic. The A4 and S4 come equipped with the latest generation of MMI®, powered by a 40-GB hard drive and an NVIDIA® processor to enhance graphics. This generation MMI® offers a color driver information system, real-time traffic and 3D topography graphics that include the buildings in many cities. Also included is the Audi parking system with rearview camera and voice control of navigation, telephone and entertainment functions. [A4/S4 Premium Plus only]

+ Audi Drive Select Package | Audi drive select controls the vehicle's adaptive suspension, dynamic steering, transmission shift characteristics and engine response. The system offers your Audi four distinct driver configurations: Comfort, Automatic, Dynamic and Individual. On the S4, the package also includes the new quattro® with Sport Rear Differential, which dynamically varies torque between the rear wheels. [A4/S4 Prestige only]

* See page 40 for important safety information regarding summer performance tires.

+ FEATURE NOT SHOWN



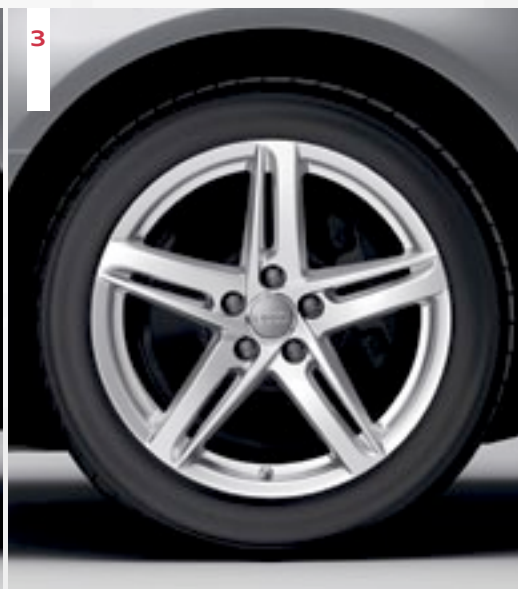

1 Front spoiler with blade insert | This Audi-designed styling component creates a dynamic lowered appearance with a front spoiler and blade. [A4 only]

2 18" 15-spoke wheels | These wheels make a strong statement with an eye-catching design. All of our alloy wheels are specially engineered to meet the strict tolerances of our Audi original wheels.

3 18" five-arm rotor design wheels | A new-look rotor design means these alloy wheels stand out from the crowd.

4 Ski and snowboard racks | These racks' rubber-cushioned aluminum bars hold securely. The smaller standard attachment holds up to two snowboards or four skis. A larger deluxe attachment holds up to four snowboards or six skis. [Must be used in combination with the base carrier bars, which are sold separately]

+ Premium textile floor mats | These precision-fit mats are made of long-life fabric to help protect the interior of your Audi from the elements. Skid-resistant. Available in Black. Set of four mats.

+ Splash guards | Help protect your Audi vehicle's finish with custom-fit front and rear splash guards. Made of long-life, crack-resistant rubber. Available in sets of two for the front and the rear.

See your local Audi dealer for the complete selection of Audi Genuine Accessories.

+ FEATURE NOT SHOWN

5 Rear spoiler | A trunk lip spoiler adds a sporty flair to your A4/S4.
[A4/S4 Sedan only]

6 19" five-arm hollow-spoke wheels | These alloy wheels feature the latest hollow-spoke technology for a lower-weight wheel that delivers improved driving dynamics and comfort.

7 Distinctive side sills | Completes the look of your A4/S4 Sedan or Avant.

+ Rear diffuser with blade insert | This Audi-designed styling component adds an aggressive edge to your A4. [A4 only]

+ Polished stainless steel exhaust tips | Enhance the look of your A4 with these tailpipe embellishers. Made of highly polished stainless steel. Tips feature rolled edges and are angle cut. [A4 only]

+ Canoe and kayak rack | This rack enables you to carry one canoe or kayak weighing up to 55 lbs. Rack conforms to most hulls. Includes one pair of heavy-duty straps. [Must be used in combination with the base carrier bars, which are sold separately]

+ Rubber floor mats | These trim-profile, embossed rubber mats help extend the life of your carpet. Available in Black or Gray, in sets of two for the front and the rear.

See your local Audi dealer for the complete selection of Audi Genuine Accessories.

+ FEATURE NOT SHOWN



A4 Wheel Options

1



4



2



5



3



A4 Wheel Options

1 17" seven-spoke wheels with 225/50 all-season tires | The 17" seven-spoke wheel is a refined design that complements the sport-inspired style of the A4. The wheels come equipped with all-season tires. [A4 Premium]

2 17" ten-spoke wheels with 245/45 all-season tires | The ten-spoke star design is a refined choice matching the sophistication of the A4 Premium Plus model. Additionally, the lightweight alloy helps to improve driving dynamics. [A4 Premium Plus]

3 18" five-spoke wheels with 245/40 all-season tires | The five-spoke wheels' progressive design is matched to the dynamic elegance of the A4. The lightweight alloy also helps to improve driving dynamics. [A4 Prestige]

4 18" ten-spoke wheels from quattro® GmbH with 245/40 summer performance tires* | The 18" Sport Package wheels add an athletic feel to the A4. The quattro® GmbH dynamic design complements the sport suspension and is optimized with summer performance tires. [18" Sport Package required. A4 Premium and Premium Plus]

5 19" seven-twin-spoke wheels from quattro® GmbH with 255/35 summer performance tires* | This aggressive, sport-inspired wheel option complements the exterior of the A4 from top to bottom. The wheels come equipped with summer performance tires, which help to improve handling and driving dynamics. [S line Package or 19" Sport Package required. A4 Prestige]

* Summer performance tires are designed for optimum performance and handling in warm climates. They are not suitable for cold, snowy or icy weather conditions. If you drive under those circumstances, you should equip your vehicle with all-season or winter tires, which offer better traction under those conditions. We suggest you use the recommended winter or all-season tires specified for your car or their equivalent. These summer performance tires also have a lower aspect ratio that aids performance and handling; however, in order to avoid tire, rim or vehicle damage, it is important that the inflation pressure is regularly checked and maintained at recommended levels. Serious wheel and tire damage may occur if the vehicle is operated on rough or damaged road surfaces, or upon encountering road debris or obstacles. Please also remember in making your selection that, while these tires deliver responsive handling, they may ride less comfortably and make more noise than other choices. Finally, these tires may wear more quickly than other choices. For more information on all of these topics, please consult the owner's manual, your local dealer or call 1-800-FOR-AUDI.

6 18" five-parallel-spoke S design wheels with 245/40 summer performance tires* | The bold yet classic style of the 18" five-parallel-spoke S design wheel is standard on the S4. The wheels come equipped with summer performance tires, which help to improve handling and driving dynamics. [S4 Premium Plus]

7 19" five-tri-spoke wheels with 255/35 summer performance tires* | The 19" five-tri-spoke wheel option is aggressive in its stance and bold in design. The wheels come equipped with summer performance tires, which help with handling. [S4 Prestige, optional on S4 Premium Plus]

6



7



* Summer performance tires are designed for optimum performance and handling in warm climates. They are not suitable for cold, snowy or icy weather conditions. If you drive under those circumstances, you should equip your vehicle with all-season or winter tires, which offer better traction under those conditions. We suggest you use the recommended winter or all-season tires specified for your car or their equivalent. These summer performance tires also have a lower aspect ratio that aids performance and handling; however, in order to avoid tire, rim or vehicle damage, it is important that the inflation pressure is regularly checked and maintained at recommended levels. Serious wheel and tire damage may occur if the vehicle is operated on rough or damaged road surfaces, or upon encountering road debris or obstacles. Please also remember in making your selection that, while these tires deliver responsive handling, they may ride less comfortably and make more noise than other choices. Finally, these tires may wear more quickly than other choices. For more information on all of these topics, please consult the owner's manual, your local dealer or call 1-800-FOR-AUDI.

BLACK LEATHER | ALUMINUM HOLOGRAM INLAY



CARDAMOM BEIGE LEATHER | ALMOND BEIGE ASH WOOD INLAY*



DECORATIVE INLAY OPTIONS

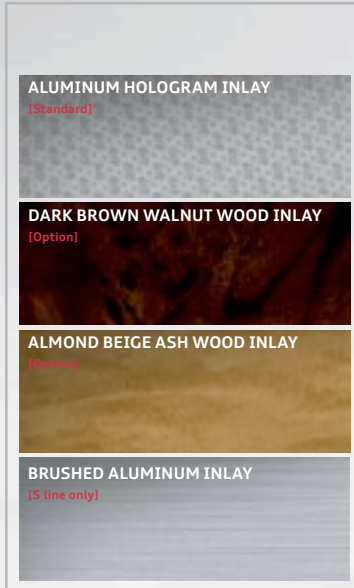

LIGHT GRAY LEATHER | DARK BROWN WALNUT WOOD INLAY*



BLACK LEATHER/PERFORATED ALCANTARA* | BRUSHED ALUMINUM INLAY [S line only]



* Optional inlay shown



BLACK LEATHER/ALCANTARA* | BRUSHED ALUMINUM INLAY



BLACK/RED SILK NAPPA LEATHER | GRAY BIRCH WOOD INLAY*



BLACK/SILVER SILK NAPPA LEATHER | CARBON FIBER INLAY*



DECORATIVE INLAY OPTIONS

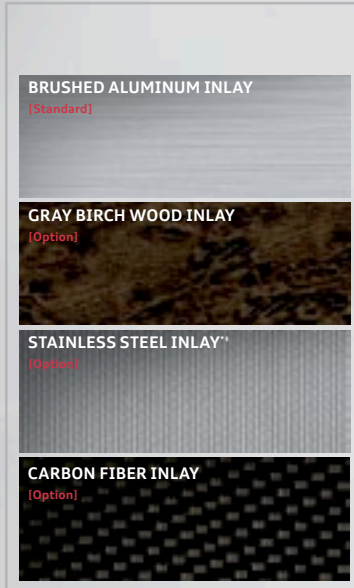

BLACK SILK NAPPA LEATHER | BRUSHED ALUMINUM INLAY



BLACK/BROWN SILK NAPPA LEATHER | STAINLESS STEEL INLAY*



* Optional inlay shown
* Silk Nappa leather is optional on S4
* Includes Piano Black inlay on center console

Audi A4 | S4 Make Yours.



A4 Monza Silver[®] PEARL EFFECT*



A4 Misano Red[®] PEARL EFFECT*



A4 Dakar Beige METALLIC



A4 Aruba Blue[®] PEARL EFFECT*



A4 | S4 Ibis White



A4 | S4 Quartz Gray METALLIC



A4 | S4 Brilliant Black



A4 | S4 Ice Silver METALLIC



A4 | S4 Brilliant Red



A4 | S4 Meteor Gray PEARL EFFECT*



A4 | S4 Phantom Black PEARL EFFECT*



A4 | S4 Deep Sea Blue PEARL EFFECT*



S4 Sprint Blue PEARL EFFECT*



S4 Imola Yellow[®] PEARL EFFECT*

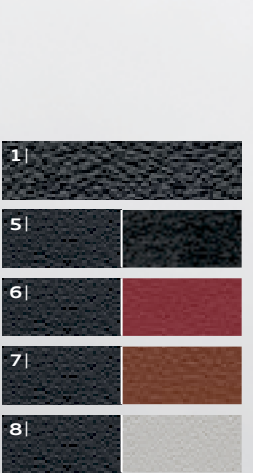
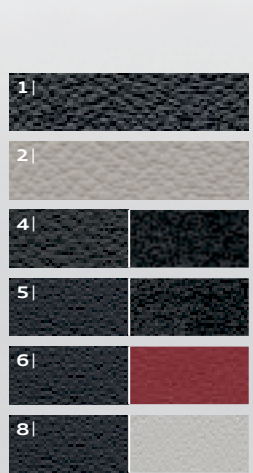
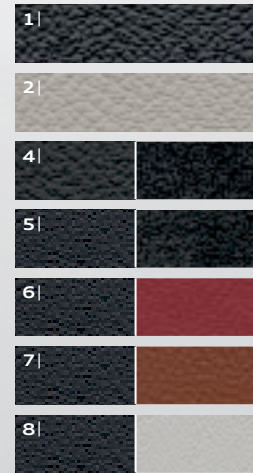
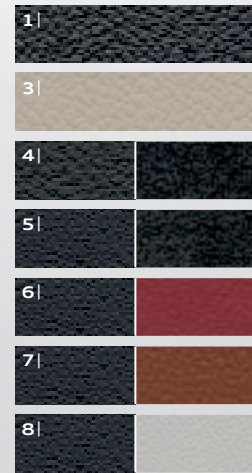
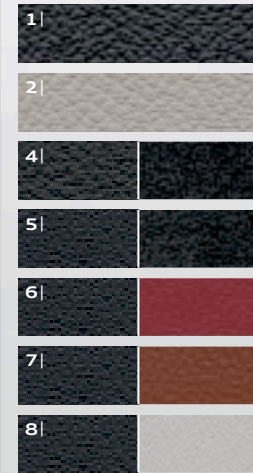
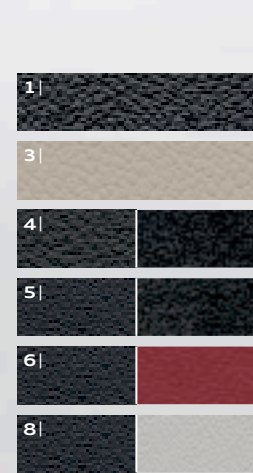
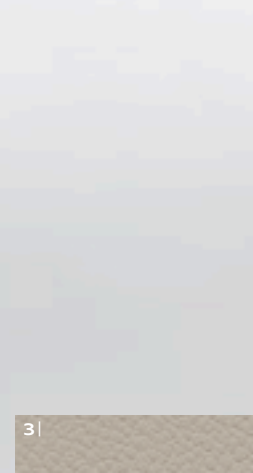
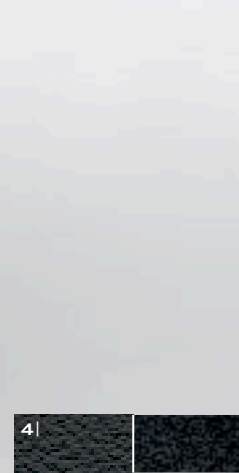

- 1 | Black
- 2 | Light Gray
- 3 | Cardamom Beige
- 4 | Black/Perforated Alcantara[®] [S line only]
- 5 | Black/Black Alcantara[®] [S4 only]
- 6 | Black/Red [S4 only]
- 7 | Black/Brown [S4 only]
- 8 | Black/Silver [S4 only]

* S line only
* Additional charge

A4 | S4 2010 Specifications

Chassis/Technical	A4	S4
Five-link front suspension with upper and lower control arms, stabilizer bar and individual, gas-charged coil springs/shock absorbers	s	s
Independent trapezoidal-link rear suspension with rigid subframe, stabilizer bar and individual, gas-charged coil springs/shock absorbers	s	s
Servotronic [®] speed-sensitive power steering – varies assistance based on vehicle speed	s	s
quattro [®] permanent all-wheel drive system utilizing torque-sensing center differential – 40:60 rear-biased torque split	o	s
quattro [®] with Sport Rear Differential permanent all-wheel drive system utilizing torque-sensing center differential – 40:60 rear-biased torque split and variable torque application between rear wheels	-	o
Sport suspension calibration	o	-
S4 sport suspension calibration	-	s
Multitronic [®] continuously variable transmission [CVT]	s	-
Six-speed manual transmission	o	s
Tiptronic [®] automatic transmission	o	-
S tronic [®] seven-speed, dual-clutch automatic transmission	-	o
Fully galvanized steel unibody with multistep anti-corrosion protection	s	s

Safety & Security	A4	S4
Driver and front passenger advanced dual-stage airbag ¹ supplemental restraints	s	s
Driver and front passenger seat-mounted side thorax airbag ¹ supplemental restraints	s	s
Seat-mounted rear side airbags ¹ for outboard seating positions	o	o
Sideguard [®] head curtain airbags ¹ for both rows of seats	s	s
Front passenger occupant detection for airbag ¹ supplemental restraints	s	s
Front three-point safety belts with automatic pretensioning and force limiters; height adjustable for front seating positions	s	s
Rear three-point safety belts with belt force limiters for outboard passenger seating positions	s	s
Safety belt reminder for driver and front passenger	s	s
Lower Anchors and Tethers for Children [LATCH] in rear seats	s	s
Pinch protection for passenger compartment windows	s	s
Central locking system with selective unlock feature	s	s
Impact protection – including reinforced high-strength-steel/aluminum crossmembers, reinforced bumpers and rigid occupant cell	s	s
Tire pressure monitoring system	s	s
Electronic Stabilization Program [ESP] ²	s	s
Anti-lock Brake System [ABS] with Electronic Brake-force Distribution [EBD]	s	s
Brake assist – a system that automatically senses emergency braking and applies maximum power boost to reduce overall stopping distance	s	s
Front ventilated disc brakes	s	s
Electromechanical parking brake	s	s
Audi hill hold assist	s	s
Reflectors in rear of all doors	s	s
Anti-theft vehicle alarm system with blinking theft-deterrent light	s	s

The table above represents the standard equipment on the Premium model. Many popular options are combined and available on the Premium Plus and Prestige models. Please see the package contents in this brochure for complete details.

¹ Airbags are supplemental restraints only and will not deploy under all crash circumstances. Always use safety belts and seat children in the rear, using restraint systems appropriate for their size and age.

² Summer performance tires are designed for optimum performance and handling in warm climates. They are not suitable for cold, snowy or icy weather conditions. If you drive under those circumstances, you should equip your vehicle with all-season or winter tires, which offer better traction under those conditions. We suggest you use the recommended winter or all-season tires specified for your car or their equivalent. These summer performance tires also have a lower aspect ratio that aids performance and handling. However, in order to avoid tire, rim or vehicle damage, it is important that the inflation pressure is regularly checked and maintained at recommended levels. Serious wheel and tire damage may occur if the vehicle is operated on rough or damaged road surfaces, or upon encountering road debris or obstacles. Please also remember in making your selection that, while these tires deliver responsive handling, they may ride less comfortably and make more noise than other choices. Finally, these tires may wear more quickly than other choices. For more information on all of these topics, please consult the owner's manual, your local dealer or call 1-800-FOR-AUDI.

³ Your Audi vehicle is equipped with a phone preparation utilizing Bluetooth[®] interface to enable hands-free functionality [compatible mobile phones sold separately]. You will need a Bluetooth[®]-enabled mobile phone in order to utilize this function. Not all Bluetooth[®]-enabled mobile phone models are compatible with Audi phone preparation. Visit audiusa.com/bluetooth, or contact your local Audi dealer for the latest listing of compatible phones. Audi recommends use of the Audi phone cradle [sold separately] with your mobile phone while operating this vehicle.

⁴ Audi Navigation plus depends on signals from the worldwide Global Positioning Satellite network. The vehicle's electrical system, and existing wireless and satellite technologies, must be available and operating properly for the system to function. The system is designed to provide you with suggested routes in locating addresses, destination and other points of interest. Changes in street names, construction zones, traffic flow, points of interest and other road system changes are beyond the control of Audi of America, Inc. Complete detailed mapping of lanes, roads, streets, toll roads, highways, etc., is not possible, therefore you may encounter discrepancies between the mapping and your actual location. Please rely on your individual judgment in determining whether or not to follow a suggested Audi Navigation plus route. Periodically, the mapping is updated, and a new DVD will be required in order to maintain the latest navigation information available to us. These will be available for purchase from time to time at an additional cost. Consult your dealer or call 1-800-FOR-AUDI for details.

Features	A4	S4
17" seven-spoke wheels with 225/50 all-season tires	s	-
17" ten-spoke wheels with 245/45 all-season tires	o	-
18" five-spoke wheels with 245/40 all-season tires	o	-
18" ten-spoke wheels with 245/40 summer performance tires ¹	o	-
19" seven-twin-spoke wheels with 255/35 summer performance tires ¹	o	-
18" five-parallel-spoke S design wheels with 245/40 summer performance tires ¹	-	s
19" five-tri-spoke wheels with 255/35 summer performance tires ¹	o	o
Singleframe [®] grille with choice of front license plate holder or filler panel with two chrome strips	s	s
Rain sensor for automatic windshield wipers	o	s
Heated windshield washer nozzles	s	s
LED turn signals in mirror housings	s	s
Power-adjustable and heated side mirrors	s	s
Power-adjustable, auto-dimming and heated exterior mirrors with memory function [Body color on A4; Aluminum Optic on S4]	o	o
Chrome trim around exterior windows	o	s
Power windows with one-touch up/down operation and pinch protection	s	s
Glass sunroof with sliding and tilting functions	s	s
Dual exhaust pipes, positioned left	s	-
S quad exhaust pipes, two left and two right	-	s
Halogen headlights with integrated high and low beams	s	-
Audi xenon plus headlights with automatic self-leveling and integrated LED daytime running lights	o	s
LED taillights [Option A4 Sedan only]	o	s
Two front fog lights located in lower front bumper	s	s
Automatic light switch controlled by light sensor, "coming home" and "leaving home" functions	o	s
Three-blink, touch-to-pass lane change feature in turn signal	s	s
Four-spoke, multifunction, leather-wrapped steering wheel with controls or audio volume	s	-
Three-spoke, sport, multifunction, leather-wrapped steering wheel with controls for audio volume, Bluetooth [®] phone and audio seek functions	o	s
Shift paddles on steering wheel [Automatic transmission]	o	s
Tilt and telescopic manually adjustable steering column	s	s
Interior lights in overhead console with front map lights	s	s
Red ambient LED lighting in headliner for front center console illumination	s	s
Front and rear floor mats	s	s
Aluminum doorsill inlays	s	s
Folding front center armrest with adjustable height	s	s
Storage nets in backs of front seats	s	s
Power central locking system with radio-operated key fob remote control for doors, deck lid and fuel door	s	s
Audi advanced key – keyless start, stop and entry	o	o
Automatic climate control	s	-
Three-zone automatic climate control	o	s
Dual front sun visors with lighted vanity mirror for driver and front passenger	s	s

Features	A4	S4
Electronic cruise control	s	s
Adaptive cruise control maintains preset distance from vehicle in front	o	o
Electric rear window defogger with automatic timed shut-off feature	s	s
Interior trunk release on driver's door	s	s
Leather seating surfaces	s	-
Leather seats with Alcantara [®] inserts	o	s
Silk Nappa leather upholstery	-	o
Eight-way power driver seat with four-way power lumbar adjustment	s	-
Eight-way power passenger seat	s	-
Memory for driver seat adjustment and exterior mirrors	o	o
Eight-way power sport front seats with four-way power lumbar adjustment	o	-
Eight-way power S sport seats with integrated headrests with four-way power lumbar adjustment	-	s
Six-step heated front seats	o	s
Split folding 60/40 rear seatback	s	s
Audi concert system with single CD player with MP3 playback capability, AM/FM radio, auxiliary input jack, SD [®] card slot for MP3 files and speed-dependent volume control	s	s
Bang & Olufsen [®] Sound System – 505 watt audio system with 14 speakers and ten-channel amplifier	o	o
SIRIUS [®] Satellite Radio with three-month trial subscription	s	s
Audi Sound System, 180 watts with ten speakers, including a subwoofer and center fill speaker	s	s
Voice control for navigation, audio function and telephone	o	o
Bluetooth [™] preparation for mobile phone	o	s
Rear parking sensors with rearview camera	o	o
Backlit instrument cluster with brightness control	s	s
Driver information system – trip computer, outside temperature, radio/telephone/navigation display, Auto-Check, open door/deck lid indicator	o	s

Packages	A4	S4
Audi Navigation plus Package: Audi Navigation plus ⁴ , voice control, rear parking sensors with camera, color driver information system display	o	o
HomeLink [®] and Bluetooth [®] Package	o	s
18" Sport Package: 18" wheels, sport seats, lumbar control for driver and passenger, sport suspension, shift paddles on automatic transmission models	o	-
19" Sport Package: 19" wheels, sport seats, lumbar control for driver and passenger, sport suspension, shift paddles on automatic transmission models	o	-
S line Package: Black leather/Alcantara [®] S line seats, 19" wheels, S line front and rear bumper, S line perforated steering wheel, Silver contrast stitching and S line doorsill inserts	o	-
Driver Assist Package: Audi side assist, rear parking sensors with camera	o	o
Audi Drive Select Package: Dynamic steering system, dynamic suspension system, dynamic engine/transmission settings, Audi drive select controls [S4 also includes quattro [®] with Sport Rear Differential]	o	o

-	Not Available	o	Option	s	Standard

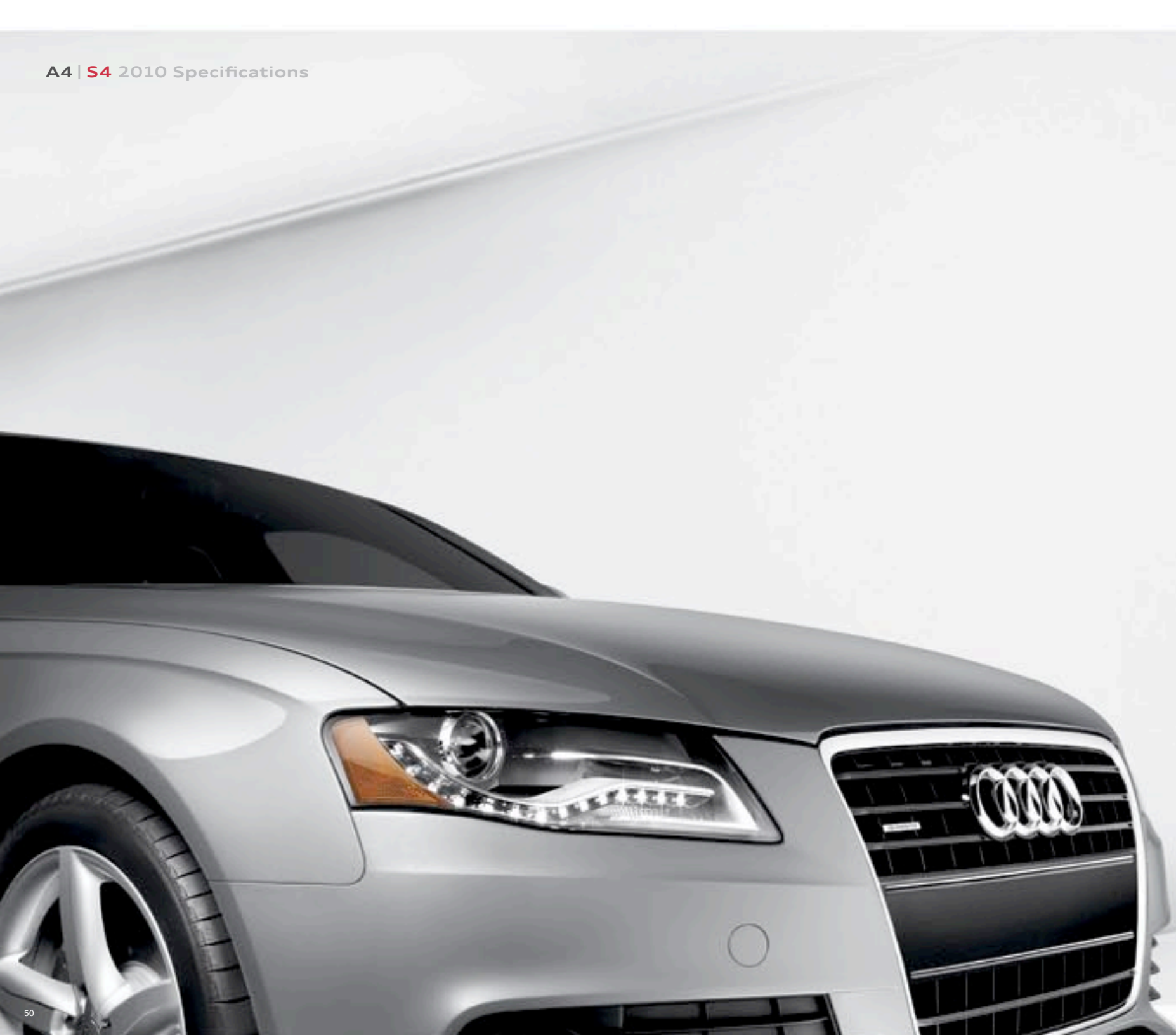

A4 Model Configurations

- 2.0 TFSI® with multitronic® CVT and FrontTrak® front-wheel drive
- 2.0 TFSI® with six-speed manual transmission and quattro® all-wheel drive
- 2.0 TFSI® with six-speed Tiptronic® transmission and quattro® all-wheel drive

Power and Performance

- + 2.0 liter turbocharged, DOHC in-line four-cylinder engine with FSI® direct injection, variable valve timing and Audi valvelift system
- + Bore: 3.25 in. Stroke: 3.65 in. Compression ratio: 9.6:1
- + Horsepower: 211 hp @ 4300-6000 rpm Torque: 258 lb-ft. @ 1500-4200 rpm
- + 0-60 MPH in seconds – multitronic®: 7.1, Manual: 6.4, Tiptronic®: 6.6
- + Top track speed*: 130 MPH
- + Fuel economy estimate, city/highway†: multitronic®: 23/30 MPG; Manual: 22/30 MPG; Tiptronic®: 21/27 MPG

S4 Model Configurations

- 3.0 TFSI® with six-speed manual transmission and quattro® all-wheel drive
- 3.0 TFSI® with seven-speed dual-clutch S tronic® transmission and quattro® all-wheel drive

Power and Performance

- + 3.0 liter supercharged, DOHC V6 gasoline engine with dual intercoolers, FSI® direct injection and variable valve timing
- + Bore: 3.33 in. Stroke: 3.5 in. Compression ratio: 10.3:1
- + Horsepower: 333 hp @ 5500-7000 rpm Torque: 325 lb-ft. @ 2900-5300 rpm
- + 0-60 MPH in seconds – Manual: 4.9, S tronic®: 4.9
- + Top track speed*: 155 MPH
- + Fuel economy estimate, city/highway‡: N/A

A4 Avant

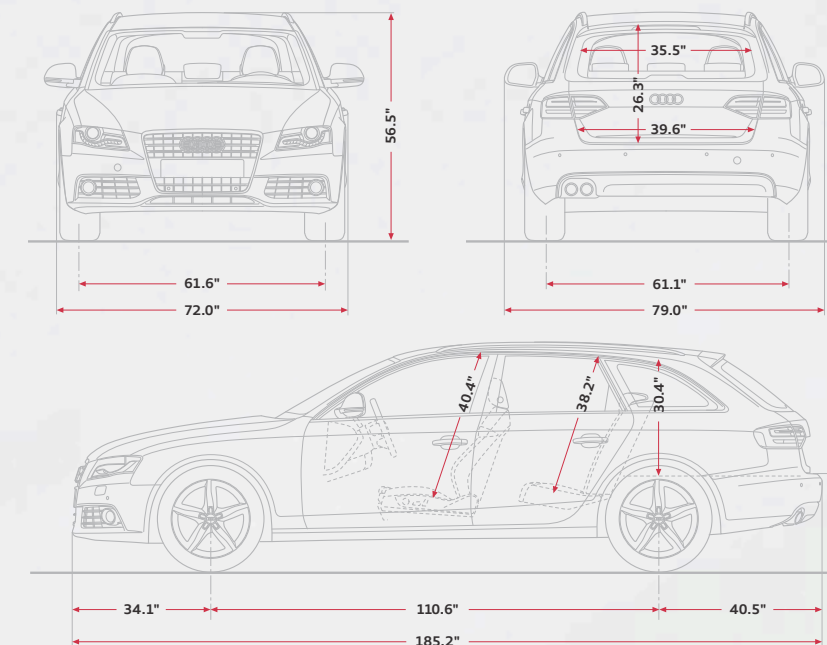

A4 | S4 Sedan

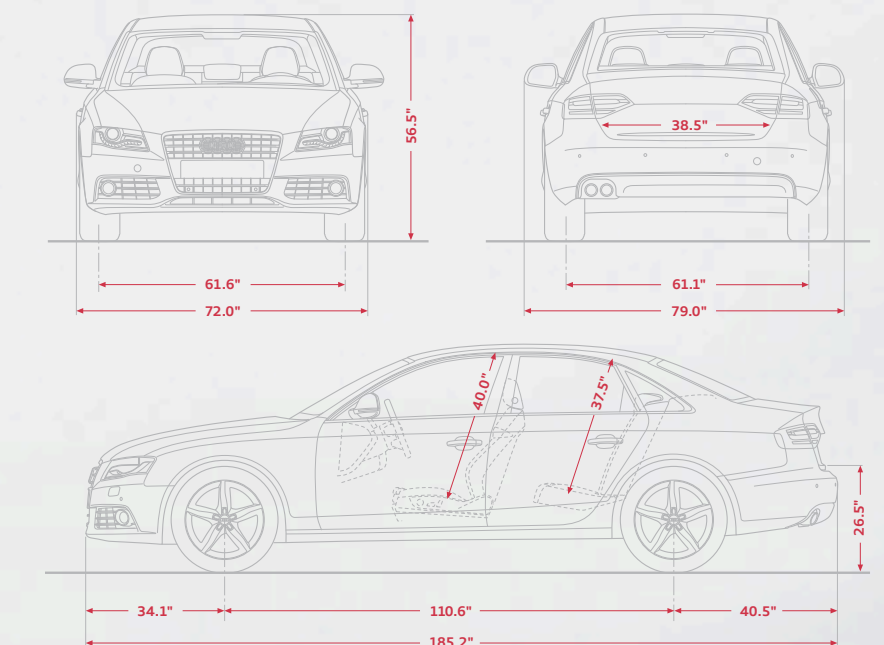

* Top track speed electronically limited to 130 MPH in the U.S. Obey all local speed and traffic laws. † EPA estimate; your mileage will vary. ‡ Top track speed electronically limited to 155 MPH in the U.S. Obey all local speed and traffic laws. § EPA estimate not available at the time of printing.



**With so much to offer, there is only one place
where you can experience it all.**

To fully interact with Audi, visit us online at any number of our special sites. From configuring your next Audi, to learning about the latest technology, to experiencing our passion for performance and racing, we invite you to explore the rich, stimulating world that is uniquely Audi.

audiusa.com/a4



Model Specific Info Summary

Dive into detailed information on the model you are considering. Each model in the Audi lineup has dedicated pages providing information on technical specifications, design, performance, safety and technology features, as well as extensive multimedia galleries.

audiusa.com/models



See All Models

Select from a remarkable array of engines, exterior colors, interior materials and progressive options to assemble your own unique Audi. You can print, request a quote or take your document to the nearest Audi dealer.

audiusa.com/technology



Technology Microsite

From the very beginning, advanced technology has been at the very heart of the Audi DNA. Contained in one convenient location, you will find great detail and demonstrations of many of our technologies.

audidrivingsite.com



Audi Driving Experience

The Audi driving experience and the Audi sportscar experience are designed to not only offer you a very special track experience in an Audi, but one that will leave you with a genuine appreciation for the technology that goes into every Audi vehicle.

audiusa.com/experience



Audi Experience

The experience section is your starting place for everything Audi. From an in-depth brand experience to a journey of our rich motorsports heritage or exclusive downloads, the online Audi Experience accommodates it all.

audi-collection.com



Audi Collection

Beautifully made. Beautifully designed. Faultlessly functional. All the qualities that distinguish our cars can also be found in our Audi collection. From performance wheels to products designed specifically with you and your particular Audi in mind to enhance the pleasure of driving and owning an Audi.

Four driven wheels are a part of what drives our progress.

Nearly 30 years ago, the notion of a car with permanent four-wheel drive was revolutionary. Audi called it quattro® and its benefits would set a new benchmark for driver confidence and performance. The simple, yet profound result of sending power to all wheels means that snow-covered mountain passes, rain-slicked highways and gravel-strewn rural roads are no longer encountered with apprehension. While on smooth dry roads, quattro® offers a level of performance unachievable by two-wheel drive cars.

The advantage of all-wheel drive was most apparent when Audi introduced quattro® to the World Rally Championship. quattro® seemed to defy physics with startling acceleration and remarkable traction. The result was an astounding 24 wins and a number of World Championships. If that wasn't enough of an endorsement for quattro®, it was later deemed an "unfair advantage" and banned from road racing altogether after repeatedly dominating the field.

Today, in that same competitive spirit, quattro® all-wheel drive continues to be refined. In Audi vehicles with a longitudinal engine configuration, quattro® is essentially a mechanical system with a self-locking center differential and continuously variable torque distribution. quattro® instantly responds to wheel speed differences and dynamically adjusts power to the wheels with the best traction. It is supported by advanced electronic control systems that together offer numerous benefits over other all-wheel drive systems. Featuring a 40:60 rear torque bias, the latest version of quattro® offers sportscar-like performance and handling with uncompromised all-wheel drive traction.

The power of quattro® is its ability to inspire driver confidence,
giving you traction when you need it, where you need it, regardless of road conditions.

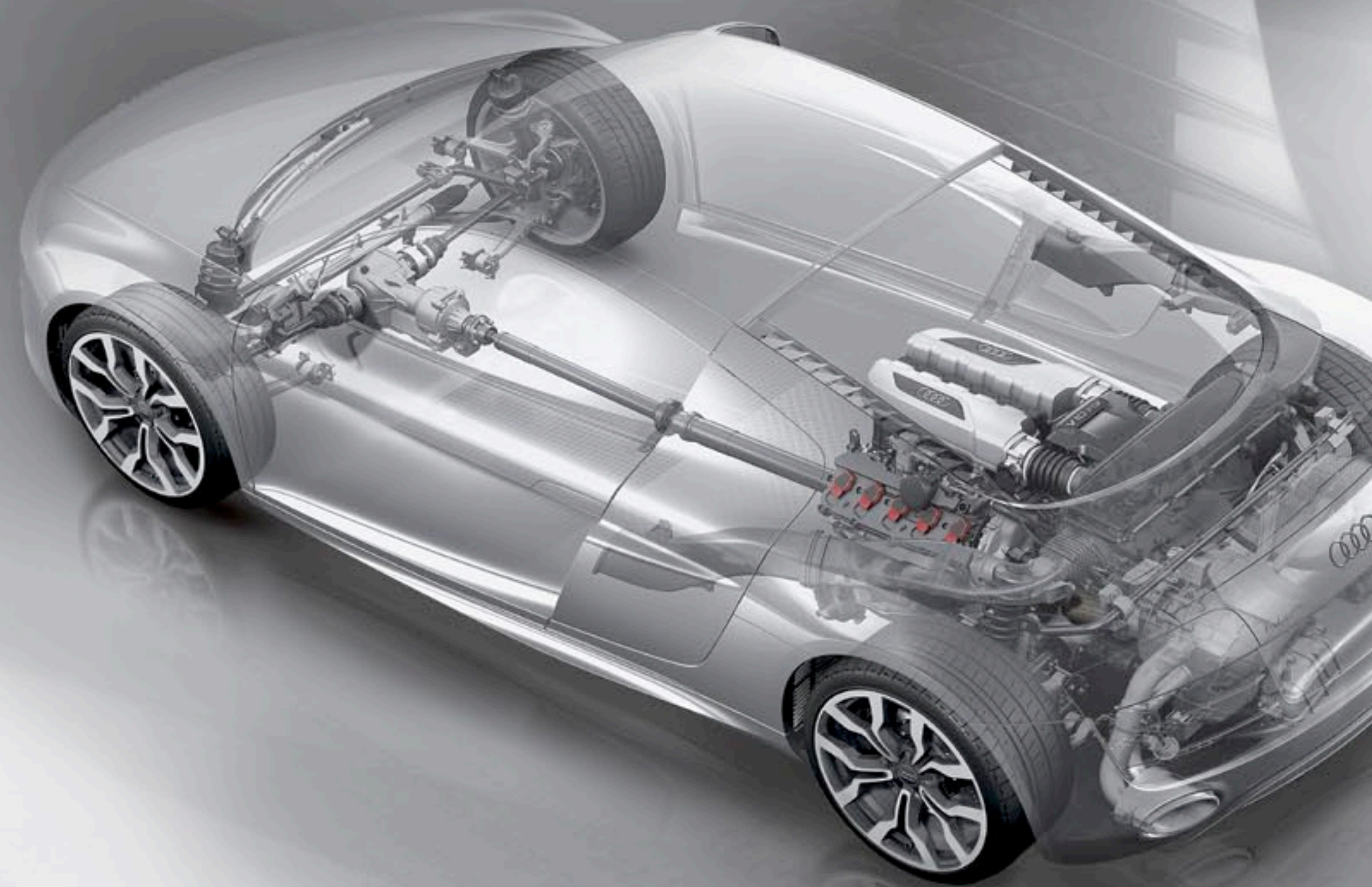



Together the future is ours.

August Horch founded this company on one word: **Progress**. Back in 1909.

To us, it is taking what seems undoable and then doing it. It is discovering what no one else has bothered to discover. It is turning skeptics into believers, and it is taking the thinking that wins on the racetrack and putting it on the road. Relentlessly designing, innovating, engineering and racing for the past 100 years have yielded amazing progress in our quest for the Truth. And although the Truth is absolute, it's in a constant state of motion always revealing new limits and opportunities. For instance, what seemed improbable has become the standard as we have created a diesel engine so quiet, so clean, so efficient and so powerful we put it to the ultimate test competing in the 24 Hours of Le Mans... winning three years in a row. But aside from walking away with trophies, we walked away with a deeper understanding of what to engineer into our cars for the street. The remarkable capabilities of TDI® clean diesel power, the all-wheel drive confidence of quattro®, and the increased power and efficiency of FSI® are but a few of those strands of DNA that have brought us that much closer to the Truth.

And it is that quest for the Truth that is behind every pencil line we draw, every calculation we make and every idea we deem not good enough. And although they may prove to be remarkable achievements in their own right, they represent a greater commitment to what is most important: **Truth in Engineering**.

Note: A word about this brochure. Audi of America, Inc. believes the specifications in this brochure to be correct at the time of printing. However, specifications, standard equipment, options and colors are subject to change without notice. Some equipment may be unavailable when your vehicle is built. Please ask your dealer for advice concerning current availability of standard and optional equipment and your dealer will verify that your vehicle will include the equipment you ordered. Vehicles in this brochure are shown with optional equipment. See your dealer for complete details on the new-vehicle limited warranty, twelve-year limited warranty against corrosion perforation and Audi 24/7 Roadside Assistance. [Roadside assistance coverage provided by Road America in the U.S. Certain conditions apply, see your dealer for details.] Tires supplied by various manufacturers. "Truth in Engineering" is a trademark of Audi of America, Inc. "Audi," "quattro," "A4," "S4," "Avant," "multitronic," "MMI," "FSI," "TFSI," "S tronic," "singleframe," "Sideguard" and the four rings logo are registered trademarks of AUDI AG. "Servotronic" is a registered trademark of the AM General Corporation. "Tiptronic" is a registered trademark of Dr. Ing h.c. F. Porsche AG. "Alcantara" is a registered trademark of Alcantara S.P.A. "ESP" is a registered trademark of Daimler AG. "HomeLink" is a registered trademark of Prince Corporation, Holland, Michigan. Prince is a wholly owned subsidiary of Johnson Controls. "Bang & Olufsen" is a registered trademark of the Bang & Olufsen Group. "NVIDIA" is a registered trademark of NVIDIA Corporation. "SIRIUS" is a registered trademark of SIRIUS Satellite Radio, Inc. "SD" is a registered trademark of SD-3C, LLC. "Bluetooth" is a registered trademark of Bluetooth SIG, Inc. "iPod" is a registered trademark of Apple, Inc.

©2009 Audi of America, Inc.

Free Manuals Download Website

<http://myh66.com>

<http://usermanuals.us>

<http://www.somanuals.com>

<http://www.4manuals.cc>

<http://www.manual-lib.com>

<http://www.404manual.com>

<http://www.luxmanual.com>

<http://aubethermostatmanual.com>

Golf course search by state

<http://golfingnear.com>

Email search by domain

<http://emailbydomain.com>

Auto manuals search

<http://auto.somanuals.com>

TV manuals search

<http://tv.somanuals.com>