

AXIS 233D
Network Dome Camera
User's Manual

2 About This Document

This manual is intended for administrators and users of the AXIS 233D Network Dome Camera, and is applicable for software release 4.40. It includes instructions for using and managing the AXIS 233D on your network. Previous experience of networking will be of use when installing and using this product. Some knowledge of UNIX or Linux-based systems would also be beneficial, for developing shell scripts and applications. Later versions of this document will be posted to the Axis Website, as required. See also the product's online help, available via the Web-based interface.

Intellectual Property Rights

Axis AB has intellectual property rights relating to technology embodied in the product described in this document. In particular, and without limitation, these intellectual property rights may include one or more of the patents listed at <http://www.axis.com/patent.htm> and one or more additional patents or pending patent applications in the US and other countries. This product includes software developed by the OpenSSL Project for use in the OpenSSL Toolkit: <http://www.openssl.org/>

Legal Considerations

Camera surveillance can be prohibited by laws that vary from country to country. Check the laws in your local region before using this product for surveillance purposes. This product includes one (1) MPEG-4 decoder license. To purchase further licenses, contact your reseller.

Electromagnetic Compatibility (EMC)

This equipment generates, uses and can radiate radio frequency energy and, if not installed and used in accordance with the instructions, may cause harmful interference to radio communications. However, there is no guarantee that interference will not occur in a particular installation. If this equipment does cause harmful interference to radio or television reception, which can be determined by turning the equipment off and on, the user is encouraged to try to correct the interference by one or more of the following measures: Re-orient or relocate the receiving antenna. Increase the separation between the equipment and receiver. Connect the equipment to an outlet on a different circuit to the receiver. Consult your dealer or an experienced radio/TV technician for help. Shielded (STP) network cables must be used with this unit to ensure compliance with EMC standards.

USA – This equipment has been tested and found to comply with the limits for a Class B computing device pursuant to Subpart B of Part 15 of FCC rules, which are designed to provide reasonable protection against such interference when operated in a commercial environment. Operation of this equipment in a residential area is likely to cause interference, in which case the user at his/her own expense will be required to take whatever measures may be required to correct the interference.

Canada – This Class B digital apparatus complies with Canadian ICES-003.

Europe –  This digital equipment fulfills the requirements for radiated emission according to limit B of EN55022/1998, and the requirements for immunity according to EN55024/1998 residential, commercial, and light industry.

Japan – This is a class B product based on the standard of the Voluntary Control Council for Interference from Information Technology Equipment (VCCI). If this is used

near a radio or television receiver in a domestic environment, it may cause radio interference. Install and use the equipment according to the instruction manual.

Australia – This electronic device meets the requirements of the Radio communications (Electromagnetic Compatibility) Standard 1998 AS/NZS 3548.

Liability

Every care has been taken in the preparation of this manual; Please inform your local Axis office of any inaccuracies or omissions. Axis Communications AB cannot be held responsible for any technical or typographical errors and reserves the right to make changes to the product and manuals without prior notice. Axis Communications AB makes no warranty of any kind with regard to the material contained within this document, including, but not limited to, the implied warranties of merchantability and fitness for a particular purpose. Axis Communications AB shall not be liable nor responsible for incidental or consequential damages in connection with the furnishing, performance or use of this material.

Trademark Acknowledgments

Acrobat, Adobe, Boa, Ethernet, IBM, Internet Explorer, Linux, Macintosh, Microsoft, Mozilla, Netscape Navigator, UNIX, Windows, WWW are registered trademarks of the respective holders. Java and all Java-based trademarks and logos are trademarks or registered trademarks of Sun Microsystems, Inc. in the United States and other countries. UPnP is a certification mark of the UPnP™ Implementers Corporation. Axis Communications AB is independent of Sun Microsystems Inc.

WEEE Directive

The European Union has enacted a Directive 2002/96/EC on Waste Electrical and Electronic Equipment (WEEE Directive). This directive is applicable in the European Union member states.



The WEEE marking on this product (see right) or its documentation indicates that the product must not be disposed of together with household waste. To prevent possible harm to human health and/or the environment, the product must be disposed of in an approved and environmentally safe recycling process. For further information on how to dispose of this product correctly, contact the product supplier, or the local authority responsible for waste disposal in your area.

Business users should contact the product supplier for information on how to dispose of this product correctly. This product should not be mixed with other commercial waste.

Axis Customer Services

Should you require any technical assistance, please contact your Axis reseller. If your questions cannot be answered immediately, your reseller will forward your queries through the appropriate channels to ensure a rapid response. If you are connected to the Internet, you can:

- download user documentation and firmware updates
- find answers to resolved problems in the FAQ database. Search by product, category, or phrases
- report problems to Axis support staff by logging in to your private support area
- visit the Axis Support Web at www.axis.com/techsup/

Safety Notice - Battery Replacement

The AXIS 233D uses a 3.0V CR2032 Lithium battery as the power supply for its internal real-time clock (RTC). This battery will, under normal conditions, last for a minimum of 5 years. Low battery power affects the operation of the RTC, causing it to reset at every power-up. A log message will appear when battery replacement is required.

The battery should not be replaced unless required!

If the battery does need replacing, please observe the following points:

Caution!

- Danger of Explosion if battery is incorrectly replaced
- Replace only with the same or equivalent battery, as recommended by the manufacturer.
- Dispose of used batteries according to the manufacturer's instructions.

AXIS 233D Network Dome Camera User's Manual
Revision 1.1
Date: June 2007
Part No: 29064
Copyright© Axis Communications AB, 2007

Table of contents

Product Overview	6
Overview	7
Status LED Indicator.....	8
Using the Network Dome Camera	9
Accessing the AXIS 233D.....	9
Video Streams	13
Stream Types.....	13
MPEG-4 protocols and communication methods	14
Other methods of accessing the video stream.....	16
Other MPEG-4 clients	16
Configuring the Network Dome Camera.....	17
Accessing the Setup Tools.....	17
Overview of the Setup Tools	17
Video & Image Settings	18
MPEG-4 Settings	22
Audio	23
Audio Settings.....	23
Advanced Audio	25
Live View Config	26
Layout	26
HTML Examples.....	29
External Video.....	30
Sequence Mode	30
Dome Configuration	31
Preset Positions.....	31
Event Configuration	33
Event Servers.....	33
Event Types	34
Motion Detection.....	37
Port Status	38
System Options.....	39
Security	39
Date & Time	41
Network - Basic TCP/IP Settings	43
Network - Advanced TCP/IP Settings	44

- SOCKS 47
- QoS (Quality of service) 47
- SMTP (email)..... 47
- SNMP..... 48
- UPnP™ 48
- RTP / MPEG-4 48
- Bonjour 48
- Ports & devices 48
- Maintenance..... 48
- Support 50
- Advanced..... 50
- About..... 51
- Resetting to Factory Default Settings..... 51
- I/O terminal Connectors..... 52
 - Power connections..... 53
 - I/O terminal connector blocks..... 54
- Troubleshooting 56
 - Checking the Firmware 56
 - Updating the Firmware 56
 - Emergency Recovery Procedure 57
 - LED Indicator flash routine 58
 - Support 59
 - Symptoms, Possible Causes and Remedial Actions 60
- Technical Specifications..... 62
 - General performance considerations 65
 - Optimizing your system 65
 - Frame rates..... 66
 - Bandwidth..... 66
- Index 67

Product Overview

The AXIS 233D Network Dome Camera is a high-performance, progressive-scan camera with security features such as HTTPS and IP address filtering for use in professional and demanding surveillance situations.

The perfect choice for large area surveillance environments where superior image quality on moving objects is important from a long distance.

Key Features

- 35x Zoom with EIS- EIS (Electronic Image Stabilizer) reduces the effect of the vibrations on the image. This feature is especially useful when the network camera is installed in places that are subject to vibrations such as near a highway
- Wide Dynamic Range - provides a better image in extreme lighting conditions
- Area zoom - Draw a square in the live view with your mouse and the AXIS 233D will zoom in that area
- Full frame rate at all resolutions in MPEG-4 or Motion JPEG
- E-flip - Electronic Flip inverts the image when a tracked target moves under the camera.
- Pan and Tilt speed: 0.05 - 450°/Sec
- Two-way audio
- Pre-/post-alarm buffer

Overview

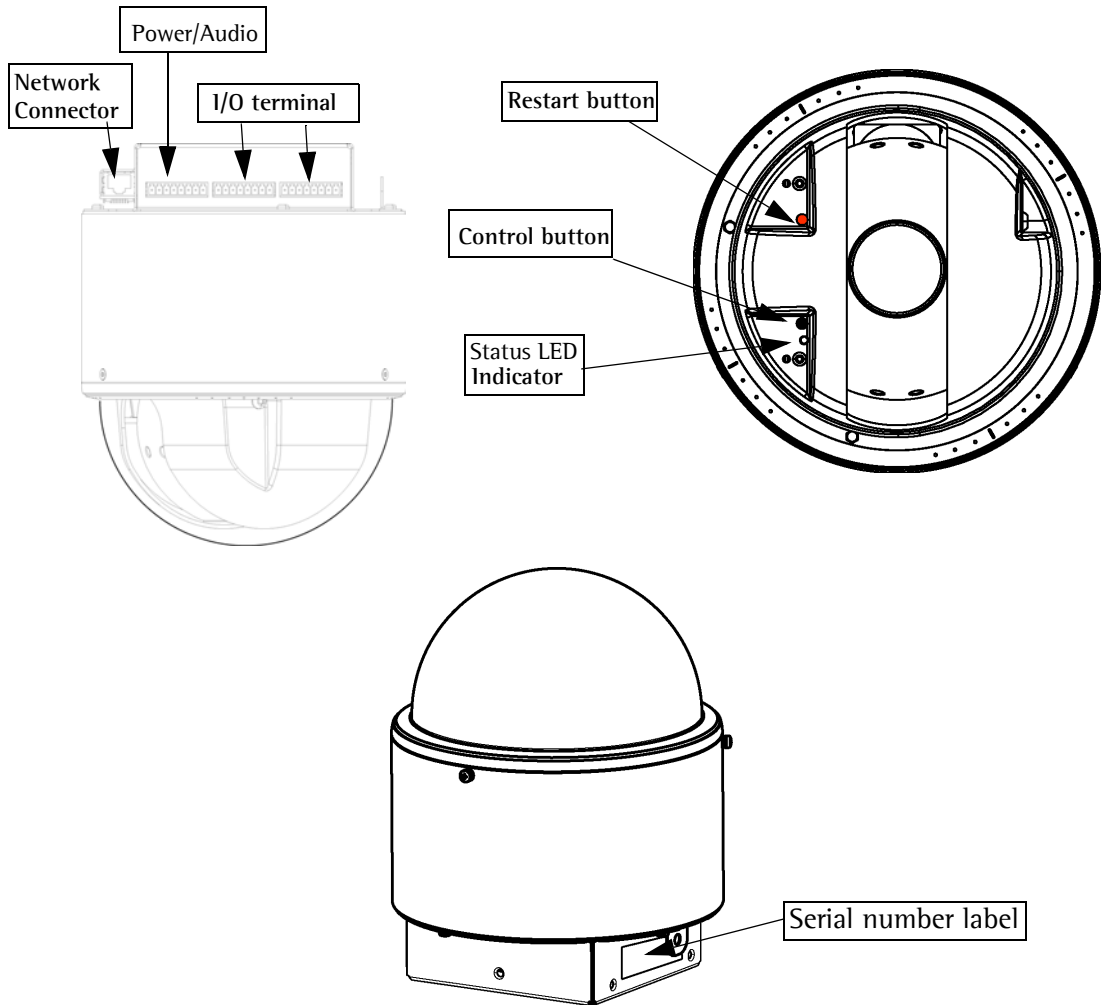

Network connector - The AXIS 233D connects to the network via a RJ-45 Ethernet connector. Using shielded cables is recommended.

Power/Audio connector - for connecting power supply and audio. See *Power connections, on page 53*.

I/O terminal connectors - The AXIS 233D has 3 (8 pin) I/O terminal connectors that provide the physical interface to four solid state relay outputs, 4 alarm inputs, auxiliary power and ground. See *I/O terminal connector blocks, on page 54*

Serial number - This number is located on the product label at the base of the camera and is used during installation and restoring the camera to factory default settings. Included in the package is an extra product label, put this in a safe place for future reference.

Restart button - This button power cycles the camera and is to be used during firmware upgrade or factory reset.

Control button - This button is used to restore the factory default settings as described in *Resetting to Factory Default Settings, on page 51*.

For instructions on how to install the AXIS 233D please refer to the Installation Guide which is supplied with the product in printed format or in PDF format from the Axis Web site at <http://www.axis.com>

Status LED Indicator

After completion of the startup and self test routines, the indicator flashes as follows. For more indicator flash routines see page 58.

Color	Description
Unlit	Steady connection/normal operation
Amber	Steady for system initiating. Flashes during firmware upgrade or reset to factory default
Amber/red	Flashes amber/red for no network connection
Red	Flashes red for firmware upgrade failure
Green	Shows steady green for 10 sec. for normal operation after restart

Using the Network Dome Camera

This document includes instructions for using and managing the AXIS 233D. For instructions on how to install the AXIS 233D on your network refer to the Installation Guide which is supplied with the product in printed format or in PDF format from the Axis Web site at <http://www.axis.com>

The AXIS 233D can be used with most standard operating systems and supports Microsoft Internet Explorer 6.x or later, Netscape 7.x or later and Mozilla 1.4 or later.

Accessing the AXIS 233D

1. Start a Web browser (Internet Explorer, Mozilla, Netscape Navigator).
2. Enter the IP address or host name of the AXIS 233D in the Location/Address field of your Web browser.
3. Enter the user name and password set by the administrator.
4. A video image is displayed in your Web browser.

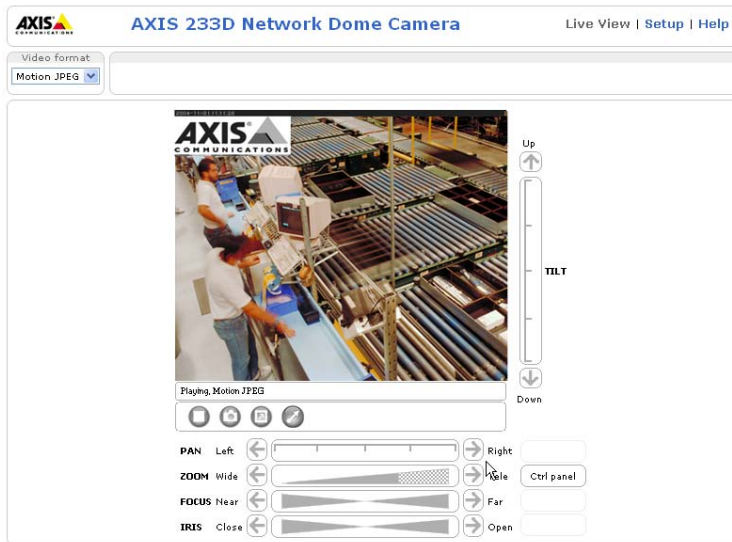
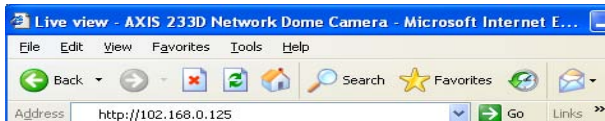

- Note:**
- To be able to view streaming video in Microsoft Internet Explorer, you must set your Web browser to allow ActiveX controls. If your working environment restricts the use of additional software components, you can configure the AXIS 233D to use a Java applet for updating images. Please refer to the online help files for more information.
 - User functions in the AXIS 233D may have been customized to meet the specific requirements of the application. Consequently, many of the examples and functions in this section may differ from those displayed in your Live View page.

If the AXIS 233D has been customized, the buttons and other items described below will be displayed accordingly on the Live View page. The following provides an overview of each button:

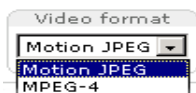

The Video Format drop-down list allows the video format on the Live View page to be temporarily changed.



The **Output** buttons control an output directly from the Live View page. These buttons are configured under **Setup > Live View Config > Layout**.

Pulse - click this button to activate the port for a defined period of time, e.g. to switch on a light for 20 seconds.



Active/Inactive - click these buttons to manually start and stop a connected device, e.g. switch a light on/off.



These buttons start/stop the **Sequence Mode**. This mode is created in **Setup > Live View Config > Sequence mode** and automatically displays the view from preset positions at set intervals.



The **Action** buttons trigger an action directly from the Live View page. These buttons are configured under **Setup > Live View Config > Layout**. Click these buttons to manually start and stop events.



Use the **Snapshot** button to capture a snapshot of the image currently being displayed in the window. Right-click on the image to save it in JPEG format on your computer.

Ctrl panel



Click the **Ctrl panel** button to access the following buttons:

- **Auto focus:** Automatically adjusts the image focus.
- **Auto iris:** Automatically adjusts the amount of light reaching the image sensor for best image results.
- **Backlight comp:** Enabling backlight compensation makes the subject clearer if the image background is too bright, or if the subject is too dark.
- **IR cut filter:** When set to off, the camera will be able to “see” infrared light, e.g. at night, it increases light sensitivity. The image is shown in black & white when the IR cut filter is off. Set to **Auto** to automatically turn the filter off when the available visible light falls below the minimum requirement.





Note: There are different buttons in the Control Panel depending on the computer's operating system but the descriptions and functionality are the same.

The AMC viewer toolbar (AXIS Media Control), available from Microsoft Internet Explorer, displays the following buttons:

-  The **Play/Stop** buttons start and stop the live video stream.
-  The **Snapshot** button takes a snapshot of the currently displayed image. The Snapshot function and the target directory for saving snapshots can be configured from AMC (AXIS Media Control), which is available from the Windows Control Panel (Internet Explorer only).
-  Click the **View Full Screen** button and the video image will fill the entire screen area. No other windows will be visible. Press Esc (Escape) on the computer keyboard to cancel full screen view.

Click-in-image movement

-  Click the **Set emulated joystick mode** button and click in the image to move the camera in the desired direction
-  Click the **Center** button and the camera view will center on the position that was clicked. The location to move to has a definite position, e.g. position x,y.

Area Zoom

This allows you to draw a box over a desired area to zoom into. To activate, click the Center button described in the AMC viewer toolbar or in other Internet browsers choose PTZ > Center. Using your mouse click in the image and while holding down the left mouse button draw a square over the area you would like to zoom into.

Pan/Tilt/Zoom Controls

The Live View page also displays the Pan/Tilt/Zoom controls. The administrator can enable/disable the control for specified users under **System Options > Security > Users > User List**.

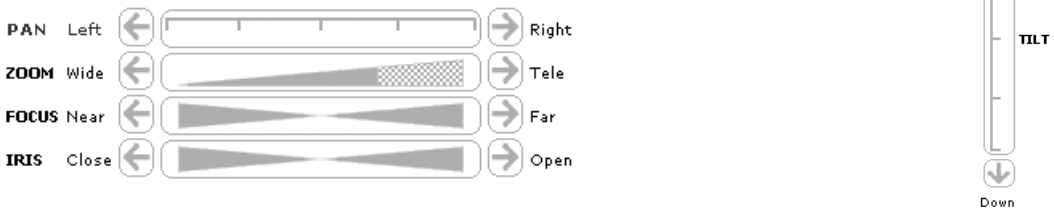







Pan/Tilt/Zoom Control Queue

The time the user is in control of the PTZ settings is limited and a queue of users has been set up. Use the buttons to request or release control of the Pan/Tilt/Zoom controllers.

PTZ Control Queue	
Status in queue:	<input type="text" value="You are possessing the control."/> Position in queue: <input type="text" value="1"/>
Time remaining:	<input type="text" value="37"/> seconds <input type="button" value="Release control"/>

The Pan/Tilt/Zoom Control Queue is set up by the administrator under:
Dome Configuration > Advanced > Control Queue.

The Toolbar available from Mozilla Firefox, displays the following buttons:

-   The **Play/Stop** buttons start and stop the live video stream.
-  The **Snapshot** button takes a snapshot of the currently displayed image. The Snapshot function and the target directory for saving snapshots can be configured from AMC (AXIS Media Control), which is available from the Windows Control Panel (Internet Explorer only).
-  Click the **View Full Screen** button and the video image will fill the entire screen area. No other windows will be visible. Press Esc (Escape) on the computer keyboard to cancel full screen view.
-  Click the **Set emulated joystick mode** button and click in the image to move the camera in the desired direction
-  Click the **Center** button and the camera view will center on the position that was clicked. The location to move to has a definite position, e.g. position x,y.

AXIS 295 Video Surveillance Joystick

The AXIS 295 is a USB device that gives responsive and accurate control of the pan, tilt, zoom functionality. On installation, the joystick is automatically detected by AXIS Media Control where the 12 buttons can be programmed for a customized video surveillance system. For more information, please visit the Axis Website at <http://www.axis.com>

Video Streams

The AXIS 233D provides several different image and video stream formats. The type to use depends on your requirements and on the properties of your network.

The Live View page in the AXIS 233D provides access to Motion JPEG and MPEG-4 video streams, as well as to single JPEG images. Other applications and clients can also access these video streams/images directly, without going via the Live View page.

Stream Types

Motion JPEG

This format uses standard JPEG still images in the video stream. These images are then displayed and updated at a rate sufficient to create a stream that shows constantly updated motion.

The Motion JPEG stream uses more bandwidth, but also provides excellent image quality and access to each and every individual image contained in the stream.

Note also that multiple clients accessing Motion JPEG streams can use different image settings.

MPEG-4

This is a video compression standard that makes good use of bandwidth, and which can provide high quality video streams at less than 1 Mbit/s.

- Notes:**
- MPEG-4 is licensed technology. The AXIS 233D includes one viewing client license. Installing additional unlicensed copies of the viewing client is prohibited. To purchase additional licenses, contact your Axis reseller.
 - All clients viewing the MPEG-4 stream must use the same image settings.

The MPEG-4 standard provides scope for a large range of different coding tools for use by various applications in different situations, and the AXIS 233D provides certain subsets of these tools. These are represented as **Video object types**, which are selected for use with different viewing clients. The supported video object types are:

- **Simple** - sets the coding type to H.263, as used by e.g. QuickTime™.
- **Advanced Simple** - sets the coding type to MPEG-4 Part 2, as used by AMC (AXIS Media Control)

When using MPEG-4 it is also possible to control the bit rate, which in turn allows the amount of bandwidth usage to be controlled. CBR (Constant Bit Rate) is used to achieve a specific bit rate by varying the quality of the MPEG-4 stream. When using VBR (Variable Bit Rate), the quality of the video stream is kept as constant as possible, at the cost of a varying bit rate.

MPEG-4 protocols and communication methods

To deliver live streaming video over IP networks, various combinations of transport protocols and broadcast methods are employed.

- RTP (Realtime Transport Protocol) is a protocol that allows programs to manage the real-time transmission of multimedia data, via unicast or multicast.
- RTSP (Real Time Streaming Protocol) serves as a control protocol, to negotiate which transport protocol to use for the stream. RTSP is thus used by a viewing client to start a unicast session, see below.
- UDP (User Datagram Protocol) is a communications protocol that offers limited service for exchanging data in a network that uses the Internet Protocol (IP). UDP is an alternative to the Transmission Control Protocol (TCP). The advantage of UDP is that it is not required to deliver all data and may drop network packets when there is e.g. network congestion. This is suitable for live video, as there is no point in re-transmitting old information that will not be displayed anyway.
- Unicasting is communication between a single sender and a single receiver over a network. This means that the video stream goes independently to each user, and each user gets their own stream. A benefit of unicasting is that if one stream fails, it only affects one user.
- Multicast is bandwidth-conserving technology that reduces bandwidth usage by simultaneously delivering a single stream of information to multiple network recipients. This technology is used primarily on delimited networks (intranets), as each user needs an uninterrupted data flow and should not rely on network routers.

How to stream MPEG-4

Deciding on the combination of protocols and methods to use depends on your viewing requirements, and on the properties of your network.

RTP+RTSP

This method (actually RTP over UDP and RTSP over TCP) should be your first consideration for live video, especially when it is important to always have an up-to-date video stream, even if some images do get dropped. This can be configured as multicast or unicast.

Multicasting provides the most efficient usage of bandwidth, especially when there are large numbers of clients viewing simultaneously. Note however, that a multicast broadcast cannot pass a network router unless the router is configured to allow this. It is thus not possible to multicast over e.g. the Internet.

Unicasting should be used for video-on-demand broadcasting. However, if more and more unicast clients connect simultaneously, the server will at some point become overloaded. There is also a maximum of 20 simultaneous viewers to be considered.

RTP/RTSP

This unicast method is RTP tunneled over RTSP. This can be used to exploit the fact that it is relatively simple to configure firewalls to allow RTSP traffic.

RTP/RTSP/HTTP or RTP/RTSP/HTTPS

These two methods can also be used to traverse firewalls. Firewalls are commonly configured to allow the HTTP protocol, thus allowing RTP to be tunneled.

The AXIS Media Control

The recommended method of accessing live video (MPEG-4 and/or Motion JPEG) from the AXIS 233D is to use the AXIS Media Control (AMC) in Microsoft Internet Explorer in Windows. This ActiveX component is automatically installed on first use, after which it can be configured by opening the AMC Control Panel applet from the Windows Control Panel. Alternatively, right-click the video image in Internet Explorer.

Other methods of accessing the video stream

Video/images from the AXIS 233D can also be accessed in the following ways:

- If supported by the client, the AXIS 233D can use Motion JPEG server push to display video. This option maintains an open HTTP connection to the browser and sends data as and when required, for as long as required.
- As single JPEG images in a browser. Enter e.g. the path:
http://<ip>/axis-cgi/jpg/image.cgi?resolution=CIF
- Windows Media Player. This requires AMC and the MPEG-4 decoder to be installed. The paths that can be used are listed below, in the order of preference.
 - Unicast via RTP: axrtpu://<ip>/mpeg4/media.amp
 - Unicast via RTSP: axrtsp://<ip>/mpeg4/media.amp
 - Unicast via RTSP, tunneled via HTTP: axrtsphhttp://<ip>/mpeg4/media.amp
 - Unicast via RTSP, tunneled via HTTPS: axrtsphhttps://<ip>/mpeg4/media.amp
 - Multicast: axrtmp://<ip>/mpeg4/media.amp

Other MPEG-4 clients

Although it may be possible to use other clients to view the MPEG-4 stream, this is not guaranteed by Axis. For some other clients, e.g. QuickTime™ the Video Object Type must be set to *Simple*, under **Video & Image > Advanced > MPEG-4**. It may also be necessary to adjust the advanced MPEG-4 settings. To access the video stream from e.g. QuickTime™ the following path can be used:

rtsp://<ip>/mpeg4/media.amp

This path is for all supported methods, and the client will negotiate with the network camera to determine exactly which transport protocol to use.

Notes: <ip> = IP address

Configuring the Network Dome Camera

This section describes how to configure the AXIS 233D and is intended for the product **Administrator** who has unrestricted access to all Setup tools and **Operator** who has access to Video & Image, Live View Config and Event Configuration. See the section on *Security*, on page 39 for more information on user access control.

The AXIS 233D is configured under Setup from a standard browser.

Accessing the Setup Tools

Follow the instructions below to access the Setup Tools from a Web browser.

1. Start the Web browser and enter the IP address or domain name of the AXIS 233D in the location/address field.
2. The Live View page is now displayed. Click **Setup** to display the Setup configuration tools.

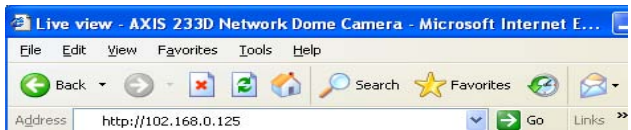

Overview of the Setup Tools

Setup Configuration

AXIS 233D Network Dome Camera Live View Setup Help	<h3 style="margin: 0;">Basic Configuration</h3> <p style="font-size: small; margin: 5px 0;">Before using the AXIS 233D Network Dome Camera, there are certain settings that should be made, most of which require Administrator access privileges. To quickly access these settings, use the numbered shortcuts to the left. All the settings are also available from the standard setup links in the menu.</p> <p style="font-size: small; margin: 5px 0;">Note that the only required setting is the IP address, which is set on the TCP/IP page. All other settings are optional. Please see the online help for more information.</p> <p style="margin: 5px 0;">Firmware version: 4.40 MAC address: 00:00:00:00:00:00</p>
<ul style="list-style-type: none"> ▾ Basic Configuration <ul style="list-style-type: none"> Instructions 1. Users 2. TCP/IP 3. Date & Time 4. Video & Image 5. Audio ▸ Video & Image ▸ Audio ▸ Live View Config ▸ Dome Configuration ▸ Event Configuration ▸ System Options About 	

Video & Image Settings

The following descriptions offer examples of the available features in the AXIS 233D. For details of each setting, please refer to the online help files which are available from each page. Click  to access the help files.

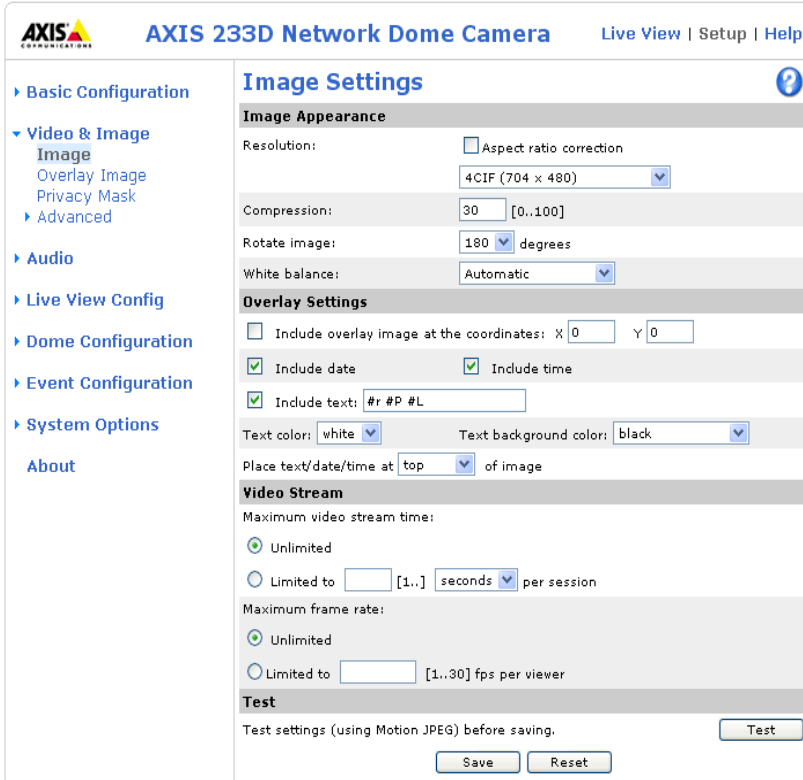

AXIS 233D Network Dome Camera Live View | Setup | Help

Image Settings 

Image Appearance

Resolution: Aspect ratio correction
4CIF (704 x 480)

Compression: 30 [0..100]

Rotate image: 180 degrees

White balance: Automatic

Overlay Settings

Include overlay image at the coordinates: X 0 Y 0

Include date Include time

Include text: #r #P #L

Text color: white Text background color: black

Place text/date/time at: top of image

Video Stream

Maximum video stream time:

Unlimited

Limited to [] [1..] seconds per session

Maximum frame rate:

Unlimited

Limited to [] [1..30] fps per viewer

Test

Test settings (using Motion JPEG) before saving.

Image Settings

To optimize the video images according to your requirements, modify the following settings under **Image Appearance**. Each setting is described in the online help files .

All configuration of images and overlays will affect the performance of the network camera, depending on the usage and the available bandwidth.

- High resolution generates larger files
- Lower compression improves image quality, but generates larger files
- Black & White uses less bandwidth than Color

See also the specifications for frame rates and bandwidth in *General performance considerations*, on page 65.

Overlay Settings

Use these settings to include an image as an overlay, and/or the date and time, along with text of your own.

Text overlays are all included on one line at the top or bottom of the video image. Use text overlays in combination with OSDI (On-Screen Directional Indicator) on page 31 to aid the viewer in navigating the camera.



Example:

To set up PTZ coordinates in text overlay.

Overlay Settings

Include overlay image at the coordinates: X Y

Include date Include time

Include text:

Text color: Text background color:

Place text/date/time at of image

To show the Preset and OSDI Zone name as text overlay use #P #L

Video Stream

The **Maximum video stream time** can be set as *Unlimited*, or a maximum stream time per session in seconds, minutes or hours can be defined. When the set time has expired, a new stream can be started by refreshing the page in the Web browser. Note that the maximum video stream time does not apply to clients connecting via multicast.

To avoid bandwidth problems on the network, the **frame rate** allowed to each viewer can also be limited. Select either *Unlimited* or define a maximum frame rate per viewer.

For a preview of the image and overlay settings before saving, click **Test**. When you are satisfied with the settings, click **Save**.

Please use the online help files for more information.

Overlay Image Settings

An overlay image is an image included in the video image. This might, for example, be your own company logo. Follow these instructions to upload and use an overlay image:

1. Go to **Setup > Video & Image > Overlay Image**.
2. To upload the file (a logo or image) to the AXIS 233D, click the **Browse** button and locate it on your computer or server.
3. Click the **Upload** button and follow the on-screen instructions.
4. The image is now available in the **Use overlay image** drop-down list.
5. Click **Save**.
6. Go to **Setup > Video & Image** and modify the parameters under **Overlay Settings**.

Overlay image requirements		Overlay image limitations
Image Formats	Image Size	<ul style="list-style-type: none"> • If the image overlay and text overlay are larger than the video image, no overlay will be displayed. When also using a text overlay, this will occupy 16 pixels in height and as many in width as the video image. • If the overlay is initially positioned so that part of it is outside the video image, it will be relocated so that it appears over the video image, i.e. the entire image is always displayed. • The maximum overlay image size supported by the AXIS 233D is the same as the maximum image resolution. See Technical Specifications, on page 46.
<ul style="list-style-type: none"> • Windows 24-bit BMP (full color) • Windows 4-bit BMP (16 colors) • OS/2 4-bit BMP (16 colors) 	The height and width of the overlay image in pixels must be exactly divisible by 4.	

Privacy Mask

Privacy masks allow you to mask areas in an image that are prohibited for the viewer. A 3D mask, covers the area regardless of the camera's angle or zoom position.

To set up a privacy mask:

1. Go to **Setup > Video & Image > Privacy Mask** and click on the **Add** button.
2. Move the camera's view so that the area to be masked is at the center of the image.
3. Use zoom or change the **Width** and **Height** values to adjust size of the masked area.
4. Click **Save**.

Advanced Camera Settings

To optimize the lighting settings according to your requirements, modify the following settings under **Lighting Conditions**:

- Color level, Brightness and Sharpness- Find the level that best suits your image needs by testing.
- Exposure control - this setting is used to adapt to the amount/type of light being used. **Allow slow shutter** can be enabled/disabled when the exposure control is set to Automatic.
- Exposure area-This setting determines which part of the image will be used to calculate the exposure.
- IR cut filter - when the IR cut filter is set to OFF, the camera will be able to 'see' infrared light, e.g. at night, thus making the image clearer. The image is shown in black & white when the IR cut filter is off.
Note: If set to Auto, the camera will automatically switch between IR cut filter ON and OFF, according to the current lighting conditions. This is only possible when the iris is set to Auto Iris, and the exposure control is set to Automatic.
- Wide dynamic range - Corrects the exposure when the contrast is extreme

between light and dark in an image. Test the different levels to find the one that works best of your light conditions.

- Backlight compensation - this setting is used to make the subject appear clearer, e.g. against a bright background.

Low Light Behavior

The settings for **Low Light Behavior** determine how the camera will behave at low light levels. These settings affect video image quality and frame rate.

Exposure control - This setting is used to adapt to the amount or type of light used. **Automatic** is the default setting and can be used in most situations. The shutter speed is automatically set to produce optimum image quality. Use **Manual** if you have special requirements for the exposure setting

Max exposure time - Increasing the exposure time will improve image quality, but at the expense of the total frame rate. There may also be an increase in motion blur.

Max gain - Measured in decibels (dB), the default value is 36 dB. A high level of amplification may provide a better image in very low light situations.

Shutter speed - A slower shutter speed in dark conditions will help to produce a brighter image, but will produce fewer frames per second which may cause images to be blurry during motion.

Please use the online help files  for more information.

Image Settings

- Auto focus enabled (default setting).
- Stabilizer - When monitoring an environment that is subject to vibrations (i.e. traffic control) the images can appear to be unsteady. Choose the frequency (High or Low) that best applies to your environment to improve image quality.
- Image freeze on PTZ - Set this option to On to freeze the image during camera movement. Once the camera reaches its position the current image is shown. Auto freezes images only between preset positions.

MPEG-4 Settings

Tools for adjusting the MPEG-4 settings and for controlling the video bit rate.

The MPEG-4 standard provides many different coding tools for various applications in different situations. As most MPEG-4 clients do not support all of these tools, it is usual to instead define and use subsets for different clients or groups of clients. These settings allow you to define the type of viewing client to use.

Adjusting the maximum bit rate and setting it to variable or constant is a good way of controlling the bandwidth used by the MPEG-4 video stream.

For more information on these advanced settings, please see the online help files [?](#)

Audio

The AXIS 233D can transmit audio to other clients by connecting an external microphone and can play audio received from other clients via a connected speaker.

Audio Settings

This section describes how to configure the basic audio settings for the AXIS 233D, e.g. set the communication mode and adjust the sound levels in the microphone and speaker connected to the camera.

Enable Audio - Check this box to enable audio.

Audio Channels

The AXIS 233D has four types of audio transmission. Choose which type best suits your needs.

Audio mode

- **Full duplex mode** has simultaneous two-way audio, which means you can talk and listen at the same time.
- **Half duplex mode** transmits and receives audio in both directions, but only in one direction at a time. This means that you must select when to receive or transmit audio with the push-to-talk button. To speak, press and hold the button (check that the microphone is not muted). When finished speaking, release the button and you will receive audio from the other end of the connection.

Note: the push-to-talk button is configured from AMC. It is also possible to configure the push-to-talk button so that it toggles between speaking and listening modes.

- When selecting **Simplex - Network Camera speaker only** mode, the speaker connected to the camera will play audio, but no audio will be transmitted from the camera to other web clients. This could be used to e.g. provide spoken instructions to a person seen in the camera. This mode requires you to use the push-to-talk button.
- **Simplex - Network Camera microphone only** mode transmits audio only from the AXIS 233D to web clients. It will not receive audio from any other web clients. This can be used in remote monitoring, web attractions etc., to provide live audio, as well as video, of a monitored situation.

When using half-duplex, the **Send the sound from the active client to all other clients** option transmits the audio signal from the client that is talking to all the other clients.

Audio Input

Audio from an external microphone or a line source can be connected to the Audio in Power/Audio connector of the AXIS 233D, see *I/O terminal connector blocks*, on page 54. The audio source must be set to **Microphone** or **Line** depending on the connected device.

When **Microphone** is selected as a **Source**, set the **Input sensitivity** to **High** for an ordinary (unamplified) microphone, e.g. a computer mic or clip-on mic. Set to **Low** for a microphone with a built-in line amplifier.

The **Enable microphone power** option provides DC power for an external microphone. If using a small electret condenser microphone such as a clip-on or PC microphone, this option needs to be enabled.

Note: To use a high impedance dynamic microphone, DC power should not be enabled. DC power will not harm the microphone, but if you are uncertain, try switching it off and on. The default value is DC power enabled. To use a professional microphone requiring 48V phantom power, you need an external power supply and must use a balanced-unbalanced converter (audio transformer) in between.

If there are problems with the sound input being too low or high, adjust the **input gain** for the microphone attached to the AXIS 233D.

Select the desired audio **Encoding** format, G711, G726.

Depending on the selected encoding, set the desired audio quality (**Bit rate**). The settings depend on the available bandwidth and the required audio quality.

The AXIS 233D can be set to trigger an event if the incoming sound level rises above, falls below or passes the set value. The **Alarm level** is set between 0-100%.

Audio Output

If the sound from the speaker is too low or high, adjust the **output gain** for the active speaker attached to the AXIS 233D.

When satisfied with the settings, click **Save**, or click **Reset** to revert to the previously saved settings.

Note: To receive synchronized video and audio, it is recommended that the time settings in the camera and client PC are synchronized with an NTP Server. This is enabled in the camera under **System Options > Date & Time**. Please refer to the help pages for more information.

Advanced Audio

Advanced audio settings can improve audio quality by speech filtering and echo and noise cancellation.

When enabled the **speech filter** reduces noise by filtering out all the frequencies below 100HZ and above 3500 Hz. This improves the sound quality if a person is close to the microphone when talking and will reduce background noises.

Enable echo cancellation to reduce acoustic echoing that can be caused by audio coming from a speaker being captured by a microphone.

Noise cancelling is a way of reducing the background noise if the microphone, for example, is set up in a noisy environment and you are only interested in hearing a person who is talking close to the microphone. The **noise canceller attenuation** produces maximum noise reduction when set to 18dB of attenuation. Optimize the sound quality by listening to the sound and adjusting the attenuation level as required.

Live View Config

Layout

These are the tools for deciding the layout of the Live View page.

The layout can be set in 3 ways:

- Use Axis look - the layout is unchanged.
- Use custom settings - modify the default page with your own colors, images etc. Click the **Configure** button and see the following page.
- Own Home Page - Upload and use your own custom made page as the default web page. Click the **Configure** button and see the following page.

The other settings on this page concern which other features to include, e.g. buttons and links. See page 27 for more information.

Customizing the default page

The appearance of the default AXIS 233D Live View page can be customized to suit your own requirements, or you can upload and use your own home page. To upload your own files, click the **Upload/Remove** button and see the description below.

AXIS 233D Network Dome Camera Live View | Setup | Help

Basic Configuration | Video & Image | Audio | **Live View Config** | Dome Configuration | Event Configuration | System Options | About

Live View Layout

Use Axis look
 Use custom settings **Configure...**

User Defined Links

Show custom link	Name	URL	Use as
<input type="checkbox"/>	Custom link 1	http://	<input checked="" type="radio"/> cgi link <input type="radio"/> web link
<input type="checkbox"/>	Custom link 2	http://	<input checked="" type="radio"/> cgi link <input type="radio"/> web link
<input type="checkbox"/>	Custom link 3	http://	<input checked="" type="radio"/> cgi link <input type="radio"/> web link
<input type="checkbox"/>	Custom link 4	http://	<input checked="" type="radio"/> cgi link <input type="radio"/> web link

Action Buttons

Show manual trigger button
 Show snapshot button

Output Buttons

Output 1:
 Output 2:
 Output 3:
 Output 4:

Default Video Format

Video format: Motion JPEG
 Show video format selection

Default Viewer

Windows Internet Explorer: AMC (ActiveX)
 Other Browsers: Server push

Viewer Settings

Show viewer toolbar
 Enable MPEG-4 decoder installation
 Show crosshair in PTZ joystick mode*
 Use PTZ joystick mode as default*
 Enable recording button

Note: QuickTime is only used with MPEG-4. Motion JPEG will be shown with AMC in Windows Internet Explorer and with server push in other browsers.
 *Not applicable to AMC (ActiveX).

Save Reset

Live View Config/Custom Settings - AXIS 233D Network Dome Camera - Microsoft Internet Explorer

Custom Settings

Upload Own Web Files

To upload or remove your own web files, click **Upload/Remove...** (administrator only)

Modify the Axis Look

Background color: Default Own: White
 Text color: Default Own: Black
 Background picture: None Own: External: http://
 Banner: None Own: External: http://
 Banner link: None Own: http://
 Logo: None Default Own: External: http://
 Logo link: None Default Own: http://
 Title: None Default Own: Title text above image
 Description: None Default Own: Description text below image

Show setup link*

* Caution! Unchecking the box for Show setup link will remove the setup link from the product's Home Page. The Setup Tools will then only be accessible by entering the full setup address into the address/URL field of a browser. The setup address for this product is http://10.94.127.248/operator/basic.shtml.

Preview the page before saving Preview

Own Home Page

Use own home page:

OK Cancel

Note that the setup address is:

http://<ip address>/operator/basic.shtml

Upload Own Web Files

Your own web files, background picture, color etc. must first be uploaded to the AXIS 233D in order to be available for selection in the Custom Settings setup dialog. Once uploaded, the files are shown in the drop-down list.

1. Enter the path to the file, e.g. a file located on your workstation or click the **Browse** button.
2. Select the user level for the uploaded file. Setting the user access level means that you have complete control over which pages can be viewed by which users.
3. When the path is shown correctly in the text field, click the **Upload** button.

All uploaded files are shown in the list in the lower section of the page. To remove a file, check the box provided next to it and then click the **Remove** button.

- To use your uploaded file, click the radio button and select the file from the drop-down list by **Own**:
- To use an external file located somewhere other than in the AXIS 233D, click the radio button and enter the URL by **External**:

Own Home Page

To use a previously uploaded web page as the default page, check the checkbox, select the page from the drop-down list and click OK.

User Defined Links

User defined links can be CGI links or web links. Once configured, the link(s) will appear on the Live View page.

To set up a **web link**, select the **Use as web link** radio button, enter a descriptive name and enter the URL in the provided field. Click **Save** and the link will appear on the Live View page.

User defined **CGI links** can be used to issue HTTP API requests, e.g. PTZ commands.

Example:

1. Check **Show Custom Link 1**
2. Enter a descriptive name, e.g. CAM START.
3. Select the **Use as cgi link** radio button and enter the cgi link in the field:
`http://192.168.0.125/axis-cgi/com/ptz.cgi?continuouspantiltmove=30,-30`



User Defined Links

4. Check **Show Custom Link 2**.
5. Enter a descriptive name, e.g. CAM STOP.
6. Select the **Use as cgi link** radio button and enter the cgi link in the field:
`http://192.168.0.125/axis-cgi/com/ptz.cgi?continuouspaniltmove=0,0`
7. These links will appear in the web interface and can be used to control the AXIS 233D.

For more information on the Axis HTTP API, see the Support / Developer pages on the Axis Web site at <http://www.axis.com>.

Please use the online help files  for more information.

For more information on the Axis HTTP API, see the Support / Developer pages on the Axis Web site at <http://www.axis.com>. See also the section on PTZ, on page 11.

Action Buttons

These buttons can be used to manually trigger and stop an event from the Live View page. The snapshot button allows you to take a snapshot of the video stream and save it to a computer.

Output Buttons

These buttons are used to control the outputs on the AXIS 233D and thus the equipment connected to them, e.g. to switch a light on or off:

- The Pulse button activates the port for a defined period
- Active/Inactive displays 2 buttons, one for each action (on/off)

Default Video Format

Select the default video format to use on the Live View page. Checking the box for **Show video format selection** displays a drop-down list on the Live View page allowing you to temporarily change the format.

When using MPEG-4 as the video format, the default viewer is AXIS Media Control with Internet Explorer.

Note: It is also possible to view Motion JPEG when MPEG-4 is chosen as default and vice versa.

Default Viewer

From the drop-down lists, select the default method for viewing video images for your browser. The camera will attempt to show the video images in the selected video format and viewer. If this is not possible, the camera will override the settings and select the best available combination.

Browser	Viewer	Description
Windows Internet Explorer	AMC	Recommended viewer in Windows Internet Explorer (MPEG-4 /Motion JPEG).
	QuickTime	MPEG-4 only.
	Java applet	A slower imaging alternative to AMC. Requires one of the following installed on the client: <ul style="list-style-type: none"> • JVM (J2SE) 1.4.2 or higher • JRE (J2SE) 5.0 or higher
	Still image	Displays still images only. Hit the Refresh button in your browser to view a new image.
Other browsers	Server Push	Recommended viewer for other browsers (Motion JPEG).
	QuickTime	MPEG-4 only.
	Java applet	A slower imaging alternative to Server Push (Motion JPEG only).
	Still image	Displays still images only. Hit the Refresh button in your browser to view a new image.

Viewer Settings

Checking the **Show viewer toolbar box** displays the toolbar under the video stream.

By checking the **Enable MPEG-4 decoder installation** box, it is also possible for the Administrator to enable or disable the installation of the MPEG-4 decoder. This is used to prevent the installation of unlicensed copies. Further decoder licenses can be purchased from your Axis dealer.

Check the **Show crosshair in PTZ joystick mode** checkbox to indicate the center of the image when viewing the video stream in PTZ joystick mode.

Enable recording button - allows the viewer to start a recording at any time by clicking on the record button.

HTML Examples

You can add live video from the AXIS 233D to your own web site. The camera can transmit a Motion JPEG stream to up to 20 simultaneous connections, although an administrator can restrict this to fewer. If MPEG-4 is set as video format, multicasting is used and the audio and video stream will be available for an unlimited number of viewers connected to the parts of the network where multicast is enabled. Please note that a separate MPEG-4 license is required for each viewer.

Select the preferred **Video Format** from the drop down list. The available options are Motion JPEG, MPEG-4 using AMC and MPEG-4 using QuickTime.

The Motion JPEG selection has additional settings for **Image Type**, **Image size** and other optional settings to configure the video stream to suit your Web page. Click **Update** once satisfied.

The camera generates the required source code for your configuration. Copy this code and paste it into your own Web page code.

External Video

An external video source is a source originating from some other Axis device on the network. The images from these sources can be displayed just as if they were produced by the AXIS 233D.

The External Video Source list shows all of the external video sources currently configured. The information displayed is the source's name and the path to the video stream. Up to 20 external video sources can be configured.

Working with External Video Sources

1. To add a new video source, click the Add button. This opens the External Video Source Setup dialog, which is used to make all the necessary settings.
2. To modify an existing video source, select it and click the Modify button.
3. To delete an external video source, select it and click the Remove button.

Sequence Mode

Sequence Mode is a configuration that automatically displays the view from multiple, previously defined Preset Positions (see *Dome Configuration*, on page 31 and the online help).

This is useful for e.g. security personnel viewing a surveillance system that constantly rotates through the selected preset positions, in the listed order, or randomly.

To set up sequence mode, simply select the desired preset positions and enter the number of seconds or minutes to display each position for. Each position can be displayed for up to 59 minutes.

Dome Configuration

Preset Positions

A preset position is a pre-defined camera view than can be used to quickly move the camera to a specific location.

From **Preset Position Setup**, use the Pan, Tilt and Zoom (PTZ) controls to steer the camera to the required position. When satisfied with the camera’s position, enter a descriptive name. The camera position, iris and focus settings are then saved as a preset position.

The position can be assumed at any time, by selecting the preset’s name from the Preset positions drop-down list. Preset positions can be selected in **Live View**, from events, in **Sequence mode** and in the **Guard Tour**.

One position can be set as the **Home** position, which is readily accessible by clicking on the **H** button in both the Preset Position Setup window and the Live View window. The position’s name will have (H) added, e.g. Office Entrance (H).

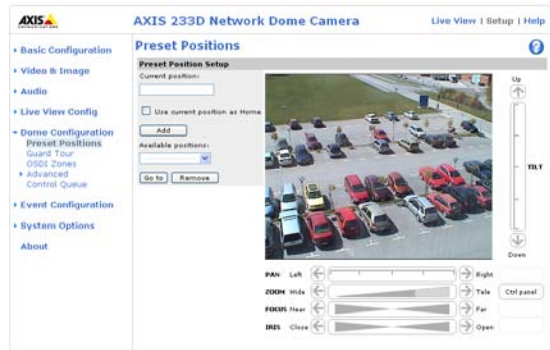

Include the preset position name in the overlay text. See *Overlay Settings*, on page 19.

Guard Tour

A guard tour displays the different preset positions, one-by-one, in a pre-determined order or randomly, and for configurable time periods. Once the preset position has been set, and added to the guard tour, the following settings can be made:

- View Time in seconds or minutes
- Move Speed - sets the speed of the Pan/Tilt movements to the preset position
- View Order (or Random)

OSDI Zones

On-screen Direction Indicator Zones are areas that you define with coordinates and a descriptive name. These zones can then be included in the Image text to aid the viewer in navigating the camera.

The camera uses the coordinates of the center of the image to set the lower left and upper right zone areas. First navigate where you would like the most lower left point of the OSDI Zone to be located. By clicking on the Get button the coordinates are set. Proceed to where the upper right point of the zone should be located and click on its Get button. Give the zone a descriptive name and go to *Overlay Settings*, on page 19 for information about including the name of OSDI Zone in the Image text.

Advanced

Limits - Define the **pan**, **tilt**, **zoom** and **focus** limits for the AXIS 233D. Movements to the left and right, up and down can be restricted to narrow the area under surveillance. The near focus limit can be set to avoid focusing on objects too close to the camera.

Note: Once a limit has been saved, this position can not be exceeded by the AXIS 233D unless the values have been reset and saved to a greater value first (i.e. reset the default values of the mechanical restrictions).

Move speed sets the speed of the camera's Pan/Tilt movements. The default setting is maximum speed.

E-flip - This flips the image automatically when the target moves, for example, under the camera and then moves on. In situations where E-flip is not desired set the Lower limit to -90° , which will turn off this function.

Ctrl Panel - Shortcut command buttons can be created to provide direct access to various commands provided by the AXIS 233D. The buttons are then displayed in the PTZ Panel which is available on the Live View page by clicking Ctrl Panel (see page 10). AXIS VAPIX gives you the possibility to create your own commands. For more information go to www.axis.com

Control Queue - The administrator can set up a queue for the PTZ controllers. Once set up, the PTZ Control Queue buttons will appear on the Live View page offering one viewer exclusive control for a limited amount of time. Other users will be placed in the queue.

PTZ Control Queue	
Status in queue:	You are possessing the control.
Position in queue:	1
Time remaining:	37 seconds
Release control	

PTZ Control Queue on Live View page

Please use the online help files [?](#) for more information.

Event Configuration

This section describes how to configure the AXIS 233D for alarm handling. The AXIS 233D can be configured to perform certain actions when certain types of events occur.

Event type	A set of parameters describing how and when the Network Dome Camera is to perform certain actions	
Triggered Event page 34	the circumstances that start an event	e.g. at a signal from an external device, such as a door switch or a motion sensor
Scheduled Event page 36	the circumstances that start an event	e.g. at a pre-programmed time
Action	what occurs when the event triggers	e.g. uploaded video images to an FTP server, email notification, etc.

Event Servers

Event Servers are used, e.g. for receiving uploaded image files and/or notification messages. To set up Event server connections in your AXIS 233D, go to **Setup > Event Configuration > Event Servers** and enter the required information according to the selected server type.

Server type	Purpose	Requires information
FTP Server	<ul style="list-style-type: none"> used for uploading saved images 	<ul style="list-style-type: none"> Descriptive name of your choice User Name and Password (to FTP server) Upload path e.g. images/ Port number e.g. port 21 Use passive mode if there is a firewall between the AXIS 233D and the FTP server
HTTP Server	<ul style="list-style-type: none"> used for notification messages used for uploading saved images 	<ul style="list-style-type: none"> Descriptive name of your choice URL User Name and Password (to HTTP server) Proxy address/Proxy port (if required) Proxy User Name and Password (if required)
TCP Server	<ul style="list-style-type: none"> used for notification messages 	<ul style="list-style-type: none"> Descriptive name of your choice User Name and Password (to TCP server) Port number e.g. port 80

For details on each setting, please refer to the online help files  which are available from each web page.

Note: Pre-trigger and Post-trigger buffers will be lost if the connection to the event server fails.

When the setup is complete, the connection can be tested by clicking the **Test** button (the connection test will take approximately 10 seconds).

Event Types

An Event Type is a set of parameters describing how and when the Network Dome Camera is to perform certain actions.

Example: If a door is opened, and an event has been configured to act on this, the Network Dome Camera can e.g. record and save video images to an FTP server or send a notification email to a pre-configured email address with a pre-configured message. Video images can be sent as an attachment with the email.

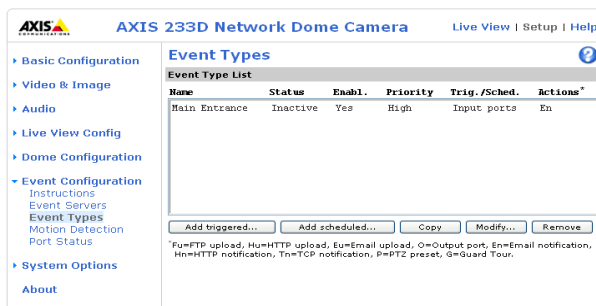

Triggered Event

A Triggered event is activated from, e.g:

- a switch (doorbell) connected to an input port on the Network Dome Camera
- lost signal from the camera
- a manually activated action e.g. from an action button in the web interface
- on restart (reboot) after e.g. power loss

How to set up a triggered event

This example describes how to set the Network Dome Camera to upload images when the main door is opened:

1. Click **Add triggered** on the Event types page.
2. Enter a descriptive **name** for the event, e.g. Main door.
3. Set the **priority** - High, Normal or Low (see online help files).
4. Set the **Respond to Trigger...** parameters when the event is to be active, e.g. only after office hours
5. Select the trigger alternative from the **Triggered by...** drop-down list, e.g. an Input port with a connected sensor if the door is opened.
6. Set the **When Triggered...** parameters i.e. set what the Network Dome Camera is to do if the main door is opened e.g. upload images to an FTP server.
7. Click **OK** to save the Event in the Event Types list.

Please use the online help files  for descriptions of each available option.

Pre-trigger and Post-trigger buffers

This function is very useful when checking to see what happened immediately before and after a trigger, e.g. 2 minutes before and after a door has been opened.

Go to Event Types > Add Triggered... > When Triggered... and check the Upload images checkbox to expand the web page with the available options.

Buffer size - up to 36 MB buffer. The maximum length of time of the pre-/post-buffer depends on the image size and selected frame rate.

Include pre-trigger buffer - images stored internally in the server from the time immediately preceding the trigger. Check the box to enable the pre-trigger buffer, enter the desired length of time and specify the required image frequency.

Include post-trigger buffer - contains images from the time immediately after the trigger. Configure as for pre-trigger.

Note: If the pre- or post-buffer is too large for the internal memory, the frame rate will be reduced and individual images may be missing. If this occurs, an entry will be created in the unit's log file.

Continue image upload (unbuffered) - enable the upload of images for a fixed length of time. Specify the length of time for the uploaded recording, in seconds, minutes or hours, or for as long as the trigger is active. Finally, set the desired image frequency to the maximum (the maximum available) or to a specified frame rate. The frame rate will be the best possible, but might not be as high as specified, especially if uploading via a slow connection.

Scheduled Event

A **Scheduled** event can be activated at pre-set times, in a repeating pattern on selected weekdays.

How to set up a scheduled event

This example describes how to set the Network Dome Camera to send an email notification with saved images from at a set time:

1. Click **Add scheduled** on the **Event types** page.
2. Enter a descriptive **name** for the event, e.g. **Scheduled email**.
3. Set the **priority** (**High**, **Normal** or **Low**).
4. Set the **Activation Time** parameters (24h clock) when the event is to be active, e.g. start on **Fridays** at **18.00** with a duration of **62** hours.
5. Set the **When Activated...** parameters i.e. set what the Network Dome Camera is to do at the specified time e.g. send uploaded images to an email address.
6. Click **OK** to save the Event in the Event Types list.

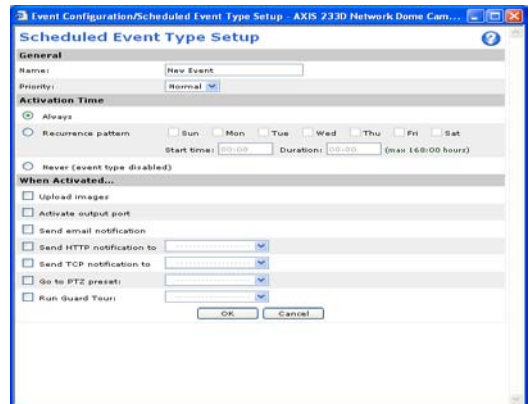

Please use the online help files  for descriptions of each available option.

Motion Detection

Motion detection is used to generate an alarm whenever movement occurs (or stops) in the video image. A total of 10 Include and/or Exclude windows can be configured.

- **Included** windows target specific areas within the whole video image
- **Excluded** windows define areas within an Include window that should be ignored (areas outside Include windows are automatically ignored)

Once configured, the motion detection windows will appear in the list of available triggers, for triggering events. See *How to set up a triggered event* above.

Note: Using the motion detection feature may decrease the camera's overall performance.

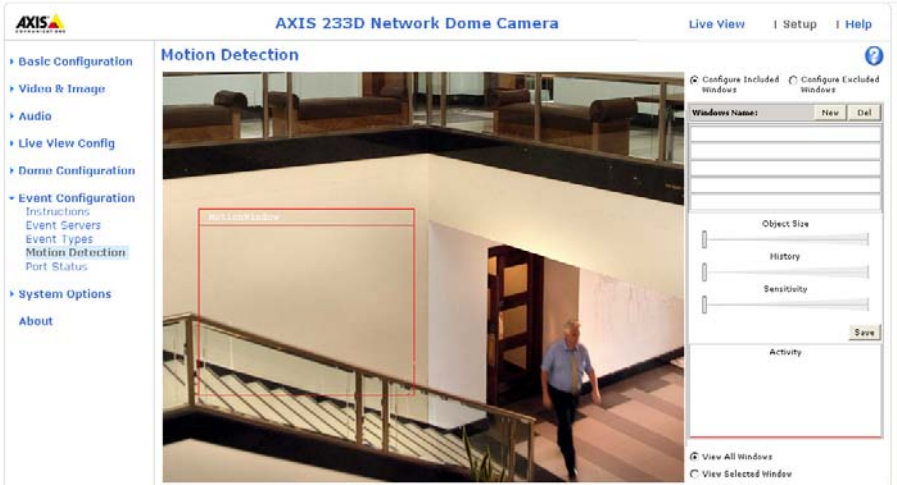

Configuring Motion Detection

1. Click **Motion Detection** in the **Event Configuration** menu.
2. Click the **Configure Included Window** radio button and click **New**.
3. Enter a descriptive name under **Window name**.
4. Adjust the size (drag the bottom right-hand corner) and position (click on the text at the top and drag to the desired position).
5. Adjust the Object size, History and Sensitivity profile sliders (see table below for details). Any detected motion within an active window is then indicated by red peaks in the **Activity** window (the active window has a red frame).
6. Click **Save**.

To exclude parts of the Include window, click the **Configure Excluded Windows** button and position the Exclude window as required, within the Include window.

Please see the online help  for descriptions of each available option.

	Object Size	History	Sensitivity
High level	Only very large objects trigger motion detection	An object that appears in the region will trigger the motion detection for a long period	Ordinary colored objects on ordinary backgrounds will trigger the motion detection
Low level	Even very small objects trigger motion detection	An object that appears in the region will trigger motion detection for only a very short period	Only very bright objects on a dark background will trigger motion detection
Default value	Low	Medium to High	Medium to High

Examples:

- Avoid triggering on small objects in the video image by setting the **object size** level to high.
- To reduce the number of triggers if there is a lot of movement during a short period of time, select a high history level.
- To only detect flashing light, low **sensitivity** can be selected. In other cases, a high sensitivity level is recommended.

Port Status

Under **Event Configuration > Port Status** there is a list that shows the status for the connected inputs and outputs of the AXIS 233D for the benefit of the Operator who cannot access the System Options section.

Example: If the Normal state for a push button (e.g. doorbell) connected to an input is set to **Open circuit** – as long as the button is not pushed, the state is **inactive**. If the push button is pushed, the state of the input changes to **active**.

System Options

Security

User access control is enabled by default, the administrator sets the root password on first access. Other users are authorized with user names and passwords, or the administrator can choose to allow anonymous viewer login to the Live View page, as described below:

Users - the user list displays the authorized users and access levels:

User	Description
Viewer	Provides the lowest level of access, which only allows the user access to the Live View page.
Operator	An Operator can view the Live View page, create and modify event types and adjust certain other settings. The Operator does not have access to the Systems Options configuration pages.
Administrator	An administrator has unrestricted access to the Setup Tools and can determine the registration of all other users.

User Settings - check the corresponding checkboxes to enable:

- **Anonymous viewer login** - allows any viewer direct access to the Live View page.
- **Maximum number of simultaneous viewers** - enter a value here to restrict the number of Motion JPEG and MPEG-4 viewers accessing the unit. This is useful if you need to save on bandwidth. Note that within the limit of 20 users, all multi-cast viewers count as 1 viewer.
- **Anonymous PTZ control login** - allows any viewer access to the Pan/Tilt/Zoom controllers on the Live View page.

IP Address Filtering

Enable **IP Address Filtering** to allow or deny access to the AXIS 233D. Once enabled, the IP addresses in the list will be allowed or denied access according to the choice made in the drop-down list **Allow/Deny** the following IP addresses.

The administrator can add up to 256 IP address entries to the list (a single entry can contain multiple IP addresses). The users from these IP addresses need to be specified in the user list with the appropriate access rights. This is done from **Setup > System Options > Security > Users**.

Referrals

To prevent unauthorized clients from including the video stream from the cameras into external Web pages, check the **Referrals** checkbox and enter the IP address or Host name of the computer that hosts the Web pages with the included video stream. Several IP addresses/host names can be defined and are separated by semicolons (;). This option is only applicable to Motion JPEG video streams.

Notes: If the referrals feature is enabled and you wish to also allow normal access to the Live View page, the product's own IP address or host name must be added to the list of allowed referrers.

Restricting referrers has no effect on an MPEG-4 video stream. To restrict an MPEG-4 stream, IP address filtering must be enabled.

Restricting referrers is of greatest value when not using IP address filtering. If IP address filtering is used, then the allowed referrers are automatically restricted to those allowed IP addresses.

HTTPS

For greater security, the AXIS 233D can be configured to use HTTPS (Hypertext Transfer Protocol over SSL (Secure Socket Layer)). That is, all communication that would otherwise go via HTTP will instead go via an encrypted HTTPS connection.

Certificate - to use HTTPS for communication with the AXIS 233D, a **Certificate** must be created using one of the following methods:

- A self-signed certificate can be created in the network camera, but this does not guarantee the same level of security as an official certificate.
- An official certificate issued by a CA (Certificate Authority). A CA issues and manages security credentials and public keys for message encryption.
 1. Click either **Create self-signed certificate** or **Create Certificate Request** and enter the required information in the provided fields.
 2. Click **OK**.
 3. **Create self-signed certificate** generates and installs a certificate which will be displayed under **Installed Certificate**. **Create Certificate Request** generates a PEM formatted request which you copy and send to a CA for signing. When the signed certificate is returned, click **Install signed certificate...** to install the certificate in the AXIS 233D.
 4. Set the **HTTPS Connection Policy** for the administrator, Operator and Viewer to enable HTTPS connection (set to HTTP by default)

Please refer to the home page of your preferred CA for information on where to send the request etc. For more information, please refer to the online help files 

802.1X - Network Admission Control

IEEE 802.1X is an IEEE standard for port-based Network Admission Control. It provides authentication to devices attached to a network port (wired or wireless), establishing a point-to-point connection, or, if authentication fails, preventing access on that port. 802.1X is based on EAP (Extensible Authentication Protocol).

In a 802.1X enabled network switch, clients equipped with the correct software can be authenticated and allowed or denied network access at the Ethernet level.

Clients and servers in an 802.1X network may need to authenticate each other by some means. In the Axis implementation this is done with the help of digital certificates provided by a **Certification Authority**. These are then validated by a third-party entity, such as a **RADIUS** server, examples of which are Free Radius and Microsoft Internet Authentication Service.

To perform the authentication, the RADIUS server uses various EAP methods/protocols, of which there are many. The one used in the Axis implementation is EAP-TLS (EAP-Transport Layer Security).

The AXIS network video device presents its certificate to the network switch, which in turn forwards this to the RADIUS server. The RADIUS server validates or rejects the certificate and responds to the switch, and sends its own certificate to the client for validation. The switch then allows or denies network access accordingly, on a pre-configured port.

The authentication process

1. A CA server provides the required signed certificates.
2. The Axis video device requests access to the protected network at the network switch. The switch forwards the video device's CA certificate to the RADIUS server, which then replies to the switch.
3. The switch forwards the RADIUS server's CA certificate to the video device, which also replies to the switch.
4. The switch keeps track of all responses to the validation requests. If all certificates are validated, the Axis video device is allowed access to the protected network via a pre-configured port.

RADIUS (Remote Authentication Dial In User Service) - AAA (Authentication, Authorization and Accounting) protocol for applications such as network access or IP mobility. It is intended to work in both local and roaming situations.

CA servers - In cryptography, a Certification Authority (CA) is an entity that provides signed digital certificates for use by other parties, thus acting a trusted third party. There are many commercial CA's that charge for their services. Institutions and governments may have their own CA, and there are free CA's available.

Date & Time

Current Server Time - displays the current date and time (24h clock). The time can be displayed in 12h clock format in the Overlay Images (see below).

New Server Time - Select your time zone from the drop-down list and check the daylight saving time changes, if desired.

From the **Time Mode** section, select the preferred method to use for setting the time:

- **Synchronize with computer time** - sets the time from the clock on your computer.
- **Synchronize with NTP Server** - the network camera will obtain the time from an NTP server every 60 minutes. Specify the NTP server's IP address or host name.

Note: Note that if using a host name for the NTP server, a DNS server must be configured under **TCP/IP** settings. See **Network > Advanced TCP/IP Settings** below.

- **Set manually** - this option allows you to manually set the time and date.

Date & Time Format Used in Images - specify the formats for the date and time (12h or 24h) displayed in the Live View video streams.

Use the predefined formats or use your own custom date and time formats. See **Advanced File Naming & Date/Time Formats** in the help files  for information on how to create your own file formats.

Network - Basic TCP/IP Settings

IP Address Configuration

The AXIS 233D supports both IP version 4 and IP version 6. Both versions may be enabled simultaneously, and at least one version must always be enabled.

When using IPv4, the IP address for the AXIS 233D can be set automatically via DHCP, or a static IP address can be set manually.

If IPv6 is enabled, the AXIS 233D will receive an IP address according to the configuration in the network router.

There are also options for setting up notification of changes in the IP address, and for using the AXIS Internet Dynamic DNS Service. For more information on setting the IP address, please see the online help.

- Notes:**
- DHCP is a protocol for automatic IP address assignment on a network. IP address assignment via DHCP may lead to the situation where the IP address changes and you lose contact. Configure the options for notification of IP address change (under Services) to receive notification from the network camera when the IP address changes.
 - Alternatively, if your DHCP server can update a DNS server, you can access the AXIS 233D by host name which is always the same, regardless of the IP address.

For more information, please refer to the online help files 

Services

Enable ARP/Ping setting of IP address - The IP address can be set using the ARP/Ping method, which associates the unit's MAC address with an IP address. Check this box to enable the service. Leave disabled to prevent unintentional resetting of the IP address.

- Notes:**
- The ARP/Ping service is automatically disabled 2 minutes after the unit is started, or as soon as an IP address is set.
 - Pinging the unit will still be possible when this service is disabled.

Options for notification of IP address change - If the IP address for the camera changes, e.g. automatically by DHCP, you can choose to be notified of the change. Click Settings... and enter the required information.

AXIS Internet Dynamic DNS Service - Use the AXIS Internet Dynamic DNS service to assign a host name for easy access to your AXIS 233D (requires Internet access).

Click Settings... to register the camera with the Axis Internet Dynamic DNS service, or to modify the existing settings (requires access to the Internet). The domain name currently registered at the Axis Internet Dynamic DNS service for your product can at any time be removed.

Network - Advanced TCP/IP Settings

DNS Configuration

DNS (Domain Name Service) provides the translation of host names to IP addresses on your network.

Obtain DNS server address via DHCP - automatically use the DNS server settings provided by the DHCP server. Click the View button to see the current settings.

Use the following DNS server address - enter the desired DNS server by specifying the following:

Domain name - enter the domain(s) to search for the host name used by the AXIS 233D. Multiple domains can be separated by semicolons (;). The host name is always the first part of a Fully Qualified Domain Name, e.g. **myserver** is the host name in the Fully Qualified Domain Name **myserver.mycompany.com** where **mycompany.com** is the Domain name.

DNS servers - enter the IP addresses of the primary and secondary DNS servers.

NTP Configuration

Obtain NTP server address via DHCP - check this radio button to automatically look up and use the NTP server settings as provided by DHCP. Click the View button to see the current settings.

Use the following NTP server address - to make manual settings, check this radio button and enter the host name or IP address of the NTP server.

Host Name Configuration

The AXIS 233D can be accessed using a host name, instead of an IP address. The host name is usually the same as the assigned DNS Name. It is always the first part of a Fully Qualified Domain Name and is always one word, with no period. For example, **myserver** is the host name in the Fully Qualified Domain Name **myserver.mycompany.com**.

The **enable dynamic DNS updates** allows you to alias a dynamic IP address to a static host name, allowing your computer to be more easily accessed from various locations on the Internet. Outside users can always access your server using the associated DNS name regardless of the WAN IP. The DNS server used by the user and/or the DNS server responsible for the domain in use must support RFC2136 and allow updates from the AXIS 233D.

The **TTL (Time To Live)** value determines how long (in seconds) the reply from the DNS server should be remembered when checking that the domain name for the registered IP address is still valid. For more information, please see the online help 

Link-Local IPv4 Address

This is enabled by default and assigns the AXIS 233D an additional IP address for use with UPnP™. The AXIS 233D can have both a Link-Local IP and a static/DHCP-supplied IP address at the same time - these will not affect each other.

HTTP

The default HTTP port number (80) can be changed to any port within the range 1 - 65535. This is useful for e.g. simple port mapping.

HTTPS

If applicable, enter the HTTPS port the AXIS 233D will use. The default setting (443) can be changed to any port within the range 1024-65535. HTTPS is used to provide encrypted web browsing.

NAT traversal (port mapping)

A broadband router allows devices on a private network (LAN) to share a single connection to the Internet. This is done by forwarding network traffic from the private network to the “outside” i.e. the Internet. Security on the private network (LAN) is increased since most broadband routers are pre-configured to stop any attempts to access the private network (LAN) from the public network/Internet.

Use NAT traversal when your AXIS 233D is located on an intranet (LAN) and you wish to make it available from the other (WAN) side of a NAT router. With NAT traversal properly configured, all HTTP traffic to an external HTTP port in the NAT router will be forwarded to the camera.

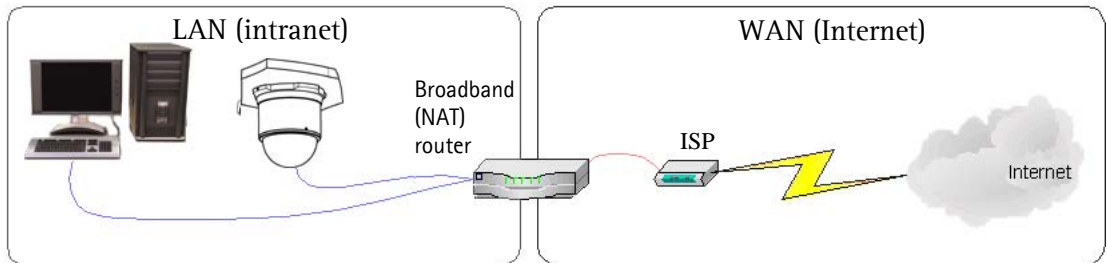

- Notes:**
- For NAT traversal to work, this must also be supported by the broadband router.
 - The broadband router has many different names: "NAT router", "Network router", "Internet Gateway", "Broadband sharing device" or "Home firewall" but the essential purpose of the device is the same.

Enable/Disable - When enabled, the AXIS 233D will attempt to configure port mapping in a NAT router on your network, using UPnP™. Note that UPnP™ must be enabled in the camera (see **System Options > Network > UPnP**).

AXIS Internet Dynamic DNS Service - Use this free service to assign a host name (user-friendly name) for easy access to your camera. If the IP address of the camera or NAT router changes, the AXIS Internet Dynamic DNS Service will automatically be updated with the new IP address.

Use manually selected NAT router - Select this option to manually select a NAT router and enter the IP address for the router in the field provided.

If a router is not manually specified, the AXIS 233D will automatically search for NAT routers on your network. If more than one router is found, the default router will be selected.

Alternative HTTP port - Select this option to manually define an external HTTP port. Enter the port number in the field provided. If no port is entered here a port number will automatically be selected when NAT traversal is enabled.

- Notes:**
- An alternative HTTP port can be used/be active even if NAT traversal is disabled. This is useful if e.g. your NAT router does not support UPnP and you need to manually configure port forwarding in the NAT router.
 - If a manually selected port is already in use, another will automatically be selected.
 - When the port is selected automatically it will be displayed in this field. This can be changed by entering a new port number and clicking Save.

FTP

The FTP server running in the AXIS 233D enables the upload of e.g. new firmware, user applications, etc. Check the box to enable the service.

RTSP

The RTSP protocol allows a connecting client to start an MPEG-4 stream. Check the box to enable the service and enter the RTSP port number to use. The default setting (554) can be changed to any port within the range 1024-65535.

Network Traffic

Connection Type - The default setting is Auto-negotiate, which means that the correct speed is automatically selected. If necessary, you can set the connection speed by selecting it from the drop-down list.

SOCKS

SOCKS is a networking proxy protocol. The AXIS 233D can be configured to use a SOCKS server to reach networks on the other side of a firewall/proxy server. This functionality is useful if the AXIS 233D is located on a local network behind a firewall, but notifications, uploads, alarms, etc., need to be sent to a destination outside the local network (e.g. to the Internet).

QoS (Quality of service)

Quality of Service (QoS) provides the means to guarantee a certain level of a specified resource to selected traffic on a network. Quality can be defined as e.g. a maintained level of bandwidth, low latency, no packet losses, etc. The main benefits of a QoS-aware network can be summarized as:

- The ability to prioritize traffic and thus allow critical flows to be served before flows with lesser priority.
- Greater reliability in the network, thanks to the control of the amount of bandwidth an application may use, and thus control over bandwidth races between applications.

The QoS in Axis network video products marks the data packets for various types of network traffic originating from the product. This makes it possible for network routers and switches to e.g. reserve a fixed amount of bandwidth for these types of traffic. The types of traffic marked by the camera are video, audio, event/alarm and management network traffic.

QoS Settings

For each type of network traffic supported by your Axis network video product, enter a DSCP (Differentiated Services Codepoint) value. This value is used to mark the traffic's IP header. When the marked traffic reaches a network router or switch, the DSCP value in the IP header tells the router or switch which type of treatment to apply to this type of traffic, for example, how much bandwidth to reserve for it.

Note that DSCP values can be entered in decimal or hex form, but saved values are always shown in decimal. For more information on Quality of Service, please see the Axis support web at www.axis.com/techsup

SMTP (email)

Enter the host names or addresses for your primary and secondary mail servers in the fields provided, to enable the sending of notifications and image/video email messages from the camera to predefined addresses via SMTP.

If your mail server requires authentication, check the box for **Use authentication to log in to this server** and enter the necessary information.

SNMP

The Simple Network Management Protocol (SNMP) allows remote management of network devices. Depending on the level of security required, select the version of SNMP to use. The three levels of security are:

- SNMP V1 - includes no security.
- SNMP V2c - uses very simple security. The community name can be specified as a password for read or read/write access to all supported SNMP objects. The community is the group of network devices using SNMP.
- SNMP V3 - provides encryption and secure passwords. HTTPS must be enabled.

UPnP™

The camera includes support for UPnP™, which is enabled by default. If also enabled on your computer, the camera will automatically be detected and a new icon will be added to “My Network Places.”

Note: UPnP must also be enabled on your Windows XP or ME computer. To do this, open the Control Panel from the Start Menu and select **Add/Remove Programs**. Select **Add/Remove Windows Components** and open the **Networking Services** section. Click **Details** and then select **UPnP** as the service to add.

RTP / MPEG-4

These settings are the port range, IP address, port number (video and audio), and Time-To-Live value to use for video and audio in multicast MPEG-4 format. Only certain IP addresses and port numbers should be used for multicast streams. For more information, please see the online help.

Bonjour

The AXIS 233D includes support for Bonjour. When enabled, the camera is automatically detected by operating systems and clients that support this.

Ports & devices

I/O Ports - The pinout, interface support and the control and monitoring functions are described in the section on the *I/O terminal connector blocks*, on page 54.

Maintenance

- **Restart** - The unit is restarted without changing any of the settings. Use this method if the unit is not behaving as expected.
- **Restore** - The unit is restarted and most current settings are reset to factory default values. The settings that will not be reset are as follows:
 - the boot protocol (DHCP or static)
 - the static IP address

- the default router
 - the subnet mask
 - the system time
- **Default** - The default button should be used with caution. Pressing this will return all of the network camera's settings to the factory default values (including the IP address).

Dome Status - Click the Test button to check the camera and dome mechanics for errors. Contact Axis Customer Services if you receive an error message as the result of this test.

Upgrade Server - See *Support*, on page 50.

Backup - To take a backup of all of the parameters, and any user-defined scripts, click this button. If necessary, it is then possible to return to a previous configuration if settings are changed and there is unexpected behavior.

Restore - click the **Browse** button to locate the saved backup file (see above) and then click the **Restore** button. The settings will be restored to the previous configuration.

Note: Backup and Restore can only be used on the same unit running the same firmware. This feature is not intended for multi-configurations or for firmware upgrades.

Support

The **support overview** page provides valuable information on troubleshooting and contact information, should you require technical assistance.

System Overview - is a quick look over the camera's status and settings. Information that can be found here includes the camera's Firmware version, IP address, Security, Optional Network Services, Event Settings, Image settings and Recent log items. Many of the captions are also links to the proper **Setup page** to conveniently make adjustments in the camera's settings.

Logs & Reports

When contacting Axis support, please be sure to provide a valid Server Report with your query.

View Information - The **Log report** and the **Parameter List** also provide valuable information for troubleshooting and when contacting Axis' support service.

Configuration:

Log Level for Log Files - from the drop-down list, select the level of information to be added to the Log file

Log Level for Email - from the drop-down list, select the level of information to send as email and enter the destination email address.

Advanced

Scripting is an advanced function that provides the possibility to customize and use scripts. This function is a very powerful tool.

Caution!

Improper use may cause unexpected behavior or even cause loss of contact with the unit. If a script does cause problems, reset the unit to its factory default settings. A backup file may be of use to return the unit to its latest configuration).

Axis strongly recommends that you do not use this function unless you fully understand the consequences. Note that Axis support does not provide assistance for problems with customized scripts.

For more information, please visit the Developer pages at www.axis.com/developer

Plain Config - this function is for the advanced user with experience of Axis network camera configuration. All parameters can be set and modified from this page. Help is available from the standard help pages.

About

Third Party Software Licenses - click View licenses for a list of the licensed software used in the AXIS 233D Network Dome Camera.

Resetting to Factory Default Settings

To reset the AXIS 233D to the original default settings, go to the **System Options > Maintenance** web page (described in *Maintenance*, on page 48) or use the control button on the AXIS 233D as described below:

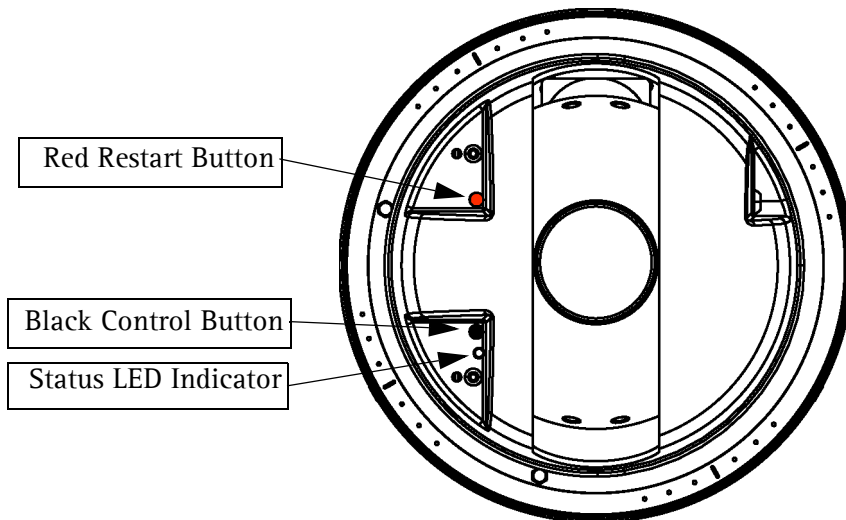

Resetting to the Factory Default Settings

This will reset all parameters, including the IP address, to the Factory Default settings:

1. Remove dome of camera. See Installation Guide for instructions.
2. Press and hold the red and black button at the same time. Release the red restart button, but continue to hold down the black control button.
3. Keep the black control button pressed until the status indicator flashes amber (this may take up to 15 seconds).
4. Release the black control button.
5. When the status indicator displays green (which can take up to 1 minute) the process is complete and the camera has been reset to factory default.
6. Re-assign the IP address in the AXIS 233D using one of the methods described in this document.

I/O terminal Connectors

The AXIS 233D Network Dome Camera has 3 (8 pin) connectors. The inputs/outputs are used in applications for, e.g. event triggering, time lapse recording, alarm notification via email, picture storage to FTP locations.

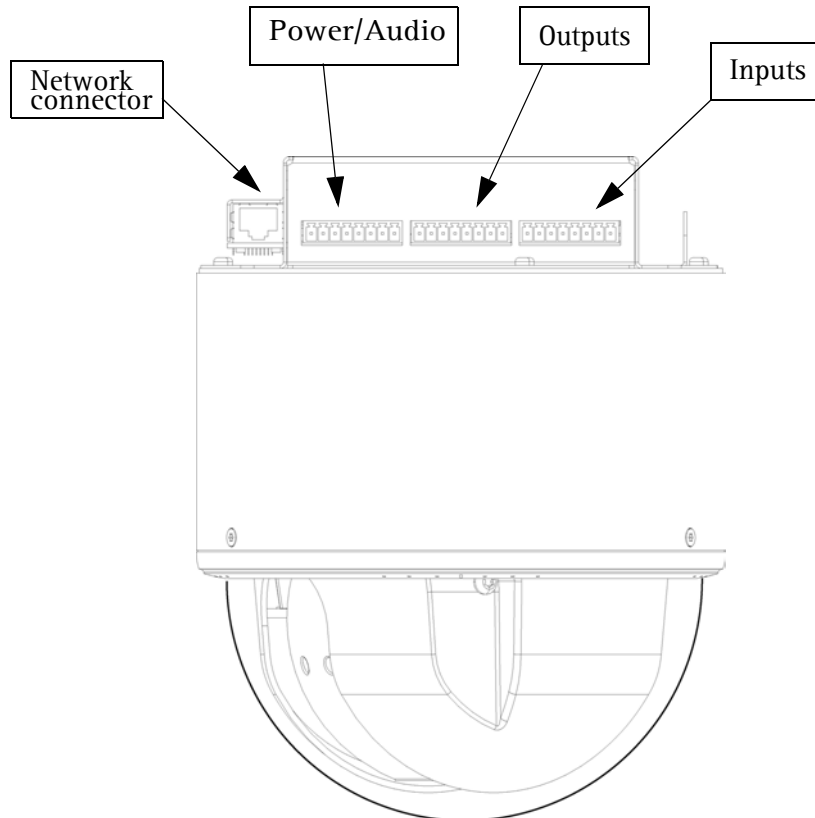

- Power, auxiliary power, GND and audio.
- 4 solid state relay outputs - These can drive a maximum load of 50V DC at 500mA directly or heavier loads by connecting additional relay circuitry. If the output is used with an external relay, a diode must be connected in parallel with the load for protection against voltage transients.
- 4 alarm inputs - Used for connecting external alarm devices and triggering images for specific alarm-based events. The input is typically connected to a motion detector or any other external security device, and images can be uploaded whenever the detector is activated. A maximum 40V DC is allowed on the inputs.

Power connections

Power can be supplied to the camera by the following methods:

- Connect the supplied indoor power adapter to the power connector block and attach it to the camera casing. Note that this indoor power adapter provides power for the camera only.
- Connect an outdoor power supply to the power connector block and attach it to the camera casing. For information on available outdoor power supplies, please visit the Support pages at <http://www.axis.com/techsup/>

The power connector block supports both AC and DC input power.

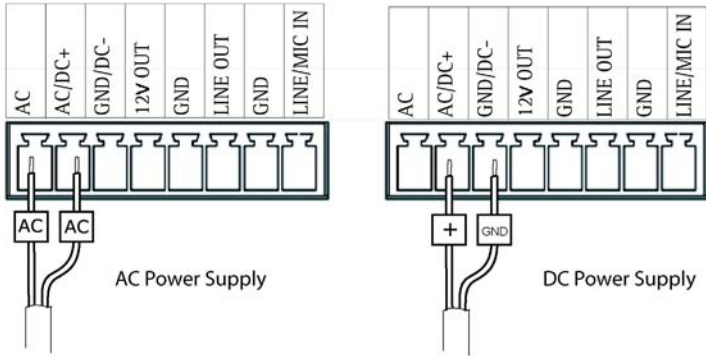

IMPORTANT! - When using a DC power supply (included with this product), it is very important that it is connected correctly to the power block. Make sure the wire labeled with “+” is connected to pin 2 and the remaining wire GND to pin 3. With an AC power supply either wire can be connected to pin 1 or 2.

I/O terminal connector blocks

Pin	Function	Description
Power/Audio		
1	Power AC	18 - 30 VAC max 25VA power consumption.
2	Power AC/DC+	18 - 30 VAC max 25VA power consumption. -or- 22 - 40 VDC max 20W power consumption.
3	GND	Ground
4	Vout	12V/200mA Vout can be used to power auxiliary equipment, max 200mA.
5	GND	Ground
6	Line OUT	Mono audio output (line level), which can be connected to an active speaker with built-in amplifier.
7	GND	Ground
8	Mic/Line IN	Input for a mono microphone or line level mono signal.
Output		
1	Out1_1_relay	On the external device output terminals (e.g. Out1_1 and Out1_2) there is no distinction between positive and negative. The terminals use a photocoupler and are electrically isolated from the other internal circuitry.
2	Out1_2_relay	
3	Out2_1_relay	
4	Out2_2_relay	
5	Out3_1_relay	The maximum load should not exceed 500mA and the maximum voltage should be not more than 50V DC. Note: Connecting AC to the Output will damage the unit.
6	Out3_2_relay	
7	Out4_1_relay	
8	Out4_2_relay	
Input		
1	In1_anode(+)	Electrically isolated from the chassis and connectors, these inputs can be supplied from an external DC voltage or pin 4 (Vout) of the Power/Audio Connector and GND. (3.3 - 40VDC allowed on the inputs) The terminals use a photocoupler and are electrically isolated from the other internal circuitry. Note: There is a distinction between anode and cathode when making connections!
2	In1_cathode(-)	
3	In2_anode(+)	
4	In2_cathode(-)	
5	In3_anode(+)	
6	In3_cathode(-)	
7	In4_anode(+)	
8	In4_cathode(-)	

Schematic Diagram - AXIS 233D I/O connectors and power

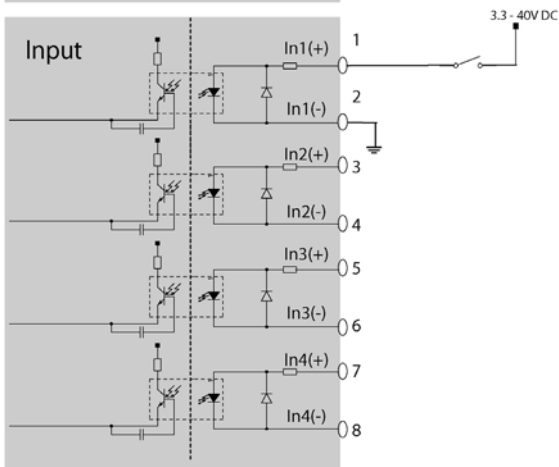
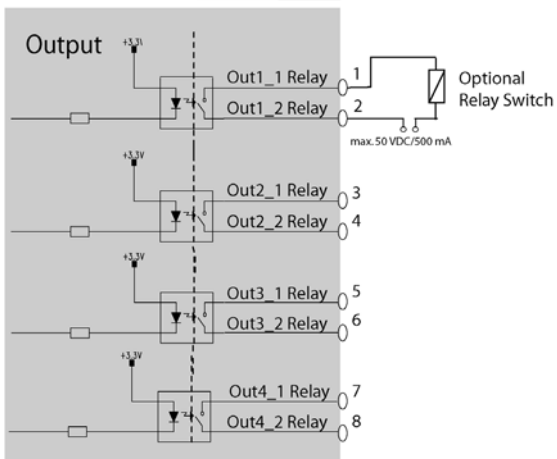
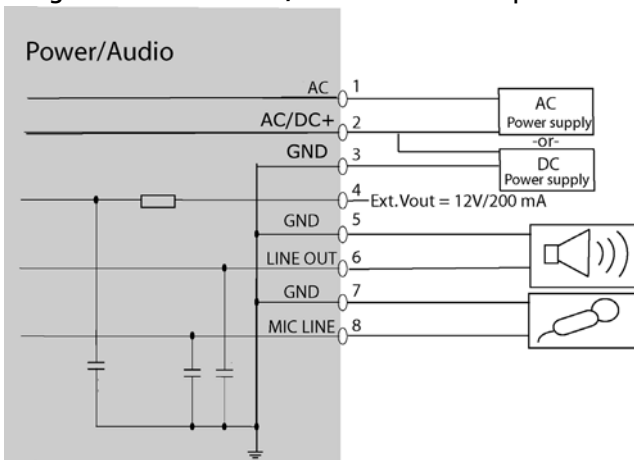

Troubleshooting

Checking the Firmware

One of your first actions when troubleshooting a problem should be to check the currently installed firmware version. The latest version may contain a correction that fixes your particular problem. See the support section at <http://www.axis.com/techsup> for information on the latest available firmware version. The current software version in your AXIS 233D is available from the product Web pages under **Setup > Basic Configuration**.

Updating the Firmware

The firmware is software that determines the functionality of the AXIS 233D. When you upgrade to the latest available firmware from the Axis Web site, your Axis product will receive the latest available functionality. Always read the upgrade instructions and release notes available with each new release, before upgrading the firmware.

New firmware can be uploaded to the AXIS 233D over the network.

Note: Preconfigured and customized settings will be retained for use when the new firmware is running (providing that the features are available in the new firmware) although this is not guaranteed by Axis Communications.

1. Save the firmware file to your computer. The latest version of the AXIS 233D firmware is available free of charge from the Axis Web site at <http://www.axis.com/techsup> or from your local distributor.
2. Go to **Setup > System Options > Maintenance** in the AXIS 233D Web pages.
3. In the **Upgrade Server** section and browse to the desired firmware file on your computer. Click **Upgrade**.

Notes: After starting the process, you should always wait at least 20 minutes before restarting the AXIS 233D, even if you suspect the procedure has failed.

Emergency Recovery Procedure

If power or the network connection to the AXIS 233D is lost during the upgrade, the process will fail and the unit will become unresponsive. When the status indicator flashes red it indicates a failed upgrade. To recover the unit, follow the steps below. The serial number is found on the label on the product casing and was included on an extra label included in the package.

1. **Unix/Linux** - From the command line, type the following:
arp -s <IP address of AXIS 233D> <Serial number> temp
ping -s 408 <IP address of AXIS 233D>

Windows - From a command/DOS prompt, type the following:
arp -s <IP address of AXIS 233D> <Serial number>
ping -l 408 -t <IP address of AXIS 233D>

Note: the ping -l command is the lower-case letter (L)

2. If the unit does not reply within a few seconds, restart it and wait for a reply. Press CTRL+C to stop Ping.
3. Open a browser and type in the AXIS 233D's IP address. In the page that appears, use the **Browse** button to select the upgrade file to use, e.g. axis233d.bin. Then click the **Load** button to restart the upgrade process.
4. After the upgrade has completed (1-10 minutes), the unit will automatically restart and show a steady green (for about 10 seconds) on the status indicator before returning to its normal unlit status.
5. Reinstall the AXIS 233D.

If the emergency recovery procedure does not get the AXIS 233D up and running again, please contact Axis support at www.axis.com/techsup/

LED Indicator flash routine

Case	Color	Description
Normal boot sequence	Unlit	Power on RFL check
	Amber	Kernel booting System initiating
	Green	Shows steady green for 10 sec. for normal operation after restart.
	Unlit	Steady connection/normal operation
Hard Factory Default	Unlit	Power on RFL check
	Amber	Steady - Kernel booting Flashes - Firmware restore Steady - System initiating
	Green	Shows steady green for 10 sec. for normal operation after restart.
	Unlit	Steady connection/normal operation
Flash Upgrade	Unlit	Steady connection/normal operation
	Amber	Flashes - Firmware upgrade
	Unlit	Reset RFL check
	Amber	Steady - Kernel booting Flashes - Firmware restore Steady - System initiating
	Green	Shows steady green for 10 sec. for normal operation after restart.
	Unlit	Steady connection/normal operation
No Network	Unlit	Power on RFL check
	Amber	Kernel booting System initiating
	Amber/red	Flashes - No network
	Green	Network connected/normal operation (10 sec.)
	Unlit	Steady connection/normal operation
AXIS DynDNS	Unlit	Steady connection/normal operation
	Green	Flashes- Dyn DNS connecting Steady - DynDNS successful (10 sec.)
	Red	Steady - DynDNS failed (10 sec)
	Unlit	Steady connection/normal operation
Bad Checksum	Red	Flashes - RFL check failed

Support

If you contact Axis Customer Services, please help us help you resolve your problems expediently by providing a server report, log file and a brief description of the problem.

Server Report - go to **Setup > System Options > Support Overview**. The server report contains important information about the server and its software, as well as a list of the current parameters.

Log file - go to **Setup > System Options > Logs & Reports**. The Log file records events within the unit since the last restart of the system and can prove a useful diagnostic tool for troubleshooting.

Symptoms, Possible Causes and Remedial Actions

Problems setting the IP address

Using ARP Ping	The IP address must be set within two minutes after the power has been applied to the AXIS 233D, restart the server and try again. Also, make sure the ping length is set to 408. See the ARP ping description in the installation section.
The AXIS 233D is located on a different subnet.	If the IP address intended for the AXIS 233D and the IP address of your computer are located on different subnets, you will not be able to set the IP address. Contact your network administrator for an IP address on the same subnet as the computer you are performing the installation from.
The IP address is being used by another device	Disconnect the power from the AXIS 233D. Run the Ping command (in a Command/DOS window, type ping and the IP address of the unit). If you receive: Reply from <IP address>: bytes = 32; time = 10 ms.... - this means that the IP address may already be in use by another device on your network. You must obtain a new IP address and reinstall the unit. If you receive: Request timed out - this means that the IP address is available for use with your AXIS 233D. In this case, check all cabling and reinstall the unit.

The AXIS 233D cannot be accessed from a Web browser

Cannot log in.	If the AXIS 233D has been configured to use HTTPS, check that the protocol in the URL used to access the unit is correct. You may need to type this in manually (i.e. http or https) in the browser's address field.
The IP address has been changed by DHCP	1) Move the AXIS 233D to an isolated network or to one with no DHCP or BOOTP server. Set the IP address again, using AXIS IP Utility or the ARP Ping command. 2) Access the unit and disable BOOTP and DHCP in the TCP/IP settings. Return the unit to the main network. The unit now has a fixed IP address that will not change. 3) As an alternative to 2), if dynamic IP address via DHCP or BOOTP is required, select the required service and then configure IP address change notification from the network settings. Return the unit to the main network. The unit will now have a dynamic IP address, but will notify you if the address changes.
Other networking problems	Test the network cable by connecting it to another network device, then Ping that device from your workstation. See instructions above.

Cannot send notifications, uploads, alarms, etc. to a destination outside the local network

Firewall protection	The AXIS 233D can be configured to use a SOCKS server to reach networks on the other side of a firewall/proxy server. See <i>SOCKS</i> , on page 47 for more information.
---------------------	---

Your AXIS 233D is accessible locally, but not externally

Firewall protection	Check the Internet firewall with your system administrator.
Default routers required	Check if you need to configure the default router settings.
The Internet site is too heavily loaded	Use a script running on your web server to relay images from the AXIS 233D to the Internet.

The status indicator flashes red

A firmware upgrade has been interrupted or the firmware has in some other way been damaged.	A rescue firmware is running in the product. First, set the IP address using AXIS IP utility or ARP and Ping, Then, from a Web browser, access the unit and upgrade the latest firmware to the product, see <i>Updating the Firmware</i> , on page 56.
---	---

No images are displayed in the Web interface

Problem with AMC (<i>Internet Explorer only</i>)	To enable the updating of images in Microsoft Internet Explorer, set your Web browser to allow ActiveX controls. Also, make sure that AXIS Media Control (AMC) component is installed on your workstation.
Installation of additional ActiveX component restricted or prohibited	Configure your AXIS 233D to use a Java applet for updating the images under Live View Config > Layout > Default Viewer for Internet Explorer. See help files for more information.

Video Image Problems

Image too dark or too light.	See the help files on Video Et Image Settings
Problems uploading own files	There is only limited space available for the upload of your own files. Try deleting one or more existing files, to free up space.
Missing images in uploads	This can occur when trying to use a larger image buffer than is actually available. Try lowering the frame rate or the upload period.
Slow image update	Configuring, e.g. pre-buffers, hi-res images, high frame rate etc will reduce the performance of the AXIS 233D.
Slow performance	Slow performance may be caused by e.g. heavy network traffic, many users with access to unit, low performing client, use of features such as Event handling., Image rotation.

Bad snapshot images

Display incorrectly configured on your workstation	In Display Properties, configure your display to show at least 65000 colors, i.e. at least 16-bit. Using only 16 or 256 colors on your display will produce dithering artifacts in the image.
--	--

Problems with the MPEG-4 format

Lower frame rate than expected.	Check with the administrator that there is enough bandwidth available. Check also the settings for bit rate control, in the Video Et Image > Advanced > MPEG-4 settings. Using an inappropriate video object type can also affect the frame rate. See the online help for more information. Check in the AMC control panel applet (MPEG-4 tab) that video processing is not set to Decode only I frames . Lower the image resolution. Reduce the number of applications running on the client computer.
No MPEG-4 displayed in the client.	Check that the correct network interface is selected in the AMC control panel applet (network tab). Check that the relevant MPEG-4 connection methods are enabled in the AMC control panel applet (network tab). In the AMC control applet, select the MPEG-4 tab and click the button Set to default MPEG-4 decoder.
No multicast MPEG-4 displayed in the client.	Check with your network administrator that the multicast addresses used by the AXIS 233D are valid for your network. Check with your network administrator to see if there is a firewall preventing viewing.
Multicast MPEG-4 only accessible by local clients.	Check if your router supports multicasting, or if the router settings between the client and the server need to be configured. The TTL (Time To Live) value may need to be increased.
Poor rendering of MPEG-4 images.	Color depth set incorrectly on clients. Set to 16-bit or 32-bit color.

Unexpected PTZ behavior

Problem with hardware	Go to System Options > Maintenance > Dome Status and click Test to test the camera and dome mechanics for errors. Contact Axis Customer Services if you receive an error message as the result of this test.
-----------------------	--

For additional assistance, please contact your reseller or check the product's support pages on the Axis Website at <http://www.axis.com/techsup>

Technical Specifications

Item	Specification
Models	<ul style="list-style-type: none"> • AXIS 233D Network Dome Camera 60 Hz • AXIS 233D Network Dome Camera 50 Hz
Image sensor	<ul style="list-style-type: none"> • 1/4" ExView HAD Progressive Scan CCD
Lens	<ul style="list-style-type: none"> • F1.4 - 4.2 • F=3.4 - 119mm • Automatic day/night IR filter • Autofocus with 35x optical zoom • Focus range: 100mm (wide) or 1000 mm (tele) to infinity
Angle of view	<ul style="list-style-type: none"> • Horizontal: 1.73 - 55.8°
Zoom	<ul style="list-style-type: none"> • 35x optical and 12x digital, Total 420x
Minimum illumination	<ul style="list-style-type: none"> • Color: 0.5 lux at 30 IRE • Black/white: 0.008 at 30 IRE
Range	<ul style="list-style-type: none"> • Pan: 360° continuous • Tilt: 180°
Speed Range	<ul style="list-style-type: none"> • Pan: 0.05 - 450°/sec • Tilt: 0.05 - 450°/sec
Video compression	<ul style="list-style-type: none"> • Motion-JPEG • MPEG-4 Part2 (ISO/IEC 14496-2) with motion estimation • Profiles: ASP level 0-5 and SP level 0-3
Resolutions	<ul style="list-style-type: none"> • 4CIF, 2CIFExp, 2CIF, CIF, QCIF • Maximum 768x575 (PAL) 704x480 (NTSC) • Minimum 176x144 (PAL) 160x120 (NTSC) • Horizontal resolution: 540 TVL
Frame rates (NTSC/PAL)	<ul style="list-style-type: none"> • Up to 30/25 fps progressive scan video in all resolutions (Motion JPEG or MPEG-4)
Video streaming	<ul style="list-style-type: none"> • Simultaneous Motion JPEG and MPEG-4 • Controllable frame rate and bandwidth • Constant and variable bit rate (MPEG-4)
Image settings	<ul style="list-style-type: none"> • Wide Dynamic Range (WDR) • Electronic image stabilization • Automatic IR filter removal • Compression levels: 100 • Manual shutter time settings • Rotation: 0°, 180° • Aspect ratio correction • Color and black/white • Configurable Brightness and Sharpness • Overlay capabilities: OSDI, preset ID, time, date, PTZ coordinates, text or image, Privacy mask in 8 zones
Pan/Tilt/Zoom	<ul style="list-style-type: none"> • E-flip • 100 preset positions • Guard tour • Control queue

Item	Specification
Shutter time	<ul style="list-style-type: none"> • 1.5s PAL(1/2s NTSC) - 1/30000s
Audio	<ul style="list-style-type: none"> • Two-way (full or half duplex) or one-way • Audio compression: G.711 PCM 64kbit/s, G726 ADPCM 32 or 24 kbits • Requires external microphone or line in. • Mono audio output (line level) connects to PA system or active speaker with built-in amplifier.
Security	<ul style="list-style-type: none"> • Multiple user access levels with password protection • IP address filtering • HTTPS encryption
Users	<ul style="list-style-type: none"> • 20 simultaneous viewers • Unlimited number of users using MPEG-4 multicast
Alarm and event management	<ul style="list-style-type: none"> • Events triggered by built-in motion detection, PTZ position, audio detection, external inputs, temperature levels or according to schedule • Image upload via FTP, e-mail and HTTP • Event notification via TCP, e-mail, HTTP and external outputs • Pre- and post-alarm buffer of 36 MB
Connectors	<ul style="list-style-type: none"> • Ethernet 10BaseT/100BaseTX, RJ-45 • Three 8 pin connectors 4 alarm inputs 3.3 - 40VDC 4 relay outputs 50V 500 mA Power in Auxiliary power out 12VDC max 200mA Audio line/Mic in Audio line out
Casing	<ul style="list-style-type: none"> • Metal/plastic casing • Polycarbonate dome cover
Processors, memory and clock	<ul style="list-style-type: none"> • CPU: AXIS ETRAX FS 32-bit RISC CPU • Compression: AXIS ARTPEC-2 video compression chip + 8MB RAM • RAM: 64MB • Flash memory: 8 MB • Battery backed up real-time clock
Power	<p>Power supply (indoor) included:</p> <ul style="list-style-type: none"> • 18-30 VAC, Max 25VA • 22-40 VDC, Max 20W
Operating conditions	<ul style="list-style-type: none"> • Temperature: -5 - 45° C (23 - 113° F) • Humidity: 20 - 80% RH (non-condensing) <p>Alarm when out of operating range.</p>
Installation, management and maintenance	<ul style="list-style-type: none"> • Configuration backup and restore • AXIS Camera Station One for recording • AXIS Camera Management on CD and web-based configuration • Firmware upgrades over HTTP or FTP. Firmware available at www.axis.com
Video access from Web browser	<ul style="list-style-type: none"> • Camera live view for up to 20 clients • Video recording to file (ASF) • Sequence tour for up to 20 Axis video sources • Customizable HTML pages.

Item	Specification	
Minimum web browsing requirements	<ul style="list-style-type: none"> • Pentium III CPU 500 MHz or higher or equivalent AMD • 128 MB RAM • AGP graphics card 32MB RAM, DirectDraw • Windows: 2003 Server, XP, 2000 • DirectX 9.0 or later • Internet Explorer 6.x or later • For other operating systems and browsers, see www.axis.com/techsup 	
System integration support	<ul style="list-style-type: none"> • Open API for application integration, including AXIS VAPIX API*, AXIS Media Control SDK*, event trigger data in video stream • Quality of Service (QoS) Layer 3, DiffServ Model • Watchdog ensures continuous operation, event notifications which can be monitored by other systems • Embedded operating system: Linux 2.6 <p>*Available at www.axis.com</p>	
Supported protocols	IPv4/v6, HTTP, HTTPS, SSL/TLS*, TCP, QoS,SNMPv1/v2c/v3 (MIB-II),RTSP, RTP, UDP, IGMP, RTCP, UDP, SMTP, FTP, ICMP DHCP, UPnP, Bonjour, ARP, DNS, DynDNS, SOCKS, IEEE802.1X. More information on protocol usage available at www.axis.com *This product includes software developed by the Open SSL Project for use in the Open SSL Tool kit (www.openssl.org)	
Accessories (included)	<ul style="list-style-type: none"> • Indoor power supply AXIS PS-R 24VDC • Drop ceiling and hard ceiling mount • Clear and smoked dome covers • Installation Guide • CD with installation tool, software, User's Manual and AXIS Camera Management 	
Video management software (not included)	<ul style="list-style-type: none"> • AXIS Camera Station - Surveillance application for viewing, recording and archiving up to 25 cameras See www.axis.com/partner/adp_partners.htm for further software applications via partners	
Accessories (not included)	<ul style="list-style-type: none"> • Outdoor housing solutions • Indoor ceiling drop pole mount • Outdoor power supply • IR illuminators • AXIS 295 Video Surveillance Joystick • MPEG-4 Decoder multi-user license pack 	
Approvals - EMC	EMC <ul style="list-style-type: none"> • EN55022:Class B • EN55024:1998 • EN61000-3-2:2000 • EN61000-3-3:2000 • EN61000-6-1 • EN61000-6-2 Safety <ul style="list-style-type: none"> • EN60950-1 (IEC 60950-1) • PSE, TUV/GS, cUL, CE, CB, SAC (PS-R Power supply) 	<ul style="list-style-type: none"> • VCCI Class B • C-Tick AS/NZS 3548 • FCC Part 15 Subpart B, Class B • ICES-003 Class B
Dimensions (HxWxD) and weight	<ul style="list-style-type: none"> • 209 x 170 x 170 mm (8.23" x 6.69" x 6.69") • Weight: 2.5 kg (5.5 lbs) including hard ceiling mount, excluding power supply 	

General performance considerations

When setting up your system, it is important to consider how various settings and situations will affect performance. Some factors affect the amount of bandwidth (the bit rate) required, others can affect the frame rate, and some will affect both. If the load on the CPU reaches its maximum, this will also affect the frame rate.

The following factors are among the most important to consider:

- High image resolutions and/or lower compression levels result in larger images. Bandwidth affected.
- Access by large numbers of Motion JPEG and/or unicast MPEG-4 clients. Bandwidth affected.
- Simultaneous viewing of different streams (resolution, compression, etc.) by different clients. Frame rate and bandwidth affected.
- Accessing both Motion JPEG and MPEG-4 video streams simultaneously. Frame rate and bandwidth affected.
- Heavy usage of event settings affects the CPU load. Frame rate affected.
- Heavy network utilization due to poor infrastructure. Bandwidth affected.
- Viewing on poorly performing client PC's lowers perceived performance. Frame rate affected.

Optimizing your system

To see the bandwidth and frame rate currently required by the video stream, the AXIS 233D provides a tool that can be used to display these values directly in the video image.

To do this, special format strings are added as part of a text overlay. Simply add **#r** (average frame rate in fps) and/or **#b** (average bandwidth in Kbps) bandwidth in Kbps) to the overlay.

For detailed instructions, please see the online help for **Video & Image > Overlay Settings**, and the help for **File Naming & Date/Time Formats**.

Important!

- The figures displayed here are the values as delivered by the server. If other restrictions are currently in force, (e.g. bandwidth limitation) these values might not correspond to those actually received by the client.
- For Motion JPEG, these values will only be accurate as long as no frame rate limit has been specified.

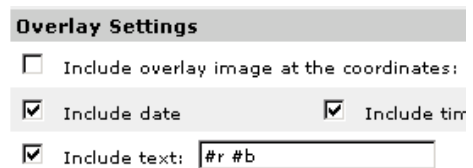

Frame rates

Motion JPEG

Test results show the frame rates in frames/second (fps) for Motion JPEG streams from the AXIS 233D, using a compression level of 50% is 25 fps for PAL and 30 fps for NTSC. Note that these values are guidelines only - actual values may vary.

MPEG-4

Test results show the frame rates in frames/second (fps) for MPEG-4 streams from the AXIS 233D is 25 fps for PAL and 30 fps for NTSC. Note that these values are guidelines only - actual values may vary.

The MPEG-4 test conditions:

- Compression level = 50%
- Video Object Type = Advanced Simple
- GOV structure = IP

Bandwidth

As there are many factors affecting bandwidth, it is very difficult to predict the required amounts. The settings that affect bandwidth are:

- the image resolution
- the image compression
- the frame rate
- the MPEG-4 object type
- the MPEG-4 GOV structure

There are also factors in the monitored scene that will affect the bandwidth. These are:

- the amount of motion
- the image's complexity
- the lighting conditions.

For MPEG-4, if there is only limited bandwidth available, and if this is more important than the image quality, using a constant bit rate (CBR) is recommended. Use a variable bit rate (VBR) if the image quality needs to be maintained at a higher level. If supported on the network, consider also using MPEG-4 multicasting, as the bandwidth consumption will be much lower.

Index

802.1x 40

A

Accessing the video stream 16
 Action Buttons 10
 Action buttons 28
 Active/Inactive 10, 28
 ActiveX Controls 9
 Advanced TCP/IP settings 44
 Alarm 33, 37, 52
 Alarm inputs 52
 AMC 11, 12
 AMC (AXIS Media Control) 11, 12, 16, 23
 ARP/Ping 43
 Audio 54
 Audio Channels 23
 Audio input 24
 Audio output 24
 Auxiliary power 52

B

Backlight Compensation 21
 Backup 49
 Bandwidth 13, 66
 Bonjour 48
 Brightness 20
 Buffer Size 35
 Buffers 35

C

CA servers 41
 CGI links 27
 Color level 20
 Constant bit rate 13
 Control queue 32
 Customize 26

D

Date & Time 41
 Default Viewer 29
 DNS configuration 44

DSCP 47

E

E-flip 32
 Emergency recovery 57
 Event 33
 Event Servers 33
 Event Types 34
 Exposure area 20
 Exposure control 20

F

Factory Default 51
 Frame rates 19, 66
 FTP Server 33
 Full duplex 23, 63

G

G711 24
 G726 24
 Guard Tour 31

H

Half duplex 23, 63
 Host name 44
 HTML examples 29
 HTTP API 27, 28
 HTTP port number 45
 HTTP Server 33
 HTTPS 40

I

I/O Ports 48
 Include Windows 37
 Input 52, 54
 Input gain 24
 Input sensitivity 24
 IP Address Filtering 39
 IR Cut Filter 20
 IR light 10

L

LED Indicator 8

Live View 17
 Logs & Reports 50
 Low light behavior 21

M

Motion JPEG 13
 Mozilla Firefox 12
 MPEG-4 13
 MPEG-4 clients 16
 MPEG-4 Decoder 64
 MPEG-4 protocols 14
 Multicasting 14

N

NAT traversal 45
 Network 43
 New Server Time 41
 Noise canceller attenuation 25
 Notification of IP address change 43

O

Output 52, 54
 Output Buttons 10, 28
 Overlay Image 19
 Overlay Settings 19
 Own home page 27
 Own web files 27

P

Pan/Tilt/Zoom Control Queue 11
 Pan/Tilt/Zoom Controls 11
 Pinout 48
 Plain Config 50
 Port Status 37, 38
 Ports & Devices 48
 Post-trigger Buffer 35
 Power 54
 Preset Positions 31
 Pre-trigger Buffer 35
 PTZ commands 27
 Pulse 10, 28
 Push to talk 23

Q

QoS 47
 QuickTime 29

R

RADIUS 41
 Recovery 57
 Referrals 39
 Relay outputs 52
 Restart 48
 Restore 48
 RTP 14
 RTSP 14, 46

S

Scheduled Event 33, 36
 Security 39
 Sequence Mode 10
 Sequence mode 31
 Services 43
 Setup Tools 17
 Sharpness 20
 Simplex - Network Camera speaker only 23
 SMTP 47
 Snapshot 10
 SNMP 48
 Specifications 62
 Streaming MPEG-4 15
 Support 50
 System Options 39

T

TCP Server 33
 Time Mode 42
 Triggered Event 33, 34
 Troubleshooting 56

U

UDP 14
 Unicasting 14
 Upgrade Server 49
 UPnP 45, 48
 User defined links 27

V

Variable bit rate 13

Video format 10

Video Stream 19

W

Wide dynamic range 20

Free Manuals Download Website

<http://myh66.com>

<http://usermanuals.us>

<http://www.somanuals.com>

<http://www.4manuals.cc>

<http://www.manual-lib.com>

<http://www.404manual.com>

<http://www.luxmanual.com>

<http://aubethermostatmanual.com>

Golf course search by state

<http://golfingnear.com>

Email search by domain

<http://emailbydomain.com>

Auto manuals search

<http://auto.somanuals.com>

TV manuals search

<http://tv.somanuals.com>