



**Resolver to Digital
Expansion Board**

Catalog No. EXB009A01

Installation and Operating Manual

6/98

MN1313

Table of Contents

Section 1

General Information	1-1
Introduction	1-1
Limited Warranty	1-2
Safety Notice	1-3
Precautions	1-3

Section 2

Expansion Board Description	2-1
Introduction	2-1
Specifications	2-1

Section 3

Installation	3-1
Board Installation	3-1
1-15HP Size A and B Controls	3-2
Single Expansion Board Installation	3-2
Dual Expansion Board Installation	3-4
15HP Size C and Larger AC Controls	3-6
Single Expansion Board Installation	3-6
Dual Expansion Board Installation	3-8
SCR DC Controls	3-10
Single Expansion Board Installation	3-10
Dual Expansion Board Installation	3-11

Section 4	
Hardware Setup	4-1
Connections	4-3
Section 5	
Software Setup	5-1
Configure Control Software	5-1
Series 18H and 22H Vector Controls	5-1
Series 19H and 20H DC SCR Controls	5-1

Section 1

General Information

Introduction

The Baldor controls represent the latest technology in microprocessor based motor controls. In addition to the user programmable parameters available in every control, many different expansion boards are available from Baldor to further customize the control to most any application.

Expansion boards are categorized by compatibility into two groups: Group 1 and Group 2, see Table 1-1. A board from either group may be used alone in a control. If two boards are to be used, one board must be from Group 1 and the other from Group 2.

Note: Using two Group 1 or two Group 2 boards in the same control is not allowed.

Table 1-1 Group 1 and Group 2 Board Categories

Group 1 Board Name	Catalog No.	Baldor Manual No.
Isolated Input Expansion Board	EXB003A01	MN1314
Master Pulse Reference/ Isolated Pulse Follower	EXB005A01	MN1312
DC Tachometer Interface	EXB006A01	MN1311
Isolated Encoder Expansion Board	EXB008A01	MN1317
Resolver to Digital Interface	EXB009A01	MN1313
Group 2 Board Name		
RS-232 Serial Communication	EXB001A01	MN1310
RS-422/RS-485 High Speed Serial Communication	EXB002A01	MN1310
Four Output Relays/3-15 PSI Pneumatic Expansion Board	EXB004A01	MN1315
High Resolution Analog I/O Expansion Board	EXB007A02	MN1316
2 Isolated Analog Output/ 3 Relay Output Expansion Board	EXB010A01	MN1319

Limited Warranty

For a period of two (2) years from the date of original purchase, BALDOR will repair or replace without charge controls and accessories which our examination proves to be defective in material or workmanship. This warranty is valid if the unit has not been tampered with by unauthorized persons, misused, abused, or improperly installed and has been used in accordance with the instructions and/or ratings supplied. This warranty is in lieu of any other warranty or guarantee expressed or implied. BALDOR shall not be held responsible for any expense (including installation and removal), inconvenience, or consequential damage, including injury to any person or property caused by items of our manufacture or sale. (Some states do not allow exclusion or limitation of incidental or consequential damages, so the above exclusion may not apply.) In any event, BALDOR's total liability, under all circumstances, shall not exceed the full purchase price of the control. Claims for purchase price refunds, repairs, or replacements must be referred to BALDOR with all pertinent data as to the defect, the date purchased, the task performed by the control, and the problem encountered. No liability is assumed for expendable items such as fuses.

Goods may be returned only with written notification including a BALDOR Return Authorization Number and any return shipments must be prepaid.

Safety Notice

This equipment contains voltages that may be as great as 1000 volts! Electrical shock can cause serious or fatal injury. Only qualified personnel should attempt the start-up procedure or troubleshoot this equipment.

This equipment may be connected to other machines that have rotating parts or parts that are driven by this equipment. Improper use can cause serious or fatal injury. Only qualified personnel should attempt the start-up procedure or troubleshoot this equipment.

PRECAUTIONS

⚠ WARNING: Do not touch any circuit board, power device or electrical connection before you first ensure that power has been disconnected and there is no high voltage present from this equipment or other equipment to which it is connected. Electrical shock can cause serious or fatal injury. Only qualified personnel should attempt the start-up procedure or troubleshoot this equipment.

⚠ WARNING: Be sure that you are completely familiar with the safe operation of this equipment. This equipment may be connected to other machines that have rotating parts or parts that are controlled by this equipment. Improper use can cause serious or fatal injury. Only qualified personnel should attempt the start-up procedure or troubleshoot this equipment.

-
- ⚠ WARNING:** Be sure the system is properly grounded before applying power. Do not apply AC power before you ensure that all grounding instructions have been followed. Electrical shock can cause serious or fatal injury.
- ⚠ WARNING:** Do not remove cover for at least five (5) minutes after AC power is disconnected to allow capacitors to discharge. Dangerous voltages are present inside the equipment. Electrical shock can cause serious or fatal injury.
- ⚠ WARNING:** Improper operation of control may cause violent motion of the motor shaft and driven equipment. Be certain that unexpected motor shaft movement will not cause injury to personnel or damage to equipment. Peak torque of several times the rated motor torque can occur during control failure.
- ⚠ WARNING:** Motor circuit may have high voltage present whenever AC power is applied, even when motor is not rotating. Electrical shock can cause serious or fatal injury.
- ⚠ Caution:** To prevent equipment damage, be certain that the electrical service is not capable of delivering more than the maximum line short circuit current amperes listed in the appropriate control manual, 230 VAC, 460 VAC or 575 VAC maximum per control rating.

Section 2

Expansion Board Description

Introduction

Resolver to Digital Interface Expansion Board

Catalog No. EXB009A01

Group 1 Expansion Board

The Resolver to Digital Interface expansion board provides closed loop operation for the Baldor Series 18H, 19H, 20H and 22H controls. The Resolver to Digital Interface can also be used for PID control.

Note: When a Resolver to Digital Interface is used in a process control application, an encoder should be used to provide velocity feedback to the control.

Specifications

The Resolver to Digital interface is used with a motor mounted resolver. This provides the correct feedback signals for the Baldor Control. The control can then monitor and control shaft position. The Buffered Encoder Output (Retransmit) signals are still available from the control.

Resolver to Digital interface	
Resolver Reference Supply	4 Volts, 25 mA maximum (@ 10KHz)
Digital Resolution	10, 12, 14, 16 bits (selectable)
Resolver Input Channels	\pm Sine, \pm Cosine
Resolver Impedance	160 Ohms @ 10KHz minimum
Resolver Return Voltage	2 Volts minimum
Resolver Transformation Ratio	2:1 (0.5 TR)
Resolver Speeds	1:128 (selectable)
Connector	Screw Terminals

Maximum Motor Speed / Resolver Speed				
Resolver Speed Type	Maximum Motor Speed (RPM)			
	10 Bits	12 Bits	14 Bits	16 Bits
(2 Pole) 1 Speed Resolver	62,400	15,600	3,900	975
(4 Pole) 2 Speed Resolver	31,200	7,800	1,950	487
(6 Pole) 3 Speed Resolver	20,800	5,200	1,300	325
(8 Pole) 4 Speed Resolver	15,600	3,900	975	244
(10 Pole) 5 Speed Resolver	12,480	3,120	780	195
(12 Pole) 6 Speed Resolver	10,400	2,600	650	163
Maximum Resolver Speed/Bit Resolution	128 (256 Poles)	64 (128 Poles)	32 (64 Poles)	8 (16 Poles)

Section 3 Installation

Board Installation

This section describes the Expansion Board installation procedure.

Caution: **Before you proceed, be sure to read and become familiar with the safety precautions at the beginning of this manual. Do not proceed if you are unsure of the safety precautions described. If you have any questions, contact BALDOR before you proceed.**

1. Remove the expansion board from the shipping container.
2. Remove all packing material from the board.

Caution: **Be sure all packing materials are removed from the board. Conductive foam may be present on the connectors to prevent static build up during shipping. This can prevent proper circuit operation.**

Installation differs between the 1-15 HP Size A and B controls and the 15HP Size C and larger AC controls and the SCR DC controls. If you are installing only one board, refer to the "Single Expansion Board Installation" procedure. If you are installing two expansion boards (or a second board) refer to the "Dual Expansion Board Installation" procedure.

1-15HP Size A and B Controls

(For all 15H Inverter, 18H Vector, and 23H Servo).

Single Expansion Board Installation

Procedure:

1. Be sure drive operation is terminated and secured.
2. Remove all power sources from the control.
3. Wait at least 5 minutes for internal capacitors to discharge.
4. Remove the four (4) Phillips head screws that secure the control cover.
5. Remove the control cover.
6. Remove the #6 screw at position MH1 (upper left on the main circuit board. See Figure 3-1.
7. Install the long standoffs provided in the installation hardware as shown in Figure 3-1. (Be sure the Male/Female standoff is at position MH1. The other three are Female/Female.)
8. Slide the expansion board male connector into the female connector of the control board.
9. Securely mount the expansion board to the standoffs installed in step 7 using #6 screws provided in the installation hardware. See Figure 3-2.
10. The mechanical installation of the expansion board is now complete. Refer to Section 4 of this manual and configure the jumpers as desired. Also complete the wiring before you proceed to step 11.
11. When complete, install the control cover using the four (4) Phillips head screws.
12. Restore all power sources to the control.
13. Restore drive operation.

Figure 3-1 Single Expansion Board Installation

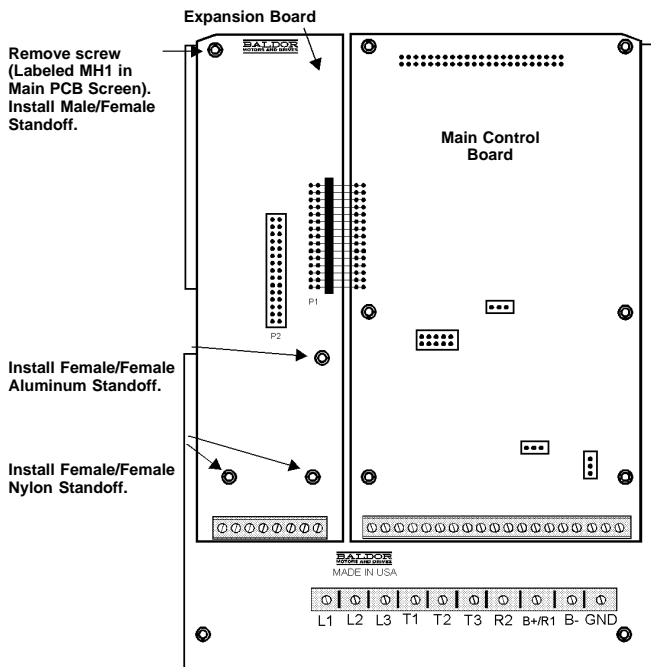

Terminal tightening torque is 7 lb-in (0.8 Nm) maximum.

Figure 3-2 Single Expansion Board Installation

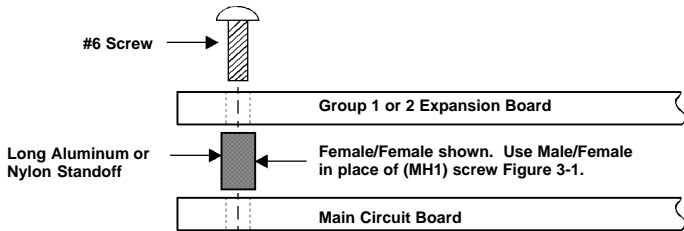

1-15HP Size A and B Controls (Continued)

Dual Expansion Board Installation

Procedure:

1. Be sure drive operation is terminated and secured.
2. Remove all power sources from the control.
3. Wait at least 5 minutes for internal capacitors to discharge.
4. Remove the four (4) Phillips head screws that secure the control cover.
5. Remove the control cover.
6. Remove the #6 screw at position MH1 (upper left on the main circuit board. See Figure 3-1.
7. Install the long standoffs provided in the installation hardware as shown in Figure 3-1. (Be sure the Male/Female standoff is at position MH1. The other three are Female/Female.)
8. Slide the Group 1 board male connector into the female connector of the control board. See Figure 3-3.
9. Securely mount the Group 1 expansion board to the standoffs installed in step 7 using the 4 short aluminum standoffs provided in the installation hardware. See Figure 3-3.
10. The mechanical installation of the Group 1 expansion board is now complete. Refer to the manual for the Group 1 board and configure the jumpers as desired. Also complete the wiring before you proceed to step 11.
11. Install the Group 2 board on top of the previously installed Group 1 board by plugging the female connector onto the male connector of the Group 1 board as shown in Figure 3-3.
12. Secure this Group 2 board to the Group 1 board using the #6 screws provided.

1-15HP Size A and B Controls

Dual Expansion Board Installation (Continued)

- The mechanical installation of the first expansion board is now complete. Refer to the manual for the Group 2 board and configure any jumpers and switches as desired. Also complete the wiring for this board before you install the cover.
- When complete, install the control cover using the four (4) Phillips head screws.
- Restore all power sources to the control.
- Restore drive operation.

Figure 3-3 Dual Expansion Board Installation

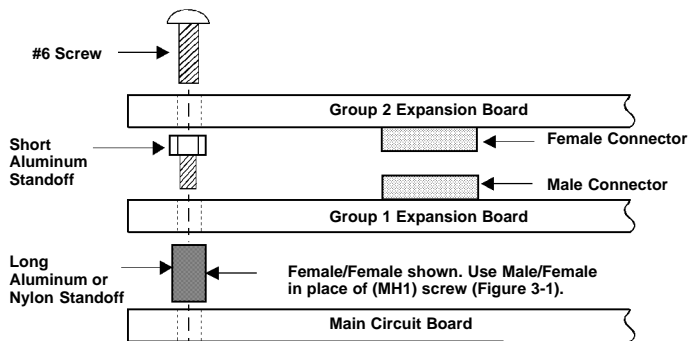

15HP Size C and Larger AC Controls

(For all 15H Inverter, 21H Line Regen Inverter, 18H Vector, 22H Line Regen Vector and 23H Servo).

Single Expansion Board Installation

Procedure:

1. Be sure drive operation is terminated and secured.
2. Remove all power sources from the control.
3. Wait at least 5 minutes for internal capacitors to discharge.
4. Remove the four (4) Phillips head screws ($1/4$ turn) that secure the control cover. (On floor mounted G size enclosures, open the enclosure door).
5. Remove the control cover.
6. Slide the expansion board male connector into the female connector of the control board. See Figure 3-4.
7. Securely mount the expansion board to the sheet metal mounting plate using the #6 screws provided in the installation hardware. See Figure 3-5.
8. The mechanical installation of the expansion board is now complete. Refer to Section 4 of this manual and configure the jumpers as desired. Also complete the wiring before you proceed to step 9.
9. When complete, install the control cover using the four (4) Phillips head screws ($1/4$ turn). (On floor mounted G size enclosures, close the enclosure door).
10. Restore all power sources to the control.
11. Restore drive operation.

15HP Size C and Larger AC Controls Single Expansion Board Installation (Continued)

Figure 3-4 Single Expansion Board Installation

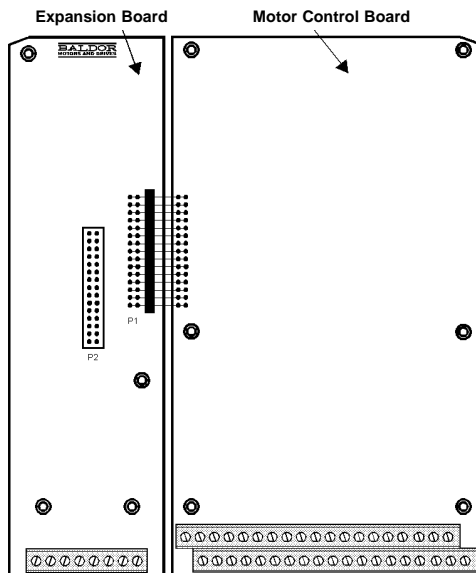

Terminal tightening torque is 7 lb-in (0.8 Nm) maximum.

Figure 3-5 Single Expansion Board Installation

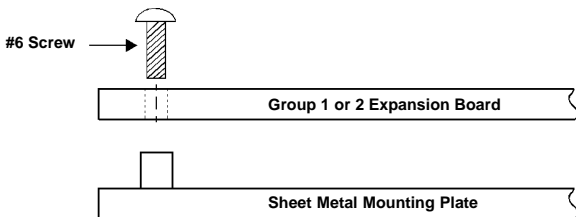

15HP Size C and Larger AC Controls (Continued)

Dual Expansion Board Installation

Procedure:

1. Be sure drive operation is terminated and secured.
2. Remove all power sources from the control.
3. Wait at least 5 minutes for internal capacitors to discharge.
4. Remove the four (4) Phillips head screws ($1/4$ turn) that secure the control cover. (On floor mounted G size enclosures, open the enclosure door).
5. Remove the control cover.
6. Slide the Group 1 expansion board male connector into the female connector of the control board. See Figure 3-4.
7. Securely mount the Group 1 expansion board to the sheet metal mounting plate using the short standoffs provided in the installation hardware. See Figure 3-6.
8. The mechanical installation of the expansion board is now complete. Refer to the manual for the Group 1 board and configure the jumpers as desired. Also complete the wiring before you proceed to step 9.
9. Install the Group 2 board on top of the previously installed Group 1 board by plugging the female connector onto the male connector of the Group 1 board as shown in Figure 3-6.
10. Secure this Group 2 board to the Group 1 board using the #6 screws provided. See Figure 3-6.
11. The mechanical installation of the expansion board is now complete. Refer to the manual for the Group 2 board and configure any jumpers and switches as desired. Also complete the wiring for this board before you install the cover.

15HP Size C and Larger AC Controls

Dual Expansion Board Installation (Continued)

12. When complete, install the control cover using the four (4) Phillips head screws ($1/4$ turn). (On floor mounted G size enclosures, close the enclosure door).
13. Restore all power sources to the control.
14. Restore drive operation.

Figure 3-6 Dual Expansion Board Installation

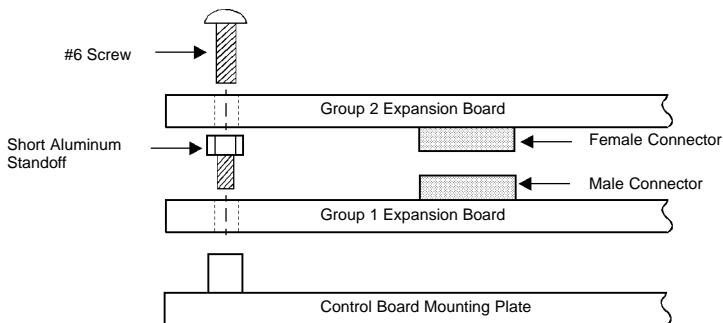

SCR DC Controls

(For 19H and 20H SCR DC Controls).

Single Expansion Board Installation

Procedure:

1. Be sure drive operation is terminated and secured.
2. Remove all power sources from the control.
3. Wait at least 5 minutes for internal capacitors to discharge.
4. Slide the expansion board male connector into the female connector of the control board. See Figure 3-4.
5. Securely mount the expansion board to the sheet metal mounting plate using the #6 screws provided in the installation hardware. See Figure 3-5.
6. The mechanical installation of the expansion board is now complete. Refer to the Group 1 manual and configure the jumpers as desired. Also complete the wiring before you proceed to step 7.
7. Restore all power sources to the control.
8. Restore drive operation.

SCR DC Controls (Continued)

Dual Expansion Board Installation

Procedure:

1. Be sure drive operation is terminated and secured.
2. Remove all power sources from the control.
3. Wait at least 5 minutes for internal capacitors to discharge.
4. Slide the Group 1 board male connector into the female connector of the control board. See Figure 3-4.
5. Securely mount the Group 1 expansion board to the sheet metal mounting plate using the short standoffs provided in the installation hardware. See Figure 3-6.
6. The mechanical installation of the expansion board is now complete. Refer to the Group 1 manual and configure the jumpers as desired. Also complete the wiring before you proceed to step 7.
7. Install the Group 2 board on top of the previously installed Group 1 board by plugging the female connector onto the male connector of the Group 1 board as shown in Figure 3-6.
8. Secure this Group 2 board to the Group 1 board using the #6 screws provided. See Figure 3-6.
9. The mechanical installation of the expansion board is now complete. Refer to the manual for the Group 2 board and configure any jumpers and switches as desired. Also complete the wiring for this board before you proceed to step 10.
10. Restore all power sources to the control.
11. Restore drive operation.



Section 4 Hardware Setup

Important:

If the Resolver to Digital expansion board is installed in a Vector control that has a feedback module installed, the feedback module must be removed to prevent interference with the expansion board. Figure 4-1 shows how to identify the feedback module on the DSP Main Control Board. The main control board is where the keypad plugs in.

Figure 4-1 Feedback Module Identification

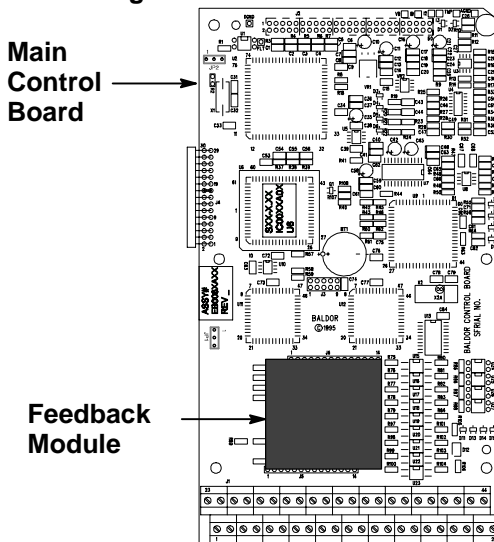

If your Vector control does not look like the one pictured in Figure 4-1, do not perform the feedback module removal procedure. Instead, continue onto page 4-3.

Feedback Module Removal Procedure

If your Vector control looks like the one pictured in Figure 4-1, perform the following procedure:

The resolver feedback module must be removed from the main control board to change the JP1 position. Use the following procedure.

1. Be sure drive operation is terminated and secured.
2. Remove all power sources from the control. Wait at least 5 minutes for internal capacitors to discharge.
3. Remove the control cover.
4. Use a grounded wrist strap connected to chassis ground.
5. Firmly grasp the Resolver Feedback Module and remove it from its connectors on the main control board. Be careful not to bend the pins by twisting or lifting the module unevenly.
6. Place the Resolver Feedback Module in an antistatic bag and store it in a clean area for future use.
7. Install the control cover.

Now there is no conflict between this module and the Resolver to Digital expansion board signal inputs to the control board. The Resolver to Digital expansion board will provide the input signals for the control board to use. Continue on page 4-3.

Connections

⚠ WARNING: High voltage is present on the Resolver to Digital expansion board. Do not touch any circuit board, power device or electrical connection before you first ensure that power has been disconnected and there is no high voltage present from this equipment or other equipment to which it is connected. Electrical shock can cause serious or fatal injury. Only qualified personnel should attempt the start-up procedure or troubleshoot this equipment.

Procedure: (Refer to Figure 4-1 and Figure 4-2.)

1. Connect the resolver SINE+ wire to J1 terminal 51 of the Resolver to Digital expansion board.
2. Connect the resolver SINE- wire to J1 terminal 52 of the Resolver to Digital expansion board.
3. Connect the resolver COS+ wire to J1 terminal 53 of the Resolver to Digital expansion board.
4. Connect the resolver COS- wire to J1 terminal 54 of the Resolver to Digital expansion board.
5. Connect the resolver REFERENCE+ wire to J1 terminal 55 of the Resolver to Digital expansion board.
6. Connect the resolver REFERENCE- wire to J1 terminal 56 of the Resolver to Digital expansion board.
7. Connect cable shields to J1 terminal 56 of the Resolver to Digital expansion board. Shields are to be connected at the expansion board. (Shields not connected at the Resolver).
8. Refer to Table 4-1 and set the DIP switches for the resolution you require.

Figure 4-1 Switch and Terminal Locations

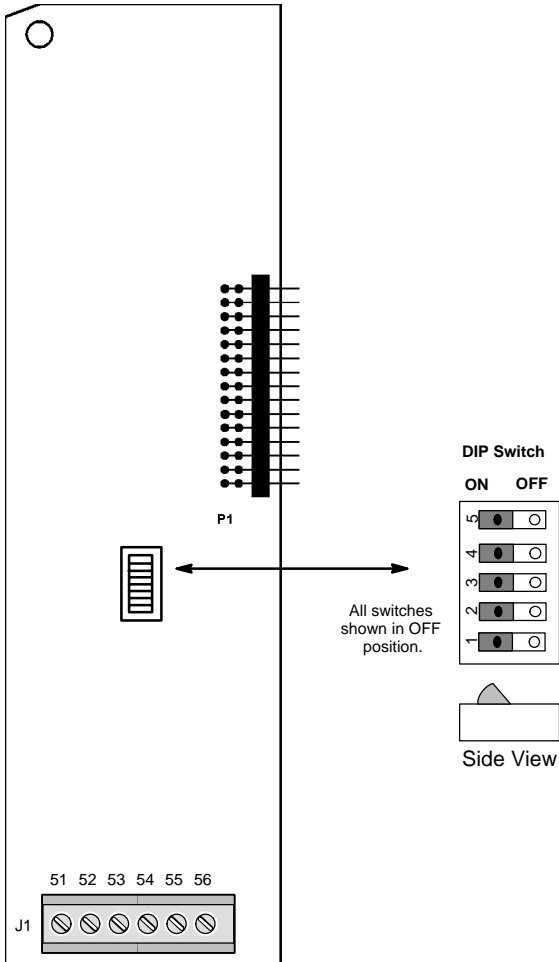

Terminal tightening torque is 7 lb-in (0.8 Nm) maximum.

Figure 4-2 Resolver Connections

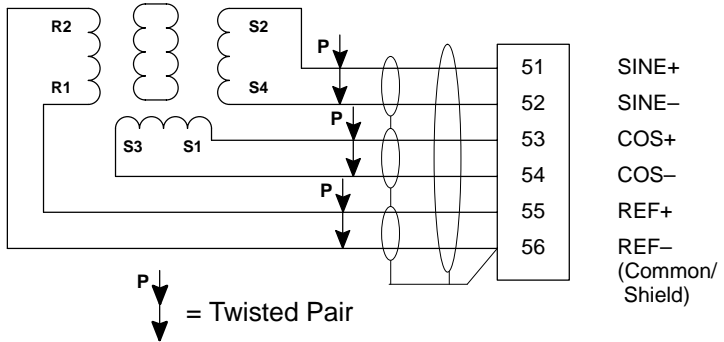

Terminal tightening torque is 7 lb-in (0.8 Nm) maximum.

Table 4-1 Switch Settings

Digital Resolution (Bits)	DIP Switch Number				
	1	2	3	4	5
10	ON	ON	OFF	OFF	ON
12	ON	OFF	OFF	OFF	ON
14	OFF	ON	OFF	ON	OFF
16	OFF	OFF	ON	OFF	OFF



Section 5

Software Setup

Configure Control Software

After the Resolver to Digital Interface board has been installed and the DIP switches are correctly set, the control software must be configured.

Series 18H and 22H Vector Controls

Note: When the Resolver to Digital Interface board is installed, the encoder inputs to the control are automatically disabled (J1 pins 23 to 30).

The value of the Level 2, MOTOR DATA Block, “Resolver Speed” parameter (P2509) must be set to the correct speed value.

Procedure:

1. At the keypad, access the Level 2 Blocks.
2. Scroll to and access the Motor Data Block.
3. Access the Resolver Speed parameter.
Change its' value to the Resolver Speed Type.
Example: For a 2 pole Resolver, enter 1 (1 Speed).
Example: For a 6 pole Resolver, enter 3 (3 Speed).

Series 19H and 20H DC SCR Controls

The value of the Level 2, MOTOR DATA Block, “Feedback Type” parameter (P2507) and “Resolver Speed” parameter (P2509) must be set.

Procedure:

1. At the keypad, access the Level 2 Blocks.
2. Scroll to and access the Motor Data Block.
3. Access the Feedback Type parameter.
Change its' value to RESOLVER.
4. Access the Resolver Speed parameter.
Change its' value to the Resolver Speed Type.
Example: For a 2 pole Resolver, enter 1 (1 Speed).
Example: For a 6 pole Resolver, enter 3 (3 Speed).



BALDOR[®]
MOTORS AND DRIVES

BALDOR ELECTRIC COMPANY
P.O. Box 2400
Fort Smith, AR 72902-2400
(501) 646-4711
Fax (501) 648-5792

© Baldor Electric Company
MN1313

Printed in USA
6/98 C&J2500

Free Manuals Download Website

<http://myh66.com>

<http://usermanuals.us>

<http://www.somanuals.com>

<http://www.4manuals.cc>

<http://www.manual-lib.com>

<http://www.404manual.com>

<http://www.luxmanual.com>

<http://aubethermostatmanual.com>

Golf course search by state

<http://golfingnear.com>

Email search by domain

<http://emailbydomain.com>

Auto manuals search

<http://auto.somanuals.com>

TV manuals search

<http://tv.somanuals.com>