

BEKO

installation & operating
instructions and drying guidance

Condenser
Time Dryer

DRCT 70 W



*get the **best** from your new tumble dryer*

Read this manual prior to initial operation of the product!

Dear Customer,

We hope that your product, which has been manufactured in modern facilities and passed through a strict quality control procedure, will give you very good results.

We advise you to read through this manual carefully before using your product and keep it for future reference.

This User Manual will

- Help you use your machine in a fast and safe way.
- Read the User Manual before installing and starting your product.
- In particular, follow the instructions related to safety.
- Keep this User Manual within easy reach for future reference.
- Please read all additional documents supplied with your product.

Remember that this User Manual is also applicable for several other models.

Explanation of symbols

Throughout this User Manual the following symbols are used:

 Important safety information. Warning for hazardous situations with regard to life and property.

 Caution; Warning for supply voltage.

 Caution; Warning for fire hazard.

 Caution; Warning for hot surfaces.

 Read the instructions.

 Useful information. Important information or useful hints about usage.



This appliance's packaging material is recyclable. Help recycle it and protect the environment by dropping it off in the municipal receptacles provided for this purpose. Your appliance also contains a great amount of recyclable material. It is marked with this label to indicate the used appliances that should not be mixed with other waste.

This way, the appliance recycling organised by your manufacturer will be done under the best possible conditions, in compliance with European Directive 2002/96/EC on Waste Electrical and Electronic Equipment. Contact your town hall or your retailer for the used appliance collection points closest to your home. We thank you doing your part to protect the environment.

TABLE OF CONTENTS

1 Your Dryer	4
Overview	4
2 Important safety information	6
General safety	6
Intended use	7
Children's safety	7
3 Installation	8
Appropriate installation location	8
Under counter installation	8
Ventilation hose and connection (for products equipped with an outlet vent)	8
Adjusting feet	9
First use	9
Disposing of packaging material	9
Transportation of the machine	9
Disposing of the old machine.....	9
4 Electrical Connection	10
Electrical requirements.....	10
Fitting a different plug	10
5 Initial preparations for drying	11
Things to be done for energy saving:.....	11
Laundry suitable for drying in the machine	11
Laundry unsuitable for drying in the machine	11
Preparing laundry for drying.....	12
Correct load capacity	12
Loading	12
6 Selecting a Programme and Operating Your Machine	13
Control panel.....	13
Preparing the machine.....	14
Timer programme selection	14
Main programmes	14

Programme selection and consumption table.....	15
Auxiliary function.....	16
Warning indicators.....	16
Starting the Programme	16
Timer follow-up indicator	16
Changing the programme after the programme has started	16
Child-proof lock.....	16
Ending the programme through cancelling	17
End of programme	17

7 Quick instructions for daily use

18

8 Maintenance and cleaning

19

Fluff filter	19
--------------------	----

9 Solution suggestions for problems

20

10 Door Reversal

21

11 Guarantee

22

What is covered?.....	22
What is not covered?.....	22
Important notes	22

12 Service

23

1 Your Dryer

Overview

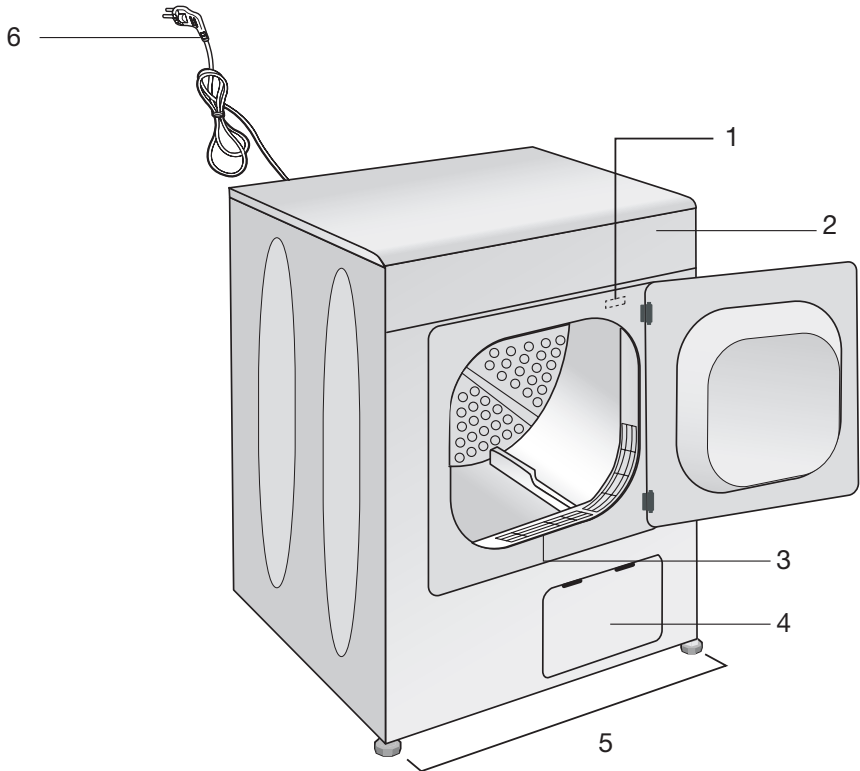

1- Rating label

2- Control Panel

3- Fluff filter

4- Condenser and water tank cover

5- Adjustable Feet

6- Power Cord

Technical Specifications

EN

Height (adjustable)	85.0 cm
Width	59.5 cm
Depth	54 cm
Capacity (max.)	7 kg
Weight (net)	37 kg
Voltage	See rating label
Rated power input	
Model code	

Type label is located behind the loading door.

Specifications of this appliance may change without notice to improve the quality of the product. Figures in this manual are schematic and may not match your product exactly. Values stated on the machine labels or in the documentation accompanying it are obtained in laboratory in accordance with the relevant standards. Depending on operational and environmental conditions of the appliance, values may vary.

2 Important safety information

This section includes safety information that will help protection from risks of personal injuries or materialistic damages. Failure to follow these instructions shall cause any warranty and reliability commitment to become void.

General safety

- Never place the machine on a carpet-covered floor, otherwise, lack of airflow beneath the machine may cause electrical parts to overheat. This will cause problems with your machine.
- If the power cable or mains plug is damaged, you must call Authorised Service Agent for repair.
- The product should not be plugged in during installation, maintenance and repair works. Such works should always be made by the technical service. Manufacturer shall not be held responsible for damages arising from processes carried out by unauthorised persons.
- Connect the product to a grounded outlet protected by a fuse of suitable capacity as stated in the technical specifications table.
- Operate your product at temperatures between +5°C and +35°C.
- Do not use electrical devices in the product.
- Do not connect the air exit of the product to the chimney holes which are used for the exhaust fumes of the devices operating with gas or other types of fuel.
- You must provide enough ventilation in order to prevent gases exiting from devices operating with other types of fuels including the naked flame from accumulating in the room due to the back fire effect.
- Always clean the lint filter before or after each loading.
- Never operate your dryer without the lint filter installed.
- Do not allow fibre, dust and dirt accumulation around the exhaust exit and at adjacent areas.
- Power cable plug must be within easy reach after installation.
- Do not use extension cords, multi-plugs or adaptors to connect the dryer to power supply in order to decrease the risk of electric shock.
- Do not make any changes on the plug supplied with the product. If it is not compatible with the socket, have a qualified electrician change the socket with a suitable one.
- Items cleaned or washed with gasoil/fuel oil, dry-laundry solvents and other combustible or explosive materials as well as the items that are contaminated or spotted with such materials should not be dried in the product since they emit flammable or explosive vapor.
- Do not dry items cleaned with industrial chemicals in the dryer.
- Do not dry unwashed items in the dryer.
- Items soiled with cooking oils, acetone, alcohol, fuel oil, kerosene, stain remover, turpentine, paraffin and paraffin removers must be washed in hot water with plenty of detergent before being dried in the dryer.
- Garments or pillows bolstered with rubber foam (latex foam), shower bonnets, water resistant textiles, materials with rubber reinforcement and rubber foam pads should not be dried in the dryer.
- Do not use fabric softeners and anti-static products unless they are recommended by the manufacturers of the fabric softener or the product.
- This product must be earthed. Grounding installation decreases the risk of electric shock by opening a path with low resistance for the electricity flow in case of a malfunction or failure. Power cable of this product is equipped with a conductor and a grounding plug that allows for grounding the product. This plug must be installed appropriately and inserted into a socket which is grounded in accordance with the local laws and regulations.
- Do not install the product behind a door with a lock, sliding door or a door that has a hinge against the hinge of

the dryer.

- Do not install or leave this product in places where it will be exposed to outdoor conditions.
- Do not tamper with the controls.
- Do not perform any repair or part replacing procedures on the product even if you know or have the ability to perform unless it is clearly suggested in the operating instructions or the published service manual.
- Inside and exhaust duct of the product must be cleaned by the qualified service personnel periodically.
- Wrong connection of grounding conductor of the product can cause electric shock. If you have any suspect about the grounding connection, have it checked by a qualified electrician, service representative or service personnel.
- Do not reach into the machine when the drum is spinning.
- Unplug the machine when it is not in use.
- Never wash down the appliance with water! There is the risk of electric shock! Always disconnect by unplugging from the mains before cleaning.
- Never touch the plug with wet hands. Never unplug by pulling on the cable, always pull out by grabbing the plug only. Do not operate the machine if the power cable or plug is damaged!
- Never attempt to repair the machine yourself, otherwise, you will be putting your life and others' lives in danger.
- For malfunctions that cannot be solved by following the information given in the safety instructions:
Turn off the machine and contact an authorised service agent.
- Do not stop the dryer before the drying cycle comes to an end unless you will remove all laundry from the dryer fast in order to lay them and dissipate the heat.
- Remove the door of the drying compartment before decommissioning or disposing of the product.
- The final step of the drying cycle (cool-down cycle) occurs without applying heat to ensure that the items are left

at a temperature that will not damage them.

- Fabric softeners or similar products should be used as specified by the fabric softener instructions.
- Underwear that contains metal reinforcements should not be placed in a dryer. Damage to the dryer can result if metal reinforcements come loose during drying.
- Check all garments for forgotten lighters, coins, metal pieces, needles, etc. before loading.
- At times when your dryer is not in use or after the laundry is taken out following the completion of drying process, turn off by using the On/Off button. In cases when the On/Off button is on (while the dryer is energized), keep the door of the dryer closed.

Intended use

- This product has been designed for domestic use. It should not be used for other purposes.
- Use the product only for drying laundry that are marked accordingly.
- Dry only those articles in your product that are stated in this manual.
- This product is not intended to be used by persons with physical, sensory or mental disorders or unlearned or inexperienced people (including children) unless they are attended by a person who will be responsible for their safety or who will instruct them accordingly for use of the product.

Children's safety

- Electrical appliances are dangerous for the children. Keep children away from the machine when it is operating. Do not let them tamper with the machine.
- Packaging materials are dangerous to children. Keep the packaging materials out of reach of children or dispose them by classifying according to waste directives.
- Do not allow children sit/climb on or enter in the product.
- Children should be supervised to ensure that they do not play with the product.
- Close the loading door when you leave the area where the product is located.

3 Installation

Refer to the nearest Authorised Service Agent for installation of your product.

- ⓘ Preparation of location and electrical installation for the product is under customer's responsibility.
- ⚠ Installation and electrical connections must be carried out by a qualified personnel.
- ⚠ Prior to installation, visually check if the product has any defects on it. If so, do not have it installed. Damaged products will cause risks for your safety.

Appropriate installation location

- Install the product in an environment which has no risk of freezing and is in a stable and level position.
- Operate your product in a well ventilated, dust-free environment.
- Do not block the air ducts in front of and under the product with materials such as long pile rugs and cupboard plinths.
- Do not place your product on a long pile rug or on similar surfaces.
- Do not install the product behind a door with a lock, sliding door or a hinged door which can strike the product.
- Once the product is installed, it should stay at the same place where its connections have been made. When installing the product, make sure that the rear wall of it does not touch anywhere (tap, socket, etc.) and also pay attention to install the product at a place where it will stay permanently.
- ⚠ Do not place the product on top of the power cable.
- Keep at least 1.5 cm distance to walls of other furniture.

Connection to a water drain (for products equipped with a condenser)

In products equipped with a condenser unit the water accumulated during the drying cycle is collected in the water tank. You should drain the accumulated water after each washing cycle.

You can directly send the accumulated

water out through the water drain hose supplied with the machine instead of periodically draining the water collected in the water tank.

Connecting the water drain hose for models with the water tank at the bottom;

Connection pipe to water drain is at the bottom rear of your machine.

1. Remove the bracket and the rubber cap.
2. Attach the drain hose and replace the bracket to its position.

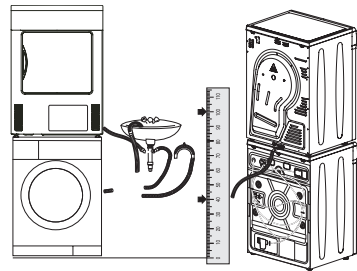
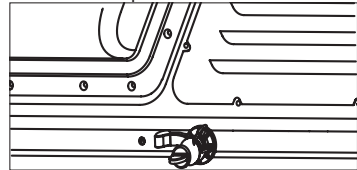

Important:

- ⓘ There is no pump in the machine, so ensure that the hose is placed to allow a easy water flow.
- ⓘ The end of the hose should never be higher than the level of the water outlet on the machine. Otherwise, the "tank full" light of your machine will illuminate and stop the programme.
- ⓘ If the dryer is mounted on the washing machine by means of a bracket, use of the water drain hose is recommended. The drain hose should be directed downwards as shown in the figure.

Adjusting feet

In order to ensure that your product operates more silently and vibration-free, it must stand level and balanced on its feet. Front feet of your product can

be adjusted. Balance the machine by adjusting the feet.

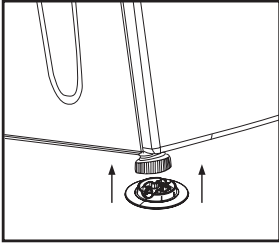

1. Loosen the feet by hand.
2. Adjust the feet until the product stands level and firmly on the floor.

i Do not use any tools to loosen the adjustable feet, otherwise, they can be damaged.

i Never remove the adjustable feet from their housings.

2 plastic pieces supplied along with the user manual prevent your machine from slipping on wet and slippery surfaces. To install the plastic parts:

1. Tilt your product to backwards.
2. Fit the plastic parts on to the front adjustable feet. Press on the plastic parts to snap them into their seating.
3. Check the balance of your product again and readjust the adjustable feet if necessary.

First use

- To have the product ready for operation before calling the authorised service agent, make sure that its location and power supply installations are appropriate. If they are not, call a qualified electrician to have any necessary arrangements carried out.
- Make sure that the power connections of the product are in accordance

with the instructions given in relevant chapters of this manual.

Disposing of packaging material

Packaging materials are dangerous to children. Keep packaging materials in a safe place out of reach of children. Packaging materials of your product are manufactured from recyclable materials. Sort and dispose of them in accordance with recycled waste instructions. Do not dispose of them with normal domestic waste.

Transportation of the machine

1. Unplug the machine from the mains.
2. Remove the water drain (if any) and chimney connections.
3. Drain water remained in the machine completely before transportation.

Disposing of the old machine

Dispose of your old machine in an environmentally friendly manner. Refer to your local dealer or solid waste collection centre in your area to learn how to dispose of your machine. Before disposing of your old machine, cut off the power cable plug and make the loading door lock unusable to avoid dangerous conditions to children.

4 Electrical Connection

Make sure that you have an earthed power outlet socket rated at 13 amps (minimum).

Attention!

If you use your dryer as built-in, the socket must be reachable after installation, or a separate switch (which can disconnect the two poles) must be used in the installation. Check for suitability.

For a permanent connection, a master switch with at least 3mm contact clearance and minimum 13 A rating must be used.

Electrical requirements

Before you insert the plug into the wall socket make sure that the voltage and the frequency shown in the rating label corresponds to your electricity supply. We recommend that this appliance be connected to the mains supply via a suitable switched and fused socket in a readily accessible position. Should the mains lead of the appliance become damaged or need replacing at any time, it must be replaced by a special purpose made mains lead which can only be obtained from a Authorised Service Agent.

⚠ Warning

This appliance must be earthed

If the fitted moulded plug is not suitable for your socket, then the plug should be cut off and an appropriate plug fitted. The moulded plug on this appliance incorporates a 13A fuse. Should the fuse need to be replaced an ASTA approved BS1362 fuse of the same rating must be used. Do not forget to refit the fuse cover. In the event of losing the fuse cover, the plug must not be used until a replacement fuse cover has been fitted. Colour of the replacement fuse cover must be the same colour as that visible on the pin face of the plug. Fuse covers are available from any good electrical store.

In order to avoid hazards, damaged supply cord should be replaced by the manufacturer, its service agent or similarly qualified people.

Built-under installation

This appliance can be installed under a worktop.

⚠ Undercounter installation without the top cover must only be carried out by an authorised agent. Risk of electric shock.

⚠ Important

Fitting a different plug

As the colours of the wires in the mains lead of this appliance may not correspond with the coloured markings identifying the terminals on your plug, proceed as follows:

- 1 Connect the green - yellow or green (earth) wire to the terminal in the plug marked 'E' or with the symbol or coloured green and yellow or green.
- 2 Connect the blue (neutral) wire to the terminal in the plug marked 'N' or coloured black.
- 3 Connect the brown (live) wire to the terminal in the plug marked 'L' or coloured red.

With the alternative plugs a 13A fuse must be fitted either in the plug or adaptor or in the main fuse box. If in doubt contact a qualified electrician.

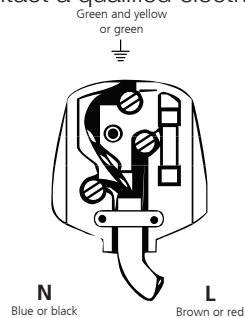

Washer/dryer combination

Do not stack washing machine on top of the tumble dryer. This would damage both appliances and guarantees would become void. It is also unsafe to stack an appliance on top of another without using a suitable and approved stacking kit obtained from the manufacturer of the appliances.

- A special stacking kit is required as an optional extra please contact customer service.

5 Initial Preparations For Drying

Things to be done for energy saving:

- Make sure that you operate the product at its full capacity but pay attention to not exceeding it.
- Spin your laundry at the highest speed possible when washing them. Thus, the drying time is shortened and energy consumption is decreased.
- Pay attention to dry same types of laundry together.
- Follow the instructions in the user manual for programme selection.
- Make sure that sufficient clearance is provided at the front and rear side of the dryer for air circulation. Do not block the grill at the front side of the product.
- Do not open the door of the machine during drying unless necessary. If you must certainly open the door, pay attention not to keep it open for a long time.
- Do not add new (wet) laundry during drying.
- Lint and fibres released from the laundry to the air during the drying cycle are collected in the "Lint Filter". Make sure that you clean the filters before or after each drying.
- In models with condenser, make sure that you clean the condenser regularly at least once every month or after every 15 drying cycles.
- In vented models, follow the chimney connection rules in the user manual and pay attention to the chimney cleaning.
- Ventilate the room, where the dryer is located, well during drying
- For power saving in models with lamps, at times when your dryer is not in use, keep the door closed if the On/Off button is pressed (if the dryer is energized).

Laundry suitable for drying in the machine

- i** Always follow the suggestions on the laundry labels. Dry only the laundry having a label stating that they are suitable for drying in a dryer and make sure that you select the appropriate programme.

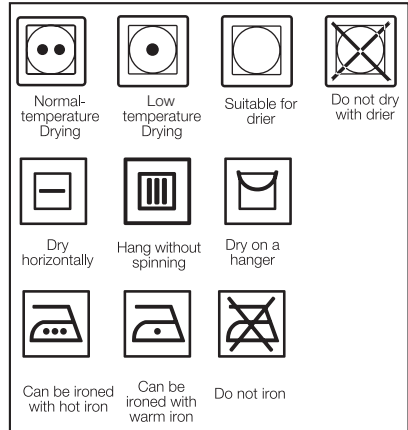

Laundry unsuitable for drying in the machine

- Laundry items with metal attachments such as belt buckles, bra wires and metal buttons can damage your dryer.
- Do not dry items such as woollens, silk garments and nylon stockings, delicate embroidered fabrics, laundry with metal accessories and items such as sleeping bags in the dryer.
- Laundry made of delicate and valuable fabrics as well as lace curtains can be creased. Do not dry them in the dryer!
- Do not dry items made of hermetic fibres such as pillows and quilts in the dryer.
- Laundry made of foam or rubber will be deformed.
- Do not dry laundry containing rubber in the dryer.
- Do not dry laundry exposed to petroleum, oil, combustible or explosive agents in the dryer even if they are washed beforehand.
- Overly wet laundry or laundry with

dripping water must not be put into the dryer.

- Items cleaned or washed with gasoil/ fuel oil, dry-laundry solvents and other combustible or explosive materials as well as the items that are contaminated or spotted with such materials should not be dried in the product since they emit flammable or explosive vapor.
- Do not dry items cleaned with industrial chemicals in the dryer.
- Do not dry your unwashed laundry in the dryer.
- Items soiled with cooking oils, acetone, alcohol, fuel oil, kerosene, stain remover, turpentine, paraffin and paraffin removers must be washed in hot water with plenty of detergent before being dried in the dryer.
- Garments or pillows bolstered with rubber foam (latex foam), shower bonnets, water resistant textiles, materials with rubber reinforcement and rubber foam pads should not be dried in the dryer.
- Do not use fabric softeners and anti-static products unless they are recommended by the manufacturers of the fabric softener or the product.
- Do not dry the underwear reinforced with metal parts in the dryer. If these metal reinforcements loosen and break during drying, they will damage your dryer.

Preparing laundry for drying

- Check all laundry items before loading them into the product to make sure that there are no lighters, coins, metal items, needles and etc. in their pockets or on any part of them.
- Fabric softeners and similar products must be used in accordance with the instructions of the manufacturer of the relevant products.
- All laundry must be spun at the highest spin speed that your washing machine allows for the laundry type.
- Laundry may be tangled after washing. Separate your laundry before placing them into your dryer.
- Sort your laundry according to their types and thicknesses. Dry the same type of laundry together. E.g.: fine kitchen towels and table cloths dry

faster than the thick bath towels.

Correct load capacity

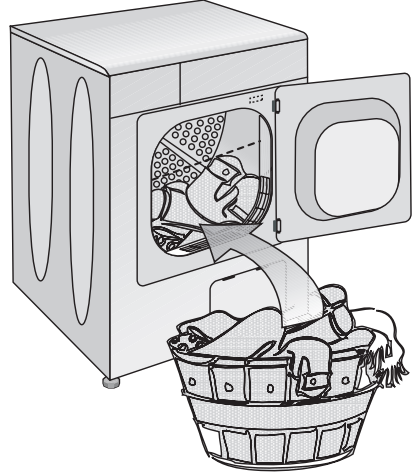

- ⚠ Consider the information in the "Programme Selection Table". Always start the programme in accordance with the maximum load capacity.
- ❗ Adding laundry to the machine more than the level shown in the figure is not recommended. Drying performance will degrade when the machine is overloaded. Furthermore, your dryer and your laundry can be damaged.
- ❗ Place your laundry into the drum loosely so that they will not get tangled.
- ❗ Large pieces (E.g.: bed sheets, quilt covers, large tablecloths) may bunch-up. Stop the dryer 1-2 times during drying process to separate bunched-up laundry.

Following weights are given as examples.

Home articles	Approximate weights (g)
Cotton quit covers (double)	1500
Cotton quit covers (single)	1000
Bed sheets (double)	500
Bed sheets (single)	350
Large tablecloths	700
Small tablecloths	250
Tea napkins	100
Bath towels	700
Hand towels	350
Garments	Approximate weights (g)
Blouses	150
Cotton shirts	300
Shirts	200
Cotton dresses	500
Dresses	350
Jeans	700
Handkerchiefs (10 pieces)	100
T-Shirts	125

Loading

- Open the loading door.
- Place laundry items loosely into the dryer.
- Push the loading door to close. Ensure that no items are caught in the door.

6 Selecting a Programme and Operating Your Machine

Control panel

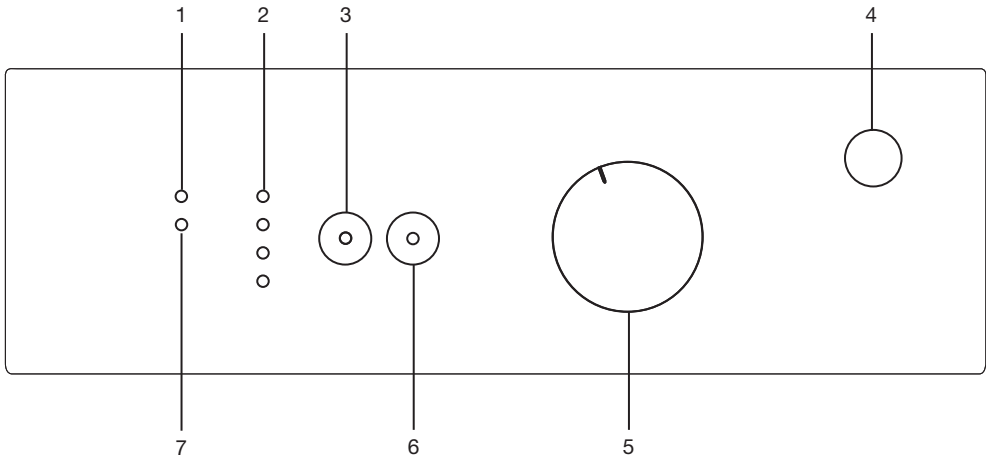

1. Filter cleaning warning light

Warning light turns on when the filter is full.

2. Programme follow-up indicator

Use to follow-up the progress of the current programme.

3. Low temperature

Use to dry in low temperatures.

4. On/Off button

Use to turn on and off the machine.

5. Programme selection knob

Use to select a programme.

6. Start/Pause/Cancel button

Use to start, pause or cancel the programme

7. Water tank warning light

Warning light turns on when the water tank is full.

Preparing the machine

1. Plug in your machine.
 2. Place the laundry in the machine.
 3. Press the “On/Off” button.
- i** Pressing the “On/Off” button does not necessarily mean that the programme has started. Press “Start/Pause/Cancel” button of the machine to start the programme.

Main programmes

•Anti-creasing

A 2-hour anti creasing programme to prevent laundry from creasing will be activated if you do not take the laundry out after the programme has come to an end. This programme rotates the laundry in 60-second intervals to prevent creasing.

•Freshen up

Only ventilation is performed for 10 minutes without blowing hot air. You can air your clothes that have been kept at closed environments for a long time thanks to this programme to deodorize unpleasant odours.

•Timer programmes

You can select one of the 10 min...60 min...80 min... timer programmes to achieve the final drying level. Dry the cotton laundry at high temperatures and synthetic and easy-care laundry at low temperatures depending on the type of the laundry.





i You must press the “Low temperature” button for synthetics

⚠ The drum, door and load may be very hot.

Programme selection and consumption table

EN

Programmes table

Programmes	Capacity (kg)	Spin speed in washing machine (rpm)	Drying time (minutes)
Cottons / Coloureds			
 Ready to Wear	7	1000	150
		800	170
	3.5	1000	80-110
		800	110-130
 Ready to Iron	7	1000	110
		800	130
	3.5	1000	80
		800	80-110
Synthetics			
 Ready to Wear	3.5	800	80
		600	80-110
	1.75	800	40
		600	40
Delicates			
 Ready to Wear	1.75	800	40

Energy consumption values

Programmes	Capacity (kg)	Spin speed in washing machine (rpm)	Approximate amount of remaining humidity	Energy consumption value kWh
Cottons linen Ready to wear*	7	1000	% 60	4.48
Cottons Ready to iron	7	1000	% 60	3.60
Synthetics& Ready to wear	3	800	% 40	1.80

For fabrics spun at higher spin speeds than shown in the table the drying times will be reduced.

* : Energy Label standard programme (EN 61121:2005)

All values given in the table have been fixed according to EN 61121:2005 Standard. These values may deviate from the table according to the laundry type, laundry spin speed, environmental conditions and voltage fluctuations.

Auxiliary function

Low temperature

This function allows for drying at lower temperatures and therefore saves energy. Warning LED will light up when you select the function.

i You must use this function when you dry your synthetic or delicate laundry.

Warning indicators

i Warning indicators may differ according to the model of your machine.

Filter cleaning

A warning LED will light up to remind filter cleaning after the programme finishes.

i If the filter cleaning warning LED lights up continuously, please refer to, "Solution suggestions for problems".

Water tank

⚠ warning LED will light up at the end of the programme or when the tank is full with water. The machine stops operating when this warning LED lights up during a programme running. To restart the machine, please drain the water in the water tank. Press "Start/Pause/Cancel" button to start the programme after you have emptied the water tank. The warning LED goes off and the programme resumes operating.

Starting the Programme

1. Press "Start/Pause/Cancel" button to start the programme.
2. "Start/Pause/Cancel" button will light up to indicate that the programme has started.

Timer follow-up indicator

One of the LED lights will remain on as far as programme runs and shows the approximate remaining time.

i LEDs on the timer follow-up indicator will also flash when the child-proof lock is activated.

Changing the programme after the programme has started

You can use this feature to dry your laundry in a different programme after your machine has started to run.

For example;

Press and hold the "Start/Pause/Cancel" button for about 3 seconds to select "80" minutes programme instead of "60"

minutes programme

Select the "80" minutes programme by rotating the programme knob.

Press "Start/Pause/Cancel" button to start the programme.

i The programme which is selected first will go on even if the programme selection button is moved and another programme mode is selected while the machine is operating. You must cancel the ongoing programme in order to change the drying programme. (See, Ending the programme through cancelling)

Adding/removing laundry in standby mode

In order to add or take out laundry after the start-up of the programme

1. Press the "Start/Pause/Cancel" button to switch the machine to "Pause" mode. Drying process will stop.
2. Open the door at Pause position and close it again after adding or taking out laundry.
3. Press "Start/Pause/Cancel" button to start the programme.

i Any laundry added after the drying process was started may cause the already dried clothes in the machine intermingle with wet clothes and the result will be wet laundry after the drying process is over.

i Laundry may be added or taken out as much as desired during a drying process, but as this process will interrupt drying continuously, it will extend the programme duration and increase energy consumption. Therefore, it is recommended to add laundry before the drying programme is started.

Child-proof lock

There is a childproof lock to prevent any programme interruption due to the pressing of keys while the programme is on. The loading door and all keys except the "On/Off" key on the panel are deactivated when the child-proof lock is active.

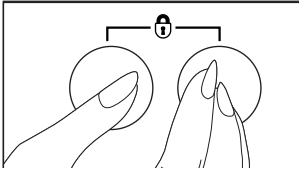

In order to activate the childproof lock, press the “Start/Pause/Cancel” and “Low temperature” buttons simultaneously for 3 seconds.

To start a new programme after the programme is over or to interrupt the programme, the childproof lock should be deactivated. To deactivate the childproof lock, press the same buttons for 3 sec.

i One of the LEDs on the programme follow-up indicator starts flashing when the child-proof lock is activated.

i Child-proof lock is deactivated when the machine is restarted by pressing the On/Off button.

Ending the programme through cancelling

The programme which is selected first will keep on going even if the position of the programme selection button is changed. A new programme can be selected and started after “Programme cancel” is activated in order to change the drying programme.

To cancel any selected programme;

- Press “Start/Pause/Cancel” button for about a duration of 3 seconds. The “Filter cleaning” warning LED as well as the “0” warning LED on the programme follow-up indicator will light up at the end of this period for reminding purposes.

⚠ As the inside of the machine will be excessively hot when you cancel the programme while the machine is running, activate the freshen up programme to cool it down.

End of programme

The “Filter cleaning” warning LED as well as the “0” warning LED on the programme follow-up indicator will light up at the end of the programme. The door can be opened and the machine becomes ready for a second cycle.

Press the “On/Off” button to shut down the machine.

i A 2-hour anti creasing programme to prevent laundry from creasing will be activated if you do not take the laundry out after the programme has come to an end.

i Clean the filter after each drying (please see, Filter cleaning).

7 Quick instructions for daily use

Preparation and starting

1. Press the "On/Off" button.
2. Place the laundry in the machine.
3. Select the programme.
4. Close the loading door.
5. Press "Start/Pause/Cancel" button.

Cancelling a programme

A new programme can be selected and started after "Programme cancel" is activated in order to change the drying programme.

In order to cancel the selected programme, press "Start/Pause/Cancel" button for about 3 seconds. The "Filter cleaning and "0/ Anti-creasing" warning LEDs will light up at the end of this period for reminding purposes.

Adding laundry

In order to add laundry after the start-up of the programme:

1. Press "Start/Pause/Cancel" button.
2. Open the loading door and put the laundry in.
3. Close the loading door.
4. Press "Start/Pause/Cancel" button to start the programme.

Changing the programme after the programme has started

You can use this feature after your machine has started to dry your clothes under higher or lower temperatures. Press and hold the "Start/Pause/Cancel" button for about 3 seconds to switch the machine into the "Cancel" status in order to change the programme. Change the programme and press "Start/Pause/Cancel" button to start it.

After the programme is finished

The "0/Anti-creasing" and "Filter cleaning" warning LEDs on the programme follow up indicator will light up when the programme comes to an end. The door can be opened and the machine becomes ready for a second cycle.

1. Press the "On/Off" button to shut down the machine.
2. Take out the laundry from the machine.
3. Check if there are any foreign objects in the machine.
4. Clean the filter after drying.

8 Maintenance and cleaning

Fluff filter

Lint and fibres released from the laundry to the air during the drying cycle are collected in the "Fluff Filter".

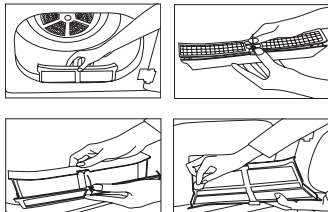

- i** Such fibre and lint are generally formed during wearing and washing.
- i** Always clean the filter after each Drying process.
- i** You can clean the filter and filter area by vacuum cleaner.

For Filter cleaning;

1. Open the cover
2. Remove the fluff filter by pulling it up and open the filter.
3. Clean lint, fibre, and the fluff by hand or with a soft piece of cloth.
4. Close the filter and place it back into its seat.

- i** Clogging may arise on the filter surface after using your machine for some time; if this occurs, wash the filter with water and dry it before using again.

Water tank (Products equipped with a condenser);

The moisture in the damp laundry is taken from the laundry and condensed. Drain the water tank after each drying cycle or during drying when "Water tank" warning light turns on.

- i** You can use the water in the water tank in your steam irons or air humidifiers.

- ⚠** Condensed water is not drinkable!
- ⚠** Never take out the water tank when the programme is running!

Water tank may be located in two different places as indicated below, depending on the model of your dryer.

- Inside the drawer on the panel
- Behind the kick plate cover

If you forget to drain the water tank, your dryer will stop during the following drying cycles when the water tank is full and the

"Water tank" warning light will turn on. If this is the case, press the "Start/Pause/Cancel" button to resume the drying cycle after draining the water tank.

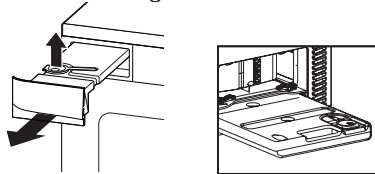

To drain the water tank:

1. Carefully remove the water tank by opening the kick plate cover/pulling the drawer.
2. Drain the water by opening the water tank cover.
3. If there is lint accumulation in the water tank cover, clean it and press to close.
4. Place the water tank back into position.

For the condenser (products with a condenser)

Hot and humid air in the condenser is cooled with the cold air from the room. Thus, the humid air circulating in your dryer is condensed and then pumped into the tank.

- i** Clean the condenser after every 15 drying cycles or once a month.

To clean the condenser:

1. If a drying process has been carried out, open the door of the product and wait until it cools down.
2. Unlock the 4 condenser locks after opening the kick plate.
3. Pull out the condenser.
4. Clean the condenser with pressurized water and wait until the water drains.
5. Replace the condenser with the side of it labelled with "Top" facing upwards. Lock the 4 condenser locks. **Make sure that the red lock on the upper right corner is engaged securely.**
6. Close the kick plate cover.

Close properly and check the locking latches?

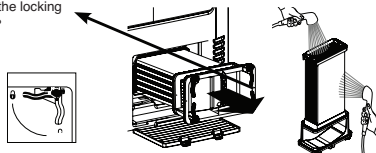

9 Solution suggestions for problems

Problem	Cause	Explanation / Suggestion
Drying process takes too much time.	The filter might have not been cleaned.	* Meshes of the filter may be clogged. Wash with water.
Laundry comes out wet at the end of drying.	* The filter might have not been cleaned. * Excessive laundry might have been loaded in.	* Meshes of the filter may be clogged. Wash with water. * Do not overload the machine.
Machine does not switch on or the programme does not start. Machine is not activated when set.	* It might have not been plugged in. * The loading door may be ajar. * Programme might have not been set or the «Start/Pause/Cancel» button might have not been pressed. * «Childproof lock» might have been activated. * The condenser cover on the models with a condenser might not be closed securely.	* Make sure that the machine is plugged in. * Make sure that the loading door is properly closed. * Make sure that the programme has been set and it is not in "Pause" mode. * Deactivate the childproof lock. * Make sure that the condenser cover and the red lock is closed securely.
Programme has been interrupted without any cause.	* The loading door may be ajar. * Electricity may be cut off.	* Make sure that the loading door is properly closed. * Press «Start/Pause/Cancel» button to start the programme.
Laundry has shrunk, become felted or deteriorated.	* A programme suitable for the laundry type might have not been used.	* Dry only the laundry which is suitable for drying in your machine after checking the labels on your clothes. * Select a programme with suitable low temperature for the laundry type to dry your clothes.
Drum light does not come on. (for models equipped with a lamp)	* The machine might have not been started by using the On/Off button. * Bulb may have blown.	* Make sure that the machine is On. * Call the authorized service to replace the bulb.
0 / Anti-creasing" LED flashes.	* The 2-hour anti creasing programme to prevent laundry from creasing might have been activated.	* Turn off the machine and take out the laundry.
0/ Anti-creasing" LED is on.	* Programme has come to an end.	* Turn off the machine and take out the laundry.
"Filter cleaning" LED flashes.	* Filter might have not been cleaned.	* Clean the cover filter.

⚠ Call an authorised service agent if the problem persists.

10 Door Reversal

1. Unplug the dryer.
2. Open the door.
3. Turn the contact pin in the upper part of door by 90° in the anti-clockwise direction and remove it.
4. Unscrew the 2 screws of each door hinge and remove the door.
5. Removing the door lock: Using a flat screwdriver release the snap-fitted door lock.
6. Remove 2 plugs for the hinges and one for the door-lock on the opposite side.
7. Insert the door lock system on the opposite side of the hinge and be sure it is properly fitted.
8. Reverse the door:
Fit the door on the opposite side using 4 screws removed. Fix the contact pin into the top side of the door by turning 90° in the clockwise direction.

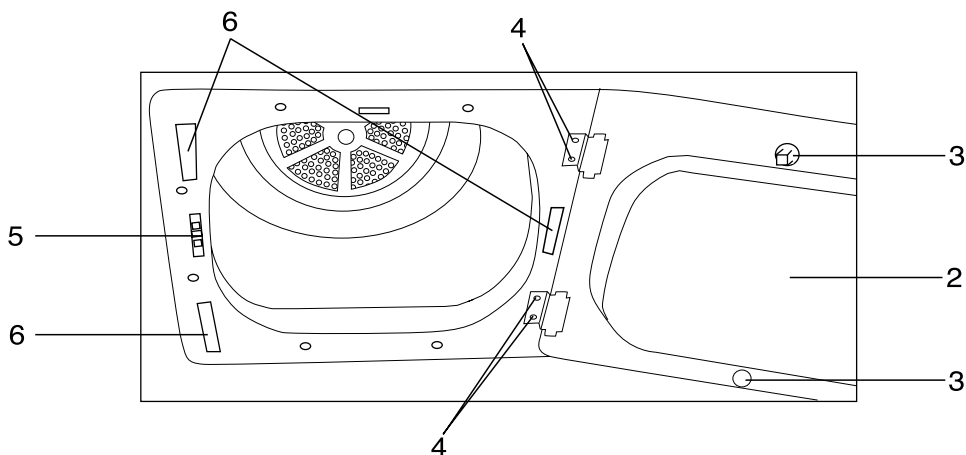

11 Guarantee

Your new product is guaranteed against the cost of breakdown repairs for twelve months from the date of the original purchase.

What is covered?

- Repairs necessary as a result of faulty materials, defective components or manufacturing defect.
- The cost of functional replacement parts, but excluding consumable items.
- The labour costs of a approved repairer to carry out the repair.

What is not covered?

- Transit, delivery or accidental damage or misuse and abuse.
- Cabinet or appearance parts, including knobs, flaps, handles or container lids.
- Accessories or consumable items including but not limited to, ice trays, scrapers, cutlery baskets, filters and light bulbs.
- Repairs required as a result of unauthorised repair or inexpert installation that fails to meet the requirements contained in the user instruction book.
- Repairs to products used on commercial or non-residential household premises.
- Loss of frozen food in freezers or fridge/freezers. (Food loss insurance is often included within your household contents insurance policy, or may be available separately from your retailer).

Important notes

- Your product is designed and built for domestic household use only.
- The guarantee will be void if the product is installed or used in commercial or non-residential domestic household premises.
- The product must be correctly installed, located and operated in accordance with the instructions contained in the User Instructions Booklet provided.
- Professional installation by a qualified Electrical Domestic Appliance Installer is recommended for all Washing Machines, Tumble Dryers, Dishwashers, Dryers and Electric Cookers
- Gas Cookers must only be installed by a GAS SAFE (or BORD GAIS) registered Gas Installer.
- The guarantee is given only within the boundaries of the United Kingdom and the Republic of Ireland.
- The guarantee is applicable only to new products and is not transferable if the product is resold.
- disclaims any liability for incidental or consequential damages.
- The guarantee does not in anyway diminish your statutory or legal rights.

12 Service

Please keep your purchase receipt or other proof of purchase in a safe place; you will need to have it should the product require attention under guarantee.

You should also complete the details below; it will help us assist you when requesting service. (The model number is printed on the Instruction Booklet and the serial number is printed on the Rating Label affixed to the appliance)

Model No:

Serial No:

Retailer:

Date of purchase:

Republic of Ireland

All Refrigeration, 01 862 3411

All Cookers

Washing Machines & Dryers, Tumble

Dryers Dishwashers

Before requesting service please check the trouble-shooting guide in the Operating Instructions as a charge may

be levied where no fault is found even though your product may still be under guarantee.

Service once the manufacturers guarantee has expired.

If you have purchased an extended guarantee please refer to the instructions contained within the extended guarantee agreement document. Otherwise please call the appropriate number above where service can be obtained at a charge.

Should you experience any difficulty in obtaining service please contact the Customer Help-Line.

Tel: 0845 600 4911

For service under guarantee simply telephone the appropriate number below.

UK Mainland & Northern Ireland

Fridges & Freezers 0845 600 4903

Electric Cookers 0845 600 4902

Gas & 0845 600 4905

Dual Fuel Cookers

Washing Machines & Dryers

Tumble Dryers 0845 600 4906

BEKO



BEKO

**Beko plc Beko House, Caxton Way, Watford
Hertfordshire, WD18 8UF**

Tel: 0845 6004911

Fax: 0845 6004922

Email: service@beko.co.uk

www.beko.co.uk

Free Manuals Download Website

<http://myh66.com>

<http://usermanuals.us>

<http://www.somanuals.com>

<http://www.4manuals.cc>

<http://www.manual-lib.com>

<http://www.404manual.com>

<http://www.luxmanual.com>

<http://aubethermostatmanual.com>

Golf course search by state

<http://golfingnear.com>

Email search by domain

<http://emailbydomain.com>

Auto manuals search

<http://auto.somanuals.com>

TV manuals search

<http://tv.somanuals.com>