

 BIONAIRE®

PERMAtech® ionizing  
air cleaner

with air quality sensor

MODELS BAP1700  
BAP1700C

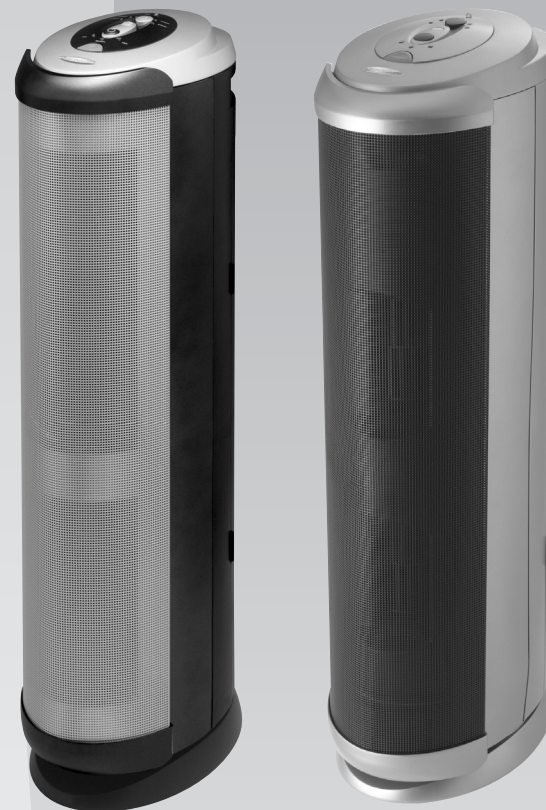

Read instructions before operating.

Retain for future reference.

## Instruction Leaflet

 **INFO-LINE**

If after having read this leaflet, you have any questions or comments on your air cleaner, call **1-800-253-2764** in North America.

 BIONAIRE®

Printed in China

9100040003375  
BAP170008EM1

## AIR CLEANER SAFETY

# READ AND SAVE THESE IMPORTANT SAFETY INSTRUCTIONS

When using electrical appliances, basic safety precautions should always be followed to reduce the risk of fire, electric shock, and injury to persons. These precautions include:

- Read all instructions before using the appliance.
- To avoid fire or shock hazard, plug the appliance directly into a 120V AC electrical outlet.
- If the filter is covered by a bag when shipped, remove plastic bag before use.
- Keep the cord out of heavy traffic areas. To avoid fire hazard, NEVER put the cord under rugs, near heat registers, radiators, stoves, or heaters.
- To protect against electrical hazards, DO NOT immerse the appliance in water or other liquids. Do not use near water.
- Close supervision is necessary when any appliance is used by or near children, or disabled persons.
- Always unplug the air cleaner before moving or cleaning the unit, opening the grill, changing the filters and whenever the unit is not in use. To disconnect the unit, be sure to pull the plug and not the cord.
- NEVER drop or insert any objects into the openings of the unit.
- Do not operate any appliance with a damaged cord or plug. If the motor fan fails to operate or the unit has been dropped or damaged in any manner, return appliance to manufacturer for examination and/or repair.
- Use appliance only for intended household use as described in this manual. Any other use not recommended by the manufacturer may cause fire, electric shock, or injury to persons. The use of attachments not recommended or sold by Jarden Consumer Solutions may cause hazards.
- DO NOT use outdoors.
- NEVER place on a soft surface such as a bed or sofa

as this could cause the unit to tip over and block the air inlet or outlet grills.

- Keep unit away from heated surfaces and open flames.
- DO NOT attempt to repair or adjust any electrical or mechanical functions on this unit. Doing so will void your warranty. The inside of the unit contains no user serviceable parts. All servicing should be performed by qualified personnel only.
- **WARNING:** To reduce the risk of fire or electric shock, DO NOT use this appliance with any solid-state speed control device.
- DO NOT place anything on top of unit.
- NEVER use detergents, gasoline, glass cleaner, furniture polish, paint thinner, or other household solvents to clean any part of the appliance.
- Always turn the appliance off before unplugging it.
- The ionizer may cause a static charge to build up on the air outlet grill. A static charge may be felt if the unit is not properly grounded. To avoid a static charge, plug the unit's three-prong plug into a grounded outlet, or properly install a ground adaptor (see PLUG SAFETY). The static charge will not occur if the ionizer is off.
- The ionizer in this appliance produces less ozone than the UL established limits of 50ppb. However, in high concentrations, ozone can be harmful to birds and small pets. To prevent ozone buildup, we suggest using the ionizer in well ventilated areas with the fan on.
- This appliance should only be used in a room with temperatures between 40° F and 110° F.

## PLUG SAFETY

To reduce the risk of electric shock, THIS PRODUCT IS EQUIPPED WITH A 3-PRONG PLUG, a grounding type plug that has a third (grounding) pin.

The cord has a plug (A) as shown. An adapter (C) can be purchased for connecting three-blade grounding-type plugs to two slot receptacles (B).

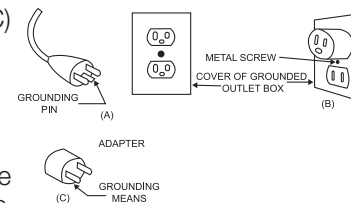

The green grounding wire or lug extending from the

adapter must be connected to a permanent ground such as a properly grounded outlet box. The adapter should not be used if a three-slot grounded receptacle is available.

This plug will only fit into a grounding type power outlet. If the plug does not fit into the outlet, contact qualified electrician to install the proper outlet.

This product is for use on 120 volts. DO NOT ALTER THE PLUG IN ANY WAY.

## CORD SAFETY

- The length of cord used on this appliance was selected to reduce tangling or tripping hazards.
- If a longer cord is necessary, an approved extension cord may be used. The electrical rating of the extension cord must be equal to or greater than the electrical rating of the air cleaner (see rating label marked on product).
- Care must be taken to arrange the extension cord so that it will not drape over the countertop or tabletop where it can be pulled on by children or accidentally tripped over.

## FEATURES

### GET TO KNOW YOUR AIR CLEANER

Your Bionarie® air cleaner features a Permanent HEPA-Type filter that removes up to 99% of airborne dust and pollen as small as 2 microns and helps reduce smoke, mold spores and pet dander from the air passing through the filter.

- Permanent filters can be vacuumed every few months for easy cleaning.
- Washable pre-filter captures larger particles and extends the permanent filter's cleaning cycle.
- Optional ionizer naturally improves performance and helps freshen the air.
- Slim tower design allows placement in almost any area of the room.

### AIR QUALITY PARTICLE SENSOR

Your Bionaire® air cleaner includes a particle sensor that measures indoor air quality. When set to auto mode, it

automatically adjusts the fan speed to cycle between low, medium and high speed to provide optimum filtration based on air particulate concentration. It also helps conserve energy by only operating the fan at higher speeds when needed.

### IONIZER

This appliance has an optional ionizer feature which, when turned on, releases negative ions into outgoing filtered air to help the air purification process.

#### What Are Ions?

Ions are tiny particles that carry a positive or negative charge. They exist naturally around us: in the air, water, and ground. Both positive and negative ions are colorless, odorless, and completely harmless.

#### How Does The Ionizer Work?

Negative ions help air purification by attaching themselves to very small airborne particles in the room. These particles take on a negative charge and may join with positively charged particles such as dust, pollen, smoke, and pet dander to form larger particles. The larger particles are then more easily captured by the filter system.

#### Important Notes:

Your ionizer may produce an occasional popping or cracking sound. This is normal and occurs when a small buildup of ions is discharged.

After extended use, you may notice dust around the grills or front panel.

- This is caused by negative ions exiting the air outlet, evidence of the ionizer's air cleaning effectiveness.
- You can remove the dust with a soft brush or clean, damp cloth.

Larger particles may be attracted to positively charged surfaces throughout the home, like walls or floors.

- This may occur more frequently when the filter is nearing the end of its useful product life and unable to capture as many charged particles.
- Excessive amounts of pet dander, dust, or smoke may decrease the life expectancy of the filter(s) and interfere with the ionization process.

To help prevent particles from attracting to surfaces throughout your home:

- You may want to run the ionizer less often.
- Check the condition of the filter(s) more frequently.

**CAUTION:** The ionizer in this appliance produces less ozone than the UL\* established limits of 50ppb. However, in high concentrations, ozone can be harmful to birds and small pets. To prevent ozone buildup, we suggest using the ionizer in well ventilated areas with the fan on.

**IMPORTANT:** Always clean the PERMAtech® filter at the recommended intervals (See CLEANING THE PERMAtech® FILTER). Using the ionizer with dirty filters may result in dirty particles exiting the air purifier and attracting to walls, carpets, furniture, or other household objects. These dirty particles may prove difficult to remove.

### HEPA-TYPE PERMAtech® FILTER

The PERMAtech® filter allows easy maintenance and eliminates the hassle of filter replacement. HEPA-type (High Efficiency Particulate Air) filters are designed to remove up to 99% of airborne pollutants, at 2 microns or larger, from the air that passes through them. These include tobacco smoke, household dust, pet dander and pollen.

### FILTER INDICATOR

The filter indicator light eliminates guesswork by letting you know when it is time to clean the filters.

### TIMER

The timer allows you to run the air cleaner at your convenience, for up to 8 hours, and automatically turns the power off when time is up, to help reduce energy costs.

### HIGH /MEDIUM, AND LOW SPEED SETTINGS

For optimum air filtration, operate your Bionaire® Air Cleaner continuously on the HI setting. Its rugged motor has been designed to give many years of use. For quieter operation (such as in a bedroom), select LOW setting.

\*tested and listed by the Underwriters Laboratories, Inc.

## BEFORE USE

1. Carefully unpack your air cleaner.
2. Select a firm, level surface with no obstructions to the air inlets or outlets.
3. If the filter is covered by a bag when shipped, remove plastic bag before use and place filters into unit (See INSTALLING THE FILTERS).

## OPERATING INSTRUCTIONS

### IMPORTANT:

- Remove all plastic bags from filters before use.
- DO NOT POINT FILTERED AIR OUTLET TOWARDS WALL.

To operate your air cleaner:

1. Press the POWER button.
  - The air cleaner will turn on at LOW filtering speed.
2. Select filtering speed by pressing POWER button until you reach the desired speed - HIGH, MEDIUM, LOW or OFF.
  - The air cleaner will also turn off when you press the POWER button for 3 seconds at any speed.
3. Press IONIZER button to turn ionizer ON or OFF.
  - IONIZER button works in any mode except when air cleaner is turned off.

### AIR QUALITY PARTICLE SENSOR

The AUTO feature uses the particle sensor to cycle between low, medium and high speeds, based on surrounding indoor air quality. To use this feature:

1. When air cleaner is off, press the AUTO button.
  - The button will illuminate and the air cleaner will turn on to auto mode.
2. When air cleaner is on and set at any manual mode speed, press the "auto" button.
  - The button will illuminate and the air cleaner will run in auto mode.

### SETTING THE TIMER MODE

You may set the timer so it automatically turns off when the desired time has elapsed:

- Press the TIMER button until you reach the desired number of hours you want the unit to operate (2, 4, 6 or 8)
  - The number of hours selected will light up and remain illuminated on the control panel.
  - When time is up, the air cleaner will beep 3 times and turn off.
- To CANCEL the timer, press the TIMER button one more time. You may also cancel the timer operation by turning the power button off.

## CLEANING AND MAINTENANCE

### CLEANING THE PERMAtech® FILTER

The PERMAtech® filter is designed to never need replacement. However, we recommend regular cleaning for optimal performance.

- Every few weeks, check the condition of the filter.
- After approximately 3 months of operation, a Filter Clean Indicator will alert you to clean the filter before further use.

To clean the filter:

- Turn off and unplug the air cleaner.
- Remove the air inlet grill by pulling on the tab.
- Remove and examine the foam pre-filter.
  - If it has collected dust or lint, remove and wash it in warm soapy water. Rinse and drip dry thoroughly before placing it back into the grill inlet.
- Check the condition of the PERMAtech® filters and remove if dirty.
- Clean the PERMAtech® filter.
  - Using your vacuum cleaner, run the brush attachment along both sides of the filter and clean between the pleated layers (Figure 2).

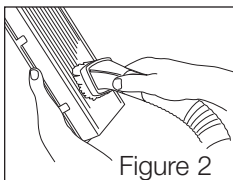
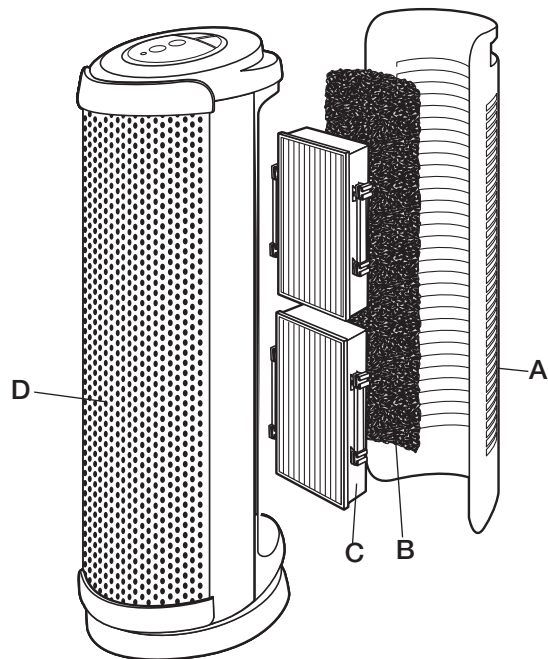
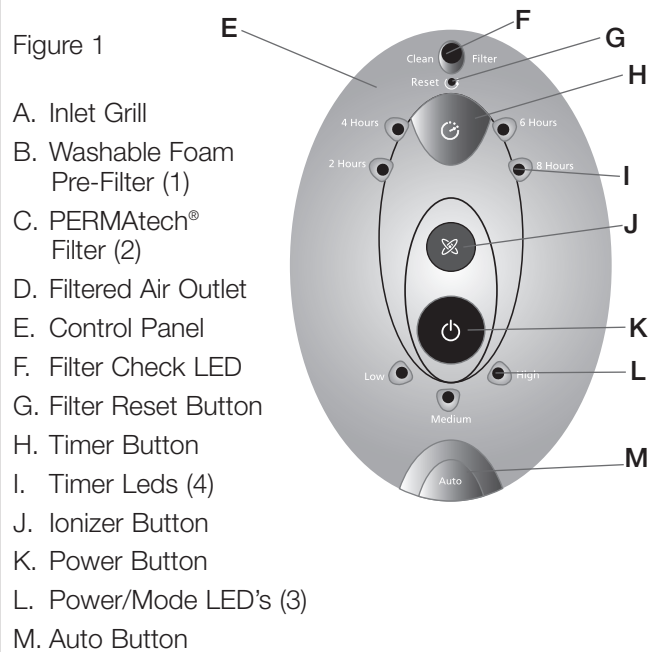

Figure 2

**IMPORTANT: Do not use water, household cleaners or detergents to clean the PERMAtech® filter.**

Figure 1



The filter may appear discolored, even after vacuuming. This is normal and does not affect performance in any way—a new filter is not necessary.

If the filter becomes damaged during cleaning, call 1-800-253-2764 to order replacements.

### REINSTALLING THE PERMAtech® FILTER AFTER CLEANING

**NOTE:** A hang tab and filter clips ensure the filter attaches properly.

1. Make sure the hang tab is securely in place. Align the clip on the top of the PERMAtech® filter with the rails on the inside of the unit. Gently slide the filter onto the rail (see Figures 3 and 4).
2. Place air inlet grill back onto unit securely.
3. After replacing the filters, RESET the Clean Filter Indicator (☺) by inserting a small object (such as a pin or paper clip) into the hole below the filter change light (see Figure 5). The light will turn off.

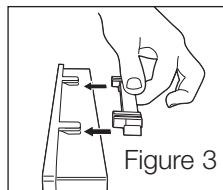

Figure 3

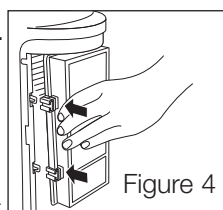

Figure 4

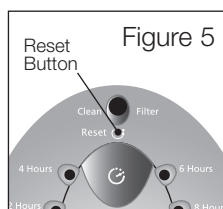

Figure 5

## TIPS AND TROUBLESHOOTING

ISSUE	SOLUTION
UNIT WILL NOT OPERATE	<ul style="list-style-type: none"> <li>• Make sure unit is properly plugged in and outlet is energized.</li> <li>• Make sure unit turned ON.</li> </ul>
DECREASED AIR FLOW	<ul style="list-style-type: none"> <li>• Make sure nothing is blocking air inlet and filtered air outlets.</li> <li>• Remove all plastic bags from filters.</li> <li>• Check condition of filters and clean if necessary.</li> <li>• Make sure that the air intake grill is at least 1 to 3 feet from away the wall.</li> <li>• When unit operates in the AUTO mode, it will automatically adjust the fan speed to provide optimum filtration based on air particulate concentration. Therefore, depending on the air quality in the room, some variation in air flow is normal and expected.</li> </ul>
PERMAtech® FILTER APPEARS DIRTY, EVEN AFTER VACUUMING CLEAN	<ul style="list-style-type: none"> <li>• This is normal and does not affect performance in any way. A new filter is not necessary.</li> </ul>
EXCESSIVE NOISE	<ul style="list-style-type: none"> <li>• Remove plastic bag(s) from filter(s).</li> <li>• Make sure parts are firmly positioned in place.</li> </ul>

## LEARNING MORE

For a wealth of information about your air cleaner and other Bionaire® products, visit our web site at [www.bionaire.com](http://www.bionaire.com).



## 5 YEAR LIMITED WARRANTY

Sunbeam Products, Inc. doing business as Jarden Consumer Solutions or if in Canada, Sunbeam Corporation (Canada) Limited doing business as Jarden Consumer Solutions (collectively "JCS") warrants that for a period of five years from the date of purchase, this product will be free from defects in material and workmanship. JCS, at its option, will repair or replace this product or any component of the product found to be defective during the warranty period. Replacement will be made with a new or remanufactured product or component. If the product is no longer available, replacement may be made with a similar product of equal or greater value. This is your exclusive warranty. Do NOT attempt to repair or adjust any electrical or mechanical functions on this product. Doing so will void this warranty.

This warranty is valid for the original retail purchaser from the date of initial retail purchase and is not transferable. Keep the original sales receipt. Proof of purchase is required to obtain warranty performance. JCS dealers, service centers, or retail stores selling JCS products do not have the right to alter, modify or any way change the terms and conditions of this warranty.

This warranty does not cover normal wear of parts or damage resulting from any of the following: negligent use or misuse of the product, use on improper voltage or current, use contrary to the operating instructions, disassembly, repair or alteration by anyone other than JCS or an authorized JCS service center. Further, the warranty does not cover: Acts of God, such as fire, flood, hurricanes and tornadoes.

### What are the limits on JCS's Liability?

JCS shall not be liable for any incidental or consequential damages caused by the breach of any express, implied or statutory warranty or condition.

Except to the extent prohibited by applicable law, any implied warranty or condition of merchantability or fitness for a particular purpose is limited in duration to the duration of the above warranty.

JCS disclaims all other warranties, conditions or representations, express, implied, statutory or otherwise.

JCS shall not be liable for any damages of any kind resulting from the purchase, use or misuse of, or inability to use the product including incidental, special,

consequential or similar damages or loss of profits, or for any breach of contract, fundamental or otherwise, or for any claim brought against purchaser by any other party.

Some provinces, states or jurisdictions do not allow the exclusion or limitation of incidental or consequential damages or limitations on how long an implied warranty lasts, so the above limitations or exclusion may not apply to you. This warranty gives you specific legal rights, and you may also have other rights that vary from province to province, state to state or jurisdiction to jurisdiction.

### How to Obtain Warranty Service

#### In the U.S.A.

If you have any question regarding this warranty or would like to obtain warranty service, please call 1-800-253-2764 and a convenient service center address will be provided to you.

#### In Canada

If you have any question regarding this warranty or would like to obtain warranty service, please call 1-800-253-2764 and a convenient service center address will be provided to you.

In the U.S.A., this warranty is offered by Sunbeam Products, Inc. doing business as Jarden Consumer Solutions located in Boca Raton, Florida 33431. In Canada, this warranty is offered by Sunbeam Corporation (Canada) Limited doing business as Jarden Consumer Solutions, located at 20 B Hereford Street, Brampton, Ontario L6Y 0M1. If you have any other problem or claim in connection with this product, please write our Consumer Service Department.

**PLEASE DO NOT RETURN THIS PRODUCT TO ANY OF THESE ADDRESSES OR TO THE PLACE OF PURCHASE.**

© 2008 Sunbeam Products, Inc. doing business as Jarden Consumer Solutions. All Rights Reserved. Distributed by Sunbeam Products, Inc. doing business as Jarden Consumer Solutions.

BAP170008EM1

Printed in China

## Free Manuals Download Website

<http://myh66.com>

<http://usermanuals.us>

<http://www.somanuals.com>

<http://www.4manuals.cc>

<http://www.manual-lib.com>

<http://www.404manual.com>

<http://www.luxmanual.com>

<http://aubethermostatmanual.com>

Golf course search by state

<http://golfingnear.com>

Email search by domain

<http://emailbydomain.com>

Auto manuals search

<http://auto.somanuals.com>

TV manuals search

<http://tv.somanuals.com>