

Operating Instructions
Mode d'emploi
Instrucciones de manejo
Instrução de serviço

BLAUPUNKT
Bosch Group



CD-R-D-S
RADIO DATA SYSTEM

VarioColour

Contents

Key Features:	4	Station tuning	14	Switching the tape side (autoreverse) ..	19
Codem IV-US Tuner Features:	4	Automatic (seek) tuning \wedge/\vee	14	Tape equalisation	19
Audio Features:	4	Manual tuning with $\ll\gg$	14	Scanning cassette tracks with SCAN ..	20
Cassette Features:	4	RDS Seek (only FM)	15	Dolby B NR*	20
DMS CD Changer Control Features:	4	Changing the memory bank (FM)	15	Skipping unrecorded tape portions	
Other Features:	4	Storing stations	15	with Blank Skip	20
Quick reference	5	Automatically storing the strongest		Listening to the radio during fast tape	
Important notes	11	stations with Travelstore	15	winding with RM (Radio Monitor)	20
Precautions	11	Recalling stored stations	15	Care notes	20
Traffic safety	11	Scanning stored stations with		CD changer operation (optional) 21	
Installation	11	Preset Scan	16	Switching to CDC operation	21
Telephone mute	11	Scanning stations with Radio-Scan	16	Selecting CDs and tracks	21
Accessories	11	Changing the scan time	16	MIX playback	21
KeyCard theft protection		Selecting the seek tuning sensitivity	16	Selecting the display mode	21
system	12	Switching from stereo to mono (FM)	16	Storing the display mode	22
Putting the unit into operation	12	PTY – Program Type	16	SCAN operation	22
Removing the KeyCard	12	Switching PTY on/off	16	Entering CD names	22
Replacing a KeyCard	12	Program types	17	Deleting CD names with	
Loss of both KeyCards	12	Checking the program type of the		DSC-UPDATE	22
Displaying the radio pass data	13	station	17	DSC programming	23
Optical indication for extra		Displaying the selected program type	17	Overview of the DSC factory	
security	13	Selecting a program type	17	settings	25
Care of your KeyCard	13	Storing program types	18	Appendix	26
Switching the audio source	13	Scanning stations with PTY-SCAN	18	Specifications	26
Radio operation with RDS	14	Emergency Alert System	18		
AF - Alternative frequency	14	Tape operation	19		
Selecting a waveband	14	Inserting a tape	19		
		Removing a tape	19		
		Fast Forward/Rewind	19		
		Selecting tracks with S-CPS	19		



FCC warning for USA

The equipment has been tested and found to comply with the limits for a Class B device, pursuant to Part 15 of the FCC Rules. These limits are designed to provide reasonable protection against harmful interference in a residential installation. This equipment generates, uses, and can radiate radio frequency energy, and, if not installed and used in accordance with instructions, may cause harmful interference with radio communications. However, there is no guarantee that radio interference will not occur in particular installation. If this equipment does cause harmful interference to radio or television reception, which can be determined by turning the equipment off and on, the user is encouraged to contact the dealer or an experienced Radio/TV technician for help.

You are cautioned that any changes or modifications not expressly approved in this manual could void your authority to operate this equipment.

The shielded interface cable recommended in this manual must be used with this equipment in order to comply with limits for a digital device pursuant to Sub-part B of Part 15 of the FCC rules.

Congratulations on your purchase of this Blaupunkt Cassette Radio with CD Changer Control. Its Codem IV-US RDS tuner and full-featured cassette deck provide the ultimate in sound reproduction. Its high-power amplifier and 4-Channel preamp output provide you with versatility in configuring your car audio system. In addition, Blaupunkt's exclusive Direct Software Control menu allows you to customize many of the features to your specific personal preferences. And no other company offers radios with either VarioColour Illumination or the KeyCard Security System.

Here is a recap of feature highlights:

Key Features:

- KeyCard Security System with 2 Key-Cards
- Each Keycard also holds separate Preset, Audio and DSC Settings
- Flashing LED "Tongue" Warning System & Window Decals
- VarioColour Illumination
- Brightness and Viewing Angle Adjustment
- 17 Direct Software Control Menu Options
- Wireless Remote Control Ready

Codem IV-US Tuner Features:

- RDS (Radio Data System) Reception
- Station Call Letter Display
- PTY Program Type Seek
- AF Alternative Frequency Search
- Emergency Alert System Capability
- Multipath Management
- 18 FM/6 AM Presets, including 6 FM/6 AM TravelStore Presets
- Station Scan & Preset Scan
- 3 lo and 3 dx Tuning Sensitivities
- ASU Electrical Impulse Noise Suppression

Audio Features:

35 x 4 Watts Peak Internal Power
Dual-Level Fader
4-Channel 2.0 V Preamp Out w/75 Ohm Resistance
Switchable Auxiliary Input

Cassette Features:

Soft-Touch, Full-Logic Deck
Super CPS Program Search
Tape Scan & Blank Skip
Dolby B Noise Reduction
AutoMetal Tape Equalization

DMS CD Changer Control Features:

Controls Blaupunkt CDC-A05 or CDC-A071 Changer
Disc Naming
Track Scan
MIX CD
MIX MAG

Other Features:

Quick-Release Wire Harness
DIN Chassis, Bracket & Hardware
Dimensions 179 x 50 x 150 mm

Designed, Engineered and Manufactured by Blaupunkt in Germany

① Switching on/off at a ON button:

Press ON.
When switching the set on with the ON button, the KeyCard has to be inserted. The unit will play with the pre-adjusted volume.



Switching on/off with the KeyCard:

Turn the unit ON.
Make the orange tongue stick out by pressing it into the radio so that it pops out. Insert the KeyCard into the slot with the gold contact facing up and the arrow pointed into the unit.

Note:
Read the information in chapter "Key-Card theft protection system".

Switching on/off via the ignition:

When connected correspondingly, the set can also be turned on and off via the vehicle ignition.

After the ignition has been switched off, a double beep tone will remind you that you should remove the KeyCard before leaving your vehicle.

Switching on with the ignition being switched off:

To keep on operating the set when the ignition is switched off (KeyCard is inserted), proceed as follows:
Press ON after the double beep tone. The unit will be turned-on.

② VOL+ / VOL-

To alter the volume.
Each time the set is switched on, it will play with the pre-adjusted volume (VOL FIX).
You may also change the VOL FIX setting (see chapter "DSC programming").

③ MUTE

For instantly muting the volume.
By pressing the MUTE button the volume will be muted immediately. "MUTE" will appear in the display.
The function is cancelled by pressing button MUTE or VOL+.

When pressing VOL-, the normal volume will be by one grade lower than the mute volume.

To program the mute volume level, proceed as follows:

- Adjust the desired volume.
- Press MUTE for two seconds until you hear a beep.

Now this volume level is stored as your mute volume.

Extra function MUTE

Memory storing button in the DSC menu.

⑤ AMT

AM switch

Extra function AMT

To store the six most powerful stations automatically with Travelstore:
Press AMT until you hear a beep or "T-STORE" appears in the display.

⑥ Rocker switch

Radio operation

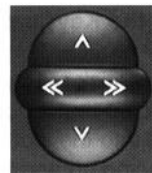

▲ / ▼ Station search (seek tuning)
▲ Up
▼ Down
<< / >> Up/Down in short intervals when AF is off (manual tuning)

<< / >> When AF is on, press << / >> to seek previously-turned RDS stations. Once RDS stations have been turned in by radio, they are added to this RDS seek table. e.g. WNEW, WNYC-FM, THE WAVE.

Tape operation

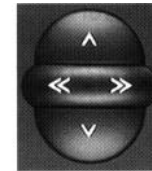

▲ / ▼ Track selection (S-CPS) ▲ Up
▼ Down

>> Fast forward

<< Fast rewind

Stop function by pressing ▲ ▼.

④ FMT

Press repeatedly to switch between the FM memory banks I, II and T (Travelstore).

When pressing this button, the system will automatically switch to FM.

Extra function FMT

To store the six most powerful stations automatically with Travelstore:
Press FMT until you hear a beep or "T-STORE" appears in the display.

Chanaer ooperation (optional)

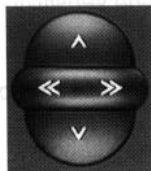

CD Disc selection

>> up
<< Down

Track selection

- ▲ **Upwards:** Press briefly.
CUE - fast advance (audible);
Keep depressed.
- ▼ **Downwards:** Press as many times as required.
To restart a track: Press briefly.
REVIEW -fast reverse (audible);
Keep depressed.

**Extra rocker switch functions:
Further setting functions with**

- AUD** (26)
- GEO** (25)
- DSC MODE** (24)
- PTY** (14)

Condition: The corresponding function has to be activated.

⑦ **Display**

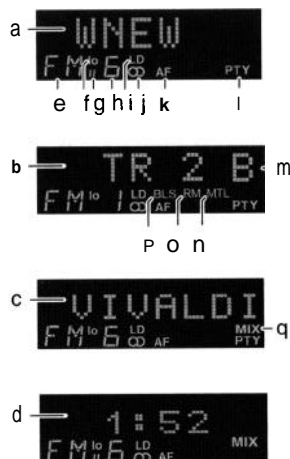

- a) WNEW - Station name
- b) TR 2 - Track (side) 2 of the cassette
- c) VIVALDI - CD name or
- d) 1 : 52 - CD time (playback time) and number for changer operation (optional)
- e) FM - Waveband
- f) lo - Seek tuning sensitivity
- g) I, II, T - Memory bank I, II or Travel-store
- h) 6 - Preset button (I-6)
- i) LD - Loudness

- j) ∞ - Stereo
- k) AF - Alternative frequency for RDS operation
- l) PTY - Program type function
- m) B - Dolby B noise reduction
- n) MTL - A metal or CrO₂ type is being played
- o) RM - Radio-Monitor (to listen to the radio during fast tape winding)
- p) BLS - Blank-Skip (to skip un-recorded tape portions)
- q) MIX - CD playback in random order

⑧ **KeyCard theft protection system**

To operate the set it is necessary that the KeyCard is inserted.



For this purpose, introduce the Key-Card (with the contact area showing up) into the slot above the tongue sticking out of the unit.

To remove the card, press first to unlock.

Read also the information in chapter "KeyCard theft protection system".

“Flashing KeyCard tongue

When the radio is turned off and the KeyCard removed, the KeyCard tongue can be programmed to flash for optical theft protection.

For more information see chapter "DSC programming".

This flashlight can be switched off by pushing in the tongue and lock.

⑨ **MIX**

Chanaer (CDC) operation (optional)

MIX CD

The CD tracks will be played at random.

The individual discs are selected in numeric order.

MIX MAG

The CD tracks will be played at random.

The individual discs are also selected in random order.

MIX OFF

The Mix function is deactivated.

Press **MIX** as many times until the desired function briefly appears in the display.

⑩ **SC**

Radio ooperation

Scan

Press SC briefly – "FM SCAN" and the name of the scanned station will alternately appear in the display. The unit will scan all stations which can be received. To stop, press SC again.

Cassette operation

Cassette-Scan

Press SC. "CC-SCAN" will appear in the display. All CC tracks will be scanned briefly. To stop CC-Scan: Press SC once again.

Chanaer operation (optional)

CD-Scan

Press SC. "CDC-SCAN" will appear in the display. All CD tracks will be scanned briefly. To stop CD-Scan: Press SC once again.

⑪ **lo**

To switch the seek tuning sensitivity level:

Press button briefly.

To switch between mono and stereo reception:

Press button for approximately two seconds (beep).

The stereo symbol ∞ will disappear for mono playback.

⑫ **Preset Scan**

Press PS, 'SCAN' and the name of the scanned station will alternately appear in the display. The unit will scan all stations stored on the preset buttons.

To stop Preset Scan: Press PS once again.

⑬ **AF**

Alternative frequency during RDS operation:

When "AF" lights up in the display, the system will automatically look for a frequency offering better reception of the same RDS program.

AF on/off: Press **AF** briefly.

14 **PTY (Program Type)**

In the PTY mode, the preset buttons become program type buttons. With each preset you can select one program type, such as for example NEWS, SPORT, ROCK, CLASSICL, etc.

15 **SRC (source)**

You can switch between the different audio sources radio, tape, and CDC/AUX (if activated).

16 **DIS**

Radio operation

When an RDS station is received, press the **DIS** button and the frequency will be displayed for approximately four seconds.

Tape operation

When pressing the DIS button, the station name or frequency will be displayed for approximately four seconds.

Chanaer operation (optional)

To switch the display mode and select between name, time (playback time) and number (disc number):

- Press **DIS** briefly.

17 **RM (Radio Monitor)**

Press this button to listen to the radio while fast forwarding or rewinding the tape.

To switch RM on/off: Press RM.

When this function has been activated, "RM" shows on the display panel.

The radio is played back during fast tape run.

18 

Press to eject the tape.

19 **1, 2, 3, 4, 5, 6 - preset buttons**

On FM, you can store six stations for each of the memory banks I, II and T.

On AM, you can store six stations.

To store a station: Press a preset button during radio operation and hold down until the set resumes play after the muting and you hear a beep.

To recall a station: Select the desired waveband. On FM, also adjust the

corresponding memory bank. Then press the relevant preset button briefly.

Extra function for preset buttons

To store and recall a PTY program type.

On FM, you can store and recall one program-type on/from each preset button when PTY is active ("PTY" lights up in the display).

20 **Cassette loading slot**

Insert the tape with side A or 1 facing up, the open side showing to the right.

21 **Δ∇ Tape side selector**

Press this button to switch over to the other side during tape operation. The display shows "TR 1" or "TR 2".

22 **B**

Dolby B NR*

Press this button to play back a tape which has been recorded with Dolby-B noise reduction. When this button is pressed, "B" lights up in the display.

* Noise Reduction system manufactured under license from Dolby Laboratories Licensing Corporation, "Dolby" and the double-D symbol are trademarks of Dolby Laboratories Licensing Corporation.

23 **LD**

Loudness - When listening at a low level, the Loudness function creates a more natural sound by boosting the low frequency range.

LD on/off: Press the button.

When the Loudness function is active, "LD" will light up in the display.

See chapter "DSC programming" for more information.

24 **DSC (Direct Software Control)**

Use the DSC function to **customise** certain programmable, basic settings to suit your personal needs and preferences. See chapter "DSC programming" for more information.

25 **GEO**

To adjust the balance (left/right) and fader (front/rear) with the rocker switch.

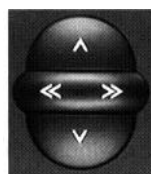

- ▲ Fader front
- ▼ Fader rear
- ◀◀ Balance left
- ◀◀ Balance right

The last setting will be stored automatically.

To switch off GEO: Press button once again.

If the setting remains unchanged within four seconds, the display will switch back to the previous condition.

26 **AUD**

To adjust the treble and bass frequencies with the rocker switch.

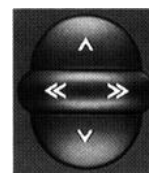

- ▲ Treble +
- ▼ Treble -
- ◀◀ Bass -
- ◀◀ Bass +

The last setting will be stored automatically.

To switch off AUD: Press button once again.

If the setting remains unchanged within four seconds, the AUD setting will be terminated automatically.

Important notes

Precautions

Before starting to use your new car radio, please read the following information carefully.

Traffic safety

As the driver of a motor vehicle, it is your responsibility to pay attention to the traffic situation at all times. Never use your car radio in a way that could distract you.

Please keep in mind that you travel a distance of 15 yards per second at a speed of only 30 miles per hour.

Should the traffic situation become particularly demanding, we advise you not to use the radio.

Always make sure that you are still able to hear any warning signals coming from outside of the vehicle, such as police or fire engine sirens, so that you can react accordingly.

Therefore, you should always select a moderate volume for playing your car radio while you are driving.

Installation

If you would like to install your new car stereo yourself or add other audio components to existing ones, then please read carefully the enclosed instructions on installation and connection.

In order to ensure that the set operates properly it is necessary that the positive power supply line is connected via the ignition and the permanent +12 V lead.

Do not ground the loudspeaker outputs!

Telephone mute

If you have a mobile telephone installed in your vehicle, radio, tape or changer playback can be muted automatically when using the phone (telephone mute).

“PHONE” will then appear in the display.

Accessories

Use only the accessories and spare parts approved by Blaupunkt.

You can use the following Blaupunkt products with this car stereo:

Changer

CDC A **05** or CDC A 071

Remote control

With the infrared steering wheel remote control and its signal-receiving apparatus you can control all of the important functions of your car audio system from the steering wheel.



Amplifier

All Blaupunkt amplifiers

Auxiliary Input 7 607 890 093

Adapter for portable audio equipment, for example.

Speakers

All Blaupunkt speakers

KeyCard theft protection system

The Blaupunkt KeyCard Security System provides an effective and convenient means of theft deterrence. Each unit operates only when **it's own card** is inserted. No card, no use. It's that simple.

The units flashing tongue and security system window stickers emphasize that point to the potential thief. No bulky release panel to put in your pocket – under your seat – where thieves know to look for it. Just remove the card and put in your wallet or pocket. It's that convenient.

This unit is supplied with two Keycards, a blue “main” card and “screamer” card. The difference: the **warranty/serial number** (the “radio pass data”) has been embedded into the main card in case you ever need it.

In addition to convenient security, each card has a personal memory bank for the FM1 and AMT band presets, bass, treble, balance, fader and DSC settings. The benefit: two drivers, such as a husband and wife, can store separate settings to their individual likings on their separate cards.

To replace a lost or stolen card, please call 1-800-920-21 21.

Putting the unit into operation

1. Turn the unit on.
2. Make the orange tongue stick out by pressing it into the radio so that it pops out.
3. Insert the **KeyCard** into the slot with the gold contact facing up and the arrow pointed into the unit.

The car radio is now ready for operation.

If a wrong **KeyCard** is inserted, then “CARD ERR” will appear in the display. In this case please do not make any further adjustments. The system will switch off after approximately ten seconds. When inserting another card type (e.g. phone or credit card), the display will show “WRONG KC” for approximately two seconds.

4. Remove the wrong card and introduce the correct **KeyCard** after the display indications “CARD ERR” or “WRONG KC” disappear.
5. Press ON to turn the set on.

Removing the KeyCard

Never pull out the KeyCard directly!

- First, slightly push in the **KeyCard**. This releases the card and puts it in the proper position for being removed.

Replacing a KeyCard

1. Insert the remaining **KeyCard** and turn on the set.
2. Press the **DSC** button and select “LEARN KC” with \wedge/\vee .
3. Press \ll or \gg .

The display will switch to “CHANGE”.

4. Push in the **KeyCard**. The card is released and put in the proper position for being removed.
5. Remove the first **KeyCard** and insert the new one while “CHANGE” is still being displayed.

After the display indication “READY” or “LEARN KC”,

6. press **DSC**.

Now you can also use the new **KeyCard** for operating your unit.

A maximum of two cards can be used for the set.

When trying to “train” a third one, the access authorisation for the **KeyCard** not used for the “training” process will be deleted automatically.

Loss of both KeyCards

Please contact your dealer or in USA call 1-800-920-21 21.

Displaying the radio pass data

Using the "Blau" KeyCard supplied with your set you can have the radio pass data such as the model name, product number (7 6 . . .) and serial number indicated on the display panel.

Please refer to chapter "DSC programming - READ KC".

Optical indication for extra security

Blinking KeyCard tongue

When the vehicle is stationary and the KeyCard removed, the KeyCard tongue can be switched to blink for extra anti-theft security.

For this it is necessary that the positive power supply line and the permanent +12 V lead are connected such as described in the installation instructions.

Be sure that "LED ON" is adjusted in the DSC mode.

If required, please refer to chapter "DSC programming - LED".

Turning off the blinking LED

When you insert your KeyCard, the LED is automatically turned off until the card is removed and the ignition turned off, assuming the unit is connected as described in the installation instructions.

If you do not want the tongue to blink at any time, simply access "LED" in the DSC menu, and press << or >> to turn in off.

Care of your KeyCard

For a proper function of the KeyCard it is important that the contacts are free from any foreign particles. Avoid direct skin contact. If necessary, clean the KeyCard contacts using a cotton swab soaked with alcohol.

Using the SRC button you can switch between the following audio sources:

- radio,
- tape,
- changer (optional), or AUX

Tape operation is only available if a cassette is inserted.

AUX is only available if no Blaupunkt changer CDC A05 or CDC A 071 is connected. "AUX ON" must be activated in the DSC menu.

To switch to another source,

- press SRC briefly.

Radio operation with RDS (Radio Data System)

13

This radio is equipped to receive Radio Data System or RDS signals. RDS is a secondary signal used by many FM radio stations to broadcast additional information. Blaupunkt has been a key player in developing RDS in Europe.

This radio's RDS features include program service name (PS), which automatically displays RDS station's identification such as WNYC-FM or THE WAVE. Other RDS features included are alternative frequency switching (AF), program type identification and search (PTY), and capability to receive future Emergency Alert System (EAS) message broadcasted by RDS stations. All are explained in this section.

AF - Alternative frequency

The AF (Alternative Frequency) function makes sure that the strongest frequency of the currently selected program is always tuned in automatically.

This function is activated when "AF" appears in the display.

In order to switch this function on or off,

- press the **AF** button briefly.

While searching for the strongest reception signal, the radio may switch to mute briefly. If "SEARCH" appears in the display when switching on the radio or recalling one of the

stored frequencies, the unit is automatically searching for an alternative frequency.

"SEARCH" will disappear from the display when the alternative frequency has been found or after the frequency band has been run through completely.

If the reception quality of the selected program becomes too bad:

- Tune into another station.

Selecting a waveband

With this car radio you can select between the following wavebands:

FM 87.5 - 107.9 MHz

AM 530 - 1710 kHz

- Select the desired waveband by pressing the **FMT** or **AMT** button.

Station tuning

Automatic (seek) tuning A/V

- Press A/V; the car radio will automatically search for the next station.

When keeping the upper or lower part ^/v of the rocker switch depressed, seek tuning will speed up in upwards or downwards direction.

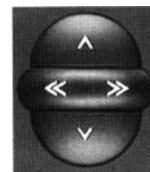

Seek tuning

^ Up

v Down

<< Down in short intervals

("AF" must be switched off)

>> Up in short intervals

("AF" must be switched off)

Manual tuning with <<>>

You can also tune in a station manually.

Condition:

AF and PTY must be switched off (i.e. the symbols do not light up in the display).

If necessary, deactivate these functions:

- Press **AF** or **PTY**.

Manual tuning:

- Press <<>>; the frequency will change in short intervals in downwards or upwards direction.

When holding the right or left part of the rocker switch down, the frequency movement is speeded up.

RDS Seek (only FM)

You can use the <<>> buttons to tune in RDS stations.

For this it is necessary that the stations have been tuned in at least once and that "AF" is active (lights up in the display).

A quick way to tune in RDS stations is to use Travelstore:

- Press FMT for two seconds; the system starts to run through the frequency band.

If "AF" is not displayed,

- press **AF**.

With this, the requirements for selecting stations with <<>> are fulfilled.

Changing the memory bank (FM)

You can shift between the memory banks I, II and T in order to store stations and recall them later.

The currently selected memory bank is indicated in the display.

- Press the FMT button as many times until the desired memory bank lights up in the display.

Scanning stored stations with Preset Scan

You can have all of the stored stations briefly scanned on all wavebands.

To start Preset Scan:

- Press SC for approximately two seconds.

All of the stored stations of the adjusted waveband will be scanned one after the other. The memory bank and preset position of the currently scanned station will flash in the display.

To select a scanned station and switch off Preset Scan:

- Press SC briefly.

Scanning stations with Radio-Scan

You can also scan all stations which can be received.

To start the Scan function:

- Press SC briefly.

The scanned frequency or the station name will start flashing in the display. During the actual scanning process "FM-SCAN" or "AM-SCAN" will be displayed.

To select a scanned station and switch off the Radio-Scan function:

- Press SC briefly.

Storing stations

On FM, you can store six stations on the preset buttons 1-6 for each of the memory banks I, II and T.

On AM, you can store six stations.

- Select the appropriate waveband with FMT or AMT.
- Tune in a station with the rocker switch (either automatically \wedge/\vee or manually <<>>).
- Press the desired preset button until the radio resumes play after the muting (takes approximately two seconds, confirmed by beep).

Now the station has been stored.

The activated preset button is indicated in the display.

Notice:

Should you tune in a station which has already been stored before on another memory bank, the corresponding preset button and the memory bank will briefly flash in the display.

Automatically storing the strongest stations with Travelstore

You can automatically store the six most powerful FM and AM stations of your current reception area sorted according to their signal strength. This function is particularly convenient on longer trips.

- Press the **FMT** or **AMT** button for two seconds.

"T-STORE" will appear in the display.

The six strongest FM or AM stations will be automatically stored on the memory bank "T" (Travelstore). When this process has been completed, the radio will play the first station.

If desired, stations can also be stored manually on the Travelstore bank (see "Storing stations").

Recalling stored stations

You can recall any stored station at the touch of a button.

- Select the waveband by pressing **FMT** or **AMT**. On FM, also choose the corresponding memory bank by pressing the **FMT** button as many times until the desired bank appears in the display.
- Press the corresponding preset button briefly to recall the station.

15

Switching from stereo to mono (FM)

If reception is poor, you may get better sound quality by switching to mono:

- Press the lo button for approximately two seconds.

With mono playback, the stereo Sign ∞ will disappear from the display.

Each time the radio is switched on, stereo playback is activated.

The unit will automatically switch to mono if the received signal is not strong enough for stereo playback.

PTY – Program Type

PTY is an RDS service offered by more and more radio broadcasters. This feature allows you to select FM stations according to their program type. After you have chosen the PTY of your preference, the corresponding stations can be selected either by seek tuning or using the scan function.

Switching PTY on/off

- Press **PTY**.

When the function is active, the program type selected last will briefly appear in the display. "PTY" will be permanently indicated in the lower right corner of the display panel.

Program types

Use <<>> to have the last selected program type displayed and to choose a new one. You can select any one of the stored types with the preset buttons 1 - 6.

Condition: PTY must be active.

All of the program types listed below are available.

The letters printed in bold are identical to the actual short-time indication in the display.

NEWS
INFORM
SPORTS
TALK
ROCK
CLS ROCK
ADLT HIT
SOFT RCK
TOP 40
COUNTRY
OLDIES
SOFT
NOSTALGA
JAZZ
CLASSICL
R & B
SOFT R&B
LANGUAGE

REL MUSC
REL TALK
PERSNLTY
PUBLIC
TEST (used for factory testing)
PTY 23 to **PTY** 29 have not been assigned.

Checking the program type of the station

- Press PTY for approximately two seconds.

After the beep tone the display will show the program type offered by the tuned in station.

Displaying the selected program type

- Press << or >>.

The program type selected last will be displayed briefly.

Selecting a program type

- Using the preset buttons
When PTY is switched on, you can use the preset buttons 1-6 to select the program types stored at the factory.
 - Press one of the presets 1 - 6.
The selected program type will be displayed for two seconds.

If you wish to listen to a station with this PTY,

- press \wedge/\vee to start seek tuning operation.

If the system is unable to find a station offering the selected program type, the display will show "NO PTY" and a beep tone will be released. The station received before starting seek tuning will be tuned in.

You can assign different program types to each preset position. Please refer to the next chapter "Storing program types".

- Using the <<>> buttons of the rocker switch

When PTY is switched on, you can select a program type using buttons <<>>.

- Press cc or >>; the program type selected last will be displayed for three seconds.
- During this period press >> (forwards) or << (backwards) to select the desired type.
- Press << or >> as many times as required.

If you wish to listen to a station offering the selected PTY,

- press \wedge/\vee to start seek tuning operation.

If the system is unable to find a station offering the selected program type, the display will show "NO PTY" and a beep tone will be released. The station received before starting seek tuning will be tuned in.

Storing program types

One program type was assigned to each of the preset buttons 1-6 at the factory.

If desired, you can also store other available program types.

To do so, make sure that "PTY" lights up in the display.

- If necessary, press the PTY button to switch on the function.
- Select a program type using buttons <<>> and
- hold down the desired preset button (1-6) until you hear a beep.

Now the selected program type can be recalled by pressing this preset. For this the PTY function must be active.

Scanning stations with PTY-SCAN

Condition: "PTY" must appear in the display.

- Press the SC button.

All received stations offering the selected program type will be scanned.

To switch off PTY-SCAN:

- Press SC once again.

Emergency Alert System

Your RDS tuner is also able to automatically receive any RDS emergency announcements broadcast during extraordinary circumstances.

Notice:

As earlier mentioned, these functions are currently only supported by a limited number of RDS stations.

Tape operation

The car stereo has to be switched on.

The unit automatically switches to tape operation when a cassette is inserted.

Inserting a tape

- Turn on the set.
- Insert a tape.

The tape will be automatically transported to the playback position. Side A or 1 starts to play.

During tape operation, "TR 1" or "TR 2" (track) will show on the display panel.

Insert the tape with side A or 1 facing up, the open side showing to the right.



Removing a tape

- Press **▲**.
The cassette will eject.

Fast Forward/Rewind

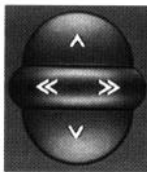

- >> Fast forward
- << Fast rewind

▲ / ▼ Track selection (S-CPS) ▲ Up
▼ Down

Stop function by pressing **▲▼**.

Selecting tracks with S-CPS (Super Cassette Program Search)

Use this function to skip (A) and repeat (V) recorded tracks.

A maximum of nine tracks can be skipped. To do so,

- press the rocker switch as many times as required.

The number of tracks to be skipped appears on the display panel.

If necessary, you can correct your entry by pressing the opposite rocker switch button. Stop by pressing **▲▼**.

For a proper operation of the S-CPS function there has to be an unrecorded tape

portion of at least three seconds between the individual tracks.

Switching the tape side (autoreverse)

To change the tape direction during cassette playback:

- Press **▲▼**.

At the end of a tape side, the mechanism changes directions automatically to play the other side (autoreverse). The display shows "TR1-PLAY" for track (side) 1 or "TR2-PLAY" for track 2.

Notice:

If there is too much tension on the tape during playback, the set may switch over by itself before having reached the end of the tape side. In this case check the condition of the cassette tape. Sometimes it helps to rewind it completely.

Tape equalisation

When a metal or CrO₂ tape is inserted, the tape mechanism automatically adjusts to metal/CrO₂ tape equalisation.

The "MTL" indicator will illuminate.

Scanning cassette tracks with SCAN

You can have the cassette tracks played briefly by using the scan function. If you like a title, stop the scan to continue listening to that track.

To start/stop the scan function:

- Press the SC button briefly.

You can individually adjust the scan time in the DSC menu (see "DSC programming - SCANTIME").

Dolby B NR*

With this unit you can play back tapes recorded with Dolby-B NR or without noise reduction.

Cassette tapes recorded with Dolby NR* stand out by their reduced tape hiss and the improved dynamics.

If Dolby-B NR is switched on, "B" will light up in the display.

To switch on/off:

- Press B (not during scan operation).

- Noise Reduction system manufactured under license from Dolby Laboratories Licensing Corporation. "Dolby" and the double-D symbol are trademarks of Dolby Laboratories Licensing Corporation.

Skipping unrecorded tape portions with Blank Skip

This function senses an unrecorded tape portion continuing for more than 15 seconds and automatically fast forwards the cassette to the beginning of the next track.

During fast tape winding, "B-SKIP" will be indicated on the display panel.

To switch the Blank Skip function on and off:

- Press the RM button for approximately one second until you hear a beep.

When the function has been activated, "BLS" will appear in the display.

Listening to the radio during fast tape winding with RM (Radio Monitor)

When the tape is fast forwarded or rewind (also with S-CPS), the radio will normally be muted. To listen to the radio during fast winding, activate the Radio Monitor function.

To switch RM on and off:

- Press RM.

When the function is active, "RM" will light up in the display.

Care notes

To avoid possible problems, we recommend you to use C-60/C-90 type cassette tapes only. Store your tapes in a cool place away from dirt, dust and temperatures exceeding 120 °Fahrenheit (50 °Celsius). Allow very cold tapes to warm up before playing them in order to avoid uneven tape transport. After approximately 100 hours of use, dust particles collected on the playback head or roller may lead to tape run problems and sound distortions.

Use a head cleaning tape to remove normal dirt build-up. For tougher cases, use a cotton swab (Q-Tip) soaked with alcohol. Do not attempt to clean by inserting a hard object into the player!

CD changer operation (optional)

This car stereo offers you convenient control of a Blaupunkt CD changer CDC-A05 or CDC-A071. These changers are sold separately and can be purchased through your Blaupunkt dealer.

Switching to CDC operation

Make sure that at least one CD has been inserted into the magazine.

Press SRC to go through the available audio sources:

- Press as many times until the display briefly shows "CDC ON".

"CD ERROR" – Disc is dirty, damaged, upside-down or CD-ROM

"NO CD" – No magazine in changer or no disc in selected slot.

Selecting CDs and tracks

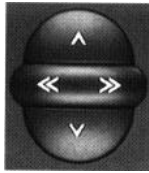

CD selection

>> up

<< Down

Track selection

▲ **Upwards:** Press briefly.
CUE - fast advance (audible): Keep depressed.

▼ **Downwards:** Press as many times as required.
To restart a track: Press briefly.
REVIEW -fast reverse (audible): Keep depressed.

MIX playback

You can have the CD tracks played in random order.

MIX CD – The tracks of the selected CD will be played at random. The next disc will be selected in numeric order.

MIX MAG – CDC-A 05 / -A071

All CD tracks will be played at random.

The next disc will then also be selected and played randomly, etc.

MIX OFF – The Mix function is deactivated. Discs and tracks will be selected in numeric order.

To alter the setting:

- Press **MIX** as many times until the desired function is briefly displayed.

If the function is active, "MIX" will appear in the right display corner.

Selecting the display mode

You can select the desired display mode for CD operation:

- "NAME" – The specified name, for example "MADONNA" will be displayed.
- "TIME" – The elapsed playback time of the track is displayed, for example "2 : 32".
- "NUMBER" – The CD position in the magazine (disc number) is displayed, for example "CD8 T5".

To switch the display mode:

- Press **DIS** during CD playback.

The display mode and the corresponding setting or value will briefly show on the display panel, e.g. "TIME", "2 : 32".

If you have selected "NAME" without having specified a name for the corresponding disc, "CD PLAY" will appear in the display. Please read also the chapter "Entering CD names".

Storing the display mode

You can store your preferred display mode which will then be active each time the radio is switched on.

If required,

- press **DIS** as many times until the desired setting is displayed.
- Hold down the **DIS** button until you hear a beep.

SCAN operation

Use this function to scan all of the CD tracks.

To start the **Scan** function:

- Press **SC**.

The tracks will be scanned one after the other in ascending order.

To stop the **Scan** function:

- Press **SC** briefly.

The track currently being scanned is continued to be played.

SCAN will also be terminated by

- pressing one of the buttons **AUD**, **GEO**, **DSC**, **SRC**, **▲**, **<<>>** or **▲▼**.

Entering CD names

You can name up to 99 discs.

The specified name (e.g. VIVALDI) will then appear in the display.

Be sure to select the display mode "NAME" using the **DIS** button.

To start the entry:

- Press the **DSC** button.
"CDC-NAME" will be displayed.

- Press **▲**.

The first underscore character will flash.

- Select the first character with the help of the rocker switch **▲▼**.

You have the choice between the capital letters A to Z, special characters and the numbers 0 to 9.

- Use the rocker switch **<<>>** to move to the next underscore and select a character.

You can select up to seven characters.

Once you have completed the name as desired:

- Press **▲** in order to store it.

To quit the naming mode,

- leave the DSC menu by pressing **DSC**.

If you would like to name another CD,

- select a new disc.

You can change any existing name by entering and storing a new one (overwriting).

Deleting CD names with DSC-UPDATE

You can delete a CD name with the help of the DSC update function. Use "CDC UPD" to confirm all of the CDs for which the specified name is not to be deleted.

- Insert a magazine with CDs for which the stored information is to be maintained.
- Press the **DSC** button.
- Press **▲▼** to select "CDC UPD".
- Press **<<>>**.

After the update has been completed, "NEXT MAG" appears in the display.

- Press the **▲** button on the changer for approximately two seconds.

The magazine will eject.

- Insert the next magazine.

DSC programming

Proceed as described above for all of the CDs/magazines for which the entered name is to be maintained.

- After having updated the last magazine, press **↵**.

To quit the function,

- press **DSC**.

The system has saved the name information for all of the CDs which were inserted. For all other discs the CD names have been deleted.

DSC (Direct Software Control) allows you to **customise** certain programmable, basic settings to suit your personal needs and preferences and then store them. The basic settings for this audio equipment were made at the factory. In the following you can find an overview of these settings, so that you can always reset to these if desired.

If you wish to alter any of the programming,

- press **DSC**.

Use the rocker switch and the **↵** button to select and adjust the functions described in the following. The display will show you the adjusted condition.

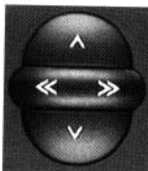

N V Select function
<< >> Adjust/recall value

CDC NAME Only available for CD changer playback (optional). Use this function to name your CDs. (See "Entering CD names").

LOUDNESS Loudness - When listening at a low level, the Loudness function creates a more natural sound by boosting the low frequency range.
LOUD 1 - Low boost
LOUD 6 - Max. boost

TA VOL Used in USA for Emergency Alert System volume level.

SPEECH In future many RDS radio stations will differentiate between music and speech programs.

You can alter the tone for speech programs from between "SPEECH 0 . . . 4".

SPEECH 0: Music and speech as per AUD bass and treble settings.

SPEECH 1: Linear reproduction (bass, treble and Loudness set to "0")

SPEECH 2-4: Different settings for volume, bass and treble with the Loudness being switched off. Try out which **SPEECH** setting you like most.

Selecting the night brightness: Switch on the vehicle lights and program the brightness value. The car radio's lighting connector must be hooked up to the vehicle's electric system for this to function properly.

READ KC To read out the **KeyCard** data. The card supplied with the radio is used to display the model name, type number (7 6..) and the serial number. If you remove the **KeyCard** during the reading process, "READ KC" will show on the display panel. The unit continues to play but does not accept any operations except from being switched off. Re-insert the card.

BEEP Acknowledgement tone for all functions which require a button to be pressed for more than one second. The volume can be adjusted from between 0 to 9. (0 = off).

COLOUR (Variocolour) For gradually matching the radio illumination with the dashboard lighting.
 green light orange red

ANGLE Use this setting to alter the viewing angle to your liking from -1 to 0 to +1.

LED ON Here you can choose between **LED ON** or **LED OFF**. With **LED ON**, the **KeyCard** tongue will flash for extra anti-theft protection when the unit has been switched off and the **KeyCard** removed.

SCANTIME Use this function to set the scan time for the radio or CD player from between five and 30 seconds.

BRIGHT You can adjust the display brightness from between 1 to 16. You can also select different values for day and night.

LEARN KC To "train" a replacement **KeyCard**. Please read the information in chapter "KeyCard theft protection system - "Replacing" a KeyCard".

S-DX To adjust the seek tuning sensitivity for distant reception.
DX 1 - high sensitivity
DX 3 - low sensitivity

S-LO To adjust the seek tuning sensitivity for local reception.
 LO 1 - high sensitivity
 LO 3 - low sensitivity
 The seek tuning sensitivity values can be separately set for AM and FM.

CDC UPD Use this function to delete CD names during CDC operation, in order to have more storage capacity for new discs available. See "Deleting CD names with DSC-UPDATE".

AUX This menu item is not available if you have connected a CD changer (A 05 or A071).
 The setting made at the factory is AUX OFF.
 If you have connected an external piece of equipment via AUX, this function must be set to AUX ON.

VOL FIX Use this function to select the volume at which the radio is set when it is switched on. Adjust the desired volume level with <<>>. When adjusted to "VOL 0", the system will come on with the volume selected before switching the radio off.

To quit the DSC programming mode and store the adjustment:
 • Press **DSC**.

Overview of the DSC factory settings

CD NAME	
LOUDNESS	3
TA VOL	35
SPEECH	0
BEEP	4
ANGLE	0
BRIGHT	16
COLOUR	green
LED	ON
LEARN KC	
READ KC	
SCANTIME	10 sec.
S-DX	1
S-LO	1
CD UPD	
AUX	OFF
VOL FIX	0

Appendix

Specifications

Amplifier

Output power: 4 x 23 W RMS power
 acc. to DIN 45324 at
 14.4 V
 4 x 35 W max. power

Tuner

Wavebands:
 FM : 87.5 – 107.9 MHz
 AM : 530 – 1710 kHz

FM sensitivity: 0.9 µV at 26 dB signal-to-noise ratio

FM frequency response:
 30 - 16 000 Hz

Tape player

Frequency response:
 30 - 18 000 Hz

Questions? Problems?

Call 1-800-266-2528

Subject to modifications!

25

Sydney RCM 126 us Toronto RDM 126 us



Fitting instructions Instructions de montage Instrucciones de montaje Instruções de montagem

● **BLAUPUNKT**

Bosch Group

8622401 236

Ⓞ **Safety notes**

Before starting to mount your car radio, read the mounting and connection instructions carefully. Disconnect the vehicle battery's negative terminal before making connections
Be sure to observe the safety notes of the automobile manufacturer (airbags, alarm systems, on-board computers, immobilisers)
Before drilling holes, look to see what is on the other side - do not damage the battery, wiring or fuse box. The positive lead used must have a cross-section of at least 2.5 mm². The set is protected by a quick-acting 10 A fuse.
During operation of the unit, the set's side wall may heat up considerably
Be sure to keep all wires away from hot parts of the housing

Ⓞ **Indications de sécurité**

Veillez lire les instructions de montage et de raccordement avant de monter votre autoradio.
Débrancher le pôle négatif de la batterie pendant les opérations de montage et de branchement.
Prendre note des indications de sécurité du fabricant du véhicule (airbag, alarmes, ordinateur de bord, dispositifs de blocage des roues).
En perçant des trous, veiller à ce que les éléments du véhicule (batterie, câble, boîte à fusibles) ne soient pas endommagés.
La section du câble positif ne doit pas être inférieure à 2,5 mm².
L'appareil est protégé par un coupe-circuit à action instantanée de 10 A.
La partie latérale de l'autoradio s'échauffe énormément pendant le service de l'appareil.
Veiller à ce qu'aucun câble ne se trouve sur le boîtier.

Ⓞ **Observaciones de seguridad**

Antes de instalar su nuevo equipo, sírvase de leer detenidamente las instrucciones de montaje y de conexión
Desconecte el terminal negativo de la batería del vehículo antes de hacer las conexiones
Observe las informaciones de seguridad del fabricante del vehículo (con respecto a airbags, sistema de alarma, ordenador de a bordo, inmovilizador).
Antes de taladrar agujeros, asegúrese de no dañar ninguna parte del vehículo (batería, cableado, caja de fusibles)
La sección transversal del cable positivo utilizado debe ser de 2,5 mm² por lo menos. El equipo está protegido mediante un fusible de 10 A de acción rápida
Durante la operación del equipo, la parte lateral de la radio puede calentarse considerablemente.
Cerciórese de que ninguno de los cables este en contacto directo con la caja del autorradio

Ⓞ **Instruções de segurança**

Antes da montagem do seu auto-rádio, ler as instruções de montagem e de ligação
Durante o tempo da montagem e da ligação, desapertar o terminal do borne negativo da bateria
Seguir as instruções de segurança do construtor do veículo (airbag, sistemas anti-roubo, computadores de bordo, sistemas imobilizadores)
Na furagem de buracos, dar atenção a não danificar quaisquer peças do veículo (bateria, cabos, caixa de fusíveis)
O diâmetro do cabo positivo não deve ser inferior a 2,5 mm². O aparelho está protegido através de um fusível 10 A de acção rápida
A parte lateral do auto-rádio atinge durante o funcionamento temperaturas altas
Dar atenção a que os cabos não fiquem próximos da caixa

Electrical Connections and Installation



To avoid the aggravation of costly mistakes and serious damage that could make you feel this way, please carefully read all of the instructions before you begin. Carefully follow all instructions. You'll be glad you did!

GENERAL RECOMMENDATIONS AND NOTES

- If you're not confident that you can install the unit correctly, have it installed by a qualified Blaupunkt installation technician.
- Use this unit only with negative ground 12 Volt (11-16 Volt) direct current (DC).
- We recommend making and testing all electrical connections before installing the unit. Connect the leads (wires) according to instructions and diagram below.
- This unit is protected by a quick-acting 10A fuse. Do not substitute with any other type of fuse.

IF YOU ARE INSTALLING A COMPATIBLE BLAUPUNKT CD CHANGER

- Blaupunkt CDC-A05 and CDC-A071 changers sold separately.
- For speaker connection, use the speaker wire harness section that comes with the receiver.
- For other connections, use the wire harness sections that come with the CD Changer, not the receiver.
- In place of this unit's yellow and green lead, use the changer's blue lead for the antenna motor.
- The changer harness also includes 4-channel RCA preamp output connections, amplifier switch-on lead and a telephone mute lead.

ELECTRICAL CONNECTION INSTRUCTIONS

1. Disconnect the vehicle battery's negative terminal before making connections.
2. Connect the speakers and/or external amplifiers (if you have any) following the guidelines in the SPEAKER CONNECTION section below.
3. Connect the yellow and green "POWER ANTENNA+" (trigger output) lead to an antenna motor trigger input terminal (if you have one). (Maximum amperage required must not exceed 150mA.)

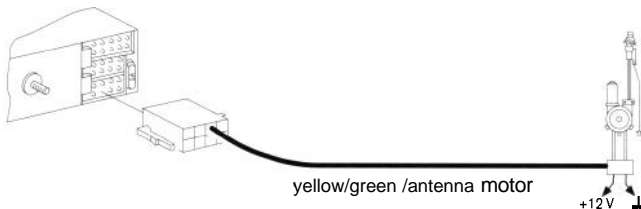

4. Connect the orange "ILLUMINATION" lead to the vehicle's adjustable illumination (dimmer).

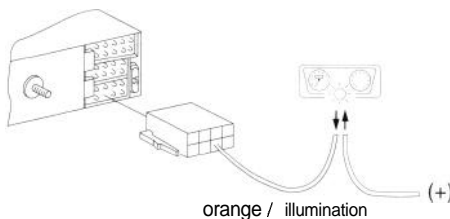

5. Connect the brown "GROUND+" lead to a grounded metal part on the vehicle. We recommend grounding all audio system ground leads (receiver, external amplifier, etc.) to a common grounding point, preferably a non-painted surface under the instrument panel.

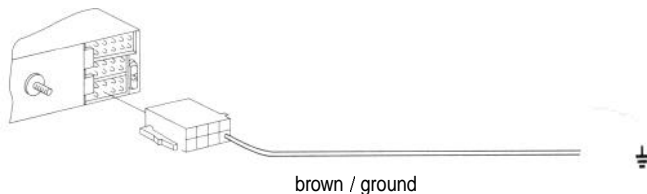

6. Connect the red lead designated "BATTERY (+12V)" to a source of constant battery power.

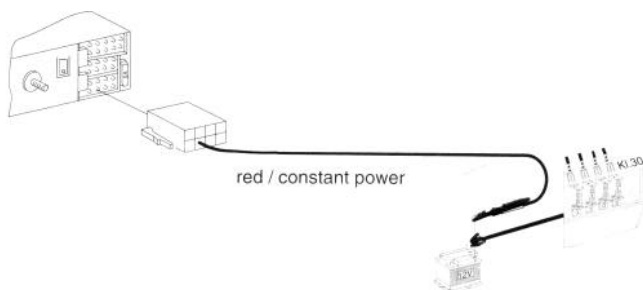

7. Connect the red lead designated as "ACC (+12V) "IGNITION" (turn-on power) only after the other leads are connected. Be sure to connect the red lead to a positive (+) 12 Volt power terminal that is energized only when the ignition key is set to the on position or accessory position.

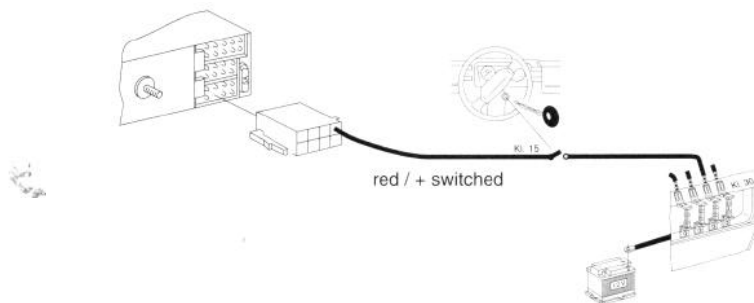

8. Cover the ends of any unused leads with electrical tape. This will prevent them from touching the vehicle or each other and causing a short-circuit and damage to the unit or vehicle.
9. Reconnect the vehicle's battery.
10. Verify that no fuses have blown.
11. Plug the harness into the unit.
12. Attach the antenna "elbow" and affixing bracket to the back of the unit. Insert your vehicle's antenna.

Test the unit. Once the connections have been successfully made, you can begin to install the unit
Download from [Www.Somanuals.com](http://www.Somanuals.com). All Manuals Search And Download.

SPEAKER CONNECTION INSTRUCTIONS

The unit's Dual-Level Fader allows you to fade between the front and the rear channels using either the front and/or rear speaker leads and/or the rear preamp outputs, providing you tremendous flexibility in configuring your speaker arrangement:

- You can connect a speaker (regular, co-axial or tri-axial speakers or component speaker system, all hereafter referred to simply as "speaker") to each of the units' four pairs of speaker leads.
- With the purchase of Blaupunkt accessory wire harness 8 643 494 218, you can connect the 4 RCA preamp outputs to multiple external amplifiers and power multiple speakers or speaker systems through the amplifiers. (See below)
- You can use a either or both of these two methods.
- Blaupunkt amplifiers and speakers sold separately.

Connecting the Speaker Leads

To prevent short circuits or serious damage to the unit and/or speakers:

- Connect the speaker leads only as indicated in the wiring diagram. Disconnect the vehicle battery's negative terminal before making connections.
- Only use speakers that have impedance ratings of 4 ohms or higher and have power-handling capabilities greater than the receiver's stated power level.
- The unit's internal amplifier is designed to handle a 4-ohm load on each pair of speaker leads.
- DON'T connect two speakers to a single pair of speaker leads ("in parallel") unless both speakers each have at least 8 ohms impedance.
- DON'T connect the left and right speaker leads to each other or to the same speakers.
- DON'T connect the front and rear speaker leads to each other or to the same speakers.
- DON'T connect the negative speaker leads to each other.
- DON'T connect the positive speaker leads to each other.
- DON'T connect any active speakers (with built-in amplifiers) to the speaker leads unless their owner's manuals specifically state that this is O.K.
- Cover the ends of any unused leads with electrical tape. This will prevent them from touching the vehicle or each other and causing a short-circuit and damage to the receiver or vehicle.

PREAMP OUTPUT CONNECTION

Blaupunkt wire harness 8 634 494 218 fits in the top block on the rear of the unit. It includes 4-channel preamp out connections, amplifier switch-on lead (blue/white), and cellular telephone mute (dark green): If you purchase a Blaupunkt CDC-A05 or CDC-A071 CD Changer, you don't need this harness because all of these connections are included in changer's wire harness.

AUXILIARY INPUT

If a changer is not connected, you can connect portable audio equipment to your unit by purchasing Blaupunkt accessory harness 7 607 890 093. This harness fits in the top block on the rear of the unit. It includes a 2 meter aux-in cable with a 3.5 mm male plug for direct insert into your portable equipment, as well as 4-channel preamp out connections, amplifier switch-on lead (blue), and cellular telephone mute (purple).

WIRELESS REMOTE CONTROLS

This receiver's most-frequently used features can be controlled by Blaupunkt's unique Thummer II Steering-Wheel Remote Control. Included with remote control are a receiving "eye" that can be placed virtually anywhere on the dash, as well as a wiring harness, which can be used simultaneously with the harnesses for the preamp output and for the changer or aux input.

INSTALLATION INSTRUCTIONS

- A. This car radio is designed to be installed in the car radio compartment provided by the vehicle manufacturer. Open the car radio compartment (remove the shelf or panel by unclipping it) or adjust the size of the car radio compartment to measure 182 x 53 mm.
- B. The mounting bracket included with this car radio is designed for installation in vehicles with a standard DIN installation compartment measuring 182 x 53 mm, a 165mm installation depth and an instrument panel thickness of approximately 1 to 20 mm in the area of the tab fasteners, see Fig. 1. Reach behind the car radio compartment and check to see which tab fasteners can be bent on the mounting bracket. Place the mounting bracket in the compartment and bend over the tabs with the help of a screwdriver, see Fig. 1, 2. Be sure to bend all of the tabs possible.
- C. Your vehicle may also allow you to provide extra ability at the back of the unit. Look at the wall behind the radio cavity to see if there is a small hole the size of the enclosed plastic plugs. If so, screw one or both of the plugs onto the threaded bolt at the back of the unit before pushing the unit into the mounting sleeve.
- D. Place the car radio in the front of the mounting bracket and push it in until the side springs snap into position on the left and the right (you will hear an audible click).

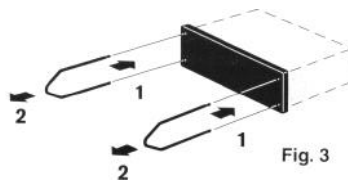
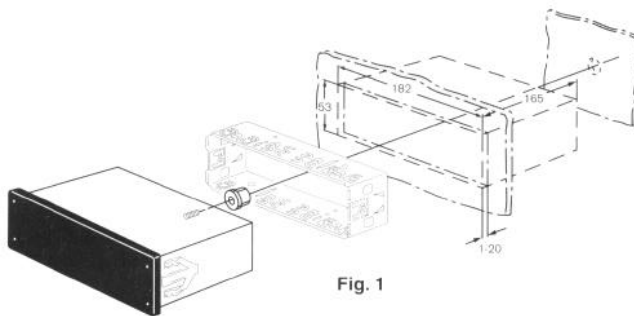

Removing the car radio

Insert the handles into the holes in the panel on the left and right of the radio and push them in until you hear a distinct click (unlocks side springs).

Pull the unit out using both handles, see Fig. 3.

Note: Handles which have snapped into place can only be removed after you have pulled the radio out of the compartment.

If you have any questions, please consult your Blaupunkt dealer or in the United States call 1-800-266-2528.

Free Manuals Download Website

<http://myh66.com>

<http://usermanuals.us>

<http://www.somanuals.com>

<http://www.4manuals.cc>

<http://www.manual-lib.com>

<http://www.404manual.com>

<http://www.luxmanual.com>

<http://aubethermostatmanual.com>

Golf course search by state

<http://golfingnear.com>

Email search by domain

<http://emailbydomain.com>

Auto manuals search

<http://auto.somanuals.com>

TV manuals search

<http://tv.somanuals.com>