

**BOSE**<sup>®</sup>

# CINEMATE<sup>®</sup> SERIES II

## CINEMATE<sup>®</sup> GS SERIES II

### DIGITAL HOME THEATER SPEAKER SYSTEM

Owner's Guide  
Guía de usuario  
Notice d'utilisation  
Guia dos proprietários





# SAFETY INFORMATION

## Please read this guide



Please take the time to follow the instructions in this guide carefully. It will help you set up and operate your system properly and enjoy all of its advanced features. Please save this guide for future reference.

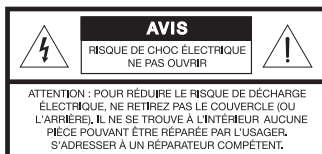
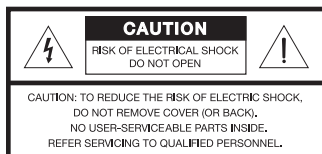

The interface module is to be used only with the Acoustimass® module in the CineMate® system.

-  **WARNING:** To reduce the risk of fire or electrical shock, do not expose the product to rain or moisture.
-  **WARNING:** Do not expose this apparatus to dripping or splashing, and do not place objects filled with liquids, such as vases, on or near the apparatus. As with any electronic products, use care not to spill liquids into any part of the system. Liquids can cause a failure and/or a fire hazard.



### WARNING:

-  The lightning flash with arrowhead symbol within an equilateral triangle alerts the user to the presence of uninsulated, dangerous voltage within the system enclosure that may be of sufficient magnitude to constitute a risk of electrical shock.
-  The exclamation point within an equilateral triangle, as marked on the system, is intended to alert the user to the presence of important operating and maintenance instructions in this owner's guide.

-  **CAUTION:** Make no modifications to the system or accessories. Unauthorized alterations may compromise safety, regulatory compliance, and system performance.
-  **WARNING:** Keep the remote control battery away from children. It may cause a fire or chemical burn if mishandled. Do not recharge, disassemble, heat above 100°C (212°F), or incinerate. Dispose of used batteries promptly. Replace only with a battery of the correct type and model number.
-  **WARNING:** Danger of explosion if battery is incorrectly replaced. CineMate series II remote—Replace only with Duracell, Eveready, Energizer, Maxell, Toshiba, or Shun Wo CR2032 or DL2032 3-volt lithium battery.



**Please dispose of used batteries properly**, following any local regulations. Do not incinerate.



**WARNING:** Do not place any naked flame sources, such as lighted candles, on or near the apparatus.



This product conforms to the EMC Directive 2004/108/EC and to the Low Voltage Directive 2006/95/EC. The complete Declaration of Conformity can be found at [www.Bose.com/static/compliance/index.html](http://www.Bose.com/static/compliance/index.html).

**Note:** Where the mains plug is used as the disconnect device, such disconnect device shall remain readily operable.

**Note:** This product must be used indoors. It is neither designed or tested for use outdoors, in recreation vehicles, or on boats.

## Additional Safety Information

See the additional instructions on the *Important Safety Instructions* sheet (North America only) enclosed in the shipping carton.

## For your records

The serial number is located on the rear of the Acoustimass module.

Serial number: \_\_\_\_\_

Dealer name: \_\_\_\_\_

Dealer phone: \_\_\_\_\_

Purchase date: \_\_\_\_\_

We suggest you keep your sales receipt and product registration card together with this owner's guide.

©2009 Bose Corporation. No part of this work may be reproduced, modified, distributed, or otherwise used without prior written permission.

|  |           |  |           |
|--|-----------|--|-----------|
| <b>INTRODUCTION</b>  | <b>2</b>  | CineMate® GS series II remote control . . . . .                    | 17        |
| Before you begin . . . . .   | 2         | Using the remote to control the<br>CineMate® system . . . . .      | 18        |
| Unpacking . . . . .  | 3         | Setting the remote for your TV and<br>other devices . . . . .      | 18        |
| <b>SYSTEM SETUP</b>  | <b>4</b>  | To control a combination device . . . . .                          | 19        |
| <b>1</b> Placing the system components . . . . .                         | 4         | Using the remote to watch TV . . . . .                             | 19        |
| <b>2</b> Connecting the speakers to the<br>Acoustimass® module . . . . . | 7         | Using the remote to watch a DVD . . . . .                          | 20        |
| <b>3</b> Connecting the interface module . . . . .                       | 9         | Selecting the TV input . . . . .                                   | 20        |
| <b>4</b> Connecting the TV audio to the interface module                 | 10        | Switching control from one device<br>to another . . . . .          | 20        |
| Connecting optical audio . . . . .                                       | 10        | Using the CineMate® GS series II<br>remote control . . . . .       | 21        |
| Connecting analog audio . . . . .  | 11        |  |           |
| Turning off the TV internal speakers . . . . .                           | 11        |  |           |
| <b>5</b> Connecting to a power outlet . . . . .                          | 12        |  |           |
| <b>6</b> Inserting the CineMate® GS remote batteries . .                 | 14        |  |           |
| <b>CONTROLS AND INDICATORS</b>   | <b>15</b> | <b>CARE AND MAINTENANCE</b>  | <b>25</b> |
| Acoustimass® module bass control . . . . .                               | 15        | Replacing the CineMate® series II<br>remote battery . . . . .      | 25        |
| CineMate® series II remote control . . . . .                             | 16        | Replacing the CineMate® GS series II<br>remote batteries . . . . . | 26        |
| Using the remote to control the<br>CineMate system . . . . .             | 16        | Cleaning your speaker system . . . . .                             | 26        |
|  |           | Troubleshooting . . . . .  | 27        |
|  |           | Customer service . . . . .   | 28        |
|  |           | <b>REFERENCE</b>   | <b>29</b> |

# INTRODUCTION

---

## Before you begin

---

Thank you for purchasing the Bose® CineMate® system, which delivers the superb acoustic performance needed to enjoy the full audio impact of DVDs and other exciting home entertainment.

The CineMate system comes in two configurations:

- CineMate series II – includes the standard CineMate speakers and a simple remote control.
- CineMate GS series II – includes the smaller Gemstone® speakers and a universal remote control.

Both configurations include an attractive floor-standing Acoustimass® module for deep bass sound and an interface module that provides simple audio connections to your TV.

Using our TrueSpace® signal processing technology, the CineMate system speakers provide improved spaciousness for bold 3-D effects and movie-like realism from surround encoded DVDs and other entertainment sources. In fact, they provide much of the performance of premium five-speaker systems from a modest array of equipment.

---

### Setup help

*The CineMate system easily connects to your TV and other home theater equipment. To help you set up your CineMate system, the following items are provided:*

- *Quick Setup Guide*
  - *Setup DVD*
  - *Detailed instructions in the Setup section of this owner's guide*
-

## Unpacking

Carefully unpack your CineMate® system. Save all packing materials, which provide the safest way to transport your system. If any part of the system appears damaged, do not try to use it. Notify Bose or your authorized Bose dealer immediately. For Bose® contact information, refer to the address sheet included in the carton.

**WARNING:** To avoid danger of suffocation, keep the plastic bags out of the reach of children.

As you identify them, you may want to place a check mark in the box next to the name of each part.

**Note:** Now is a good time to find the serial number on the rear of the Acoustimass® module. Copy that number in the space provided on page ii for easy reference when registering your system.

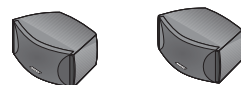

- Cinemate series II speakers

OR

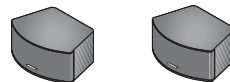

- CineMate GS series II Gemstone® speakers



- Acoustimass module



- Small rubber feet



- Large rubber feet



- CineMate series II remote

OR



- CineMate GS series II remote

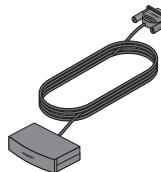

- Interface module



- Speaker cable



- Power cord



- Stereo cable



- Optical cable

## SYSTEM SETUP

# 1 Placing the system components

What you need to use:

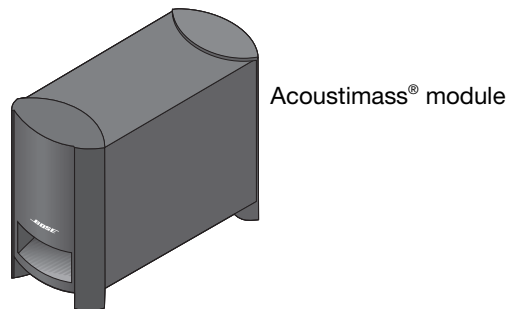
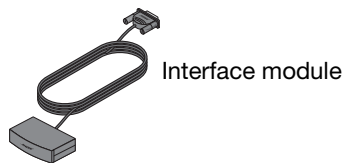
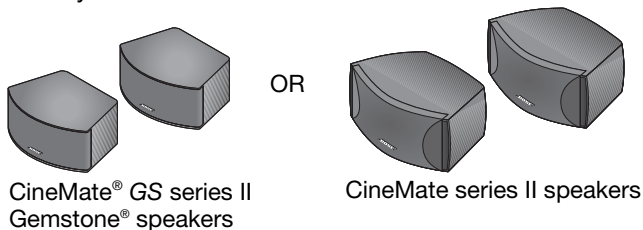

The image below shows one of the many ways you can position your system.

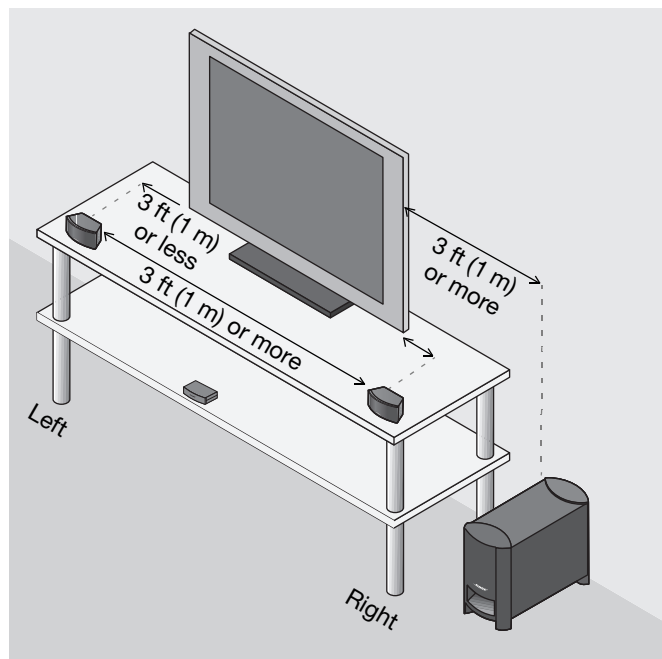

See Steps 1-5 for details.

1. On the bottom of each speaker, attach one set of small rubber feet.

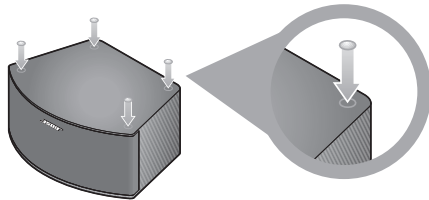

2. Place the left and right speakers:
  - at least 3 feet (1 meter) apart
  - within 3 feet (1 meter) of the TV screen
  - near the front edge of any shelf
  - aimed straight ahead (not angled) to face the listening area.
3. On the legs of the Acoustimass® module, attach the large rubber feet.

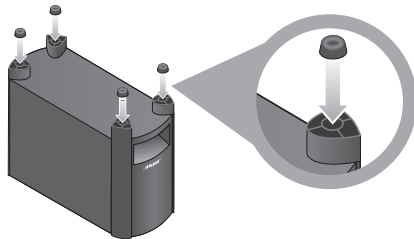

4. Place the Acoustimass module:
  - at the same end of the room as the speakers and your TV
  - at least 3 feet (1 meter) from the TV to prevent interference with the screen
  - at least 2.5 feet (.8 meters) from audio or video tapes to prevent magnetic damage to them
  - within reach of the cable from the interface module and an AC (mains) power outlet
  - with the front port aimed out from or along a wall for balanced performance
  - hidden under a table, behind a sofa or chair, or behind drapes as preferred
  - NOT in an enclosure, on a bed, on a sofa, or on a surface that can block the ventilation openings.

---

**CAUTION:** Do not block ventilation openings on the bottom and rear of the module.

---



---

**Note:** Keep in mind that the Acoustimass module is the only part of this system that connects to a power outlet.

---

## SYSTEM SETUP

---

The interface module receives commands from the remote control and provides audio input connections for the CineMate® system. The remote control commands allow you to turn the speakers on, change the volume, and mute or turn off the speaker system.

### 5. Place the interface module:

- on a flat surface near the TV and other home theater equipment
- within 15 feet (4.6 meters) of the Acoustimass® module
- NOT in direct sunlight

If you position the interface module on a shelf, make sure the front edge of the module is flush with the front edge of the shelf. If on a high shelf, make sure the front edge of the module extends slightly past the front of the shelf, so the shelf does not block signals from the remote control.

Peel the protective film off the lens on the front of the interface module.

---

**Note:** *The remote should have a clear line of sight to the interface module, the TV, and any other equipment it will control.*

---

---

**CAUTION:** *When positioning the interface module, avoid blocking any ventilation openings on the TV or other electronic equipment.*

---

Continue with **2** on the next page.



# 2

## Connecting the speakers to the Acoustimass® module

What you need to use:



CineMate® GS series II  
Gemstone® speakers

OR

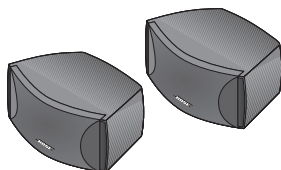

CineMate series II speakers



Acoustimass module

1. Notice the two plugs at one end of the speaker cable.

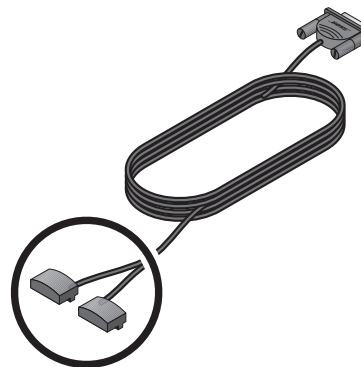

2. Separate the two plugs so each one reaches a speaker.

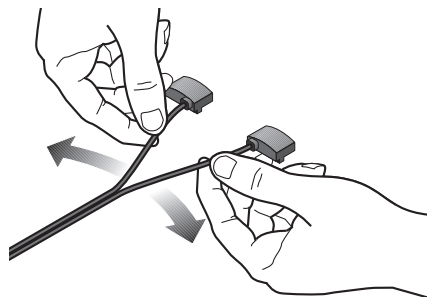

## SYSTEM SETUP

3. Insert each plug into the connector on the proper speaker.

The plug marked RIGHT goes into the speaker placed to the right of your TV (facing toward the TV).

(Refer to **1** for placement guidelines.)

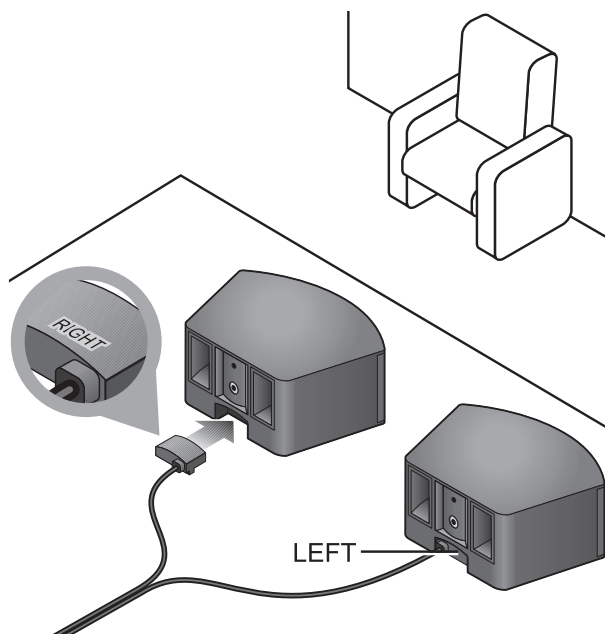

4. Insert the single plug at the other end of the speaker cable into the connector labeled SPEAKERS on the back of the Acoustimass® module.

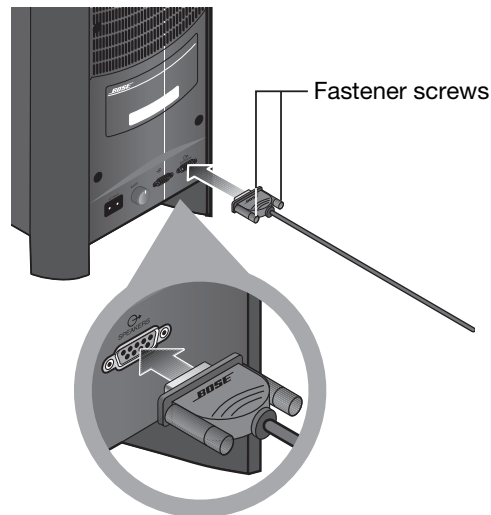

5. Tighten each fastener screw by hand to secure the plug.

**CAUTION:** Do not plug the Acoustimass module into an AC power (mains) outlet until all other components are connected.

6. Continue with **3** on the next page.

# 3 Connecting the interface module

What you need to use:

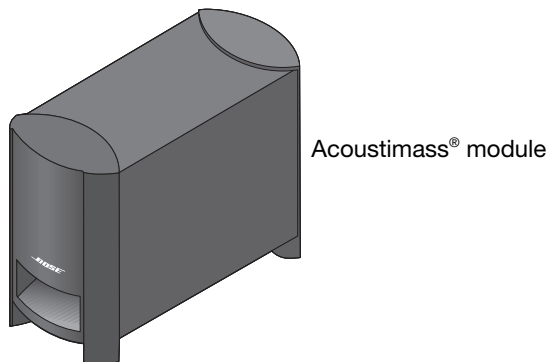
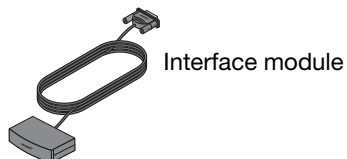

1. Insert the plug from the interface module into the input connector on the back of the Acoustimass module.

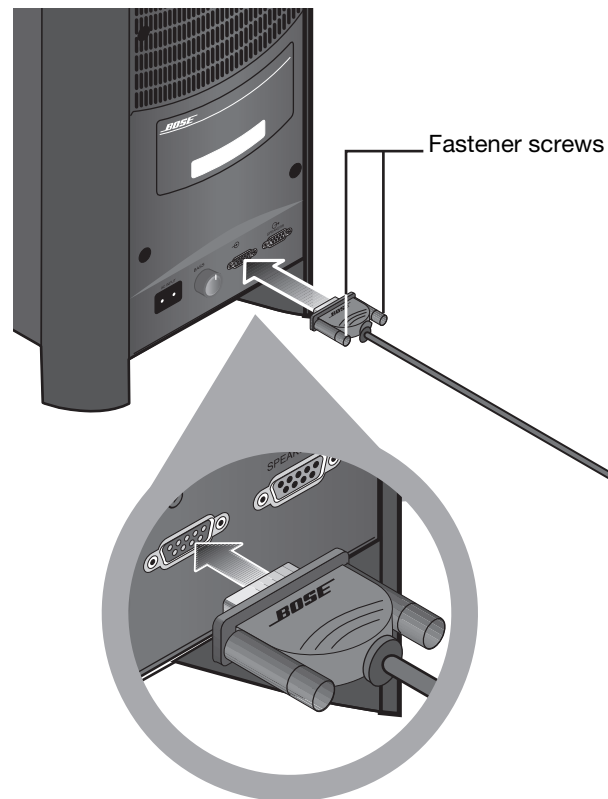

2. Continue with **4** on the next page.

## SYSTEM SETUP

# 4 Connecting the TV audio to the interface module

What you need to use:

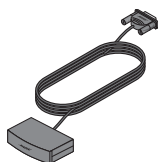

Interface module



Optical audio cable

OR



Stereo audio cable

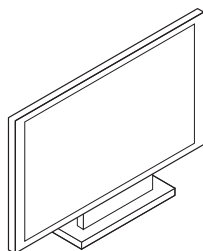

TV

If your TV has audio output connectors, you can connect them to the CineMate® system. Your TV may have an optical connector, analog RCA connectors, or both. If your TV has both types of output connectors, you should use the optical connector. Using the optical connection gives you the highest-quality digital sound.

**Note:** To receive the highest-quality digital sound from the sources connected to your TV, connect those devices to your TV using an HDMI cable.

## Connecting optical audio

Connect the supplied optical audio cable from the optical audio out connector on your TV to the interface module OPTICAL IN connector. (The optical out connector on your TV may also be marked “Digital Audio.”)

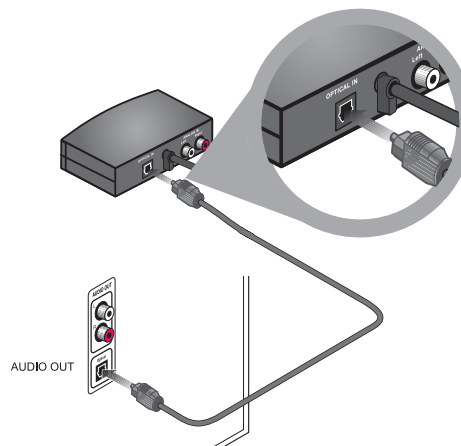

**Note:** The interface module has both optical and analog connectors to accommodate a variety of TVs. When your TV is connected to the optical input on the interface module, the analog input cannot be used as a second audio input.

## Connecting analog audio

If your TV is not equipped with an optical connector, use the supplied stereo audio cable to connect from your TV audio out connectors to the interface module ANALOG IN connectors.

The stereo audio cable has two RCA connectors at each end, one red and one white. It connects to left (L) and right (R) audio outputs on the rear panel of your TV and the interface module.

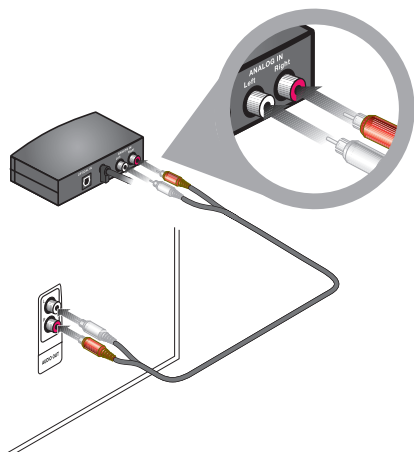

If your TV provides both fixed (FIX) and variable (VAR) audio output connectors, use the fixed connectors for higher sound quality. Be sure to select Fixed in the setup menu of your TV.

To enjoy the full benefit of hearing TV audio through the CineMate® system, the internal speakers in your TV should be turned off. Your TV may have an onscreen audio menu that includes an option for turning the TV speakers on or off.

## Turning off the TV internal speakers

Newer TVs normally have a setup menu item for turning off speakers. Older TVs may have a speaker on/off switch on the rear panel near the audio output connectors.

### Using a TV setup menu

1. Use your TV remote to display the audio menu on your TV screen.
2. Locate the menu item to turn your speakers on or off and select **Off**.

If your TV does not have a menu setting for turning off the internal speakers, exit the audio menu and reduce the TV volume to its lowest setting.

### Using a speaker on/off switch

If the rear panel of your TV has a **SPEAKER ON/OFF** switch, set it to the **OFF** position and adjust the TV volume to about 80% of the highest volume.

## SYSTEM SETUP

# 5 Connecting to a power outlet

What you need to use:

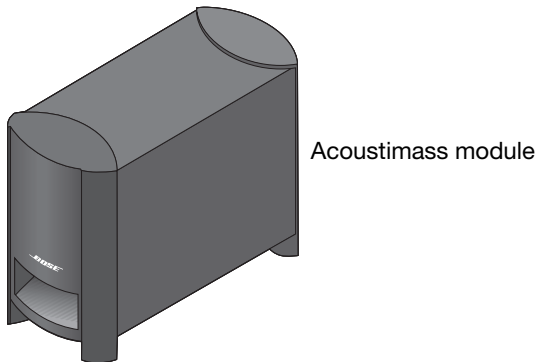

1. Insert the large plug on the power cable into the power connector marked  $\sim$  on the Acoustimass module.

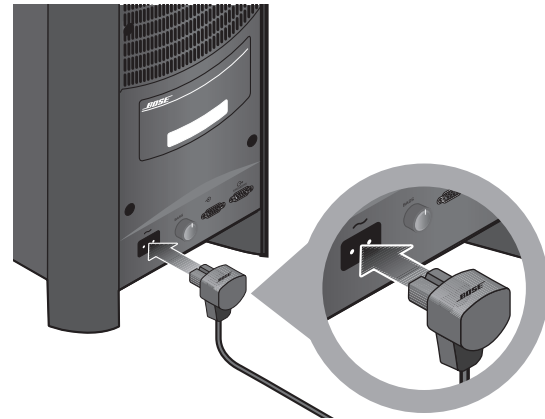

2. Plug the other cable end into the AC (mains) power.

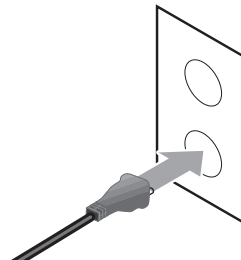

When you connect the CineMate® system to a power source, the green LED on the front of the interface module flashes for 10 seconds, then extinguishes, indicating that the system has been connected to power.

When you press the remote control On-Off, Volume Up/Down, or Mute button, the green LED on the interface module flashes.

---

**CAUTION:** *Bose recommends using a safety agency-approved surge protector on all electronic equipment. Voltage variations and spikes can damage electronic components in any system.*

---

Continue with **6** on the next page.

## SYSTEM SETUP

# 6

## Inserting the CineMate® GS remote batteries

The CineMate® GS series II remote control requires two AA batteries (supplied). The batteries go into the compartment on the back of the remote. To insert the batteries:

1. Slide the battery compartment cover off.

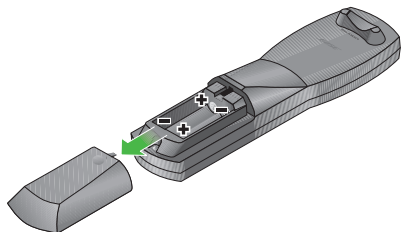

Symbols inside the compartment show how to match the – and + symbols on the batteries.

2. Insert the two batteries, making sure to match the – and + symbols.

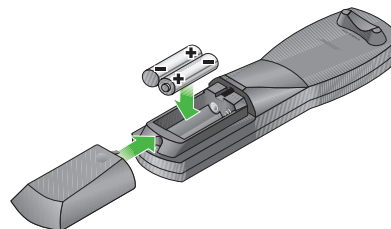

3. Slide the cover back on until it clicks into place.



## Acoustimass® module bass control

---

The bass control knob located on the rear of the Acoustimass module allows you to change the bass level of the system. The bass control knob is set at the factory to the middle position. To change the preset bass level:

1. Turn the bass control knob to the left to decrease the bass output of the Acoustimass module.
2. Turn the bass control knob to the right to increase the bass output.

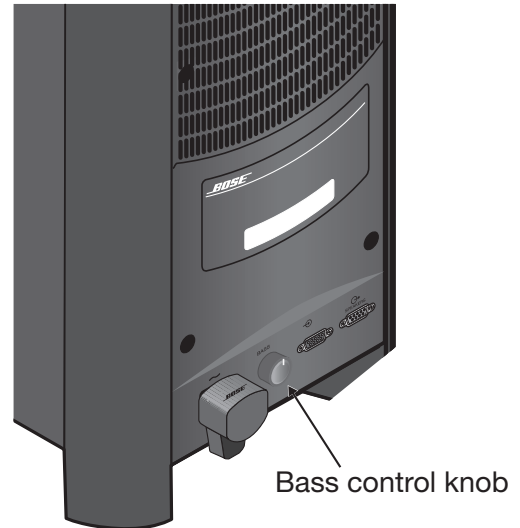

## CONTROLS AND INDICATORS

## CineMate® series II remote control

The CineMate series II remote control turns the power to your system on and off. It also controls the audio volume.

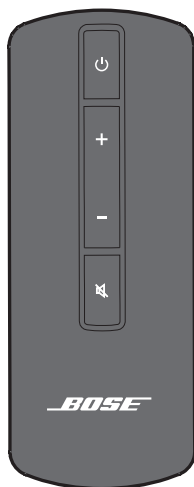

**Note:** The CineMate series II remote control only operates your CineMate series II system.

### Using the remote to control the CineMate system

When you point the remote control at the interface module and press a button, the green LED on the interface module flashes.



Press **On-Off** to turn on the CineMate system. Press again to turn the system off.



Press **Volume Up** to raise the volume. When maximum volume is reached, the green LED on the interface module flashes twice.



Press **Volume Down** to reduce the volume. When the minimum volume is reached, the green LED on the interface module flashes twice.



Press **Mute** to silence the audio. Press **Mute** again to restore the audio. When the system is muted, the green LED flashes until audio is restored.

## CineMate® GS series II remote control

The remote control provided with the CineMate GS series II system can be programmed to control your TV, DVD or Blu-ray disc player, cable/satellite box, VCR, and Digital Video Recorder (DVR). With the CineMate GS series II system universal remote, you can enjoy the convenience of using only one remote control for all your home theater equipment.

Once your universal remote control has been set up correctly, you can use it to control your TV, DVD player, and other audio/video sources.



CineMate GS series II remote control

## CONTROLS AND INDICATORS

### Using the remote to control the CineMate® system

When you point the remote control at the interface module and press the On-Off, Volume, or Mute button, the green LED on the interface module flashes.



Press **On-Off** to turn on the CineMate speaker system. Press again to turn the system off.



Volume

Press **Volume Up** to raise the volume. When maximum volume is reached, the green LED on the interface module flashes twice.

Press **Volume Down** to reduce the volume. When the minimum volume is reached, the green LED on the interface module flashes twice.



Press **Mute** to silence the audio. Press again to restore the audio. When the system is muted, the green LED on the interface module flashes until audio is restored.

The universal remote can also be programmed to control up to five audio/video devices and will control the functions of one device at a time.

### Setting the remote for your TV and other devices

To use the remote with your TV, you must set the remote for the proper TV device code.

1. Locate the TV section in the *Universal Remote Device Codes* book.
2. Locate the device code(s) for your brand of TV and start with the first one.
3. Press and hold **Setup** on the remote until all five source buttons light up.
4. Press the **TV** source button. Only the **TV** source button will remain lit.
5. On the remote keypad, enter the first device code for your brand of TV.
6. Check that the TV source button blinks twice and turns off after the code is entered.
7. Point the remote at your TV and press **TV On-Off**. If your TV does not respond, go back to Step 1 and try another code.

---

**Note:** During programming, the five source buttons will flash rapidly three times if you press an invalid key or enter an unavailable device code. If this happens, go back to Step 1 and start over.

---

Follow the same procedure for each of your other devices, using the appropriate device code and source button for each one.

### To control a combination device

- If you are programming the remote to control a combination device that has more than one source, such as a VCR/DVD unit, you can program the combination code into either remote control source. You may find it convenient to program the code twice – once for the VCR and once for the DVD.
- To find the right device code, first search the “COMBINATION” listings in the universal remote device codes book. If you cannot find a valid code there, then search the listings for individual device types (TV, CBL, VCR, DVD, etc.).

### Using the remote to watch TV

**Note:** In order to control your TV and other audio/video devices using the remote control, you must first program the remote with a device code for each device.

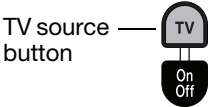
1. Press **TV On-Off** to turn on your TV and the CineMate® speaker system. The green LED on the front of the interface module will light.
2. Press the **TV** source button. The button will flash to indicate that the remote control is in TV mode.
 
3. Use the remote to select a channel and navigate menus. See “Using the CineMate® GS series II remote control” on page 21 for a complete description of the remote’s buttons. In addition to controlling TV functions, the remote will control the basic CineMate speaker functions, such as turning on the speaker system, changing the volume, and muting or turning off the speaker system.

## CONTROLS AND INDICATORS

### Using the remote to watch a DVD

**Note:** In order to control your TV and other audio/video devices using the remote control, you must first program the remote with a device code for each device.

1. Press **TV On-Off** to turn on your TV and the CineMate® speaker system. The green LED on the front of the interface module will light.
2. Press **DVD On-Off** to turn on your DVD player.
3. Press the **DVD** source button. The button will flash to indicate that the remote control is in DVD mode.
4. Use the remote to control play options and navigate DVD menus. See “Using the CineMate® GS series II remote control” on page 21 for a complete description of the remote buttons. In addition to controlling DVD functions, the remote will always control the basic CineMate speaker functions, such as turning on the speaker system, changing the volume, and muting or turning off the speaker system.

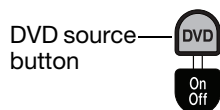

### Selecting the TV input

Press **TV•Video** to select the correct TV input for the source you want to watch. These inputs are commonly labeled TV, Video 1, Video 2, and AUX on the back of the TV. If you have multiple inputs connected to your TV, you may need to press this button several times to find the correct input.

### Switching control from one device to another

The source buttons light up when selected to indicate which source the remote is currently controlling.



You can easily switch control from one device to another by pressing the source button that corresponds with the source you want to control. In addition to controlling the selected source, the remote will always control the basic CineMate speaker functions (on/off, volume, mute).







## Using the CineMate® GS series II remote control

**Note:** In order to control your TV and other audio/video devices using the remote control, you must first program the remote with a device code for each device.

### Source and input selection

- **TV•Video:** Selects the correct TV input for the source you want to watch. These inputs are commonly labeled TV, Video 1, Video 2, and AUX. If you have multiple inputs connected to your TV, you may need to press this button several times to find the correct input. 
- **TV:** Selects the TV source. When the TV source is selected, the remote will control your TV's functions, such as channel selection and menu navigation. 
- **On-Off:** Turns TV on or off.

- **CBL-SAT:** Selects the CBL-SAT source. When the CBL-SAT source is selected, the remote will control cable/satellite box functions, such as channel selection and Electronic Program Guide navigation. If your cable/satellite box includes a Digital Video Recorder (DVR), the remote will control both cable/satellite and DVR functions when CBL-SAT source is selected. 
- **On-Off:** Turns cable/satellite on or off.
- **DVD:** Selects the DVD or CD source. When the DVD source is selected, the remote will control DVD functions, such as play options and menu navigation. 
- **On-Off:** Turns DVD on or off.
- **VCR:** Selects the VCR source. When the VCR source is selected, the remote will control VCR functions, such as play options and menu navigation. 
- **On-Off:** Turns VCR on or off.
- **AUX:** Selects the AUX source. When the AUX source is selected, the remote will control the functions of the source designated as AUX. 
- **On-Off:** Turns AUX source on or off.

## CONTROLS AND INDICATORS

### Menu and program selection

**Note:** The menu and program selection buttons will control only one source at a time, depending on which source is selected on your remote (TV, CBL-SAT, DVD, VCR, or AUX).

- Exits the Setup mode.
- Exits the menu or Electronic Program Guide of the currently selected source (if supported).
- Skips ahead one page in the Electronic Program Guide (if supported).  
CBL-SAT source must be selected.



- Skips back one page in the Electronic Program Guide (if supported).  
CBL-SAT source must be selected.
- Displays the menu for the selected source.
- Displays details of items in Electronic Program Guide (if supported).
- Displays the Electronic Program Guide (if supported).  
CBL-SAT source must be selected.
- Confirms a menu selection or introduces the next level of menu options.
- Moves up, down, left, or right in onscreen menus.

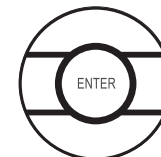



## Play options

**Note:** The functionality of the play options buttons may vary depending on the brand of your device(s). Some features may not be supported by your brand. See your owner's guide(s) for more information.

- Skips to the next or previous channel, CD track, or DVD chapter.
- Raises or lowers the volume of the current source.
- Pressing **+** restores muted sound from the current source.
- Pressing **-** lowers the volume of the current source, but does not restore muted sound.
- Stops the CD, DVD, VCR, or DVR program.
- Pauses a currently playing CD, DVD, VCR, or DVR program.
- Starts the CD, DVD, VCR, or DVR program.

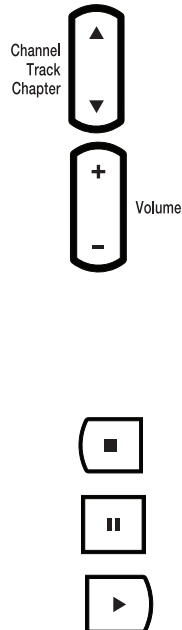

- Rewinds or forwards the CD, DVD, VCR, or DVR.
- Starts instant replay for DVR (if supported).
- Initiates the record function. The source that will record a program (VCR or DVR) must be selected. Press firmly to initiate.
- Initiates *Quick Skip* for DVR (if supported).
- Initiates *Return to Live* for DVR (if supported).
- Enters device codes.
- Selects a channel, CD track, DVD chapter, or numbered menu item (if supported).
- Enters Setup mode (for entering device codes into the remote). Press and hold for 3 seconds to enter Setup mode.
- Returns to previously selected channel.

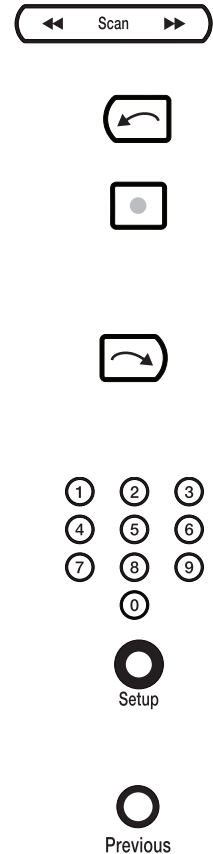

## CONTROLS AND INDICATORS

- Switches between VCR and TV as the current video input source on your VCR or VCR combination device.
- Switches between widescreen options and normal TV display (if supported).
- Displays the list of DVR recorded programs (if supported).
- Displays cable/satellite program information (if supported).



### Cable-specific buttons

These buttons operate cable-specific functions (if supported).



### TeleText buttons (Europe only)



Turns on the TeleText feature (if supported).



Turns off the TeleText feature (if supported).



Expands TeleText (top). Press again to expand TeleText (bottom). Press a third time to return to normal (if supported).



## Replacing the CineMate® series II remote battery

Replace the battery when the remote control stops operating or its range seems reduced. Insert a CR2032 or DL2032 battery into the compartment on the back of the remote control.

1. Using a coin, turn the battery cover slightly counterclockwise.

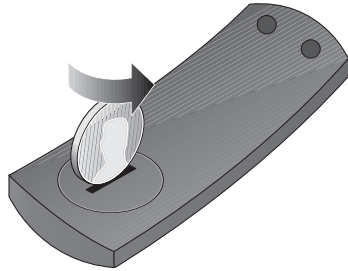

2. Remove the used battery and replace with a new battery (CR2032 or DL2032). Refer to page ii for battery safety instructions. Be sure the battery is flat side up, with the + symbol in view.

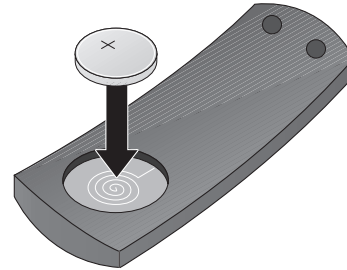

3. Re-seat the cover and turn it clockwise until it locks into place.

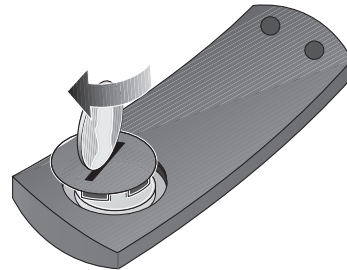

**CARE AND MAINTENANCE**

## Replacing the CineMate® GS series II remote batteries

Replace both batteries when the remote control stops operating or its range seems reduced. Alkaline batteries are recommended.

1. Slide open the battery compartment cover on the back of the remote.
2. Remove both batteries.  
Be sure to dispose of the batteries according to the regulations in your area.
3. Insert two AA (IEC-R6) 1.5V batteries, or the equivalent. Match the + and – symbols on the batteries with the + and – markings inside the compartment.
4. Slide the battery compartment cover back into place.

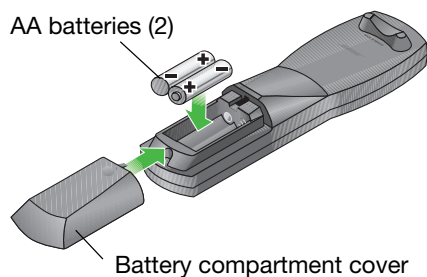

## Cleaning your speaker system

- You can clean the surface of your speakers, Acoustimass® module, and interface module with a soft, damp cloth. You can use an ammonia-free window cleaner on a soft cloth to maintain the finish.
- Do not use any sprays near the speakers. Do not use any solvents, chemicals, or cleaning solutions containing alcohol, ammonia, or abrasives.
- Do not allow liquids to spill into any openings.
- The speaker grilles require no special care, although you may vacuum them carefully, if necessary.

## Troubleshooting

| Problem  | What to do  |
|----------|---|
| No power | <ul style="list-style-type: none"> <li>• Unplug the Acoustimass® module power cord from the AC wall outlet for one minute.</li> <li>• Make sure the power cord is inserted securely into the Acoustimass module.</li> <li>• Reconnect the power cord firmly into an operating AC wall outlet. The green LED should flash 10 times, then extinguish (the system will then be in standby).</li> <li>• Make sure the interface module is plugged into the Acoustimass module properly.</li> <li>• Make sure you use the remote control to power on the system.</li> </ul>  |
| No sound | <ul style="list-style-type: none"> <li>• Make sure the CineMate® system is turned on. The green LED on the front of the interface module should be lit when the system is on.</li> <li>• Increase the volume.</li> <li>• If your system is a CineMate GS series II, make sure you pressed the remote button for the source you want to hear.</li> <li>• Check to see if the TV is muted. If so, press the TV remote control Mute button to unmute it.</li> <li>• Make sure the interface module and speaker cables are both firmly connected to the Acoustimass module.</li> <li>• Check the connections on the back of the speakers.</li> <li>• Check that the correct TV Video input has been selected. See “Selecting the TV input” on page 20.</li> <li>• Check the connections from the interface module to the TV or other source.</li> <li>• Check that the TV’s audio output is enabled. See your TV owner’s guide for information.</li> <li>• If the TV’s audio output is VARIABLE (VAR), make sure the TV’s internal speakers are turned off and the TV volume is turned up.</li> <li>• If using a sound source other than the TV, check to ensure that the device is playing source material.</li> </ul> |

## CARE AND MAINTENANCE

| Problem   | What to do   |
|---|--|
| Sound but no picture                            | <ul style="list-style-type: none"> <li>• Make sure the TV is turned on.</li> <li>• Check that the correct TV/Video input is selected. See “Selecting the TV input” on page 20.</li> </ul>  |
| Remote control is inconsistent or does not work | <ul style="list-style-type: none"> <li>• Check the battery to be sure it is installed properly.</li> <li>• Point the remote control at the interface module.</li> <li>• Relocate the interface module, making sure it is in a clear line of sight to the remote and there are no obstructions.</li> <li>• Make sure the protective film is removed from the lens on the front of the interface module.</li> <li>• Check that the source button on the CineMate® GS series II remote flashes when a button is pressed.</li> <li>• Check that the green LED on the interface module flashes when a remote power, volume, or mute button is pressed.</li> <li>• There may be more than one device code for your brand of device. Find your device and brand in the <i>Universal Device Codes</i> book. Try programming another code, then check the device for improved functionality.</li> </ul> |
| Sound is distorted                              | <ul style="list-style-type: none"> <li>• Make sure speaker cables are not damaged and the connections are secure.</li> <li>• Reduce the audio output level from the TV connected to the interface module.</li> </ul>   |
| Sound is coming from the TV                     | <ul style="list-style-type: none"> <li>• Turn off your TV's internal speakers. See “Turning off the TV internal speakers” on page 11.</li> <li>• Turn down the TV volume.</li> </ul>   |

## Customer service

For additional help in solving problems, contact Bose® Customer Service. Refer to the address sheet included with the CineMate system.

## Limited warranty

---

Your CineMate® system is covered by a limited transferable warranty. Details of the limited warranty are provided on the product registration card that is included in the carton. Please refer to the card for instructions on how to register. Failure to register will not affect your limited warranty rights.

### What you must do to obtain Limited Warranty Service:

Return product, with proof of purchase from an authorized Bose dealer, using the following procedures:

1. Contact the Bose organization in your country/region (visit **Global.Bose.com** for Bose contact information in your country/region) for specific return and shipping instructions;
2. Label and ship the product, freight prepaid, to the address provided by the Bose organization in your country; and
3. Place any necessary return authorization number prominently on the outside of the carton. Cartons not bearing a return authorization number, where required, will be refused.

## Copyright and licenses

---

©2009 Bose Corporation. No part of this work may be reproduced, modified, distributed, or otherwise used without prior written permission.

Manufactured under license from Dolby Laboratories. "Dolby" and the double-D symbol are trademarks of Dolby Laboratories. Confidential Unpublished Works. ©1992-1997 Dolby Laboratories. All rights reserved.



This product contains one or more programs protected under international and U.S. copyright laws as unpublished works. They are confidential and proprietary to Dolby Laboratories. Their reproduction or disclosure, in whole or in part, or the production of derivative works therefrom without the express permission of Dolby Laboratories is prohibited. ©1992-1996 by Dolby Laboratories, Inc. All rights reserved.

MPEG Layer-3 audio compression technology licensed by Fraunhofer IIS and THOMSON multimedia.

Designed with UEI Technology™ Under License from Universal Electronics Inc. ©UEI 2000-2002.



***BOSE***<sup>®</sup>  
*Better sound through research*<sup>®</sup>

©2009 Bose Corporation, The Mountain,  
Framingham, MA 01701-9168 USA  
AM323023 Rev.00



## Free Manuals Download Website

<http://myh66.com>

<http://usermanuals.us>

<http://www.somanuals.com>

<http://www.4manuals.cc>

<http://www.manual-lib.com>

<http://www.404manual.com>

<http://www.luxmanual.com>

<http://aubethermostatmanual.com>

Golf course search by state

<http://golfingnear.com>

Email search by domain

<http://emailbydomain.com>

Auto manuals search

<http://auto.somanuals.com>

TV manuals search

<http://tv.somanuals.com>