

FAX-2850

MFC-4800

**OWNER'S MANUAL**

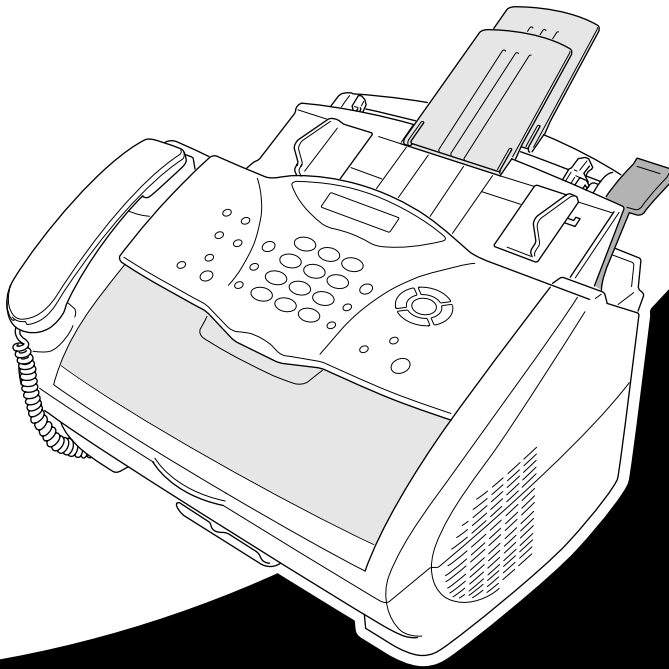

At your side.  
**brother**®



## APPROVAL INFORMATION

---

Brother advises that this product may not function correctly in a country other than which it was originally purchased, and does not offer any warranty in the event that this product is used on public telecommunication lines in another country.

### **Use only GENUINE brother supplies**

DO NOT refill the toner cartridges. Attempting to use refilled toner cartridges and using incompatible toners may cause damage to the machine and such damage will not be covered by warranty. Warranty coverage does not apply to problems caused by the use of 3rd party consumables. We can only recommend the use of genuine Brother consumables.

# Using This Manual

Thank you for purchasing a Brother fax machine/multi function centre.

This machine has been designed to be simple to use, with LCD screen prompts to guide you through functions. However, you can use the machine to its fullest potential by taking a few minutes to read this manual.



Additionally, the machine has a **Reports** key. Press **Reports** and **1** to print a help list of basic operational steps and functions.

## Finding Information

---

All chapter headings and subheadings are listed in the Table of Contents. You will also be able to find information about a specific feature or function by checking the Index at the back of this manual. Also, throughout this manual, you will see special symbols alerting you to important information, cross-references, and warnings. Illustrations of some screen displays also help you choose the correct key-presses.

## Symbols Used In This Manual

---



Note or additional information.



The machine may be damaged or may not work correctly if this is not observed.



Warnings detail precautions you must take to avoid possible personal injury.

# User-Friendly Programming

We have designed the machine with on-screen programming. User-friendly programming helps you take full advantage of all the functions the machine has to offer.

Since your programming is done on the LCD, we have created step-by-step on-screen prompts to help you program the machine. All you need to do is follow the prompts as they guide you through the function menu selections, programming options and settings. Additionally, you can program settings more quickly by pressing **Menu/Set** and the menu number using the dial pad.

A complete list of the function selections, options, and settings that are available is provided in the appendix of this manual. (See *Menu Mode & Menu Selection Table*, page 148.)

## Alternating Displays

---

The LCD sometimes alternates between the currently selected option, and a help message giving brief instructions about how to proceed. The display you'll probably see most often is shown on the right, showing you that when you place a document in the ADF, you can either dial a number to send it as a fax or press the **Copy** key to make a copy of the document.

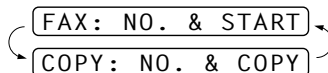







# Quick Reference Guide

For Thai, Arabic, Indonesian, Cantonese, please refer to Quick Reference Guide enclosed in the carton box.

## Sending Faxes

### Automatic Transmission

- 1 Place the original face down in the ADF.
- 2 Enter the fax number using One Touch (For FAX-2850 Only), Speed Dial, Search or the dial pad.
- 3 Press **Fax Start**.
- 4 Sending a Cover Page
- 5 Place the original face down in the ADF.
- 6 Press **Menu/Set, 2, 2, 7**.
- 7 When **NEXT FAX ONLY** appears, press **Menu/Set**.
- 8 Press  to select **ON** (or **OFF**), and then press **Menu/Set**.
- 9 Press  to select a comment, and then press **Menu/Set**.
- 10 Enter two digits to indicate the number of pages being sent, and then press **Menu/Set**.
- 11 Press **1** to select additional settings —OR— Press **2** if you are ready to fax.
- 12 Enter the fax number.
- 13 Press **Fax Start**.

### Real Time Transmission

You can send faxes in real time.

- 1 Place the original face down in the ADF.
- 2 Press **Menu/Set, 2, 2, 5**.

- 3 Press  to select **ON**, and then press **Menu/Set** —OR—

For the next transmission only, press  to select **NEXT FAX ONLY**, and then press **Menu/Set**.

- 4 For the next fax only, press  to select **ON**, and then press **Menu/Set**.
- 5 Press **1** to select additional settings —OR— Press **2** if you are ready to fax.
- 6 Enter the fax number.
- 7 Press **Fax Start**.

## Receiving Faxes

### Select Receive Mode

Press **Receive Mode** to select **FAX ONLY**, **FAX/TEL**, **TAD:ANSWER MACH.** or **MANUAL**. If you select **FAX/TEL**, make sure to set Ring Delay and F/T Ring Time.

### Manual Reception

- 1 Pick up the handset.
- 2 Press **Fax Start** if you hear fax tones (beeps).
- 3 When the LCD shows **RECEIVING**, replace the handset.





## Storing Numbers

---

### Storing One Touch Dial Numbers (For FAX-2850 Only)

- 1 Press **Menu/Set**, **2, 3, 1**.
- 2 Press the One Touch key where you want to store the number.
- 3 Enter a number (up to 20 digits), and then press **Menu/Set**.
- 4 Enter a name (or leave it blank), and then press **Menu/Set**.
- 5 Press **Stop/Exit**.

### Storing Speed Dial Numbers

- 1 For the FAX press **Menu/Set**, **2, 3, 2**.  
For the MFC, press **Menu/Set**, **2, 3, 1**.
- 2 Enter a two-digit Speed Dial number, and then press **Menu/Set**.
- 3 Enter a number (up to 20 digits), and then press **Menu/Set**.
- 4 Enter a name (or leave it blank), and then press **Menu/Set**.
- 5 Press **Stop/Exit**.



## Telephone Operation

---

### One Touch Dialing / Speed Dialing

- 1 Pick up the handset—**OR**—Press **Hook** and listen for a dial tone.
- 2 When you hear the dial tone, press the One Touch key of the location you want to call (FAX-2850)  
—**OR**—Press **Search/Speed Dial**, press **#**, then press the two-digit Speed Dial number. (If you pressed **Hook** to dial, pick up the handset when the other party answers.)
- 3 To hang up, replace the handset.

### Search/Speed Dial

- 1 Press **Search/Speed Dial**, then enter the first letter of the name you're looking for.
- 2 Press  or  to search the memory.
- 3 When the name is displayed, lift the handset—**OR**—Press **Hook**.
- 4 Press **Fax Start** to dial. (If you pressed **Hook** to dial, pick up the handset when the other party answers.)
- 5 To hang up, replace the handset.

## Making Copies

---

### Making a Single Copy

- 1 Place the original face down in the ADF.
- 2 Press **Copy**.

### Making Multiple Copies

- 1 Place the original face down in the ADF.
- 2 Use the dial pad to enter the number of copies you want.
- 3 Press **Copy**.





# Table of Contents

## Using This Manual

### User-Friendly Programming

Table of Contents .....	vi
-------------------------	----

## PREPARATION AND SIMPLE USE

### Preparation and Simple Use Guide

Advice for Preparation and Simple Use Guide .....	3
FAX-2850 Control Panel Overview .....	7
MFC-4800 Control Panel Overview .....	9

## BASIC FAX USE

### Chapter 1 Setup

Initial Settings.....	11
Custom Settings.....	12
Storing Numbers for Easy Dialling .....	14

### Chapter 2 Sending a Fax

Scanning Adjustment.....	16
Dialling a Number .....	16
Sending Operation .....	18

### Chapter 3 Receiving a Fax

Receive Mode Settings .....	20
Receiving a Fax .....	23

### Chapter 4 Telephone (Voice) Operation

Making Voice Calls .....	25
--------------------------	----

### Chapter 5 Printing Reports

Transmission Report and Journal Setting.....	28
Using the Reports Key.....	29

## ADVANCED FAX USE

### Chapter 6 Advanced Sending

Advanced Operations .....	30
---------------------------	----

### Chapter 7 Advanced Receiving

Operation from an External or Extension Telephone.....	38
--------------------------------------------------------	----

### Chapter 8 Telephone Service

Telephone Service for Australia.....	40
Telephone Service for New Zealand .....	43

Caller ID (Caller IDentification).....	45
Telephone Service for Some Countries .....	47

**Chapter 9 Polling**

Polling Receive .....	49
Polling Transmit.....	51

**Chapter 10 Remote Fax Options**

Setting Fax Storage.....	52
Fax Forwarding.....	52
Remote Retrieval .....	53

**COPIER**

**Chapter 11 Making Copies**

Basic Copy Operations .....	56
Temporary Copy Setting.....	57
Copy Quality – Default Settings.....	60

**PRINTER/SCANNER**

**Chapter 12 Using the machine as a Printer**

Special Printing Features .....	62
Printing From Your PC.....	62
Simultaneous Printing/Faxing.....	64
Acceptable Paper .....	65

**Chapter 13 Printer Driver Settings (For Windows® Only)**

Using the Brother MFC-4800 Printer Driver.....	66
Basic Tab .....	66
Advanced Tab .....	68
Support.....	75

**Chapter 14 Using the Windows®-Based Brother MFL-Pro Control Centre (For Windows® Only)**

Brother MFL-Pro Control Centre .....	76
Using the Scan Keys with PC Windows.....	77
Using the Control Panel Keys.....	78
Brother Control Centre Features.....	79
Scan to File .....	82
Scan to E-mail.....	83
Scan to Word Processor .....	85
User Defined Button .....	86
Copy.....	87
Send a Fax.....	88

**Chapter 15 Using ScanSoft™ PaperPort® for Brother and ScanSoft™ TextBridge®**

<b>Chapter 16</b>	<b>Setting Up and Using PC FAX (For Windows® Only)</b>	
	Introduction .....	95
	MFC Remote Setup .....	95
	PC FAX Sending (For Windows® Only) .....	96
<b>Chapter 17</b>	<b>Using Automatic E-Mail Printing</b>	
	For Windows® 95, 98, 98SE, Me Only .....	106
<b>Chapter 18</b>	<b>Using the Brother MFC with a New Power Macintosh® G3, G4 or iMac™ /iBook™</b>	
	Set up Your USB Equipped Apple® Macintosh® G3,G4 or iMac™ with Mac OS 8.5/8.5.1/8.6/9.0/9.0.4/9.1 .....	107
	Using Brother Printer Driver with your Apple® Macintosh® .....	107
	Sending a Fax from your Macintosh Application .....	109
	Using Brother TWAIN Scanner Driver with Your Apple® Macintosh® ...	113

## **MAINTENANCE**

<b>Chapter 19</b>	<b>Troubleshooting and Maintenance</b>	
	Error Messages .....	117
	Document Jams and Paper Jams.....	119
	Packing and Shipping the Machine .....	125
	Regular Maintenance.....	127

## **IMPORTANT INFORMATION**

<b>Chapter 20</b>	<b>Important Safety Information</b>	
	Important Information for Australia.....	136
	Important Information for New Zealand .....	137
	Important Information for Some Countries .....	139
	Important Information for All Countries .....	141

## **APPENDIX**

<b>Chapter 21</b>	<b>Specifications</b>	
	Fax Specifications .....	143
	Printer Specifications (For MFC-4800 Only).....	144
	Computer Requirement (For MFC-4800 Only) .....	145
	Electrical and Environment .....	145
	Compilation and Publication Notice .....	146
	Trademarks .....	146
	Entering Text .....	147
	Menu Mode & Menu Selection Table .....	148
	About Fax Machines.....	153
	Glossary.....	154
	Index .....	157

# Preparation and Simple Use Guide

## Steps to prepare and use the machine simply

Follow the steps below to prepare and use the machine simply.

However, before you perform these steps, see **Important Safety Information** (page 136), and **Advice for Preparation and Simple Use Guide** (page 3).

If you need further information, refer to BASIC USE or ADVANCED USE.

### 1 Read the Quick Setup Guide

Follow the instructions on the Brother Quick Setup Guide to set up the machine.

### 2 Setting the Document

- Documents must be between 14.8 and 21.6 cm wide, and 15 and 60 cm long. This machine can only scan an image 20.8 cm wide, regardless of how wide the document is.
- Make sure you insert documents **face down, top edge first**.
- Adjust the paper guides to fit the width of your document.

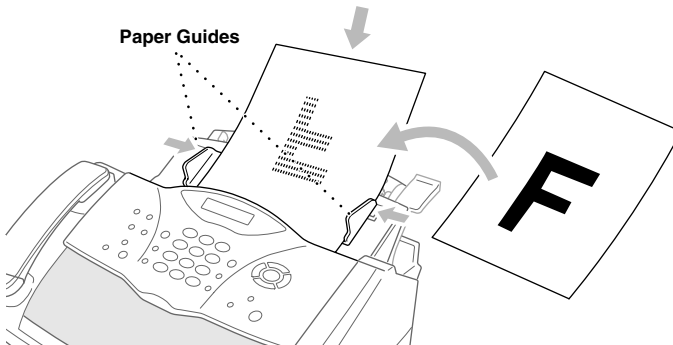

- The automatic document feeder (ADF) can hold up to 20 pages, feeding each one individually through the machine. Use standard ( $64 \text{ g/m}^2$ – $90 \text{ g/m}^2$ ) paper when using the ADF; if you're using heavier paper, feed each sheet individually to prevent paper jams.

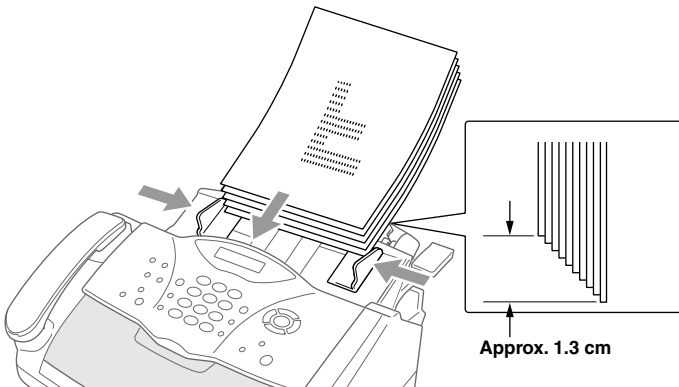

- Open the document tray by pulling it toward you (①), then unfold the extension (②).

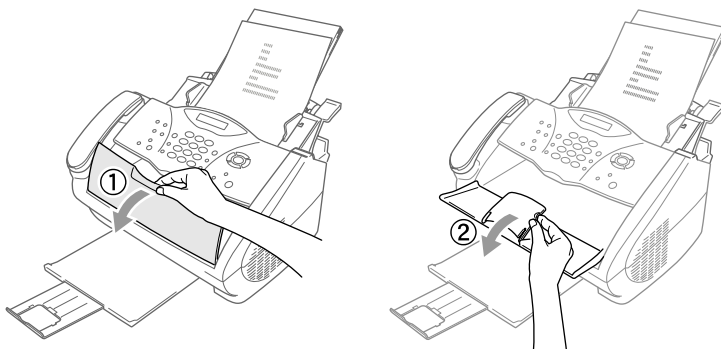

- **DO NOT** use curled, wrinkled, folded, or ripped document, or document with staples, paper clips, paste, liquid paper or tape attached. **DO NOT** use cardboard, newspaper, or fabric.
- **Make sure** documents written with ink are completely dry.

### 3 Sending a fax

- ① Insert the document *face down* in the ADF.
- ② Enter the fax number you want to call.
- ③ Press **Fax Start**.

### 4 Making a single copy

- ① Insert the document *face down* in the ADF.
- ② Press **Copy**.
- ③ To stop copying, press **Stop/Exit**. Press **Stop/Exit** again to release the original document. (See *Making Copies*, page 56.)

### 5 Multiple Copies

- ① Insert the document *face down* in the ADF.
- ② Using the dial pad, enter the number of copies you want (up to 99).  
For example, press **3, 8** for 38 copies.
- ③ Press **Copy**.

# Advice for Preparation and Simple Use Guide

## Choosing a Location

---

Place the machine on a flat, stable surface, such as a desk. Select a place that is free of vibration and shocks. Locate the machine near a telephone wall socket and a standard earthed electrical socket, grounded power outlet.



**Avoid placing the machine where it may be knocked. Do not place near heaters, air conditioners, water, chemicals or refrigerators. Do not expose the machine to direct sunlight, excessive heat, moisture or dust. Do not connect the machine to electrical outlets controlled by wall switches or automatic timers as disruption of power can wipe out information in the unit's memory. Do not connect the machine to electrical outlets on the same circuit as large appliances or other equipment that might disrupt the power supply. Avoid interference sources, such as speakers or the base units of cordless phones. Ensure the airflow from the fan on the right hand side of the machine is not impeded.**



- We recommend that this product be used with a surge protection device to protect the product against damage caused by a lightning strike.
- Never touch telephone wires or terminals that are not insulated unless the telephone line has been disconnected at the network interface.
- Avoid using a telephone (other than a cordless type) during an electrical storm. There may be a remote risk of electric shock from lightning.
- Do not use the telephone to report a gas leak in the vicinity of the leak.

## Connecting the Power Cord

---



- This machine must be fitted with an earthed plug.
- Since the machine is earthed via the mains plug, you can protect yourself from potentially hazardous electrical conditions on the telephone network by keeping the power to the machine on when you connect it to a telephone line. Similarly, you can protect yourself when you want to move the machine, by disconnecting the telephone line first, and then the power cord.

**IMPORTANT:**

If you need to remove the moulded mains plug in order to fit an appropriate type, you must discard the moulded plug immediately having cut it off, in order that it is not inadvertently inserted into a live socket, thus presenting a shock hazard. The wires in the mains lead of this appliance are colored in accordance with the following code.

- Green-and-yellow : Earth
- Blue : Neutral
- Brown : Live

As the wires in the mains lead of this apparatus may not correspond with the colored markings identifying the terminals in your plug, proceed as follows: The wire which is colored green-and-yellow must be connected to the terminal in the plug which is marked by the letter "E" or by the safety earth symbol  $\perp$  or colored green or green-and-yellow.

The wire which is colored blue must be connected to the terminal which is marked with the letter "N" or colored black.

The wire which is colored brown must be connected to the terminal which is marked with the letter "L" or colored red.

## Memory Storage

In the event of a power failure, all settings in the **GENERAL SETUP**, **SETUP RECEIVE**, **SETUP SEND**, **SET QUICK-DIAL**, **REPORT SETTING**, **REMOTE FAX OPT** and **MISCELLANEOUS** functions are stored permanently and fax sending and receiving data are stored for several days.

# Connecting an External Telephone Answering Device (TAD)

## Sequence

You might choose to connect an additional answering machine. When you have an **external** TAD on the same telephone line as the machine, the TAD answers all calls. The machine “listens” for fax calling (CNG) tones. If it hears them, the machine takes over the call and receives the fax. If it doesn’t hear the CNG tones, the machine will not answer the call, and messages can be left on the TAD by callers in the normal way.

The TAD must answer within a maximum of four rings. However, we recommend two rings as the TAD setting. The machine cannot hear CNG tones until the TAD has answered the call, and with four rings there are only 8–10 seconds of CNG tones left for the fax “handshake.” Make sure you carefully follow instructions in this manual for recording your outgoing message. Do not use a “toll-saver” ring setting on the TAD.



**It is important that the TAD is connected via the EXT socket on the machine or on the line jack unit. Do not use a line doubler on the line jack as this can cause answering problems.**

## Connections

**1** You may connect an external TAD to the machine, as shown below.

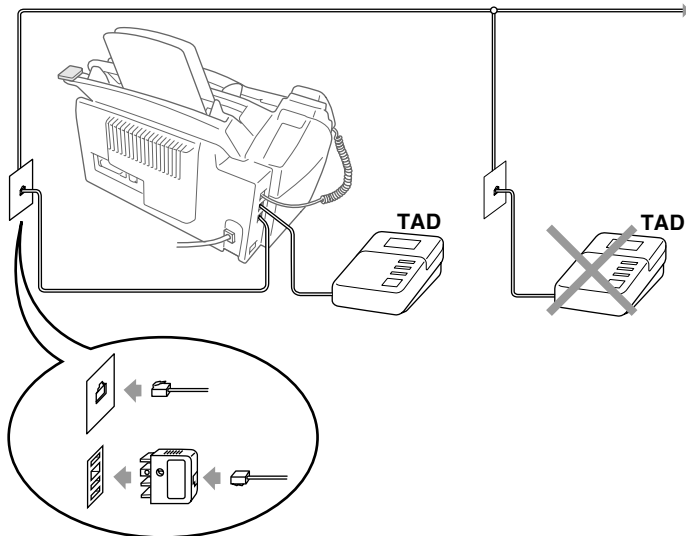

(Example for Australia)

- 2** Set your external TAD to two rings or less.
- 3** Record the outgoing message (see next page).
- 4** Set the TAD to answer calls.
- 5** Set the Receive Mode to **TAD:ANSWER MACH.** by pressing **Receive Mode**.



## Outgoing Message (OGM) of External TAD

Timing is important in recording this message. The message sets up the ways to handle both manual and automatic fax reception.

- 1 We recommend the outgoing message (OGM) is no longer than 20 seconds.
- 2 Allow 5 seconds of silence at the beginning of your message.  
(This allows the fax to detect the calling tone prior to OGM, so reception can be faster.)
- 3 We recommend that you end your OGM by giving your Remote Activation Code for people sending manual faxes. For example:  
“After the beep, leave a message or send a fax manually by pressing \*51 (\*91 for New Zealand) and Fax Start.”

Please note that some faxes that are sent manually cannot be received automatically because some fax machines do not send a fax tone if the call is manually dialed. In these cases you must inform callers that they must enter the remote activation code to send a fax.

## Connecting an External Telephone

Your FAX/MFC is equipped with a handset that you can use as a regular phone. However, you can also connect a separate telephone to your FAX/MFC, as shown below.

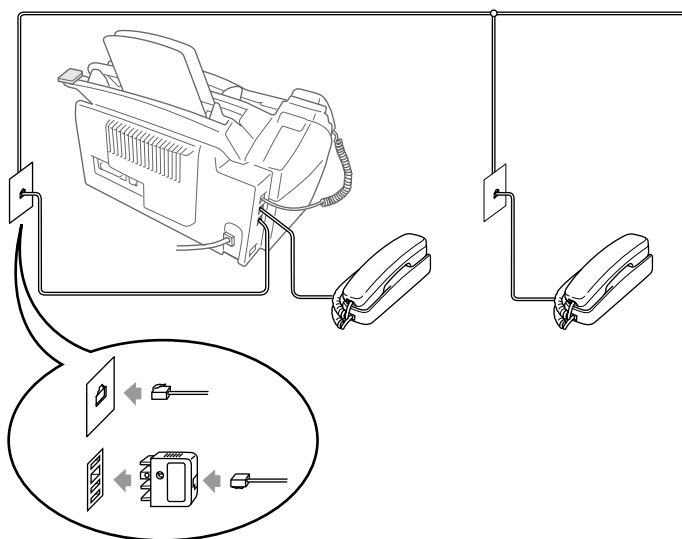

(Example for Australia)

Whenever this external phone (or TAD) is in use, the screen displays **EXT. TEL IN USE**, and, if the FAX/MFC's handset is lifted, an alarm sounds.

To disconnect the call on the external phone and switch to the FAX/MFC, lift the handset and press **Hook**.

# FAX-2850 Control Panel Overview

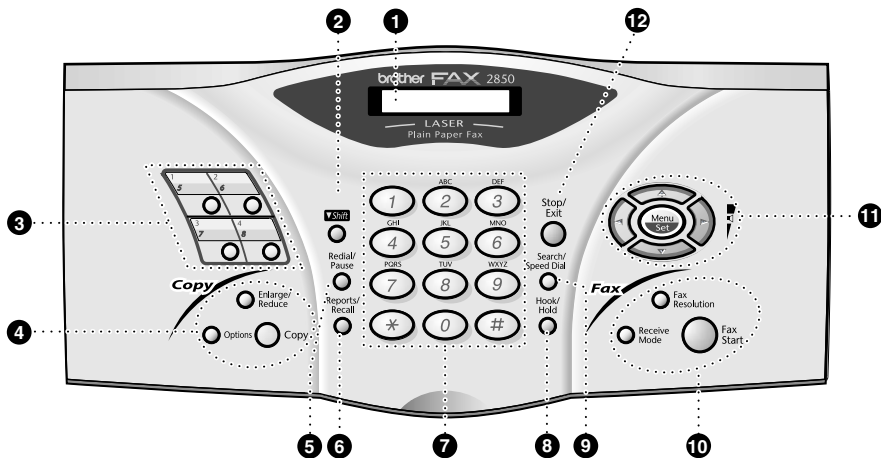

## 1 Liquid Crystal Display

Displays messages to help you set up and operate the machine.

## 2 Shift

This key is used to access the “5” through “8” One Touch keys.

## 3 One Touch Dial Keys

These 4 keys give you access to 8 previously stored phone numbers.

## 4 Copy Keys: Options

You can quickly and easily select temporary settings (for the next copy only).

### Enlarge/Reduce

Lets you select an enlargement or reduction ratio: 50%, 71%, 100%, 141%, 150%, 200%. For more choices, select **MANUAL** and use dial pad to type any percentage between 50% and 200%.

### Copy

Makes a copy.

## 5 Redial/Pause

Re-dials the last number called. Also inserts a pause in autodial numbers.

## 6 Reports/Recall

You can access the Reports menu so you can select a report to print: Help, Quick Dial, Journal, Xmit Verify and System Setup List and Order Form.

## 7 Dial Pad

Dials phone and fax numbers and can be used as a keyboard for entering information into the machine.

**#** key lets you switch the dialling type during a telephone call from “**PULSE**” to “**TONE**”. (Not available in New Zealand.)

## 8 Hook/Hold

Lets you dial telephone and fax numbers without lifting the handset.

—**OR**—

Lets you place telephone calls on hold.

## 9 Search/Speed Dial

Lets you look up numbers stored in the dialling memory. Also, lets you dial stored phone numbers by pressing **#** and two-digit number.

**10 Fax Keys:**

**Receive Mode**

Select how the machine will handle incoming calls.

**Fax Resolution**

Sets the resolution when you send a fax.

**Fax Start**

Starts sending a fax.

**11 Navigation Keys:**

**Menu/Set**

Lets you access the menu and programming mode and stores your settings in the machine.

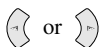

Press to scroll forward or backward to set a menu selection.

Also, you can use these keys to do an alphabetical search for the names of stored numbers.



Press to scroll through the menus and options.

—OR—

You can press these keys to adjust the ring or speaker volume.

**12 Stop/Exit**

Stops a fax, cancels an operation or exits from function mode.

# MFC-4800 Control Panel Overview

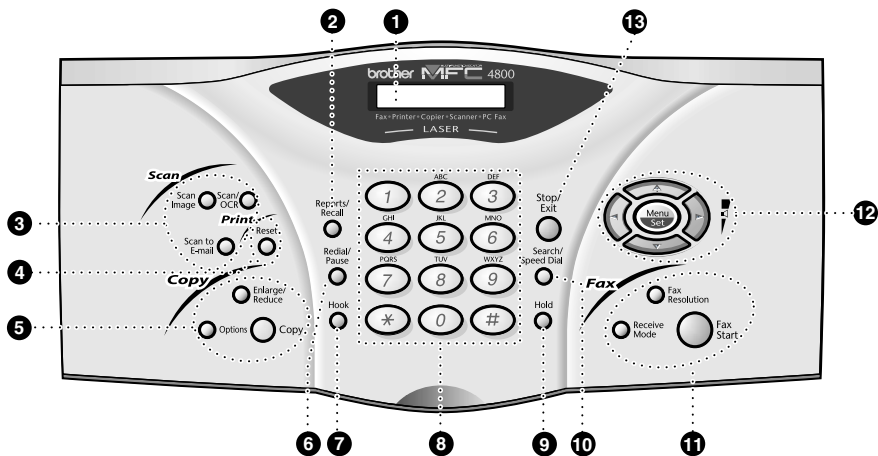

- 1 Liquid Crystal Display**  
Displays messages to help you set up and operate the machine.
- 2 Reports/Recall**  
Accesses the Reports menu so you can select a report to print: Help, Quick Dial, Journal, Xmit Verify and System Setup List and Order Form.
- 3 Scan Keys:**  

**Scan Image**  
Press this key to scan a picture into your graphics application for viewing and editing.

**Scan/OCR**  
Press this key to start scanning a text document. ScanSoft™ TextBridge® will convert it to editable text and display it in your word processor application for further editing.

**Scan to E-mail**  
Press this key to start scanning an original into your E-mail application, setting it up automatically as an attachment.
- 4 Print Key:**  

**Reset**  
Clears data from the printer memory.
- 5 Copy Keys:**  

**Options**  
You can quickly and easily select temporary settings (for the next copy only).

**Enlarge/Reduce**  
Lets you select an enlargement or reduction ratio: 50%, 71%, 100%, 141%, 150%, 200%. For more choices, select **MANUAL** and use dial pad to type any percentage between 50% and 200%.

**Copy**  
Makes a copy.
- 6 Redial/Pause**  
Re-dials the last number called. Also inserts a pause in autodial numbers.
- 7 Hook**  
Lets you dial telephone and fax numbers without lifting the handset.
- 8 Dial Pad**  
Dials phone and fax numbers and can be used as a keyboard for entering information into the machine.  
# key lets you switch the dialling type during a telephone call from “**PULSE**” to “**-tone**”. (Not available in New Zealand.)
- 9 Hold**  
Lets you place telephone calls on hold.
- 10 Stop/Exit**  
Press this key to stop a copy or fax job.
- 11 Fax Keys:**  

**Fax Resolution**  
Selects the resolution for the fax.

**Receive Mode**  
Selects the receive mode for the fax.

**Fax Start**  
Starts a fax.
- 12 Menu/Start**  
Press this key to start a copy or fax job.
- 13 Search/Speed Dial**  
Press this key to search for a speed dial number.

**10 Search/Speed Dial**

Lets you look up numbers stored in the dialling memory. Also, lets you dial stored phone numbers by pressing # and two-digit number.

**11 Fax Keys:**

**Receive Mode**

Select how the machine will handle incoming calls.

**Fax Resolution**

Sets the resolution when you send a fax.

**Fax Start**

Starts sending a fax.

**12 Navigation Keys:**

**Menu/Set**

Lets you access the menu and programming mode and stores your settings in the machine.

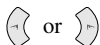

Press to scroll forward or backward to set a menu selection.

Also, you can use these keys to do an alphabetical search for the names of stored numbers.



Press to scroll through the menus and options.

—OR—

You can press these keys to adjust the ring or speaker volume.

**13 Stop/Exit**

Stops a fax, cancels an operation or exits from function mode.

# 1 Setup

## Initial Settings

### Setting the Date and Time

---

The machine displays the date and time, and prints it on every fax you send.

In the event of a power failure, the machine maintains date and time information for up to 9 hours. All other settings remain unaffected.

- 1 Press **Menu/Set**, **1**, **1**.
- 2 Enter the two digits of the year, and press **Menu/Set**. “02” is registered as 2002 in the machine.
- 3 Enter two digits for the month and press **Menu/Set**.
- 4 Enter two digits for the day and press **Menu/Set**.
- 5 Enter the time in 24 hour format and press **Menu/Set**.
- 6 Press **Stop/Exit**.

### Setting the Station ID

---

You can store your name, fax number, and telephone number to be printed on the fax Cover Page, and on all fax pages that you send. (See *Electronic Cover Page*, page 30.)

It is important that you enter the fax and telephone numbers in the internationally standardized format, i.e. in accordance with the following strict sequence:

- The “+” (plus) character (press \* key)
- Your Country Code
- Your local area code minus any leading “0”
- A space
- Your number on the local exchange, using spaces to aid readability as appropriate.

- 1 Press **Menu/Set**, **1**, **2**.
- 2 Enter your fax number (up to 20 digits) and press **Menu/Set**.
- 3 Enter your telephone number (up to 20 digits) and press **Menu/Set**.
- 4 Enter your name (up to 20 characters) using the dial pad and the chart. To enter a space press  twice.
- 5 Press **Menu/Set**.
- 6 Press **Stop/Exit**.



- When you enter your name, see *Entering Text*, page 147.
- The telephone number you enter is used only for the Cover Page features.
- If you do not enter a fax number, no additional information can be entered.
- To enter a space, press  once between numbers and twice between characters.
- If your Station ID has already been programmed, the screen prompts “1” to make a change, or “2” to exit without changing.



# Custom Settings

## Volume Settings

---



### Ring Volume

You can select how loud the machine rings. The ring volume can be turned off for silent reception if required.

- 1 Press **Menu/Set, 1, 3, 1.**
- 2 Press  or  to select **OFF, LOW, MED, or HIGH.**
- 3 Press **Menu/Set** when the screen displays your selection.
- 4 Press **Stop/Exit.**

—OR—



You can adjust the ring volume when the machine is idle. You can turn the ring OFF.

Press  or  to adjust the volume level. With each key press, the machine rings so you can hear the current setting and the display shows the setting you are choosing. Each key press changes the volume to the next setting.

The new setting will remain until you change it again.



### Beeper Volume

You can set the beeper to **LOW, HIGH** or **OFF**. The machine comes with this volume set to **LOW**. When the beeper is set to **LOW** or **HIGH**, the machine beeps every time you press a key or make an error, and at the end of sending or receiving a fax.

- 1 Press **Menu/Set, 1, 3, 2.**
- 2 Press  or  to select your setting.
- 3 When the screen displays the setting you want, press **Menu/Set.**
- 4 Press **Stop/Exit.**

### Speaker Volume

You can set the volume of the machine speaker.

- 1 Press **Menu/Set, 1, 3, 3.**
- 2 Press  or  to select your volume setting (**OFF, LOW, MED, or HIGH**).
- 3 Press **Menu/Set** when the screen displays your selection.
- 4 Press **Stop/Exit.**

—OR—

If you are using **Hook**, you can adjust the speaker volume while dialing. You can turn the speaker off or you can select a speaker volume level. The default setting is the lowest volume.



Press  or  to adjust the volume level. The display shows the setting you are choosing.

Each key press changes the volume to the next setting. The new setting will remain until you change it again. Press **Hook** to disconnect the line.

## Toner Save

---

You can conserve toner using this feature. When you set Toner Save to **ON**, print appears somewhat lighter. The default setting is **OFF**.



- 1 Press **Menu/Set, 1, 4**.
- 2 Press  or  to select **ON** (or **OFF**).
- 3 Press **Menu/Set**.
- 4 Press **Stop/Exit**.

## Power Save

---

Setting Power Save Mode more reduces power consumption. If you switched **ON**, when the machine is idle, it drops into power save mode automatically.

In the power save mode, you can not use fax detect function and remote activation with the extension or external phone. And the machine does not display the date and time.

- 1 Press **Menu/Set, 1, 5**.
- 2 Press  or  to select **ON** (or **OFF**).
- 3 Press **Menu/Set** when the screen displays your selection.
- 4 Press **Stop/Exit**.

## Sleep Mode

---



Setting the Sleep Mode reduces power consumption while the machine is idle. You can choose how long the machine is idle (from 00 to 99 minutes) before it drops into sleep mode. The timer automatically resets when the machine receives a fax or PC data, or makes a copy. The factory setting is 0 minutes.

- 1 Press **Menu/Set, 1, 6**.
- 2 Use the dial pad to enter the amount of time the machine is idle before it drops into sleep mode (00 to 99).
- 3 Press **Menu/Set**.
- 4 Press **Stop/Exit**.



## Setting the Dialling Mode (Tone/Pulse) (Not available in New Zealand)

The machine is initially set to **TONE**. If you are using a **PULSE** dial line, you can change the setting to **PULSE** by following the steps below.

- 1 Press **Menu/Set**, **1**, **7**. The screen prompts you to select **PULSE** (or **TONE**).
- 2 Use  or  to select the dialling mode.
- 3 Press **Menu/Set** when the screen displays the dialling mode you want.
- 4 Press **Stop/Exit**.

## Storing Numbers for Easy Dialling

You can set up the machine to do the following types of easy dialling: One Touch (FAX-2850), Speed Dial and Groups for Broadcasting of faxes.

Even if you lose electrical power, numbers stored in memory will not be lost.

### Storing One Touch Dial Numbers (For FAX-2850 Only)

You can store 8 fax/phone numbers that you can dial by pressing one key. You can also store names with these numbers. When you press a One Touch key, the screen displays the name or number as the call is dialled. (See *One Touch Dialling (For FAX-2850 Only)*, page 16.)



One Touch Dial keys are not the dial pad keys. They are the 4 keys (numbers 1-8). One Touch Dial Numbers 5-8 are accessed by holding down **Shift** while you press the appropriate One Touch Dial key.

- 1 Press **Menu/Set**, **2**, **3**, **1**.
- 2 Press the One Touch Dial key where you want to store a number. The screen displays the location you selected.
- 3 Enter a number (up to 20 digits), and press **Menu/Set**. The screen prompts you to enter a name for this number.
- 4 Use the dial pad to enter the name (up to 15 characters). (See *Entering Text*, page 147.)—**OR**—Go to Step 5 to store the number without a name.
- 5 Press **Menu/Set**. Return to Step 2 to store another One Touch dial number—**OR**—Press **Stop/Exit**.

When you dial a One Touch dial number, the screen displays the name you have stored or if you have not stored a name, the number you have stored.

## Storing Speed Dial Numbers

---

You can store Speed Dial numbers, which you dial by pressing only four keys. There are 100 Speed Dial locations. (See *Speed Dialling*, page 17.)



- 1** For the FAX, press **Menu/Set, 2, 3, 2**.  
For the MFC, press **Menu/Set, 2, 3, 1**.  
The screen prompts you to enter a location.
- 2** Use the dial pad to enter a two-digit location (00-99), and press **Menu/Set**. The screen displays your entry, then prompts you to enter the number you're storing.
- 3** Enter the number (up to 20 digits), and press **Menu/Set**.  
The screen now prompts you to store a name with this number.
- 4** Use the dial pad to enter the name (up to 15 characters). (See *Entering Text*, page 147.)—**OR**—  
Go to Step 5 to store the number without a name.
- 5** Press **Menu/Set**. Return to Step 2 to store another Speed Dial number—**OR**—Press **Stop/Exit**.

When you dial a Speed dial number, the screen displays the name you have stored or if you have not stored a name, the number you have stored.

## Changing One Touch (FAX-2850) and Speed Dial Numbers

---

If you try to store a One Touch or Speed Dial number in a location where a number is already stored, the screen displays the current name stored there, then prompts you to either change it or exit.

- 1** Press **1** to change the number stored, or press **2** to exit without making a change.
- 2** Enter a new number.
  - ◆ If you want to erase the number, press **Stop/Exit** when the cursor is to the far left of the digits.
  - ◆ If you want to change a digit, use  or  to position the cursor under the digit you want to change, then enter the new digit—**OR**—Press **Stop/Exit** to delete all characters above and to the right of the cursor.
- 3** Follow the directions in Storing One Touch Dial or Speed Dial Numbers.





You can print a list of all stored numbers. (See *Using the Reports Key*, page 29.)

## Scanning Adjustment

### Contrast



If your document is very light or very dark, you might want to set the contrast accordingly. Use **LIGHT** to send a light document. Use **DARK** to send a dark document. This setting is a temporary setting.

- 1 Insert the document face down in the ADF.
- 2 Press **Menu/Set, 2, 2, 1**.
- 3 Use  or  to select **AUTO**, **LIGHT**, or **DARK**.
- 4 When the screen displays your selection, press **Menu/Set**.
- 5 Press **2** if you have finished choosing settings, and go to Step 6—**OR**—Press **1** if you want to select additional settings. The display returns to **Setup Send** menu.
- 6 Enter a fax number and press **Fax Start**.

### Fax Resolution

When you have a document in the ADF, you can use the **Fax Resolution** key to temporarily change the setting. Press **Fax Resolution** repeatedly until the LCD shows the setting you want.  
—**OR**—

You can change the default setting.

- 1 Press **Menu/Set, 2, 2, 2**.
- 2 Press  or  to select the resolution you want, and then press **Menu/Set**.
- 3 Press **Stop/Exit**.

**STANDARD:** Suitable for most typed documents.

**FINE:** Good for small print; transmits a little slower than Standard resolution.

**S.FINE:** Good for small print or artwork; transmits slower than Fine resolution.

**PHOTO:** Use when document has varying shades of grey; slow transmission time.

## Dialling a Number

### One Touch Dialling (For FAX-2850 Only)

- 1 Insert the document face down in the ADF.
- 2 Press the One Touch key of the location you want to call.
- 3 Press **Fax Start**.



If you try to use a One Touch or Speed Dial location with no number stored in it, you hear a warning sound, and screen displays **NOT ASSIGNED**. The display returns to normal after 2 seconds.

## Speed Dialling



---

- 1 Insert the document face down in the ADF.
- 2 Press **Search/Speed Dial**, then press **#** and the two-digit Speed Dial number.
- 3 Press **Fax Start**.



## Search

---

You can search for names you have stored in One Touch (FAX-2850) and Speed Dial memories. (See *Storing One Touch Dial Numbers (For FAX-2850 Only)*, page 14 and *Storing Speed Dial Numbers*, page 15.)

- 1 Insert the document face down in the ADF.
- 2 Press **Search/Speed Dial**, then enter the first letter of the name you're looking for.
- 3 Press  or  to search the memory that are stored alphabetically.
- 4 When the screen displays the name you want to call, press **Fax Start**.



You can also use  or  key to search the numbers you have stored in memory in numerical order. In that case, do not enter the first letter of the name in Step 2.

## Chain Dialling

---

You can store very long dialling sequences by dividing them and setting them up as One Touch (for FAX-2850 only) and Speed Dial numbers. Then while dialling, you can combine two or more One Touch and/or Speed Dial numbers and even include manual dialling using the dial pad. You can use these numbers in any combination. The combined number will be dialled, in the order you entered it, as soon as you press **Fax Start**.

For example:

For the FAX-2850, you can store “555” on One Touch Dial key **01** and “7000” on One Touch Dial key **02**. If you press One Touch **01**, **02** and **Fax Start**, you can dial “555 7000”. To temporarily change a number, you can substitute part of the number with manual dialling using the dial pad. So, if you press One Touch **01** and press **7001** using the dial pad, you can dial “555 7001”.

For the FAX-2850 and MFC-4800, you can store “555” on Speed Dial #01 and “7000” on Speed Dial #02. If you press **Search/Speed Dial**, **#**, **0**, **1**, **Search/Speed Dial**, **#**, **0**, **2** and **Fax Start**, you can dial “555 7000”. To temporarily change a number, you can substitute part of the number with manual dialling using the dial pad. So, if you press **Search/Speed Dial**, **#**, **0**, **1** and press **7001** using the dial pad, you can dial “555 7001”.

Using access codes is easy. Sometimes you may want to choose from the among several long distance carriers when you make a call; rates may vary depending upon the time and destination. To take advantage of low rates, you can store the access codes or long-distance carriers as One Touch and Speed Dial numbers.

## Manual and Automatic Fax Redial

---

If you're sending a fax manually and the line is busy, press **Redial/Pause** and **Fax Start** to try again. Anytime you want to make a second call to the last number dialled, press **Redial/Pause** and **Fax Start** to save time.

If you're sending a fax automatically and the line is busy, the machine will automatically redial up to 2 times at 2 minute intervals for Australia or up to 2 times at 3 minute intervals for New Zealand (10 times in 3 minute intervals for some countries).

## Pause

---

Press **Redial/Pause** to insert a pause between digits to be dialled.



When you press **Redial/Pause**, a dash "-" will appear on the display. By storing a pause, you can create a delay of 3.5 seconds.

## Sending Operation

### Automatic Transmission

---

This is the easiest way to send a fax.

**IMPORTANT:** Do not pick up the handset, or press **Hook** to listen for a dial tone.

- 1 Insert the document face down in the ADF.
- 2 Enter the fax number using One Touch (FAX-2850), Speed Dial, Search or the dial pad.
- 3 Press **Fax Start**.

### Manual Transmission

---

Manual transmission lets you hear the dial tone, ringing and fax receiving tones before sending a fax.

- 1 Insert the document face down in the ADF.
- 2 Pick up the handset and listen for a dial tone—**OR**—press **Hook** and listen for a dial tone.
- 3 Enter the fax number you want to call. (You can dial the number by using One Touch, Speed Dial, Search or dial pad.) (See *Dialling a Number*, page 16.)
- 4 When you hear the fax tone, press **Fax Start**.
- 5 Replace the handset.

## Dual Access

---

You can scan up to 50 messages into the fax memory, even while the machine is receiving or sending another fax (from the memory). You can set temporary settings for each fax you're scanning, except Timer and Polling.







If you get a **OUT OF MEMORY** message while scanning the first page of a fax, press **Stop/Exit** to cancel the scan. If you get a **OUT OF MEMORY** message while scanning in a subsequent page, you'll have the option to press **Fax Start** to transmit the pages scanned so far, or to press **Stop/Exit** to cancel the operation.

- 1 Insert the document face down in the ADF.
- 2 Enter the fax number.
- 3 Press **Fax Start**. The machine starts scanning the document and the screen displays the job number (#XXX) of the fax, and how much memory is available. When the machine starts dialling you can immediately repeat Steps 1 through 3 for the next fax.

## Real Time Transmission

---

When memory is full, the machine cannot continue to scan documents into memory before sending. However, you can turn on **REAL TIME TX**. Then place the documents in the ADF and enter the fax number. As soon as the phone line is free, the machine starts dialling and sending the fax.

- 1 Insert the document face down in the ADF.
- 2 Press **Menu/Set, 2, 2, 5**.
- 3 To change the default setting, press  or  to select **ON** (or **OFF**) and press **Menu/Set**. Go to Step 6—**OR**—For the next fax transmission only, press  or  to select **NEXT FAX ONLY**.
- 4 Press **Menu/Set**.
- 5 For the next fax only, press  or  to select **ON** (or **OFF**) and press **Menu/Set**.
- 6 Press **1** if you want to select additional settings. The display returns to the **SETUP SEND** menu—**OR**—Press **2** if you have finished choosing settings and go to Step 7.
- 7 If you switched ON Real Time Transmission for the next fax only, enter the fax number and press **Fax Start**.

## Receive Mode Settings

### Select Receive Mode



There are four different receive modes for the machine. You may choose the mode that best suits your needs by pressing **Receive Mode** repeatedly until the screen displays the setting you want to use.

You'll need to connect an external telephone to select Fax/Tel (F/T) or Manual Mode.

Receive Mode	For
1. <b>FAX ONLY</b>	Use this function if you want to receive fax messages only (no telephone calls). The machine should be connected on its own line. The machine automatically answers every call as a fax call. You cannot receive a voice call, but, if you have connected an External telephone, you can still dial out and make voice calls. (This setting is recommended if the machine is on its own dedicated line.)
2. <b>FAX/TEL (F/T)</b>	Use this function if you expect to receive many fax messages and few phone calls. The machine automatically answers every call. If the call is a fax, it prints the fax. If the call is not a fax, it signals you with an F/T pseudo-ring, different from the phone company ringing, to alert you to pick up the call. If you select this setting, you'll need to set the Ring Delay and F/T Ring Time features (on the following pages).
3. <b>TAD:ANSWER MACH.</b> (with an External Answering Machine)	This is the only setting in which you can use an <b>external</b> answering machine. Your telephone answering device is connected to the machine, and answers every call. Once the external telephone answering device (TAD) answers, the machine listens for fax tones. If it detects fax tones, fax messages are printed.  The TAD setting works only with an external telephone answering device (TAD). Ring Delay and F/T Ring Time do not work in this setting.
4. <b>MANUAL</b>	Use this function if you receive many telephone calls and few fax messages. You must answer all calls yourself. If you hear fax tones, wait until the machine takes over the call automatically, then hang up (see Fax Detect function).

## To Select or Change Your Receive Mode

- 1 Press **Receive Mode**. The screen displays your current selection.
- 2 Press the key again and the next selection appears. After 2 seconds, the screen returns to the date and time display, along with your new Receive Mode setting.

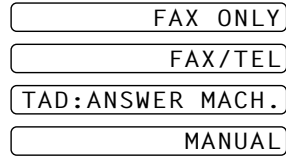

If you are changing the Receive Mode while in another operation, the screen returns to that operation.



Current Receive Mode . . . . .

FAX : FAX ONLY  
F / T : FAX/TEL  
TAD : EXTERNAL ANSWERING MACHINE  
MAN : MANUAL

## Setting the Ring Delay

The Ring Delay setting determines the number of times the machine rings before it answers in FAX ONLY or FAX/TEL mode. (See *Operation from an External or Extension Telephone*, page 38 and *For Fax/Tel Mode Only*, page 38.)

- 1 Press **Menu/Set, 2, 1, 1**.
- 2 Press or to select how many times the line rings before the machine answers (02-10 for Australia, 01-10 for New Zealand, 00 -10 for some countries.).
- 3 Press **Menu/Set** when the screen displays your selection.
- 4 Press **Stop/Exit**.

## Setting the F/T (Fax/Tel) Ring Time (Fax/Tel Mode Only)

You need to determine how long the machine will notify you with its special F/T pseudo-ring when you have a voice call. This ringing happens after the initial ringing from the phone company. Only the machine rings, for 20, 30, 40 or 70 seconds (for 20, 30, 40 or 55 seconds: Only for New Zealand) ; no other phones on the same line ring the special F/T pseudo-ring. However, you can answer the call on any extension phone (in a separate wall socket) on the same line as the machine. (See *Operation from an External or Extension Telephone*, page 38.)

- 1 Press **Menu/Set, 2, 1, 2**.
- 2 Press or to select how long the machine will ring to alert you that you have a voice call, and then press **Menu/Set**.
- 3 Press **Stop/Exit**.



Now, when a call comes in and the machine is set to Fax/Tel (F/T) Mode, all phones on this line will ring the number of times you selected in Ring Delay.

You can let the machine pick up and detect if it's a fax or voice call. If it's a fax call, the machine prints the fax. If it's a voice call, the machine signals you with an F/T pseudo-ring for the length of time you selected in F/T Ring Time.





Even if the caller hangs up during the F/T pseudo-ringing, the machine continues the F/T pseudo-ringing for the set time.

## Fax Detect (set ON by default)

When you use this feature, you don't have to press **Fax Start** when you answer a fax call and hear calling beeps. Just hold the handset and wait for several seconds. When you see **RECEIVING** on the fax screen or when you hear "chirps" through the handset of an extension phone connected to another wall socket, just replace the handset, and the machine does the rest. Selecting **ON** allows the machine to receive fax calls automatically, even if you lift the handset of an extension or external phone. Selecting **SEMI** lets the fax machine receive the call only if you've answered it at the machine. Selecting **OFF** means you'll have to activate the machine yourself, by pressing **Fax Start** or \* 5 1 (\* 9 1 for New Zealand) if you are not at the machine. (You have to set Remote Activation to **ON** in **Menu/Set, 2, 1, 4** to use \* 5 1 (\* 9 1 for New Zealand).) (See *Operation from an External or Extension Telephone*, page 38.)

In case Fax Detect does not work, because of a poor phone line connection, just press the Activation Code \* 5 1 (\* 9 1 for New Zealand).



- 1** Press **Menu/Set, 2, 1, 3**.
- 2** Use  or  to select **ON**, **SEMI** or **OFF** and press **Menu/Set**.
- 3** Press **Stop/Exit**.

# Receiving a Fax

## Printing a Reduced Incoming Document (Auto Reduction)

---

If you choose **ON**, the machine reduces an incoming document automatically, so that it fits on one page of A4 recording paper, regardless of the size of the original document.

- 1 Press **Menu/Set**, **2**, **1**, **5**. The screen displays
- 2 Use  or  to select **ON** (or **OFF**).
- 3 Press **Menu/Set** when the screen displays your selection.
- 4 Press **Stop/Exit**.

5 . AUTO REDUCTION



If you receive faxes that are split on two pages, change this setting **ON**.





- When you use Auto Reduction to reduce incoming documents to fit on one page of recording paper, you can do so only as long as the original document is not longer than 35 cm. If the original is longer than 35 cm, the data will not be reduced and will carry over to print on a second page.
- When you use Auto Reduction and you receive an incoming document that is smaller than your recording paper, no reduction will take place, and you will get the same size recorded as the original.

## Setting the Print Density

---

If the machine is printing too light or too dark, you can adjust the print density level. The new setting will remain until you change it again.

- 1 Press **Menu/Set**, **2**, **1**, **7**.
- 2 Press  or  to select your setting. Each key press changes the print density to the next setting.
- 3 When the screen shows the setting you want, press **Menu/Set**.
- 4 Press **Stop/Exit**.

## Reception into Memory

---



As soon as the multi-purpose sheet feeder becomes empty during fax reception, the screen will display “**CHECK PAPER**”; please put some paper in the multi-purpose sheet feeder. (See Brother Quick Setup Guide.)

### If the MEMORY RECEPTION switch is ON at this time...

The current fax reception will continue, with the remaining page(s) being stored in memory, subject to available memory. Subsequent incoming faxes will also be stored into memory until the memory is full, following with no further incoming fax calls will be automatically answered. To print all data, put fresh paper in the multi-purpose sheet feeder and press **Fax Start**.

### If the MEMORY RECEPTION switch is OFF at this time...

The current fax reception will continue, with the remaining page(s) being stored in memory, subject to available memory. Subsequent incoming fax calls will not be automatically answered until fresh paper is put in the multi-purpose sheet feeder. To print the last fax received, put paper in the multi-purpose sheet feeder and press **Fax Start**.

- 1 Press **Menu/Set, 2, 1, 6**.
- 2 Use  or  to select **ON** or **OFF**, and press **Menu/Set** when the screen displays your selection.
- 3 Press **Stop/Exit**.

## Printing a Fax from Memory

---

If you have fax storage ON for remote retrieval or fax forwarding, you can still print a fax from the machine's memory when you are at the machine: (See *Setting Fax Storage*, page 52.)

- 1 Press **Menu/Set, 2, 5, 4**.
- 2 Press **Fax Start**.
- 3 After all the data saved in the memory is printed out, press **Stop/Exit**.

# 4 Telephone (Voice) Operation

## Making Voice Calls

You can use your FAX/MFC to make voice telephone calls, by dialling manually or by using Search, One Touch (FAX 2850) or Speed Dial memory. When you dial an auto dial number, the screen displays the name you've stored, or if you haven't stored a name, the fax number you've stored.



You can also use Chain Dialling or Pause function. (See *Chain Dialling*, page 17 and *Pause*, page 26)



## Manual Dialling

Manual dialling is simply pressing all of the digits of the phone number.



- 1 Pick up the handset. —OR— Press **Hook**.
- 2 When you hear a dial tone, dial the number, using the dial pad.
- 3 If you pressed **Hook** to dial the call, pick up the handset when the other party answers. (The speaker works only one way; the other party won't be able to hear you unless you pick up the handset.)
- 4 To hang up, replace the handset.

## Search

You can search for names you have stored in One Touch (FAX-2850) and Speed Dial memories. (See *Storing One Touch Dial Numbers (For FAX-2850 Only)*, page 14 and *Storing Speed Dial Numbers* in Chapter 1.)

- 1 Press **Search/Speed Dial**, then enter the first letter of the name you're looking for.
- 2 Press  or  to search the memory.
- 3 When the screen displays the name you want to call, press **Fax Start** to begin dialling.
- 4 If you press **Hook** to dial the call, pick up the handset when the other party answers. (The speaker works only one way; the other party won't be able to hear you unless you pick up the handset.)
- 5 When the call is over, hang up.



You can also use  or  key to search the numbers you have stored in memory in numerical order of registration. In that case, do not enter the first letter of the name in Step 2.

## One Touch Dialling (For FAX-2850 Only)

- 1 Pick up the handset. —OR— Press **Hook**.
- 2 When you hear a dial tone, press the One Touch key of the location you want to call. To use One Touch dial numbers 5-8 hold down **Shift** and press the appropriate One Touch Dial key.
- 3 If you pressed **Hook** to dial the call, pick up the handset when the other party answers. (The speaker works only one way; the other party won't be able to hear you unless you pick up the handset.)

- 4 To hang up, replace the handset.



If you try to use a One Touch location with no number stored in it, you hear a warning sound, and screen displays **NOT ASSIGNED**. The display returns to normal after 2 seconds.

## Speed Dialling

---

- 1 Pick up the handset. —**OR**— Press **Hook**.
- 2 When you hear a dial tone, press **Search/Speed Dial**, press **#**, and then press the two-digit Speed Dial number. (See *Storing Speed Dial Numbers*, page 15.)
- 3 If you pressed **Hook** to dial the call, pick up the handset when the other party answers. (The speaker works only one way; the other party won't be able to hear you unless you pick up the handset.)
- 4 To hang up, replace the handset.



If you are sending a fax, press **Fax Start** after pressing the Speed Dial number. If you picked up the handset, press **Fax Start** when the receiving fax machine answers with fax tone.

## Hold

---

- 1 Press **Hold** to put a call on Hold.
- 2 You can put down the handset without disconnecting the call.
- 3 Pick up the FAX/MFC handset to release the call from hold. Picking up an extension handset will not release the call from Hold.

## Pause

---

Press **Redial/Pause** to insert a 3.5 second pause between numbers. If you are dialing overseas, you can press **Redial/Pause** as many times as needed to increase the length of the pause.

## On Hook Dialling

---

- 1 Dial the number by using the dial pad or One Touch Dial key (FAX 2850), or Speed Dial and **#** then two-digit Speed Dial number.
- 2 The number you are dialling, or the name you have stored for One Touch or Speed Dial is displayed on the LCD.
- 3 Press **Fax Start**.
- 4 Pick up the handset when you hear the other end from the monitor speaker.



When you make a call by pressing **Fax Start** after dialling, you can listen to the other end of the line from the monitor speaker, but they can't hear you unless you pick up the handset.

If you accidentally press **Hook** before lifting the handset, the call will be disconnected.

## Tone/Pulse (Not available in New Zealand)

---

If you have pulse dialling service, but need to send tone signals (for telephone banking, for example), follow the directions below. If you have touch tone service, you do not need this feature to send tone signals.

- 1** Lift the handset.
- 2** Press #. Any digits dialled after this sends tone signals.
- 3** When you hang up, FAX/MFC returns to pulse dialling service.

## Fax/Tel (F/T) Mode

---

When you share one line for your telephone and fax machine, in the Fax/Tel (F/T) Mode, the fax machine can determine whether an incoming call is a fax or a telephone call. (See *Select Receive Mode*, page 20.)

## Hook Key

---

If you press **Hook** when you are talking lifting the handset with the other end, you can hear the other end from machine's monitor speaker, but the other end cannot hear you.

## Transmission Report and Journal Setting

Two reports require initial setup in the Menu table: Transmission Verification Report and Journal Period. For initial setup:

Press **Menu/Set, 2, 4, 1.**

1. TRANSMISSION

—OR—

Press **Menu/Set, 2, 4, 2.**



2. JOURNAL PERIOD

### Customizing the Transmission Verification Report

You can use the Transmission Report as confirmation that you sent a fax. This report lists the name or fax number of the receiving party, the time and date of transmission, and if the transmission was successful.





When the feature is **OFF**, the report is printed automatically only if an error occurred during transmission. If the report indicates **ERROR**, send the document again. If the report indicates you should check the readability of certain pages, resend those pages.

If you typically send multiple faxes to the same destinations, you may need a reminder to identify each fax transmission. You can select **OFF+IMAGE** or **ON+IMAGE** to print a portion of the first page of the fax message on the report.

- 1 Press **Menu/Set, 2, 4, 1.**
- 2 Press  or  to select **OFF**, **OFF+IMAGE**, **ON** and **ON+IMAGE**.
- 3 Press **Menu/Set.**
- 4 Press **Stop/Exit.**

### Setting the Journal Period

You can set the machine to print activity reports at specific intervals (1, 3, 6, 12, 24 hours, 2, 4 or 7 days). If you set the interval to **OFF**, you can print the report by following the steps in the next section.

- 1 Press **Menu/Set, 2, 4, 2.**
- 2 Press  or  to choose your setting, and then press **Menu/Set.** If you choose 7 days, the screen prompts you to choose a day at which to begin the 7-day countdown. Press  or  to choose your setting and press **Menu/Set.**
- 3 Enter the time to begin printing, in 24-hour format (for example, enter 19:45 for 7:45 PM), and press **Menu/Set.**
- 4 Press **Stop/Exit.**

# Using the Reports Key

Six lists are available.

1. HELP

Lists basic operational steps and functions.

2. QUICK-DIAL

Lists names and numbers stored in Speed Dial memory, in numerical order.

3. JOURNAL

Journal lists information about the last 200 incoming and outgoing faxes. TX means Transmit; RX means Receive.

4. XMIT VERIFY

Prints a Transmission Verification Report for your last transmission.

5. SYSTEM SETUP



Lists settings for **GENERAL SETUP**, **SETUP RECEIVE**, **SETUP SEND**, **REPORT SETTING**, **REMOTE FAX OPT** and **MISCELLANEOUS**.

6. ORDER FORM

You can print an accessories order form to your Brother dealer for service.

## To Print a Report

**1** Press **Reports**.

**2** Press  or  to select the report you want, and then press **Menu/Set**.  
—OR—

Enter the number of the report you want to print. For example, press **1** to print the Help List.



## Advanced Operations

### Electronic Cover Page

The cover page is sent to the receiving party's machine. Your cover page includes the name stored in the One Touch (FAX-2850) or Speed Dial memory, if you have used this feature to start the call. The cover page indicates the fax is from your Station ID, and the number of pages you're sending. If you have **COVERPG SETUP** set to **ON** (Function menu 2-2-7), the number of pages remains blank.

You can select a comment to include on your cover page, or you can select **1.NOTE OFF** if you do not wish to include a comment. (See *Entering Text*, page 147.)

As well as using one of the comments above, you can also enter up to two customized messages, each 27 characters long. (See *Composing Your Own Comments*, page 31.)

1. NOTE OFF

2. PLEASE CALL





3. URGENT

4. CONFIDENTIAL

### Cover Page for Next Fax Only

Make sure Station ID is set up. (See *Setting the Station ID*, page 11.) This feature does not work without the Station ID.





You can set the machine to send a cover page with a particular document. This cover page will include the number of pages in your document.

- 1 Insert the document face down in the ADF.
- 2 Press **Menu/Set**, **2**, **2**, **7**.
- 3 Press **Menu/Set** when the screen displays **NEXT FAX ONLY**.
- 4 Press  or  to select **ON** (or **OFF**), and press **Menu/Set**.
- 5 Press  or  to view the comment selections.
- 6 Press **Menu/Set** when the screen displays your selection.
- 7 Enter two digits to indicate the number of pages you are sending. (Enter 00 to leave the number of pages blank.) If you make a mistake, press  to back up and re-enter the number of pages.
- 8 Press **Menu/Set**. The screen prompts you to continue.
- 9 Press **1** if you want to select additional settings. The display returns to the **SETUP SEND** menu—**OR**—Press **2** if you have finished choosing settings, and go to Step 10.
- 10 Enter the fax number and then press **Fax Start**.

## Always Send Cover Page



Make sure Station ID is set up. (See *Setting the Station ID*, page 11.) This feature does not work without the Station ID.

You can set the machine to send a cover page whenever you send a fax. The number of pages in your fax is not included when you use this setting.



- 1 Press **Menu/Set, 2, 2, 7**.
- 2 Press  or  to select **ON** or **OFF**.
- 3 Press **Menu/Set** when the screen displays **COVERPAGE:ON**. (If you select **ON**, a coverpage is always sent when you send a fax.)
- 4 If you selected **ON**, the screen displays the cover page comment options. Press  or  to view comment selections.
- 5 Press **Menu/Set** when the screen displays your selection. The screen prompts you to continue.
- 6 Press **1** if you want to select additional settings. The display returns to the **SETUP SEND** menu—**OR**—Press **2** to exit if you have finished choosing settings.

## Using a Printed Cover Page

If you prefer using a printed cover page that you have write on, you can print the sample page and attach it to your fax.

- 1 Press **Menu/Set, 2, 2, 7**.
- 2 Press  or  to select **PRINT SAMPLE**, and press **Menu/Set** when the screen displays your selection.
- 3 Press **Fax Start**. The machine prints a copy of your cover page.
- 4 Press **Stop/Exit**.

## Composing Your Own Comments



- 1 Press **Menu/Set, 2, 2, 8**. The screen displays: **COVERPAGE NOTE**.
- 2 Use  or  to choose position 5 or 6 for your customized comment, and press **Menu/Set**.
- 3 Use the dial pad to enter your customized comment. (See *Entering Text*, page 147.)
- 4 Press **Menu/Set**. The screen prompts you to continue
- 5 Press **1** if you want to select additional settings. The display returns to the **SETUP SEND** menu—**OR**—Press **2** to exit.

## Overseas Mode

---

Sometimes, when sending a fax to overseas numbers, problems can be experienced. This mode makes the machine work better for such calls.

After you send a fax using this feature, the feature turns itself off.

- 1 Insert the document face down in the ADF.
- 2 Press **Menu/Set, 2, 2, 9**.
- 3 Press  or  to select **ON** (or **OFF**), and press **Menu/Set** when the screen displays your selection.
- 4 Press **1** if you want to select additional settings. The display returns to the **SETUP SEND** menu—**OR**—Press **2** if you have finished choosing settings and go to Step 5.
- 5 Enter the fax number you're calling, and press **Fax Start**.

## Delayed Transmission (Timer)



---

You can use this function to send a fax up to 24 hours later.

- 1 Insert the document face down in the ADF.
- 2 Press **Menu/Set, 2, 2, 3**.
- 3 Enter the time you want the fax to be sent, in 24-hour format (for example, enter 19:45 for 7:45 PM), and press **Menu/Set**.
- 4 Press **1** to select **DOC**—**OR**—Press **2** to select **MEMORY**. If you select **1.DOC**, the machine will not start scanning the document until the preset time. The document must be left in the ADF.
- 5 Press **1** if you want to select additional settings. The display returns to the **SETUP SEND** menu—**OR**—Press **2** if you have finished choosing settings and go to Step 6. The screen prompts you to enter the fax number.
- 6 Enter the fax number, and press **Fax Start**. The machine will wait until the time you have entered to send the fax.

## Delayed Batch Transmission

Before sending the delayed faxes, your Brother machine will economize by sorting all the documents in memory by destination and scheduled time. If you set Batch Transmission to **ON**, all delayed faxes scheduled at the same time to the same fax number will be sent as one transmission.

- 1 Press **Menu/Set, 2, 2, 4**.
- 2 Press  or  to select **ON** (or **OFF**) and press **Menu/Set**.
- 3 Press **Stop/Exit**.

## Broadcasting

---

Broadcasting is automatically sending the same fax message to multiple fax numbers. Using the **Menu/Set** key, you can include up to 8 One Touch locations (FAX-2850), up to 100 Speed Dial locations, and up to 50 manually dialled numbers (maximum of 158 (FAX-2850) or 150 (MFC-4800) locations if you did not use up any locations for Groups, access codes or credit card numbers). However, available memory will vary with the types of jobs in memory and numbers of locations used for broadcasting. If you broadcast to more than the maximum locations available, you will not be able to setup transmissions using dual access and the timer.

The easiest way to broadcast is to first combine frequently used One Touch (FAX-2850) and Speed Dial numbers as a Group, which uses up a One Touch key (FAX-2850) or a Speed Dial #. (Remember, you can have up to six Groups and Quick Dial numbers can be included in more than one Group). Then by pressing **Menu/Set** between each location, you can include One Touch (FAX-2850), Speed Dial, Groups, and manual dialling (using the dial pad) in the same broadcast. Use the **Search/Speed Dial** to help you choose the numbers easily.

After the broadcast is completed, a Broadcast Report will be printed automatically to let you know the results.

- 1 Insert the document face down in the ADF.
- 2 Enter a number using One Touch (FAX-2850), Speed Dial, Search, Group number or the dial pad.  
Example: Group number
- 3 Press **Menu/Set**. You will be prompted to enter the next number.
- 4 Enter the next number.  
Example: Speed Dial
- 5 Press **Menu/Set**.
- 6 Enter the next fax number.  
Example: Manual dialling, using the dial pad.
- 7 Press **Fax Start**.

The machine will read the documents into memory and then start sending faxes to all the numbers you entered.



- To stop the broadcasting in progress, press **Stop/Exit**. The display asks if you want to cancel all locations or just the location that is being sent to.
- Enter the long dialling sequence numbers as you normally would, but keep in mind that each key counts as one location, so the number of locations you can call becomes limited.
- If the line is busy or a connection could not be made for some other reasons while broadcasting, the machine will redial the number automatically.
- If the memory is full, press **Stop/Exit** to abort the job or press **Fax Start** to send the portion that is in the memory (if more than one page has been scanned).

## Setting Up Groups for Broadcasting

Groups allow you to send the same fax message to many fax numbers by pressing only one One Touch Group key and **Fax Start** (FAX-2850) or five keys (**Search/Speed Dial**, #, the two-digit location, and **Fax Start**). You can store up to six of the Groups on your One Touch keys (FAX-2850) or Speed Dial, and then broadcast by pressing only the One Touch key (FAX-2850) or **Search/Speed Dial**, #, the two-digit location (and **Fax Start**). **First**, you'll need to store each fax number as a One Touch or Speed Dial number. Then, you can combine them into a Group. Each Group uses up a One Touch or Speed Dial number. You can have up to six Groups, or you can assign up to 107 (FAX-2850) or 99 (MFC-4800) numbers to one large Group. (See *Storing One Touch Dial Numbers (For FAX-2850 Only)*, page 14 and *Storing Speed Dial Numbers*, page 15.)

- 1 For the FAX, press **Menu/Set**, **2**, **3**, **3**.  
For the MFC, press **Menu/Set**, **2**, **3**, **2**.

For FAX-2850, LCD shows



For MFC-4800, LCD shows



- 2 *Storing the Group as a Speed Dial Number.*

Press **Search/Speed Dial**, and then enter the two-digit location where you wish to store the Group number, and then press **Menu/Set**.

(For example, press **Search/Speed Dial**, **07**.)

—OR—

*Storing the Group on a One Touch key.*

For the FAX-2850, press a One Touch key where you wish to store the Group number, and then press **Menu/Set**.

(For example, press One Touch key **2**.)

- 3 Use the dial pad to enter the Group number, and then press **Menu/Set**.

(For example, press **1** for Group 1.)

- 4 To include One Touch or Speed Dial numbers in the Group, enter them as if you were dialling. For example, for One Touch Dial key **5**, press One Touch Dial key **5**.

For Speed Dial location 09, press

**Search/Speed Dial**, then press **0**, **9** on the dial pad.

The LCD shows \*05, #09.

- 5 Press **Menu/Set**. The screen prompts you to enter a name.

- 6 Use the dial pad to enter a name for the group (for example, NEW CLIENTS) and press **Menu/Set**. (See *Entering Text*, page 147.)

- 7 Press **Stop/Exit**.



You can print a list of all One Touch and Speed Dial numbers. Group numbers will be marked in the column of "**GROUP**". (See *Printing Reports*, page 28.)

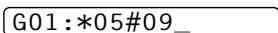

## Cancelling a Job While Scanning the Document

---



You can cancel a job while you are scanning it into memory by pressing **Stop/Exit**. Eject the document by pressing **Stop/Exit** again.

## Checking and Cancelling a Scheduled Job in Memory

---

You can check or cancel a job that is waiting in memory.

If the machine is idle,

- 1 Press **Menu/Set, 2, 6**.  
Any waiting jobs appear on the display. If nothing is waiting, the screen displays **NO JOB WAITING**.
- 2 If you have more than two jobs waiting, use  or  to select the job you want to cancel. Press **Menu/Set** when the screen displays your selection—**OR**—If you have only one job waiting, go to Step 3.
- 3 Press **1** to cancel—**OR**—Press **2** to exit without cancelling.  
To cancel another job, return to Step 2.
- 4 Press **Stop/Exit**.



- You can check which jobs are remaining in memory by following Steps 1 and 2 above.

## Memory Security

---

This feature allows you to prevent unauthorised access to the machine. When switched ON, Memory Security prohibits most functions. The following functions listed are available while Memory Security is switched ON.

- Receiving faxes into memory [limited by Memory Capacity].
- Scheduled Delayed Transmission\*
- Polling\*
- Fax Forwarding\*
- Remote Retrieval



\* Provided it was set before Memory Security was switched ON.

## Using Memory Security

---

You must use a password to switch Memory Security ON and OFF.

### Setting Up Memory Security for the First Time

- 1 Press **Menu/Set, 2, 0, 1**.
- 2 Enter a 4-digit number as a password.
- 3 Press **Menu/Set**.  
The screen prompts you to re-enter the password.
- 4 Re-enter the password and press **Menu/Set**.
- 5 Press  or  to choose **SET SECURITY**.
- 6 Press **Menu/Set**.

NEW PASSWD:XXXX

VERIFY:XXXX

The screen prompts you to enter the password.

PASSWORD : XXXX

- 7 Enter a 4-digit password, followed by **Menu/Set**.

This is the same as the security password of the machine already stored.



The screen displays **ACCEPTED** for 2 seconds, followed by **SECURE MODE** - Memory Security is now switched ON.



If the password you enter at Step 7 is incorrect, the screen would display **WRONG PASSWORD**. After 2 seconds the display will then return to normal (displaying the date & time). You must then start from Step 5 to set Memory Security.

### Changing the Memory Security Password

- 1 Press **Menu/Set, 2, 0, 1**.

- 2 Press  or  to choose **SET PASSWORD**.

- 3 Press **Menu/Set**.

The screen prompts you to enter the old password.

OLD PASSWD : XXXX

- 4 Enter the current password.

- 5 Press **Menu/Set**.

NEW PASSWD : XXXX

- 6 Enter a 4-digit number as a new password.

- 7 Press **Menu/Set**.

The screen prompts you to re-enter the new password.



VERIFY : XXXX

- 8 Enter the new password again and press **Menu/Set**.

- 9 Press **Stop/Exit**.

### Switching Memory Security ON

- 1 Press **Menu/Set, 2, 0, 1**.

- 2 Press  or  to choose **SET SECURITY**.

- 3 Press **Menu/Set**.

The screen prompts you to enter the password.

PASSWORD : XXXX

- 4 Enter a 4-digit password, followed by **Menu/Set**.

This is the same as the security password of the machine already stored.

The screen displays **ACCEPTED** for 2 seconds, followed by **SECURE MODE** - Memory Security is now switched ON.



If the password you enter at Step 4 is incorrect, the screen would display **WRONG PASSWORD**. After 2 seconds the display will then return to normal (displaying the date & time). You must then start from Step 1 to set Memory Security.

## Switching OFF Memory Security

- 1 When Memory Security is switched ON, press **Menu/Set**.

PASSWORD : XXXX

- 2 Enter a 4-digit password and press **Menu/Set**.

The screen displays **ACCEPTED**, then after 2 seconds the display reverts to normal. Memory Security is now switched OFF. Then all the data saved in the memory will be printed out.



If the password you enter at Step 2 is incorrect, the screen would display **WRONG PASSWORD**. After 2 seconds the display will then return to displaying **SECURE MODE**. You must then start from Step 1 to switch OFF Memory Security.

If you forget the Memory Security password, please contact your Brother dealer for service or the help number given with the warranty documentation.



## Operation from an External or Extension Telephone

An external phone is a telephone that is plugged into the machine (either into the machine's EXT socket or into the back of the connector that plugs into the telephone wall socket).

An extension phone is another phone on the same phone number as the machine, but plugged into a different telephone wall socket. For example, the machine may be connected to a phone line in your study, and you may have another phone on the same line (and same phone number) in your kitchen. This feature enables you to answer the phone in the kitchen if it rings while you are making a coffee, knowing that you can transfer the call to the machine if the incoming call is a fax.

If you answer a fax call on an external or extension phone, you can make the machine take over by using the Activation Code. When you press the Activation Code \* 5 1 (\* 9 1 for New Zealand), the machine starts to receive a fax. If you set FAX DETECT to ON, you don't have to press \* 5 1 (\* 9 1 for New Zealand), just hold the handset and wait for several seconds. (See *Fax Detect (set ON by default)*, page 22.)

If the machine answers a voice call and F/T pseudo-rings for you to take over, use the Deactivation Code # 5 1 (# 9 1 for New Zealand) to take the call at an extension phone. The Deactivation Code is used only in Fax/Tel (F/T) Mode. (You have to set Remote Activation to ON in **Menu/Set, 2, 1, 4** to use \* 5 1 or # 5 1 (\* 9 1 or # 9 1 for New Zealand).)

If you answer a call, and no one is on the line, assume you're receiving a fax. At an extension phone, press \* 5 1 (\* 9 1 for New Zealand), wait for fax receiving tones (chirps), then hang up. At an external phone, press \* 5 1 (\* 9 1 for New Zealand) and wait for the phone to be disconnected (the screen displays **RECEIVING**) before you hang up. (Your caller will have to press Start to send the fax.)



If you accidentally pick up an extension phone when a fax message is being received, you may disrupt the transmission or render some portions unreadable.

The Remote Activation Code can also be used by your callers. When you are using an external TAD, your outgoing message (OGM) should end with the statement "to send a fax, press \* 5 1 (\* 9 1 for New Zealand)". (See *Outgoing Message (OGM) of External TAD*, page 6.)

### For Fax/Tel Mode Only

When the machine is in Fax/Tel (F/T) Mode, it will use the F/T Ring Time (F/T pseudo-ringing) to alert you to a voice call. If you're at the machine, you can lift the handset to answer.

If you're at an extension phone, you'll need to lift the handset during the F/T Ring Time and press # 5 1 (# 9 1 for New Zealand) between the F/T pseudo-rings. If no one is on the line, or if someone wants to send you a fax, send the call back to the machine by pressing \* 5 1 (\* 9 1 for New Zealand).

## Switching ON Remote Activation and Changing Remote Codes



---

Remote Codes might not work with some telephone systems. The preset Activation Code is \* 5 1 (\* 9 1 for New Zealand). The preset Deactivation Code is # 5 1 (# 9 1 for New Zealand).



If you are always disconnected when accessing your external TAD remotely, try changing the Activation Code from \* 5 1 (\* 9 1 for New Zealand) to # # # and the Deactivation Code from # 5 1 (# 9 1 for New Zealand) to 1 1 1. You cannot use the same number for the Activation Code, the Deactivation Code and the Remote Access Code.

### To switch Remote Activation ON and change Remote Codes

- 1** Press **Menu/Set, 2, 1, 4**.
- 2** Press  or  to select **ON** (or **OFF**), and press **Menu/Set** when the screen displays the setting you want.
- 3** If you want to, enter a new Remote Activation Code, then press **Menu/Set**.
- 4** If you want to, enter a new Remote Deactivation Code, then press **Menu/Set**.
- 5** Press **Stop/Exit**.

## Telephone Service for Australia

### Distinctive Ringing

This machine feature lets you use the Distinctive Ringing subscriber service offered by Telstra's FaxStream® Duet, which allows you to have at least two separate telephone numbers on the phone line. Each phone number has its own Distinctive Ringing pattern, so you know which phone number is ringing. This is one way you can have a separate phone number for your FAX/MFC.

Your FAX/MFC has a Distinctive Ringing function, allowing you to dedicate one phone number just for receiving faxes.





You can switch it off temporarily, then turn it back on. When you get a new fax number, make sure you reset this function.



- To have your external TAD answer only the main number, the machine must be in **Manual Mode**.
- In **FAX/TEL (F/T)** or **FAX ONLY** mode, the machine will answer all numbers on the phone line.

### Set the Distinctive Ringing to ON

- 1 Disconnect the FAX/MFC from any TAD or telephone company voice mail.
- 2 Set the FAX/MFC to Manual Mode.
- 3 Press **Menu/Set, 2, 0, 2**. The screen displays the current setting of this feature.
- 4 Press  or  to select **ON** (or **OFF**).
- 5 Press **Menu/Set**.
- 6 Press **Stop/Exit**.

### Caller ID (Caller Identification)

Caller ID is a telephone service that allows the subscriber to see a display of the caller's phone number or name as the telephone rings. It is a fast way to screen your calls. You can respond quickly to calls you missed, because Caller IDs are received and stored in your FAX/MFC memory.



- To get the Caller ID Service: apply for the Caller ID service at your local telephone company, if available.

## Advantages of Caller ID

### For Business

All businesses profit from a quicker response to customer calls. Businesses that provide mail order services, money-lending services or provide confidential information, can protect themselves from false orders or acceptance of false identification.

### At Home

Residential customers can protect themselves from unwanted calls.

## How Does the Caller ID Work?

---

### The Caller ID Appears on the Display When Your Telephone Rings

As your telephone rings, the display shows you the caller's phone number or name. Once you pick up the handset, the caller's ID disappears. You will see up to the first 16 characters of the number on the display.

### Helpful Hints

- If **OUT OF AREA** appears on the display, it means that the call came from outside your caller ID service area or a public phone. \*
- If **PRIVATE CALL** appears on the display, it means the caller intentionally blocked the transmission of his/her ID. \*
- If no caller ID was transmitted to your fax machine, **PICK UP PHONE** will remain on the display.

\* Depends on network Function.

## The Caller ID is Stored in Your Machine's Memory

---

The FAX/MFC can store a maximum of the last 30 incoming caller IDs in the memory, along with the time and date of reception. The 31st call will cause the oldest ID to be erased.

The Caller ID information stored in the memory can be used for the following.







### ■ Printing the Caller ID List.

You can review calls you received by checking the Caller IDs in memory. This report will list the Date, Time, Phone Number (Caller ID), and type of Call (Comment).



## Viewing Caller ID List

---

Caller ID memory stores information for up to thirty calls; when the thirty-first call comes in, information about the first call is erased. You can scroll through Caller ID information to review those calls made to your FAX/MFC.

- 1** Press **Menu/Set**, **2**, **0**, **3**.
- 2** Press  or  to select **DISPLAY #** and press **Menu/Set**.  
If the name was not received, it will not be displayed.
- 3** Press  or  to scroll through the Caller ID memory to select the Caller ID you want to view and press **Menu/Set**.  
The next screen shows the caller's telephone number and the date and time of the call.
- 4** Press  or  to return to the Caller ID listing —**OR**— Press **Stop/Exit** to exit.

## Printing Caller ID List

- 1** Press **Menu/Set, 2, 0, 3**.
- 2** Press  or  to select **PRINT REPORT**.
- 3** Press **Menu/Set**.
- 4** Press **Fax Start**.

# Telephone Service for New Zealand

## FaxAbility

---

FaxAbility is a service offered by Telecom that allows you to have an additional number on one phone line, with its own distinctive ring pattern. This way, when you get an incoming call, you can identify the number being called by its ring.

### How Will the Fax Machine Treat All Other Numbers?

FaxAbility mode ensures that the machine will answer calls to the FaxAbility (secondary) number. When a call comes in to your main number, all the phones will ring. You can set an external answering device (TAD) to answer calls on the other number(s). (See the chart in the following page.)

If you change the answer mode on the fax machine to FAX/TEL (F/T) or FAX ONLY mode, that setting will override the FaxAbility setup. **In FAX/TEL (F/T) or FAX ONLY mode, your fax machine will answer all the phone numbers (including its own ring pattern).**

### What is the Advantage of Using the FaxAbility Function?

Using FaxAbility is the most efficient way to receive both fax and telephone calls on the same line. It is much easier for your callers who dial manually. The fax machine will answer with receiving tones so they will not have to press an activation code. And the people who call to talk on your main number, will not have to talk to your fax machine. Basically, it gives you two independent numbers without the higher cost of a second line.

### How Does FaxAbility Work?

Your telephone number will have the standard ring pattern of long, long tone, while the new number will have a ring pattern of long, silence, long, etc. When FaxAbility is **ON**, you will not hear the first ring of all incoming calls on the fax machine. Extension phones will ring as usual. If the fax machine recognizes the ring pattern, all ringing will stop and the fax machine will answer and automatically receive the fax message. Otherwise, you will hear the extension phones and the fax machine continue to ring. The fax machine always listens to the ring pattern before it answers, so do not pick up the phone during that time. You will quickly learn to recognize the ring pattern for faxes, so you will not be tempted to answer that number. Either you or a telephone answering device can answer the main number(s).

## Flowchart Sequence of Incoming Call

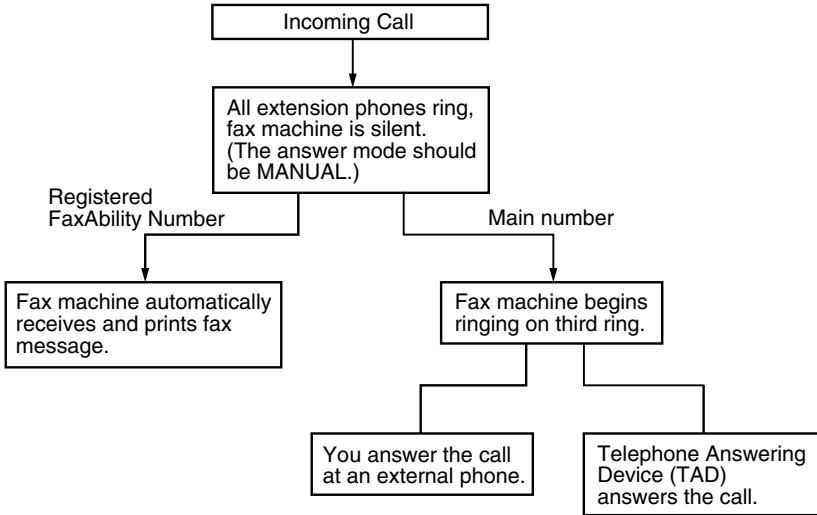

### How to Turn FaxAbility OFF or ON

The FaxAbility function is designed to accommodate the FaxAbility service provided by Telecom. To change the setting, repeat Steps 1-3; Step 2 is where you can select either **ON** or **OFF**.

Call Waiting beeps caused by incoming calls on your main number can affect fax transmissions.

If you have FaxAbility Service but don't have Call Waiting you need do nothing at this stage.



If you do have Call Waiting as well as FaxAbility, set the Call Waiting menu option to **ON**. See below.

Your FaxAbility service automatically suspends Call Waiting when incoming faxes are being sent to you.

- 1** Press **Menu/Set, 2, 0, 2.**

The screen displays

2. FAXABILITY

- 2** Press  or  to select **ON** (or **OFF**).

FAXABILITY: OFF

FAXABILITY: ON

- 3** Press **Menu/Set.**

Only when FAXABILITY is set **ON**, Call Waiting can be selected **ON**.

In case of FAXABILITY is set **OFF**, Call Waiting is automatically **OFF** without choice.

CALL WAITING: OFF

- 4** Press **Menu/Set.**

- 5** Press **Stop/Exit.**

# Caller ID (Caller IDentification)

Caller ID is a telephone service that allows the subscriber to see a display of the caller's phone number as the telephone rings. It is a fast way to screen your calls. You can respond quickly to calls you missed, because Caller IDs are received and stored in your machine's memory.



- To get the Caller ID Service: apply for the Caller ID service at your local telephone company, if available.

## Advantages of Caller ID

### For Business

All businesses profit from a quicker response to customer calls. Businesses that provide mail order services, money-lending services or provide confidential information, can protect themselves from false orders or acceptance of false identification.

### At Home

Residential customers can protect themselves from unwanted calls.

## How Does the Caller ID Work?

---

### The Caller ID Appears on the Display When Your Telephone Rings

As your telephone rings, the display shows you the caller's phone number. Once you pick up the handset, the caller's ID disappears. You will see up to the first 16 characters of the number on the display.

### Helpful Hints







- If **OUT OF AREA** appears on the display, it means that the call came from outside your caller ID service area. \*
- If **PRIVATE CALL** appears on the display, it means the caller intentionally blocked the transmission of his/her ID. \*
- If no caller ID was transmitted to your fax machine, **PICK UP PHONE** will remain on the display.

\* Depends on network Function.





## Viewing Caller ID List

Caller ID memory stores information for up to thirty calls; when the thirty-first call comes in, information about the first call is erased. You can scroll through Caller ID information to review those calls made to your FAX/MFC.

- 1 Press **Menu/Set, 2, 0, 3.**
- 2 Press  or  to select **DISPLAY #** and press **Menu/Set.**  
If the name was not received, it will not be displayed.
- 3 Press  or  to scroll through the Caller ID memory to select the Caller ID you want to view and press **Menu/Set.**  
The next screen shows the caller's telephone number and the date and time of the call.
- 4 Press  or  to return to the Caller ID listing —OR— Press **Stop/Exit .**

## Printing Caller ID List

- 1 Press **Menu/Set, 2, 0, 3.**
- 2 Press  or  to select **PRINT REPORT.**
- 3 Press **Menu/Set.**
- 4 Press **Fax Start.**



If you use the Caller ID for Dial back...

- Please be sure that you use appropriate dialling procedures for local and national call.
- Please be sure that you make sure of the details of the exact number to be called back, and the need to insert prefix(es) for manual dialling.
- Please understand that your machine may not display precisely the digits to be called.

# Telephone Service for Some Countries

## Distinctive Ringing (For Singapore and Hong Kong)

---

This FAX/MFC feature lets you use the Distinctive Ringing subscriber service offered by some telephone companies, which allows you to have several telephone numbers on one phone line. Each phone number has its own Distinctive Ringing pattern, so you'll know which phone number is ringing. This is one way you can have a separate phone number for your FAX/MFC.



Your FAX/MFC has a Distinctive Ringing function, allowing you to dedicate one phone number just for receiving faxes. You'll need to set Distinctive Ringing to ON.



You can switch it off temporarily, then turn it back on. When you get a new fax number, make sure you reset this function.

- The FAX/MFC will answer only calls to the Distinctive Ringing number.
- To have your external TAD answer only the main number, the FAX/MFC must be in Manual Mode.
- In FAX/TEL (F/T) or FAX ONLY mode, the FAX/MFC will answer all numbers on the phone line.

### Setting the Distinctive Ringing

- 1 Set the FAX/MFC to MANUAL mode.
- 2 Press **Menu/Set, 2, 0, 2**.
- 3 Press  or  to select **ON** (or **OFF**).
- 4 Press **Menu/Set**.
- 5 Press **Stop/Exit**.

## Caller ID (For Singapore and Hong Kong)

---

The Caller ID feature of this machine lets you use the Caller ID subscriber service offered by many local phone companies. This service provides you, by means of the screen display, the telephone number (or name) of your caller as the line rings. (See *Printing Caller ID List*, page 48.)

After a few rings, the screen displays the telephone number of your caller (or name, if available). Once you pick up the handset, the Caller ID information disappears from the screen, but the call information remains stored in the Caller ID memory.

- You will see the first 16 characters of the number or name.
- **OUT OF AREA** display means call originates outside your Caller ID service area.
- **PRIVATE CALL** display means the caller has intentionally blocked transmission of information.
- **CALL PICKUP** display remains on the screen when no Caller ID information was transmitted.









If both the name and number are received, the screen displays only the name.

You can print a list of Caller ID information received by your machine.

Caller ID service varies with different carriers. Call your local phone company to determine the kind of service available in your area.

## Viewing Caller ID List

Caller ID memory stores information for up to thirty calls; when the thirty-first call comes in, information about the first call is erased. You can scroll through Caller ID information to review those calls made to your machine.

- 1** Press **Menu/Set, 2, 0, 3**.
- 2** Press  or  to select **DISPLAY #?** and press **Menu/Set**.  
If the name was not received, it will not be displayed.
- 3** Press  or  to scroll through the Caller ID memory to select the Caller ID you want to view and press **Menu/Set**.  
The next screen shows the caller's telephone number and the date and time of the call.
- 4** Press  or  to return to the Caller ID listing—**OR**—Press **Stop/Exit**.

## Printing Caller ID List

- 1** Press **Menu, 2, 0, 3**.
- 2** Press  or  to select **PRINT REPORT?** and press **Menu/Set**.
- 3** Press **Fax Start**.

# 9 Polling



Polling is the process of retrieving faxes from another machine. You can use the machine to “poll” other machines, or you can have someone poll the machine.

All parties involved in polling need to set up their machines to accommodate polling. When someone polls the machine to receive a fax, they pay for the call; if you poll someone’s fax machine to receive a fax, you pay for the call. (See *Polling Transmit*, page 51.)





**Some machines do not respond to the polling function.**

## Polling Receive

Polling Receive is when you call another fax machine to receive a fax from it.

### Setup for Polling Receive (Standard)

---

- 1 Press **Menu/Set, 2, 1, 8**.
- 2 Press  or  to choose **STANDARD**, and press **Menu/Set**.
- 3 Enter the fax number you are polling, and press **Fax Start**.  
The screen displays **DIALING #XXX**.

ENTER FAX NO.

### Secure Polling



---

Secure Polling is a way to keep your documents and others’ from falling into the wrong hands while the fax machines are set up for polling. You can use Secure Polling only with another Brother fax machine. Your four-digit secure code must be entered on the machine that polls for your documents.

### Setup for Polling Receive with Secure Code

---



You need to make sure you are using the same secure code as the other party.

- 1 Press **Menu/Set, 2, 1, 8**.
- 2 Press  or  to choose **SECURE**, and press **Menu/Set**.
- 3 Enter a four-digit secure code.  
This is the same as the security code of the fax machine you are polling.
- 4 Press **Menu/Set**.
- 5 Enter the fax number you are polling.
- 6 Press **Fax Start**.

ENTER FAX NO.

## Setup Delayed Polling Receive

You can set the machine to begin Polling Receive at a later time.

- 1 Press **Menu/Set, 2, 1, 8**.
- 2 Press  or  to choose **TIMER**, and press **Menu/Set**.
- 3 The screen prompts you to enter the time you want to begin polling.
- 4 Enter the time (in 24-hour format) you want to begin polling.  
For example, enter 21:45 for 9:45 PM.
- 5 Press **Menu/Set**. The screen prompts you to enter the fax number you are polling.
- 6 Enter the fax number, and press **Fax Start**.  
The machine makes the polling call at the time you entered.



ENTER FAX NO.



You can set up only one Delayed Polling.

## Sequential Polling

The machine can request documents from several fax units in a single operation. You just specify several destinations in Step 6. Afterward, a Sequential Polling Report will be printed.



- 1 Press **Menu/Set, 2, 1, 8**.
- 2 Press  or  to choose **STANDARD**, **SECURE** or **TIMER**, and press **Menu/Set** when the screen displays the setting you want.
- 3 If you selected **STANDARD**, go to Step 4.
  - If you selected **SECURE**, enter a four-digit number and press **Menu/Set**, and then go to Step 4.
  - If you selected **TIMER**, enter the time (in 24-hour format) you want to begin polling and press **Menu/Set**, and then go to Step 4.
- 4 Specify the destination fax machines, which you wish to poll by using One Touch (FAX-2850), Speed Dial, Search, a Group (see *Setting Up Groups for Broadcasting*, page 34) or the dial pad. You must press **Menu/Set** between each location.
- 5 Press **Fax Start**.  
The machine polls each number or group number in turn for a document.

# Polling Transmit

## Setup for Polling Transmit (Standard)

---



Polling Transmit is when you set up the machine to wait with a document so another fax machine can retrieve it.

- 1 Insert the document face down in the ADF.
- 2 Press **Menu/Set, 2, 2, 6**.
- 3 Press  or  to choose **STANDARD**, and press **Menu/Set**. The screen displays: 1 . DOC 2 . MEMORY
- 4 Press **1** to select **DOC** if you want the machine to scan the printed document at the time it is polled—**OR**—Press **2** to select **MEMORY**.
- 5 Press **1** if you want to select additional settings. The display returns to the **SETUP SEND** menu—**OR**—Press **2** if you have finished choosing setting and go to Step 6.
- 6 Press **Fax Start**.

## Setup for Polling Transmit with Secure Code

---

When you choose **POLLING:SECURE**, anyone who polls the machine must enter the polling secure code.



- 1 Insert the document face down in the ADF.
- 2 Press **Menu/Set, 2, 2, 6**.
- 3 Press  or  to choose **SECURE**, and then press **Menu/Set**.
- 4 Enter a four-digit number, and press **Menu/Set**.  
The screen displays: 1 . DOC 2 . MEMORY
- 5 Press **1** to select **DOC** if you want the machine to scan the printed document at the time it is polled—**OR**—Press **2** to select **MEMORY**.
- 6 Press **1** if you want to select additional settings. The display returns to the **SETUP SEND** menu—**OR**—Press **2** if you have finished choosing settings and go to Step 7.
- 7 Press **Fax Start** and wait for the fax to be polled.



You can use Secure Polling only with another Brother fax machine.

## Setting Fax Storage

If you set Fax Storage to **ON**, you will be able to retrieve fax messages from another location, using Fax Forwarding or Remote Retrieval functions. The screen will indicate when you have a fax stored in memory.

- 1 Press **Menu/Set, 2, 5, 2**.
- 2 Press  or  to select **ON** (or **OFF**), and press **Menu/Set** when the screen displays your selection.
- 3 Press **Stop/Exit**.



If there are faxes in memory when you turn the Fax Storage **OFF**, the screen prompts you to erase any faxes in memory.

If you press **1**, all fax data is erased and Fax Storage is turned **OFF**. If the fax data in memory has not been printed before, it will be printed first, and then erased. If you press **2**, data is not erased, and Fax Storage remains **ON**.

### Backup Print

If you've set **FAX STORAGE** to **ON**, the machine automatically prints fax messages as they are received into memory. This is a safety feature in case the power goes out for several days so you won't lose the messages.



## Fax Forwarding



You cannot use Fax Forwarding when "Fax Storage" is set to **OFF**.

### Programming a Fax Forwarding Number

When Fax Forwarding and Fax Storage are set to **ON**, the machine stores the received fax in memory, then dials the fax machine phone number you've programmed, and forwards the fax message. You can change a Fax Forwarding number remotely. (See *Changing the Fax Forwarding Number*, page 55.)

- 1 Press **Menu/Set, 2, 5, 1**.
- 2 Press  or  to select **ON** (or **OFF**), and press **Menu/Set**.  
The screen prompts you to enter the number of the fax machine where faxes will be forwarded.
- 3 Enter the forwarding number (up to 20 digits), and press **Menu/Set**.
- 4 Press **Stop/Exit**.



You can also dial into the machine from a remote location to switch this feature on, or to change the number you want your faxes forwarding to.

## Changing the Remote Access Code

---

Enter your Remote Access Code when the machine picks up your call, so you can access features remotely. The access code is preset to 1 5 9 \*, but you can change this.

- 1** Press **Menu/Set, 2, 5, 3**.
- 2** Enter a three-digit number from 000 to 999, and press **Menu/Set**.  
The \* cannot be changed. Do not use the same digits that appear in your Remote Activation or Deactivation Code.
- 3** Press **Stop/Exit**.

## Remote Retrieval

### Using Your Remote Access Code

---

To receive faxes at your location, you must call from a fax machine using touch tone. For convenience, you can retrieve faxes from a touch tone phone by having them sent to a fax machine. For example, if your hotel room does not have a fax machine, you can enter the number of the fax machine at the hotel's Front Desk.

- 1** Dial your fax number from a touch tone phone.
- 2** When the machine answers and beeps, immediately enter your Remote Access Code (the factory setting is 1 5 9 \*).
- 3** The machine signals the kinds of messages received:  
**1 long beep — Fax message(s)**  
**No beep — No messages**
- 4** The machine prompts you with two short beeps to enter a command. If you wait longer than 30 seconds to enter a command, the machine hangs up. If you enter an invalid command, the machine beeps three times.
- 5** Press **9 0** to reset the machine when you finish.
- 6** Hang up.



## Remote Commands

---

Follow the commands below to access features remotely. When you call the machine and enter your Remote Access Code (the factory setting is 1 5 9 \*), the system will signal you with two short beeps to enter a remote control command.

### Change Fax Forwarding Setting

Press **9 5**

*then to*

**Turn Fax Forwarding OFF**—Press **1**.

**Turn Fax Forwarding ON**—Press **2**.

**Program Fax Forward Number**—Press **4**. Automatically turns Fax Forwarding **ON**.

**Turn Fax Storage ON**—Press **6**.

**Turn Fax Storage OFF**—Press **7**. (This is only possible if there are no faxes stored in the memory, or if all faxes have been erased using Remote Control **9 6 3**).

### Retrieve or Erase a Fax

Press **9 6**

*then to*

**Retrieve all faxes**—Press **2**, then enter the number of remote fax machine and then press **# #**. After the beep, hang up and wait.

**Erase all fax messages**—Press **3**. If the data stored in the memory has not been printed before, it will be printed first and then erased.

### Check the Receiving Status

Press **9 7**

*then Press 1.*

**1 long beep**—Received fax messages.

**3 short beeps**—No messages.

### Change Receive Mode

Press **9 8**

*then for*

**TAD**—Press **1**.

**F/T (FAX/TEL)**—Press **2**.

**FAX**—Press **3**.

### Exit Remote Operation

Press **9 0**.

## Retrieving Fax Messages

---

- 1 Dial the machine's number.
- 2 When you hear the beep, immediately enter your Remote Access Code (the factory setting is 1 5 9 \*).
- 3 As soon as you hear two short beeps, use the dial pad to press **9 6 2**.
- 4 Using the dial pad, enter the number (up to 20 digits) of the remote fax machine where you want your fax messages forwarded, and then press **# #**.



You cannot use \* and # as dial numbers. However, if you want to store a pause, press #.

- 5 After you hear the machine beep, hang up and wait.  
The machine calls the remote fax machine and sends the stored documents. The remote fax machine prints your fax messages.

## Changing the Fax Forwarding Number

---

You can change the default setting of your fax forwarding number from a remote telephone/fax machine using touch tone.

- 1 Dial the machine's number.
- 2 When you hear the beep, immediately enter your Remote Access Code (the factory setting is 1 5 9 \*).
- 3 When you hear two short beeps, use the dial pad to press **9 5 4**.
- 4 Enter the new number of the remote fax machine where you want your fax messages forwarded, and then press **# #**.



You cannot use \* and # as dial numbers. However, if you want to store a pause, press #.

- 5 After you hear the machine beep, hang up.

# 11 Making Copies

## Basic Copy Operations

### Using the Machine as a Copier

You can use the machine as a copy machine, making up to 99 copies at a time.

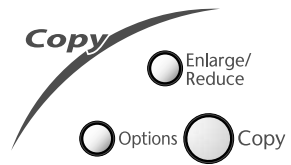

**Do NOT pull on the paper while copying is in progress. To cancel, press Stop/Exit. Press Stop/Exit again to release the original document.**

The scannable area of the machine begins at approximately 4mm from the edge of the paper.

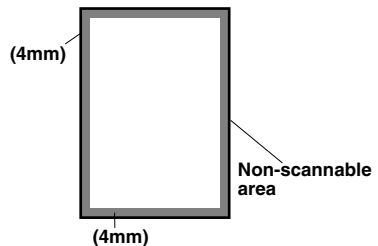

### Making a Single Copy

- 1 Insert the document face down in the ADF.
- 2 Press **Copy**.



To stop, press **Stop/Exit**. To release the original document, press **Stop/Exit** again.

### Making Multiple Copies

- 1 Insert the document face down in the ADF.
- 2 Using the dial pad, enter the number of copies you want.  
For example, press **3, 8** for 38 copies.
- 3 Press **Copy**.



To sort the copies, use Options key.

## Out of Memory Message

If the memory becomes full while you're making copies, the screen displays:

OUT OF MEMORY

If you were scanning the first page to be copied, press **Stop/Exit** to cancel the operation and restart to make a single copy. If you were scanning a subsequent page, you'll have the option to press **Copy** to copy the pages scanned so far —**OR**— press **Stop/Exit** to cancel.

You'll need to clear some fax messages to make some additional memory available before you can continue.



To gain extra memory, you can turn off Fax Storage—**OR**—Print fax messages in memory. (See *Setting Fax Storage*, page 52.)

## Temporary Copy Setting

You can quickly enlarge or reduce copies or improve the copy quality by using the **Enlarge/Reduce**, and **Options** keys. These settings are temporary, and the machine returns to its default settings when you finish copying.

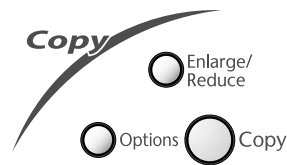



## Copying Using Multiple Settings







You can try different combinations of settings for the best results.

After you finish settings using the **Enlarge/Reduce** or **Options** keys, the LCD shows:



- Press  or  if you want to select additional settings.  
—**OR**—  
Press **Copy** if you have finished choosing settings.

## Making Enlarged or Reduced Copies (Temporary Setting)

- 1 Insert the document face down in the ADF.
- 2 Using the dial pad, enter the number of copies—**OR**—Keep the default (01).
- 3 Press **Enlarge/Reduce**.
- 4 Press  or  to choose an enlargement or reduction ratio.  
You can reduce to **71%** or **50%** of the original size by pressing  key.  
—**OR**—  
You can enlarge to **141%**, **150%**, **200%** by pressing  key.  
—**OR**—  
You can press  or  to select **MANUAL**, then use the dial pad to enter an enlargement or reduction ratio between 50% and 200%. For example, press **5, 3** to enter 53%.

5 Press **Menu/Set**.

6 Press **Copy**—**OR**—Press  or  for additional settings.



Special Copy Options (2 in 1 or 4 in 1 copy) are not available with **Enlarge/Reduce**.

## Using the Options Key







The **Options** key changes the settings for copy mode, contrast, sort and special copy options **for the next copy only**.

Press **Options**.

Press Options	Menu Selections	Options	Factory Setting
 Options	<b>NO. OF COPIES</b>	<b>NO. OF COPIES:XX</b>	<b>01</b>
	<b>COPY MODE</b>	<b>AUTO/TEXT/PHOTO</b>	<b>AUTO</b>
	<b>CONTRAST</b>	- □ □ □ □ □ +	- ■ ■ ■ □ □ +
	<b>SPECIAL</b>	<b>2IN1/4IN1/OFF</b>	<b>OFF</b>
	<b>PAPER TYPE</b>	<b>THIN/PLAIN THICK/THICKER/ TRANSPARENCY</b>	<b>PLAIN</b>







## Copy Mode (Type of Original)

You can select the Copy resolution for your type of original. The default setting is **AUTO**, which is used for originals that contain both text and photographs. **TEXT** is used for originals containing only text. **PHOTO** is used for copying photographs.

- 1 Insert the document face down in the ADF.
- 2 Use the dial pad to enter the number of copies you want (up to 99).
- 3 Press **Options** and  or  to select **COPY MODE** and then press **Menu/Set**.
- 4 Press  or  to choose the type of original (**AUTO**, **TEXT** or **PHOTO**), and then press **Menu/Set**.
- 5 Press **Copy**—**OR**—Press  or  for additional settings.

## Copy Contrast







You can adjust copy contrast to make copies darker or lighter.

- 1 Insert the document face down in the ADF.
- 2 Use the dial pad to enter the number of copies you want (up to 99).
- 3 Press **Options** and  or  to select **CONTRAST**, and then press **Menu/Set**.
- 4 Press  to make a copy lighter, or  to make a copy darker, and then press **Menu/Set**.
- 5 Press **Copy**—**OR**—Press  or  for additional settings.

## Special Copy Options

---

You can save paper by copying either two or four pages onto one page.

- 1 Insert the document face down in the ADF.
- 2 Use the dial pad to enter the number of copies you want.
- 3 Press **Options** and  or  to select **SPECIAL**, and then press **Menu/Set**.
- 4 Press  or  to select **2 IN 1**, **4 IN 1** or **OFF**, and then press **Menu/Set**.
- 5 Press **Copy—OR—**Press  or  for additional settings.

### 2 in 1

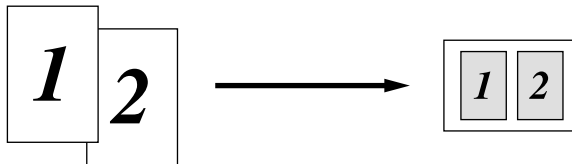

### 4 in 1

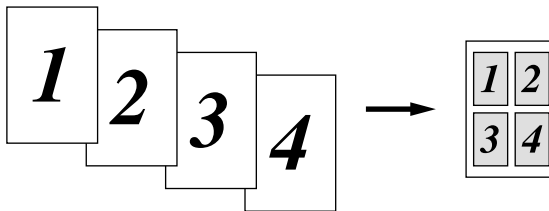







Special Copy Options (2in1 or 4in1 Copy) are not available with **Enlarge/Reduce**.

## Paper Type

---

You can use the following types of paper for copying. For the best print quality, select the type of media that you are using.



<b>THIN</b> (64-69 gsm)	For thin paper or transparency
<b>PLAIN</b> (70-95 gsm)	For ordinary plain paper
<b>THICK</b> (96-120 gsm)	For heavy weight paper or rough paper
<b>THICKER</b> (121-158 gsm)	For heavier weight paper, rough paper or bond paper
<b>TRANSPARENCY</b>	For transparency (OHP)

- 1 Press **Options** and  or  to select **PAPER TYPE**, and then press **Menu/Set**.
- 2 Press  or  to select your type of paper, and then press **Menu/Set**.
- 3 Press **Copy—OR—**Press  or  for additional settings.

# Copy Quality – Default Settings

## Changing Default Settings

Press **Menu/Set, 3** to change default settings for Copy mode. These settings will remain until you change them again by pressing **Menu/Set**. Adjust the Copy Mode and Contrast settings.

By pressing a number, you can adjust copy settings as shown in the following chart. Press  or  to move through the selections for each setting. Press **Menu/Set** to save your selection. Press **Stop/Exit—OR—Press**  to select the next setting you want to change.

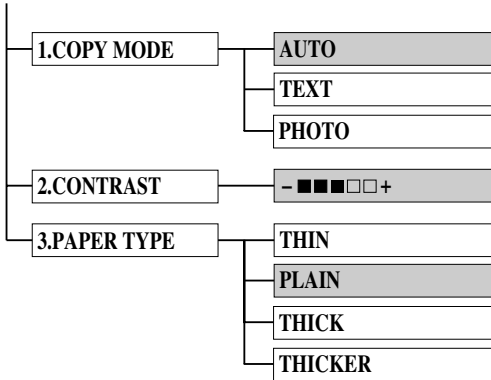

Press **Menu/Set, and 3**.



 is default



## Copy Mode (Type of Original)

You can select the Copy resolution for your type of original. The default setting is **AUTO**, which is used for originals that contain both text and photographs. **TEXT** is used for originals containing only text. **PHOTO** is used for copying photographs.

- 1 Press **Menu/Set, 3, 1**.
- 2 Press  or  to choose the type of original (**AUTO**, **TEXT** or **PHOTO**), and then press **Menu/Set**.
- 3 Press **Stop/Exit—OR—Press**  for additional settings.

## Copy Contrast

You can adjust copy contrast to make copies darker or lighter.

- 1 Press **Menu/Set, 3, 2**.
- 2 Press  to make a copy lighter—**OR—Press**  to make a copy darker, and then press **Menu/Set**.
- 3 Press **Stop/Exit—OR—Press**  for additional settings.



## Paper Type

---

You can use the following types of paper for copying. For the best print quality, select the type of media that you use most often.

<b>THIN</b> (64-69 gsm)	For thin paper
<b>PLAIN</b> (70-95 gsm)	For ordinary plain paper
<b>THICK</b> (96-120 gsm)	For heavy weight paper or rough paper
<b>THICKER</b> (121-158 gsm)	For heavier weight paper, rough paper or bond paper

**1** Press **Menu/Set, 3, 3**.

**2** Press  or  to select your type of paper, and then press **Menu/Set**.

**3** Press **Stop/Exit**.



## ***Special Printing Features***

### **Windows® Printing**

---

The dedicated printer driver for Microsoft® Windows® 95, 98, 98SE, Me, 2000 Professional and Windows NT® Workstation Version 4.0 are available on the CD-ROM supplied with the machine. You can easily install them into your Windows® system using our installer program. The driver supports our unique compression mode to enhance printing speed in Windows® applications, and allows you to set various printer settings including economy printing mode and custom paper size.

### **Enhanced Memory Management**

---

The machine has its own Data Compression Technology, which automatically compresses graphic data and downloads font data efficiently into the printer's (machine's) memory. You can avoid memory errors and print most full-page, 600dpi graphic and text data, including larger fonts, with the machine's standard memory.

## ***Printing From Your PC***

### **Multi-Purpose Sheet Feeder**

---

The machine's multi-purpose sheet feeder can feed plain paper, envelopes, and organizer paper, Postcard, Labels and Transparencies. When the machine receives data from your computer, it begins the print process by loading paper from the multi-purpose sheet feeder.

- Select the print command from your PC.

Your PC sends a print command and data to the machine. If there are more pages, the machine begins to print the next page automatically.



You may select the proper paper source, paper size, and orientation in your application software.

If your application software does not support your custom paper size, select the next larger paper size. Then adjust the print area by changing the right and left margins in your application software.

## Two-Sided Printing (Manual Duplex)

The supplied printer drivers for Windows® 95/98/98SE/Me and Windows NT® Workstation Version 4.0 support manual duplex printing. (For more information, see the Help screen for the printer driver.)

Please select LPT1 port in the printer driver. The machine prints all the even-numbered pages on one side of the paper first. Then, the Windows® driver instructs you (with a pop-up message) to reinsert the paper. Before reinserting the paper, straighten it well or you may get a paper jam. Very thin or very thick paper is not recommended. If the paper “double-feeds” (sends two sheets at once), hold the stack of paper except for the front sheet while the paper is feeding.

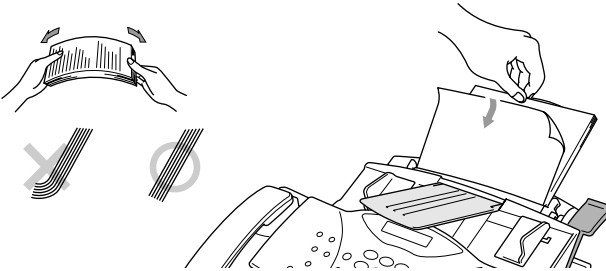

**When you use manual duplexing, it is possible that a paper jam may occur or the printer quality might not be satisfactory.**

## Loading Envelopes

If you load envelopes into the Multi-purpose sheet feeder, make sure they are inserted in the direction shown below.

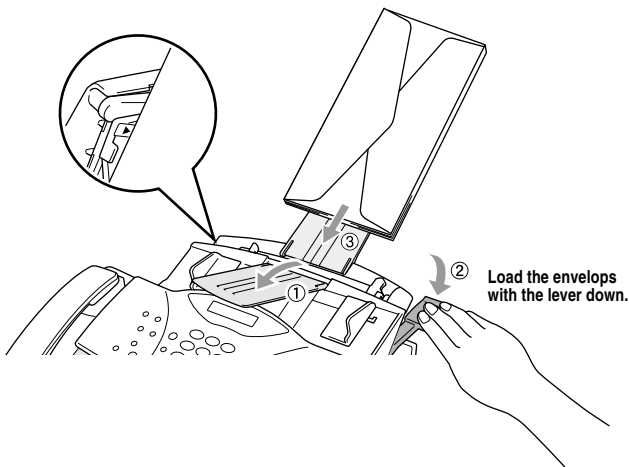

## Paper Tray

---

The machine ejects paper with printed surfaces face down into the paper tray at the front of the machine. When you use transparencies, remove each sheet immediately after printing, to prevent a paper jam or curled sheets.

## Reset Key (For MFC-4800 Only)

---

Press this key to clear data from the memory.

## *Simultaneous Printing/Faxing*

The machine can print data from your computer while sending or receiving a fax, or while scanning information into the computer. However, when the machine is copying or receiving a fax on paper, it pauses the PC printing operation, and resumes when copying or fax receiving is complete. Fax sending continues during PC printing.

# Acceptable Paper

To achieve high quality printing using the machine, it's very important to select the right kind of paper.

Paper Type	Paper Size
Cut sheet	A4, Letter, Legal, B5, A5, Executive, Custom size 70-216 x 127-356 mm (2.75-8.5 x 5-14 inches)
Envelopes	DL, C5, COM-10, Monarch
Post Card	70-216 x 127-279 mm (2.75-8.5 x 5-11 inches)
Organizer	Day-Timer® J, K, L, M 70-216 x 127-279 mm (2.75-8.5 x 5-11 inches)
Labels and Transparencies	70-216 x 127-356 mm (2.75-8.5 x 5-14 inches)

## Paper Capacity in Feeder

Multi-purpose Sheet Feeder: Up to 22 mm (0.87 inches) in height (up to the mark) Approx. 200 sheets of 75 g/m<sup>2</sup> (20 lb) or 50 sheets of 158 g/m<sup>2</sup> (42 lb) A4/Letter paper, or 10 envelopes

	Cut Sheet	Envelope
Basis Weight	64 to 158 g/m <sup>2</sup> (17 to 42 lb)	75 to 90 g/m <sup>2</sup> (20 to 24 lb) single thickness
Caliper	(±0.003 to ±0.008 inches) 0.08 to 0.2 mm	(0.0033 to 0.0058 inches) 0.084 to 0.14 mm single thickness
Moisture Content	4% to 6% by weight	4% to 6% by weight
Smoothness	100 to 250 (Sheffield)	100 to 250 (Sheffield)

## Recommended paper types:

Cut sheet:	Xerox 4200
Label:	Avery laser label or equivalent
Transparency:	3M CG3300 for laser printers or equivalent
Output Tray:	Approx. 50 sheets of 75 g/m <sup>2</sup> (20 lb) A4/Letter paper

# 13 Printer Driver Settings (For Windows® Only)

## Using the Brother MFC-4800 Printer Driver

A Printer Driver is software that translates data from the format used by a computer into the format required by a particular printer, using a printer command language or page description language.

The printer drivers are on the supplied CD-ROM.

For FAX-2850, you can download the latest Brother Printer Driver from the Brother Web Site. Visit us at:

<http://solutions.brother.com>

<http://www.brother.com>

## Features in the Printer Driver (For Windows® Users Only)



The screens shown in this section are from Windows® 98. The screens on your PC may vary depending on your Windows® Operating System.

For more detailed information, please see the on-line Help in the printer driver.

## Basic Tab

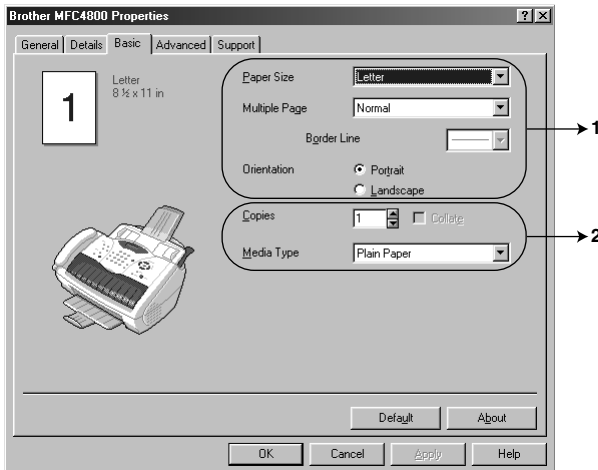

1. Select the **Paper size**, **Multiple Page** and **Orientation**.
2. Select number of **Copies** and **Media Type**.

## Paper Size

---

From the drop-down box select the **Paper Size** you are using.

## Multiple Page

---

The **Multiple Page** selection can reduce the image size of a page allowing multiple pages to be printed on one sheet of paper or enlarging the image size for printing on page on multiple sheets of paper.



Ex. 4 in 1



Ex. 1 in 2x2 pages

## Border Line

---

When printing multiple pages on one sheet with the Multiple Page feature you can select to have a solid border, dash border or no border around each page on the sheet.

## Orientation

---

**Orientation** selects the position of how your document will be printed (**Portrait** or **Landscape**).



Portrait

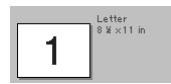

Landscape

## Copies

---

The **Copies** selection sets the number of copies that will be printed.

## Collate

---

The collate selection is active if more than one copy is selected. With the collate check box selected, one complete copy of your document will be printed and then repeated for the number of copies you selected. If the collate check box is not selected then each page will be printed for all the copies selected before the next page in the document is printed.

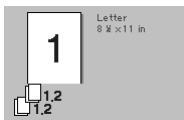

Collate box checked

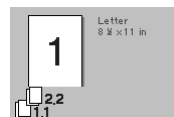

Collate box not checked

## Media Type

You can use the following types of media in your printer. For the best print quality, select the type of media that you wish to use.

- Plain Paper*
- Thin Paper*
- Thick Paper*
- Thicker Paper*
- Bond Paper*
- Transparencies*

When using ordinary plain paper, select *Plain Paper*. When using heavier weight paper, envelopes or rough paper select *Thick Paper* or *Thicker Paper*. For bond paper, select *Bond Paper* and for OHP transparencies, select *Transparencies*.

## Advanced Tab

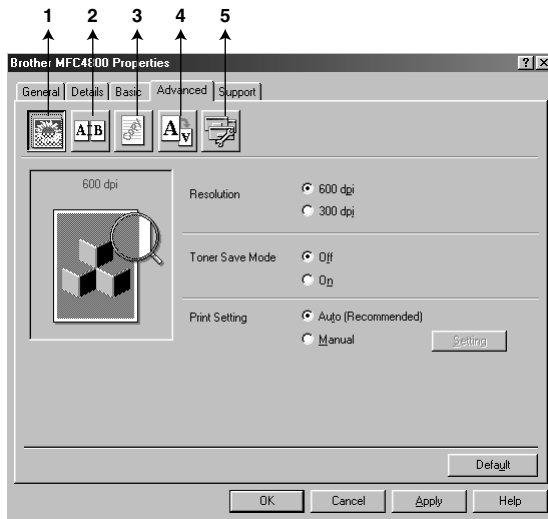

Change the tab settings by selecting one of the following icons:

1. **Print Quality**
2. **Duplex Printing**
3. **Watermark**
4. **Page Setting**
5. **Device Option**

# Print Quality

---

## Resolution

You can change the resolution as follows:

- ◆ 300 dpi
- ◆ 600 dpi

## Toner Save

You can save running costs by turning on the **Toner Save Mode**, which reduces the print density.

## Print Setting (For Windows® 95/98/98SE/Me Users Only)

Print Setting is used for optimizing your print quality for the type of document being printed (Photos, Graphics or Scanned Images). When you choose **Auto (Recommended)**, the printer automatically prints with the most suitable print settings.

With the Print Setting set to **Manual**, you can change the **Brightness**, **Contrast** and **Graphics Quality** options manually.

## Duplex Printing

---

Choosing the **Duplex Printing** icon displays the **Manual Duplex** features available.

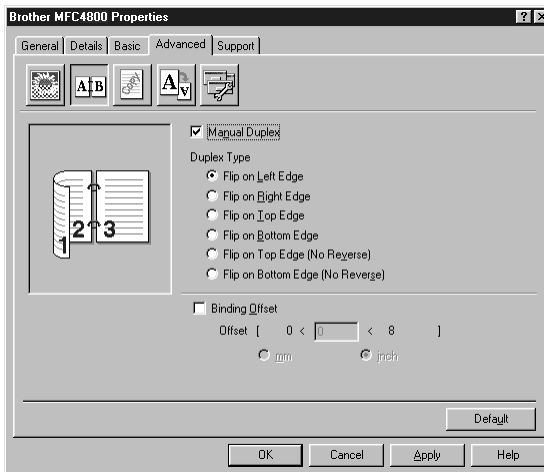

## Manual Duplex

Check the **Manual Duplex** box and there are six types of duplex directions available for each orientation. In this mode, the machine prints all the even numbered pages first. Then the printer driver stops and shows the instructions required to re-install the paper. When you click **OK** the odd numbered pages are printed.

## Binding Offset

Check the **Binding Offset** option, you can specify the offset value of the binding side in millimetres or inches (0 – 203.2 mm) [0 – 8 inches].



## Watermark

You can place a logo or text into your document as a Watermark by using a bitmap file as your source file or select one of the preset Watermarks.

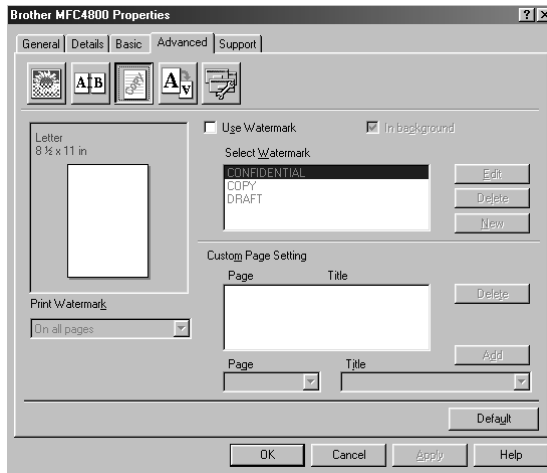

### Print Watermark

The **Print Watermark** feature offers printing choices of:

- On all pages*
- On first page only*
- From second page*
- Custom*

### In background

With the **In background** feature checked the Watermark will print behind your document on the page. If this feature is not checked then the Watermark will print on top of your document.

You can change the size and the **position** of the Watermark on the page by selecting the Watermark and clicking the **Edit** button. If you want to add a new Watermark, click the **New** button and select **Text** or **Bitmap** from the **Watermark Style**.

### Watermark Text

Enter your **Watermark Text** into the Text Box and select the **Font**, **Size**, **Darkness** and **Style**.

## Watermark Bitmap

Enter the file name and location of your bitmap image in the **File** box or **Browse** for the file location. You can also set the scaling size of the image.

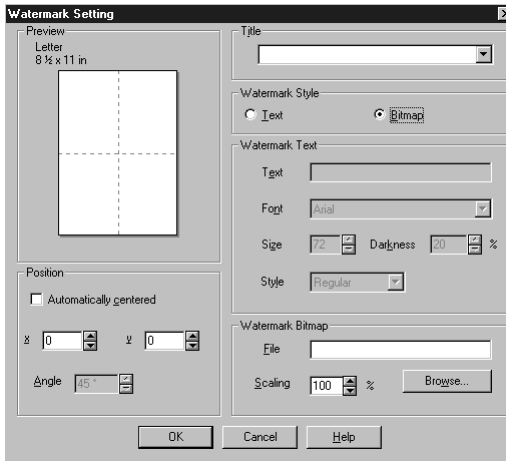

## Position

The position settings offer controls on where the Watermark can be positioned on the page.

## Page Setting

You can change the print size of your document with the **Scaling** feature.

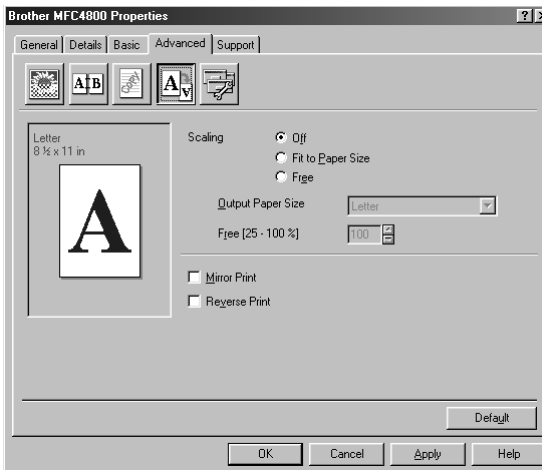

1. Check **Off** if you want to print the document as it appears on your screen.
2. Check **Fit to Paper Size**, if your document has an unusual size, or if you have only the standard size paper.
3. Check the **Free** box if you want to reduce or enlarge the output.

You can also use the **Mirror Print** or **Reverse Print** feature for your page setting.

# Device Options

Set one of the following Printer Functions:

- **Quick Print Setup**
- **Administrator (For Windows® 95/98/98 SE/Me Users Only)**
- **Print Date & Time**

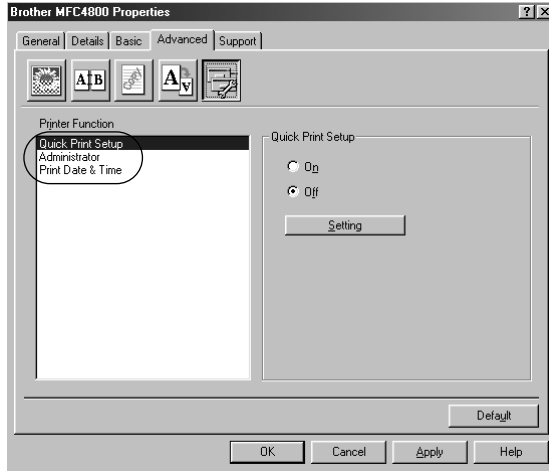

## Quick Print Setup

The **Quick Print Setup** feature allows you to quickly select driver settings. To view settings, simply click your mouse button on the task tray icon. This feature can be set to **ON** or **OFF** from the Device Options section.

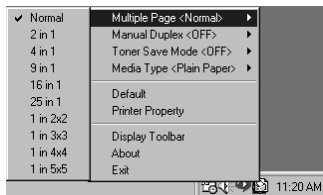

## Administrator (For Windows® 95/98/98SE/Me Users Only)

The administrator selection permits the **Copy**, **Scaling** and **Watermark** features to be locked and **Password** protected.

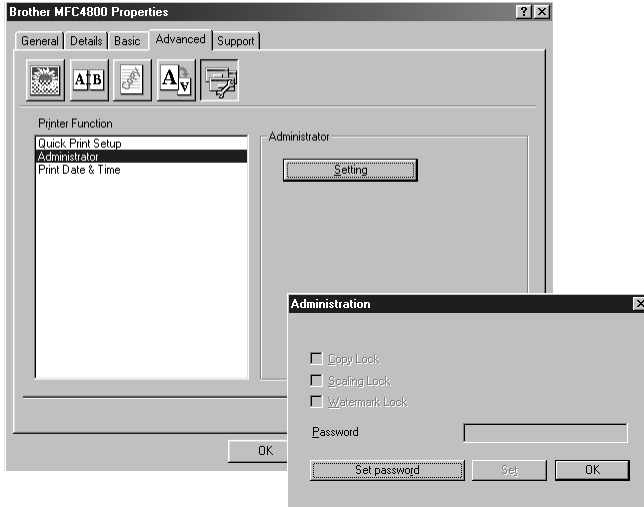

Record your password and keep it in a safe place for future reference. If you forget your password these settings can not be accessed.

## Print Date & Time

When enabled the **Print Date and Time** feature will automatically print the date and time on your document from your computers system clock.

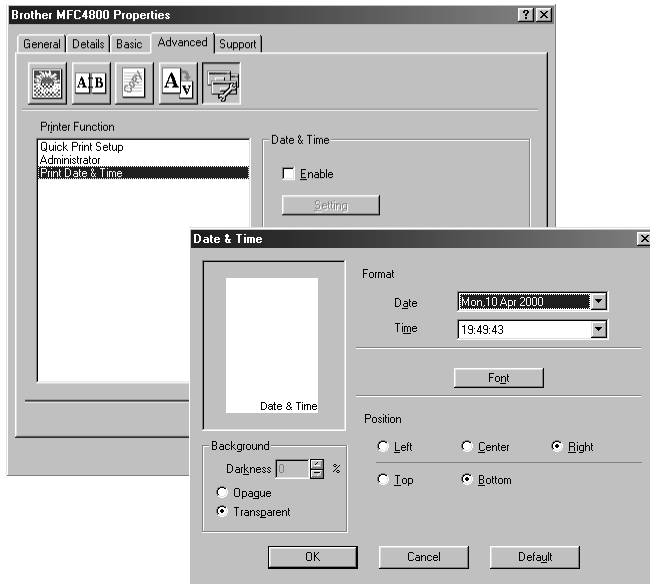

Click the **Setting** button to change the **Date and Time Format, Position and Font**. To include a background with the Date and Time select **Opaque**. When **Opaque** is selected you can set the **Darkness** of the Date and Time background by changing the percentage.



The Date and Time indicated in the selection box represents the format that will be printed. The actual Date and Time printed on your document is automatically retrieved from the settings of your computer.

# Support

The Support Tab provides driver version information and setting information. In addition there are links to the Brother Solution Centre and Driver Update Web sites.

## Brother Solutions Centre

The **Brother Solutions Centre** is a Web site offering information about your Brother product including FAQ's, User Guides, Driver updates and Tips for using the machine.

## Web Update

**Web Update** checks the brother web site for updated drivers and automatically downloads and updates the driver on your computer.

## Check Setting

The **Check Setting** selection displays a list of your current drivers settings.

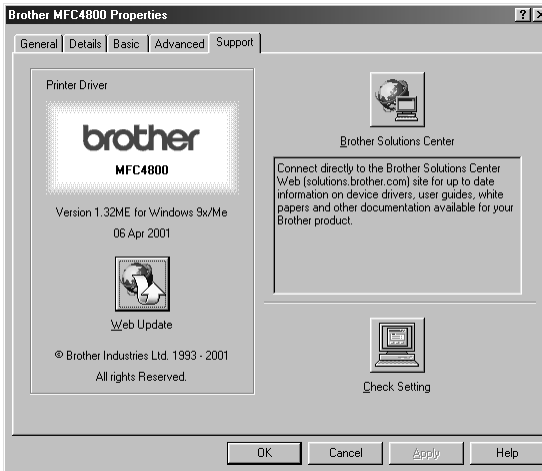

## Brother MFL-Pro Control Centre

The Brother Control Centre is a software utility that pops up on the PC screen whenever paper is placed in the ADF. This allows you to access the most frequently used scanning applications only with a few mouse clicks. Using the Control Centre eliminates the need to manually launch the specific applications.

The Brother Control Centre provides three categories of functions:

- 1 Scan directly to a file, E-mail, word processor or graphic application of choice
- 2 Copy functions.
- 3 PC Faxing using the Brother MFL Pro PC-FAX Software.



### AutoLoad the Brother Control Centre



The Control Centre is initially configured to automatically load each time Windows® is started.

When the Control Centre is loaded, the Control Centre  icon will appear in the task bar. If you don't want the Control Centre to load automatically, you can turn off AutoLoad.



If the Control Centre  icon does not appear in your taskbar, you will have to launch this software. From the **Fax Start** menu, select **Programs, PaperPort**, and then double-click **Brother SmartUI PopUp**.

## How to Turn Off AutoLoad

- 1 Left click the Control Centre  icon and click **Show**.
- 2 When the Control Centre main screen appears, left click on the **Smart Click**  **Control Centre** button. A dialog box with a check box labelled “**AutoLoad Pop-up**” will appear:

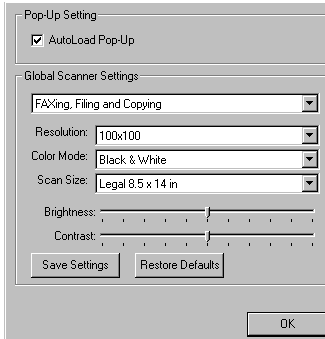

- 3 Uncheck the **AutoLoad Pop-Up** option.

## Using the Scan Keys with Windows PC



If you have connected a Macintosh, the scan keys will not work with your computer. (See *Using the Brother MFC with a New Power Macintosh® G3, G4 or iMac™/iBook™*, page 107.)

You can use the Scan keys on the control panel to scan originals into your word processing, graphics or E-mail applications. The advantage of using the Scan keys is that you avoid the mouse clicks required to scan from your PC.

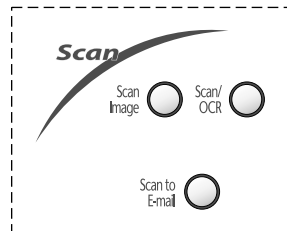



# Using the Control Panel Keys

Before you can use the Scan keys on the control panel, you must have connected the machine to your Windows® based PC and loaded the appropriate Brother Drivers for your version of Windows®. When you are ready to use the Scan keys, make sure the Brother Control Centre application is running on your PC. (For details about how to configure the Brother Control Centre buttons to launch the application of your choice using the Scan keys, see *Brother MFL-Pro Control Centre*, page 76.)

## Scan Image

---

You can scan a picture into your graphics application for viewing and editing.

- 1 Insert the document face down in the ADF.
- 2 Press **Scan Image**.
- 3 The machine will scan the document and send a image to your graphics application.

## Scan/OCR

---

If your document is text, you can have it automatically converted by ScanSoft™ TextBridge® to an editable text file and then displayed in your word processing application for further editing.

- 1 Insert the document face down in the ADF.
- 2 Press **Scan/OCR**.
- 3 The machine will scan the document perform OCR in ScanSoft™ TextBridge®, and then display the result in your word processing application for viewing and editing.

## Scan to E-mail

---

You can scan documents into your E-mail application as a file attachment. Although the Brother Control Centre can be configured to send only black and white file attachments at one time, you can easily change this setting. (See *Scan to E-mail*, page 83.)

- 1 Insert the document face down in the ADF.
- 2 Press **Scan to E-mail**.
- 3 The machine will scan the document, create a file attachment, and launch your E-mail application, displaying the new message waiting to be addressed.

# Brother Control Centre Features

## Auto Configuration

---

During the installation process the Control Centre checks your system to determine the default applications for E-mail, word processing and graphics viewer/editor. For example, if you are using Outlook as your default E-mail application, the Control Centre automatically will create a link and a scanning application button for Outlook.

You can change a default application by right clicking on any of the scan buttons in the Control Centre and selecting a different application. For example,

you can change a scan button from *MS Word*  to *MS Word Pad*



by changing the application that is listed for the **Word Processor**.



## Scanning Operations

---

*Scan to File*—allows you to scan directly to a disk file with two mouse clicks. You can change the file type, destination directory and file name, as needed.

*Scan to E-mail*—enables you, with just two mouse clicks, to scan a picture or text document directly into an E-mail application as a standard attachment. You have the option of selecting the file type and resolution for the attachment.

*Scan to Word Processor*—enables you to scan a text document, run ScanSoft TextBridge OCR and insert the text original (not graphic image) into a word processing file with just two mouse clicks. You have the option of selecting the destination word processing program, such as Word Pad, MS Word, Word Perfect, etc.

*Scan to Graphic Application*—allows you to scan an image directly into any graphic viewer/editor application. You can select the destination application, such as MS Paint or Corel PhotoPaint.

## Copy Operations

---

*Copy*—allows you to use the PC and any Windows® printer driver for enhanced copy functions. You can scan the page on the Brother MFC and print the copies using any of the features of the Brother MFC printer driver—**OR**—you can direct the copy output to any standard Windows® printer driver installed on the PC.

## PC Fax Operation

---

*Send a Fax*—allows you to scan a picture or text original and automatically send the image as a fax from the PC using the Brother MFL Pro PC-FAX software.

## Scanner Settings for Scan and Copy Buttons

---

When the Pop-Up screen is displayed, you can access the **Scanner Settings** window.

Click the **Smart Click**  icon at the top right of the Brother Control.

Centre screen—**OR**—Click the **Modify Settings...** button on any of the Configuration screens.

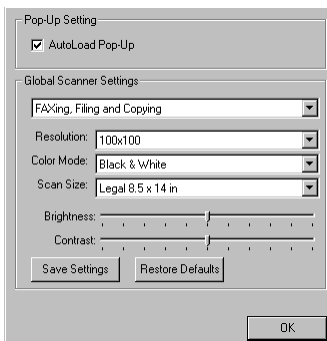

## Global Settings

---

**AutoLoad Pop-Up**—Click this checkbox if you want Brother MFL Control Centre to load when you boot your computer.

## Setting Up the Scanner Configurations

---

The Pop-Up application stores eight different scanning modes. Each time you scan an original, you will choose the most appropriate scanning mode from the following:

*Faxing, Filing and Copying*  
*Text for OCR*  
*Photos*  
*Photos (High Quality)*  
*Photos (Quick Scan)*  
*Custom*  
*Draft Copy*  
*Fine Copy*

Each mode has its own set of stored settings. You can keep the factory default settings or change them at any time:

**Resolution**—Select the scanning resolution you most frequently use.

**Color Mode**—From the pull-down list.

**Scan Size**—From the pull-down list.

**Brightness**—Slide the adjuster from 0% to 100%

**Contrast**—Slide the adjuster from 0% to 100%

Click **OK** to save your changes. If you make a mistake or later decide to return to the original default setting, just click the **Restore Defaults** button when the scanning mode is displayed.

## To access the Scanner Configurations screen:

---

- 1 Insert the document face down in the ADF.
- 2 Right-click the appropriate **Control Centre** button to display **Configurations**, then click it. The configuration screen for that **Control Centre** button will appear.
- 3 To save your settings, press the **OK** button—**OR**—To return to the factory default settings, press the **Restore Defaults** button.

## Perform an Operation from the Brother Control Centre Screen

---

If you see this screen it means you left-clicked a button in the **Brother Control Centre** window without first placing an document in the ADF.

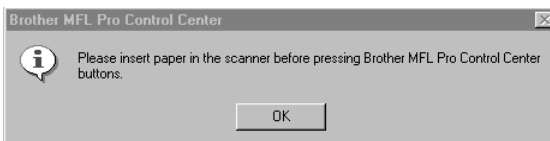

Place the document in the Brother machine's ADF, then click **OK** to return to the **Brother Control Centre** screen.

# Scan to File

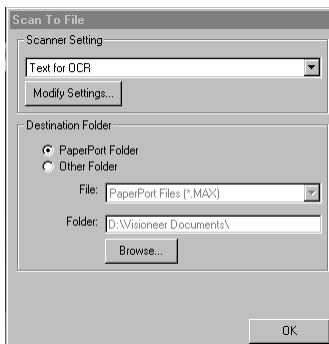

## Scanner Settings

From the pull-down list, select the scanning mode that is appropriate for the type of file: *Faxing, Filing and Copying; Text for OCR; Photos; Photos (High Quality); Photos (Quick Scan); Custom; Draft Copy* or *Fine Copy*.

To change any of the settings for that mode, click the **Modify Settings...** button.

## Destination Folder

**PaperPort Folder**—Select this checkbox to scan the document into your PaperPort folder.

**Other Folder**—Select this checkbox, to scan the document as another file type and/or into another directory/folder.

**File**—If you selected Other Folder, from the pull-down list select the type of file:

- PaperPort Files (\*.MAX)*
- Self Viewing Files (\*.EXE)*
- PaperPort 5.0 Files (\*.MAX)*
- PaperPort 4.0 Files (\*.MAX)*
- PaperPort 3.0 Files (\*.MAX)*
- Windows Bitmap (\*.BMP)*
- PC Paintbrush (\*.PCX)*
- Multi-page PCX (\*.DCX)*
- JPEG Image Files (\*.JPG)*
- TIFF-Uncompressed (\*.TIF)*
- TIFF Group 4 (\*.TIF)*
- TIFF Class F (\*.TIF)*
- Multi-Page TIFF-Uncompressed (\*.TIF)*
- Multi-Page TIFF Group 4 (\*.TIF)*
- Multi-Page TIFF Class F (\*.TIF)*
- PDF Files (\*.PDF)*
- Portable Network Graphics (\*.PNG)*
- FlashPix (\*.FPX)*
- HFX Fax Files (\*.HFX)*

To Search your system for the directory and folder you want, click the **Browse...** button. Click **OK** to save your settings.

# Scan to E-mail

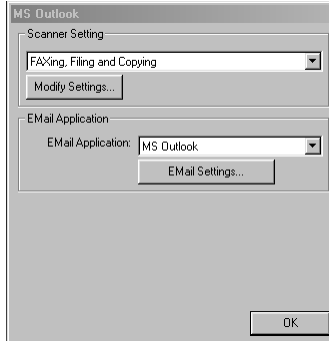

## Scanner Settings

From the pull-down list, select the scanning mode that is appropriate for the type of file: *Faxing, Filing and Copying*; *Text for OCR*; *Photos*; *Photos (High Quality)*; *Photos (Quick Scan)*; *Custom*; *Draft Copy* or *Fine Copy*.

To change any of the settings for that mode, click the **Modify Settings...** button.

## Email Application

*Email Application*—From the pull-down list, select your E-mail application.

**Email Settings**—Click the **EMail Settings...** button to set up links.

The **Links Preferences** window will appear:

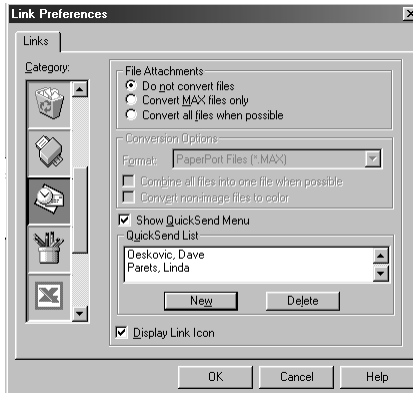

## File Attachments

**Do not convert files**—Click this checkbox if you do not want to change the file type of attachments. The Conversion Options will not be available (greyed).

**Convert MAX files only**—Click this checkbox if you want to convert only attachments that are PaperPort files.

**Convert all files when possible**—Click this checkbox if you want to change the file type of all attachments.

## Conversion Options

### Format

**Combine all files into one file when possible**—Click this checkbox to combine all files of the same type into one file.

(For Brother Color Models Only) **Convert non-image files to color**—Click this checkbox to convert all files that have been processed through OCR to color.

### Show QuickSend Menu

Click this checkbox if you want the **Select QuickSend Recipient** window to be displayed when you choose Scan to E-mail. This feature works only with MAPI type E-mail applications, such as Microsoft Exchange, Microsoft Outlook and Eudora.

### QuickSend List

You can create a list of Email names and addresses for quick selection.

Click the **New** button to add a name(s) to your **QuickSend list**. Your Email phone book listing is displayed, so you can select stored names or create new ones:

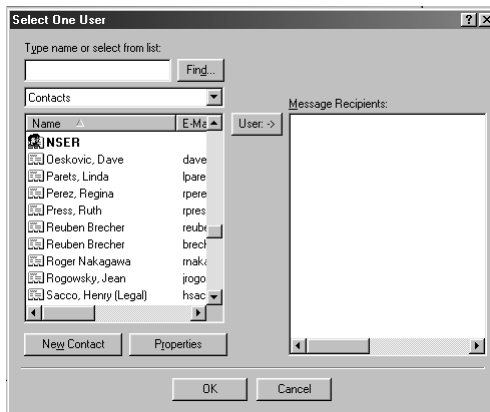

Highlight the name(s) you want to add to your list, click the **User** button, then click **OK** to return to the Link Preference window.

From the **Link Preference** window, you can remove a name from the QuickSend list, by highlighting the name and clicking the **Delete** button.

# Scan to Word Processor



## Scanner Settings

From the pull-down list, select the scanning mode that is appropriate for the type of file: *Faxing, Filing and Copying; Text for OCR; Photos; Photos (High Quality); Photos (Quick Scan); Custom; Draft Copy or Fine Copy.*

To change any of the settings for that mode, click the **Modify Settings...** button.

## Word Processor

*Word Processor*—From the pull-down list, select the word processor you want to use.

Click the **Link Settings...** button to display a screen to set up a link to the version of OCR and document format that you want to use:

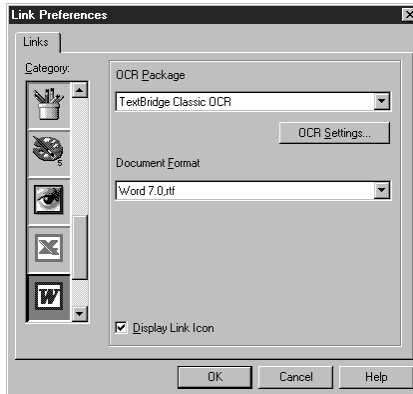



**OCR Package**—From the pull-down list, select *TextBridge Classic* OCR if you want to use the OCR package that was installed with the Brother software.

Click the **OCR Settings...** button to choose how the OCR application will read the pages you scan into your word processor application.

The Preferences window will appear:

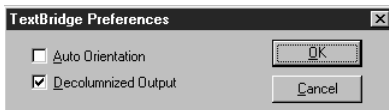

Select your setting and click **OK**.

- ◆ **Auto Orientation**—Check this checkbox if you want your word processor application to read the page as it is set up.
- ◆ **Decolumnized Output**—Check this checkbox if you want your word processor application to read across the entire page from left to right.

**Document Format**—From the pull-down list, select the file format you want to use for your word processor or text documents.

## User Defined Button

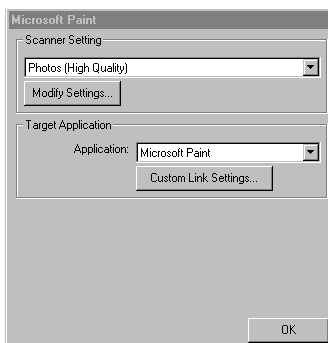

## Scanner Settings

From the pull-down list, select the scanning mode that is appropriate for the type of file: *Faxing, Filing and Copying; Text for OCR; Photos; Photos (High Quality); Photos (Quick Scan); Custom; Draft Copy* or *Fine Copy*.

To change any of the settings for that mode, click the **Modify Settings...** button.

## Target Application

**Application**—From the pull-down list, select the application you want to add to this Pop-Up screen. Click the **Custom Link Settings...** button to set up links for your user-defined application.

# Copy

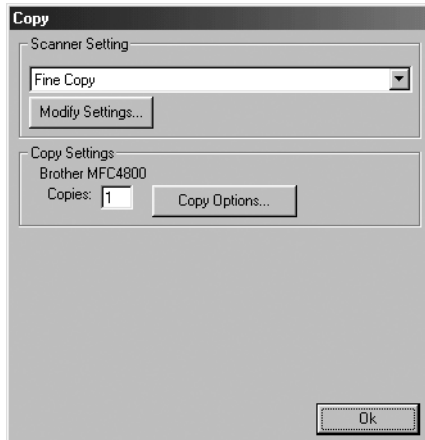

## Scanner Settings

---

From the pull-down list, select the scanning mode that is appropriate for the type of file: *Faxing*, *Filing and Copying*; *Text for OCR*; *Photos*; *Photos (High Quality)*; *Photos (Quick Scan)*; *Custom*; *Draft Copy* or *Fine Copy*.

To change any of the settings for that mode, click the **Modify Settings...** button.

## Copy Settings

---

Brother MFC-4800

**Copies**—Enter the number of copies you want to print.

To change the copy options, click the **Copy Options...** button.

Click the **OK** button to save your **Copy** settings.

# Send a Fax



## Scanner Settings

From the pull-down list, select the scanning mode that is appropriate for the type of file: *Faxing, Filing and Copying*; *Text for OCR*; *Photos*; *Photos (High Quality)*; *Photos (Quick Scan)*; *Custom*; *Draft Copy* or *Fine Copy*.

To change any of the settings for that mode, click the **Modify Settings...** button.

## FAX Settings

### Brother MFL Pro Fax

**FAX Resolution**—*Fine (200 x 200)*

- 1 To change the fax options, click the **FAX Options...** button.

The Brother PC-FAX Properties screen appears:

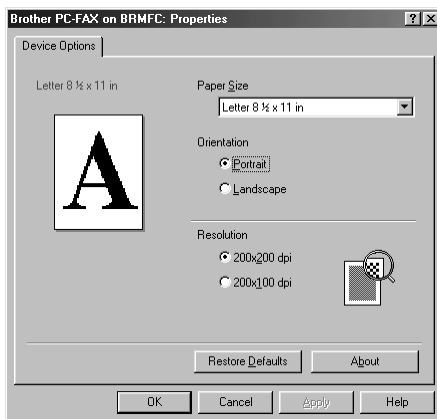

- 2 Select the **Paper Size** and **Orientation (Portrait or Landscape)** and click **OK**.



To return to the factory default settings, click the **Restore Defaults** button.

# 15 Using ScanSoft™ PaperPort® for Brother and ScanSoft™ TextBridge®

ScanSoft™ PaperPort® for Brother is a document management application. You will use PaperPort® to view scanned documents. PaperPort® has a sophisticated, yet easy-to-use, filing system that will help you organize your documents. It allows you to combine or “stack” documents of different formats for printing or filing. PaperPort® can be accessed through the PaperPort® program group.

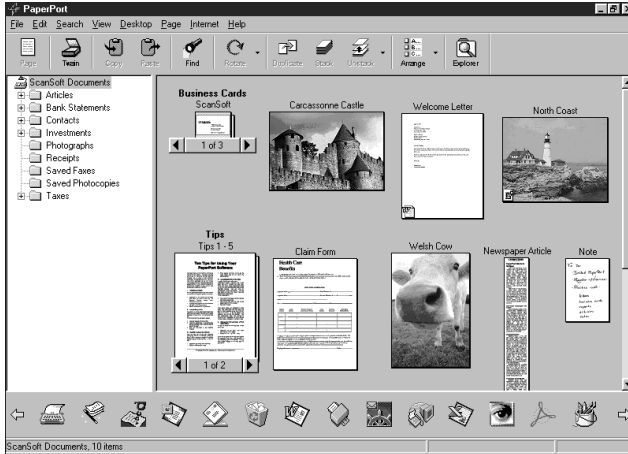

The complete ScanSoft™ PaperPort® Owner’s Manual, including ScanSoft™ TextBridge® OCR, is in the **On-Line Documentation** on the CD-ROM. This chapter is only an introduction to the basic operations.

When you install Multi-Function Link® Pro Suite, ScanSoft™ PaperPort® for Brother and ScanSoft™ TextBridge® OCR are installed with it automatically.



## To Uninstall PaperPort® and ScanSoft™ TextBridge®

Select **Fax Start, Settings, Control Panel, Add/Remove Programs** and the **Install/Uninstall** tab. Select PaperPort® from the list and click the **Add/Remove** button.

## Viewing Items in ScanSoft™ PaperPort® for Brother

PaperPort® provides several ways to view items: **Desktop View** displays a **thumbnail**, a small graphic that represents each item in a Desktop or folder. Items in the selected folder appear on the PaperPort® Desktop. You can see PaperPort® items (MAX files) and non-PaperPort® items (files created using other applications).

Non-PaperPort® items include an icon that indicates the application that was used to create the item; a non-PaperPort® item is represented by a small rectangular thumbnail and not an actual image.

**Page View** displays a close-up of a single page and you can open a PaperPort® item by double-clicking on it. As long as you have the appropriate application on your computer to display it, you can also double-click a non-PaperPort® item to open it.





## Accessing the Scanner

To choose **TWAIN-32 Brother MFL Pro Scanner** as your scanner driver, select it under the “**Select scanner**”—OR—“**Select source**” option in your software.

From the PaperPort® window, select **Acquire** from the File drop-down menu or select the **TWAIN** or **Scan** button. The TWAIN-32 Brother MFL Pro Scanner Setup dialog box will appear:

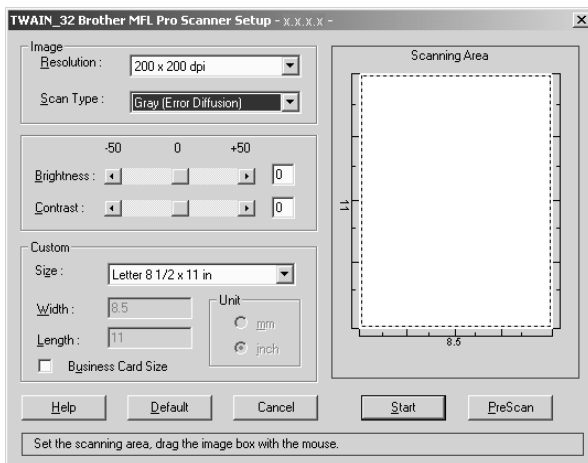

## Scanning a Document into your PC

- 1 Insert the document face down in the ADF.
- 2 Adjust the following settings, if needed, in the Scanner Setup window:
  - ◆ **Resolution**
  - ◆ **Scan Type** (*Black & White, Gray [Error Diffusion], True Gray*)
  - ◆ **Brightness**
  - ◆ **Contrast**
  - ◆ **Size**
- 3 Select the **Fax Start** button from the Scanner window.

When scanning is completed, close the scanner window. The PaperPort® screen will appear showing the image you scanned highlighted in red.

## Settings in the Scanner Window

### Image

#### Resolution

Select the scanning resolution from the Resolution drop down list. Higher resolutions take more memory and transfer time, but can achieve a finer scanned image.

When the setting is *True Gray*, *200 x 100 dpi* and *200 x 400 dpi* is not available.

## Scan Type

Gray Scale: Set the image Type to *Black & White* for text or line art. For photographic images, set the image type to *Gray (Error Diffusion)* or *True Gray*.

*Gray (Error Diffusion)* is used for documents that contain photographic images or graphics. (*Error Diffusion* is a method for creating simulated gray images by placing black dots in a specific matrix instead of true gray dots.)

*True Gray* mode is used for documents containing photographic images or graphics. This mode requires the most memory and longest transfer time.

## Brightness

Adjusting the brightness settings to obtain the best image. The Brother Multi-Function Link<sup>®</sup> Pro Suite offers 100 brightness settings (-50 to 50). The default value is 0, representing an “average” setting.

You can set the brightness level by dragging the slider to the right to lighten the image or to the left to darken the image. You can also type a value in the box to set the settings.

If the scanned image is too light, set a lower brightness value and scan the document again.

If the image is too dark, set a higher brightness value and scan the document again.

## Contrast

The contrast setting is adjustable only when you have selected one of the gray scale settings, but it is not available when *Black & White* is selected as the gray Scale.

Increasing the contrast level (by dragging the slider to the right) emphasizes dark and light areas of the **Image**, while decreasing the contrast level (by dragging the slider to the left) reveals more detail in gray areas. Instead of using the slider, you can type a value in the box to set the contrast.

## Custom

### Size

Set the **Size** to one of the following:

- ◆ *Letter (8 1/2 x 11 inches)*
- ◆ *A4 (210 x 297 mm)*
- ◆ *Legal (8 1/2 x 14 inches)*
- ◆ *A5 (148 x 210 mm)*
- ◆ *B5 (182 x 257 mm)*
- ◆ *Executive (7 1/4 x 10 1/2 inches)*
- ◆ *Business Card (60 x 90 mm)*
- ◆ *Custom (User adjustable from 0.35 x 0.35 in. to 8.5 x 14 inches)*

After you select a custom size, you can adjust the scanning area further by using the left mouse button to drag the dotted outline of the scanning area. This is required when you want to crop an image when scanning.

### Business Card Size

To scan business cards, select the **Business Card (60 x 90 mm) size** setting and place the business card at the top centre of a carrier sheet.



Carrier sheets are available from your Dealer.



When scanning photographs or other images for use in a word processor or other graphics application, you should try different settings for the contrast, mode and resolution to see which settings best suit your needs.

## PreScanning an Image

PreScanning allows you to scan an image quickly at a low resolution. A thumbnail version of the image will appear in the **Scanning Area**. This is only a preview of the image so you can see how it will look. The **PreScan** button is used to preview an image for cropping any unwanted portions from the image. When you are satisfied with the preview, select the **Fax Start** button to scan the image.

**1** Insert the document face down in the ADF.

**2** Select the **PreScan** button:

The entire document will be scanned into the PC and will appear in the **Scanning Area** of the Scanner window.

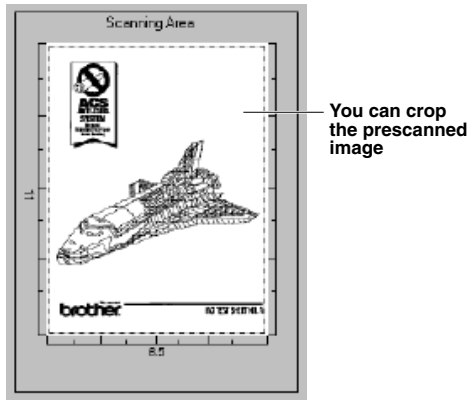

**3** To crop a portion of the document to be scanned, drag any side or corner of the dotted outline in the **Scanning Area** with the left mouse button. Adjust the dotted outline until it surrounds only the portion of the document you wish to scan.

**4** Place document in the document feeder of the machine again.

**5** Adjust the settings for **Resolution**, **Scan Type**, **Brightness**, **Contrast**, and **Size** in the Scanner Setup window, as needed.

**6** Select the **Fax Start** button.

This time only the selected area of the document will appear in the PaperPort<sup>®</sup> window.

**7** In the PaperPort<sup>®</sup> window, use the options available in the Markups pull-down menu and the Crop option in the Options pull-down menu to refine the image.

## Introduction

This chapter outlines the basics of the Brother software, so you can get started using the Multi-Function Link® Pro Suite software. Detailed installation and setup instructions are in the On-Line Documentation section of the Brother CD-ROM that is included with the machine.

Multi-Function Link® Pro Suite software for the machine includes ScanSoft™ PaperPort® for Brother and ScanSoft™ TextBridge®. (See *Using ScanSoft™ PaperPort® for Brother and ScanSoft™ TextBridge®*, page 89.)

## Brother Resource Manager

The Brother Resource Manager application must be running for you to use the machine with your Windows® computer. Multi-Function Link® Pro Suite software and the MFL Pro Suite Printer Driver automatically load the Resource Manager, as needed. The Resource Manager allows the single bi-directional Parallel port on the machine to simulate a Communications port for faxing and scanning and to simulate a Parallel port for Windows® GDI printing.

## MFC Remote Setup

The MFC Remote Setup application allows you to quickly set up the machine by taking advantage of the ease and speed of programming on your PC. When you access this application, the settings on the machine will be downloaded automatically to your PC and displayed on your computer screen. If you change the settings, you can upload them directly to the machine.

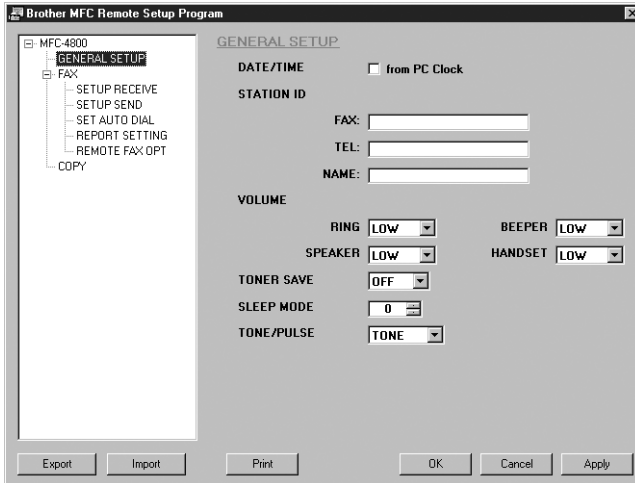

### OK

This starts the process of uploading the data to the machine and exiting the remote setup program. If an error message is displayed enter the correct data again, then click **OK**.

### Cancel

This exits the remote setup application without uploading the data to the machine.

## Apply

This uploads the data to the machine, but does not exit the remote setup application.

## Print

This command prints the selected items on the machine. You can not print the data until it is uploaded to the machine. Click **Apply** to upload the new data to the machine and click **Print**.

## Export

This command saves the current configuration settings to a file.

## Import

This command reads the settings from a file.

# PC FAX Sending (For Windows® Only)

The Brother PC FAX feature allows you to use your PC to send a file. You can create a file in any application on your PC, and then send it as a PC FAX. You can even attach a cover page. All you have to do is set up the receiving parties as Members or Groups in your PC-FAX Address Book. Then you can use the Address Book Search feature to quickly find them to address your fax.

## Setting Up User Information

- 1 From the **Fax Start** menu, select **Programs, Brother, Brother MFL Pro Suite**, and then select **PC-FAX Setting**.



You can also access the Brother PC-FAX Setup dialog box from the FAX Sending dialog box by clicking . (See *Sending a File as a PC FAX Using the Simple Style*, page 105.)

The **Brother PC-FAX Setup** dialog box will appear:

Field	Value
Name:	John Doe
Company:	International Spring Board Assoc.
Department:	U56
Phone Number:	908-555-1212
Fax Number:	908-555-1212
E-mail:	JDoe@springboard.org
Address 1:	123 Rose Hill Drive
Address 2:	Poterville, NJ 08688

- 2 Enter the required **User information**. This information is required to create the Fax Header and Cover Page.
- 3 To save the **User Information**, click **OK**.

## Setting Up Sending

To access the Sending tab from the **Brother PC-FAX Setup** dialog box, click the **Sending** tab.

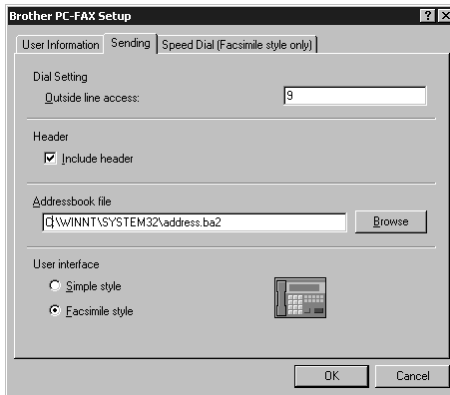

### Outside line access

Enter the number needed to access an outside line. This is sometimes required by the local PBX telephone system.

### Include header

To add header information to the top of the fax pages being sent, check the **Header** box.

### Addressbook file

You can select different database files for use with the address book. You must enter the path and file name of the database file or use the **Browse** button to view the file system to select the file.

### User interface

To select User Interface for the sending dialog box. You have a choice of the **Simple Style** or the **Facsimile Style**.

#### Simple Style

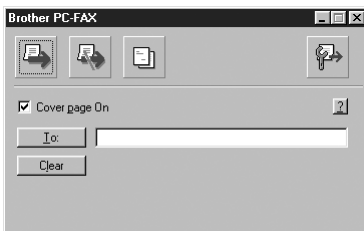

#### Facsimile Style



## Setting Up Speed Dial

Access the **Speed Dial** tab from the **Brother PC-FAX Setup** dialog box by clicking the **Speed Dial** tab. (To use the feature you must select the Facsimile Style user interface.)

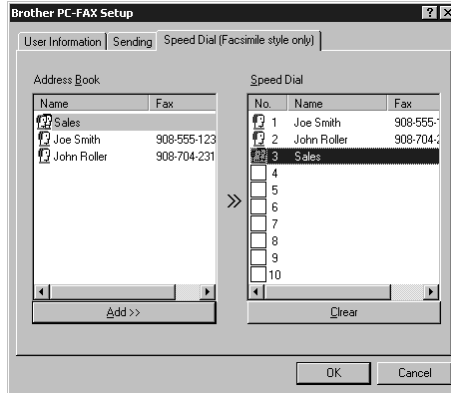

You can register any address or group on one of the ten Speed Dial buttons.

### To register an address on a Speed Dial location:

- 1 Click the Speed Dial location you want to program.
- 2 Click the address or group you wish to assign to the Speed Dial location.
- 3 Click the **Add >>** button to program the Speed Dial location.

### To clear a Speed Dial location:

- 1 Click the Speed Dial location you want to clear.
- 2 Click the **Clear** button.

# The Address Book

From the **Fax Start** menu, select **Programs, Brother, Brother MFL Pro Suite**, and then click **Address Book**.

The **Brother Address Book** dialog box will appear:

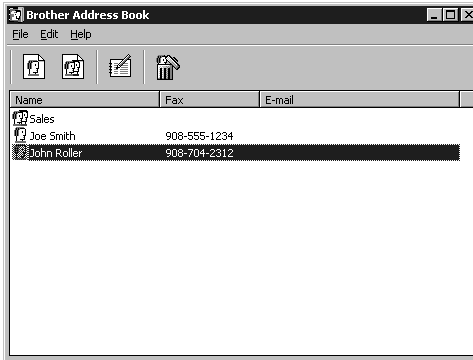

## Setting Up a Member in the Address Book

In the **Brother Address Book** dialog box you can add, edit and delete stored information for members and groups.

- 1 In the **Address Book** dialog box, click the  icon to add a member.  
The **Brother Address Book Member Setup** dialog box will appear:

Name:	<input type="text" value="Joe Smith"/>	Title:	<input type="text" value="Mr."/>
Company:	<input type="text" value="Brother International Corp."/>		
Department:	<input type="text" value="Sales"/>	Job Title:	<input type="text" value="Sales Rep."/>
Street Address:	<input type="text" value="100 SomeStreet"/>		
City:	<input type="text"/>	State/Province:	<input type="text" value="N.J."/>
Zip Code/Post Code:	<input type="text" value="08807"/>	Country/Region:	<input type="text" value="USA"/>
Business Phone:	<input type="text" value="908-555-1234"/>	Home Phone:	<input type="text"/>
Fax:	<input type="text" value="908-555-1234"/>	Mobile Phone:	<input type="text"/>
E-Mail:	<input type="text" value="joe.smith@*****.com"/>		
MFC E-mail Address:	<input type="text"/>		

- 2 In the **Brother Address Book Member Setup** dialog box, type the member's information. **Name** and **Fax** are required fields. Click the **OK** button to save the member's information.

## Setting Up a Group for Broadcasting

---

If you repeatedly send the same PC-FAX to multiple recipients, you can combine members into a Group.

- 1 In the **Brother Address Book** dialog box, click the  icon to create a group.  
The **Brother Address Book Group Setup** dialog box appears:

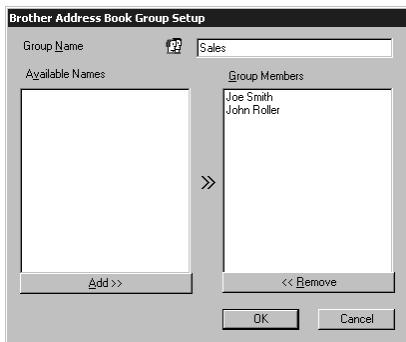

- 2 Type the name of the new group in the **Group Name** field.
- 3 In the **Available Names** box, select each member to be included in the Group, and then click **Add>>**.  
Members you add to the group will be listed in the **Group Members** box.
- 4 After all the members have been added, click **OK**.

## Editing Member Information

---

**To edit a Member or Group:**

- 1 Select the Member or Group you want to edit.
- 2 Click the **Edit**  icon.
- 3 Edit the Member or Group information.
- 4 Click **OK** to save your changes.

## Deleting a Member or Group

---

**To delete a Member or Group:**

- 1 Select the Member or Group you want to delete.
- 2 Click the **Delete**  icon.
- 3 Click **OK** when the **Delete OK?** dialog appears.

## Exporting the Address Book

You can export the address book to an ASCII text file (\*.csv).

### To export the current telephone book:



If you are creating a Vcard, you must first select the member.

- 1 From the Address Book select **File**, point to **Export**, and then click **Text**—**OR**—Click **Vcard** and go to Step 5.
- 2 Select the data fields you wish to Export from the **Available Items** column, and then click **Add>>**.



Select items in the order you want them listed.

- 3 If you are exporting to an ASCII file, select **Divide Character - Tab** or **Comma**. This selection inserts a Tab or Comma between each data field when it is Exported.
- 4 Select the **OK** button to save the data.

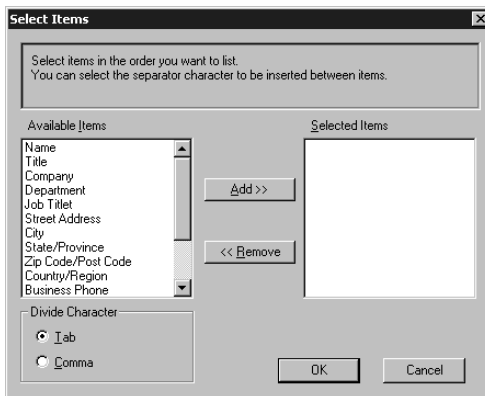

- 5 Type in the name of the file, and then select **Save**.

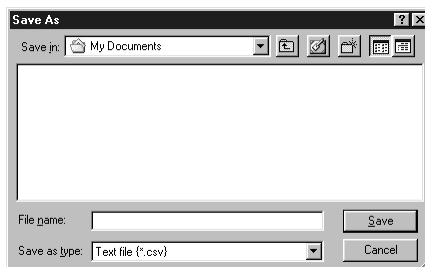



# Importing to the Address Book

You can import ASCII text files (\*.csv) or Vcards into your Address Book.

## To import an ASCII text file:

- 1 From the Address Book select **File**, point to **Import**, and then click **Text**—OR—Click **Vcard** and go to Step 5.

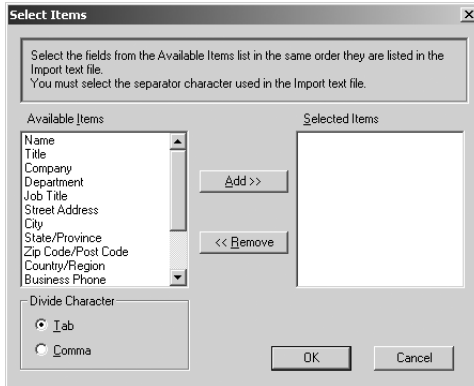

- 2 Select the data fields you wish to Import from the **Available Items** column and click **Add>>**.



Select the fields from the Available Items list in the same order they are listed in the Import text file.

- 3 Select **Divide Character - Tab** or **Comma** based on what file format you are importing.
- 4 Select the **OK** button to import the data.
- 5 Type the name of the file and select **Open**.

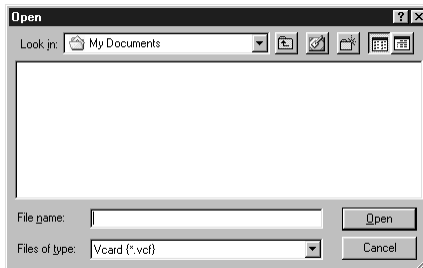

## Setting Up Cover Page

Access the Brother PC-FAX Cover Page Setting from the FAX Sending dialog box by clicking  .  
(See *Sending a File as a PC FAX Using the Simple Style*, page 105.)

The **Brother PC-FAX Cover Page Setup** dialog box will appear:

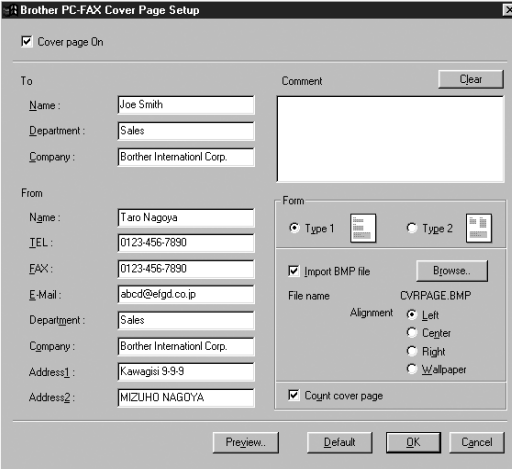

### To

You can enter information in each box.



If you are sending a fax to multiple recipients, the recipient information will not be printed on the Cover Page.

### From

You can enter information in each box.

### Comment

Type the comment you want to add to the cover page.

### Select Cover Page Form

Select the cover page form you want.

### Import BMP file

You can insert a bitmap file, such as your company logo, in the cover page.

Select the BMP file by using the **browse** button, and then select the alignment style.

### Count Cover Page

When this box is checked, the Cover Page will be included in the page numbering. When this box is not checked, the Cover Page will not be included.

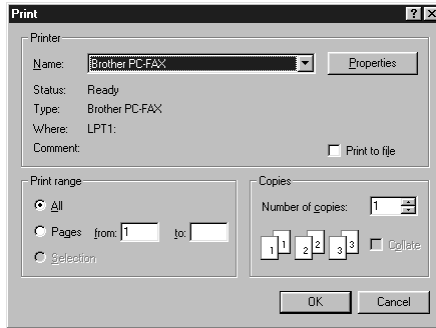

## Sending a File as a PC FAX using the Facsimile Style

- 1 Create a file in Word, Excel, Paint, Draw, or any other application on your PC.
- 2 From the **File** menu, select **Print**.  
The **Print** dialog box will appear:



- 3 Select **Brother PC-FAX** as your printer, and then click **OK**.  
The FAX Sending dialog box will appear:



- 4 Enter a telephone number by using any of the following methods:
  - A. Enter the number using the numeric keypad.
  - B. Click any of the 10 **Speed Dial** buttons.
  - C. Click the **Address Book** button, and then select a Member or Group from the Address Book.
- 5 If you make a mistake you can use the **Clear** button to clear all the entries.
- 6 To include, click the  **Cover Page On (P)**. You can also click the  icon to create or edit an existing cover page.
- 7 Click **Start** to send the fax.
- 8 If you wish to cancel the fax, click **Stop**.

### Redial:

If you wish to redial a number, press **Redial** to scroll through the last five fax numbers.

## Sending a File as a PC FAX Using the Simple Style

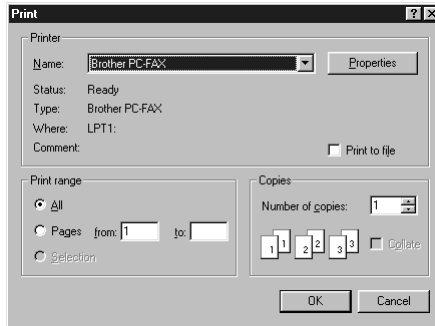

---

- 1 Create a file in Word, Excel, Paint, Draw, or any other application on your PC.
- 2 From the **File** menu, select **Print**.  
The **Print** dialog box will appear:

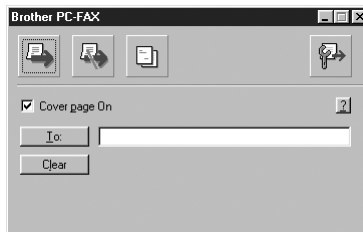

- 3 Select **Brother PC-FAX** as your printer, and then click **OK**.  
The FAX Sending dialog box will appear:



- 4 In the **To:** field, type the fax number of the receiving party. You can also use the Address Book to select destination fax numbers by clicking **To:** button. If you made a mistake entering a number, click the **Clear** button to clear all entries.
- 5 To send a Cover Page and note, click the **Cover Page On (P)** check box. You can also click the  to create or edit an existing cover page.
- 6 When you are ready to send your fax, click the  icon.
- 7 If you wish to cancel the fax, click the  icon.

**For Windows<sup>®</sup> 95, 98, 98SE, Me Only****Main Features**

- You can use Automatic E-Mail Printing with other E-mail software:  
Brother Automatic E-Mail Printing has some extra functions that other E-mail software, such as Netscape Navigator? or MS Internet Mail, do not support.
- Automatic E-Mail Printing can be configured for a multiple user account:  
In Brother Automatic E-Mail Printing you can set up more than one e-mail account on a single PC so you can print e-mail in each account automatically.
- Automatic access to your specified POP3 server at the specified time:  
You can specify the time when the Brother Automatic E-Mail Printing automatically accesses the server to check for new mail.
- Provides an "In Memory" printer driver:  
You can receive and print e-mail data at the same time, by searching for a specified character string in the mail header. It allows you to see the sender, subject and relevant part of the mail content.

**Before You Use this Software**

Please read *Using Automatic E-Mail Printing* in the **On-Line Documentation** on the CD-ROM. Check the online README.WRI file in the root directory of the CD-ROM for last-minute important information and troubleshooting tips not included in the On-Line Documentation.

**To Access the On-Line Documentation**

After you have installed the Brother driver(s) for your model and operating system, click **View On-Line Documentation** for operating instructions.

**To Install Automatic E-mail Printing (Optional Application):**

- 1 Insert MFL Pro CD-ROM into your CD-ROM drive.
- 2 Click on **Install Software** from the main CD-ROM screen.
- 3 Click **Automatic E-mail Printing**.



This is optional software and will not be required for printing, faxing and scanning operations.

**The Automatic E-mail Printing option is NOT available for Windows NT<sup>®</sup> 4.0 and Windows<sup>®</sup> 2000 Professional.**

## Set up Your USB Equipped Apple® Macintosh® G3, G4 or iMac™ with Mac OS 8.5/8.5.1/8.6/9.0/9.0.4/9.1



Before you can connect the machine to your Macintosh®, you must purchase a USB cable that is no longer than 6 feet (1.8 meters).

To work with the machine, your USB-Equipped Apple® Macintosh® must be set up with Mac OS 8.5/8.5.1/8.6/9.0/9.0.4/9.1. (The Brother Scanner Driver works only with Mac OS 8.6/9.0/9.0.4/9.1.)

## Using Brother Printer Driver with your Apple® Macintosh®

To select the Printer:

- 1 From the Apple menu, open the **Chooser**.

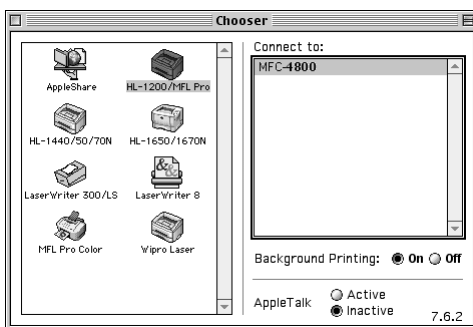

- 2 Click the **HL-1200/MFL Pro** icon. On the right side of the **Chooser**, click the printer to which you want to print. Close the **Chooser**.

**To print the document:**

- From application software such as PaperPort®, click **File** menu and select **Page Setup**. You can change the settings for **Paper Size**, **Orientation** and **Scaling**, then click **OK**.

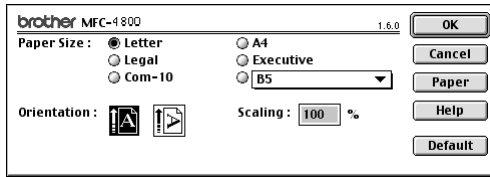

- From application software such as PaperPort, click **File** menu and select **Print**. Click **Print** to start printing.

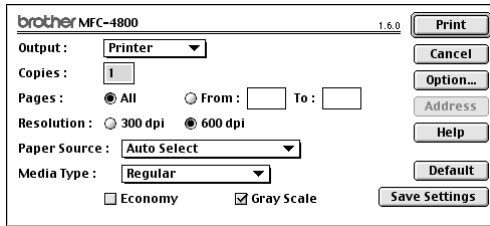

If you want to change **Copies**, **Pages**, **Resolution**, **Paper Source** and **Media Type**, select your settings before clicking **Print**. **Option Setup** allows you to change **Duplex**.

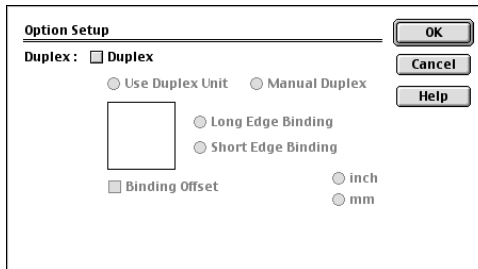

# Sending a Fax from your Macintosh Application

You can send a fax directly from your Macintosh application using the following steps:

- 1 Create a document in a Macintosh application.
- 2 To begin the fax transmission, select **Print** from the **File** menu.

The **Printer** dialog box appears:

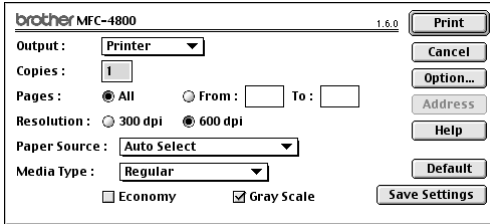

When *Printer* is selected, the top button shows **Print** and the **Address** button is greyed.

- 3 From the **Output** pull-down menu, select *Facsimile*.

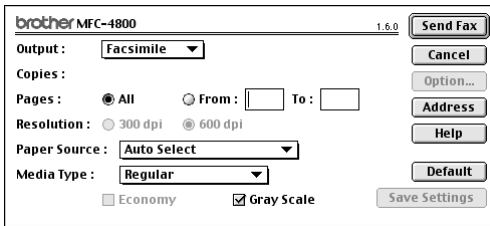

When *Facsimile* is selected, the top button shows **Send Fax** and the **Address** button is available.

- 4 Click **Send Fax**.

The **Address Book** dialog box appears:

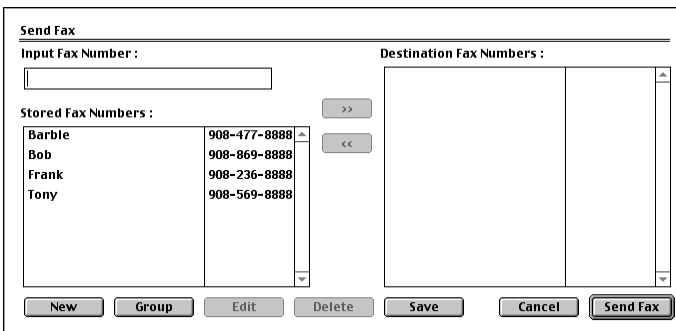

The **Address Book** dialog box has two list boxes. The left box shows all the previously **Stored Fax Numbers**; the right box will show the **Destination Fax Numbers** as you select them.



**5** To address the fax, type a fax number in the **Input Fax Number** box.

—OR—

Select a name/number from the **Stored Fax Numbers** box, and then click >>. Your recipient will appear in the **Destination Fax Numbers** box.



You can select several stored numbers at once by using the Shift and Ctrl keys.

**6** If you want to, you can add your new recipients to the **Address Book** at this time by clicking **New** to open the **Address Book** dialog box. (See *Adding a New Member*, page 111.)

—OR—

You can add a new group by clicking **Group**. (See *Adding a New Group*, page 112.)

**7** If you have finished addressing your fax, click **Send Fax**.



To select and send only certain pages of the document, enter the page numbers in the **From:** and **To:** boxes in the Facsimile dialog box.



If you click **Send Fax** without addressing your fax, the following error message appears:

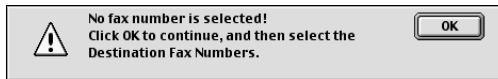

Click **OK** to return to the **Address Book** dialog box.

# Setting Up Your Address Book

You can add new members and groups to your Address Book, even while you are addressing a fax.

## Adding a New Member

- 1 To add a new member to the Address Book, in the Facsimile dialog box click **Address**.  
The **Address Book** dialog box appears:

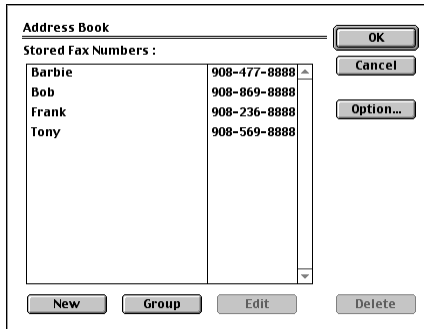

The Address Book dialog box contains a table of stored fax numbers and several control buttons.

Stored Fax Numbers :	
Barbie	908-477-8888
Bob	908-869-8888
Frank	908-236-8888
Tony	908-569-8888

Buttons: OK, Cancel, Option..., New, Group, Edit, Delete

- 2 Click **New**.

The following dialog box appears:

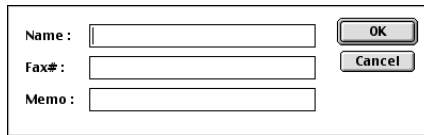

The New Member dialog box has three input fields and two buttons.

Name :

Fax# :

Memo :

Buttons: OK, Cancel

- 3 Type the name and fax number.
- 4 If you want to, you can store a comment in the Memo field if you wish (up to 15 characters).
- 5 Click **OK** to return to the **Address Book** dialog box.

## Adding a New Group

You can set up a group of multiple recipients.

### 1 Click **Group**.

The **Group Setting** dialog box appears:

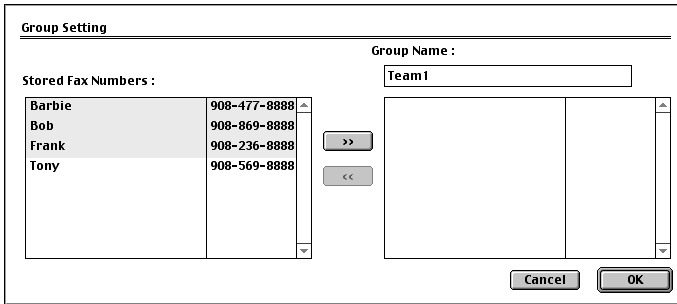

### 2 In the **Group Name** field, type a name for your Group.

### 3 From the **Stored Fax Numbers** box select the recipients for your Group, and then click >>. Your selection will appear in the box under the **Group Name** field.

### 4 Click **OK**.

The **Address Book** dialog box reappears:

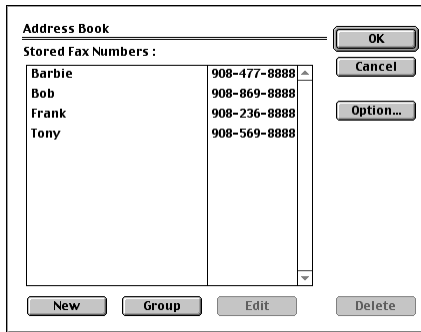

### 5 Click **OK**.

The **Print/Facsimile** dialog box reappears:

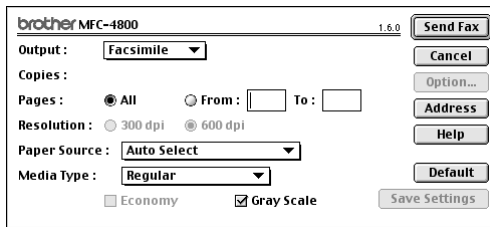

### 6 If you are ready to send your fax, click **Send Fax**. (Follow the steps on page 109 for sending a fax.)

# Using Brother TWAIN Scanner Driver with Your Apple® Macintosh®

The Brother MFC software includes a TWAIN Scanner driver for Macintosh®. This Macintosh® TWAIN Scanner driver can be used with application that supports the TWAIN specification. You can use PaperPort for scanning.

## Accessing the Scanner

Run your PaperPort® software. You will see the PaperPort® icon in the upper right hand corner of your screen. The first time you use the Brother TWAIN driver, set it as the default by choosing the “**Select Source**”, then click the **PaperPort** icon. Afterward, for each document you scan choose “**Acquire Image**” by clicking the **PaperPort** icon. The Scanner setup dialog box will appear.

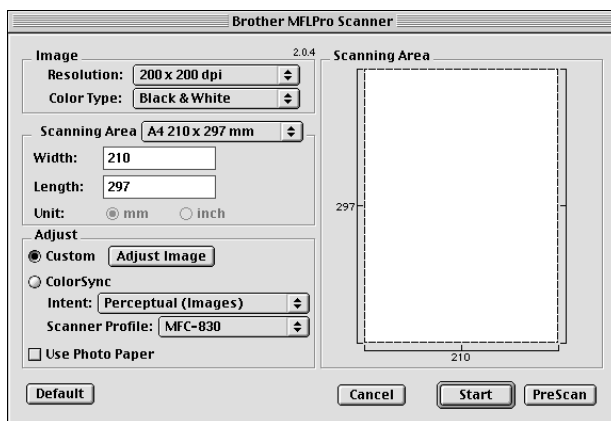

## Scanning a Document into Your Macintosh G3, G4 or iMac

- 1 Insert the document face down in the ADF.
- 2 Adjust the following settings, if needed, in the scanner setup dialog box:
  - Resolution**
  - Color Type**
  - Brightness**
  - Contrast**
  - Scanning Area**

- 3 Click **Fax Start**.

When scanning is finished, the image will appear in your graphics application.

# Settings in the Scanner Window

## Image

### Resolution

Choose the scanning resolution from the **Resolution** pop-up menu. Higher resolutions take more memory and transfer time, but can achieve a finer scanned image. (Each model has different resolutions. See *Specifications*, page 143.)

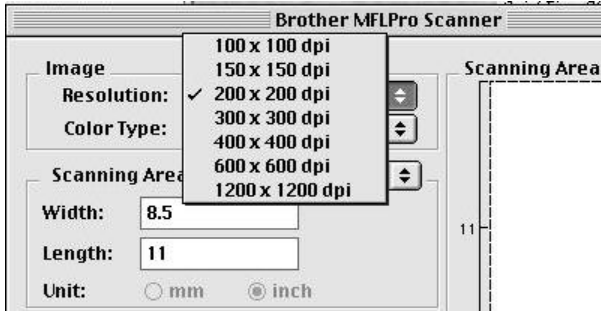

### Color Type

**Black & White**—Set the image Type to *Black & White* for text or line art. For photographic images, set the image type to *Grey (Error diffusion)* or *True Grey*.

**Grey (Error Diffusion)**—is used for documents that contain photographic images or graphics. (*Error Diffusion* is a method for creating simulated grey images by placing black dots in a specific matrix instead of true grey dots.)

**True Grey**—also is used for documents containing photographic images or graphics. This mode is more exact because it uses up to 256 shades of grey. It requires the most memory and longest transfer time.

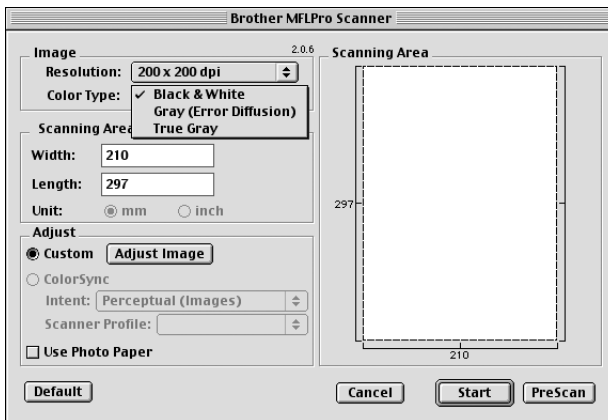

## Scanning Area

Set the **Size** to one of the following:

- ◆ *Letter (8.5 × 11 inches)*
- ◆ *A4 (210 × 297 mm)*
- ◆ *Legal (8.5 × 14 inches)*
- ◆ *A5 (148 × 210 mm)*
- ◆ *B5 (182 × 257 mm)*
- ◆ *Executive (7.25 × 10.5 inches)*
- ◆ *Business Card (90 × 60 mm)*
- ◆ *Custom (User adjustable from 0.35 × 0.35 inches to 8.5 × 14 inches)*

After you choose a custom size, you can adjust the scanning area. Click and hold the mouse button as you drag the mouse to crop the image.

**Width:** Enter the width of the custom size.

**Length:** Enter the length of the custom size.

## Business Card Size

To scan business cards, select the Business Card size setting (90 × 60 mm), and then place the business card at the top center of a carrier sheet.



Carrier sheets are available from your Dealer.

When scanning photographs or other images for use in a word processor or other graphics application, it is a good idea to try different settings for the Contrast, Mode and Resolution to determine which settings look best.

## Adjust Image

### Brightness

Adjust the brightness settings to obtain the best image. The Brother TWAIN Scanner driver offers 100 brightness settings (-50 to 50). The default value is 0, representing an “average” setting.

You can set the brightness level by dragging the slider to the right to lighten the image or to the left to darken the image. You can also type a value in the box to set the setting. Click **OK**.

If the scanned image is too light, set a lower brightness value and scan the document again.

If the image is too dark, set a higher brightness value and scan the document again.

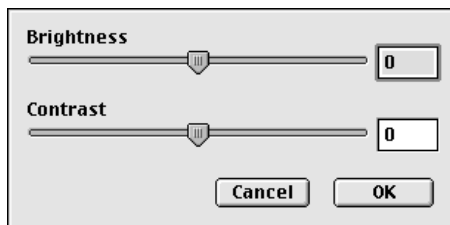

### Contrast

The contrast setting is adjustable only when you have selected one of the grey scale settings, but it is not available when Black & White is selected as the grey scale.

Increasing the contrast level (by dragging the slider to the right) emphasizes dark and light areas of the Image, while decreasing the contrast level (by dragging the slider to the left) reveals more detail in grey areas. Instead of using the slider, you can type a value in the box to set the contrast. Click **OK**.

## PreScanning an Image

PreScanning allows you to scan an image quickly at a low resolution. A thumbnail version will appear in the **Scanning Area**. This is only a preview of the image, so you can see how it will look. The **PreScan** button is used to preview an image for cropping any unwanted portions from the image. When you are satisfied with the preview, click **Fax Start** to scan the image.

**1** Insert the document face down in the ADF.

**2** Click **PreScan**.

The entire document will be scanned into your Macintosh will appear in the **Scanning Area** of the Scanner dialog box:

**3** To scan a portion of the prescanned image, click and drag the mouse to crop it.

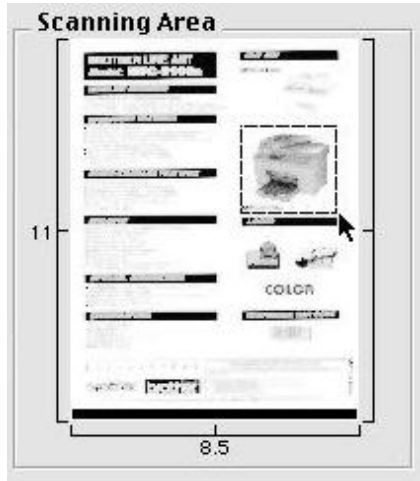

**4** Insert document face down in the ADF of the Brother MFC again.

**5** Adjust the settings for **Resolution**, **Color Type** (Grey Scale), **Brightness**, **Contrast**, and **Size** in the Scanner Setup dialog box, as needed.

**6** Click **Fax Start**.

This time only the selected area of the document will appear in the **Scanning Area**.

**7** Use your application, software for editing and refining the image as usual.

# 19 Troubleshooting and Maintenance

## Error Messages

You may occasionally encounter a difficulty with the machine or telephone line. If this happens, the machine often identifies the problem and displays an error message. The list below explains the most common error messages, in alphabetical order.

ERROR MESSAGE	CAUSE	ACTION
<b>CHANGE DRUM SOON</b>	The drum unit is near the end of its life.	If you have a print quality problem, replace the drum unit with a new one.
<b>CHANGE TONER</b>	If the display shows <b>CHANGE TONER</b> , you can still print. But the toner is depleted and the machine is telling you that the toner will soon run out.	Order a new toner cartridge now.
<b>CHECK DOCUMENT</b>	Documents were not inserted or fed properly or document was too long.	Do not pull paper out until you see <i>Document Jam</i> , page 119.
<b>CHECK DRUM UNIT</b>	Drum unit is not installed.	Reinstall the drum unit.
<b>CHECK PAPER</b>	The machine is out of paper or paper is not properly loaded in the Multi-purpose Sheet Feeder.	Refill the paper or remove the paper and load it again and then press <b>Fax Start</b> .
<b>CHECK PAPER SIZE</b>	Paper Size is improper for fax receiving.	Load A4 paper in multi-purpose sheet feeder, and then press <b>Fax Start</b> .
<b>COMM.ERROR</b>	A poor quality phone line caused communications error.	Try the call again.
<b>CONNECTION FAIL</b>	You tried to poll a fax machine that is not in Polled Waiting mode.	Verify the other party's polling setup.
<b>COOLING DOWN WAIT FOR A WHILE</b>	The temperature of the drum unit or toner cartridge is too hot. The machine will pause its current print job and go into cooling down mode. During the cooling down mode, you will hear the cooling fan running while the display on the machine shows <b>COOLING DOWN</b> and <b>WAIT FOR A WHILE</b> .	You must wait and allow the machine to resume printing when it is ready.
<b>COVER OPEN</b>	The top cover was not completely closed.	Open, then close, the cover.
<b>DISCONNECTED</b>	The other party or other party's fax machine terminated the call.	Try to re-transmit or call the other party to see what happened.
<b>MACHINE ERROR XX</b>	Machine has a mechanical problem.	Unplug the machine. Then contact your Brother dealer for service.



ERROR MESSAGE	CAUSE	ACTION
<b>NO RESPONSE/BUSY</b>	The number you called does not answer or is busy. Or, you may have reached a number that is not connected to a fax machine.	Check the number and try again.
<b>NOT ASSIGNED NOT REGISTERED</b> (for some countries)	You tried to access a One Touch or Speed Dial number that is not programmed.	Set up the One Touch or Speed Dial number. (See <i>Storing One Touch Dial Numbers (For FAX-2850 Only)</i> , page 14 and <i>Storing Speed Dial Numbers</i> , page 15.)
<b>OUT OF MEMORY</b> (When the machine is used as a printer.)	The machine memory capacity has been exceeded.	<ul style="list-style-type: none"> <li>- If you have installed the Windows® driver, try again after setting the True Type mode to “Print as Graphics” in the PRINT menu of your application software.</li> <li>- Reduce the print resolution or reduce the complexity of your document.</li> </ul>
<b>PAPER JAM</b>	The recording paper is jammed in the machine.	See <i>Paper Jam</i> , page 119.
<b>PLS OPEN COVER</b>	A page, piece of paper or paper clip, etc. may be jammed inside the machine.	Open the top cover. If you see any jammed paper or other item, gently pull it out, then close the top cover. If the error message remains, open and close the top cover again. If the machine cannot reset itself and return to the date and time prompt, it will display <b>MACHINE ERROR XX</b> . Please call your Brother dealer for service.
<b>TONER EMPTY</b>	Toner is used up and printing is not possible, or toner cartridge is not installed into the drum unit.	Replace the toner cartridge with a new one, or install the toner cartridge into the drum unit. (See <i>Replacing the Toner Cartridge</i> , page 129.)

# Document Jams and Paper Jams

Based upon where the original document or printed sheet is jammed, follow the appropriate set of instructions to remove it.

## Document Jam

---

The documents were not inserted or fed properly, or were too long.

- 1 Open the control panel.
- 2 Carefully pull the document toward the front of the machine.
- 3 Close the control panel and press **Stop/Exit**.

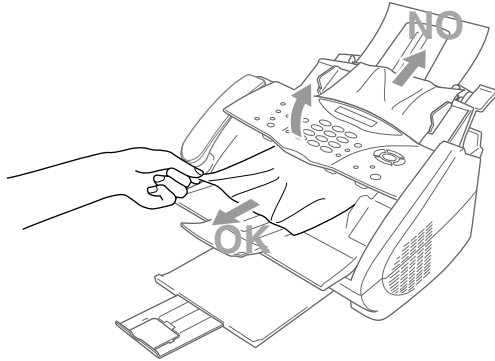

## Paper Jam

---

Before you can clear a paper jam error, you must find out where the paper is stuck. Use the diagram below to help locate the position of the paper.



**Do not force the jammed paper from the paper tray because you may damage the machine and cause toner to scatter.**

**After you have used the machine, some internal parts of the machine are extremely HOT! When you open the top cover of the machine, never touch the shaded parts shown in the following diagram.**

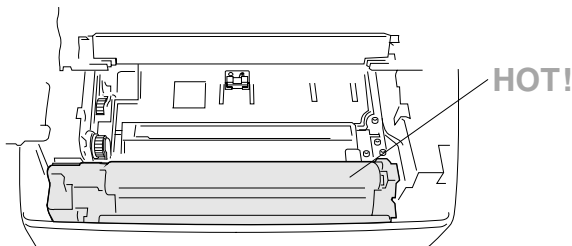

▲ Inside the Fax Machine

■ Clearing a Paper Jam in the Multi-purpose Sheet Feeder.

If paper is jammed inside the Multi-purpose Sheet Feeder, push down the paper lever to pull the jammed paper upwards out of the feeder. Also, open the top cover and check that a torn piece of paper does not remain inside the machine.

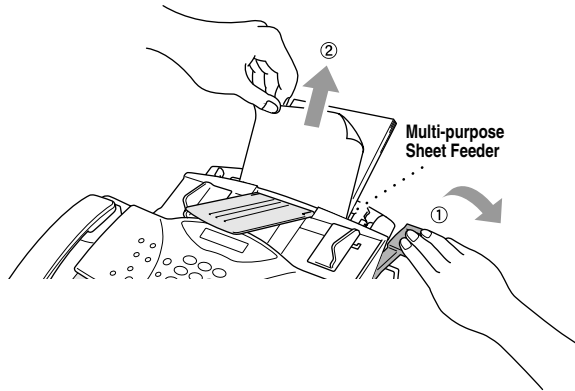

■ Clearing a Paper Jam near the Drum Unit.

If paper is jammed near the drum unit, open the top cover and remove the drum unit. Then, pull the jammed paper upwards and out of the machine. Reinstall the drum unit and close the top cover.

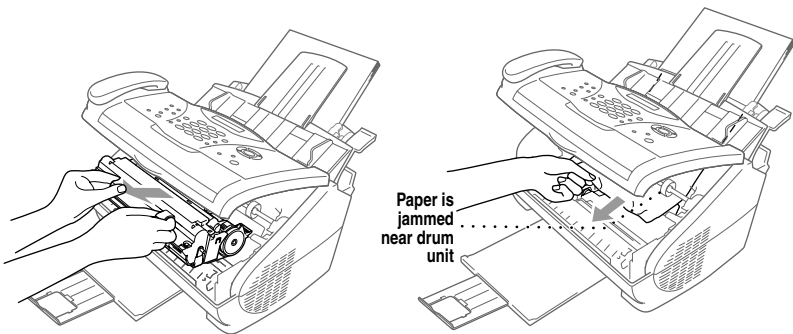









## Difficulty with Operation

If you think there is a problem with the machine, make a copy first. If the copy looks good, the problem is probably not the machine. Check the table below and follow the troubleshooting tips.

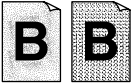
DIFFICULTY	SUGGESTIONS
<b>Printing and Receiving Faxes</b>	
Condensed print and horizontal streaks/top and bottom of sentences are cut off.	If your copy looks good, you probably had a bad connection, with static or interference on the phone line. Try again and see if there is an improvement. If a copy looks worse, then call your Brother dealer for service.
Vertical streaks/black lines appear on the fax you receive	Sometimes you may see vertical streaks/black lines on the faxes you receive. Either the machine's primary corona wire for printing may be dirty, or the sending party's fax scanner may be dirty. Clean your primary corona wire, or ask the sender to make a copy to see if the problem is with the sending machine. Try receiving from another fax machine. If the problem continues, call Brother dealer for service.
Machine "hears" voice as CNG tone	If the machine is set to Fax Detect (with an External Telephone) ON, it is more sensitive to sounds. The machine may mistakenly interpret certain voices or music on the line as a calling fax machine and respond with fax receiving tones. Deactivate the fax by pressing <b>Stop/Exit</b> . Try avoiding this problem by turning Fax Detect (with an External Telephone) to OFF. (See <i>Fax Detect (set ON by default)</i> , page 22.)
<b>Phone Line or Connections</b>	
Dialling does not work	Check for a dial tone. Change <b>TONE/PULSE</b> setting (See <i>Setting the Dialling Mode (Tone/Pulse)</i> (Not available in New Zealand), page 14). Check all line cord connections, and make sure the curled handset cord is not in the <b>EXT</b> jack. Check power cord connection. Send a manual fax by pressing <b>Hook—OR—</b> by lifting the handset, and dialing the number. Wait to hear the fax receiving tones before pressing <b>Fax Start</b> .
The machine does not answer when called	Make sure the FAX/MFC is in the correct receiving mode for your setup (either <b>FAX</b> , <b>FAX/TEL</b> or <b>TAD</b> ). Check for dial tone. If possible, call your FAX/MFC to hear it answer. If there is still no answer, check the telephone line cord connection. Connect a standard telephone handset to the FAX/MFC telephone jack. If there is no ringing when you call your FAX/MFC, call your Telephone Company to check the line.
No dial tone on the handset	Press <b>Hook—OR—</b> Lift the handset. If you hear no dial tone, check telephone line cord connections at the FAX/MFC and wall jack. Check that the handset curled cord is connected to the FAX/MFC's handset jack. Test the jack with another single line telephone. If no dial tone on the wall outlet, call your Telephone Company.

DIFFICULTY	SUGGESTIONS
<b>Sending Faxes</b>	
Poor transmitting quality	Try changing your resolution to FINE or SUPERFINE. (See <i>Fax Resolution</i> , page 16.) Make a copy to verify the machine's scanner operation.
Transmission verification prints "Results:NG"	There is probably temporary noise or static on the phone line. Try sending the fax again. If the problem continues, call the Telephone Company to check your phone line.
When the receiving party says the picture is not clear	Sometimes the resolution mode you chose when you sent your fax may not have been appropriate. Send the fax again, but try using the <b>FINE</b> or <b>S.FINE</b> mode. Also, the machine's scanner may be dirty, so try cleaning it.
When the receiving party says vertical streaks appear on the faxes they receive	The machine's scanner may be dirty or the receiving party's print head may be dirty. Clean your scanner and make a copy to check if the problem was caused by the machine.
<b>Handling Incoming Calls</b>	
F/T pseudo-ring in Fax/Tel (F/T) Mode.	The machine knows the incoming call is not a fax so it is signalling you to answer the telephone call. Pick up the handset or answer from an extension phone and press the machine's Deactivation Code (default setting is #51 (#91 for New Zealand)).
Transferring a fax call to the machine.	If you answered at the machine, press <b>Fax Start</b> and hang up immediately. If you answered at an extension phone, press your Remote Activation Code (default setting is *51 (*91 for New Zealand)). When the machine answers, hang up.
The Caller ID does not display after the Call Waiting Signal.	The Caller ID signal is sent ten seconds after the Call Waiting Signal and speaking may interfere with it. When you hear the Caller Waiting signal, ask the other party to hold while you catch the other call. Then stop speaking until you see the Caller ID on the LCD.
<b>General Printing Difficulties (For MFC-4800 Only)</b>	
The machine does not print.	Make sure the machine is plugged in. The toner cartridge and drum unit are installed properly. The interface cable is securely connected between the machine and computer. Check to see if LCD is showing an error message.
The machine prints unexpectedly or it prints garbage.	Unplug the machine. Make sure your application software is correctly set up to use the machine by checking the primary settings in your application software.
The machine prints the first couple of pages correctly, then some pages have text missing.	Your computer is not recognizing the printer's "input buffer full" signal. Please make sure you connect the printer cable correctly.
The machine cannot print full pages of a document. An <b>OUT OF MEMORY</b> error message occurs.	Reduce the printer resolution. Reduce the complexity of your document and try again. Reduce the graphic quality or the number of font sizes within your application software.
My headers or footers appear when I view my document on the screen but do not show up when I print them.	Most laser printers have a restricted area that will not accept print. Usually these are the first two lines and last two lines, leaves 62 printable lines. Adjust the top and bottom margins in your document to allow for this.

DIFFICULTY	SUGGESTIONS
<b>Windows® Setup Printing Difficulties (For MFC-4800 Only)</b>	
I cannot print from my application software.	Make sure the Windows® printer driver is installed and you select it in your application software.
<b>Software Difficulties (For MFC-4800 Only)</b>	
“MFC Connect Failure”	If the machine is not connected to your PC and you have loaded the Brother software, the PC will show “MFC Connect Failure” each time you restart Windows®. You can ignore this message or you can turn it off by deselecting the <b>AutoLoad PopUp</b> check box in the Brother Control Center chapter. (See <i>How to Turn Off AutoLoad</i> , page 77.)
<b>Paper Handling Difficulties</b>	
The machine does not load paper. The LCD shows <b>CHECK PAPER</b> or <b>PAPER JAM</b>	Check to see if the <b>CHECK PAPER</b> or <b>PAPER JAM</b> message appears on the LCD. If so, the Multi-purpose Sheet Feeder may be out of paper. If it is empty, load a new stack of paper into the feeder and then press <b>Fax Start</b> . If there is paper in the Multi-purpose Sheet Feeder, make sure it is straight. If the paper is curled, you should straighten it. Sometimes it is helpful to remove the paper, turn the stack over and put it back into the Multi-purpose Sheet Feeder. Reduce the amount of paper in the Multi-purpose Sheet Feeder, then try again.
How can I clear paper jams?	See <i>Paper Jam</i> , page 119.
<b>Copy Quality Difficulties</b>	
Vertical streaks appear in copies	Sometimes you may see vertical streaks on your copies. Either the scanner or the primary corona wire for printing is dirty. Clean them both.
<b>Print Quality Difficulties</b>	
Printed pages are curled.	Thin Paper (17lb-18.4lb) can cause this problem. Make sure you select the Paper Type that suits the paper in your multi-purpose sheet feeder. (See <i>Paper Type</i> , page 61 and <i>Media Type</i> , page 68.)
Printed pages are smeared.	Rough surfaces or thick media can cause “smeared pages”-OR-“the toner to smear”. Make sure you select the correct Paper Type that suits the paper in your multi-purpose sheet feeder. (See <i>Paper Type</i> , page 61 and <i>Media Type</i> , page 68.)
Printouts are too dark or light	Adjust the print conditions by setting the Print Density function. It has been factory set to the middle position. (See <i>Setting the Print Density</i> , page 23.)
Printed pages contain white stripes.  <b>White Stripes or Faint Images</b>	You may fix this by wiping the scanner windows with a clean soft cloth. (See <i>Regular Maintenance</i> , page 127 and <i>Cleaning the Drum Unit</i> , page 128.) If you still see white stripes or faint images and the display shows <b>CHANGE DRUM SOON</b> , replace the drum unit with a new one.
Printed pages are stained with toner or have vertical stripes.  <b>Dark Stripes or Toner Stains</b>	Clean the machine’s interior and the primary corona wire of drum unit. (See <i>Regular Maintenance</i> , page 127 and <i>Cleaning the Drum Unit</i> , page 128.) Make sure that the tab of the corona wire is at the home position. If after cleaning, you still see dark stripes or toner stains and the display shows <b>CHANGE DRUM SOON</b> , replace the drum unit with a new one.

DIFFICULTY	SUGGESTIONS
<p>Printed pages have white spots in black text and graphic areas.</p>  <p><b>White Spots</b></p>	<p>Make sure that you use paper that meets the specifications. Rough surface or thick media can cause the problem. If you still see white spots and the display shows <b>CHANGE DRUM SOON</b>, replace the drum unit with a new one.</p>
<p>Toner scatters and stains the printed page.</p>  <p><b>Scattering Toner</b></p>	<p>Adjust the print conditions by setting the Print Density function. Clean the machine's interior. (See <i>Regular Maintenance</i>, page 127 and <i>Cleaning the Drum Unit</i>, page 128.) Make sure that you use paper that meets specifications. (See <i>Acceptable Paper</i>, page 65.) If you still have scattered toner and the display shows <b>CHANGE DRUM SOON</b>, replace the drum unit with a new one.</p>
<p>The whole page is printed black.</p>  <p><b>Black Page</b></p>	<p>Wipe the electric terminals. (See <i>Regular Maintenance</i>, page 127 and <i>Cleaning the Drum Unit</i>, page 128.) Also, do not use heat-sensitive paper as it will cause this problem. After cleaning, if the printed pages are still black and the display shows <b>CHANGE DRUM SOON</b>, replace the drum unit with a new one.</p>
<p>Nothing is printed on the page.</p>  <p><b>White page</b></p>	<p>Make sure that the toner cartridge is not empty. Wipe the electric terminals referring to <i>Regular Maintenance</i>, page 127 and <i>Cleaning the Drum Unit</i>, page 128. Make sure that a torn piece of paper does not remain on the scanner window.</p>
<p>Printed pages are marked regular intervals.</p>  <p><b>Example of Regular Marking</b></p>	<p>Markings may disappear by themselves. Try copying at multiple pages to clear this problem. Markings may occur if the machine has not been used for a long time. A possible cause is that the surface of the drum is marked or damaged by excessive exposure to light. In this case, replace the drum unit with a new one.</p>
<p>Printed pages are blurred at the centre or at either edge.</p>  <p><b>Blurred Page</b></p>	<p>Certain environmental conditions such as humidity, high temperatures, etc. may cause this condition to occur. Make sure the machine is placed on a flat, horizontal surface. Remove the drum unit with the toner cartridge installed. Try rocking them from side to side. You may clear a blurred page by wiping the scanner windows with a clean soft cloth. (See <i>Regular Maintenance</i>, page 127 and <i>Cleaning the Drum Unit</i>, page 128.) If a blurred page occurs after cleaning and the display shows <b>CHANGE DRUM SOON</b>, replace the drum unit with a new one.</p>
<p>Ghost images appear on printed pages.</p>  <p><b>Ghost Images</b></p>	<p>Adjust the print conditions by changing the Print Density setting, page 23. <b>-OR-</b> Rough surfaces or thick media can cause a ghost image. Make sure you select the Paper Type that suits the paper in your multi-purpose sheet feeder. (See <i>Paper Type</i>, page 61 and <i>Media Type</i>, page 68.)</p>



The drum unit is a consumable and it is necessary to replace it periodically.

# Packing and Shipping the Machine

Whenever you transport the machine, use the packing materials that came with the machine. Failure to pack the machine correctly may damage the machine and such damages will not be covered under warranty.

- 1 Make sure you close the paper tray and the extension.
- 2 Remove the line cord and unplug the machine from the AC outlet.
- 3 Open the top cover.
- 4 Remove the drum unit assembly.



**Remove the drum unit and toner cartridge assembly. Leave the toner cartridge installed in the drum unit.**

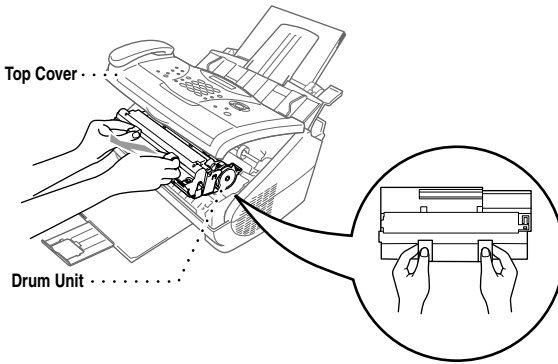

- 5 Place the drum unit and toner cartridge assembly into the plastic bag and seal the bag completely.

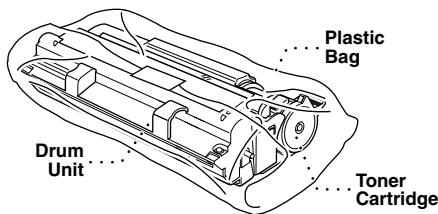

- 6 Close the top cover. Remove the document and paper supports and pack them.



- 7** Wrap the machine in the plastic bag and place it in the original carton with the original packing material.

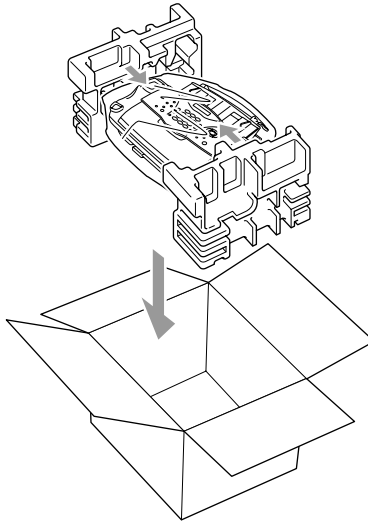

- 8** Place documents (manual, printed material and CD-ROM), the drum unit and toner cartridge assembly, the telephone cord, printer cable and paper supports into the carton as shown below.

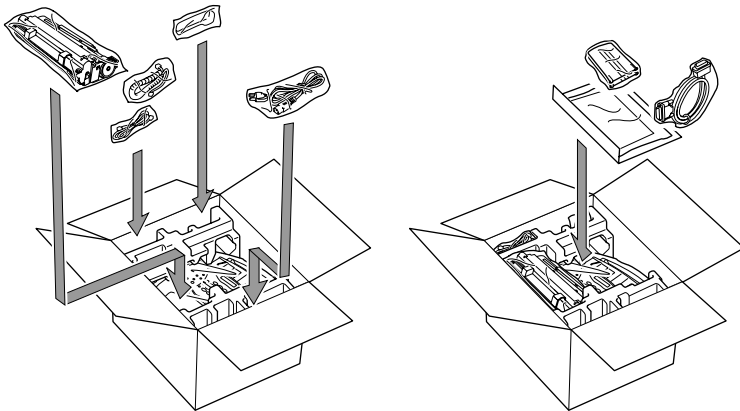

- 9** Close the carton and tape it shut.

# Regular Maintenance

You can keep the machine in optimum condition by cleaning it on a regular basis. It is a good idea to clean the drum unit during this routine. Avoid using thinners or other organic solvents to clean the machine and do not use water.

## Cleaning the Scanner

---

**1** Unplug the telephone line and then the power cord.

When you reconnect these lines later, make sure to connect the power cord first, then the telephone line.

**2** Open the document tray, and then the control panel.

**3** Wipe dirt off the machine using a slightly damp clean cloth.

**4** Clean the white bar and the glass cover.

Moisten a small piece of clean soft, lint-free cloth with isopropyl alcohol and carefully remove dirt from the glass cover and the white bar of the scanner.

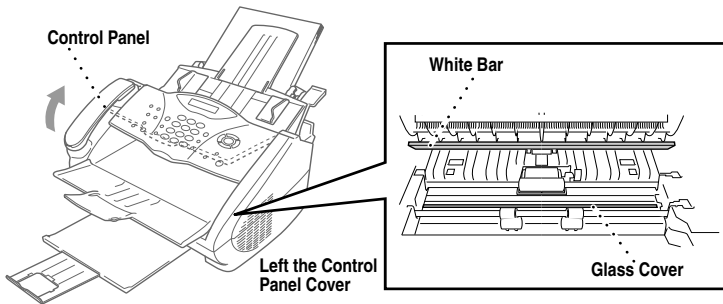

## Cleaning the Printer

---



- Do not use isopropyl alcohol to remove dirt from the control panel. It may cause a crack on the panel.
- Do not use isopropyl alcohol to clean the scanner window or the toner sensor.
- Do not touch the scanner window with your finger.
- Handle the drum unit carefully as it contains toner. If toner scatters and your hands or clothes get dirty, immediately wipe or wash it off with cold water.

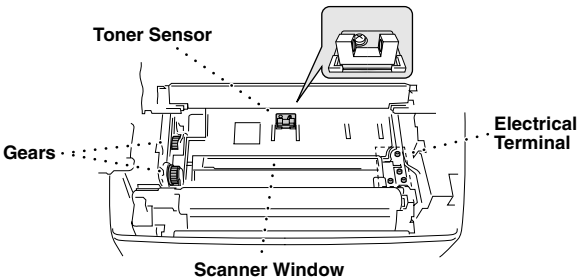



After you have used the machine, some internal parts of the machine are extremely **HOT!** When you open the top cover of the machine, never touch the shaded parts shown in the diagram below.

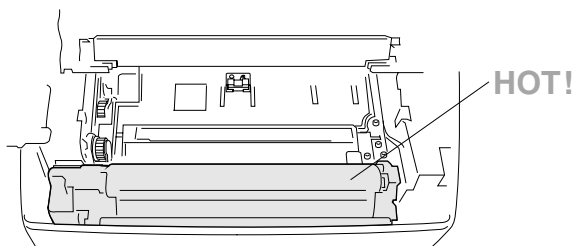

▲ Inside the Fax Machine

- 1 Open the top cover.
- 2 Remove the drum unit assembly.
- 3 Wipe the electric terminals with isopropyl alcohol on a cotton swab.
- 4 Wipe the gears with a clean dry cloth.
- 5 Gently wipe the scanner window and the toner sensor with a clean soft dry cloth. Do not use isopropyl alcohol to clean the scanner window or the toner sensor.

## Cleaning the Drum Unit

We recommend you place the drum unit on a drop cloth or large piece of disposable paper to avoid spilling and scattering toner.

- 1 Turn the drum unit upside down carefully.
- 2 Clean the primary corona wire inside the drum unit by gently sliding the tab from right to left several times.
- 3 Return the tab to the home position (▼ mark position) before reinstalling the drum unit.

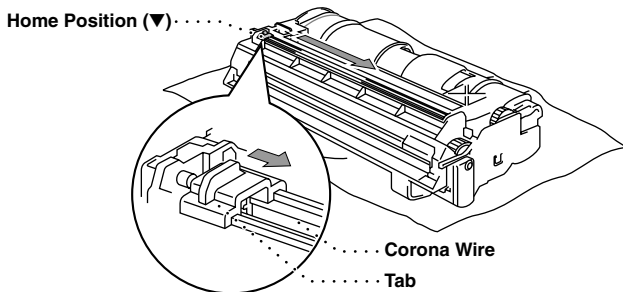

If you do not position the tab at the home position, printed pages may have vertical stripes.

**4** Install the drum unit into the machine. (See *Replacing the Drum Unit*, page 132.)

**5** Close the top cover.

## Replacing the Toner Cartridge

---

The machine can print approximately 2,200 pages with one toner cartridge (TN-8000). When the toner cartridge is running low, the display shows **CHANGE TONER**. Actual page count will vary depending on your average document type (i.e. standard letter, detailed graphics). The above specifications relate to a 5% black coverage A4 size document.

It is a good idea to keep a new toner cartridge ready for use when you see the toner low warning.

Discard the used toner cartridge according to local regulations. If you are not sure of them, consult with Brother dealer for service. Be sure to seal the toner cartridge tightly so toner powder does not spill out of the cartridge. When discarding used toner cartridges, keep them separate from domestic waste.

It is recommended that you clean the machine when you replace the toner.

The display shows **TONER EMPTY** to indicate that the toner is empty. Once this indication appears, the machine will not resume printing until you have installed a new toner cartridge.



**DO NOT refill the toner cartridges. Attempting to use refilled toner cartridges and using incompatible toners may cause damage to the machine and such damage will not be covered by warranty. Warranty coverage does not apply to problems caused by the use of 3rd party consumables. We can only recommend the use of genuine Brother consumables.**

### Steps for Replacing Toner Cartridge



**After you have just used the machine, some internal parts of the machine will be extremely HOT! So, never touch the shaded parts shown in the illustration below.**

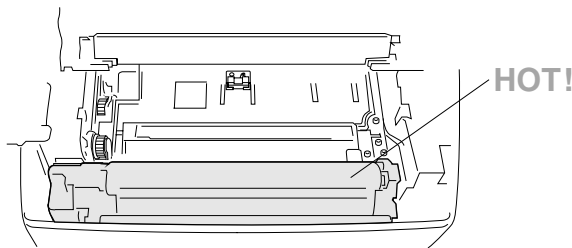

**▲ Inside the Fax Machine**

- 1 Open the top cover. Make sure the top cover is completely open. To remove the drum unit, hold each side of the drum by the handles and gently lift the drum forward toward you.

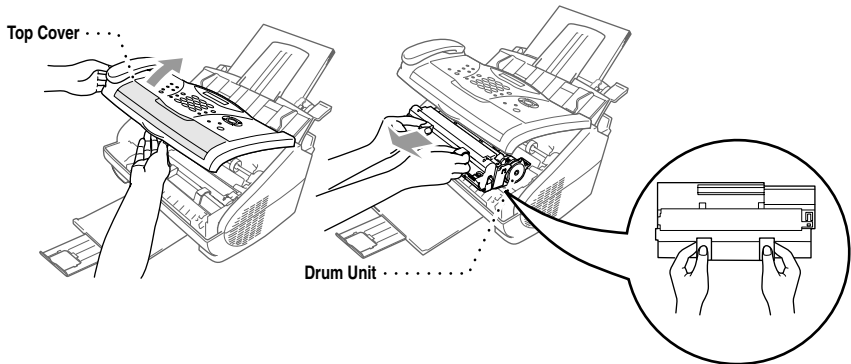

Place the drum unit on a drop cloth or large piece of disposable paper to avoid spilling and scattering the toner.

- 2 Gently turn the lever on the toner cartridge forward until it stops. The toner cartridge cannot be removed unless the shutter is completely closed, by turning the lever fully to the front.

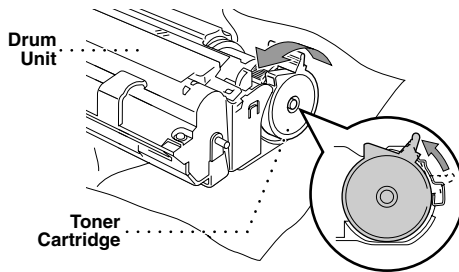

- 3 Remove the old toner cartridge from the drum unit by gently pulling it out.



**Handle the toner cartridge carefully. If toner scatters on your hands or clothes, immediately wipe it off or wash them with cold water.**

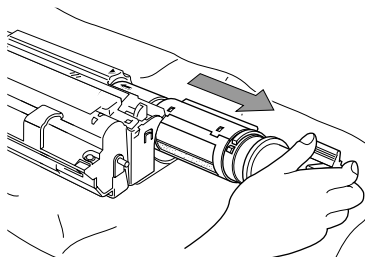

- 4** Unpack the new toner cartridge. Place the used toner cartridge into the aluminium bag and discard it according to local regulations.

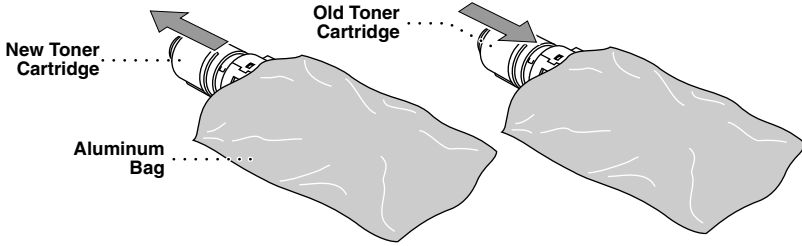

- **Wait to unpack the toner cartridge until immediately before you install it into the machine. If a toner cartridge is left unpacked for a long period of time, the toner life is shortened.**

- 5** Gently rock the toner cartridge from side to side five or six times, and then remove the protective seal.

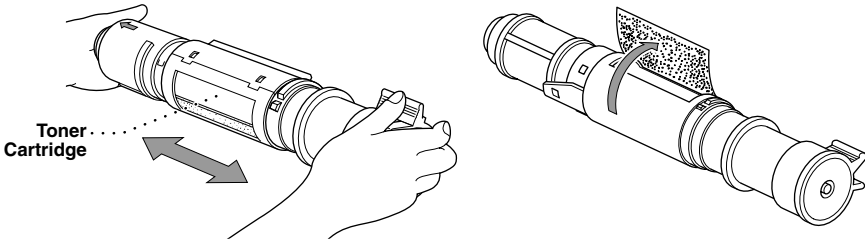

- 6** Slide the new toner cartridge into the opening on the right side of the drum unit. To ensure that the toner cartridge and the drum unit fit together correctly, make sure that the toner cartridge guide bar is exactly aligned with the guide slot in the drum unit.

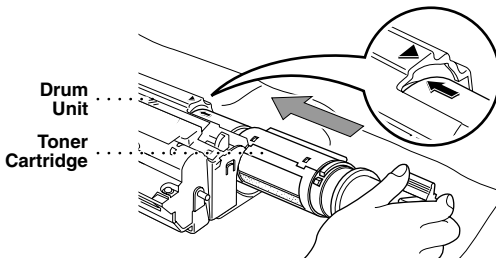

7 Gently turn the lever on the toner cartridge backward until it stops.

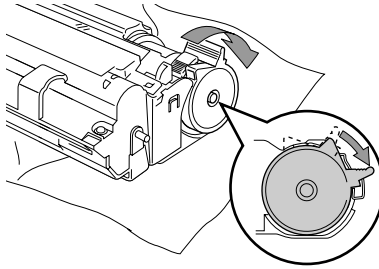

8 Reinstall the drum unit into the machine and close the top cover.

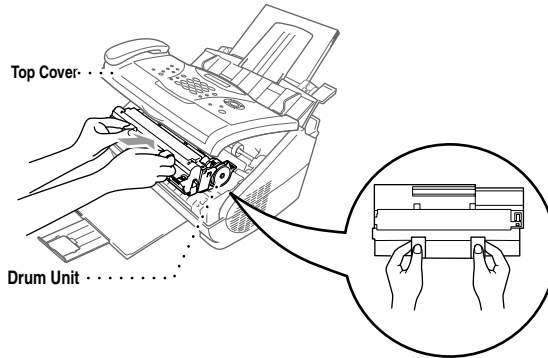

## Replacing the Drum Unit

The machine uses a drum unit to create the print images on paper. If the screen displays **CHANGE DRUM SOON**, the drum unit is nearly at the end of its life. Prepare a new drum unit to replace the current one. You may need to order one from your Brother dealer.

Even if the display shows **CHANGE DRUM SOON**, you may be able to continue to print without replacing the drum unit for a while. However, if there is a noticeable deterioration in the output print quality even before **CHANGE DRUM SOON** is shown, then the drum unit should be replaced. You should clean the machine when you replace the drum unit.



**When removing the drum unit, handle carefully because it contains toner. When you replace the drum unit, you should clean the machine.**



The drum unit is a consumable, and it is necessary to replace it periodically. There are many factors that determine the actual drum life, such as temperature, humidity, type of paper and toner that you use and the number of pages per print job, etc. The drum life is estimated at approximately 8,000 pages at 1 page per job. The actual number of pages your drum will print may be significantly less than these estimates. Because we have no control over the many factors that determine the actual drum life, we cannot guarantee a minimum number of pages that will be printed by your drum.

For best performance, use only genuine Brother toner, and the product should be used only in a clean, dust-free environment with adequate ventilation.



**After you have just used the machine, some internal parts of the machine will be extremely HOT! So please be careful.**

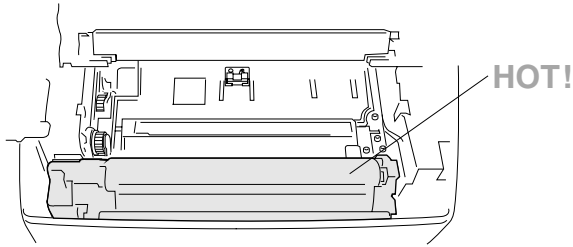

▲ Inside the Fax Machine

Follow these steps to replace the drum unit:

- 1** Open the top cover.
- 2** Remove the old drum unit. Place the drum unit on an old cloth or large piece of disposable paper to avoid spilling and scattering the toner.

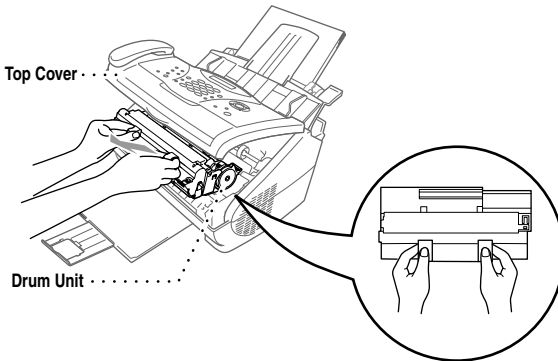

- 3** Remove the toner cartridge from the drum unit and keep it in a safe place. (See *Replacing the Toner Cartridge*, page 129.)

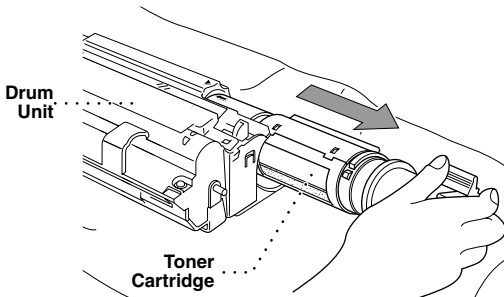





Discard the used drum unit according to local regulations. Be sure to seal the drum unit tightly so toner powder does not spill out of the unit. When discarding used drum units, keep them separate from domestic rubbish.

- 4 Wait to unpack the new drum unit until immediately before installing it. Place the old drum unit into the aluminium bag and discard it according to local regulations.

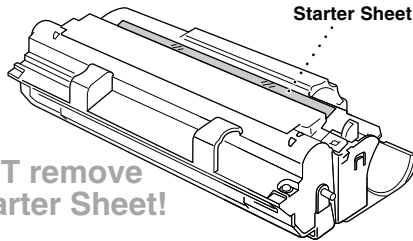
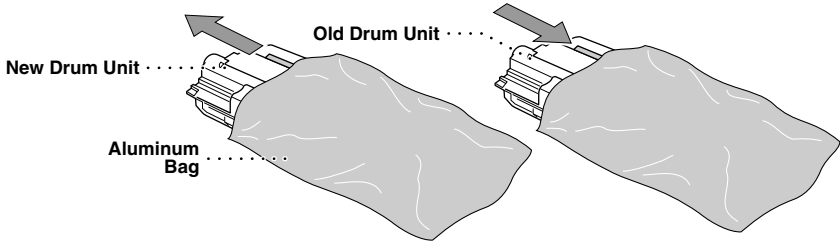

- Do not pull or force the starter sheet from the machine. It will be ejected automatically.
- Wait to unpack the drum unit immediately before installing it into the machine.
- If an unpacked drum unit is subjected to excessive direct sunlight or room light, the unit may be damaged.
- Handle the toner cartridge and the drum unit carefully because they contain toner. If toner scatters and your hands or clothes get dirty, immediately wipe or wash with cold water.
- Do not touch the scanner window with your finger.

**5** Reinstall the toner cartridge into the new drum unit. (See *Replacing the Toner Cartridge*, page 129.)

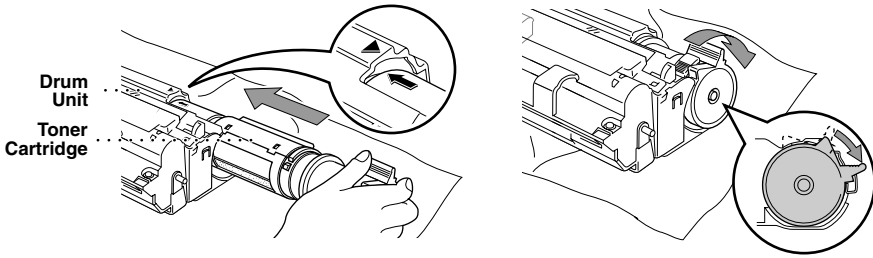

**6** Holding the new drum unit by the handles, install it. Close the top cover.

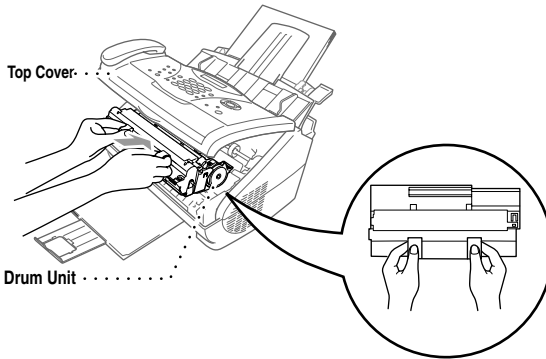

**7** The machine will automatically eject the starter sheet. Do not pull or force the starter sheet from the machine.

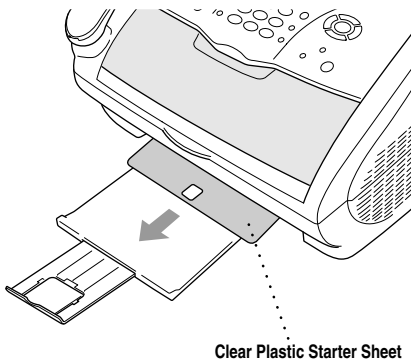

## *Important Information for Australia*

### Important Safety Instructions

---

- 1** Read all of these instructions.
- 2** Save them for later reference.
- 3** Follow all warnings and instructions marked on the product.
- 4** Unplug this product from the telephone and AC sockets (in this order) before cleaning. Do not use liquid or aerosol cleaners. Use a damp cloth for cleaning.
- 5** Do not place this product on an unstable surface.
- 6** Slots and openings in the case and the back or bottom are provided for ventilation; to ensure reliable operation of the product and to protect it from overheating, these openings must not be blocked or covered. The openings should never be blocked by placing the product on a bed, sofa, rug, or other similar soft surface. This product should never be placed near or over a radiator or heater. This product should not be placed in a built-in installation unless proper ventilation is provided.
- 7** This product should be operated from the type of power source indicated on the label. If you are not sure of the type of power available, consult with your dealer or local power company.
- 8** This product is equipped with a 3-wire earthed plug. This plug will fit into only an earthed socket. This is a safety feature. If you are unable to insert the plug into the outlet, contact your electrician to replace your obsolete socket. Do not defeat the purpose of an earthed plug.
- 9** Do not allow anything to rest on the power cord. Do not locate this product where people can walk on the cord.
- 10** Do not place anything in front of the machine that will block received faxes. Do not place anything in the path of received faxes.
- 11** Do not touch a document during printing.
- 12** Never push objects of any kind into this product through cabinet slots, since they may touch dangerous voltage points or short out parts resulting in a risk of fire or electric shock. Never spill liquid of any kind on the product.
- 13** Do not attempt to service this product yourself, because opening or removing covers may expose you to dangerous voltage points and/or other risks. Refer all servicing to service personnel.
- 14** This product has no mains ON/OFF switch. It is therefore highly important that access to the mains plug and the mains socket to which the plug is connected, is never obstructed, in case for some reason the mains power to the machine must be quickly disconnected.

- 15** Unplug this product from the mains power and telephone line sockets, and refer servicing to qualified service personnel under the following conditions:
- ◆ When the power cord is damaged or frayed.
  - ◆ If liquid has been spilled into the product.
  - ◆ If the product has been exposed to rain or water.
  - ◆ If the product does not operate normally when the operating instructions are followed. Adjust only those controls that are covered by the operating instructions. Improper adjustment of other controls may result in damage and will often require extensive work by a qualified technician to restore the product to normal operation.
  - ◆ If the product has been dropped or the cabinet has been damaged.
  - ◆ If the product exhibits a distinct change in performance, indicating a need for service.
- 16** We do not advise the use of an extension lead.

## ***Important Information for New Zealand***

### **Important Safety Instructions**

---

- 1** Read all of these instructions.
- 2** Save them for later reference.
- 3** Follow all warnings and instructions marked on the product.
- 4** Unplug this product from the telephone and AC sockets (in this order) before cleaning. Do not use liquid or aerosol cleaners. Use a damp cloth for cleaning.
- 5** Do not use this product near water.
- 6** The grant of a Telepermit for any item of terminal equipment indicates only that Telecom has accepted that the item complies with minimum conditions for connection to its network. It indicates no endorsement of the product by Telecom, nor does it provide any sort of warranty. Above all, it provides no assurance that any item will work correctly in all respects with another item of Telepermitted equipment of a different make or model, nor does it imply that any product is compatible with all of Telecom's network services.
- 7** This equipment does not fully meet Telecom's impedance requirements. Performance limitations may occur when used in conjunction with some parts of the network. Telecom will accept no responsibility should difficulties arise in such circumstances.
- 8** If a charge for local calls is unacceptable, the "Dial Button" should not be used for local calls. Only the 7-digits of the local number should be dialled from your telephone. Do not dial the area code digit or the "0" prefix.
- 9** This equipment shall not be set to make automatic calls to the Telecom "111" Emergency Service.
- 10** **IMPORTANT NOTICE**  
Under power failure conditions, this telephone may not operate. Please ensure that a separate telephone, not dependent on local power, is available for emergency use in emergencies.
- 11** Some parameters required for compliance with Telecom's Telepermit requirements are dependent on the equipment (PC) associated with this device. In order to operate within the limits for compliance with Telecom's Specifications, the associated equipment shall be set to

ensure that calls are answered between 3 and 30 seconds of receipt of ringing.

- 12** This equipment should not be used under any circumstances which may constitute a nuisance to other Telecom customers.
- 13** Not all telephones will respond to incoming ringing when connected to the extension socket.
- 14** This equipment may not provide for the effective hand-over of a call to another device connected to the same line.
- 15** The answer delay setting of this equipment shall not be set to less than the default setting as this will destroy Caller ID information.
- 16** All persons using this device for recording telephone conversations shall comply with New Zealand law. This requires that at least one party to the conversation is to be aware that it is being recorded. In addition, the Principles enumerated in the Privacy Act 1993 shall be complied with in respect to the nature of the personal information collected, the purpose for its collection, how it is to be used and what it disclosed to any other party.
- 17** The Caller ID Information is presented in the form: Area Code + Directory number  
When dialling back, always insert a zero in front of the area code for a toll call and omit the area code for a local call. If a zero is inserted in front of the area code for a local call, the call will still proceed correctly but if the line has non-code access to another toll carrier, you should check with that carrier before inserting zero on a local call.
- 18** Do not place this product on an unstable surface.
- 19** Slots and openings in the case and the back or bottom are provided for ventilation; to ensure reliable operation of the product and to protect it from overheating, these openings must not be blocked or covered. The openings should never be blocked by placing the product on a bed, sofa, rug, or other similar soft surface. This product should never be placed near or over a radiator or heater. This product should not be placed in a built-in installation unless proper ventilation is provided.
- 20** This product should be operated from the type of power source indicated on the label. If you are not sure of the type of power available, consult with your dealer or local power company.
- 21** This product is equipped with a 3-wire earthed plug. This plug will fit into only an earthed socket. This is a safety feature. If you are unable to insert the plug into the outlet, contact your electrician to replace your obsolete socket. Do not defeat the purpose of an earthed plug.
- 22** Do not allow anything to rest on the power cord. Do not locate this product where people can walk on the cord.
- 23** Do not place anything in front of the machine that will block received faxes. Do not place anything in the path of received faxes.
- 24** Do not touch a document during printing.
- 25** Never push objects of any kind into this product through cabinet slots, since they may touch dangerous voltage points or short out parts resulting in a risk of fire or electric shock. Never spill liquid of any kind on the product.
- 26** Do not attempt to service this product yourself, because opening or removing covers may expose you to dangerous voltage points and/or other risks. Refer all servicing to service personnel.
- 27** This product has no mains ON/OFF switch. It is therefore highly important that access to the mains plug and the mains socket to which the plug is connected, is never obstructed, in case for some reason the mains power to the machine must be quickly disconnected.

- 28** Unplug this product from the mains power and telephone line sockets, and refer servicing to qualified service personnel under the following conditions:
- ◆ When the power cord is damaged or frayed.
  - ◆ If liquid has been spilled into the product.
  - ◆ If the product has been exposed to rain or water.
  - ◆ If the product does not operate normally when the operating instructions are followed. Adjust only those controls that are covered by the operating instructions. Improper adjustment of other controls may result in damage and will often require extensive work by a qualified technician to restore the product to normal operation.
  - ◆ If the product has been dropped or the cabinet has been damaged.
  - ◆ If the product exhibits a distinct change in performance, indicating a need for service.
- 29** We do not advise the use of an extension lead.

## ***Important Information for Some Countries***

### **Important Safety Instructions**

---

- 1** Read all of these instructions.
- 2** Save them for later reference.
- 3** Follow all warnings and instructions marked on the product.
- 4** Unplug this product from the wall outlet before cleaning. Do not use liquid or aerosol cleaners. Use a damp cloth for cleaning.
- 5** Do not place this product near water.
- 6** Do not place this product on an unstable cart, stand, or table. The product may drop, causing serious damage to the product.
- 7** Slots and openings in the cabinet and the back or bottom are provided for ventilation; to ensure reliable operation of the product and to protect it from overheating, these openings must not be blocked or covered. The openings should never be blocked by placing the product on a bed, sofa, rug, or other similar surface. This product should never be placed near or on a radiator or heater. This product should never be placed in a built-in installation unless proper ventilation is provided.
- 8** This product should be operated from the type of power source indicated on the label. If you are not sure of the type of power available, consult with your dealer or local power company.
- 9** This product is equipped with a 2-wire grounding type plug or a 3-wire grounding type plug (Only for Singapore, Malaysia, Hong Kong and India), a plug having two or three pins. This plug will only fit into only a grounding-type power outlet. This is a safety feature. If you are unable to insert the plug into the outlet, contact your electrician to replace your obsolete outlet. Do not defeat the purpose of the grounding-type plug.
- 10** Do not allow anything to rest on the power cord. Do not place this product where people can walk on the cord.
- 11** If an extension cord is used with this product, make sure that the total ampere ratings on the products plugged into the extension cord do not exceed the extension cord ampere rating.
- 12** Do not place anything in front of the machine that will block received faxes. Do not place anything in the path of received faxes.

- 13** Do not touch a document during printing.
- 14** Never push objects of any kind into this product through cabinet slots, since they may touch dangerous voltage points or short out parts resulting in the risk of fire or electric shock. Never spill liquid of any kind on the product.
- 15** Do not attempt to service this product yourself, as opening or removing covers may expose you to dangerous voltage points and/or other risks, and may void your warranty. Please refer all servicing to our Authorized Service Personnel. A list of Authorized Service Centres has been included for your convenience, or you may contact the Brother Dealer for Service.
- 16** This product does not have an ON/OFF switch. Therefore, it is very important that you have easy access to the main plug and the main socket to which the plug is connected, if the main power to the FAX/MFC need to be disconnected quickly.
- 17** Unplug this product from the wall outlet and refer servicing to Authorized Service Personnel under the following conditions:
- ◆ If the power cord is damaged or frayed.
  - ◆ If the product has been spilled by liquid.
  - ◆ If the product has been exposed to rain or water.
  - ◆ If the product does not operate normally when the operating instructions are followed. Adjust only those controls that are covered by the operating instructions. Improper adjustment of other controls may result in damage and will often require extensive work by a qualified technician to restore the product to normal operation.
  - ◆ If the product has been dropped or the cabinet has been damaged.
  - ◆ If the product exhibits a distinct change in performance, indicating a need for service.
- 18** To protect your product against power surges, we recommend the use of a power protection device (Surge Protector).
- 19** We do not advise the use of an extension lead.



- **For protection against the risk of electrical shock, always disconnect all cables from the wall outlet before servicing, modifying or installing the equipment.**
- **This equipment may not be used on coin service lines provided by the telephone company or connected to party lines.**
- **Brother cannot accept any financial or other responsibilities that may be the result of your use of this information, including direct, special or consequential damages. There are no warranties extended or granted by this document.**

# Important Information for All Countries

## IEC 60825 Specification

This machine is a Class 1 laser product as defined in IEC 60825 specifications. The label shown below is attached in countries where required.

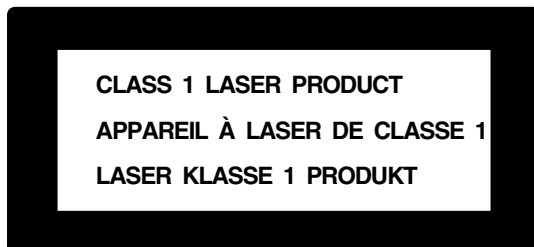

This machine has a Class 3B Laser Diode which emits invisible laser radiation in the Scanner Unit. The Scanner Unit should not be opened under any circumstances.

### Laser Diode

Wave length: 760 - 810 nm

Output: 5 mW max.

Laser Class: Class 3B

### Caution

Use of controls, adjustments or performance of procedures other than those specified in this manual may result in hazardous radiation exposure.

The following caution label is attached near the scanner unit.

<b>CAUTION</b>	INVISIBLE LASER RADIATION WHEN OPEN AND INTERLOCK DEFEATED. AVOID DIRECT EXPOSURE TO BEAM. CLASS 3B LASER PRODUCT.
<b>ADVARSEL</b>	USYNLIG LASER STRÅLING NÅR KABINETLÅGET STÅR ÅBENT. UNGDÅ DIREKTE UDSÆTTELSE FOR STRÅLING. KLASSE 3B LASER.
<b>VARNING</b>	OSYNLIG LASERSTRÅLNING HÄR DENNA DEL ÄR ÖPPNAD OCH SPÄRRAR ÄR URKOPPLADE. STRÅLEN ÄR FÄRLIG. KLASSE 3B LASER APPARAT.
<b>VARO!</b>	AVATTAESSA JA SUOJALUKITUS OHITETTAESSA OLET ALTIINA NÄKYMÄTTÖMÄLLE LASERSÄTEILYLLE. ÄLÄ KATSO SÄTEESEEN. LUOKAN 3B LASERLAITE.
<b>ADVARSEL</b>	USYNLIG LASERSTRÅLING. UNNGÅ DIREKTE KONTAKT MED LASERENHETEN NÅR TOPPDEKSELET ER ÅPENT. KLASSE 3B LASERPRODUKT.
<b>ATTENTION</b>	RADIATIONS LASER INVISIBLES QUAND OUVERT ET VERROUILLAGE ENLEVE. EVITER EXPOSITIONS DIRECTES AU FAISCEAU. PRODUIT LASER CLASSE 3B.
<b>VORSICHT</b>	UNSICHTBARE LASERSTRAHLUNG WENN ABDECKUNG GEÖFFNET UND SICHERHEITSVERRIEGELUNG ÜBERBRÜCKT. NICHT DEM STRAHL AUSSETZEN. SICHERHEITSKLASSE 3B.
<b>ATENCIÓN</b>	RADIACIÓN LASER INVISIBLE CUANDO SE ABRE LA TAPA Y EL INTERRUPTOR INTERNO ESTÁ ATASCADO. EVITE LA EXPOSICIÓN DIRECTA DE LOS OJOS. PRODUCTO LASER CLASE 3B.

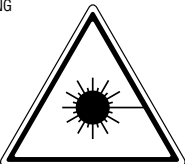



## **For Your Safety**

To ensure safe operation the three-pin plug supplied must be inserted only into a standard three-pin power point which is effectively grounded through the normal household wiring.

Extension cords used with the equipment must be three-conductor and be correctly wired to provide connection to ground. Incorrectly wired extension cords are a major cause of fatalities.

The fact that the equipment operates satisfactorily does not imply that the power is grounded and that the installation is completely safe. For your safety, if in any doubt about the effective grounding of the power, consult a qualified electrician.

## **Disconnect device**

This product must be installed near a socket outlet that is easily accessible. In case of emergencies, you must disconnect the power cord from the socket outlet in order to shut off power completely.

## ***Fax Specifications***

<b>Compatibility</b>	ITU-T Group 3
<b>Coding system</b>	MH/MR/MMR
<b>Modem speed</b>	14400 - 2400 bps; Automatic fallback
<b>Document input width</b>	148 mm to 216 mm
<b>Document input length</b>	100 mm to 360 mm
<b>Scanning/printing width</b>	208 mm
<b>Automatic Document Feeder (ADF)</b>	Up to 20 sheets (75 gsm)
<b>Multi-purpose sheet feeder</b>	Up to 200 sheets (75 gsm) Acceptable Paper for fax receive and copy functions Size : A4 (210 mm · 297 mm) Weight : 64 gsm - 158 gsm Thickness : 0.08 - 0.20 mm
<b>Printer type</b>	Laser printer
<b>Grey scale</b>	64 levels (Error Diffusion)
<b>Display</b>	LCD, 16 characters
<b>Polling types</b>	Standard, Secure, Delayed, Sequential
<b>Contrast control</b>	Automatic/Light/Dark (manual setting)
<b>Resolution</b>	<ul style="list-style-type: none"><li>• Horizontal 8 dots/mm</li><li>• Vertical Standard—3.85 lines/mm Fine, Photo—7.7 lines/mm Superfine, Photo (copy)—15.4 lines/mm</li></ul>
<b>Out of paper reception</b>	Up to 80 pages* in memory
<b>One touch dial</b>	8 stations (FAX-2850)
<b>Speed dial</b>	100 stations
<b>Automatic redial</b>	2 times at 2 minute intervals (for Australia) 2 times at 3 minute intervals (for New Zealand) 10 times at 3 minute intervals (for some countries)
<b>Speaker type</b>	Monitor
<b>Automatic answer</b>	2, 3, 4, 5, 6, 7, 8, 9 or 10 rings (for Australia) 1, 2, 3, 4, 5, 6, 7, 8, 9 or 10 rings (for New Zealand) 0, 1, 2, 3, 4, 5, 6, 7, 8, 9 or 10 rings (for some countries)
<b>Communication source</b>	Public switched telephone network (PSTN)

**Consumable items****Toner cartridge:**

Life expectancy: up to 2,200 pages/new toner cartridge  
(when printing A4 paper at 5% print coverage)

Toner life expectancy will vary depending on the type of average print job.

**Drum unit:**

Life expectancy: 8,000 pages at 1 page per job

There are many factors that determine the actual drum life, such as temperature, humidity, type of paper and toner that you use, the number of pages per print job, etc.

\*Pages refers to the “ITU-T Chart” with MMR cording and standard resolution.

## ***Printer Specifications (For MFC-4800 Only)***

**Printer driver**

Windows® 95, 98, 98SE, Me, 2000 professional and Windows NT® Workstation Version 4.0 driver supporting Brother Native Compression mode and bi-directional capability

Apple® Macintosh® QuickDraw® Driver for OS 8.5/8.5.1/8.6/9.0/9.0.4/9.1

**Interface**

Bi-directional parallel interface (IEEE-1284)  
USB (Universal Serial Bus) interface

**Memory**

2 MB

**Printer method**

Electrophotography by semiconductor laser beam scanning

**Resolution**

600 dots/inch

**Print quality**

Normal printing mode  
Economy printing mode

**Print speed**

10 pages/minute (when loading A4 paper from the multi-purpose sheet feeder)

# Computer Requirement (For MFC-4800 Only)

For Windows®			
Operating System	CPU (Pentium)	RAM	Hard Disk Space
95, 98, 98SE	75 MHz	24 MB (32 MB recommended)	50 MB
NT Workstation4.0	75 MHz	32 MB (64 MB recommended)	
2000 Professional	133 MHz	64 MB (128 MB recommended)	
Me	150 MHz	32 MB (64 MB recommended)	

For Macintosh®			
Operating System	CPU	RAM	Hard Disk Space
Apple® Macintosh® QuickDraw® G3, G4, iMac or iBook with OS8.5, 8.5.1 (Only Printer) OS8.6/9.0/9.0.4/9.1 (Printer & Scanner)	All base models meet minimum requirements.		50 MB

## Electrical and Environment

<b>Temperature</b>	(Allowable) 10 - 32.5°C (Storage) 0 - 40°C
<b>Warm-up</b>	Approx. 12 seconds at 23°C
<b>Power source</b>	220 ~ 240V AC 50/60Hz
<b>Power consumption</b>	Operating (Copying); 260 W or less (25°C) Peak: 940 W Sleep Mode: 10 W or less Stand by: 70 W or less (25°C)
<b>Noise</b>	Operating: 50 dB A or less Stand by: 39 dB A or less
<b>Humidity</b>	Operating: 20 to 80% (without condensation) Storage: 10 to 90% (without condensation)
<b>Dimensions</b>	395 x 359 x 243 mm
<b>Weight</b>	7.5 kg (without drum unit)

Specifications are subject to change for improvement without prior notice.

## Compilation and Publication Notice

Under the supervision of Brother Industries Ltd., this manual has been compiled and published, covering the latest product's descriptions and specifications.

The contents of this manual and the specifications of this product are subject to change without notice.

Brother reserves the right to make changes without notice in the specifications and materials contained herein and shall not be responsible for any damages (including consequential) caused by reliance on the materials presented, including but not limited to typographical and other errors relating to the publication.

## Trademarks

Multi-Function Link Pro Suite is registered trademark of Brother Industries, Ltd.

Brother is a registered trademark of Brother Industries, Ltd.

The brother logo is a registered trademark of Brother Industries, Ltd.

Windows, Windows NT, Microsoft, MS-DOS, Excel, Word, Paint and Draw are registered trademark of Microsoft in the U.S. and other countries.

NT is a trademark of Northern Telecom Limited.

Macintosh is a registered trademark, and iMac is a trademark of Apple Computer, Inc.

PaperPort and TextBridge are registered trademarks of ScanSoft, Inc.

Each company whose software title is mentioned in this manual has a Software License Agreement specific to its proprietary programs.

IBM and IBM PC are registered trademarks of International Business Machines Corporation.

All other brand and product names mentioned in this User's Guide are registered trademarks of their respective companies.

## Ordering Accessories and Supplies

For the best quality results use only genuine Brother accessories. These are available from most Brother dealers.

<b>Model Name</b>	<b>Description</b>
Laser Fax Toner	TN-8000
Laser Fax Drum	DR-8000

# Entering Text

When you are setting certain functions, such as the Station ID, you may need to enter text into the machine. Most keys on the dial pad have three or four letters printed above them. The keys for **0**, **#**, and **\*** don't have printed letters because they are used for special characters.

By pressing the appropriate number on the dial pad the correct number of times, you can access the character you want.

Press Key	one time	two times	three times	four times	five times
2	A	B	C	2	A
3	D	E	F	3	D
4	G	H	I	4	G
5	J	K	L	5	J
6	M	N	O	6	M
7	P	Q	R	7	P
8	T	U	V	8	T
9	W	X	Y	9	W

## Inserting spaces

If you want to enter a blank space, press  twice.

## Making corrections

If you entered a letter incorrectly and want to change it, press  to move the cursor after the last correct letter. Then press **Stop/Exit**; all letters above and to the right of the cursor are deleted. Re-enter the correct text and/or digits. You can also back up and type over incorrect letters.

## Repeating letters

If you need to enter a character assigned to the same key as the previous character, press  to move the cursor to the right.

## Special characters and symbols

Press the **\***, **#**, or **0** key repeatedly or press  to move the cursor under the special character or symbol you want. Then press **Menu/Set** to select it.

**0** key    Ä Æ Ö Ü À Ç È É 0

**\*** key    (space) ! " # \$ % & ' ( ) \* + , - . / €

**#** key    ; < = > ? @ [ ] ^ \_

# Menu Mode & Menu Selection Table

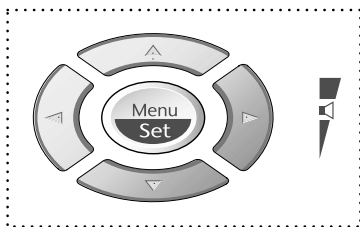

- Access the Menu
- Go to next menu level
- Accept an option
- Scroll through the current menu level
- Back to previous menu level
- Forward to next menu level
- Exit the Menu

You can access the menu mode by pressing **Menu/Set**.

When you enter the Menu, the LCD scrolls:

SELECT ↑ ↓ & SET

Press **1** for General Setup Menu—**OR**—

1. GENERAL SETUP





Press **2** for Fax Menu—**OR**—

2. FAX

Press **3** for Copy Menu—**OR**—



3. COPY

—**OR**—

You can scroll more quickly through each menu level by pressing  or  keys, and then set an option by pressing **Menu/Set** when that option appears on the LCD. Then the LCD shows next menu level. Press  or  key to scroll to your next menu selection, and then press **Menu/Set**. When you finish setting an option, the LCD shows **ACCEPTED**.











Use  to scroll backward if you passed your choices or to save keystrokes.

You can program your FAX/MFC by pressing **Menu/Set** followed by the menu numbers. For example: to set **FAX RESOLUTION** to **FINE**, press **Menu/Set**, **2**, **2**, **2** and  or  to select **FINE**, and then press **Menu/Set**.

To access the menu, press  **Menu/Set**.

To exit, press  **Stop/Exit**.





Main Menu	Submenu	Menu Selections	Options	Descriptions	Page	
	 	 	 	 to accept		
<b>1. GENERAL SETUP</b>	<b>1. DATE/TIME</b>	—	—	Enter date and time for LCD display and to print on transmissions.		
	<b>2. STATION ID</b>	—	—	Program the name and fax number to appear on each transmitted page.	11	
	<b>3. VOLUME</b>	<b>1. RING</b>		HIGH MED <b>LOW</b> OFF	Adjusts ring volume.	12
		<b>2. BEEPER</b>		HIGH <b>LOW</b> OFF	Adjusts beeper volume.	12
		<b>3. SPEAKER</b>		HIGH MED <b>LOW</b> OFF	Adjusts speaker volume.	12
	<b>4. TONER SAVE</b>	—	ON <b>OFF</b>	Increase life of toner cartridge.	13	
	<b>5. POWER SAVE</b>	—	ON <b>OFF</b>	Power save mode.	13	
	<b>6. SLEEP MODE</b>	—	—	Set the time before the machine drops into sleep mode.	13	
<b>7. TONE/PULSE (Not available in New Zealand)</b>	—		<b>TONE</b> PULSE	Select the dialling mode.	14	

\* The factory setting (option) is shown in bold.





To access the menu, press  **Menu/Set**.





To exit, press  **Stop/Exit**.

<b>Main Menu</b> 	<b>Submenu</b> 	<b>Menu Selections</b> 	<b>Options</b> 	<b>Descriptions</b> to accept 	<b>Page</b>
<b>2. FAX</b>	<b>1. SETUP RECEIVE</b>	<b>1. RING DELAY</b>	10 09 08 07 06 05 04 03 (Example for <b>02</b> Australia)	Number of rings before the machine answers in Fax/Tel (F/T) or Fax Mode.	21
		<b>2. F/T RING TIME</b>	70 40 <b>30</b> (Example for 20 Australia)	Sets the time for “F/T pseudo-ring” in Fax/Tel (F/T) Mode.	21
		<b>3. FAX DETECT</b>	ON SEMI OFF	Receive fax messages without pressing the <b>Fax Start</b> key.	22
		<b>4. REMOTE CODE</b>	ON (*51, #51) (*91, #91 for New Zealand) <b>OFF</b>	Activate or deactivate the machine from a remote location. You can also personalize these codes.	39
		<b>5. AUTO REDUCTION</b>	ON OFF	Reduces size of image.	23
		<b>6. MEM.RECEIVE</b>	ON OFF	Automatically stores any incoming faxes in its memory if it runs out of paper.	24
		<b>7. PRINT DENSITY</b>	- ■ ■ ■ □ □ +	Adjusts printing to be lighter or darker.	23
		<b>8. POLLING RX</b>	STANDARD SECURE TIMER	You call another fax machine to receive a fax from it.	49
	<b>2. SETUP SEND</b>	<b>1. CONTRAST</b>	AUTO LIGHT DARK	Change the lightness or darkness of a fax you are sending.	16
		<b>2. FAX RESOLUTION</b>	STANDARD FINE S.FINE PHOTO	Changes the default setting of fax resolution.	16
		<b>3. TIMER</b>	—	Set the machine to send your documents later.	32

\* The factory setting (option) is shown in bold.

To access the menu, press  **Menu/Set**.





To exit, press  **Stop/Exit**.

Main Menu	Submenu	Menu Selections	Options	Descriptions	Page
			 to accept		
<b>2. FAX (Continued)</b>	<b>2. SETUP SEND (Continued)</b>	<b>4. BATCH TX</b>	ON <b>OFF</b>	Sends all delayed faxes that are to the same fax number and at the same time as one transmission.	32
		<b>5. REAL TIME TX</b>	NEXT FAX ONLY ON <b>OFF</b>	When memory is full, you can send faxes in real time.	19
		<b>6. POLLED TX</b>	STANDARD SECURE	Set Polled Transmission for someone to poll the machine to receive a fax from you.	51
		<b>7. COVERPG SETUP</b>	NEXT FAX ONLY ON <b>OFF</b> PRINT SAMPLE	Automatically sends a programmable cover page or prints a sample coverpage.	30
		<b>8. COVERPAGE NOTE</b>	—	Program a customized message for fax cover page.	31
		<b>9. OVERSEAS MODE</b>	ON <b>OFF</b>	Special setting for international transmissions.	32
	<b>3. SET QUICK-DIAL</b>	<b>1. ONE-TOUCH DIAL (For FAX-2850 Only)</b>	—	Stores dial numbers in memory so as to dial them by pressing only one key.	14
		<b>2. SPEED-DIAL (1.SPEED-DIAL For MFC-4800)</b>	—	Stores dial numbers in memory so as to dial them by pressing only four keys.	15
		<b>3. SETUP GROUPS (2.SETUP GROUPS For MFC-4800)</b>	—	Set up a Group for broadcasting.	34
	<b>4. REPORT SETTING</b>	<b>1. TRANSMISSION</b>	ON <b>ON+IMAGE</b> OFF OFF+IMAGE	Initial setup for Transmission Verification Report and Journal period.	28
		<b>2. JOURNAL PERIOD</b>	2/4/7 Days 1/3/6/12/24 Hours <b>OFF</b>		28

\* The factory setting (option) is shown in bold.

To access the menu, press  **Menu/Set**.

To exit, press  **Stop/Exit**.

Main Menu	Submenu	Menu Selections	Options	Descriptions	Page	
						
<b>2. FAX (Continued)</b>	<b>5. REMOTE FAX OPT</b>	<b>1. FAX FWD</b>	ON <b>OFF</b>	Set the machine to forward faxes.	52	
		<b>2. FAX STORAGE</b>	ON <b>OFF</b>	Store incoming faxes in memory for fax forwarding and remote retrieval.	52	
		<b>3. REMOTE ACCESS</b>	159 *	Set code for retrieving faxes.	53	
		<b>4. PRINT DOCUMENT</b>	—	Print incoming faxes stored in the memory.	24	
	<b>6. REMAINING JOBS</b>	—	—	Check which jobs are in memory or cancel a delayed fax (timer) or polling job.	35	
	<b>0. MISCELLANEOUS</b>	<b>1. MEM SECURITY</b>	—	—	Prohibits most functions except receiving faxes into memory.	35
		<b>2. DISTINCTIVE (Not available in New Zealand)</b>	ON <b>OFF</b>	Use with phone company distinctive ringing service to register the ring pattern with the MFC.	40	
		<b>2. FAXABILITY (Only for New Zealand)</b>	ON <b>OFF</b>	If you have FaxAbility from Telecom, you can use this function to store the ringing pattern of your fax number. And if you set it to ON, you should use the registered number as a fax number only.	43	
		<b>3. CALLER ID</b>	DISPLAY PRINT REPORT	View or print a list of the last 30 Caller IDs stored in memory.	46	
	<b>3. COPY</b>	<b>1. COPY MODE</b>	—	<b>AUTO</b> TEXT PHOTO	Selects the Copy resolution for your type of document.	58, 60
<b>2. CONTRAST</b>		—	- ■ ■ ■ □ □ +	Adjust the contrast.	58, 60	
<b>3. PAPER TYPE</b>		—	THIN <b>PLAIN</b> THICK THICKER	Identify the type of paper in the multi-purpose sheet feeder.	61	

\* The factory setting (option) is shown in bold.

# About Fax Machines

If you are a first-time fax machine user, fax operation might seem a little mysterious. You will soon get used to the unusual fax tones on your phone line, and be able to send and receive faxes easily.

## Fax Tones and Handshake

---

When someone is sending a fax, the fax machine sends fax calling tones, (CNG tones)—soft, intermittent beeps at 4-second intervals. You'll hear them when you dial and press **Fax Start**, and they continue for about 60 seconds after dialling. During that time, the sending machine must begin the "handshake" with the receiving machine. Each time you use automatic procedures to send a fax, you are sending CNG tones over the phone line. You'll soon learn to listen for these soft beeps each time you answer a phone on your fax line, so you can know if you are receiving a fax message.

The receiving fax responds with fax receiving tones—loud, chirping sounds. A receiving fax chirps for about 60 seconds over the phone line, and the screen displays **RECEIVING**. If the machine is set to the Fax Only Mode, it will answer every call automatically with fax receiving tones. Even if the other party hangs up, the machine continues to send the "chirps" for about 60 seconds, and the screen continues to display **RECEIVING**. To cancel the receiving mode, press **Stop/Exit**.

When the machine is in Fax/Tel (F/T) Mode, it answers with a short beep. After this beep, the fax machine listens for CNG tones, and then responds with receiving tones.

The fax "handshake" is the time in which the sending machine's CNG tones and the receiving machines "chirps" overlap. This must be for at least 2 to 4 seconds, so the fax machines can understand how each is sending and receiving the fax. The handshake cannot begin until the call is answered, and the CNG tones only last for about 60 seconds after the number is dialled. Therefore, it's important for the receiving machine to answer the call in as few rings as possible.



When you have an external telephone answering device (TAD) on your fax line, your TAD will determine the number of rings before the call is answered. Pay special attention to the directions in the Installation chapter for connecting a TAD (or answering machine) to the machine.

## ECM (Error Correction Mode)

---

The Error Correction Mode (ECM) is a way for the fax machine to check the integrity of a fax transmission while it is in progress. ECM transmissions are possible only between machines that both have the ECM feature. If they do, you may send and receive fax messages that are continuously checked for their integrity.

Sufficient memory must be available in the machine for this feature to work.

# Glossary

- ADF (Automatic Document Feeder Capacity)** Refers to the number of pages that can be placed in the document feeder and fed one at a time automatically.
- Automatic E-Mail Printing** Software application that automatically prints incoming E-mail messages on the FAX/MFC. (Instructions are on the CD-ROM.)
- Automatic Fax Transmission** Sending a fax without picking up the handset or pressing **Hook**.
- Automatic Redial** A feature that enables the machine to redial the last fax number if the original fax did not go through because the line was busy or there was no answer.
- Backup Print** Sets the machine to print a copy of faxes that are received and stored in memory.
- Beeper** The sound the keys make when they are pressed, an error occurs or a document has been received or transmitted.
- Beeper Volume** Volume setting for the beep when you press a key or make an error.
- Broadcasting** The ability to send the same fax message to more than one location.
- Caller ID** A service purchased from the Telephone Company that lets you see the number (or name) of the party calling you.
- CNG tones** The special tones (beeps) sent by fax machines during automatic transmission to tell the receiving machine that they are from a fax machine.
- COMM. ERROR (Communication error)** An error during fax sending or receiving, usually caused by line noise or static.
- Coding Method** Method of coding the information contained in a document. All fax machines must use a minimum standard of Modified Huffman (MH). The machine is capable of greater compression method, Modified Read (MR) and Modified Modified Read (MMR), if the receiving machine has the same capability.
- Compatibility Group** The ability of one fax unit to communicate with another. Compatibility is assured between ITU-T Group.
- Contrast** Setting to compensate for dark or light documents, by lightening dark documents or darkening light documents.
- Cover Page** Prints a page at the other party's machine, that contains the sender and recipient's name and fax number, number of pages and comment. You can generate an electronic cover page at the other end with pre-programmed information from memory or you can print a sample cover page to fax with your document.
- Cover Page Message** The comment that is on the Cover Page. This is a programmable feature.
- Delayed Transmission** Sends your fax at a later time that day.
- Distinctive Ring** A service purchased from the Telephone Company that provides another phone number on an existing phone line. The Brother fax machine uses the new number to simulate a dedicated fax line.
- Drum unit** A printing device for the machine.
- Dual Access** The machine can scan outgoing faxes or scheduled jobs into memory at the same time it is sending a fax or receiving or printing an incoming fax.

- ECM (Error Correction Mode)** Detects errors during fax transmission and resends the parts of the document that had errors.
- Electronic Cover Page** A preprogrammed cover page that is transmitted from the machine's memory, eliminating the need for making up cover pages manually.
- Extension Phone** A telephone on the fax number that is plugged into a separate wall jack.
- External Phone** A TAD (telephone answering device) or telephone that is plugged into the Ext. socket of the machine.
- F/T Ring Time** The length of time the machine rings (when the answer mode setting is Fax/Tel) to notify you to pick up a voice call that has been automatically answered.
- FaxAbility** A service purchased from the Telephone Company that provides another phone number on an existing phone line. The Brother fax machine uses the new number to simulate a dedicated fax line.
- Fax/Tel mode** You can receive faxes and telephone calls. Do not use Fax/Tel if you are using an external answering machine. (With external telephone only)
- Fax Forwarding** Sends a fax received in memory to another preprogrammed fax number.
- Fax Storage** You can store faxes in memory for remote retrieval.
- Fax tones** The signals sent by sending and receiving fax machines while communicating information.
- Fine Mode** Resolution is 203 x 196 dpi. It is used for small print and graphs.
- Grey scale** The shades of grey available for copying and faxing photographs.
- Group number** A combination of One Touch (FAX-2850) and/or Speed Dial numbers that are stored on a One Touch Dial (FAX-2850) key or Speed Dial # for Broadcasting.
- Journal** Lists information about the last 200 incoming and outgoing faxes. TX means Transmit. RX means Receive.
- Journal Period** The preprogrammed time period between automatically printed Journal Reports. You can print Journal on demand without interrupting this cycle.
- LCD (Liquid crystal display)** The display screen on the machine that shows interactive messages during On-Screen Programming and defaults to the date and time when the machine is idle.
- Manual fax** When you press **Hook—OR—**lift the handset so you can hear the receiving fax machine answer before you press **Fax Start** to begin transmission.
- Menu Mode** The programming mode for changing the setting of the machine.
- One Touch Dial (FAX-2850 Only)** Keys on the machine control panel where you can store numbers for easy dialling. You must use a separate key for each number.
- Out of Paper Reception** Receives faxes into the machine's memory when the machine is out of paper.
- Overseas Mode** Makes temporary changes to the fax tones to accommodate noise and static on overseas phone lines.
- Pause** Allows you to place a 3.5 second delay in the dialling sequence stored.
- Photo Mode** A resolution setting that uses varying shades of grey for the best representation of photographs.
- Polling** The process of a fax machine calling another fax machine to retrieve waiting fax messages.

- Pulse** A form of dialling on a telephone line.
- Print reduction** Reduces the size of incoming faxes.
- Quick-Dial List** A listing of names and numbers stored in One Touch (FAX-2850) and Speed Dial memory, in numerical order.
- Real Time transmission** When memory is full, you can send documents in real time.
- Remaining Jobs** You can check which jobs are waiting in memory and cancel jobs individually.
- Remote access** The ability to access the machine remotely from a touch tone phone.
- Remote activation** allows you to transfer a fax call, answered at an extension phone, to the machine.
- Remote access code** The four-digit code that allows you to call and access the machine from a remote location.
- Resolution** The number of horizontal and vertical lines per inch.
- Ring Delay** The number of telephone rings before the machine answers a call in Fax/Tel (F/T) or Fax Only Mode.
- Ring Volume** Volume setting for the machine's ring.
- Scanning** The process of sending an electronic image of an original paper document into your computer.
- Search** You can search for names you have stored in One Touch (FAX-2850) and Speed Dial memories.
- Speaker Volume** You can set the volume of the machine speaker.
- Speed dial** A preprogrammed number for easy dialling. You must press the **Search/Speed Dial** key and #, then two digit code to start the dialling process.
- Standard resolution** 203 × 98 dpi. It is used for regular size text and quickest transmission.
- Station ID** The stored information that appears on the top of faxed pages. It includes the sender's name and fax number.
- Super fine resolution** 203 × 391 dpi. Best for very small print and line art.
- System Setup List** A printed report that shows the current setting of the machine.
- Temporary Setting** You can select certain options for each fax transmission without changing the default settings.
- Timer** A feature that lets you program a fax to go out at a certain time, such as Delayed Fax or Delayed Polling Receive.
- Tone** A form of dialling on the telephone line used for Touch Tone telephones.
- Toner cartridge** An accessory that holds toner for the drum unit on Brother laser models.
- Toner Save** A process that causes less toner to be affixed to the page to extend the life of the toner assembly. This will make the receiving document significantly lighter.
- Transmission** The process of sending documents over the phone lines from the machine to the receiving fax machine.
- Transmission Report** A listing of each transmission, showing caller ID, date, time, and number of pages.

# Index

## A

Accessories .....	146
Activation Code .....	38
Administrator .....	73
Alternating Displays .....	iii
Answering Machine .....	5
Auto Reduction .....	23
Automatic Document Feeder (ADF) .....	1
Automatic Transmission .....	2, 18

## B

Beeper Volume .....	12
Broadcasting .....	33
Brother Control Centre .....	76
Brother MFL-Pro Control Centre ....	76-77

## C

Chain Dialling .....	17
CHANGE DRUM SOON .....	117, 132
CHANGE TONER .....	117, 129
CHECK DRUM UNIT .....	117
CHECK PAPER .....	117
CHECK PAPER SIZE .....	117
Cleaning (Drum Unit) .....	128
Cleaning (Printer) .....	127
Cleaning (Scanner) .....	127
COMM.ERROR .....	117
Connect (External Telephone Answering Machine) .....	5
Connect (External Telephone) .....	6
Contrast .....	16
Control Panel Overview .....	7, 9
COOLING DOWN .....	117
Copy (2in1/4in1) .....	59
Copy (Enlarging/Reducing) .....	57
Copy Contrast .....	58

Copy Mode .....	58, 60
Copy Operations .....	56
Corrections .....	147
COVER OPEN .....	117
Cover Page .....	30
Cover Page Message .....	31

## D

Date and Time .....	11
Deactivation Code .....	38
Delayed Batch Transmission .....	32
Delayed Transmission (Timer) .....	32
Device Options .....	72
Dialling Mode (Tone/Pulse) .....	14
Difficulty .....	121
Document (Size) .....	1
Document Jam .....	119
Drum Unit (Replacing) .....	132
Dual Access .....	19
Duplex Printing .....	69

## E

ECM (Error Correction Mode) .....	153
Entering Text .....	147
Error Messages .....	117
Extension Telephone .....	38
External Telephone .....	6, 38
External Telephone Answering Device (TAD) .....	5

## F

F/T (Fax/Tel) Ring Time .....	21
F/T Ring Time .....	38
Fax Detect .....	22
Fax Forwarding .....	52
Fax Storage .....	52



Fax Tones and Handshake .....	153
Fine (Resolution) .....	16
Function Selection Table .....	148

**G**

Glossary .....	154
Grey Scale .....	143

**H**

HELP .....	29
Help .....	ii

**I**

iMac .....	107
Importing .....	91
Inserting Spaces .....	147
International Calls .....	32

**J**

Job Cancel .....	35
JOURNAL .....	29
JOURNAL PERIOD .....	28
Journal Period .....	28

**M**

Macintosh® G3, G4 or iMac™ .....	107
Maintenance .....	117
Memory Security .....	35
Memory Storage .....	4
Menu Mode .....	148
Menu Selection Table .....	148
Multi-Function Link® Pro Suite .....	95
Multi-Purpose Sheet Feeder .....	62
Mute .....	26

**N**

Navigation Keys .....	8, 10
NO RESPONSE/BUSY .....	118
NOT ASSIGNED .....	118

**O**

One Touch Dial (Changing) .....	15
One Touch Dial (Storing) .....	14
On-Screen Programming .....	iii
Options .....	7
Options Key .....	58
ORDER FORM .....	29
Order Form .....	29
OUT OF MEMORY .....	57
Outgoing Message .....	6
Overseas Mode .....	32

**P**

Packing and Shipping .....	125
Page Setting .....	71
Paper .....	65
PAPER JAM .....	118
Paper Jam .....	119
Paper Type .....	65
PaperPort® .....	89
Pause .....	18
PC FAX .....	96
PC FAX (Sending) .....	105
PC FAX (Setting) .....	96
PC FAX Sending (For Macintosh) .....	109
Photo (Resolution) .....	16
PLS OPEN COVER .....	118
Polling (Receive) .....	49
Polling (Transmit) .....	51
Power Cord .....	3
Power Save .....	13
Print a Report .....	29

Print Date & Time .....	74
Print Density .....	23
Printer Driver Settings .....	66
Product Description .....	143

## Q

Quick Print Setup .....	72
QUICK-DIAL .....	29
QUICK-DIAL (list) .....	29

## R

Real Time Transmission .....	19
Receive Mode .....	20
Reception into Memory .....	24
Remote Access Code .....	53
Remote Code (Changing) .....	39
Remote Commands .....	54
REMOTE CONTROL ACCESS CARD ..	160
Remote Retrieval .....	53
Remote Setup .....	95
Reports .....	28
Reports/Recall .....	7, 9
Reset Key .....	64
Resolution .....	16
Ring Delay .....	21
Ring Volume .....	12

## S

Scan Image .....	78
Scan Keys .....	77
Scan to E-mail .....	78
Scan to File .....	82
Scan to Word Processor .....	85
Scan/OCR .....	78
Scanning into PC .....	92
ScanSoft™ PaperPort® .....	89
Search .....	17

Simultaneous Printing/Fax .....	64
Sleep Mode .....	13
Speaker Volume .....	12
Special characters .....	147
Specifications .....	143
Speed Dial .....	15
Speed Dial (Changing) .....	15
Standard (Resolution) .....	16
Station ID .....	11
Storing Telephone number .....	14
SYSTEM SETUP .....	29

## T

To change Remote Codes .....	39
Tone/Pulse .....	14
Toner Cartridge (Replacing) .....	129
TONER EMPTY .....	118
Toner Save .....	13
Trademarks .....	146
Transmission report .....	28
Transmission Verification Report .....	28
Troubleshooting .....	117

## W

Watermark .....	70
Word Processor .....	85

**Change Answer Mode**Press **9 8***then for***TAD**, press **1**.**Fax/Tel (F/T)**, press **2**.**Fax**, press **3**.**Exit Remote Operation**Press **9 0**.**Change Remote Access Code****1** Press **Menu/Set**, **2**, **5**, **3**.**2** Enter the 3-digit number. The \* cannot be changed.**3** Press **Menu/Set**.**4** Press **Stop/Exit**.**4****REMOTE CONTROL ACCESS CARD****Using Remote Access Code****1** Dial the machine phone number from a touch tone phone.**2** Enter your Remote Control Access Code (159\*) after the beep.**3** The machine signals the kinds of messages received:**1 long beep — Fax message(s)****No beeps — no messages****4** After 2 short beeps, enter a command.**5** Press **9 0** to reset the machine when you finish.**6** Hang up.**1**

## Remote Commands

### Change Fax Forwarding Setting

Press **9 5**

*then to* **Turn Fax Forwarding OFF** press **1**.

**Turn Fax Forwarding ON** press **2**.

**Program Fax Forward Number**

press **4**. Enter the new number of the remote fax machine where you want your fax message forwarded and then press **# #**.

**Turn Fax Storage ON** press **6**.

**Turn Fax Storage OFF** press **7**.

### Retrieve Fax

Press **9 6**

*then to* **Retrieve all faxes** press **2**, then enter the number of remote fax machine, and then **# #**. After the beep, hang up and wait.

**Erase all fax messages** press **3**.

### Check the Receiving Status

Press **9 7 1**.

**1 long beep** — Fax message(s)

**3 short beeps** — no messages

**2**

**3**





This machine is approved for use in the country of purchase only, local Brother companies or their dealers will only support machines purchased in their own countries.

ARL/ASA/NZ  
version A  
Printed in China

## Free Manuals Download Website

<http://myh66.com>

<http://usermanuals.us>

<http://www.somanuals.com>

<http://www.4manuals.cc>

<http://www.manual-lib.com>

<http://www.404manual.com>

<http://www.luxmanual.com>

<http://aubethermostatmanual.com>

Golf course search by state

<http://golfingnear.com>

Email search by domain

<http://emailbydomain.com>

Auto manuals search

<http://auto.somanuals.com>

TV manuals search

<http://tv.somanuals.com>