

brother®

TZ
TAPE

P-touch

1800/1810

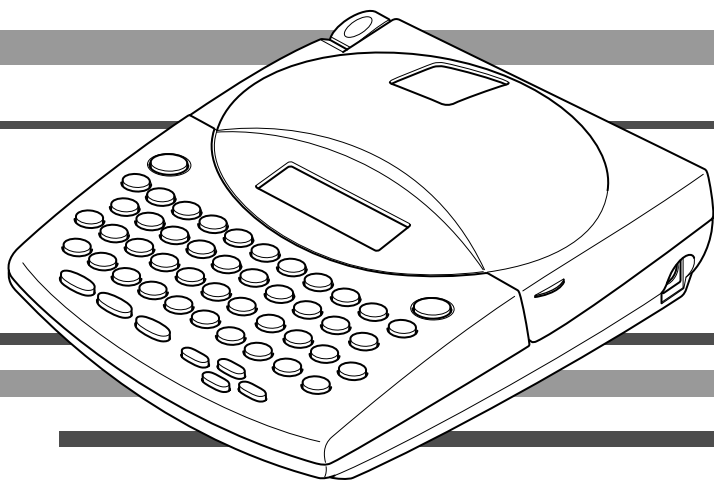

USER'S GUIDE

- Read this User's Guide before you start using your P-touch.
- Keep this User's Guide in a handy place for future reference.

INTRODUCTION

Thank you for purchasing the P-touch 1800/1810!

Your new P-touch will allow you to create labels and stamps for any need. Its versatility enables you to design custom labels by choosing from a variety of frame designs and from many characters sizes and styles. In addition, the four tape widths (1/4" (6 mm), 3/8" (9 mm), 1/2" (12 mm), and 3/4" (18 mm)) and variety of tape colors allow you to print personalized labels, useful for color-coded filing. With the **Stamp** function, you can quickly and easily make stamps for reusable pre-inked stamp holders.

You no longer have to worry about urgent tasks that require professional printing. In the office, the factory, the lab and the home, the quality and performance of the P-touch 1800/1810 makes it an extremely practical machine.

Finally, as you may want to refer to this User's Guide occasionally, we suggest that you keep it in a handy place.

(The PT-1800 and the PT-1810 models are equipped with the same functions; however, only the PT-1810 is available with a carrying case.)

FCC NOTICE

This equipment has been tested and found to comply with the limits for a Class B digital device, pursuant to Part 15 of the FCC Rules. These limits are designed to provide reasonable protection against harmful interference in a residential installation. This equipment generates, uses, and can radiate radio frequency energy and, if not installed and used in accordance with the instructions, may cause harmful interference to radio communications. However, there is no guarantee that interference will not occur in a particular installation. If this equipment does cause harmful interference to radio or television reception, which can be determined by turning the equipment off and on, the user is encouraged to try to correct the interference by one or more of the following measures:

- Reorient or relocate the receiving antenna
- Increase the separation between the equipment and receiver.
- Connect the equipment into an outlet on a circuit different from that to which the receiver is connected.
- Consult the dealer or an experienced radio/television technician for help.

Patent numbers and patent publication numbers which are related to this product are as below:

USP4839742	USP4983058	USP5120147
USP4927278	USP5009530	
USP4976558	USP5069557	

CONTENTS

Getting Started

GENERAL DESCRIPTION.....	2
GENERAL PRECAUTIONS	4
BATTERIES.....	5
OPTIONAL AC ADAPTOR	6
TAPE CASSETTE.....	7
ATTACHING LABELS.....	8
PRINT HEAD & ROLLERS	9

Learning the Ropes

DOOR LABEL EXAMPLE.....	12
ADDRESS LABEL EXAMPLE	16

For Your Information

POWER KEY	24
CURSOR KEYS.....	25
CODE, ALT & SHIFT KEYS.....	27
SPACE KEY	30
RETURN KEY	31
TAB FUNCTION.....	32
DELETE KEY	34
LINE OUT FUNCTION	35
CLEAR FUNCTION.....	36
ACCENT FUNCTION.....	39
SYMBOL FUNCTION	41
AUTO FORMAT FUNCTION.....	43
STAMP FUNCTION	45
SIZE & WIDTH FUNCTIONS.....	49
STYLE FUNCTION.....	53
UNDERLINE FUNCTION.....	56
FONT FUNCTION.....	57
FRAME FUNCTION	59

TAPE MARGIN FUNCTION.....	61
HORIZONTAL ALIGNMENT FUNCTION.....	63
MIRROR PRINTING FUNCTION	64
LENGTH FUNCTION	65
PRINT KEY & FEED FUNCTION	67
NUMBERING FUNCTION.....	68
REPEAT PRINTING FUNCTION.....	70
MEMORY FUNCTIONS.....	72
TROUBLESHOOTING.....	76
ERROR MESSAGE LIST	77
SPECIFICATIONS.....	81
ACCESSORIES.....	82

Getting Started

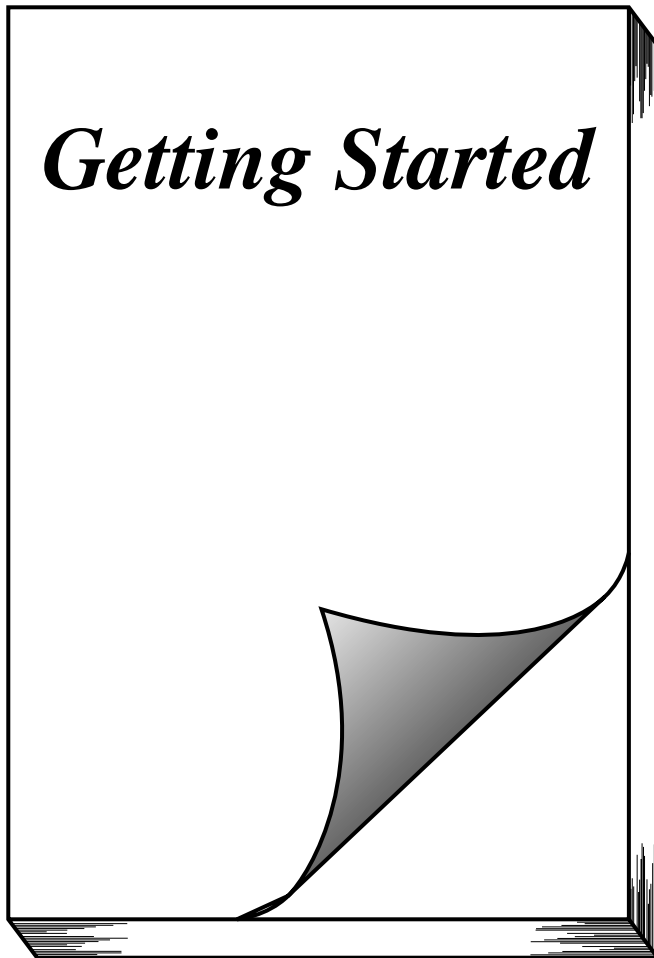

GENERAL DESCRIPTION

TOP VIEW

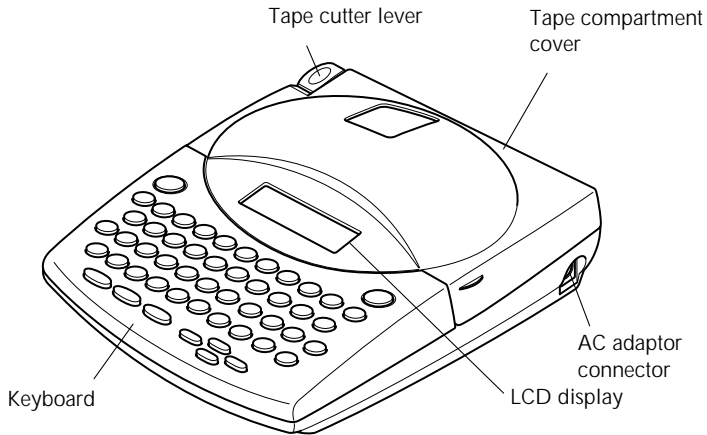

BOTTOM VIEW

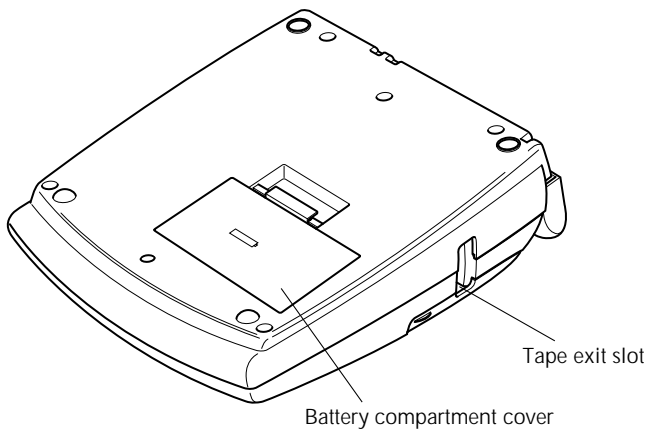

KEYBOARD & LCD DISPLAY

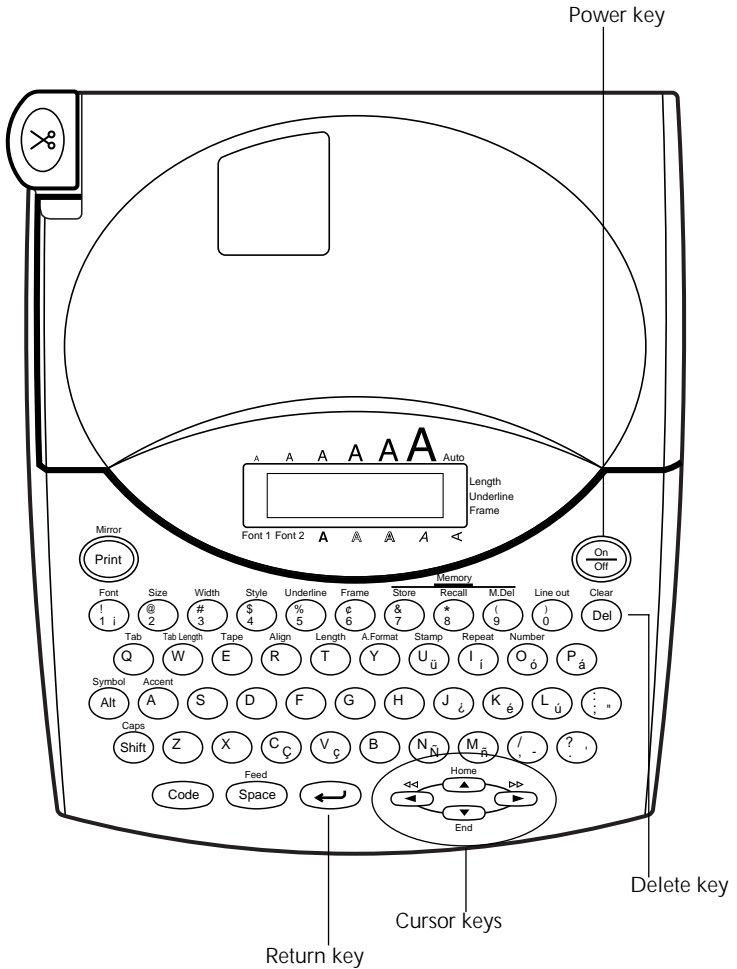

GENERAL PRECAUTIONS

- Use only Brother TZ tapes with this machine. Do not use tapes that do not have the  mark.
- Do not pull on the tape being fed from the P-Touch. This may damage the tape cassette.
- Do not use the machine in dusty places, and keep it out of both direct sunlight and rain.
- Do not expose the machine to high temperatures or high humidity. Never leave it on the dashboard or in the back of your car.
- Do not leave any rubber or vinyl on the machine for an extended period of time. Doing so may cause staining.
- Do not clean the machine with alcohol or other organic solvents. Use a soft, dry cloth only.
- Do not put any foreign objects into or anything on the machine.
- To avoid injuries, do not touch the cutter's edge.
- Use only the AC adaptor (model AD-60) designed exclusively for this machine. Use of any other adaptor will void the warranty.
- Do not try to disassemble the AC adaptor.
- When the machine is not being used for a long period of time and it is not necessary to keep the text files stored in the memory, disconnect the AC adaptor, and remove the batteries to prevent them from leaking and damaging the machine.
- When the AC adaptor is connected, unplugging the adaptor from the electrical outlet before unplugging it from the machine can delete all text files in the memory, even if batteries are installed.
- **Use six AA alkaline batteries in this machine.**

BATTERIES

This lightweight and portable machine can be used anywhere by installing six (6) **AA alkaline batteries**. When you change the batteries, always replace all six at the same time.

To change the batteries:

- 1 Remove the battery compartment cover on the back of the machine.
- 2 If batteries are already installed, remove them.
- 3 Insert six new AA alkaline batteries, making sure that they face the correct direction.
- 4 Attach the battery compartment cover.

☞ *Be sure to insert the new batteries within five minutes of removing the old ones, otherwise the text shown in the display and any text files stored in the memory will be lost (unless the machine is plugged into an AC outlet with the AC adaptor).*

Remove the batteries and disconnect the AC adaptor if you do not intend to use this machine for an extended period of time. When the power is disconnected, all text shown in the display and stored in the memory will be lost.

If alkaline batteries are not used, large fonts cannot be printed.

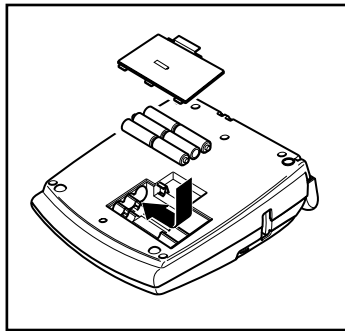
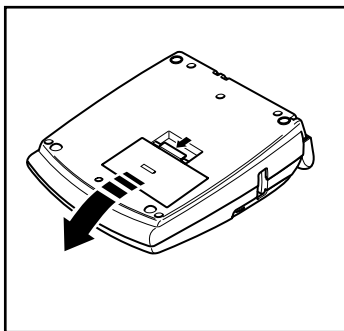

OPTIONAL AC ADAPTOR

The AC adaptor (model AD-60) allows you to use this machine wherever there is an electrical outlet.

To connect the optional AC adaptor:

- 1 Insert the plug on the adaptor cord into the connector marked DC IN 9.5V on the right side of the machine.
- 2 Insert the plug on the adaptor into the nearest standard electrical outlet.



Only use the AC adaptor designed exclusively for this machine.

Remove the batteries and disconnect the AC adaptor if you do not intend to use this machine for an extended period of time. When the power is disconnected, all text shown in the display and stored in the memory will be lost.

When the AC adaptor is connected, unplugging the adaptor from the electrical outlet before unplugging it from the machine can delete all text files in the memory, even if batteries are installed.

It is recommended that you use the AC adaptor when printing large fonts on 3/4" (18-mm)-wide tape since this operation can quickly drain the batteries.

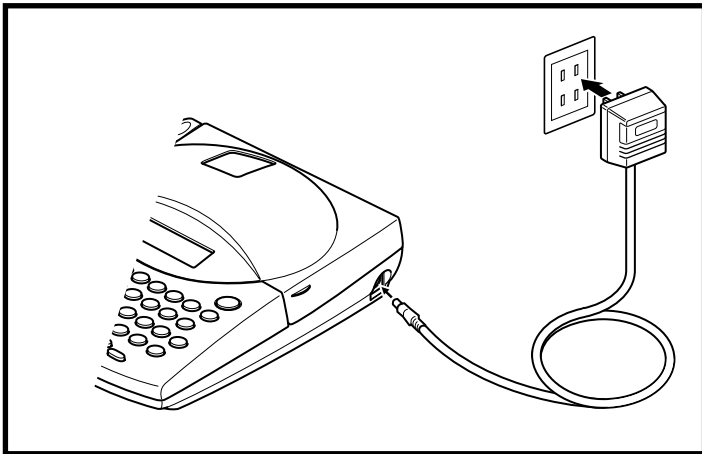





TAPE CASSETTE

A single TZ tape cassette is supplied with this unit. However, since TZ tape cassettes are available for this machine in a wide variety of colors and sizes, it is possible to make distinctive color-coded and stylized labels.

In addition, this machine has been designed to allow you to change the tape cassettes quickly and easily.

To change the tape cassette:

- 1 Lift open the tape compartment cover. The installed cassette is also released.
- 2 If a tape cassette is already installed, remove it by pulling it straight up.
- 3 If the ink ribbon in the other tape cassette is loose, use your finger to wind the toothed wheel in the direction of the arrow on the cassette until there is no slack in the ribbon. Also, make sure that the end of the tape feeds under the tape guides.
 *If you are using a new tape cassette provided with a stopper, be sure to remove the stopper.*
- 4 Insert the tape cassette firmly into the tape compartment, making sure that the entire back of the cassette touches the bottom of the compartment.
 *When inserting the tape cassette, make sure that the inner ribbon does not catch on the corner of the metal guide.*
- 5 Close the compartment cover, then turn on the machine if it is off.
- 6 Hold down  and press  once to advance the tape and remove any slack.
- 7 Push down on the tape cutter lever to cut off any excess tape.

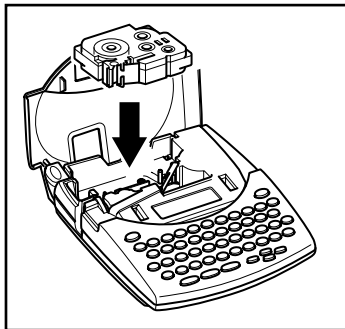
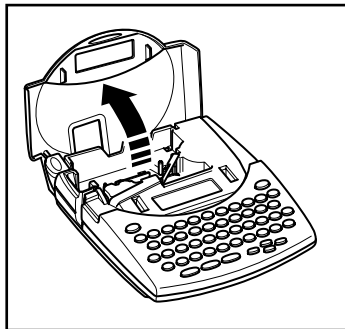

ATTACHING LABELS

LAMINATED TAPE

The enclosed stick enables you to easily remove the backing from labels printed on laminated tapes.

- 1 Hold the tape in your left hand, with the printed surface facing up, and hold the stick in your right hand.
- 2 Pass the tape halfway through the long narrow hole in the stick.
- 3 Turn the stick three-quarters of a turn towards you and pull the stick away from you as shown below.
- 4 Peel off the label backing.

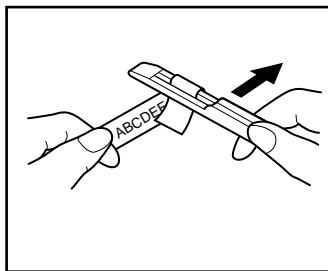
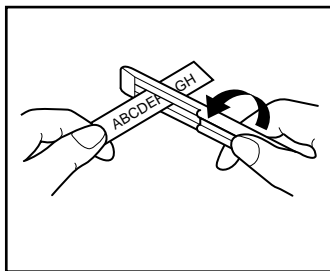

FABRIC TAPE

Fabric tape is used to attach a piece of fabric printed with your text onto garments using an iron. After printing the text onto fabric tape and cutting off the label using scissors, place the label on an ironed garment at the location where you wish to attach it in such a way that the printed text can be read correctly. Cover the label with another piece of cloth and use an iron set to a medium-high temperature (320 to 356 °F (160 to 180 °C)) to press down firmly for 10 to 15 seconds. For more details, refer to the instructions included with the fabric tape cassette.

STAMP TAPE

Refer to pages 45 through 48 for a detailed explanation on using the stamp tape to make stamps.

PRINT HEAD & ROLLERS

Occasionally, specks of dust or dirt become attached to the machine's print head and rollers. This is particularly likely when you are using the unit outdoors or in a very dusty environment. If a section of the print head is covered with dust, a blank horizontal streak may appear through the label text. Therefore, as with a tape recorder, the machine's head may need to be cleaned from time to time.

To clean the print head and rollers:

- 1 Turn off the machine.
- 2 Open the tape compartment cover, then remove the tape cassette if one is installed. The print head and rollers are located in the tape compartment.
- 3 **Print head:** Use a dry cotton swab to gently wipe the print head with an up-and-down motion.
Rollers: Use a dry cotton swab to wipe each roller with an up-and-down motion while rotating them with your finger.
- 4 Install a tape cassette, close the tape compartment cover, and then try printing again.
- 5 If dust still remains, repeat steps 3 and 4 using a cotton swab dipped in isopropyl (rubbing) alcohol.

If none of the above works, contact your service representative.

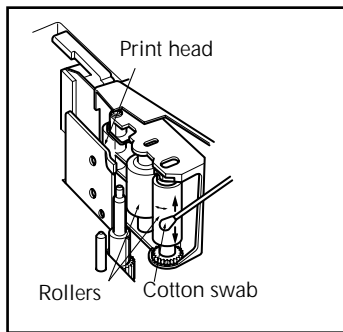
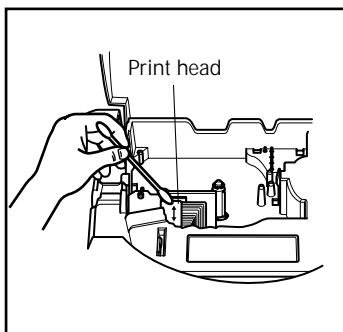



***Learning
the Ropes***

DOOR LABEL EXAMPLE



After you have inserted the batteries and the enclosed tape cassette as explained in the *Getting Started* chapter, let's practice using some of the basic functions of your P-touch. We must first begin by turning on the power to the machine.

To turn on the machine:

- 1 Press  in the top right-hand corner of the keyboard.



The underline in the LCD display is called the "cursor". It is like a pointer which shows your current position and lets you select characters in your text.

The text you create may sometimes be longer than the 11 characters that the LCD display can show at one time. Therefore, the cursor can be moved to show other parts of the text. Pressing the left cursor key () moves the cursor to the left so that the left side of the text can be seen and pressing the right cursor key () moves the cursor to the right so that the right side of the text can be seen.

Some format settings are shown by the triangular and square indicators around the edge of the display. The default settings (the selected settings when the power is turned on for the very first time) have been pre-programmed into the machine and represent the most common settings for labels. However, you can design your own label to have any format that you wish. Detailed explanations of the formats can be found on pages 64 through 66. Now, let's enter the text for our first example, the simple door label shown below.



MEETING ROOM

 The label in this example was made using the enclosed 1/2" (12-mm)-wide tape.

ENTERING THE TEXT

Since all of the text will be in capital letters, we will use the **Caps** mode, which allows us to type capital letters continuously without holding down .





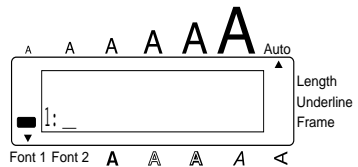

To enter Caps mode:

- 2 Hold down  and press  once. The **Caps** indicator on the left side of the display lights up.





Then, let's type in the text in the same way that you would type on a typewriter or a computer keyboard.

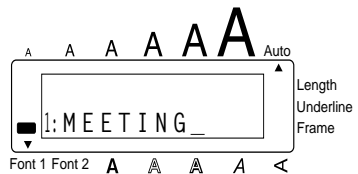

To type in "MEETING":

- 3 Press  once and  twice, then press , ,  and  once each.

All letters are automatically entered as capital letters.



Also like on a typewriter or computer keyboard, the **Space** key () allows you to add blank spaces to the text.

 The **Space** key () is different from the right cursor key () , which moves the cursor through the entered text without adding blank spaces.



To add a space:

- 4 Press .



Type the second word, "ROOM", to finish the text.

To type in "ROOM":



- 5 Press  once,  twice,
then  once.

Since the text is longer than the LCD display, "ME" moves off the display to the left.



Now that we are finished entering capital letters, we can exit **Caps** mode.

To exit Caps mode:

- 6 Hold down  and press
 once. The **Caps** indicator
goes off.



Once you have entered the text, you can easily edit it by correcting mistakes or simply adjusting it or its format. For detailed explanations of text editing methods, see pages 34 to 38.

PRINTING THE TEXT

Several format settings are available, however, in this example we will use the default settings pre-programmed into the machine and print out our label.

To print the door label:

- Press  once. The message "COPIES 1/1" appears while the label is being printed.



To cut off the door label:

- Push down on the tape cutter lever.

ADDRESS LABEL EXAMPLE

While making the multi-line address label in this example, we will learn how to create more decorative labels using the various format settings.

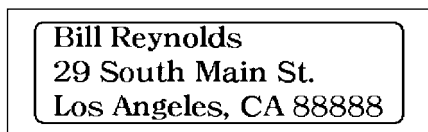

☞ *Three-line labels, such as this address label, can only be printed on either 1/2" (12-mm)- or 3/4" (18-mm)-wide tape.*

Before entering the new text, we must first erase the text shown in the display from the previous time that the machine was used. When clearing the display, we can choose whether to erase all of the text and return all format functions (**Font**, **Size**, **Width**, **Style**, **Underline**, **Frame**, **Tape margin**, **Alignment**, and **Length**) to their default settings or just to erase the text.

To erase all of the text and reset the format functions:

- ① Hold down **Code** and press

Clear
Del once.

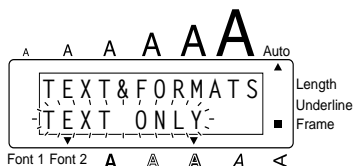

- ② Press **Home** or **End** until





TEXT&FORMATS is selected,
and then press **←**.



ENTERING THE TEXT

Let's begin by typing in the first row of text, the name "Bill Reynolds".

To type in "Bill Reynolds":

- 3 Hold down  and press  once, then release . Press  once, then  twice.





- 4 Press .

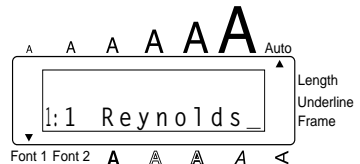

- 5 Type in "Reynolds".

Again, the text is longer than the LCD display. So "Bil" moves off the display to the left.



In a multi-line label, the return key () is used to end one line and start the next one. The return mark () indicates the end of the line.

To end the first line and begin another one:

- 6 Press .

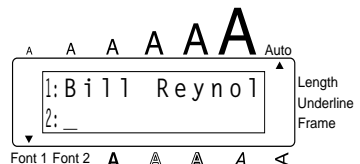

Now, we can enter the address: 29 South Main St.; Los Angeles, CA 88888.

To type in the address:

- 7 Type "29 South Main St.", then press .



- 8 Type "Los Angeles, CA 88888".

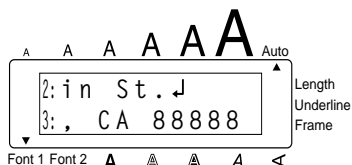



FORMATTING THE TEXT

Now the text has been entered as we wish. If it were printed, the standard default settings would be used. The text would be aligned on the left side with 1" (25 mm) margins and would not be framed or underlined. In addition, the characters would be auto-sized (**Auto**) and printed using the **HELSINKI** font (Font1) and **NORMAL** style settings. For more details concerning format settings, please see pages 56 and 73.

For this label, though, let's assume we want a different style of text: **BRUSSELS** font (Font2), framed, and printed with **NARROW** (1/6" (4 mm)) tape margins. Therefore, we must change the format.

To select the BRUSSELS font setting:

- 9 While holding down , press  once, and keep  held down to display the current font setting.



- 10 While still holding down

Code, continue pressing

Font **1** until **BRUSSELS** is displayed, and then release

Code.

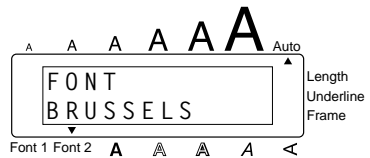

To select the ROUND frame setting:

- 11 While holding down **Code**,

press **Frame** **6** once, and keep

Code held down to display the current frame setting.



- 12 While still holding down **Code**,

continue pressing **Frame** **6** until

ROUND is displayed, and then release **Code**.



To select the NARROW tape margin setting:

- 13 While holding down **Code**,

press **Tape** **E** once, and keep

Code held down to display the current tape margin setting.

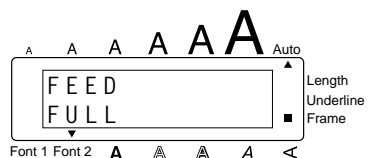

- 14 While still holding down

Code, continue pressing **Tape** **E**

until **NARROW** is displayed, and then release **Code**.

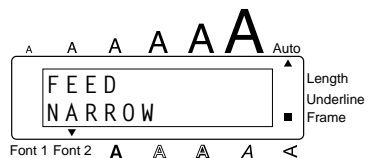



Different format settings can be chosen either before or after the text is entered. The procedure shown above can be used to change the other format settings.

PRINTING THE TEXT

If we want only one copy of the text, we could just press  to print it. However, let's assume that we have three letters onto which we wish to attach address labels. Therefore, we need to print three copies of the same text.

To print three copies of the label:

- 15 Hold down  and press

 once.



- 16 Press .



- 17 Press . The number of each copy is displayed while it is being printed.

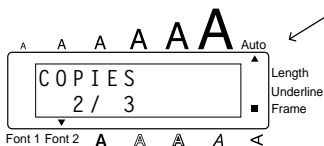

- 18 Push down on the tape cutter lever to cut the tape, then use scissors to cut along the cutting guide to separate the labels.

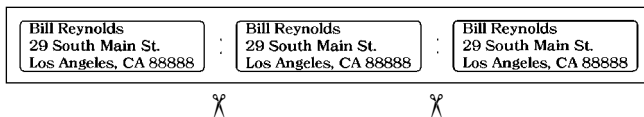

With these examples, we have covered many of the basic features of your P-touch so that you can begin creating your own customized labels. If you have any questions about any of the functions or keys, refer to the appropriate explanation in the following section.

***For Your
Information***

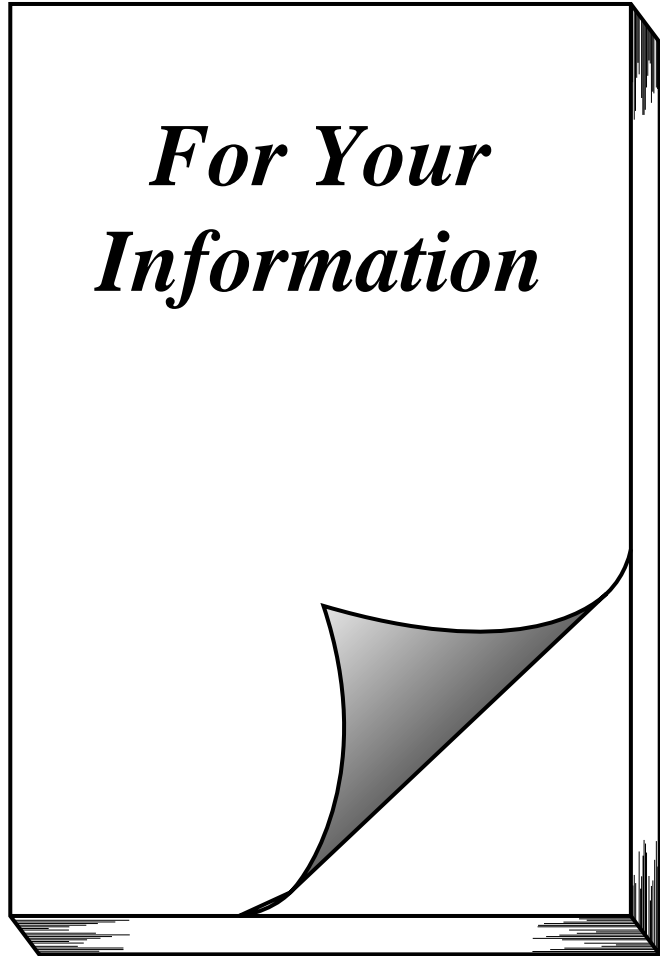

POWER KEY

The power key () is located in the top right-hand corner of the keyboard. If batteries have been installed or the machine has been plugged in using the optional AC adaptor, the previous session's information is displayed when the machine is turned on. This feature allows you to stop work on a label, turn off the machine, and return to it later without having to re-enter the text.

The machine will automatically turn off if no key is pressed within 5 minutes. The machine's internal memory stores the current session's information and displays it when you turn on the machine again.

To turn on the machine:

- Press . The previous session's information appears in the LCD display.

To turn off the machine:

- Press . The current session's information is stored in the internal memory.

CURSOR KEYS

The machine's LCD display shows two rows of 11 characters; however, the text that you create can be up to 99 characters long. You can review and edit your text by using the cursor keys to move the cursor so that different parts are shown in the display.

LEFT CURSOR KEY



To move the cursor one character to the left:

- Press  once.

To move the cursor several characters to the left:

- Hold down  until the cursor moves to the desired position.

To move the cursor to the beginning of the current line:

- Hold down  and press .

RIGHT CURSOR KEY

To move the cursor one character to the right:

- Press  once.

To move the cursor several characters to the right:

- Hold down  until the cursor moves to the desired position.

To move the cursor to the end of the current line:

- Hold down  and press .

UP CURSOR KEY

To move the cursor up to the previous line:

- Press  once.





If the cursor is in the first line of text, it will move to the beginning of the line.

To move the cursor up several lines:

- Hold down  until the cursor moves to the desired position.

To move the cursor to the beginning of the entire text:

- Hold down  and press .

DOWN CURSOR KEY

To move the cursor down to the following line:

- Press  once.





If the cursor is in the last line of text, it will move to the end of the line.

To move the cursor down several lines:

- Hold down  until the cursor moves to the desired position.

To move the cursor to the end of the entire text:

- Hold down  and press .

CODE, ALT & SHIFT KEYS

Most characters can be entered simply by pressing their keys. However, to use special functions or to enter capital letters, accented characters and some symbols, the following special keys are necessary.

CODE KEY

To use a function printed above a key:

- Hold down **Code** and press the key immediately below the desired function.

EXAMPLE

To start the Symbol function:

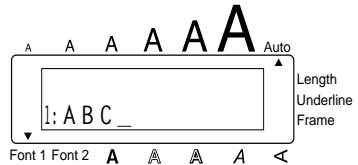



- Hold down **Code** and press

Symbol
Alt once.





ALT KEY

To type in characters printed in color on the right-hand side of the keys:

- Hold down  and press the key of the desired character written in color. The **Alt** indicator on the left side of the display lights up while  is held down.

EXAMPLE

To type in “-”:

- Hold down  and press  once. The **Alt** indicator lights up while  is held down.

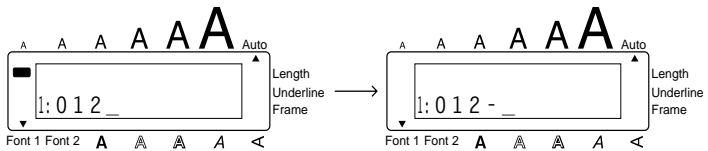

SHIFT KEY

To type in a capital letter or a symbol printed in the top left-hand corner of a key:

- Hold down  and press the key of the desired letter or symbol.

EXAMPLE

To type in "5":



- Hold down  and press .

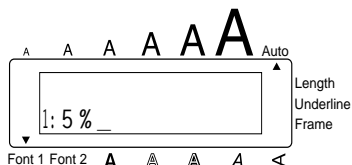



The **Caps** mode is similar to holding down . It allows you to type capital letters continuously.



To type in many capital letters:

- 1 Hold down  and press . The **Caps** indicator on the left side of the display lights up.



- 2 Press the keys of the desired letters or symbols.
- 3 To exit **Caps** mode, hold down  and press . The **Caps** indicator goes off.

SPACE KEY

The **Space** key () lets you add blank spaces between characters in your text. It is different from the right cursor key (), which just moves the cursor without adding blank spaces.

To add a space:

- Press  .

EXAMPLE

To add a space:





- Press  .



RETURN KEY



Like on a typewriter or word processor, this machine's return key () is used to end a line of text and start another one. When you have finished entering one line, press the return key to make a new line and move the cursor to it.

 A single block can only contain a maximum of three text lines. If you press  when the cursor is located in the third line, the error message "3 LINE LIMIT!" will appear.



Tape widths	Maximum number of lines that can be printed
1/4" (6 mm)	1
3/8" (9 mm)	2
1/2" (12 mm)	3
3/4" (18 mm)	3

The return key can also be used to select an item from a list (e.g., add a symbol or accented character to the text) or to apply a selected setting.

Some questions asking you to confirm a command may appear on the LCD display, especially when the function that you have chosen will delete or affect files. In these cases, pressing  is like answering "yes".

 To answer "no", press . Refer to DELETE KEY on page 34.

To add a new line:

- Press . The return mark () appears to indicate the end of the line.

To select an item from a list:



- Press .

To answer "yes":

- Press .





TAB FUNCTION



This function allows you to separate sections of a line of text by adding tabs. This enables you to create perfectly aligned columns without having to type in several spaces. All tabs have the same length and are measured from either the beginning of the line or the previous tab if there is more than one. The tab length can be set between 0.0" and 11.8" (0.0 and 30.0 cm).

 The text can contain no more than 50 tabs. If 50 tabs have already been added to the text when  is pressed, the error message "TAB LIMIT!" appears.

Part No.	Product	Price
Printer	8667	\$300
Fax	122960	\$75



To set the tab length:

- 1 Hold down  and press  once. The current tab length is displayed.
- 2 Press  or  until the desired length is displayed or use the number keys to type in the length.

 To change the units (inches or centimeters) used to display the tab lengths, press  until the desired units are displayed.

- 3 Press .

To add a tab:

- Hold down  and press  once. The tab mark () appears in the text to indicate the position of the tab.

 If the text in front of a tab extends past the point where the next section of text should start, the text will instead start at the following tab position.
For example, if the tab length is set to 2" and the following text is typed in:

```
1: A B C T D E F T G H I ↓  
2: J K L M N O P Q R S T U
```

the label shown below will be printed

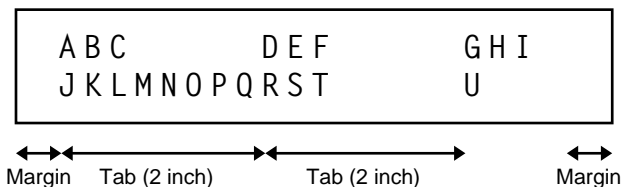

EXAMPLE

To set the tab length to 1":

- 1 Hold down **Code** and press

Tab Length
W once.

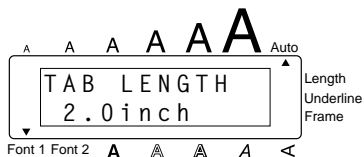

- 2 Press **End** until 1.0 is displayed.

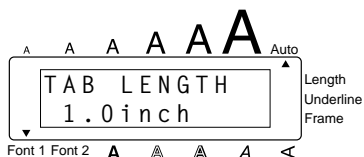

- 3 Press **Left Arrow**.



To add a tab:

- Hold down **Code** and press

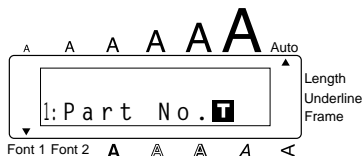
Tab
Q once.



DELETE KEY





The delete key () allows you to remove characters to the left of the cursor's current position. It differs from the left cursor key (), which only moves the cursor without deleting any characters.

The delete key can also be used to quit most functions and return to the previous display without changing the text.





Some questions asking you to confirm a command may appear on the LCD display, especially when the function that you have chosen will delete or affect files. In these cases, pressing  is like answering "no".

 To answer "yes", press . Refer to RETURN KEY on page 31.

To delete one character:

- 1 Press , ,  or  to position the cursor below the character immediately to the right of the character that you wish to delete.
- 2 Press  once.

To delete a sequence of characters:

- 1 Press , ,  or  to position the cursor below the character immediately to the right of the last character that you wish to delete.
- 2 Hold down  until all of the characters that you wish to delete are deleted.

To quit a function without changing your text:

- Press  to return to your text.

To answer "no":

- Press .

LINE OUT FUNCTION

With the **Line Out** function, you can easily remove an entire line of text.

To delete a line of text:

① Press , , or to position the cursor within the line of text that you wish to delete.

② Hold down and press once.

Each time is pressed while is held down, one line of text is deleted.

EXAMPLE

To delete "012-345-6789":



● Hold down and press

once.



CLEAR FUNCTION

When clearing the display before entering new text, the **Clear** function can be used to choose whether all of the text is erased and all format functions (**Font**, **Size**, **Width**, **Style**, **Underline**, **Frame**, **Tape margin**, **Alignment**, **Tab length**, **Mirror printing**, and **Length**) are returned to their default settings, or whether just the text is erased.

To delete all of the text and return all formats to their default settings:

- 1 Hold down **Code** and press **Clear Del**.
- 2 Press **Home** or **End** until **TEXT&FORMATS** is selected (flashing).
 To return to the text without erasing anything, press **Clear Del**.
- 3 Press **Left Arrow**.

EXAMPLE

To clear the text and formats:

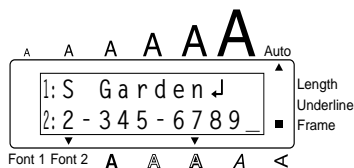

- 1 Hold down **Code** and press

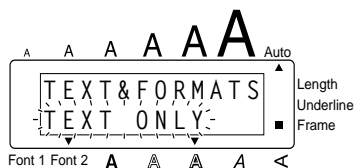

- 2 Press **Home** until **TEXT&FOR-**
MATS is flashing.

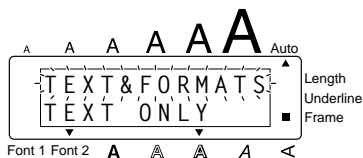

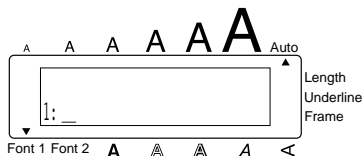

3 Press .



To delete just the text:

1 Hold down  and press .

2 Press  or  until **TEXT ONLY** is selected (flashing).

 To return to the text without erasing anything, press .

3 Press .

EXAMPLE

To clear just the text:

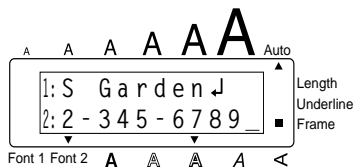

1 Hold down  and press

.

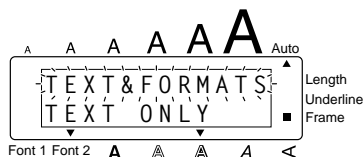

- 2 Press  until **TEXT ONLY** is flashing.



- 3 Press .

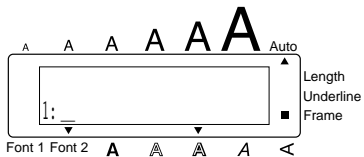

ACCENT FUNCTION

The **Accent** function can also be used to add accented characters to your text. Many of these characters can also be typed in using the **Symbol** function.

The accented characters are grouped according to the capital or small letter that they are combined with. The following accented characters are available:

Letters	Accented characters	Letters	Accented characters
a	à á â ã ä å æ	l	í î ï
A	À Á Â Ã Ä Å Æ	n	ñ
c	ç	N	Ñ
C	Ç	o	ó ô õ ö
e	è é ê ë ì	O	Ó Ô Õ Ö
E	È É Ê Ë Ì	u	ù ú û ü
i	í î ï	U	Ù Ú Û Ü

To type in an accented character:

① Hold down **Code** and press **Accent A**. The message "a - u / A - U?" appears on the display.

② Press the key of the letter in the desired accented character.

☞ *To type a capital letter, hold down **Caps Shift** (or hold down **Code** and press **Caps Shift** to turn on **Caps** mode) before pressing the letter key.*

③ Press **←** or **→** until the desired accented character flashes.

④ Press **↵**. The letter and the accent flash alternately in the text.

☞ *To type in a series of accented characters, hold down **Code** before pressing **↵**. Then, continue adding accented characters by selecting them as explained in steps ② and ③, and holding down **Code** while pressing **↵**. Press just **↵** after selecting the last character in the series.*

EXAMPLE

To add the accented character "É":

- 1 Hold down **Code** and press

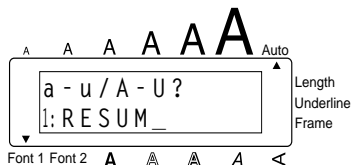

- 2 Hold down **Caps Shift** and press



- 3 Press **▶▶** until É flashes.



- 4 Press **↶**.



SYMBOL FUNCTION

In addition to the letters, symbols and numerals on the key tops, there are 53 additional marks available with the **Symbol** function.

The following symbols are available:

Group	Symbol
1	Ü Æ æ Ã ã Ě ě Ō ō • ° ™
2	+ × ÷ = § ² ³ ² ³ 4 []
3	↑ ↓ → ← ↵ ↶ ☉ ☺ ☎ 📁 📧 ☠
4	🌐 🍷 🔥 ♿ ⚡ 🎬 🌐 🌐 🔑 🌐 🍷 🧑
5	🧐 🍷 🎵 ❤️ ★

To type in a symbol:

- ① Hold down **Code** and press **Alt**^{Symbol}. A row of symbols appear in the display.
 - ② Press **Home** or **End** to display different rows of symbols and press **←** or **→** until the desired symbol flashes.
 - ③ Press **↵**. The symbol appears in the text.
- ☞ *To type in a series of symbols, hold down **Code** before pressing **↵**. Then, continue adding symbols by selecting them as explained in steps ② and ③, and holding down **Code** while pressing **↵**. Press just **↵** after selecting the last symbol in the series.*

EXAMPLE

To add the symbol "☠":

- 1 Hold down **Code** and press

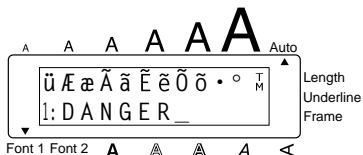

- 2 Press **Home** or **End** until the row containing "☠" appears, then press **←** or **→** until "☠" flashes.



- 3 Press **↵**.









AUTO FORMAT FUNCTION

With the **Auto Format** function, you can select from a variety of preset formats perfect for your specific need. This function automatically adjusts the label length, tape margins and horizontal alignment without changing the text or any other formats, allowing you to create labels faster and easier.

The following preset formats are available:

Auto Format setting	Label length setting	Tape margin setting	Horizontal alignment setting
DEFAULT	OFF	FULL	LEFT
3.5" FLOPPY	2.8" (7.0 cm)	NARROW	CENTER
5" FLOPPY	4.8" (12.2 cm)	NARROW	CENTER
VHS SPINE	5.5" (14.0 cm)	NARROW	CENTER
VHS	3.0" (7.7 cm)	NARROW	CENTER
VCR8mm CASE	3.6" (9.2 cm)	NARROW	CENTER
VCR8mm	2.9" (7.3 cm)	NARROW	CENTER
VHS-C SPINE	1.8" (4.5 cm)	NARROW	CENTER
VHS-C	2.3" (5.8 cm)	NARROW	CENTER
AUDIO	3.5" (8.9 cm)	NARROW	CENTER
DAT CASSETTE	2.2" (5.6 cm)	NARROW	CENTER
MINI DISK	2.0" (5.2 cm)	NARROW	CENTER
ORGANIZER L	3.2" (8.2 cm)	NARROW	CENTER
ORGANIZER S	2.6" (6.5 cm)	NARROW	CENTER
FILE LONG	7.2" (18.3 cm)	NARROW	CENTER
FILE SHORT	3.7" (9.4 cm)	NARROW	CENTER

To select a preset format:

- 1 Hold down  and press  once. The currently selected setting appears in the display.
 - 2 Press  or  to select the desired setting.
-  To return to default settings, press .



- ③ Press  to apply the selected setting.
 ➔ The **Length** indicator lights up if any setting other than **DEFAULT** is selected.

EXAMPLE

To select the **AUDIO** setting:

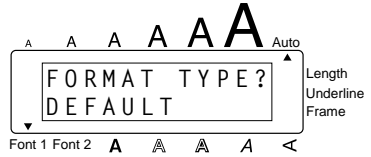
- ① Hold down  and press



- ② Press  or  until the **AUDIO** setting is displayed.







- ③ Press .

STAMP FUNCTION

The **Stamp** function allows you to quickly and easily create your own stamp stencil films for customized stamps. Select this function to automatically center the text and adjust the tape length and margins to a perfect format for the pre-inked stamp film holders. Since the stamp holder is reusable, just make a new stamp stencil film and replace the one in the holder.

To make a stamp:

- 1 Type in the text, and then insert a Medium (3/4" (18-mm)-wide) stamp film cassette.
- 2 Hold down  and press  once. The message "STAMP FORMAT?" appears in the display.
- 3 Press . The text is formatted for a stamp: centered within the preset message area with the tape length and margins automatically adjusted.
- 4 Press  to cut the text out of the stamp stencil film.
- 5 Push down on the tape cutter lever, remove the backing paper from the stamp stencil film and affix it to the ink pad of a stamp film holder.

EXAMPLE

To cut a stamp:

- 1 Enter the text and insert a stamp film cassette in the tape compartment.
- 2 Hold down  and press

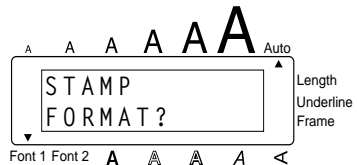

3 Press .

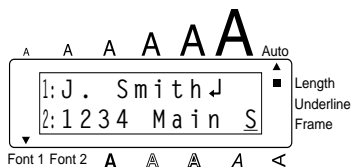

4 Press .



5 Push down on the tape cutter lever to cut the stamp stencil film.

To affix a stamp:

- 6 Remove the stamp frame from around the stamp film holder ink pad, one side at a time, then remove the protective seal covering the ink pad and the backing paper from the stamp stencil film.
- 7 With the glossy side of the stamp stencil film upward, align one of its ends with the slit on the side of the stamp film holder.

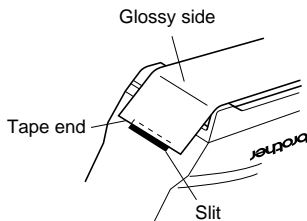

- 8 Hold the end of the stamp stencil film in place with your thumb, then pass the tape through the guides while pulling it tight.

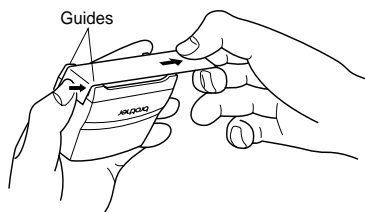

- 9 Fold the other end of the stamp stencil film over the other side of the stamp film holder and hold it in place with your finger.

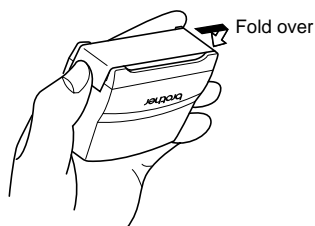

- 10 Fit the stamp frame over the stamp stencil film and push it into place.

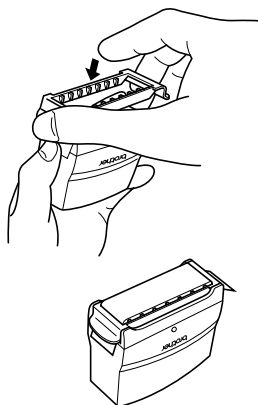

- 11 Insert the stamp film holder straight into its cap.

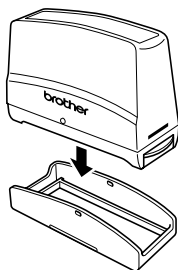

Be sure that the stamp is correctly covered in order to prevent ink spills.

SIZE & WIDTH FUNCTIONS

The character size can be adjusted using both the **Size** and **Width** functions. Since the character size that can be used depends on the width of the tape, the following table shows the character sizes that can be used with each tape width.

Tape widths	Sizes (in points)
1/4" (6 mm)	6, 9, 12
3/8" (9 mm)	6, 9, 12, 18
1/2" (12 mm)	6, 9, 12, 18, 24
3/4" (18 mm)	6, 9, 12, 18, 24, 36

The default size setting is **AUTO** and the default width setting is **OFF**. The currently selected size setting is always shown by the indicator above the display.

With the **AUTO** size setting, the machine compares your text with the width of the installed tape and automatically adjusts the characters to the largest possible size. However, six other point sizes are also available and each can be printed in wide characters.

Size setting (in points)	Width function OFF	Width function ON
6	ABC	ABC
9	ABC	ABC
12	ABC	ABC
18	ABC	ABC

Size setting (in points)	Width function OFF	Width function ON
24	ABC	ABC
36	ABC	ABC

To change the size setting:

- 1 While holding down **Code**, press **Size** $\frac{\text{@}}{2}$ once, and keep **Code** held down to display the current size setting.
- 2 While still holding down **Code**, continue pressing **Size** $\frac{\text{@}}{2}$ until the desired size setting is displayed and is shown by the size indicator.

 *The current character size setting is also shown by the size indicator above the display.*
- 3 Release **Code** to apply the selected size setting to the entire text.

 *With the **AUTO** setting selected and 3/4" (18-mm)-wide tape installed, text consisting of just one line of only capital letters will be printed with a character size of 48 points.*

EXAMPLE

To select the 24 point size setting:

- 1 While holding down **Code**, press **Size @ 2** once, and keep **Code** held down.



- 2 While still holding down **Code**, continue pressing **Size @ 2** until 24 is displayed.



- 3 Release **Code**.

To turn on or off the Width function:

- 1 While holding down **Code**, press **Width # 3** once, and keep **Code** held down to display the current width setting.
- 2 While still holding down **Code**, continue pressing **Width # 3** until the desired width setting is displayed.
- 3 Release **Code** to apply the selected width setting to the entire text.

EXAMPLE

To turn on the Width function:

- 1 While holding down **Code** ,
press **Width #3** once, and keep
Code held down.



- 2 While still holding down **Code** ,
continue pressing **Width #3** until **ON** is
displayed.



- 3 Release **Code** .

STYLE FUNCTION

You can choose from nine different character styles to apply to your text.

☞ *Characters printed using the smaller sizes may be difficult to read if certain style settings (e.g., I+SHADOW) are selected.*

The following style settings are available:

NORMAL	I+BOLD (italic & bold)
BOLD	I+OUTLINE (italic & outline)
OUTLINE	I+SHADOW (italic & shadow)
SHADOW	VERTICAL
ITALIC	

The default style setting is **NORMAL**. The style indicator at the bottom right of the display shows the current style setting when any setting other than **NORMAL** is selected.

Refer to *Reference* at the end of this section for samples of the available settings.

To change the style setting:

- 1 While holding down **Code**, press **Style** $\frac{S}{4}$ once, and keep **Code** held down to display the current style setting.
- 2 While still holding down **Code**, continue pressing **Style** $\frac{S}{4}$ until the desired style setting is displayed.
☞ *The current style setting is shown by the style indicator at the bottom right of the display.*
- 3 Release **Code** to apply the selected style setting to the entire text.

EXAMPLE

To select the I+SHADOW style setting:

- 1 While holding down **Code**, press **Style** $\frac{S}{4}$ once, and keep **Code** held down.



2 While still holding down **Code**, continue pressing **S** until **I+SHADOW** is displayed.

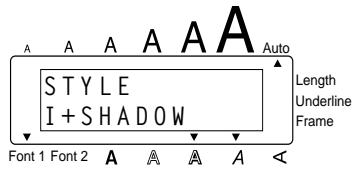

3 Release **Code**.

REFERENCE

Font setting	Style setting		
	NORMAL	BOLD	OUTLINE
HELSINKI	abc	abc	abc
BRUSSELS	abc	abc	abc

Font setting	Style setting		
	SHADOW	ITALIC	I+BOLD
HELSINKI	abc	<i>abc</i>	<i>abc</i>
BRUSSELS	abc	<i>abc</i>	<i>abc</i>

Font setting	Style setting		
	I+OUTLINE	I+SHADOW	VERTICAL
HELSINKI	<i>abc</i>	<i>abc</i>	Ɱ Ɱ Ɱ
BRUSSELS	<i>abc</i>	<i>abc</i>	Ɱ Ɱ Ɱ

UNDERLINE FUNCTION

You can emphasize your text by underlining it.

The default underline setting is OFF. When the **Underline** function is set to **ON**, the **Underline** indicator on the right side of the display lights up.

ON ABC

To turn on or off the Underline function:

- 1 While holding down **Code**, press **Underline % 5** once, and keep **Code** held down to display the current underline setting.
- 2 While still holding down **Code**, continue pressing **Underline % 5** until the desired underline setting is displayed.
 *The **Underline** indicator lights up when the **ON** setting is selected.*
- 3 Release **Code** to apply the selected underline setting to the entire text.

EXAMPLE

To select the ON underline setting:

- 1 While holding down **Code**, press **Underline % 5** once, and keep **Code** held down.
- 2 While still holding down **Code**, continue pressing **Underline % 5** until **ON** is displayed.
- 3 Release **Code**.

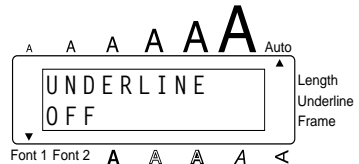

FONT FUNCTION

With the **Font** function, you can choose one of two fonts for your text.

The following font settings are available:

HELSINKI and BRUSSELS

The default font setting is **HELSINKI**. The currently selected font setting is always shown by the **Font** indicators below the display.

Refer to *Reference* at the end of this section for samples of the available settings.

To change the font setting:

- 1 While holding down **Code**, press **Font** once, and keep **Code** held down to display the current font setting.
- 2 While still holding down **Code**, continue pressing **Font** until the desired font setting is displayed and is shown by the font indicator.
 *The current font setting is also shown by the font indicator at the bottom left of the display.*
- 3 Release **Code** to apply the selected font setting to the entire text.

EXAMPLE

To select the BRUSSELS font setting:

- 1 While holding down **Code**, press **Font** once, and keep **Code** held down.
- 2 While still holding down **Code**, continue pressing **Font** until **BRUSSELS** is displayed.
- 3 Release **Code**.



REFERENCE

Font setting	Font sample	Display indicator
HELSINKI	abc	Font 1
BRUSSELS	abc	Font 2

FRAME FUNCTION

With the **Frame** function, you can choose from various frames and highlights to design a more decorative or emphasized label.

The following Frame settings are available:

OFF, ROUND, CANDY, POINTING, NAMEPLATE, DOT

The default frame setting is **OFF**; however, other settings are also available. When any setting other than **OFF** is selected, the **Frame** indicator on the right side of the display lights up.

Refer to *Reference* at the end of this section for samples of the available settings.

To change the frame setting:

- 1 While holding down **Code**, press **Frame** $\frac{c}{6}$ once, and keep **Code** held down to display the current frame setting.
- 2 While still holding down **Code**, continue pressing **Frame** $\frac{c}{6}$ until the desired frame setting is displayed.
 *The **Frame** indicator lights up when any setting other than **OFF** is selected.*
- 3 Release **Code** to apply the selected frame setting to the entire text.



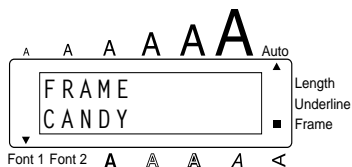

EXAMPLE

To select the CANDY frame setting:

- 1 While holding down **Code**, press **Frame** $\frac{c}{6}$ once, and keep **Code** held down.
- 2 While still holding down **Code**, continue pressing **Frame** $\frac{c}{6}$ until **CANDY** is displayed.
- 3 Release **Code**.



REFERENCE

Frame setting	Frame sample	Frame setting	Frame sample
OFF	ABC	POINT- ING	
ROUND		NAME- PLATE	
CANDY		DOT	

TAPE MARGIN FUNCTION

The **Tape margin** function allows you to adjust the size of the margins on the left and right sides of your text.

The default tape margin setting is **FULL**; however, three other settings are also available.

FULL
(1" (25 mm
margins))



NONE
(no margins)

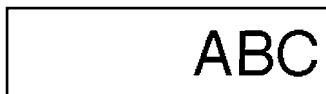



NARROW
(1/6" (4 mm
margins))









HALF
(1/2" (12 mm
margins))



 After printing a label using the **NONE** tape margin setting, hold down  and press  once to feed the tape before pushing down on the tape cutter lever to cut it. Otherwise some of the printed characters may be cut off.

After printing using the **NARROW** and **HALF** tape margin settings, push down on the tape cutter lever to cut off the label, then use scissors to cut along the printed dots (·) to center the text within the label.

To change the tape margin setting:

- 1 While holding down , press  once, and keep  held down to display the current tape margin setting.
- 2 While still holding down , continue pressing  until the desired tape margin setting is displayed.
- 3 Release  to apply the selected tape margin setting to the entire text.

EXAMPLE

To select the HALF tape margin setting:

- 1 While holding down **Code**, press **E** once, and keep **Code** held down.



- 2 While still holding down **Code**, continue pressing **E** until **HALF** is displayed.



- 3 Release **Code**.

HORIZONTAL ALIGNMENT FUNCTION

You can choose to align the text in one of three ways. In addition, if the **Length** function was used to set the length of the label, the text will align within the label according to the selected horizontal alignment setting.

Three settings exist, as follows. The default setting is **LEFT**.

LEFT	AB CDE FG	CENTER	AB CDE FG	RIGHT	AB CDE FG
------	-----------------	--------	-----------------	-------	-----------------

To change the horizontal alignment setting:

- 1 While holding down **Code**, press **Align R** once, and keep **Code** held down to display the current horizontal alignment setting.
- 2 While still holding down **Code**, continue pressing **Align R** until the desired horizontal alignment setting is displayed.
- 3 Release **Code** to apply the selected horizontal alignment setting to the entire text.

EXAMPLE

To select the **RIGHT** horizontal alignment setting:

- 1 While holding down **Code**, press **Align R** once, and keep **Code** held down.

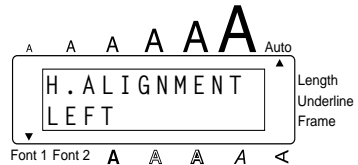

- 2 While still holding down **Code**, continue pressing **Align R** until **RIGHT** is displayed.



- 3 Release **Code**.

MIRROR PRINTING FUNCTION

With this function, you can print your text so that the characters can be read from the tape side of the tape. If mirror-printed labels are attached to glass or some other clear material, they can be read correctly from the opposite side.

☞ When using the **Mirror printing** function, the text should be printed on clear tape. The default mirror printing setting is **OFF**.

ON

ABC

To turn on or off the mirror printing setting:

- 1 While holding down **Code**, press **Print** once, and keep **Code** held down to display the current mirror printing setting.
- 2 While still holding down **Code**, continue pressing **Print** until the desired mirror printing setting is displayed.
- 3 Release **Code** to apply the selected mirror printing setting to the entire text.

EXAMPLE

To select the **ON** mirror printing setting:

- 1 While holding down **Code**, press **Print** once, and keep **Code** held down.



- 2 While still holding down **Code**, continue pressing **Print** until **ON** is displayed.



- 3 Release **Code**.

LENGTH FUNCTION

Although the length of the printed label automatically adjusts to fit the length of the entered text, there may be times when you will want to make a label with a specific length. The **Length** function allows you to set the label length between 1.6" and 11.8" (4.0 cm and 30.0 cm).

The default length setting is **OFF**. When the **Length** function is set to **ON**, the **Length** indicator on the right side of the display lights up.

☞ *Turning off the machine and turning it on again changes the length setting back to **OFF**.*

To turn on or off the Length function:

① While holding down **Code**, press **Length** **T** once, and keep **Code** held down to display the current length of the label (the text and both margins) briefly, then display the current label length setting (**ON** or **OFF**).

② While still holding down **Code**, continue pressing **Length** **T** until the desired label length setting is displayed.

☞ *The **Length** indicator lights up when **ON** is selected.*

③ Release **Code**. If **ON** was selected, the current label length setting is displayed.

④ Press **Home** **▲** or **End** **▼** to select the desired length or use the number keys to enter the length.

☞ *To change the units (inches or centimeters) used to display the label length, press **M_n** until the desired units are displayed.*

*To change the length in 1" (1.0-cm)-steps, hold down either **Home** **▲** or **End** **▼**, and then release the key when the desired setting is displayed.*

⑤ Press **←**.

EXAMPLE

To select a label length of 5":

- 1 While holding down **Code**, press **T** once, and keep **Code** held down.

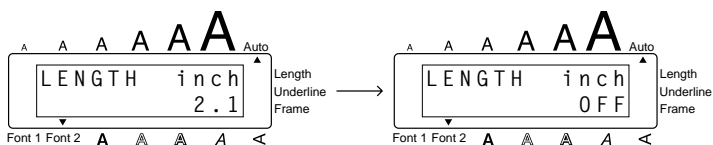

- 2 While still holding down **Code**, continue pressing **T** until **ON** is displayed.

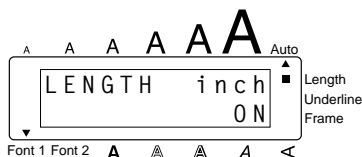

- 3 Release **Code**.

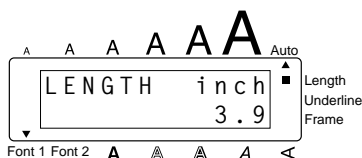

- 4 Press **Home** until **5.0** is displayed.

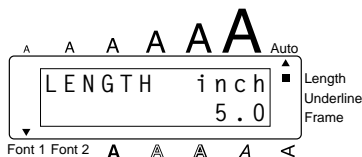



- 5 Press **←**.

PRINT KEY & FEED FUNCTION

After you have entered your text and chosen the desired format settings, you are ready to print.

To print a label:

- Press  once. The message "COPIES" followed by the number of the label being printed is displayed.

 If **NONE** tape setting is selected and the tape is immediately, some printed characters will be cut off. To feed the tape after printing, hold down  and  once.

To feed the tape:

- Hold down  and press  once. 1" (25 mm) of tape is fed out.

To cut the tape:

- Push down on the tape cutter lever.



 In order to prevent damaging the tape, do not try to cut it while printing or feeding. Pushing down on the tape cutter lever too far may break it.

EXAMPLE

To make a label using the NONE tape margin setting:

- 1 Press  once.



- 2 Hold down  and press  once.
- 3 Push down on the tape cutter lever.

NUMBERING FUNCTION

This function can be used to print many copies of the same text while increasing a certain number in the text by 1 after each label is printed.

To use the Numbering function:

- 1 Press \leftarrow , \rightarrow , \uparrow (Home) or \downarrow (End) to position the cursor below the number that you wish to increase.
- 2 Hold down (Code) and press $\text{O}_0^{\text{Number}}$. The message "NUMBER UNTIL 1-9?" appears in the display.
- 3 Press the number key (i_1^{Font} to $\text{i}_9^{\text{M.Del}}$) of the last number that is to be printed.

\rightarrow To cancel the **Numbering**, hold down (Code) and press $\text{O}_0^{\text{Number}}$ (or press just $\text{Del}^{\text{Clear}}$).

- 4 Press $\text{Print}^{\text{Mirror}}$ (or \leftarrow) to begin printing the labels. The number of each copy is displayed while it is being printed.

\rightarrow After printing using the **NONE** tape margin setting, hold down (Code) and press $\text{Space}^{\text{Feed}}$ once to feed the tape before cutting it, otherwise some of the printed characters may be cut off.

- 5 Press down on the tape cutter lever to cut the tape, and then use scissors to cut along the printed dots to separate the labels.

EXAMPLE

To print three labels with numbers 1, 2 and 3:

- 1 Position the cursor below "1".



- 2 Hold down **Code** and press

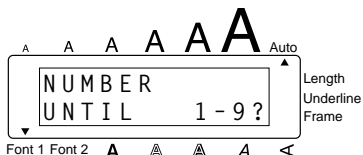

- 3 Press **Width** (# 3).

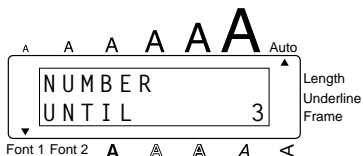

- 4 Press **Mirror** (Print) (or **Reverse**).



- 5 Press in the tape cutter lever to cut the tape, then use scissors to cut along the cutting guide to separate the labels.



REPEAT PRINTING FUNCTION

This function allows you to print up to 9 copies of the same text.

To use the Repeat printing function:

① Hold down **Code** and press **Repeat** (**1** **i**). The message "COPIES UNTIL 1-9?" appears in the display.

② Press the number key (**Font** **1** **i** to **M.Del** **9**) of the number of labels that you want.

☞ To cancel the **Repeat printing**, hold down **Code** and press **Repeat** (**1** **i**) (or press just **Clear** **Del**).

③ Press **Mirror** **Print** (or **←**) to begin printing the labels. The number of each copy is displayed while it is being printed.

☞ If **NONE** tape setting is selected and the tape is immediately, some printed characters will be cut off. To feed the tape after printing, hold down **Code** and **Feed** **Space** once.

④ Press down on the tape cutter lever to cut the tape, and then use scissors to cut along the printed dots to separate the labels.

EXAMPLE

To print three copies of a label:

① Hold down **Code** and press

Repeat
1 **i**



2 Press .



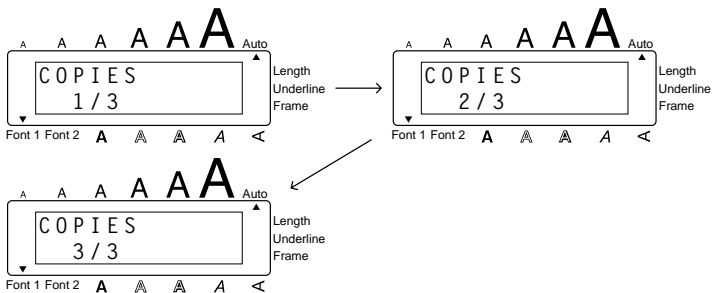

3 Press  (or ).

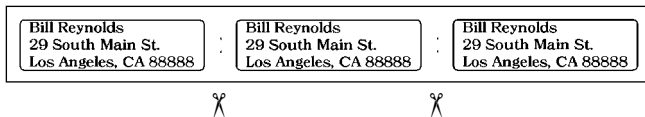

4 Press down on the tape cutter lever to cut the tape, and then use scissors to cut along the cutting guide to separate the labels.



MEMORY FUNCTIONS

You can use the memory to store your most frequently used text files. The text remains in the memory, even after all characters are removed from the display using the **Clear** function (holding down  and pressing ).



When each file is stored, it is given a number to make recalling it easier. Up to 9 text files or about 300 characters can be stored in the memory. Each stored text file can have a maximum of 99 characters.

Since a copy of the stored text file is recalled when the **Recall** function is used, the text can be edited or printed without changing the originally stored file. When a file is no longer needed or more space is necessary, the **Memory delete** function can be used to delete it.



 *When inserting new batteries, be sure to insert the new ones within five minutes of removing the old ones, otherwise any text files stored in the memory will be lost (unless the machine is plugged into an electrical outlet with the AC adaptor).*

STORING TEXT



To store a text file:

① Hold down  and press . The message "STORE SELECT 1-9?" appears on the display.

 *If 300 characters have already been stored, the error message "MEMORY FULL!" appears in the display. If this occurs, an existing text file must be deleted before the new one can be stored.*

② Press the key ( to ) of the file number where you wish to store the text. The text is stored under the selected file number and the text previously shown in the display reappears.

 *If a file is already stored under the selected file number, the message "OVERWRITE?" appears in the display and you must decide whether or not to overwrite it (delete it from the memory and store the new one).*

To quit the **Store** function without storing the text, hold down  and press  (or press just .

To overwrite the stored file with the new one:



- Press  to delete the previously stored file and store the new one under the selected number.



 To go back and choose another file number without overwriting the text file,

press , and then press the key of a different file number.



RECALLING TEXT

To recall a text file:



- 1 Hold down  and press . The message "RECALL SELECT 1-9?" appears on the display.

- 2 Press the key ( to ) of the file number containing the text that you wish to recall. The text stored under the selected file number is shown.

 To see other parts of the selected text file, press  or .

To display the text stored under other file numbers, press  or , or the key of a different file number.



To quit the **Recall** function without recalling text, hold down  and

press  (or press just ).

- 3 Press . Any text previously entered in the display is erased and the text stored under the selected file number is recalled into the display.

DELETING A FILE

To delete a text file:

- 1 Hold down  and press . The message "CLEAR SELECT 1-9?" appears on the display.

- 2 Press the key ($\overset{\text{Font}}{\underset{1}{\text{F}}}$ to $\overset{\text{M.Del}}{\underset{9}{\text{M}}}$) of the file number containing the text that you wish to delete. The text stored under the selected file number is shown.

☞ To see other parts of the selected text file, press \leftarrow or \rightarrow .

To display the text stored under other file numbers, press $\overset{\text{Home}}{\uparrow}$ or \downarrow End, or the key of a different file number.

To cancel the **Memory delete** function without deleting the text file, hold down Code and press $\overset{\text{M.Del}}{\underset{9}{\text{M}}}$ (or press just $\overset{\text{Clear}}{\text{Del}}$).

- 3 Press \leftarrow to delete the text file that was selected.

EXAMPLE

To store text under file number 4:

- 1 Hold down Code and press

$\overset{\text{Store}}{\underset{7}{\text{S}}}$.

A A A A A A Auto
STORE
SELECT 1-9?
Length Underline Frame
Font 1 Font 2 A A A A <

- 2 Press $\overset{\text{Style}}{\underset{4}{\text{S}}}$.

A A A A A A Auto
4: John Smith
Length Underline Frame
Font 1 Font 2 A A A A <

To recall the text from file number 4:

- 1 Hold down Code and press

$\overset{\text{Recall}}{\underset{8}{\text{R}}}$.

A A A A A A Auto
RECALL
SELECT 1-9?
Length Underline Frame
Font 1 Font 2 A A A A <

2 Press .

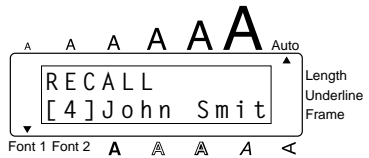

3 Press .



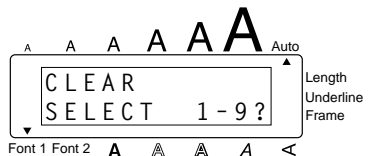

To delete the text stored under file number 4:

1 Hold down  and press



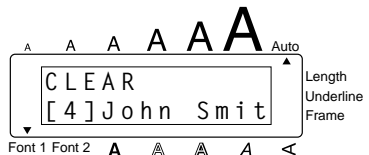

2 Press .





3 Press .











TROUBLESHOOTING

Problem	Remedy
1. The display stays blank after you have turned on the machine.	<ul style="list-style-type: none"> • Check that the AC adaptor is connected correctly. • If you are using alkaline batteries, check that they are correctly inserted. • If the batteries are low, replace them with new ones.
2. The machine does not print or the printed characters are blurred.	<ul style="list-style-type: none"> • Check that the tape cassette has been inserted properly. • If the tape cassette is empty, replace it with a new one. • Make sure that the tape compartment cover has been closed.
3. The text files that you stored in the memory are no longer there.	<ul style="list-style-type: none"> • If the batteries are low, replace them with new ones.
4. The printed characters are not formed properly.	<ul style="list-style-type: none"> • If you are using alkaline batteries, they may be low. Try using the AC adaptor or replace the batteries with new ones.
5. A blank horizontal line appears through the printed label.	<ul style="list-style-type: none"> • Clean the print head as explained on page 9.
6. Striped tape appears.	<ul style="list-style-type: none"> • You have reached the end of the tape. Replace the tape cassette with a new one.
7. The machine has "locked up" (i.e., nothing happens when a key is pressed).	<ul style="list-style-type: none"> • Turn off the machine, and then while holding down  and , turn the machine back on. The text and formats in the display and all text files stored in the memory are erased.

ERROR MESSAGE LIST

Error Message	Cause	Remedy
3 LINE LIMIT!	<ul style="list-style-type: none"> This message appears if three lines already exist when you press . 	<ul style="list-style-type: none"> Limit the number of lines to three.
BATTERIES WEAK!	<ul style="list-style-type: none"> This message appears when the installed alkaline batteries become weak. 	<ul style="list-style-type: none"> Replace the batteries or use the AC adaptor.
BUFFER EMPTY!	<ul style="list-style-type: none"> This message appears if you hold down  and press , but no text has been entered in the display. This message appears if you try to print, but no text has been entered. This message appears if you try to store a text file in the memory, but no text has been entered in the display. 	<ul style="list-style-type: none"> Enter some text before starting the function. Enter text before printing. Enter text before storing.
BUFFER FULL!	<ul style="list-style-type: none"> This message appears if you try to enter a character, symbol, bar code, return or space after 99 characters have already been entered. 	<ul style="list-style-type: none"> Delete some existing text so that more text can be entered.

Error Message	Cause	Remedy
CAN'T HERE!	<ul style="list-style-type: none"> This message appears if the cursor is at the end of the text when you hold down  and press . 	<ul style="list-style-type: none"> Move the cursor below a number before holding down  and pressing .
CHANGE ADAPTOR	<ul style="list-style-type: none"> This message appears if a high-voltage adaptor is being used. 	<ul style="list-style-type: none"> Remove the high-voltage adaptor and connect the adaptor designed exclusively for this machine.
CUTTER ERROR!	<ul style="list-style-type: none"> This message appears if the tape cutter lever is pressed down while a label is being printed. 	<ul style="list-style-type: none"> Release the tape cutter lever.
INVAL. CHRS!	<ul style="list-style-type: none"> This message appears if the cursor is not below a number when you hold down  and press . 	<ul style="list-style-type: none"> Move the cursor below a number before holding down  and press .
LENGTH LIMIT!	<ul style="list-style-type: none"> This message appears if the text is longer than 1 meter when you try to print. This message appears if the Length function is used to set a label length that is less than 1.6" (4.0 cm) or more than 11.8" (30.0 cm). This message appears if the Tab Length function is used to set a tab length that is more than 11.8" (30.0 cm). 	<ul style="list-style-type: none"> Shorten the text to less than 1 meter before trying to print. Set the label length between 1.6" (4.0 cm) and 11.8" (30.0 cm). Set the tab length so that it is less than 11.8" (30.0 cm).

Error Message	Cause	Remedy
LINE LIMIT!	<ul style="list-style-type: none"> This message appears if the number of lines in the text is greater than the maximum number of lines possible for the installed tape. 	<ul style="list-style-type: none"> Reduce the number of lines or install a tape of greater width.
MEMORY FULL!	<ul style="list-style-type: none"> This message appears if you try to store a text file after 300 characters have already been stored in the memory. 	<ul style="list-style-type: none"> Delete an unwanted file to make room for the new one.
NO FILES!	<ul style="list-style-type: none"> This message appears if you try to recall or delete a text file from the memory when none are stored. 	<ul style="list-style-type: none"> Store a text file first.
NUMBER TOO SMALL!	<ul style="list-style-type: none"> This message appears if the number that is set to be printed using the Numbering function is less than the number above the cursor. 	<ul style="list-style-type: none"> Press the key of a number that is greater than the number in the text.
ROM PROBLEM!	<ul style="list-style-type: none"> This message appears if there is a problem with the machine's read only memory. 	<ul style="list-style-type: none"> Contact your service representative.
REPLACE BATTERIES!	<ul style="list-style-type: none"> This message appears if the installed alkaline batteries are about to run out. 	<ul style="list-style-type: none"> Replace the batteries or use the AC adaptor.
SYSTEM ERROR!	<ul style="list-style-type: none"> This message appears if there is a problem with the machine's software. 	<ul style="list-style-type: none"> Contact your service representative.

Error Message	Cause	Remedy
NO TAPE!	<ul style="list-style-type: none"> This message appears if you try to print a label or feed the tape when no tape cassette is installed. 	<ul style="list-style-type: none"> Install a tape cassette and try again.
TAB LIMIT!	<ul style="list-style-type: none"> This message appears if 50 tabs have already been added to the text when you press . 	<ul style="list-style-type: none"> Limit the number of tabs in the text to 50.
TEXT TOO HIGH!	<ul style="list-style-type: none"> This message appears if the size of the text is larger than the width of the installed tape. 	<ul style="list-style-type: none"> Reduce the size of the characters or install a wider tape.
TEXT TOO LONG!	<ul style="list-style-type: none"> This message appears if the length of the text is longer than the label length that has been set using the Length function. 	<ul style="list-style-type: none"> Delete some of the text, reduce the character width or increase the set label length.

SPECIFICATIONS

HARDWARE

- Input Device:** Keyboard - 51 keys
- LCD:** 7 × 5 dots
12 characters × 2 lines
17 indicators
- Print Tape:** Pressure-sensitive, Adhesive-based
26' 3" (8 m) long
Four widths available:
 1/4" (6 mm)
 3/8" (9 mm)
 1/2" (12 mm)
 3/4" (18 mm)
- Power Supply:** Six AA alkaline batteries (AM3, LR6) or optional AC adaptor
Auto power-off if no key is pressed for 5 minutes
- Print Head:** 128 dot / 180 dpi
- Dimensions:** 7" (W) × 8 1/16" (D) × 2 23/63" (H)
(178 × 205 × 60 mm)
- Weight:** 1.5 lbs (700 g) (without a tape cassette and batteries installed)

SOFTWARE

- Buffer Size:** Maximum 99 characters
Maximum three lines
- Memory Size:** 300 characters
- Character Size:** Six sizes (6, 9, 12, 18, 24 and 36 points) + 48 point (Capital letters only)
All are available in normal and wide
- Print Styles:** Normal, Outline, Bold, Shadow
(each can be combined with Italic), and Vertical

ACCESSORIES

● Supplies

Obtain tape cassettes from your nearest authorized dealer.

Use only Brother TZ tapes with this machine. Brother cannot be held responsible for trouble caused by the use of unauthorized supplies. Do not use tapes that do not have the  mark.

Stock No.	Description	QTY/ PACKAGE	PRICE
3/4" (18mm)-wide laminated tapes			
TZ-141	Black characters on clear tape	1	\$20.99
TZ-145	White characters on clear tape	1	\$20.99
TZ-241	Black characters on white tape	1	\$20.99
TZ-242	Red characters on white tape	1	\$20.99
TZ-243	Blue characters on white tape	1	\$20.99
TZ-344	Gold characters on black tape	1	\$24.99
TZ-345	White characters on black tape	1	\$23.99
TZ-441	Black characters on red tape	1	\$20.99
TZ-541	Black characters on blue tape	1	\$20.99
TZ-545	White characters on blue tape	1	\$23.99
TZ-641	Black characters on yellow tape	1	\$20.99
TZ-741	Black characters on green tape	1	\$20.99
TZ-B41	Black characters on fluorescent orange tape	1	\$24.99
TZ-M41	Black characters on clear (matte) tape	1	\$20.99
TZ-WB41	Black characters on Bugs Bunny tape	1	\$23.99
TZ-WT41	Black characters on Taz tape	1	\$23.99
TZ-WS41	Black characters on Tweety & Sylvester tape	1	\$23.99
1/2" (12mm)-wide laminated tapes			
TZ-131	Black characters on clear tape	1	\$16.99
TZ-231	Black characters on white tape	1	\$17.99
TZ-232	Red characters on white tape	1	\$17.99
TZ-335	White characters on black tape	1	\$20.99
3/8" (9mm)-wide laminated tapes			
TZ-121	Black characters on clear tape	1	\$14.99
TZ-221	Black characters on white tape	1	\$16.99
TZ-325	White characters on black tape	1	\$18.99
TZ-421	Black characters on red tape	1	\$16.99

Stock No.	Description	QTY/ PACKAGE	PRICE
1/4" (6mm)-wide laminated tapes			
TZ-111	Black characters on clear tape	1	\$12.99
TZ-211	Black characters on white tape	1	\$14.99
TZ-315	White characters on black tape	1	\$17.99

Special tapes

Stock No.	Description	QTY/ PACKAGE	PRICE
TZ-SE4	Black characters on 3/4" (18 mm) security tape	1	\$29.99
TZ-FA3	Blue characters on 1/2" (12 mm) fabric tape	1	\$24.99

Stamp kit

Stock No.	Description	QTY/ PACKAGE	PRICE
SK-MB	Stamp-making kit for Medium stamp with black ink	1	\$37.99
SH-MB	Additional stamper for Medium stamp with black ink	1	\$24.99

Options

Stock No.	Description	QTY/ PACKAGE	PRICE
AD-60	AC Adapter	1	\$24.99

GUIA DE INSTRUCCIONES

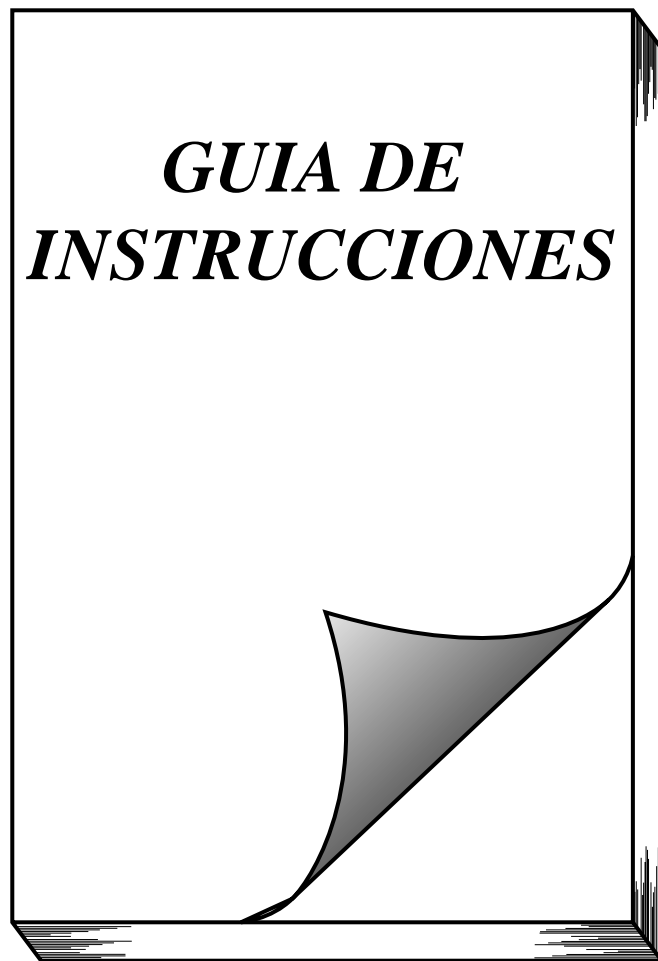

INTRODUCCIÓN

Gracias por adquirir una P-Touch 1800.

Su nueva P-Touch le permitirá diseñar y crear etiquetas y membretes para cualquier tipo de aplicación. Su versatilidad le permitirá crear etiquetas personales seleccionando distintos diseños de marcos y muchos tamaños y estilos de caracteres. Además, los cuatro diferentes anchos de cinta (1/4" (6 mm), 3/8" (9 mm), 1/2" (12 mm), 3/4" (18 mm) y 1" (24 mm)) y la variedad de los colores de la cintas le hará posible imprimir etiquetas personales, útiles para relleno con código de colores. Con la función de membretes, podrá hacer membretes con facilidad y rapidez para soportes de membretes entintados reutilizables.

Ya no hay por qué preocuparse por tareas urgentes que requieren impresión profesional. En la oficina, la fábrica, el laboratorio, o en casa, la calidad y el rendimiento de la P-Touch 330/350 la convierten en una máquina muy práctica.

Para terminar, puesto que esta guía del usuario le será de gran utilidad, le aconsejamos que la guarde en un lugar accesible para poder consultar en cualquier momento.

(Los modelos PT-1800 y PT-1810 disponen de las mismas funciones. Sin embargo, solamente el modelo PT-1810 dispone de estuche de transporte.)

AVISO DE LA FCC

Este equipo ha sido probado y cumple con los límites de un aparato digital de la Clase B, siguiendo el apartado 15 de las normas de la FCC. Estos límites están pensados para proporcionar una protección razonable contra interferencias nocivas dentro de una instalación residencial. Este equipo podría interferir de forma nociva con comunicaciones por radio si no se instala y utiliza siguiendo las instrucciones. No obstante, no existe ninguna garantía de que no vayan a suceder interferencias en una instalación concreta. Si este equipo causara interferencias nocivas con la recepción de radio o televisión, lo cual puede determinarse poniendo el equipo en ON u OFF, se recomienda que el usuario intente corregir dichas interferencias mediante una de las siguientes medidas:

- Reoriente o ponga la antena receptora en otro lugar.
- Aumente la separación entre el equipo y el receptor.
- Conecte el equipo en una toma de un circuito diferente de la que esté conectada el receptor.
- Consulte a su distribuidor o a un técnico experimentado de radio/televisión.

A continuación se indican los números de patente y de publicación de patente relacionados con este producto:

USP4839742	USP4983058	USP5120147
USP4927278	USP5009530	
USP4976558	USP5069557	

ÍNDICE

PRECAUCIONES GENERALES	1
PILAS	2
ADAPTADOR DE CA OPCIONAL	3
CASETES DE CINTA	4
CABEZAL DE IMPRESIÓN Y RODILLOS	5
COLOCACIÓN DE ETIQUETAS	6
TECLA DEL CURSOR	7
TECLAS CODE, ALT Y SHIFT	9
TECLA DE RETORNO	10
TABULACIÓN	11
TECLA DE BORRADO (DEL)	13
FUNCIÓN DE BORRADO DE LÍNEA (LINE OUT)	14
FUNCIÓN DE REPOSICIÓN (CLEAR)	14
FUNCIÓN DE ACENTOS	15
FUNCIÓN DE SÍMBOLOS	16
FUNCIÓN DE FORMATO AUTOMÁTICO	17
FUNCIÓN DE MEMBRETE	19
FUNCIONES DE TAMAÑO Y DE ANCHURA	20
FUNCIÓN DE ESTILO	21
FUNCIÓN DE SUBRAYADO	22
FUNCIÓN DEL TIPO DE CARACTERES	23
FUNCIÓN DE MARCOS	24
FUNCIÓN DE CINTA	25
FUNCIÓN DE LA ALINEACIÓN HORIZONTAL	26
FUNCIÓN DE IMPRESIÓN DE ESPEJO	27
LENGTH FUNCIÓN	28
FUNCIÓN DE LA TECLA DE IMPRESIÓN Y AVANCE	29
FUNCIÓN DE NUMERACIÓN	30
FUNCIÓN DE IMPRESIÓN REPETIDA	31
FUNCIONES DE LA MEMORIA	32
SOLUCIÓN DE PROBLEMAS	35
LISTA DE MENSAJES DE ERROR	36
ESPECIFICACIONES	40
ACCESORIOS	41

PRECAUCIONES GENERALES

- Con esta máquina emplee sólo cintas TZ Brother. No emplee cintas que no tengan la marca .
- No tire de la cinta que se alimenta desde la P-Touch. Podría dañar el casete de cinta.
- No utilice la máquina en lugares polvorientos, y manténgala alejada de la luz solar directa y la lluvia.
- No exponga la máquina a altas temperaturas ni humedad. No la deje nunca en el tablero de instrumentos ni en la parte trasera de su automóvil.
- No deje nada que sea de goma o vinilo encima de la máquina durante períodos prolongados. Podría producir manchas.
- No limpie la máquina con alcohol ni con otros solventes orgánicos. Emplee solamente un paño suave y seco.
- No ponga ningún objeto encima ni dentro de la máquina.
- Para evitar daños, no toque el borde de la cuchilla.
- Cuando inserte pilas nuevas, asegúrese de hacerlo antes de que transcurran cinco minutos desde el momento en que extrae las pilas gastadas, porque de lo contrario se perderían todos los archivos de texto (a menos que la máquina esté enchufada a una toma de CA con el adaptador de CA).
- Emplee sólo el adaptador de CA (modelo AD-60) exclusivamente diseñado para esta máquina. El empleo de otro cancelaría la garantía.
- No intente desmontar el adaptador de CA.
- Cuando la máquina no se utilice durante períodos prolongados de tiempo y no sea necesario conservar los archivos de texto en la memoria, desenchufe el adaptador de CA, y saque las pilas para evitar fugas de las mismas que podrían ser causa de daños en la máquina.
- Cuando el adaptador de CA esté enchufado en la máquina, si se desenchufa el adaptador de la toma de CA se correrá el riesgo de perder todos los archivos de texto de la memoria, aunque las pilas estén insertadas.
- **En esta máquina, emplee seis pilas alcalinas del tamaño AA.**

PILAS

Esta máquina ligera y portátil puede utilizarse en cualquier lugar instalando seis (6) **pilas alcalinas AA**. Cuando cambie las pilas, reemplace siempre las seis pilas al mismo tiempo.

Para cambiar las pilas:

- 1 Extraiga la cubierta del compartimiento de las pilas de la parte posterior de la máquina.
- 2 Si ya hay pilas instaladas, extráigalas.
- 3 Inserte seis pilas alcalinas AA nuevas, asegurándose de que quedan orientadas en la dirección correcta.
- 4 Coloque la cubierta del compartimiento de las pilas.

☞ *Asegúrese de insertar las pilas nuevas antes de que transcurran cinco minutos desde que se extraen las pilas gastadas, porque de lo contrario el texto que se visualiza en la pantalla y los archivos de texto almacenados en la memoria se perderían (a menos que la máquina esté enchufada a una toma de CA con el adaptador de CA).*

Extraiga las pilas y desconecte el adaptador de CA si no se propone utilizar la máquina durante períodos de tiempo prolongados. Cuando se desconecta la alimentación, se pierden el texto que se muestra en la pantalla y el que está almacenado en la memoria.

Si no se emplean pilas alcalinas, no podrán imprimirse tipos de caracteres grandes.

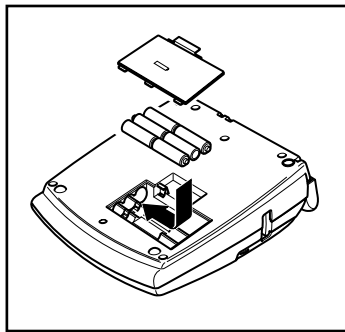
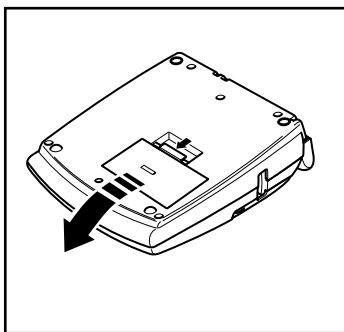

ADAPTADOR DE CA OPCIONAL

El adaptador de CA (modelo AD-60) le permite emplear esta máquina siempre que disponga de una toma de corriente eléctrica.

Para conectar el adaptador de CA opcional:

- 1 Inserte la clavija del adaptador en el conector que tiene la marca DC IN 9.5V al lado derecho de la máquina.
- 2 Inserte la clavija del adaptador de CA en la toma de corriente más cercana.

☞ *Emplee sólo el adaptador de CA diseñado exclusivamente para esta máquina.*

Extraiga las pilas y desconecte el adaptador de CA si no se propone utilizar la máquina durante períodos de tiempo prolongados. Cuando se desconecta la alimentación, se pierden el texto que se muestra en la pantalla y el que está almacenado en la memoria.

Cuando el adaptador de CA esté enchufado en la máquina, si se desenchufa el adaptador de la toma de CA se correrá el riesgo de perder todos los archivos de texto de la memoria, aunque las pilas estén insertadas.



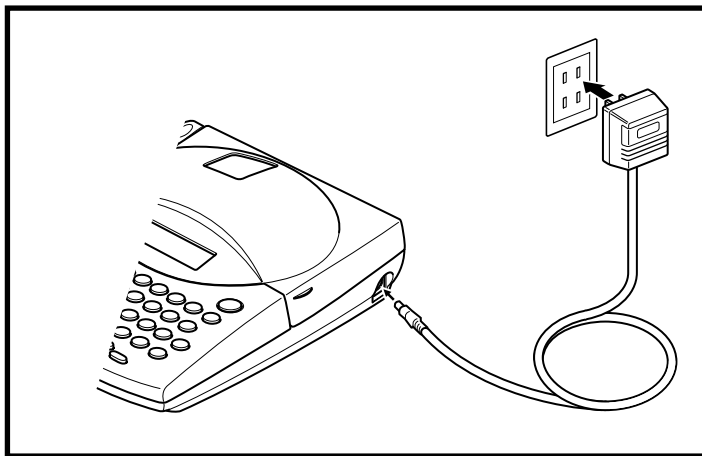

Se recomienda emplear el adaptador de CA para imprimir tipos de caracteres grandes y códigos de barras con cintas de 18 mm (3/4") porque esta operación pueden gastar las pilas con rapidez.



CASETES DE CINTA

Un casete de TZ se suministra con la unidad. Sin embargo, para esta máquina hay disponibles una amplia gama de casetes de cinta TZ de distintos colores y tamaños, es posible crear etiquetas diferentes codificadas por colores o tamaños.

Para cambiar el casete de cinta:

- 1 Levante la cubierta del compartimiento de la cinta para abrirla. Se libera también entonces el casete instalado.
- 2 Si ya hay un casete instalado, extráigalo tirando del mismo recto hacia arriba.
- 3 Si la cinta entintadora del otro casete se afloja, utilice un dedo para bobinar la rueda dentada en el sentido de la flecha de dicho casete hasta tensar la cinta. Además, cerciórese de que el extremo de la cinta esté debajo de las guías de la misma.
 *Si está utilizando un casete de cinta nuevo provisto de retén, cerciórese de extraer éste.*
- 4 Inserte firmemente el casete de cinta en el compartimiento de la cinta asegurándose de que toda la parte posterior del casete está en contacto con la inferior del compartimiento.
 *Cuando inserte el casete de cinta, asegúrese de que la cinta interior no esté enganchada en la esquina de la guía metálica.*
- 5 Cierre la cubierta del compartimiento y conecte la alimentación de la máquina si estaba desconectada.
- 6 Mantenga pulsada  y presione  una vez para que la cinta avance y así quede con la tensión óptima.
- 7 Presione la palanca de la cuchilla de la cinta para cortar la cinta sobrante.

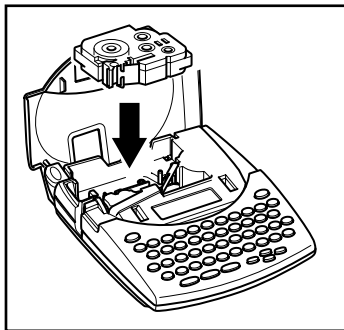
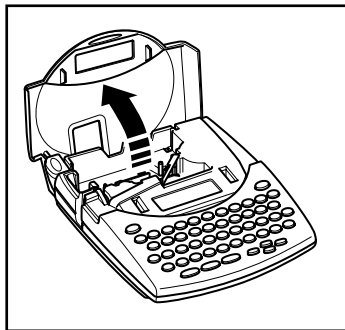

CABEZAL DE IMPRESIÓN Y RODILLOS

De vez en cuando, motas de polvo o suciedad se adhieren al cabezal de impresión y a los rodillos de la máquina. Suele suceder cuando se emplea la unidad en exteriores o en lugares con mucho polvo. Si alguna parte del cabezal de impresión está cubierta de polvo, es posible que aparezca una franja horizontal blanca por el texto de la etiqueta.

Por lo tanto, al igual que con las grabadoras de cintas, el cabezal de la máquina deberá limpiarse de vez en cuando.

Para limpiar el cabezal de impresión y los rodillos:

- 1 Desconecte la alimentación de la máquina.
- 2 Abra la cubierta del compartimiento de la cinta, extraiga el casete, si está dentro. El cabezal de impresión y los rodillos están situados dentro del compartimiento de la cinta.
- 3 Cabezal de impresión: Emplee un palillo con punta de algodón seco para frotar con cuidado el cabezal de impresión con movimiento hacia arriba y abajo.
Rodillos: Emplee un palillo con punta de algodón seco para frotar cada rodillo con movimiento hacia arriba y abajo mientras los gira con el dedo.
- 4 Pruebe de nuevo la impresión.

Si todavía queda polvo:

- 5 Repita el paso 3 empleando un palillo con cabeza de algodón humedecido en alcohol isopropílico (limpieza).

Si no funciona nada de lo de arriba, póngase en contacto con el representante de servicio.

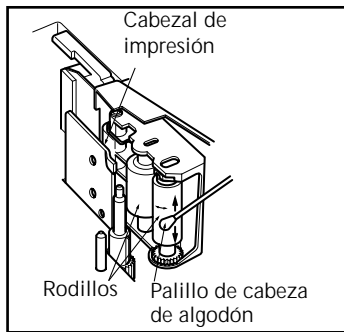
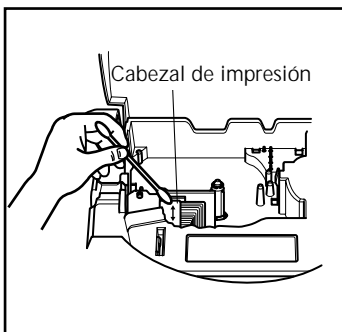

COLOCACIÓN DE ETIQUETAS

CINTA LAMINADA

La varilla suministrada permite que, en las cintas laminadas, usted pueda extraer fácilmente el papel del dorso de la etiqueta.

- 1 Tome la cinta con la mano izquierda, con la superficie impresa arriba, y tome la varilla con la mano derecha.
- 2 Pase la mitad de la cinta por el orificio estrecho largo de la varilla.
- 3 Gire tres cuartos de vuelta la varilla hacia usted y separe la varilla de usted como se muestra abajo.
- 4 Pele el papel del dorso de la etiqueta.

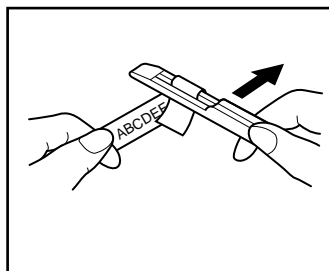
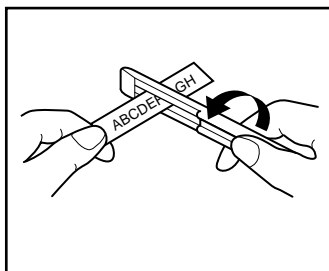

CINTAS DE TELA

La cinta de tela se emplea para adherir un trozo de tela impresa con el texto en prender de vestir empleando una plancha. Después de imprimir el texto en la cinta de tela y de haber cortado la etiqueta empleando unas tijeras, coloque la etiqueta sobre una prenda planchada en la posición en la que desee ponerla de modo que el texto impreso pueda leerse correctamente. Cubra la etiqueta con otra tela y emplee un ajuste de la plancha de temperatura medio-alta (320 a 356 °F (160 a 180 °C)) para presionar con firmeza durante 10 a 15 segundos. Para más detalles, consulte las instrucciones suministradas con el casete de cinta de tela.

CINTAS DE MEMBRETES

Consulte las páginas 19 para encontrar la explicación detallada sobre el empleo de cintas de membretes para hacer membretes.

TECLA DEL CURSOR

El visualizador de LCD de esta máquina muestra dos filas de 11 caracteres; sin embargo, el texto que usted cree puede tener hasta 99 caracteres de longitud. Podrá revisar y editar el texto empleando las teclas del cursor para moverlo y que muestre las distintas partes en el visualizador.

TECLA DEL CURSOR IZQUIERDA



Para mover el cursor un carácter hacia la izquierda:

- Presione  una vez.

Para mover el cursor varios caracteres hacia la izquierda:

- Mantenga presionado  hasta que el cursor se mueva a la posición deseada.

Para mover el cursor al principio de la línea actual:

- Mantenga presionado  y presione .

TECLA DEL CURSOR DERECHA



Para mover el cursor un carácter hacia la derecha:

- Presione  una vez.

Para mover el cursor varios caracteres hacia la derecha:

- Mantenga presionado  hasta que el cursor se mueva a la posición deseada.

Para mover el cursor al final de la línea actual:

- Mantenga presionado  y presione .

TECLA DEL CURSOR HACIA ARRIBA

Para mover el cursor a la línea anterior:



- Presione  una vez.

 Si el cursor está en la primera línea del texto, se moverá al principio de la línea.

Para mover el cursor varias líneas hacia arriba:

- Mantenga presionado  hasta que el cursor se mueva a la posición deseada.

Para mover el cursor al principio de todo el texto:

- Mantenga presionado  y presione .

TECLA DEL CURSOR HACIA ABAJO

Para mover el cursor a la línea siguiente:

- Presione  una vez.





Si el cursor está en la última línea del texto, se moverá al final de la línea.

Para mover el cursor varias líneas hacia abajo:

- Mantenga presionado  hasta que el cursor se mueva a la posición deseada.

Para mover el cursor al final de todo el texto:

- Mantenga presionado  y presione .

TECLAS CODE, ALT Y SHIFT

La mayoría de los caracteres pueden introducirse simplemente presionando sus teclas. Sin embargo, para emplear funciones especiales o para introducir letras en mayúsculas, caracteres acentuados y algunos símbolos, se requieren las siguientes teclas especiales.



TECLA CODE

Para emplear una función impresa encima de la tecla:

- Mantenga presionado  y presione la tecla que está inmediatamente debajo de la función deseada.

TECLA ALT

Para escribir los caracteres impresos en color del lado derecho de las teclas:

- Mantenga presionado  y presione la tecla del carácter deseado escrita en color. El indicador **Alt**, de la izquierda del visualizador, se encenderá mientras se tiene presionado .





TECLA SHIFT

Para escribir una letra mayúscula o un símbolo impreso en la esquina superior izquierda de la tecla:

- Mantenga presionado  y presione la tecla de la letra o símbolo deseado.



El modo **Caps** (mayúsculas) es similar a mantener presionada . Le permite escribir letras mayúsculas continuamente.

Para escribir muchas letras mayúsculas:

- 1 Mantenga presionado  y presione . El indicador de **Caps**, de la izquierda del visualizador, se encenderá.
- 2 Presione las teclas de las letras o símbolos deseados.
- 3 Para salir del modo **Caps**, mantenga presionado  y presione . Se apagará el indicador de **Caps**.

TECLA DE RETORNO



Al igual que en una máquina de escribir o procesador de texto, la tecla de retorno () de esta máquina se emplea para poner fin a una línea de texto y empezar otra. Cuando haya terminado de introducir una línea, presione la tecla de retorno para hacer una línea nueva y mover al cursor a la misma.

 Un bloque sólo puede contener un máximo de tres líneas de texto. Si presiona  cuando el cursor está situado en la tercera línea, aparecerá el mensaje de error "3 LINE LIMIT!".

Anchuras de cinta	Número máximo de líneas que pueden imprimirse
1/4" (6 mm)	1
3/8" (9 mm)	2
1/2" (12 mm)	3
3/4" (18 mm)	3

La tecla de retorno también podrá utilizarse para seleccionar un ítem de una lista (p. ej., añadir un símbolo o un carácter acentuado al texto) o para aplicar un ajuste seleccionado.

Es posible que aparezcan en el visualizador de LCD algunas preguntas para que confirme un comando, especialmente cuando la función que usted ha seleccionado es para borrar o afectar archivos. En estos casos, si presiona  es como si respondiera "sí".

 Para contestar "no", presione . Consulte la descripción de la TECLA DE BORRADO (DEL) de la página 13.



TABULACIÓN



Esta función le permitirá separar secciones de una línea de texto añadiendo **tabulaciones**. Esto le permitirá crear columnas perfectamente alineadas sin tener que introducir varios espacios. Todas las tabulaciones tendrán la misma longitud y se medirán desde el comienzo de la línea, o de la tabulación anterior, si es que existe. La longitud de las tabulaciones podrá ajustarse entre 0,0" y 11,8" (0,0 y 30,0 cm).

☞ El texto no podrá contener más de 50 tabulaciones. Si ya ha añadido 50 tabulaciones al texto, cuando presione , aparecerá el mensaje de error "TAB LIMIT".

Part No.	Product	Price
Printer	8667	\$300
Fax	122960	\$75

Para ajustar la longitud de las tabulaciones:



❶ Mantenga pulsada  y presione  una vez. Se visualizará la longitud de tabulación actual.

❷ Presione  o  hasta que se visualice la longitud deseada, o utilice las teclas numéricas para introducir la longitud.

☞ Para cambiar las unidades (pulgadas o centímetros) utilizadas para la indicación de la longitud de las tabulaciones, presione  hasta que se visualicen las unidades deseadas.

❸ Presione .

Para añadir una tabulación:

● Mantenga pulsada  y presione una vez . La marca de tabulación (**T**) aparecerá en el texto para indicar la posición de la tabulación.

☞ Si el texto delante de una tabulación sobrepasa el punto en el que tiene que comenzar la sección siguiente de texto, tal texto comenzará en la siguiente posición de tabulación.



Por ejemplo, si la longitud está ajustada a 2" y escribe el texto siguiente:

1: A B C **T** D E F **T** G H I ↓
2: J K L M N O P Q R S **T** U

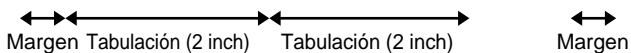
Se imprimirá la etiqueta mostrada a continuación.





TECLA DE BORRADO (DEL)





La tecla de borrado () le permite eliminar caracteres situados a la izquierda de la posición actual del cursor. Se diferencia de la tecla del cursor izquierda () que sólo mueve el cursor sin borrar ningún carácter.

La tecla de borrado también puede utilizarse para abandonar la mayor parte de funciones y volver a la visualización anterior sin cambiar el texto.





Es posible que aparezcan en el visualizador de LCD algunas preguntas para que confirme un comando, especialmente cuando la función que usted ha seleccionado es para borrar o afectar archivos. En estos casos, si presiona  es como si respondiera "sí".

 Para contestar "no", presione . Consulte la descripción de la TECLA DE RETORNO de la página 10.

Para borrar un carácter:

- 1 Presione , , , o  para situar el cursor debajo del carácter que está inmediatamente a la derecha del carácter que usted desea borrar.
- 2 Presione  una vez.







Para borrar una secuencia de caracteres:



- 1 Presione , , , o  para situar el cursor debajo del carácter que está inmediatamente a la derecha del último carácter que usted desea borrar.
- 2 Mantenga presionado  hasta que se hayan borrado todos los caracteres que usted deseaba borrar.

FUNCIÓN DE BORRADO DE LÍNEA (LINE OUT)

Con la función de **borrado de línea**, podrá sacar con facilidad una línea entera de texto.

Para borrar una línea de texto:





- 1 Presione , , , o  para situar el cursor dentro de la línea del texto que usted desee borrar.
- 2 Mantenga presionado  y presione  una vez.



 Cada vez que se presione  mientras se tiene presionado , se borrará una línea de texto.

FUNCIÓN DE REPOSICIÓN (CLEAR)

Si borra la visualización antes de introducir nuevo texto, la función **Reposición** podrá utilizarse para elegir si se desea borrar todo el texto, y todas las funciones de formato (**Tipo de caracteres, Tamaño, Ancho, Estilo, Subrayado, Marco, Margen de la cinta, Alineación, Longitud de la tabulación, Impresión de espejo y Longitud**) volverán a sus ajustes iniciales, o borrar solamente texto.

Para borrar todo el texto y reponer todos los formatos a sus ajustes iniciales:

- 1 Mantenga presionado  y presione .
- 2 Presione  o  hasta que se seleccione **TEXT&FORMAT** (parpadeando).

 Para volver al texto sin borrar nada, presione .
- 3 Presione .



FUNCIÓN DE ACENTOS

La función de **acentos** también podrá utilizarse para añadir caracteres acentuados al texto. Muchos de estos caracteres podrán introducirse empleando .





Los caracteres acentuados se agrupan de acuerdo con la letra mayúscula o minúscula con la que se combinan. Hay disponibles los siguientes caracteres acentuados:



Letras	Caracteres acentuados	Letras	Caracteres acentuados
a	à á â ã ä å æ	l	ĺ ľ
A	À Á Â Ã Ä Å Æ	n	ñ
c	ç	N	Ñ
C	Ç	o	ó ô õ
e	è é ê ë	O	Ó Ô Õ
E	È É Ê Ë	u	ù ú û
i	í î	U	Û Ü Û

Para escribir un carácter acentuado:







1 Mantenga presionado  y presione . Aparecerá el mensaje "a-u/A-U?" en el visualizador.

2 Presione la tecla de la letra acentuada deseada.

 *Para escribir una letra mayúscula, mantenga pulsada  (o mantenga pulsada  y presione  para pasar al modo de mayúsculas) antes de pulsar la tecla de la letra.*

3 Presione  o  hasta que parpadee el carácter acentuado.

4 Presione . La letra y el acento parpadearán alternadamente en el texto.







 *Para escribir una secuencia de caracteres acentuados, mantenga presionada  antes de pulsar . Después continúe añadiendo caracteres acentuados seleccionándolos como se ha explicado en los pasos 2 y 3, manteniendo pulsada  y presionando . Después de haber seleccionado el último carácter de la serie, presione simplemente .*







FUNCIÓN DE SÍMBOLOS

Además de letras, de los símbolos y los números de las teclas, hay 126 marcas adicionales con la función de símbolos.

Los siguientes símbolos están disponibles:

Para escribir un símbolo:

- 1 Mantenga presionado  y presione . Aparecerá una fila de símbolos en el visualizador.
- 2 Presione  o  para visualizar distintas filas de símbolos y presione  o  hasta que parpadee el símbolo deseado.
- 3 Presione . El símbolo aparecerá en el texto.

 Para escribir una secuencia de símbolos, mantenga presionada  antes de pulsar . Después continúe añadiendo símbolos seleccionándolos como se ha explicado en los pasos 2 y 3, manteniendo pulsada  y presionando . Después de haber seleccionado el último símbolo de la serie, presione simplemente .



FUNCIÓN DE FORMATO AUTOMÁTICO



Con la función de **formato automático**, podrá seleccionar gran variedad de formatos preajustados adecuados para su necesidad específica. Esta función ajustará automáticamente la longitud de la etiqueta y los márgenes de la cinta sin cambiar el texto ni ningún otro formato, permitiéndole crear etiquetas con mayor rapidez y facilidad.

Los formatos preajustados son los siguientes:

Ajuste de formato automático	Ajuste de longitud de la etiqueta	Aajuste del margen de la cinta	Aajuste de la alineación horizontal
DEFAULT	OFF	FULL	LEFT
3.5"FLOPPY	2.8" (7.0 cm)	NARROW	CENTER
5"FLOPPY	4.8" (12.2 cm)	NARROW	CENTER
VHS SPINE	5.5" (14.0 cm)	NARROW	CENTER
VHS	3.0" (7.7 cm)	NARROW	CENTER
VCR8mm CASE	3.6" (9.2 cm)	NARROW	CENTER
VCR8mm	2.9" (7.3 cm)	NARROW	CENTER
VHS-C SPINE	1.8" (4.5 cm)	NARROW	CENTER
VHS-C	2.3" (5.8 cm)	NARROW	CENTER
AUDIO	3.5" (8.9 cm)	NARROW	CENTER
DAT CASSETTE	2.2" (5.6 cm)	NARROW	CENTER
MINI DISK	2.0" (5.2 cm)	NARROW	CENTER
ORGANIZER L	3.2" (8.2 cm)	NARROW	CENTER
ORGANIZER S	2.6" (6.5 cm)	NARROW	CENTER
FILE LONG	7.2" (18.3 cm)	NARROW	CENTER
FILE SHORT	3.7" (9.4 cm)	NARROW	CENTER

Para seleccionar un formato preajustado:

❶ Mantenga pulsada  y presione una vez . El ajuste actualmente seleccionado parecerá en el visualizador.

❷ Pulse  o  para seleccionar el ajuste deseado.

☞ *El ajuste predeterminado (DEFAULT) podrá seleccionarse presionando*







❸ Presione  para aplicar el ajuste seleccionado.

☞ *El indicador de longitud se encenderá cuando seleccione un ajuste que no sea **DEFAULT**.*

FUNCIÓN DE MEMBRETE

La función de **membrete** le permite crear con rapidez y facilidad sus propios clichés para membretes personalizados. Seleccione esta función para centrar automáticamente el texto y ajustar la longitud de la cinta y los márgenes a un formato perfecto para los soportes de películas de membrete entintados. Puesto que el soporte del membrete es reutilizable, haga un nuevo cliché de membrete y reemplácelo por el que hay en el soporte de películas.

Para hacer un membrete:

- 1 Escriba el texto, y después inserte un casete de película de membretes de tamaño medio (3/4" (18 mm)).
- 2 Mantenga presionado  y presione  una vez. Aparecerá el mensaje "STAMP FORMAT" en el visualizador.
- 3 Presione . Se hará el formato del texto para un membrete: centrado dentro del área preajustada del mensaje con la longitud y los márgenes de la cinta automáticamente ajustados.
- 4 Presione  para separar el texto del cliché de membrete.
- 5 Presione la palanca de la cuchilla de la cinta, extraiga el papel del dorso del cliché del membrete y adhiéralo al tampón de tinta o soporte de películas.

Para adherir un membrete:

- 1 Extraiga el marco del membrete de entorno al lado al tampón de tinta del soporte de películas de una vez, y saque entonces el sello protector que cubre el tampón de tinta y el papel del dorso del cliché del membrete.
- 2 Con el lado brillante del cliché del membrete encarado hacia arriba, alinee uno de sus extremos con la ranura del lado del soporte de películas de membrete.
- 3 Retenga el extremo del cliché del membrete en su lugar con el dedo pulgar, y pase la cinta por las guías mientras la tensa bien.
- 4 Pliegue el otro extremo del cliché del membrete por en otro lado del soporte de películas de membrete y reténgalo en su lugar con el dedo.
- 5 Adapte el marco del membrete encima del cliché del membrete y presiónelo a su lugar.
- 6 Inserte el soporte de películas de membrete recto en su tapa.

 *Asegúrese de que el membrete quede correctamente cubierto para evitar derrames de tinta.*

FUNCIONES DE TAMAÑO Y DE ANCHURA

El tamaño de los caracteres puede ajustarse empleando las funciones de **tamaño** (Size) y de **ancho** (Wide). Puesto que el tamaño de los caracteres que puede utilizarse depende del ancho de la cinta, la tabla siguiente indica los tamaños de caracteres que pueden utilizarse con cada ancho de cinta.

Anchos de cinta	Tamaños (en puntos)
1/4" (6 mm)	6, 9, 12
3/8" (9 mm)	6, 9, 12, 18
1/2" (12 mm)	6, 9, 12, 18, 24
3/4" (18 mm)	6, 9, 12, 18, 24, 36

El ajuste del tamaño de ajuste inicial es **AUTO** y el ajuste inicial para el ancho es **OFF**. El tamaño y el ancho actualmente seleccionados siempre se indican con los indicadores de encima del visualizador.

Con el ajuste de tamaño **AUTO**, la máquina compara su texto con el ancho de la cinta instalada y ajusta automáticamente los caracteres al tamaño más grande posible. Sin embargo, hay también otros seis tamaños de puntos disponibles y cada uno puede imprimirse con caracteres anchos.

Para cambiar el ajuste del tamaño:

- 1 Manteniendo presionada **Code**, pulse una vez **@ 2**^{Size}, y mantenga presionada **Code** para hacer que se visualice el tamaño actualmente ajustado.
- 2 Siguiendo manteniendo presionada **Code**, continúe presionando **@ 2**^{Size} hasta que se visualice el tamaño actualmente ajustado mediante el indicador del mismo.
 El ajuste del tamaño actual también se mostrará en el indicador de tamaño situado sobre el visualizador.
- 3 Para aplicar el ajuste de tamaño seleccionado a todo el texto, suelte **Code**.

Para activar o desactivar la función de anchura:

- 1 Manteniendo presionada **Code**, pulse una vez **# 3**^{Width}, y mantenga presionada **Code** para hacer que se visualice el ancho actualmente ajustado.
- 2 Siguiendo manteniendo presionada **Code**, continúe presionando **# 3**^{Width} hasta que se visualice el ancho actualmente ajustado mediante el indicador del mismo.
- 3 Para aplicar el ajuste de ancho seleccionado a todo el texto, suelte **Code**.

Cuando haya seleccionado el ajuste **AUTO** y haya instalado una cinta de 18 mm (3/4") de anchura, el texto se imprimirá en mayúsculas y en una sola línea con un tamaño de caracteres de 48 puntos.

FUNCIÓN DE ESTILO

Podrá seleccionar entre doce estilos de caracteres distintos que podrá aplicar a su texto.

☞ *Los caracteres que se imprimen utilizando los tamaños más pequeños pueden resultar difíciles de leer si se seleccionan ciertos ajustes de estilos (por ejemplo, (I+SHADOW).*

Hay disponibles los siguientes ajustes de estilos:

NORMAL

BOLD (negrilla)

OUTLINE (perfilado)

SHADOW (sombreado)

ITALIC (cursiva)

I+BOLD (cursiva y negrilla)

I+OUTLINE (cursiva y perfilado)







I+SHADOW (cursiva y sombreado)

VERTICAL

El ajuste de estilo predeterminado es **NORMAL**. El indicador de estilo de la parte inferior derecha del visualizador mostrará el ajuste de estilo actual cuando seleccione un estilo que no sea **NORMAL**.

Consulte el apartado de Referencia, al final de esta sección, para ver muestras de los ajustes disponibles.

Para cambiar el ajuste del estilo:

- 1 Manteniendo presionada , pulse una vez , y mantenga presionada  para hacer que se visualice el estilo actualmente ajustado.
- 2 Siguiendo manteniendo presionada , continúe presionando  hasta que se visualice el estilo actualmente ajustado mediante el indicador del mismo.
☞ *El ajuste de estilo actual se mostrará en el indicador de estilo de la esquina inferior derecha del visualizador.*
- 3 Para aplicar el ajuste de estilo seleccionado a todo el texto, suelte .

FUNCIÓN DE SUBRAYADO







Podrá acentuar el texto subrayándolo.

El ajuste de subrayado predeterminado es OFF. Cuando haya ajustado la función de **subrayado** a **ON**, el indicador de **subrayado** de la parte derecha del visualizador se encenderá.

ACTIVADO

ABC

Para cambiar el ajuste del subrayado:

- 1 Manteniendo presionada , pulse una vez , y mantenga presionada  para hacer que se visualice el subrayado actualmente ajustado.
- 2 Siguiendo manteniendo presionada , continúe presionando  hasta que se visualice el subrayado actualmente ajustado mediante el indicador del mismo.
 Cuando seleccione el ajuste **ON**, el indicador de **subrayado** se encenderá.
- 3 Para aplicar el ajuste de subrayado seleccionado a todo el texto, suelte .

FUNCIÓN DEL TIPO DE CARACTERES

Con la función del **tipo de caracteres** podrá seleccionar una amplia variedad de tipos de caracteres para su texto.







Los ajustes de tipos de caracteres siguientes están disponibles en la PT-1800/1810:

HELSINKI, BRUSSELS

El ajuste inicial del tipo de caracteres es **HELSINKI**. El ajuste actualmente seleccionado del tipo de caracteres siempre se muestra con los indicadores del **tipo de caracteres** de debajo del visualizador.

Consulte el apartado de Referencia, al final de esta sección, para ver muestras de los ajustes disponibles.

Para cambiar el ajuste del tipo de caracteres:

- 1 Manteniendo presionada , pulse una vez , y mantenga presionada  para hacer que se visualice el tipo de caracteres actualmente ajustado.
- 2 Siguiendo manteniendo presionada , continúe presionando  hasta que se visualice el tipo de caracteres actualmente ajustado mediante el indicador del mismo.
 *El ajuste actual de fuente también se mostrará mediante el indicador de fuente de la parte inferior izquierda del visualizador.*
- 3 Para aplicar el ajuste de tipo de caracteres seleccionado a todo el texto, suelte .

REFERENCIA

Ajustes del tipo de caracteres	Muestras de tipos de caracteres	Indicadores del visualizador
HELSINKI	abc	Font 1
BRUSSELS	abc	Font 2

FUNCIÓN DE MARCOS

Con la función de **marcos**, podrá seleccionar diversos marcos y funciones destacadas para hacer un diseño más decorativo o una etiqueta con más énfasis.







Los ajustes de marcos siguientes están disponibles:

OFF, ROUND, CANDY, POINTING, NAMEPLATE, DOT





El ajuste inicial de marco es **OFF**, aunque hay también otros ajustes. Si se selecciona cualquier ajuste que no sea **OFF**, se encenderá el indicador de **marco**, situado a la derecha del visualizador.

Consulte el apartado de Referencia, al final de esta sección, para ver muestras de los ajustes disponibles.

Para cambiar el ajuste del marco:

- 1 Manteniendo presionada , pulse una vez , y mantenga presionada  para hacer que se visualice el marco actualmente ajustado.
- 2 Siguiendo manteniendo presionada , continúe presionando  hasta que se visualice el marco actualmente ajustado mediante el indicador del mismo.
 *El indicador de **marco** se enciende si se selecciona un ajuste que no sea **OFF**.*
- 3 Para aplicar el ajuste de marco seleccionado a todo el texto, suelte .

REFERENCIA

Ajustes del marco	Muestras de marco	Ajustes del marco	Muestras de marco
OFF	ABC	POINTING	
ROUND		NAME-PLATE	
CANDY		DOT	

FUNCIÓN DE CINTA

La función de margen cinta le permite ajustar el tamaño de los márgenes de los lados izquierdo y derecho del texto.

El ajuste inicial de margen cinta es FULL, aunque hay también disponibles otros tres ajustes.

FULL

(márgenes de 25 mm (1"))

NONE



(sin márgenes)

NARROW

(márgenes de 4 mm (1/6"))







HALF

(márgenes de 12 mm (1/2"))

➡ Después de imprimir una etiqueta usando el ajuste **NONE** de margen cinta, mantenga presionado  y presione  una vez para que la cinta avance antes de presionar la palanca de la cuchilla de la cinta para cortarla, porque de lo contrario podrían cortarse algunos de los caracteres impresos.

Después de imprimir empleando los ajustes de margen cinta **NARROW**, y **HALF**, presione la palanca de la cuchilla de la cinta para cortar la etiqueta, y emplee entonces unas tijeras para cortar a lo largo de los puntos (:) impresos para centrar el texto dentro de la etiqueta.

Para cambiar el ajuste de la cinta:

- ➊ Manteniendo presionada , pulse una vez , y mantenga presionada  para hacer que se visualice la cinta actualmente ajustado.
- ➋ Siguiendo manteniendo presionada , continúe presionando  hasta que se visualice la cinta actualmente ajustado mediante el indicador del mismo.
- ➌ Para aplicar el ajuste de la cinta seleccionado a todo el texto, suelte .

FUNCIÓN DE LA ALINEACIÓN HORIZONTAL

Podrá elegir alinear texto en una de las tres formas disponibles. Además, si utilizó la función de longitud para ajustar la longitud de la etiqueta, los textos se alinearán dentro de la etiqueta de acuerdo con el ajuste de alineación horizontal seleccionado.

El ajuste inicial de la alineación horizontal es **LEFT** (izquierda), aunque también están disponibles otros dos ajustes.

LEFT	AB CDE FG	RIGHT	AB CDE FG
CENTER	AB CDE FG		

Para cambiar el ajuste de la alineación horizontal:

- 1 Manteniendo presionada **Code**, pulse una vez **Align R**, y mantenga presionada **Code** para hacer que se visualice la alineación horizontal actualmente ajustado.
- 2 Siguiendo manteniendo presionada **Code**, continúe presionando **Align R** hasta que se visualice la alineación horizontal actualmente ajustado mediante el indicador del mismo.
- 3 Para aplicar el ajuste de la alineación seleccionado a todo el texto, suelte **Code**.



LENGTH FUNCIÓN



Aunque la longitud de la etiqueta impresa ajusta automáticamente dicha longitud de acuerdo con el texto introducido, es posible que usted desee hacer una etiqueta con una longitud específica. La función de **longitud** le permitirá ajustar la longitud de la etiqueta entre 1,6" y 11,8" (4,0 cm y 30,0 cm).

El ajuste predeterminado de longitud es **OFF**. Cuando ponga la función de **longitud** en **ON**, se encenderá el indicador de longitud de la parte derecha del visualizador.

☞ *Si desconecta y vuelve a conectar la alimentación de la máquina, el ajuste de longitud volverá a **OFF**.*



Para activar y desactivar la función de longitud:

1 Manteniendo presionada , presione una vez , y mantenga presionada  hasta que se visualice brevemente la longitud actual de la etiqueta (texto y ambos márgenes), y después haga que se visualice el ajuste de longitud de etiqueta actual (**ON** u **OFF**).



2 Manteniendo presionada , continúe presionando  hasta que se visualice el ajuste de longitud de etiqueta deseado.

☞ *Cuando seleccione **ON**, se encenderá el indicador de **longitud**.*

3 Suelte . Si había seleccionado **ON**, se visualizará la longitud actual de la etiqueta.

4 Presione  o  para seleccionar la longitud deseada, o utilice las teclas numéricas para introducir la longitud.

☞ *Para cambiar las unidades (pulgadas o centímetros), presione  hasta que aparezcan las unidades deseadas.*

Para cambiar la longitud en pasos de 1" (1,0 cm), mantenga pulsada  o , y después presione la tecla cuando se visualice el ajuste deseado.



5 Presione .

FUNCIÓN DE LA TECLA DE IMPRESIÓN Y AVANCE



Después de haber introducido el texto y de haber seleccionado los ajustes del formato deseado, estará preparado para la impresión.

Para imprimir una etiqueta:

- Presione una vez . Se visualizará "COPIES" y a continuación el número de etiquetas que van a imprimirse.

☞ Después de haber impreso utilizando el ajuste de margen de cinta **NONE**, mantenga pulsada  y después presione una vez  para hacer que la cinta avance antes de cortarla, ya que de lo contrario algunos caracteres no se imprimirían.

Para hacer avanzar la cinta:

- Mantenga presionado  y presione  una vez. La cinta avanzará 25 mm (1") hacia afuera.









Para cortar la cinta:

- Presione la cinta sobre la palanca de la cuchilla.
- ☞ Para evitar daños en la cinta, no trate de cortarla durante la impresión ni el avance. Si presiona demasiado la palanca de la cuchilla, puede romperse.



FUNCIÓN DE NUMERACIÓN



Esta función podrá utilizarse para imprimir muchas copias del mismo texto aumentando en 1 cierto número en el texto después de haber impreso cada etiqueta.



Para utilizar la función de numeración:

- 1 Presione , , , o  para colocar el cursor debajo del número que desee aumentar.
- 2 Mantenga pulsada  y presione . En el visualizador aparecerá el mensaje "NUMBER UNTIL 1-9?".
- 3 Presione una tecla numérica ( a ) correspondiente al último número que desee imprimir.

 Para abandonar la función de **numeración** sin imprimir, mantenga pulsada

 y después presione  (o presione simplemente ).

- 4 Para comenzar la impresión de etiquetas, presione  (o ). El número de cada copia se visualizará mientras esté copiándose.



 Después de haber impreso utilizando el ajuste de margen **NONE**, mantenga pulsada  y presione una vez  para hacer que la cinta avance antes de cortarla, ya que de lo contrario algunos caracteres no se imprimirían.



- 5 Para cortar la cinta, presione la palanca del cortador de la misma, y después utilice unas tijeras para cortar a lo largo de los puntos a fin de separar las etiquetas.

FUNCIÓN DE IMPRESIÓN REPETIDA



Esta función le permite imprimir hasta 9 copias del mismo texto.



Para emplear la función de impresión repetida:

❶ Mantenga presionado  y presione . Aparecerá el mensaje "COPIES UNTIL 1-9?" en el visualizador.

❷ Presione la tecla numérica ( a ) correspondiente al número de etiquetas que desee.

☞ *Para abandonar la función de impresión repetida sin imprimir, mantenga pulsada  y después presione  (o presione simplemente ).*

❸ Presione  (o ) para empezar a imprimir las etiquetas. Se visualizará el número de cada copia mientras se imprime.

☞ *Después de imprimir empleando el ajuste **NONE** de margen cinta, mantenga presionado  y presione  una vez para que avance la cinta antes de cortarla, porque de no hacerlo así algunos caracteres impresos podrían quedar cortados.*

❹ Presione la palanca de la cuchilla de la cinta para cortar la cinta, y emplee luego unas tijeras para cortar a lo largo de los puntos impresos para separar las etiquetas.

FUNCIONES DE LA MEMORIA

Usted podrá utilizar la memoria para almacenar sus archivos de texto más frecuentemente utilizados. El texto permanecerá en la memoria, incluso después de haberlo eliminado del visualizador utilizando la función de **borrado** (manteniendo presionada )

y presionando .

Cuando almacena cada archivo, a éste se le asignará un número para poder invocarlo fácilmente. En la memoria podrá almacenar hasta 9 archivos de texto, o aproximadamente 300 caracteres. Cada archivo de texto almacenado podrá tener un máximo de 99 caracteres.

Como, cuando se invoque un archivo de texto con la función de **invocación**, se invocará una copia del archivo almacenado, el texto podrá editar o imprimirse sin cambiar el archivo originalmente almacenado. Cuando ya no necesite un archivo o cuando ya no lo necesite, podrá utilizar la función de **borrado de la memoria**.



☞ *Cuando tenga que insertar nuevas pilas, hágalo antes de cinco minutos de haber extraído las viejas, ya que de lo contrario los archivos de texto almacenados en la memoria se perderían (a menos que la máquina esté enchufada en un tomacorriente de la red con el adaptador de alimentación de CA).*

ALMACENAMIENTO DE TEXTO

Para almacenar un archivo de texto:



① Mantenga pulsada  y presione . En el visualizador aparecerá el mensaje "STORE SELECT 1-9?".

☞ *Si ya están almacenados 300 caracteres, en el visualizador aparecerá el mensaje de error "MEMORY FULL!". Cuando ocurra esto, tendrá que borrar un mensaje existente antes de poder almacenar otro nuevo.*

② Presione la tecla ( a ) correspondiente al número de archivo en el que desee almacenar texto. El texto se almacenará en el número de archivo seleccionado y el texto previamente mostrado en el visualizador desaparecerá.



☞ *Si ya hay un archivo almacenado con el número de archivo seleccionado, en el visualizador aparecerá el mensaje "OVERWRITE?", y usted tendrá que decidir entre reescribir o borrar tal archivo.*

*Para abandonar la función de **almacenamiento** del texto, mantenga pulsada*

 y presione  (o simplemente presione .



Par reescribir un archivo almacenado con otro nuevo:



- Presione  para borrar el archivo previamente almacenado y almacenar el nuevo con el número seleccionado.



 Para retroceder y elegir otro número de archivo sin reescribir el archivo de texto, presione , y después presione una tecla numérica correspondiente a un número de archivo diferente.



INVOCACIÓN DE TEXTO



Para invocar un archivo de texto:

- 1 Mantenga pulsada  y presione . En el visualizador aparecerá el mensaje "RECALL SELECT 1-9?".

- 2 Presione la tecla ( a ) correspondiente al número de archivo que desee invocar. Aparecerá el texto almacenado con el número de archivo seleccionado.

 Para ver otras partes del archivo de texto seleccionado, presione  o .



Para hacer que se visualice el texto almacenado en otros números de archivos, presione  o , o la tecla correspondiente a otro número de archivo.



Para abandonar la función de **invocación** sin invocar texto, mantenga pulsada  y presione  (o presione simplemente .



- 3 Presione . Cualquier texto previamente introducido en el visualizador se borrará y el texto introducido en el número de archivo seleccionado se invocará en el visualizador.



BORRADO DE UN ARCHIVO



Para borrar un archivo de texto:

- 1 Mantenga pulsada  y presione . En el visualizador aparecerá el mensaje "CLEAR SELECT 1-9?".

2 Presione la tecla ( a ) correspondiente al número de archivo que desee borrar. En el visualizador aparecerá el texto almacenado con el número de archivo seleccionado.



 Para ver otras partes del archivo de texto seleccionado, presione  o .

Para hacer que se visualice el texto almacenado en otros números de archivos, presione  o , o la tecla correspondiente a otro número de archivo.







Para abandonar la función **borra de la memoria** sin borrar el archivo de texto, mantenga pulsada  y presione  (o presione simplemente ).





3 Para borrar el archivo de texto seleccionado, presione .

SOLUCIÓN DE PROBLEMAS

Problema	Remedio
1. El visualizador se queda en blanco después de haber conectado la alimentación de la máquina.	<ul style="list-style-type: none"> • Compruebe que el adaptador de CA esté correctamente enchufado. • Si está empleando pilas alcalinas, compruebe que estén correctamente insertadas. • Si las pilas están gastadas, reemplácelas por otro nuevo.
2. La máquina no imprime o los caracteres impresos quedan borrosos.	<ul style="list-style-type: none"> • Compruebe que el casete de cinta se haya insertado correctamente. • Si el casete de cinta está vacío, reemplácelo por otro nuevo. • Asegúrese de que la cubierta del casete de cinta se haya cerrado.
3. Los archivos de texto almacenados en la memoria ya no están ella.	<ul style="list-style-type: none"> • Si las pilas están gastadas, reemplácelas por otro nuevo.
4. Los caracteres impresos no se forman correctamente.	<ul style="list-style-type: none"> • Si está empleando pilas alcalinas, quizás estén gastadas. Pruebe utilizando el adaptador de CA o reemplace las pilas por otras nuevas.
5. Aparece una línea horizontal en blanco a través de la etiqueta impresa.	<ul style="list-style-type: none"> • Limpie el cabezal de impresión como se ha explicado en la página 12.
6. Aparecen franjas.	<ul style="list-style-type: none"> • Se ha terminado la cinta. Reemplace el casete de cinta por otro nuevo.
7. La máquina se ha "bloqueado" (es decir, no responde cuando se presiona una tecla).	<ul style="list-style-type: none"> • Desconecte la alimentación de la máquina, y entonces, mientras mantiene presionado  y , vuelva a conectar la alimentación. El texto y los formatos del visualizador y todos los archivos de texto almacenados en la memoria quedan borrados.

LISTA DE MENSAJES DE ERROR

Mensaje de error	Causa	Remedio
3 LINE LIMIT!	<ul style="list-style-type: none"> Este mensaje aparece si ya existen cuatro líneas presionando . 	<ul style="list-style-type: none"> Límite el número de líneas a tres.
BATTERIES WEAK!	<ul style="list-style-type: none"> Este mensaje aparece cuando las pilas alcalinas instaladas están gastadas. 	<ul style="list-style-type: none"> Reemplace las pilas o emplee el adaptador de CA.
BUFFER EMPTY!	<ul style="list-style-type: none"> Este mensaje aparece si mantiene pulsada  y presiona , pero sin haber introducido texto en el visualizador. Este mensaje aparece si intenta imprimir, pero sin haber introducido texto. Este mensaje aparece si intenta almacenar archivo de texto en la memoria, pero sin haber introducido texto en el visualizador. 	<ul style="list-style-type: none"> Introduzca algo de texto antes de iniciar la función. Introduzca texto antes de la impresión. Introduzca texto antes del almacenamiento.
BUFFER FULL!	<ul style="list-style-type: none"> Este mensaje aparece si intenta introducir un carácter, símbolo, código de barras, retorno, o un espacio cuando ya se han introducido 99 caracteres. 	<ul style="list-style-type: none"> Borre algo del texto existente para poder introducir más texto.
CAN'T HERE!	<ul style="list-style-type: none"> Este mensaje aparecerá si el cursor está al final del texto cuando mantenga pulsada  y presione . 	<ul style="list-style-type: none"> Mueva el cursor hasta debajo del número manteniendo pulsada  y presionando .

Mensaje de error	Causa	Remedio
CHANGE ADAPTOR	<ul style="list-style-type: none"> Este mensaje aparece si se está empleando un adaptador de alta tensión. 	<ul style="list-style-type: none"> Extraiga el adaptador de alta tensión y conecte el adaptador de 9,0V CA 1,2 A.
CUTTER ERROR!	<ul style="list-style-type: none"> Este mensaje aparecerá si presiona la palanca del cortador de cinta mientras esté imprimiéndose una etiqueta. 	<ul style="list-style-type: none"> Suelte la palanca del cortador de cinta.
INVAL. CHRS!	<ul style="list-style-type: none"> Este mensaje aparecerá si el cursor está al final del texto cuando mantenga pulsada  y presione . 	<ul style="list-style-type: none"> Mueva el cursor hasta debajo del número manteniendo pulsada  y presionando .
LENGTH LIMIT!	<ul style="list-style-type: none"> Este mensaje aparece si el texto es más largo de 1 metro cuando trate de imprimirlo. Este mensaje aparecerá si utilizó la función de longitud para ajustar una longitud inferior a 1,6" (4,0 cm) o más de 11,8" (30,0 cm). Este mensaje aparecerá si utilizó la función de longitud de tabulaciones para ajustar una longitud superior a 11,8" (30,0 cm). 	<ul style="list-style-type: none"> Acorte el texto a menos de 1 metro antes de tratar imprimir. Ajuste la longitud de la etiqueta entre 1,6" (4,0 cm) y 11,8" (30,0 cm). Ajuste la longitud de las tabulaciones de forma que sea inferior a 11,8" (30,0 cm).
LINE LIMIT!	<ul style="list-style-type: none"> Este mensaje aparece si el número de líneas del texto es mayor que el número máximo de líneas posible para la cinta instalada. 	<ul style="list-style-type: none"> Reduzca el número de líneas o instale una cinta más ancha.
MEMORY FULL!	<ul style="list-style-type: none"> Este mensaje aparecerá si intenta almacenar un archivo de texto después de haber almacenado ya 300 caracteres en la memoria. 	<ul style="list-style-type: none"> Borre un archivo que no desee para dejar espacio para el nuevo.

Mensaje de error	Causa	Remedio
NO FILES!	<ul style="list-style-type: none"> Este mensaje aparece si intenta llamar o borrar un archivo de texto de la memoria cuando realmente no hay ninguno almacenado. 	<ul style="list-style-type: none"> Almacene primero un archivo de texto.
NUMBER TOO SMALL!	<ul style="list-style-type: none"> Este mensaje aparecerá si el número ajustado para imprimirse utilizando la función de numeración es inferior al situado sobre el cursor. 	<ul style="list-style-type: none"> Presione la tecla correspondiente a un número superior al del texto.
RAM PROBLEM!	<ul style="list-style-type: none"> Este mensaje aparece si hay algún problema con la memoria de acceso aleatorio de la máquina. 	<ul style="list-style-type: none"> Póngase en contacto con su representante de servicio.
REPLACE BATTERIES!	<ul style="list-style-type: none"> Este mensaje aparece cuando las pilas alcalinas instaladas están casi gastadas. 	<ul style="list-style-type: none"> Reemplace las pilas o emplee el adaptador de CA.
ROM PROBLEM!	<ul style="list-style-type: none"> Este mensaje aparece si hay algún problema con la memoria de acceso aleatorio de la máquina. 	<ul style="list-style-type: none"> Póngase en contacto con su representante de servicio.
SYSTEM ERROR!	<ul style="list-style-type: none"> Este mensaje aparece si hay algún problema con el software de la máquina. 	<ul style="list-style-type: none"> Póngase en contacto con su representante de servicio.
NO TAPE!	<ul style="list-style-type: none"> Este mensaje aparecerá si intenta imprimir una etiqueta o alimentar cinta cuando haya casete de cinta instalado. 	<ul style="list-style-type: none"> Instale un casete de cinta y pruebe de nuevo.
TAB LIMIT!	<ul style="list-style-type: none"> Este mensaje aparecerá si ya ha ajustado 50 tabulaciones en el texto cuando presione . 	<ul style="list-style-type: none"> Limite el número de tabulaciones del texto a 50.
TEXT TOO HIGH!	<ul style="list-style-type: none"> Este mensaje aparece si el tamaño del texto es más grande que el ancho de la cinta instalada. 	<ul style="list-style-type: none"> Reduzca el tamaño de los caracteres o instale una cinta más ancha.

Mensaje de error	Causa	Remedio
TEXT TOO LONG!	<ul style="list-style-type: none">• Este mensaje aparece si la longitud del texto es mayor que la longitud que se ha ajustado para la etiqueta utilizando la función de longitud.	<ul style="list-style-type: none">• Borre algo de texto, reduzca el ancho de los caracteres o incremente la longitud ajustada de la etiqueta.

ESPECIFICACIONES

HARDWARE

Dispositivo de entrada:	Teclado de 52 teclas
LCD:	7 × 5 puntos 12 caracteres × 2 líneas 17 indicadores
Cinta de impresión:	Sensible a la presión, base adhesiva, 8 m (26'3") de longitud Cuatro anchos disponibles: 6 mm (1/4") 9 mm (3/8") 12 mm (1/2") 18 mm (3/4")
Alimentación:	Seis pilas alcalinas AA (AM3, LR6) o adaptador de CA opcional Desconexión automática de la alimentación si no se pulsa ninguna tecla durante 5 minutos
Cabezal de impresión:	128 puntos / 180 dpi
Dimensiones:	178 (An) × 205 (Prf) × 60 (Al) mm (7" × 8 1/6" × 2 23/63")
Peso:	700 g (1.5 lbs) (sin casete de cinta ni pilas instalados)

SOFTWARE

Tamaño de la memoria intermedia:	Máximo de 99 caracteres Una línea – 1 m Máximo de tres líneas
Tamaño de la memoria:	300 caracteres
Tamaño de caracteres:	Seis tamaños (6, 9, 12, 18, 24 y 36 puntos) + 48 puntos (Mayúsculas solamente) Todos disponibles en el modo normal y ancho (wide)
Estilos de impresión:	Normal, perfilado, negrilla, sombreado (todos pueden combinarse con cursiva), y Vertical

ACCESORIOS

● Accesorios de consumo

Adquiera los casetes de cinta en el distribuidor autorizado que le quede más cerca. Emplee sólo cintas Brother TZ con esta máquina. Brother no puede hacerse responsable por los problemas causados por el empleo de accesorios de consumo no autorizados. No emplee cintas que no tengan la marca .

N.º de producto	Descripción	CANT./PAQUETE	PRECIO
Cintas laminadas de 18 mm (3/4")			
TZ-141	Caracteres negros sobre adhesivo transparente	1	\$20.99
TZ-145	Caracteres blancos sobre adhesivo transparente	1	\$20.99
TZ-241	Caracteres negros sobre adhesivo blanco	1	\$20.99
TZ-242	Caracteres rojos sobre adhesivo blanco	1	\$20.99
TZ-243	Caracteres azules sobre adhesivo blanco	1	\$20.99
TZ-344	Caracteres dorados sobre adhesivo negro	1	\$24.99
TZ-345	Caracteres blancos sobre adhesivo negro	1	\$23.99
TZ-441	Caracteres negros sobre adhesivo rojo	1	\$20.99
TZ-541	Caracteres negros sobre adhesivo azul	1	\$20.99
TZ-545	Caracteres blancos sobre adhesivo azul	1	\$23.99
TZ-641	Caracteres negros sobre adhesivo amarillo	1	\$20.99
TZ-741	Caracteres negros sobre adhesivo verde	1	\$20.99
TZ-B41	Caracteres negros sobre adhesivo naranja fluorescente	1	\$24.99
TZ-M41	Caracteres negros sobre adhesivo claro (MATE)	1	\$20.99
TZ-WB41	Caracteres negros sobre adhesivo Bugs Bunny	1	\$23.99
TZ-WT41	Caracteres negros sobre adhesivo Taz	1	\$23.99
TZ-WS41	Caracteres negros sobre adhesivo Tweety & Sylvester	1	\$23.99
Cintas laminadas de 12 mm (1/2")			
TZ-131	Caracteres negros sobre adhesivo transparente	1	\$16.99
TZ-231	Caracteres negros sobre adhesivo blanco	1	\$17.99
TZ-232	Caracteres rojos sobre adhesivo blanco	1	\$17.99
TZ-335	Caracteres blancos sobre adhesivo negro	1	\$20.99
Cintas laminadas de 9 mm (3/8")			
TZ-121	Caracteres negros sobre adhesivo transparente	1	\$14.99
TZ-221	Caracteres negros sobre adhesivo blanco	1	\$16.99
TZ-325	Caracteres blancos sobre adhesivo negro	1	\$18.99

N.º de producto	Descripción	CANT./ PAQUETE	PRECIO
TZ-421	Caracteres negros sobre adhesivo rojo	1	\$16.99
Cintas laminadas de 6 mm (1/4")			
TZ-111	Caracteres negros sobre adhesivo transparente	1	\$12.99
TZ-211	Caracteres negros sobre adhesivo blanco	1	\$14.99
TZ-315	Caracteres blancos sobre adhesivo negro	1	\$17.99

Cintas especiales

N.º de producto	Descripción	CANT./ PAQUETE	PRECIO
TZ-SE4	Caracteres negros sobre cinta de seguridad de 18 mm (3/4")	1	\$29.99
TZ-FA3	Caracteres azules sobre cinta de tela de 12 mm (1/2")	1	\$24.99

JUEGO DE MEMBRETES

N.º de producto	Descripción	CANT./ PAQUETE	PRECIO
SK-LB	Juego para hacer sellos para sello con tinta negra grande	1	\$39.99
SK-MB	Juego para hacer sellos para sello con tinta negra medio	1	\$37.99
SH-LB	Estampador adicional para sello con tinta negra grande	1	\$27.99
SH-MB	Estampador adicional para sello con tinta negra medio	1	\$24.99

brother®

Printed in Japan
LA0659001

Free Manuals Download Website

<http://myh66.com>

<http://usermanuals.us>

<http://www.somanuals.com>

<http://www.4manuals.cc>

<http://www.manual-lib.com>

<http://www.404manual.com>

<http://www.luxmanual.com>

<http://aubethermostatmanual.com>

Golf course search by state

<http://golfingnear.com>

Email search by domain

<http://emailbydomain.com>

Auto manuals search

<http://auto.somanuals.com>

TV manuals search

<http://tv.somanuals.com>