

iD50



Your music + our passion

Contents

Introduction	2
Important safety instructions	3
Limited warranty	4
Rear panel	5
Connections.....	5
Front panel	6
Remote control.....	7
Operating instructions	8
Technical specifications	10
Troubleshooting.....	11

Like all Cambridge Audio products, the iD50 adheres to three core principles – stunning performance, ease of use and incredible value.

Make sure you register your purchase!
Visit: www.cambridgeaudio.com/sts

By registering, you'll be the first to know about:

- Future product releases
- Software upgrades
- News, events and exclusive offers plus competitions!

This guide is designed to make installing and using this product as easy as possible. Information in this document has been carefully checked for accuracy at the time of printing; however, Cambridge Audio's policy is one of continuous improvement, therefore design and specifications are subject to change without prior notice.

This document contains proprietary information protected by copyright. All rights are reserved. No part of this manual may be reproduced by any mechanical, electronic or other means, in any form, without prior written permission of the manufacturer. All trademarks and registered trademarks are the property of their respective owners.

"Made for iPod" means that an electronic accessory has been designed to connect specifically to iPod and has been certified by the developer to meet Apple performance standards.

Apple is not responsible for the operation of this device or its compliance with safety and regulatory standards.

© Copyright Cambridge Audio Ltd 2008

iTunes, iPod and the Apple logo are trademarks of Apple Inc., registered in the U.S. and other countries.

Introduction

Thank you for purchasing the Cambridge Audio iD50 Audiophile Docking Station for iPod. We are confident that it will provide you with many years of listening pleasure.

The iD50 enables you to get the very best audio and video quality from your iPod. A ground sensing pseudo-balanced noise cancelling scheme and buffered audio outputs extract the maximum information possible.

Gold-plated RCA/Phono connections allow the iD50 to be used with a high quality separates system for true audiophile performance.

In addition, you can use your television to both browse your iPod via the iD50's simple On-Screen Display and view video content. An RS232 interface is also included for custom installation use.

The iD50 supports both Simple and Advanced modes of operation. In Simple Mode, the dock is in an active standby state to allow charging of the iPod and output of the audio via the iD50. The iPod's own display is active and it is controllable via the supplied remote control or its own front panel and touch-wheel.

In Advanced Mode, the iPod can be controlled and browsed using the remote control and the iD50's On-Screen Display via a suitable TV. Audio and video are available via the iD50 connections and charging of the iPod can be turned on or off.

Please do not compromise on the quality of interconnects you use with this product. Naturally, we particularly recommend cables from the Cambridge Audio range, designed to the same exacting standards as this product. Contact your dealer for details.

Thank you for taking the time to read this manual; we recommend you keep it for future reference.



Matthew Bramble
Cambridge Audio Technical Director
and the Docking Station design team

Important safety instructions

For your own safety please read the following important safety instructions carefully before attempting to connect this unit to the mains power supply. They will also enable you to get the best performance from and prolong the life of the unit:

1. Read these instructions.
2. Keep these instructions.
3. Heed all warnings.
4. Follow all instructions.
5. Do not use this apparatus near water.
6. Clean only with a dry cloth.
7. Do not block any ventilation openings. Install in accordance with the manufacturer's instructions.
8. Do not install near any heat sources such as radiators, heat registers, stoves, or other apparatus (including amplifiers) that produce heat.
9. Do not defeat the safety purpose of the polarized or grounding-type plug. A polarized plug has two blades with one wider than the other. A grounding-type plug has two blades and a third grounding prong. The wide blade or the third prong are provided for your safety. If the provided plug does not fit into your outlet, consult an electrician for replacement of the obsolete outlet.
10. Protect the power cord from being walked on or pinched, particularly at plugs, convenience receptacles and the point where they exit from the apparatus.
11. Only use attachments/accessories specified by the manufacturer.
12. Use with only the cart, stand, tripod, bracket, or table specified by the manufacturer, or sold with the apparatus. When a cart is used, use caution when moving the cart/ apparatus combination to avoid injury from tip-over. 
13. Unplug this apparatus during lightning storms or when unused for long periods of time.
14. Refer all servicing to qualified service personnel. Servicing is required when the apparatus has been damaged in any way, such as the power-supply cord or plug having been damaged, liquid has been spilled or objects have fallen into the apparatus, the apparatus has been exposed to rain or moisture, does not operate normally, or has been dropped.

WARNING – To reduce the risk of fire or electric shock, do not expose this unit to rain or moisture.

The unit must be installed in a manner that makes disconnection of the mains plug from the mains socket outlet (or appliance connector from the rear of the unit) possible. Where the mains plug is used as the disconnect device, the disconnect device shall remain readily operable. Only use the mains cord supplied with this unit.

Please ensure there is ample ventilation (at least 10cm clearance all round). Do not put any objects on top of this unit. Do not situate it on a rug or other soft surface and do not obstruct any air inlets or outlet grilles. Do not cover the ventilation grilles with items such as newspapers, tablecloths, curtains, etc.

This unit must not be used near water or exposed to dripping or splashing water or other liquids. No objects filled with liquid, such as vases, shall be placed on the unit.



CAUTION

Risk of electric shock.
Do not open.

AVIS

Risque de choc électrique.
Ne pas ouvrir.

ACHTUNG

Vorm öffnen des Gerätes.
Netzstecker ziehen.



The lightning flash with the arrowhead symbol within an equilateral triangle is intended to alert the user to the presence of un-insulated 'dangerous voltage' within the product's enclosure that may be of sufficient magnitude to constitute a risk of electric shock to persons.

The exclamation point within an equilateral triangle is intended to alert the user to the presence of important operating and maintenance instructions in the service literature relevant to this appliance.



The symbol on this product indicates that it is of CLASS II (double insulated) construction.



WEEE symbol

The crossed-out wheeled bin is the European Union symbol for indicating separate collection for electrical and electronic equipment. This product contains electrical and electronic equipment which should be reused, recycled or recovered and should not be disposed of with unsorted regular waste. Please return the unit or contact the authorised dealer from whom you purchased this product for more information.



CE mark

This product complies with European Low Voltage (2006/95/EC) and Electromagnetic Compatibility (89/336/EEC) Directives when used and installed according to this instruction manual. For continued compliance only Cambridge Audio accessories should be used with this product and servicing must be referred to qualified service personnel.



C-Tick mark

This product meets the Australian Communications Authority's Radio communications and EMC requirements.



Ross Test Stamp

This product meets Russian electronic safety approvals.

FCC regulations

NOTE: THE MANUFACTURER IS NOT RESPONSIBLE FOR ANY RADIO OR TV INTERFERENCE CAUSED BY UNAUTHORIZED MODIFICATIONS TO THIS EQUIPMENT. SUCH MODIFICATIONS COULD VOID THE USER AUTHORITY TO OPERATE THE EQUIPMENT.



This equipment has been tested and found to comply with the limits for a Class B digital device, pursuant to Part 15 of the FCC Rules. These limits are designed to provide reasonable protection against harmful interference in a residential installation. This equipment generates, uses and can radiate radio frequency energy and, if not installed and used in accordance with the instructions, may cause harmful interference to radio communications. However, there is no guarantee that interference will not occur in a particular installation.

If this equipment does cause harmful interference to radio or television reception, which can be determined by turning the equipment off and on, the user is encouraged to try to correct the interference by one or more of the following measures:

- Re-orient or relocate the receiving antenna.
- Increase the separation between the equipment and receiver.
- Connect the equipment into an outlet on a circuit different from that to which the receiver is connected.
- Consult the dealer or an experienced radio/TV technician for help.

Limited warranty

Ventilation

IMPORTANT – The unit will become hot when in use. Do not stack multiple units on top of each other. Do not place in an enclosed area such as a bookcase or in a cabinet without sufficient ventilation.

Ensure that small objects do not fall through any ventilation grille. If this happens, switch off immediately, disconnect from the mains supply and contact your dealer for advice.

Positioning

Choose the installation location carefully. Avoid placing it in direct sunlight or close to a source of heat. No naked flame sources, such as lighted candles, should be placed on the unit. Also avoid locations subject to vibration and excessive dust, cold or moisture. The unit can be used in a moderate climate.

This unit must be installed on a sturdy, level surface. Do not place in a sealed area such as a bookcase or in a cabinet. Do not place the unit on an unstable surface or shelf. The unit may fall, causing serious injury to a child or adult as well as serious damage to the product. Do not place other equipment on top of the unit.

Due to stray magnetic fields, turntables or CRT TVs should not be located nearby due to possible interference.

Electronic audio components have a running in period of around a week (if used several hours per day). This will allow the new components to settle down and the sonic properties will improve over this time.

Power sources

The unit should be operated only from the type of power source indicated on the marking label. If you are not sure of the type of power-supply to your home, consult your product dealer or local power company.

To turn the unit off, unplug it from the mains socket.

Overloading

Do not overload wall outlets or extension cords as this can result in a risk of fire or electric shock. Overloaded AC outlets, extension cords, frayed power cords, damaged or cracked wire insulation and broken plugs are dangerous. They may result in a shock or fire hazard.

Be sure to insert each power cord securely. To prevent hum and noise, do not bundle the interconnect leads with the power cord or speaker leads.

Cleaning

To clean the unit, wipe its case with a dry, lint-free cloth. Do not use any cleaning fluids containing alcohol, ammonia or abrasives. Do not spray an aerosol at or near the unit.

Battery disposal

Please dispose of any discharged batteries according to local environmental/electronic waste disposal guidelines.

Loudspeakers

Before making any connections to loudspeakers, make sure all power is turned off and only use suitable interconnects.

Servicing

These units are not user serviceable. Never attempt to repair, disassemble or reconstruct the unit if there seems to be a problem.

A serious electric shock could result if this precautionary measure is ignored. In the event of a problem or failure, please contact your dealer.

Cambridge Audio warrants this product to be free from defects in materials and workmanship (subject to the terms set forth below). Cambridge Audio will repair or replace (at Cambridge Audio's option) this product or any defective parts in this product. Warranty periods may vary from country to country. If in doubt consult your dealer and ensure that you retain proof of purchase.

To obtain warranty service, please contact the Cambridge Audio authorised dealer from which you purchased this product. If your dealer is not equipped to perform the repair of your Cambridge Audio product, it can be returned by your dealer to Cambridge Audio or an authorised Cambridge Audio service agent. You will need to ship this product in either its original packaging or packaging affording an equal degree of protection.

Proof of purchase in the form of a bill of sale or receipted invoice, which is evidence that this product is within the warranty period, must be presented to obtain warranty service.

This Warranty is invalid if (a) the factory-applied serial number has been altered or removed from this product or (b) this product was not purchased from a Cambridge Audio authorised dealer. You may call Cambridge Audio or your local country Cambridge Audio distributor to confirm that you have an unaltered serial number and/or you made a purchase from a Cambridge Audio authorised dealer.

This Warranty does not cover cosmetic damage or damage due to acts of God, accident, misuse, abuse, negligence, commercial use, or modification of, or to any part of, the product. This Warranty does not cover damage due to improper operation, maintenance or installation, or attempted repair by anyone other than Cambridge Audio or a Cambridge Audio dealer, or authorised service agent which is authorised to do Cambridge Audio warranty work. Any unauthorised repairs will void this Warranty. This Warranty does not cover products sold AS IS or WITH ALL FAULTS.

REPAIRS OR REPLACEMENTS AS PROVIDED UNDER THIS WARRANTY ARE THE EXCLUSIVE REMEDY OF THE CONSUMER. CAMBRIDGE AUDIO SHALL NOT BE LIABLE FOR ANY INCIDENTAL OR CONSEQUENTIAL DAMAGES FOR BREACH OF ANY EXPRESS OR IMPLIED WARRANTY IN THIS PRODUCT. EXCEPT TO THE EXTENT PROHIBITED BY LAW, THIS WARRANTY IS EXCLUSIVE AND IN LIEU OF ALL OTHER EXPRESS AND IMPLIED WARRANTIES WHATSOEVER INCLUDING, BUT NOT LIMITED TO, THE WARRANTY OF MERCHANTABILITY AND FITNESS FOR A PRACTICAL PURPOSE.

Some countries and US states do not allow the exclusion or limitation of incidental or consequential damages or implied warranties so the above exclusions may not apply to you. This Warranty gives you specific legal rights, and you may have other statutory rights, which vary from state to state or country to country.

For any service, in or out of warranty, please contact your dealer.

Rear panel

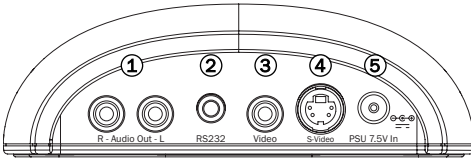

① Stereo Audio Outputs (RCA/Phono)

Connect the iD50 to any suitable amplifier, TV, AV Receiver or stereo system using a stereo audio cable (RCA/Phono to RCA/Phono). Any line level input (which may be labelled CD, Tape, Aux, etc.) is suitable.

② RS232 terminal

For custom installation use, connect the iD50 to an external multi-room control system using a 3.5mm stereo jack to RS232 D9 cable. Please refer to the Cambridge Audio website for full details of the dock control protocol.

③ Composite Video Out terminal

To use the iD50's on-screen display, and view video content, connect the iD50 to a TV/monitor using a suitable 75 ohm RCA/Phono cable designed specifically for Composite video.

④ S-Video Out terminal

A higher quality alternative to the Composite connection, connect the iD50 to a TV/monitor using a suitable S-Video cable.

Note: S-Video connectors are polarised and only fit one way up. Carefully rotate the plug until you find the right orientation before inserting.

⑤ 7.5V DC In terminal

Connect the iD50 to the supplied worldwide voltage AC adaptor only.

The supplied adapter may be used worldwide with electricity supply voltages 100V-240V 50/60Hz.

Note: For your convenience, the iD50 is supplied with a combined Stereo RCA/Phono/Composite Video cable. However, for the best quality audio and video output, we recommend upgrading to dedicated interconnects.

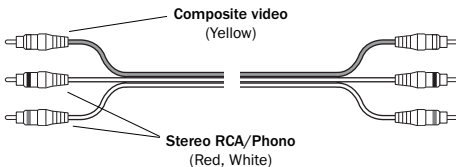

Connections

Ensure all necessary connections from the iD50 are in place before connecting the power supply.

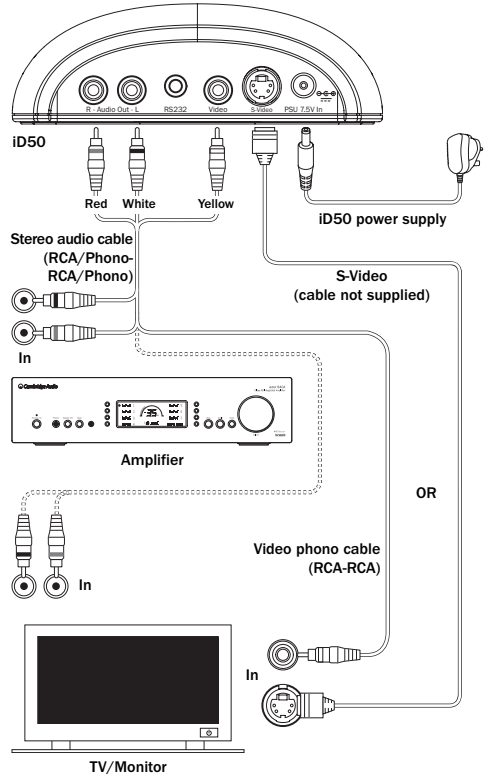

The iD50's audio outputs can be connected to a stereo system or suitable TV with audio inputs and built-in amplification as shown above. For the best quality, we recommend use of a good quality hi-fi separates system.

Note: playback volume is always adjusted via your amplifier or TV as appropriate.

Connections (continued)

Carefully place iPod into the iD50 docking station.

The iD50 is supplied with adaptors for the 3G iPod nano and iPod classic models.

Depending on your type of iPod, you may need to use the alternative docking adaptor that will have been supplied with your iPod. Simply clip this in place as shown below:

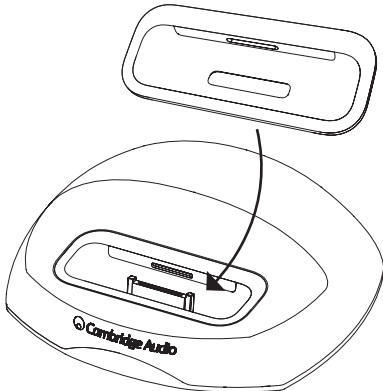

Note: To prevent damaging the dock connector, do not twist the iPod when inserting it or removing it.

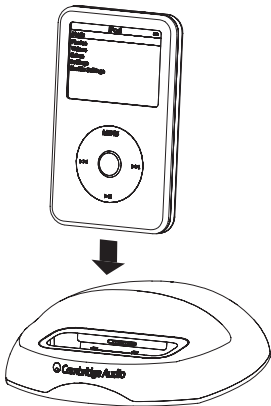

Front panel

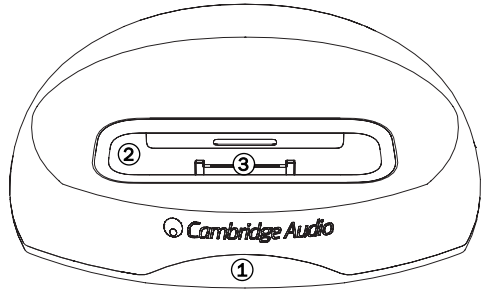

① Remote sensor

Receives IR commands from the supplied remote, an Apple iPod remote or a Cambridge Audio Azur Navigator 'iPod-compatible' remote. A clear and unobstructed line of sight between the remote control and the sensor is required.

② Docking adaptor slot

Fit the required docking adaptor to support your type of iPod (two are supplied, new iPod models also come with a suitable new adaptor).

iPod compatibility

The iD50 is able to communicate with and control the following iPod models:

- iPod nano (1st, 2nd, 3rd and 4th generation)
- iPod (4th generation, photo and 5th generation)
- iPod mini
- iPod classic
- iPod touch (1st and 2nd generation)
- iPhone (flight mode recommended)

③ Dock connector

Gently insert your iPod into the dock. Excessive force may damage the connector.

Remote control

Backlight

Turns the iPod backlight on for about 10 seconds.

Standby/Mode

Pressing this button both brings the dock in and out of Standby and selects the iD50's Simple or Advanced modes for controlling the iPod.

In Standby mode there will be a dim blue LED visible through the front IR window.

Pressing the  button when the dock is in Standby wakes up the iPod and dock (in the mode it was last in). The blue LED visible through the front IR window turns on more brightly.

Pressing the  button again will then toggle the dock back and forth between Simple and Advanced modes.

In Simple Mode the iPod is controllable either by remote control or its own front panel and touch wheel. The iPod's own display is active and can be used to view and select content, etc.

In Advanced Mode, the iPod is instead fully controlled and browsed via the iD50's On-Screen Display (OSD) on a suitable TV. The iPod's own display, front panel and touch wheel are not used. A Cambridge Audio logo and "Ready to Disconnect" appears on the iPod's display and the iD50's OSD becomes active via the video outputs. The blue LED visible through the front IR window is also on brightly in this mode.

Note: the iD50 will take a few seconds to initialise the iPod when entering this mode.

In either mode, to put the iD50 and iPod into Standby simply press and hold the  button on the remote or the *Play/Pause* key on the iPod itself for about three seconds.

Menu

Press to go back to the previous menu. Hold down to return to the Home menu (Advanced Mode only).

Navigate

Navigates up/down through the menus.

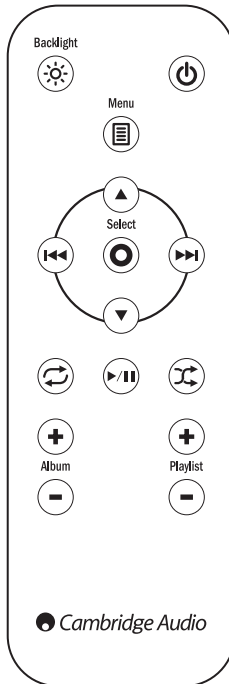

Skip

Press to select previous or next song. Hold down to fast-forward or rewind songs.

Select

Press to select a menu item.

Repeat

Press to cycle through the repeat modes in Simple Mode. In Advanced Mode, the settings menu will be shown on the OSD showing the current status of this function. Press the button again to select a new repeat function.

Play/Pause

Press to play or pause video or audio playback.

Shuffle

Press to select song shuffle in Simple Mode. In Advanced Mode, the settings menu will be shown on the OSD showing the current status of this function. Press the button again to select a new shuffle function.

Album

Simple Mode: Press to select previous or next album.

Advanced Mode: Press to view the previous or next page of the menu (for speedier navigation).

Playlist

Simple Mode only: Press to skip to the next playlist on the iPod (if you have created playlists).

Note: The iD50 is also compatible with Apple's own iPod remote and some Cambridge Audio Azur Navigator remote controls supplied with our products. Currently almost all of the remotes in our Azur range are 'iPod-compatible'.



Please refer to the remote control section of the Azur product's manual for more information.

Operating instructions

Simple Mode

Simple Mode allows you to browse and control your iPod without requiring a television. In this case, the listener simply uses the iPod's own display and front panel/touch wheel or the supplied remote control to navigate the iPod.

Press  on the remote control to toggle between Simple and Advanced modes. In Simple Mode, the dock's blue LED will be bright and you will see the iPod's standard menu appear on its screen.

You can now fully control the iPod using the remote control. Use the Navigator   buttons to highlight either the next or previous item in the current menu.

Press  to choose that item.

Press  to return to the previous menu.

If you wish to use the iD50 for viewing videos or photos on your television and you have a suitable iPod, ensure that Video Out is enabled on your iPod. This is in the Video/Settings menu.

Note: not all iPod models support video playback.

Advanced Mode

Advanced mode allows the user to navigate through the iPod's audio and video content (if your iPod supports video playback) whilst displaying the information on your television.





In Advanced Mode, the dock's blue LED will be bright and you will see the Cambridge Audio logo and "Ready to Disconnect" on the iPod's screen. Toggle between Advanced and Simple modes by pressing .

① Configuring your iD50

The iD50 supports both PAL and NTSC standards. It will have been preset for the TV system in your area.

If you can't see the iD50 menu on your television, or move country and find the image is distorted, it may be a good idea to ensure the dock is in the correct video mode.





To toggle the display mode between PAL and NTSC:



1. Remove the iPod from the dock.
2. Press the four navigator keys one at a time (, , , then .

The dock will shut down and restart in the new video mode.

② Navigation

Your iPod's content is displayed on the TV screen in a simple menu format. It is very similar in layout to the iPod's own user interface.

Use the  and  buttons to move the highlight bar to the desired item. Press  to choose the item. If there are more than eight items in the current menu, you can repeatedly press the  or  buttons until you reach the previous or following page.

Alternatively you can use Album   to jump directly to the next page.

If you wish to return to the previous menu, press the  button.

③ Menus

When the iPod is first inserted, the television will display the following options:

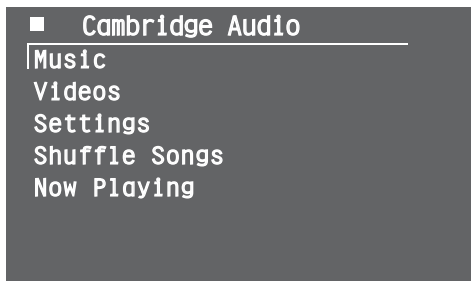

Music

Select to browse the audio content of your iPod.

Videos

This option enters a sub-menu, which contains your iPod's video content. Please note that not all iPod models support this feature.

Settings

Use this option to change the *Shuffle* or *Repeat* settings, configure the video output, or to enable or disable iPod charging. For more information on settings, please see Section Five below.

Shuffle Songs

Selecting this option will instantly play a random selection of your iPod's music.

Now Playing

While the iPod is either playing or paused, you can view the current track, album and playing time by selecting this item.

④ Music Menu

Music is categorised under *Playlists*, *Artists*, *Albums*, *Songs*, *Podcasts*, *Genres* and *Composers*.

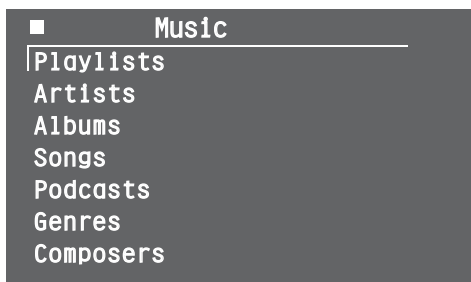

⑤ Videos Menu

The Video menu will only appear if your iPod supports video browsing.

Note: iPod touch does not support this feature.

Entering the Video menu will provide you with a list of categories including, for example, *Movies* and *Video Podcasts*. These categories are organised with iTunes.

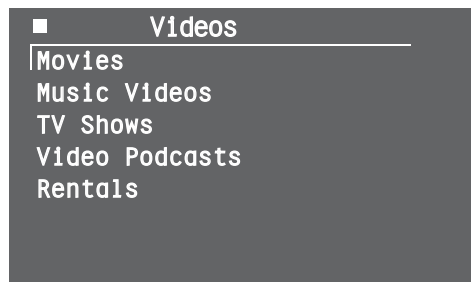

To play a video item, use the Navigator keys to highlight your selection, then press **⊙**. Your video will start playing, and will appear on your television.

To stop playback, simply press the **⊞** button. This will take you back to the previous menu.

If you do not see a picture, please consult the troubleshooting guide.

⑥ Settings Menu

The iD50 can be configured in a number of different ways to allow control of video settings, audio playback modes and charging.

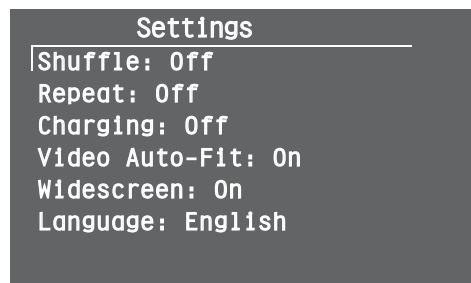

Operating instructions (continued)

Shuffle Mode

Selecting this item allows you to choose any of the following:

Shuffle Tracks (standard shuffle mode – plays songs in the current selection in a random order);

Shuffle Albums (after the current album playing has finished, a random album will be selected and playback will resume);

Shuffle Off (your music selection will play in order).

Repeat Mode

Repeat Tracks (plays each song in the current selection, then starts again);

Repeat One Track (repeatedly plays the selected song);

Repeat Off (no songs are repeated).

Charging

The iD50 docking station also charges the iPod battery while it is in the dock. However, the iPod's battery charging circuit can introduce a little noise to the audio and video outputs. By switching the charging off, the listener is provided with the best possible listening experience.

Note: if the battery is completely flat, the iPod may not respond for a short while.

For more information on battery recharging, please consult your iPod manual.

Video Auto Fit

When this option is selected, the iPod attempts to enlarge the video image to fill the screen so that the top and bottom or left and right edges end at the screen edge without losing any vertical or horizontal image information.

Depending on the iPod media and aspect ratio of the screen as selected below, this may still result in adding either letterbox black bars at the top and bottom of the screen or pillarbox black bars at the left and right of the screen.

Widescreen Mode

Use this mode when your video monitor/TV has a horizontal-to-vertical aspect ratio of 16:9 (widescreen) rather than 4:3 (normal). This setting tells the iPod that your TV is widescreen so that it can make the best choice of video mode. Depending on the media source format and this screen configuration preference, the media content may be displayed in full widescreen fitting the screen, or have pillarbox bars as described above.

Language Settings

Use to select between various different languages for the iD50's On-Screen Display.

Technical specifications

THD	< 0.005% @ 1kHz
S/N	< -75dB @ 1kHz
Output level	1.7-2.0V rms nominal
Standby power consumption	<1.3W idle
Maximum power consumption	2.5W in operation and charging at maximum rate

Inputs/Outputs

Power adaptor input	100-240V ~ 50/60Hz
Power adaptor output	7.5V DC, 500 mA
Composite video output	x 1
S-Video out	x 1
RS232	x 1
	Tip: TX from dock, Ring: RX to dock, Screen: Ground
	9600 BAUD, No check bit,
	1 Stop Bit, No RTS/CTS or XON/XOFF required
	See website for command protocol.

Remote control

Battery	Coin Cell type: V3, CR2032 or equivalent
----------------	--

Troubleshooting

There is no video on the TV

Check if the iD50 is in Advanced Mode.

Check if your iPod is correctly docked in the iD50.

Check if your iPod is playing a video rather than an audio track.

Check if your TV/receiver is turned on and that the right input source and type (composite or S-video) is selected.

Check if the video cable and DC adaptor are firmly and correctly connected.

The iD50 supports both PAL and NTSC standards and will have been preset for the TV system in your area. However, if there is no picture, check that the PAL/NTSC setting is correct (see the Advanced Mode operation section in this manual).

There is no sound from my Stereo system

Check if your iPod is correctly docked in the iD50.

Check if your iPod is playing.

Check if your TV/receiver is turned on, the right input source is selected and the volume is turned up.

Check if the video and audio cables and DC adaptor are firmly and correctly connected.

The docking station does not charge the iPod's battery

Check charging is enabled in the On Screen Display.

Check if your iPod is correctly docked in the iD50.

Check the AC/DC power adaptor is firmly plugged into the dock and the mains power socket outlet.

The remote control does not function

For the remote control to work as intended with your iPod, the iPod must be running the most updated Apple software. If you need to upgrade, simply visit the Apple iPod website and follow the instructions there for a free download. Go to: <http://www.apple.com/iPod/download/>

If it still does not work, please unplug the power cable for one minute, then plug it back in (this resets the system).

Check if your iPod is correctly docked in the iD50.

Try the remote from different locations and see if it works. Strong fluorescent lighting or other room conditions may cause the problem. Make sure nothing blocks the infra-red (IR) signal path between the remote and the iD50.

Check that the remote control's battery is correctly inserted and has not expired.

For more frequently asked questions (FAQs), technical advice and information on getting the most out of your iD50, please visit the Support section on Cambridge Audio's website: www.cambridgeaudio.com/support.php

For all servicing, in or out of warranty, please contact your dealer.

Cambridge Audio is a brand of Audio Partnership Plc
Registered Office: Gallery Court, Hankey Place,
London SE1 4BB, United Kingdom
Registered in England No. 2953313

www.cambridge-audio.com



© 2008 Cambridge Audio Ltd

Free Manuals Download Website

<http://myh66.com>

<http://usermanuals.us>

<http://www.somanuals.com>

<http://www.4manuals.cc>

<http://www.manual-lib.com>

<http://www.404manual.com>

<http://www.luxmanual.com>

<http://aubethermostatmanual.com>

Golf course search by state

<http://golfingnear.com>

Email search by domain

<http://emailbydomain.com>

Auto manuals search

<http://auto.somanuals.com>

TV manuals search

<http://tv.somanuals.com>