

Important Usage Instructions

E

WARNING:

TO REDUCE THE RISK OF FIRE OR ELECTRIC SHOCK, DO NOT EXPOSE THIS PRODUCT TO RAIN OR MOISTURE.

WARNING:

Introduction

Digital Video Camcorder, OPTURA200 MC systems

This device complies with Part 15 of the FCC Rules. Operation is subject to the following two conditions:

(1) This device may not cause harmful interference, and (2) this device must accept any interference received, including interference that may cause undesired operation.

Note: This equipment has been tested and found to comply with the limits for class B digital device, pursuant to Part 15 of the FCC Rules. These limits are designed to provide reasonable protection against harmful interference in a residential installation. This equipment generates, uses and can radiate radio frequency energy and, if not installed and use in accordance with the instructions, may cause harmful interference to radio communications. However, there is no guarantee that interference will not occur in a particular installation. If this equipment does cause harmful interference to radio or television reception, which can be determined by turning the equipment off and on, the user is encouraged to try to correct the interference by one or more of the following measures:

- Reorient or relocate the receiving antenna.
- Increase the separation between the equipment and receiver.
- Connect the equipment into an outlet on a circuit different from that to which the receiver is connected.
- Consult the dealer or an experienced radio/TV technician for help.

Use of shielded cable is required to comply with class B limits in Subpart B of Part 15 of FCC Rules.

Do not make any changes or modifications to the equipment unless otherwise specified in the manual.

If such changes or modifications should be made, you could be required to stop operation of the equipment.

Canon U.S.A. Inc.

One Canon Plaza, Lake Success, NY 11042, U.S.A.

Tel No. (516)328-5600

IMPORTANT SAFETY INSTRUCTIONS

In these safety instructions the word “product” refers to the Canon Digital Video Camcorder OPTURA200 MC A and all its accessories.

1. Read Instructions — All the safety and operating instructions should be read before the product is operated.
2. Retain Instructions — The safety and operating instructions should be retained for future reference.
3. Heed Warnings — All warnings on the product and in the operating instructions should be adhered to.
4. Follow Instructions — All operating and maintenance instructions should be followed.
5. Cleaning — Unplug this product from the wall outlet before cleaning. Do not use liquid or aerosol cleaners. The product should be cleaned only as recommended in this manual.
6. Accessories — Do not use accessories not recommended in this manual as they may be hazardous.
7. Avoid magnetic or electric fields — Do not use the camera close to TV transmitters, portable communication devices or other sources of electric or magnetic radiation. They may cause picture interference, or permanently damage the camera.
8. Water and Moisture — Hazard of electric shock — Do not use this product near water or in rainy/moist situations.
9. Placing or Moving — Do not place on an unstable cart, stand, tripod, bracket or table. The product may fall, causing serious injury to a child or adult, and serious damage to the product.
10. Power Sources — The CA-560 Compact Power Adapter should be operated only from the type of power source indicated on the marking label. If you are not sure of the type of power supply to your home, consult your product dealer or local power company. Regarding other power sources such as battery power, refer to instructions in this manual.
11. Polarization — The CA-560 Compact Power Adapter is equipped with a polarized 2-prong plug (a plug having one blade wider than the other). The 2-prong polarized plug will fit into the power outlet only one way. This is a safety feature. If you are unable to insert the plug fully into the outlet, try reversing the plug. If the plug still fails to fit, contact your electrician to replace your obsolete outlet. Do not defeat the safety purpose of the polarized plug.
12. Power Cord Protection — Power cords should be routed so that they are not likely to be walked on or pinched by items placed upon or against them. Pay particular attention to plugs and the point from which the cords exit the product.
13. Outdoor Antenna Grounding — If an outside antenna is connected to the product, be sure the antenna is grounded so as to provide some protection against voltage surges and built-up static charges. Section 810 of the National Electrical Code, ANSI / NFPA No. 70—1984, provides information with respect to proper grounding of the mast and supporting structure, grounding of the lead-in wire to an antenna discharge unit, size of grounding conductors, location of antenna discharge unit, connection to grounding electrodes, and requirements for the grounding electrode. See figure 1.

A product and cart combination should be moved with care. Quick stops, excessive force, and uneven surfaces may cause the product and cart combination to overturn.



Fig. 1

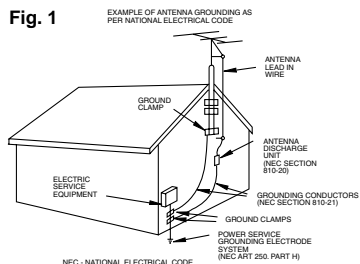

14. **Lightning** — For added protection of this product during a lightning storm, or when it is left unattended and unused for long periods of time, disconnect it from the wall outlet and disconnect the antenna. This will prevent damage to the product due to lightning and power-line surges.
15. **Overloading** — Do not overload wall outlets and extension cords as this can result in a risk of fire or electric shock.
16. **Objects and Liquid Entry** — Never push objects of any kind into this product through openings as they may touch dangerous voltage points or short out parts that could result in a fire or electric shock. Be careful not to spill liquid of any kind onto the product.
17. **Servicing** — Do not attempt to service this product yourself as opening or removing covers may expose you to dangerous voltage or other hazards. Refer all servicing to qualified service personnel.
18. **Damage Requiring Service** — Disconnect this product from the wall outlet and all power sources including battery, and refer servicing to qualified service personnel under the following conditions:
 - a. When the power-supply cord or plug is damaged.
 - b. If any liquid has been spilled onto, or objects have fallen into, the product.
 - c. If the product has been exposed to rain or water.
 - d. If the product does not operate normally even if you follow the operating instructions. Adjust only those controls that are covered by the operation instructions. Improper adjustment of other controls may result in damage and will often require extensive work by a qualified technician to restore the product to its normal operation.
 - e. If the product has been dropped or the cabinet has been damaged.
 - f. When the product exhibits a distinct change in performance. This indicates a need for service.
19. **Replacement Parts** — When replacement parts are required, be sure the service technician has used replacement parts that are specified by Canon or that have the same characteristics as the original part. Unauthorized substitutions may result in fire, electric shock or other hazards.
20. **Safety Check** — Upon completion of any service or repairs to this product, ask the service technician to perform safety checks to determine that the product is in safe operating order.

When replacement of power supply is required, please return it to the responsible nearest Canon Service Center and please replace it with the same type number CA-560 or equivalent.

The Adapter can be used with a power supply between 100 and 240 V AC. For areas where 120 V AC power is not used, you will need a special plug adapter. Contact your nearest Canon Service Center for further information.

Reference Guide

E

Three manuals are supplied with your camcorder: the “Digital Video Camcorder OPTURA200 MC Instruction Manual”, “DIGITAL VIDEO SOLUTION DISK Software Instruction Manual”, and the “DV NETWORK SOLUTION DISK Software Instruction Manual”.

■ Digital Video Camcorder OPTURA200 MC Instruction Manual

This manual explains the camcorder operations such as recording and playing back still images and movies on a tape or a memory card.

■ DIGITAL VIDEO SOLUTION DISK Software Instruction Manual

This manual explains how to download still images and movies from the memory card to a computer by using the supplied USB cable. You can also add sample images for the card mix function, or the “my camera” settings to the camcorder.

Windows XP Only

■ DV NETWORK SOLUTION DISK Software Instruction Manual

This manual explains how to download still images and movies from the memory card to a computer by using the DV (IEEE1394) cable. You can also perform videoconference and file transfer over the Internet using Windows XP’s Windows Messenger. There are several requirements for using this software. For details, please refer to this instruction manual.

Introduction

Trademark Acknowledgements

- Canon is a registered trademark of Canon Inc.
- ArcSoft is a trademark or registered trademarks of ArcSoft, Inc.
- Macintosh is a trademark of Apple Computer Inc., registered in the United States and other countries.
- Windows® is either a registered trademark or trademark of Microsoft Corporation in the United States and/or other countries.
- Other names and products not mentioned above may be registered trademarks or trademarks of their respective companies.

Contents

E

Introduction

Important Usage Instructions	2
IMPORTANT SAFETY	
INSTRUCTIONS	3
Reference Guide.....	5
Thank you for Choosing a Canon	8
Introducing the OPTURA200 MC	9

Mastering the Basics

Finding Your Way Around the OPTURA200 MC	10
---	----

Preparations

Powering Your Camcorder	13
Loading a Cassette.....	18

Basic Recording

Basic Recording	20
Zooming	25
Using the LCD Screen.....	27
Tips for Making Better Videos	30

Basic Playback

Playing Back a Tape	32
Connections for Playback on a TV Screen	36

Using the Full Range of Features

General

Searching and Reviewing While Recording	39
Using the Menu	40
Using the Wireless Controller	50

Recording

Setting the Date and Time	53
Recording Still Images onto a Tape	56
Using the Built-in flash	58

Turning the Image Stabilizer Off	60
Using the Various Recording Programs	61
Using Digital Effects	65
Using the Multi-Image Screen	71
Audio Recording	73
Setting the Self-Timer.....	75

Manual Adjustments

Adjusting Exposure Manually	77
Setting the Shutter Speed	79
Adjusting Focus Manually.....	81
Setting the White Balance	83

Playback

Enlarging the Image during Playback ..	85
Displaying Date, Time and Camcorder Data (Data Code).....	86
Searching the Tape (Photo Search/ Date Search)	89
Returning to a Pre-Marked Position	90

Editing

Editing to a VCR	91
Dubbing to/from a Tape with Digital Video Equipment.....	92
Recording from a VCR, TV or Analog Camcorder (Analog Line-in).....	94
Digitally outputting analog video and audio signals (Analog-Digital Converter)	96
Recording Over Existing Scenes (AV Insert Editing)	98
Audio Dubbing	101
Setting the Audio Mix	104
Connecting to a PC Using a DV Cable.....	106

Introduction

Using a Memory Card

Memory Card Introduction	107
Recording Still Images onto a Memory Card	112
Recording Still Images from a tape	115
Recording Still Images from Other Devices (VCR, TV or Other Digital Camcorders)	116
Recording Movies onto a Memory Card	117
Recording Movies from a Tape	118
Recording Movies from Other Devices (VCR, TV or Other Digital Camcorders)	119
Recording Panoramic Images (Stitch Assist)	120
Playing Back a Memory Card	122
Settings of the Still Images/Movies	125
Preventing Accidental Erasure (Protect)	128
Marking a Still Image for Printing (Print Mark).....	129
Erasing Still Images	131
Using Printers Supporting the Direct Print Function (Optional)	133

Combining Images (Card Mix)	142
Copying Still Images from Tape to Memory Card	147
Copying Still Images from Memory Card to Tape	148
Formatting a Memory Card	149
Connecting to a PC Using a USB Cable	150
Other Information and Precautions....	153

Additional Information

Preparing the Camcorder	156
Notes on Using the Batteries	158
Maintenance	161
Troubleshooting	165
The OPTURA200 MC System Diagram	169
Optional Accessories	170
Screen Displays.....	173
Specifications	183
Index	185
Menu at a Glance	187

Symbols Used in this Instruction Manual

: Reference page numbers

: Functions that can be operated from the body of the camcorder

: Functions that can be operated from the wireless controller

: Supplementary notes for camcorder operation

: Operation confirmation beeps ( 24)

- Capital letters are used to refer to settings displayed in the menus and buttons labeled on the camcorder itself, e.g. Press the MENU button.

The serial number of this product may be found on the bottom of the camcorder. No others have the same serial number as yours. You should record the number and other vital information here and retain this book as a permanent record of your purchase to aid identification in case of theft.

Date of Purchase
Dealer Purchased From
Dealer Address
Dealer Phone No.
Model Name OPTURA200 MC
Serial No.

Thank You for Choosing a Canon

E







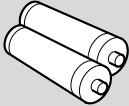

First, we'd like to thank you for purchasing this Canon camcorder. Its advanced technology makes it very easy to use — you will soon be making high-quality videos which will give you pleasure for years to come.

To get the most out of your new camcorder, we recommend that you read this manual thoroughly — there are many sophisticated features which will add to your recording enjoyment.

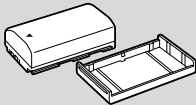
Getting Started

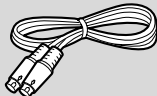
To get started we suggest that you master the basic operations of the camcorder first, before moving on to use its full range of features.

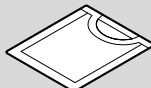
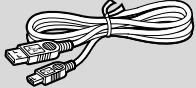
Your camcorder is supplied with the following accessories:

WL-D78 Wireless Controller 	Two AA batteries 
Lens hood 	Lens cap and lens cap cord 
BP-512 Battery Pack 	CA-560 Compact Power Adapter (including power cord) 
Lithium button battery CR1616 	S-150 S-video Cable 
STV-250N Stereo Video Cable 	SDC-8M SD Memory Card (with pre-recorded sample images) 
Soft case for SD Memory Card 	IFC-300PCU USB cable 
Digital Video Solution Disk DV Network Solution Disk ArcSoft Camera Suite CD 	

Introducing the OPTURA200 MC

Mega-pixel CCD

Your camcorder incorporates a mega-pixel CCD. High-resolution still images can be recorded onto a memory card.

Built-in Flash



The built-in flash automatically rises up and fires according to the brightness of the surrounding area.

10× Optical Zoom and 200× (card 40×) Digital Zoom

Optical Image Stabilizer



Canon's optical technology stabilizes your recordings even in long telephoto shots.

Super Night Mode & Night Mode

Allows you to record even in dark places. The Night mode adjusts automatically to the optimum shutter speed, and the Super Night mode utilizes the Super Night LED to record bright colorful pictures.

Still Images



You can record still images like photographs. You can also shoot continuously still images and record them onto a memory card.

Memory Card

You can record still images and movies onto a SD Memory Card or MultiMediaCard. Transfer still images/movies to your PC and use the supplied software to edit or attach them to your e-mail, or merge separate still image into one large panoramic scene.

Direct Printing

You can print still images by connecting the camcorder to a printer supporting the Direct Print function.

My Camera Function

You can customize the start up image and shutter sound of the camcorder.

USB Terminal

Allows high-speed transfer of memory card data to a PC with a built-in USB port. You can organize and edit still images/movies on your PC using the supplied software.

IEEE 1394 DV Terminal

The DV terminal allows high-quality transfer with virtually no deterioration in quality of images. You can edit and process images by connecting the camcorder to a PC with the IEEE 1394 terminal.

Analog Line-in Recording

Audio Dubbing/AV Insert Editing

Digital Effects



Show your creativity by using the special effects and digital faders. These digital effects and faders can add visual appeal and greater imaging variety. The multi-image screen captures moving subjects in 4, 9 or 16 sequences of still images.

Finding Your Way Around the OPTURA200 MC

E

Mastering
the Basics

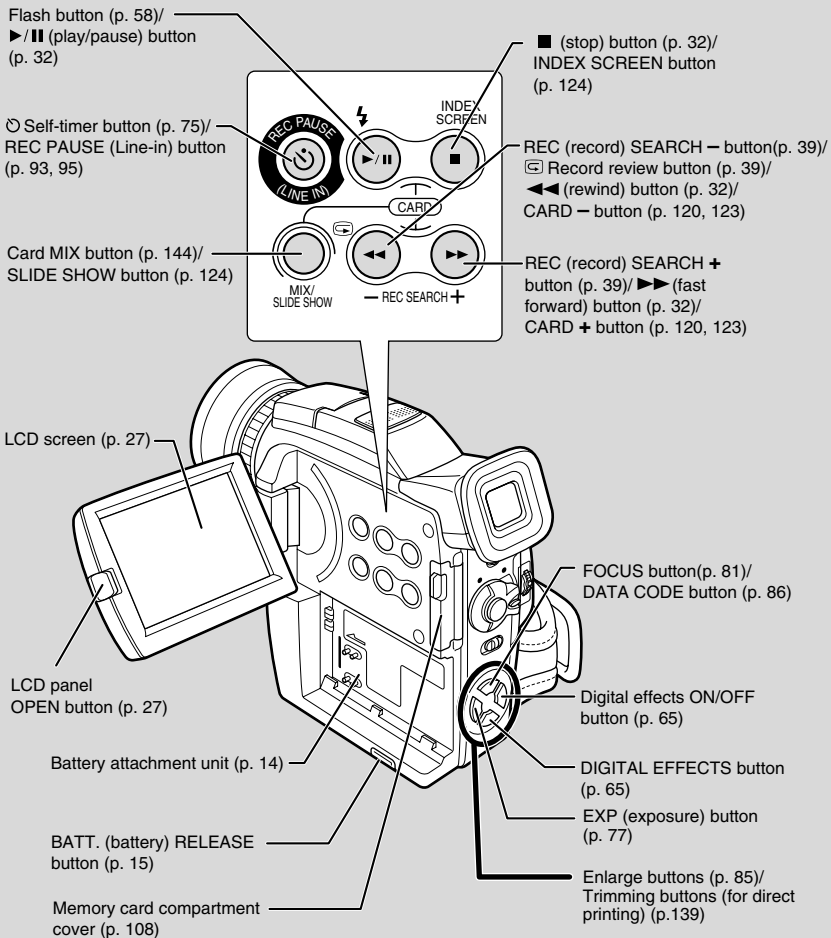

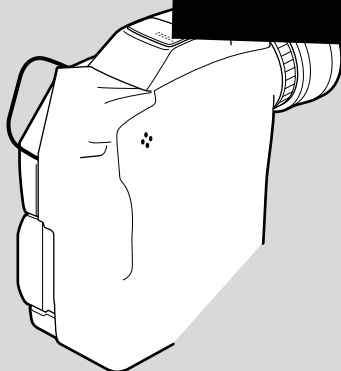

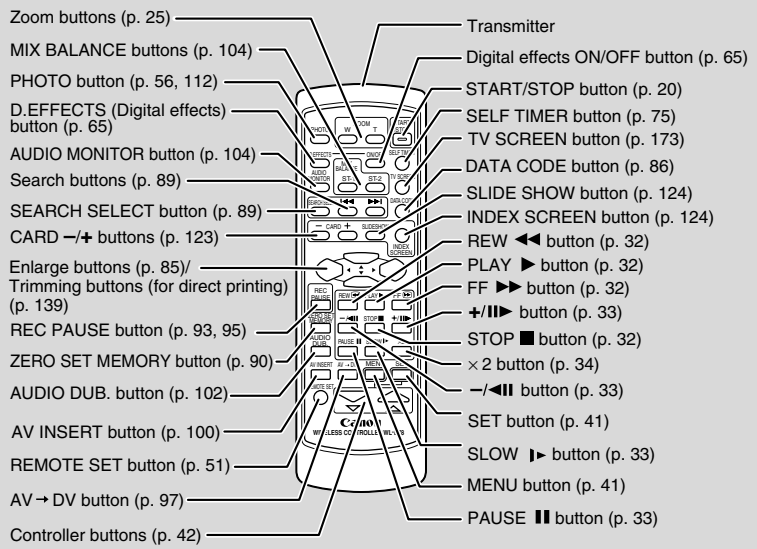
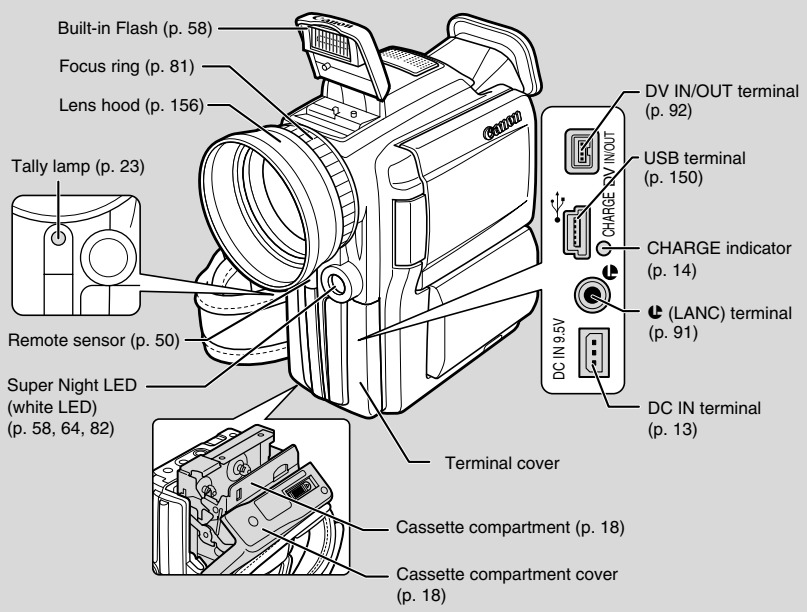

Powering Your Camcorder

Before operating your camcorder, you will need to use the power adapter to:

Provide power from a household power socket

or

Charge a battery pack



Notes:

- The power adapter converts current from a household power socket (100–240 V AC, 50/60 Hz) to the DC current used by your camcorder.
- If the adapter is used next to a TV, it may cause bars to appear on the TV — move the adapter away from the TV or the antenna cable.
- Do not connect products not expressly recommended to the camcorder's DC terminal. Likewise, do not connect products not expressly recommended to the power adapter.

Connecting the Camcorder to a Household Power Socket

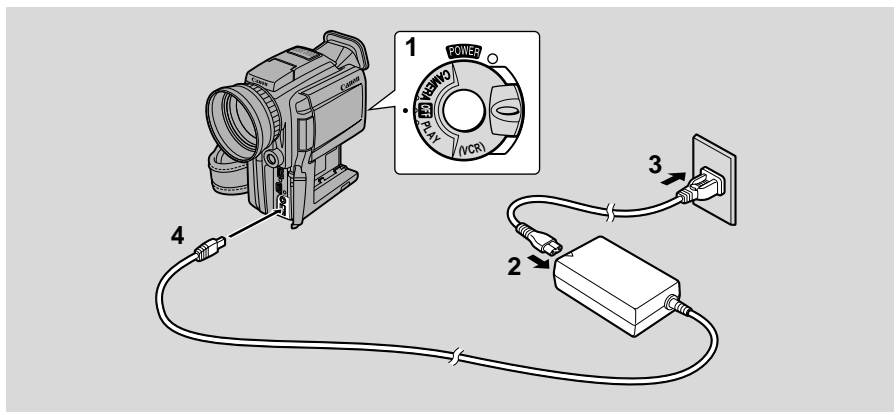

Use the power adapter to provide your camcorder with instant power from a household power socket. Always turn the camcorder off before connecting/removing the power source.

- 1. Set the POWER switch to OFF.**
- 2. Connect the power cord to the power adapter.**
- 3. Plug the power cord into a household power socket.**
- 4. Connect the power adapter to the camcorder's DC IN terminal.**
- 5. Disconnect the power adapter from the camcorder after use. Unplug the power cord from the household power socket, then disconnect it from the adapter.**

Attaching and Charging the Battery Packs

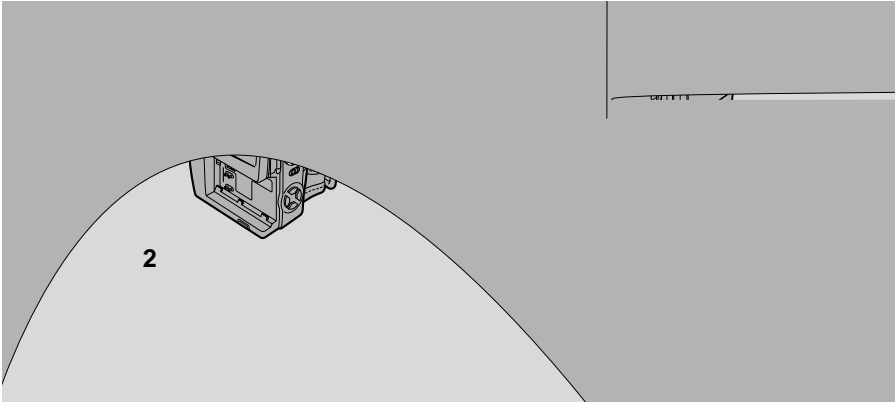

Your battery pack has been partially charged before it left the factory. It should have enough power for you to check that your camcorder is working properly. Charge the battery pack fully if you want it to power the camcorder for more than a few minutes.

Always turn the camcorder off before connecting/removing the battery.

- 1. Set the POWER switch to OFF.**
- 2. Attach the battery to the camcorder.**
 - Remove the battery pack's terminal cover.
 - Align the edge of the battery pack with the line on the camcorder, press lightly and slide it in the direction of the arrow until it clicks into place.
- 3. Connect the power cord to the adapter and plug it into a household power socket.**
- 4. Connect the power adapter to the camcorder.**
 - The charge indicator flashes red to show that charging is in progress. Single flashes mean that the battery pack is less than 50% charged. Double flashes mean that it is more than 50% charged. The indicator glows steadily when the battery pack is fully charged. If the indicator blinks rapidly and continuously (twice a second), the battery pack may be defective.
 - When the CHARGE indicator flashes, the battery pack is being charged even if the POWER switch is set to a position other than OFF.
- 5. When charging is complete, disconnect the power adapter from the camcorder, unplug the power cord, and disconnect the power cord from the adapter.**

6. Remove the battery pack after use.

Press the BATT. RELEASE button and remove the battery.

E



Note:

- You can find details for using the batteries in the “Notes on Using the Batteries” (📖 158). These notes include charging and recording times and how to install the backup battery.

Using the Charge Adapter CR-560 Kit (optional)

The Compact Power Adapter CA-560 supplied with the camcorder can be used along with the CR-560 Kit for 3 different ways to power the camcorder or charge battery packs:

1. Charge the BP-500 Series battery packs with power from your car battery.
2. Operate the camcorder with power from your car battery.
3. Charge the BP-500 Series battery packs from a household power socket.

The Charge Adapter/Car Battery Cable Kit CR-560 includes the following:

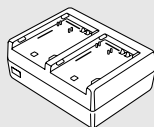

Charge Adapter

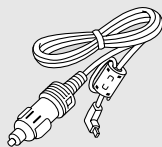

Car Battery Cable

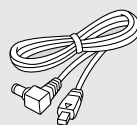

DC Cable

1. Charge the BP-500 Series battery packs with power from your car battery.

1 or 2 battery pack(s) + Charge Adapter + Car Battery Cable → car's cigarette lighter

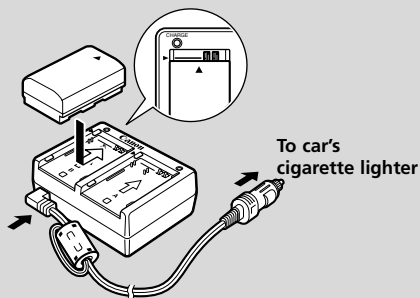

- Fast charging for the high-capacity BP-522 and BP-535 (both optional). 15 minutes of charging gives 60 minutes of recording (using the viewfinder).

	Time required for full charge from car battery or household outlet
BP-512	1 hr. 20 min.
BP-511 (optional)	1 hr. 20 min.
BP-522 (optional)	1 hr. 40 min.
BP-535 (optional)	2 hr. 30 min.

- 2. Operate the camcorder with power from your car battery.**
Camcorder + DC Cable + Charge Adapter + Car Battery Cable → car's cigarette lighter

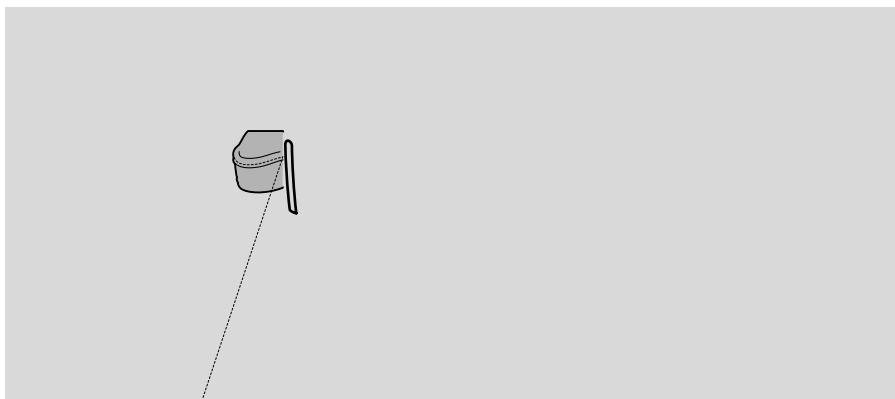

Loading a Cassette

E

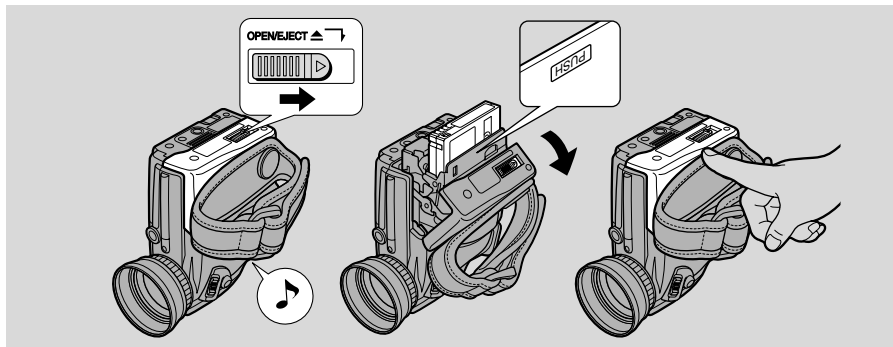



Only use videocassettes marked with the D logo.*

Loading and Unloading

1. **Make sure that you have attached a power source.**
2. **Slide the OPEN/EJECT \blacktriangle switch (on the bottom of the camcorder) to release the cassette compartment cover.**
 - Pull the cover fully open (while holding the button) and wait a couple of seconds for the cassette compartment to open automatically.
 - The confirmation beep sounds when the cassette cover fully opens.
3. **Load or unload the cassette.**
 - Insert the cassette gently with the window facing the grip belt, and the REC/SAVE tab up.
 - Remove the cassette by pulling it straight out.
4. **Press the P mark on the compartment until it clicks, and wait for the compartment to close.**
5. **Click the cover back into place.**

* D is a trade mark.

Notes:

- Do not interfere with the cassette compartment while it is opening or closing automatically, and do not attempt to close the cover until the cassette compartment has fully retracted.
- Be careful not to get your fingers caught in the cassette compartment cover.
- Do not leave the cassette in the camcorder after use — return it to its case and store it in a cool, clean, dry place.
- When you turn the camcorder's power on,  flashes in the display until you load a cassette.
- With some types of tapes, the remaining tape display may not give an accurate reading ( 174).

Protecting Tapes from Accidental Erasure

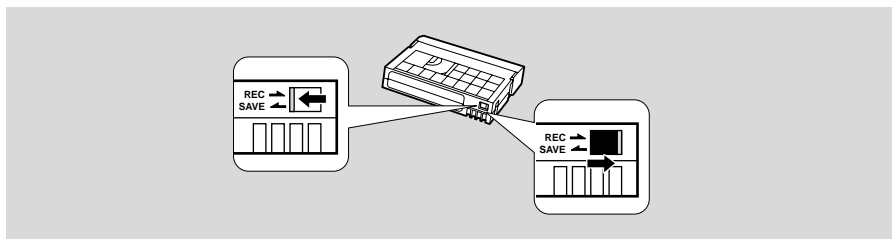

To protect your recording from accidental erasure, slide the tab on the cassette so that it exposes the hole. (This switch position is usually labelled SAVE or ERASE OFF.)

If you load this cassette and put the camcorder in record pause mode (□ 20), "THE TAPE IS SET FOR ERASURE PREVENTION" is displayed for approx. 4 seconds and then the  mark flashes in the display.

If you want to record on the cassette again, slide the tab back so that the hole is closed.

Cassette Handling Precautions

- To protect the tape heads, transfer cassettes directly from the tape case to the camcorder — do not open the tape protect cover or touch the tape itself.
- Do not use cassettes where the tape has been damaged or spliced — they may damage the camcorder.
- Do not insert anything into the small holes on the cassette or cover them with cellophane tape.
- Handle cassettes with care — dropping them or exposing them to external shocks may cause internal damage.
- Store cassettes in the provided case, first rewinding them to the start of the tape and then storing them upright.
- A cassette with metal plated terminals may become dirty with use, affecting information transfer. Therefore, after using a tape about 10 times, be sure to clean the terminals with a cotton swab.

Cassette Memory Function

You are unable to use the cassette memory function with this camcorder.



E

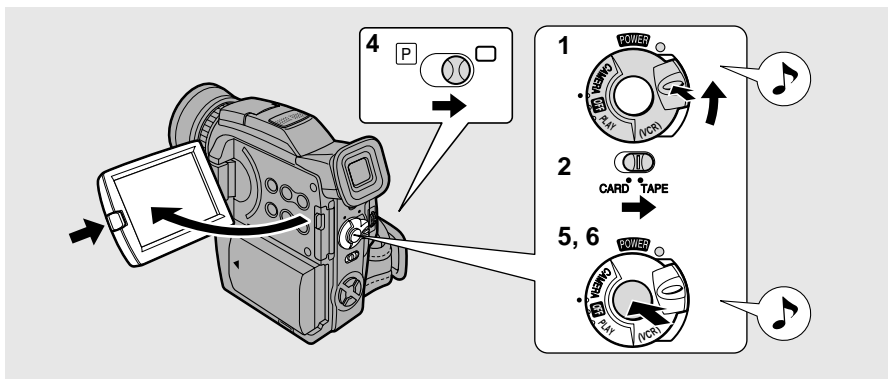

Before You Start Recording

Have you completed the following steps?

- Attaching a power source (13).
- Removing the lens cap (157).
- Fastening the grip belt (157).
- Attaching the lens hood (156).
- Choosing the display: viewfinder (156) or LCD screen (27).

Note:

- When you're using the viewfinder, fully close the LCD or rotate the LCD so that it faces into the same direction as the lens (27).

You may also want to install the backup battery (160) in order to set the date and time display (53).

Recording

1. Press and hold the small button on the POWER switch and turn the POWER switch to CAMERA.

- The camcorder automatically sets to record pause mode. PAUSE appears in the display.
- If you have not set the date and time display, SET THE TIME ZONE, DATE AND TIME appears in the display. For setting the time zone, see p. 53. For setting the date and time, see p. 55.
- The camcorder power indicator lights up.
- The confirmation beep sounds.
- The camcorder will turn itself off if you leave it in record pause mode for more than about 5 minutes. To return to record pause mode, turn the POWER switch to OFF and then back to CAMERA.

- 2. Make sure the TAPE/CARD switch is set to TAPE.**
 - For recording still images onto a memory card, see p.112. For recording movies onto a memory card, see p.117.
- 3. Load a cassette (18).**
 - Start recording when the tape counter has stopped.
- 4. Slide the program selector to .**
 - This selects the camcorder's Easy Recording program. It allows you to simply point and shoot without making any manual adjustments ( 62).
- 5. Press and release the start/stop button once to begin recording.**
 - For still image recording to a cassette, see p. 56.
- 6. Press and release the start/stop button again to pause recording.**
 - The camcorder returns to record pause mode and PAUSE reappears in the display.
 - You can stop and restart recording as often as you like by pressing the start/stop button.

Changing the Recording Mode



You can select between SP (standard play) and LP (long play). LP extends the tape usage by 1.5 times.

It is not possible to dub audio or insert images to a tape that has been recorded in LP mode.

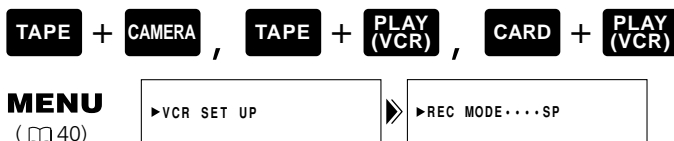

To change to LP mode, open the menu and select VCR SET UP. Then select REC MODE, set it to LP and close the menu.

Notes:

- Depending on the nature and usage condition of the tape, recording/playback in LP mode may cause image or sound distortion. We recommend using the SP mode for important recordings.
- We recommend recording in SP mode when you plan to transfer images taken with the camcorder to your PC.
- If you record in both modes on the same tape, the image may become distorted during playback and the time code may not be written correctly.
- If you play back a tape recorded on another digital equipment on this camcorder, or vice versa, image and sound may become distorted.

16:9 (Wide Screen TV Recording)



Produces images in the 16:9 format for playback on wide screen TVs.

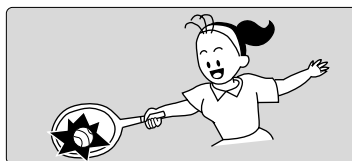

To switch 16:9 to ON, open the menu and select CAM.SET UP. Then select 16:9, set it to ON and close the menu.

Notes:

- "16:9" is shown in the display when you switch the 16:9 mode on.
- You cannot use the 16:9 mode with the Easy Recording program.
- You cannot use the multi-image screen when setting the 16:9 mode on.
- If you play back a recording made for 16:9 on a normal TV screen, the image will appear to be vertically "squashed" (compressed).
- If you connect the camcorder to a TV with an S1 terminal or the Video ID-1 system, recordings made in the 16:9 mode for wide screen TVs will automatically play back in wide screen mode on the TV screen.

Turning Off the Tally Lamp



The tally lamp lets you know that the camcorder is recording, receiving signals from the wireless controller or counting down for the self-timer. However, its flashing may be reflected into the lens during close-up recording, or when recording through glass.

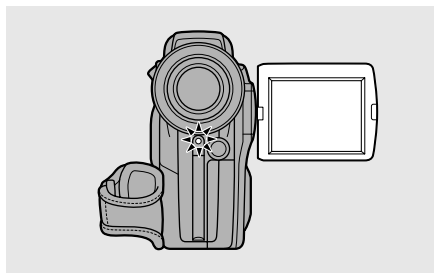

You may therefore decide to turn it off.

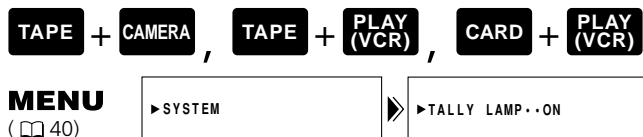

To turn the tally lamp off, open the menu and select SYSTEM. Then select TALLY LAMP, set it to OFF and close the menu.

- The tally lamp no longer flashes during recording, but it will still light up when the camcorder receives a signal from the wireless controller and during the self-timer countdown.

Confirmation/Warning Beeps



The camcorder's short operation confirmation beeps are indicated by  in the illustrations. Beeps sound upon certain camcorder operations such as when you turn the camcorder on, during the self-timer countdown, right before the camcorder's automatic shut-off, and also upon any unusual condition of the camcorder. Beeps are not recorded on the tape.

TAPE + **CAMERA** , **TAPE** + **PLAY (VCR)** , **CARD** + **CAMERA** , **CARD** + **PLAY (VCR)**

MENU

( 40)

▶SYSTEM

▶BEEP.....ON

To turn the beep off, open the menu and select SYSTEM. Then select BEEP, set it to OFF and close the menu.

- All camcorder sounds, including the shutter sound that sounds when recording a still image onto a memory card will be turned off.

Demonstration Mode



You can see a demonstration of the camcorder's main features. To see the demonstration, do either of the following:

- With no cassette or memory card inserted, turn the DEMO MODE on in the TAPE CAMERA menu or CARD CAMERA menu and close the menu.
- Leave the camcorder with no cassette or memory card inserted for five minutes after turning it on.

TAPE + **CAMERA** , **CARD** + **CAMERA**

MENU

( 40)

▶DISP.SET UP

▶DEMO MODE...ON

To turn the demonstration mode off, open the menu and select DISP. SET UP. Then select DEMO MODE, set it to OFF and close the menu.



Note:

- To cancel the demo mode once it has begun: push any button, turn off the power, load a cassette or insert a memory card.

Zooming



E

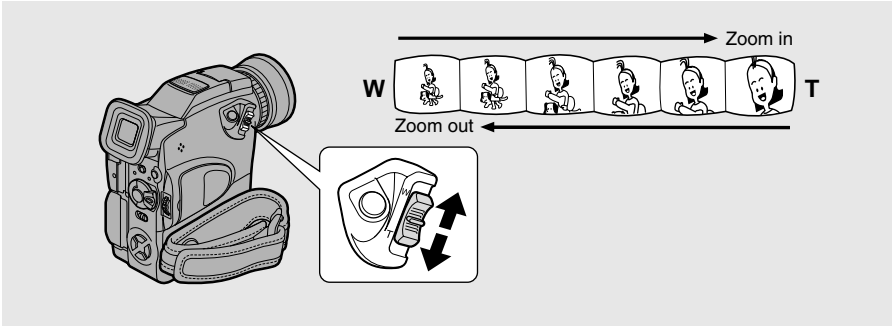

10× Optical Zoom

The camcorder's zoom lens allows you to choose the best picture angle for each scene:

- Move the zoom control towards W to zoom out to wide-angle.
- Move it towards T to zoom in to telephoto.

You can also control the speed of zooming:

- Move the control slightly to zoom slowly.
- Move it farther to zoom more quickly. (The farther you move the zoom control, the faster the zoom speed.)

The T and W buttons on the wireless controller adjust the picture angle, but not the zoom speed.

40×/200× Digital Zoom (Card 40×)

Magnifies the camcorder's zoom range by up to 20× in TAPE CAMERA mode. The zoom control continues to work as usual. You can freely zoom in and out between 1× and 200× magnification — the camcorder automatically switches between optical zooming (up to 10×) and digital zooming (10× to 40× or 10× to 200×).

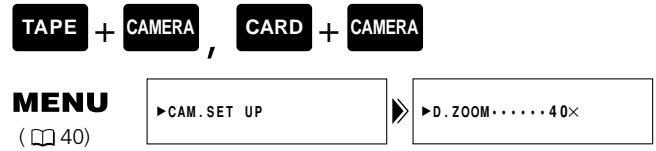

To change the digital zoom, open the menu and select CAM.SET UP. Then select D.ZOOM, set it to OFF or 200× and close the menu.

Mastering
the Basics

**Notes:**

- When zooming, as a rule, keep at least 3 ft $3\frac{3}{8}$ in (1 m) between you and your subject. However when the zoom is at the wide-angle position, you can focus on a subject as close as $\frac{3}{8}$ in (1 cm).
- Image resolution is slightly lower when the magnification is greater than 10 \times .
- You cannot use digital zoom in the Night and Super Night recording program.
- You cannot use digital zoom when the multi-image screen is set. The display becomes “— — —”.
- The zoom indicator appears for 4 seconds. When the digital zoom is set to 40 \times , the zoom indicator extends (light blue). When the digital zoom is set to 200 \times zoom, the zoom indicator extends again (a darker blue).

Using the LCD Screen

Opening and Closing the LCD Screen

Press the LCD panel OPEN button and open the panel by pulling it away from the camcorder. This automatically switches the LCD screen on and the viewfinder off. Close the LCD panel until it clicks securely closed. When you close the LCD panel, the LCD screen automatically switches off and the viewfinder switches back on.

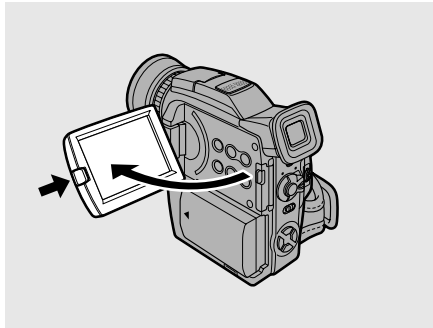

E

Changing the Angle of the LCD Screen

You can choose the angle of the screen that suits you best by opening and rotating the screen. You can also rotate the LCD screen so that it faces in the direction of the lens (📖 29).

You can also push the panel flat against the camcorder until it is flush with the side, with the screen facing outwards.

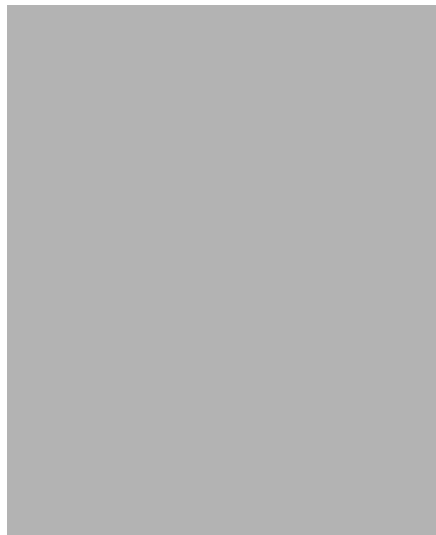

Notes:

- Avoid touching the LCD screen when moving the LCD panel.
- Do not hold the camcorder by the LCD panel or the viewfinder.
- Make sure to open the LCD panel at 90° before attempting to rotate it.
- Always rotate the LCD panel vertically into place before closing it or pushing it flat against the side of the camcorder.
- Always fully close the LCD panel until it clicks securely.
- Be careful not to leave the LCD, viewfinder or lens exposed to direct sunlight outdoors or through a window. Doing so could cause damage.

- Bright light falling on the LCD screen may cause glare that makes it difficult for you to view the image. In this case, switch to using the viewfinder. You can also adjust the brightness of the screen (see “Adjusting the LCD screen” below).

Adjusting the LCD Screen



You can adjust the brightness of the LCD screen.



MENU

(40)

▶ DISP.SET UP

▶▶ BRIGHTNESS... ———+

Open the menu and select DISP.SET UP from the menu. Then select BRIGHTNESS, adjust the level with the selector dial and close the menu.

A bar showing the level appears in the display.

- Turn the selector dial up to make the display brighter.
- Turn the selector dial down to make the display darker.



Notes:

- The camcorder retains your brightness setting even after you turn it off.
- The brightness of the LCD does not affect that of the recorded images or the viewfinder.

About the LCD Screen

The LCD screen built into this camcorder is a high precision product. However, small black dots or bright points of light (red, blue or green) may appear constantly on the LCD screen. This is not a malfunction of the LCD screen and they are not recorded. (Effective dots: more than 99.99%)

Allowing the Subject to Monitor Recording



E

When you turn the LCD panel so that it faces to the same direction as the lens, you can watch yourself during recording or let your subject monitor recording. The viewfinder is also activated when the panel is in this position. (“Adjusting the Viewfinder” [156](#))

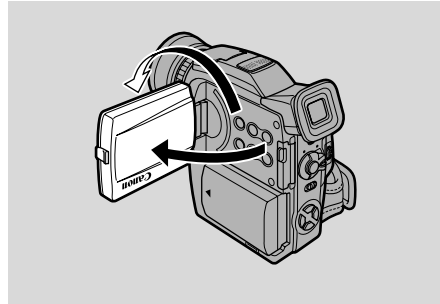

- You can choose the display style, reversed (mirror on) or not (mirror off). The recording itself is unaffected regardless of which one you choose.

TAPE + **CAMERA** , **CARD** + **CAMERA**

MENU
([40](#))



To turn the mirror mode off, open the menu and select DISP.SET UP. Then select LCD MIRROR, set it to OFF and close the menu.

The indicators that appear on the LCD screen when LCD MIRROR is turned on:

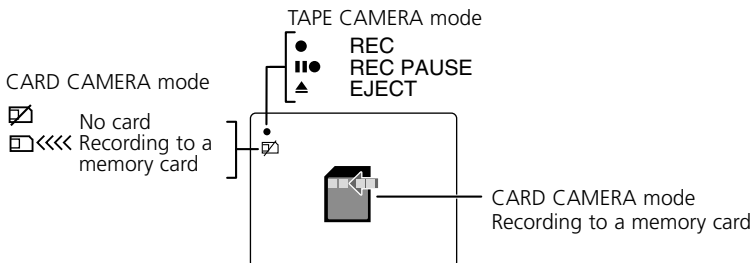

Tips for Making Better Videos

E

Holding the camcorder

For maximum stability, grip the camcorder in your right hand and keep your right elbow pressed against your body.

If necessary support the camcorder with your left hand. With practice, you will be able to operate the controls by touch, without taking your eye off the action.

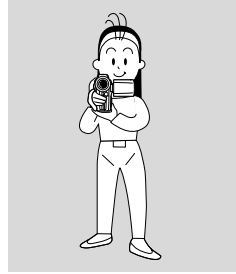

Using a Tripod

To prevent any unwanted movement, you can mount the camcorder on a tripod, (or any flat surface at a suitable height) and operate it with the wireless controller.

- When you are using a tripod, be careful not to leave the viewfinder exposed to bright sunlight as it may melt. (The light is concentrated by the viewfinder lens.)
- Make sure that the fastening screw of the tripod is no longer than 1/4 inch (5.5 mm), as it will damage the camcorder.

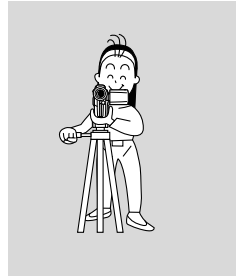

Composition

The most important element in the scene does not have to be in the center. For a more interesting picture, try to position your subject slightly to one side. Leave some space on the side of the frame that the subject is facing or moving towards.

Do not cut off the top of the subject's head, and do not cut people off at the neck, hips or knees (move a little bit above or below).

Watch out for distracting objects in the background.

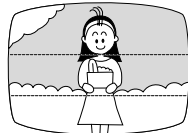

Picture Angle

Instead of zooming while recording, try to choose your picture angle before you begin. A good way to tell a story with video is to begin with a long shot that establishes the situation, and then move in with medium shots and close-ups to show the details. Remember to change your viewpoint for each shot.



Long shot



Medium shot



Close-up

Remember that any camcorder movement or change in picture angle should have a definite purpose. Avoid unnecessary or half-hearted movements.

Camcorder Moves

Use pans to record a landscape or follow a moving subject. Decide the area you want to cover and stand facing the end of your panning angle. Without moving your feet, turn your waist to the starting position. Start recording, and after a few seconds begin to turn slowly from the waist. Hold the final image for a few seconds before you stop recording.

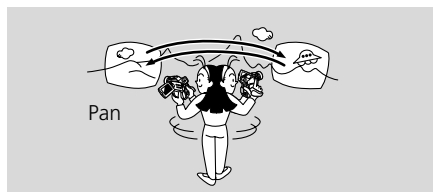

Tilt the camcorder up to exaggerate the height of the subject. Tilt down from the top of a building, for example, as an introduction to subjects at the bottom.

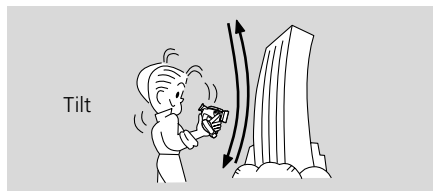



E

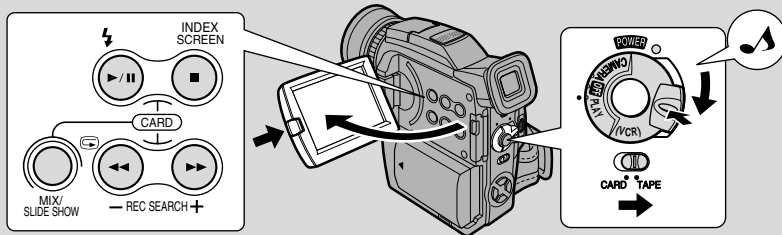

You can use the LCD screen for instant, on-the-spot playback. The camcorder also plays back the sound track via the built-in speaker (35).

- When you play back a tape, you can also close the LCD panel with its screen side facing outward.
- When you wish to use the viewfinder to view playback, close the LCD panel. The built-in speaker does not sound. Use headphones to monitor the sound.

For playing back your recordings on a TV, see p. 36.

For using the wireless controller, see p. 50.



Note:

- To avoid accidental recording, slide the tab on the cassette so that it exposes the hole (the switch position is usually labelled SAVE or ERASE OFF).

1. Attach a power source and turn the POWER switch to PLAY (VCR).

- The power indicator lights up.

2. Make sure the TAPE/CARD switch is set to TAPE.

3. Load the cassette.

4. Press the ► (play) button to start playback.

- To end playback, press the ■ (stop) button.
- To wind the tape forwards, stop playback and press the ►► (fast forward) button.
- To wind the tape backwards, stop playback and press the ◀◀ (rewind) button.
- If the playback picture is rough (mosaic-like noise), clean the video heads using a Canon DVM-CL Digital Video Head Cleaning Cassette or a commercially available digital video head cleaning cassette.

Other Playback Modes



E

Playback Pause

Press the **||** (pause) button. To resume normal playback, press it again, or press the **▶** (play) button. The camcorder automatically goes into stop mode after about 5 minutes' playback pause.

Fast Forward Playback

To play back the recording at about 9.5 times normal speed, press and hold the **▶▶** (fast forward) button during normal playback or press and hold the **▶▶** (fast forward) button during normal fast forward.

Rewind Playback

For reverse playback at about 9.5 times normal speed, press and hold the **◀◀** (rewind) button during normal playback or press and hold the **◀◀** (rewind) button during normal rewind.

Special Playback



Frame Advance

To play back frame by frame, press the **+ / ||▶** button repeatedly during playback pause.

Press and hold to play back continuous frame advance.

Frame Reverse

To play back in reverse frame by frame, press the **- / ◀||** button repeatedly during playback pause.

Press and hold to play back continuous frame reverse.

Slow Forward Playback

To play back at about 1/3 normal speed, press the SLOW M button during normal playback.

Press the PLAY **▶** button to return to normal playback.

Slow Reverse Playback

To play back in reverse at about 1/3 normal speed, press the **- / ◀||** button and then the SLOW M button during normal playback.

Press the PLAY **▶** button to return to normal playback.

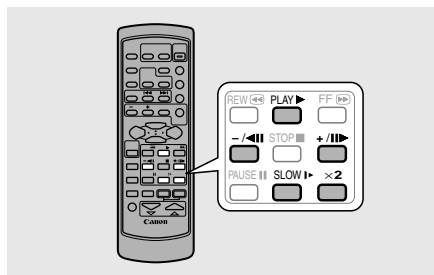

Reverse Playback

To play back in reverse at normal speed, press the  button during normal forward playback.

Press the PLAY  button to return to normal forward playback.

- The camcorder automatically goes into stop mode after about 2 minutes of paused reverse playback.

Forward ×2 Playback

Press the ×2 button during normal playback.

Press the PLAY  button to return to normal playback.

Reverse ×2 Playback

Press the  button and then the ×2 button during normal playback.

Press the PLAY  button to return to normal playback.



Notes:

- Mosaic-like noise appears on the screen during some of the special playback modes.
- There is no audio during special playback.

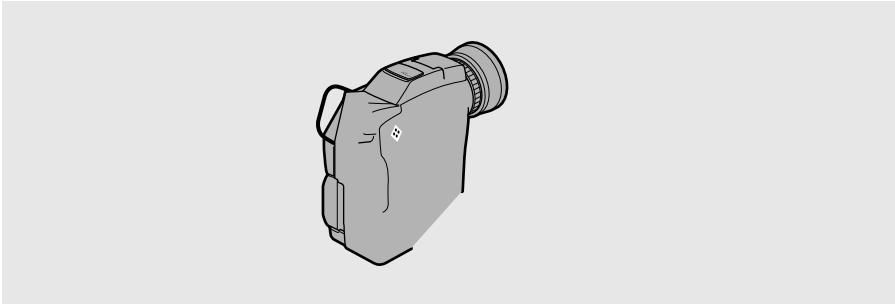

Adjust the speaker volume with the selector dial.

- Pull the selector dial up to increase the volume, and down to lower the volume.
- A bar appears in the display to indicate the current volume. It disappears in 4 seconds.
- You can turn off the volume completely by pulling the selector dial down until OFF appears.

 **Notes:**

- Sometimes audio may sound distorted when the volume is turned up high. If this happens, turn down the volume.
- The speaker does not sound if PHONES is displayed. Set AV/headphones to AV ( 36).

Connections for Playback on a TV Screen

E

You can connect the camcorder to a TV or VCR in order to play back your recordings. You will need to attach a power source to the camcorder (13). Power off all devices before starting the connections.

See your TV or VCR instruction manual for further details.

Switching the AV/Headphone Terminal

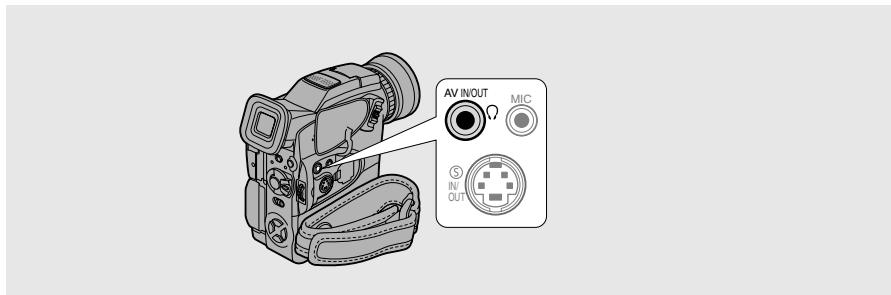

Mastering
the Basics

Through the menu, the camcorder's AV/headphone terminal can be switched to function as either the AV terminal or the headphone terminal.



MENU
(40)

▶ VCR SET UP

▶▶ AV / PHONES...AV

Open the menu and select VCR SET UP. Then select AV/PHONES and set it to AV or PHONES and close the menu.

- When the terminal is switched to PHONES, PHONES appears in the display.

Using the headphones

- Make sure you switch the AV/headphones terminal to PHONES before using headphones. If the AV/headphones terminal is not switched to PHONES before you use the headphones, noise will come out from the headphones.



- Use the S-150 S-video Cable to connect the S-video terminals. Use the STV-250N Stereo Video Cable to connect the AUDIO terminals. Connect the white plug to the white AUDIO terminal **L** (left). Connect the red plug to the red AUDIO terminal **R** (right). Do not connect the yellow plug.
- If you are connecting the camcorder to a TV, set the TV/VIDEO selector on the television to VIDEO.
- If you are connecting the camcorder to a VCR, set the input selector on the VCR to LINE.

If Your TV (or VCR) Has Audio/Video Input Terminals

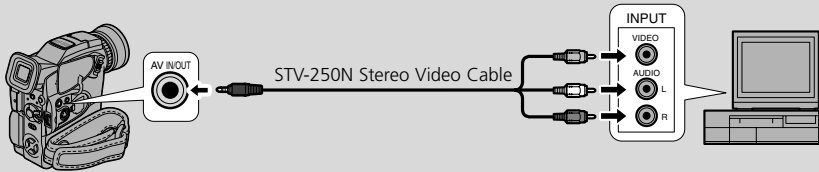

- Connect the camcorder using the STV-250N Stereo Video Cable. Connect the white plug to the white audio terminal **L** (left). Connect the red plug to the red audio terminal **R** (right). Connect the yellow plug to the yellow video terminal **VIDEO**.
- If you are connecting the camcorder to a TV, set the TV/VIDEO selector on the television to VIDEO.
- If you are connecting the camcorder to a VCR, set the input selector on the VCR to LINE.



Notes:

- If you are going to use the TV as a monitor while you are recording, remember to keep the TV volume turned down as long as the camcorder's audio terminals are connected. If the sound from the TV speakers is picked up by the microphone, an unpleasant high-pitched squeal, called feedback, may be produced.
- For TVs having the Video ID-1 system:
If you connect the camera to the TV's S terminal or video in terminal, recordings made in the 16:9 mode for wide screen TVs will automatically play back in wide screen mode on the TV screen.

Searching and Reviewing While Recording

Record Search

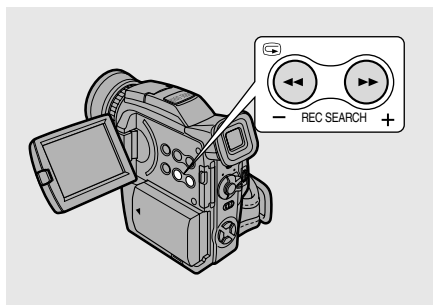

When the camcorder is in record pause mode, you can use record search to play the tape forwards or backwards to locate the point where you wish to start or resume recording. This is useful when you wish to add a new scene to a previously used cassette. By using record search, you can ensure a smooth, noise-free join between the new scene and the old one.

**E****TAPE + CAMERA**

- 1. Press and hold the REC SEARCH + or – button on the camcorder while you check the picture in the display.**
 - The + button plays the recording forwards and the – button plays it backwards.
- 2. Release the button at the point you wish to start recording.**
 - The camcorder returns to record pause mode.

Record Review



When the camcorder is in record pause mode, you can use record review to play back the last few seconds of your recording and then return automatically to record pause mode. You can quickly check if a scene has been recorded properly and then go on to shoot the next scene, without producing any noise in the picture.

TAPE + CAMERA

- 1. Press and release the  (record review) button while you check the picture in the display.**
 - The camcorder rewinds the tape, plays back the last few seconds, and returns to record pause mode.

**Note:**

- Noise may appear on the screen when you play the tape backwards.

Using the Menus



E

Many of the camcorder's advanced functions are selected from menus which appear in the display.

There are 4 main menus:

- CAM. MENU Camera menu (42)
- VCR MENU VCR menu (44)
- C.CAM. MENU Card camera menu (45)
- C.PLAY MENU Card play menu (47)

● CAM. MENU TAPE + CAMERA

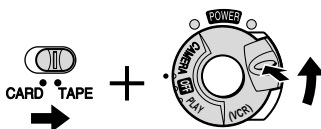
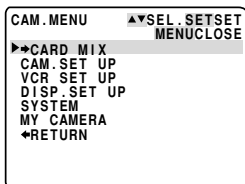

● VCR MENU TAPE + PLAY (VCR)

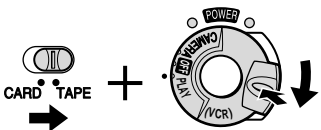
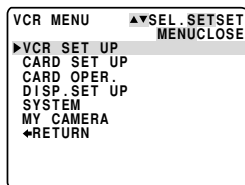

● C. CAM. MENU CARD + CAMERA

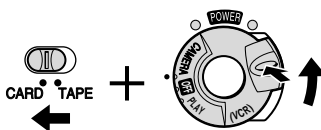
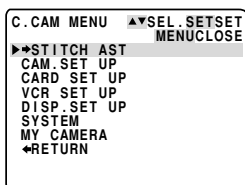

● C. PLAY MENU CARD + PLAY (VCR)

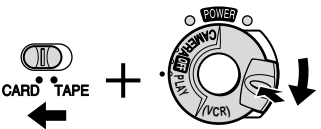
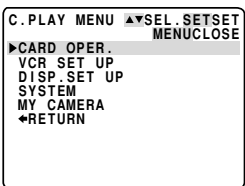

Using the Full Range of Features

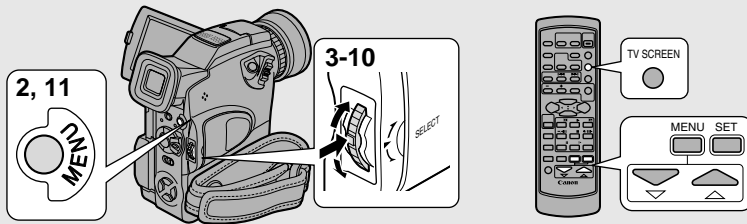

1. Turn the **POWER** switch and the **TAPE/CARD** switch to the desired settings.
2. Press the **MENU** button to open the menu.
 - One of the main menus appears, according to the settings of the TAPE/CARD switch and the POWER switch.
3. Pull the selector dial up or down and move the arrow to the desired submenu.
4. Press the selector dial in to select.
 - The submenu appears.
5. Pull the selector dial up or down and move the arrow to the desired function.
6. Press the selector dial in to select.
 - The function and its settings only appear.
7. Pull the selector dial up or down and move the arrow to the desired setting.
 - If you are setting a function other than the white balance or shutter speed, the function will be set if you skip to step 11.
8. Press the selector dial in to select.
 - The function is set and you return to the submenu.
9. Pull the selector dial up or down and move the arrow to ← **RETURN**.
10. Press the selector dial in to select.
 - You return to the main menu.
11. Press the **MENU** button.
 - The main menu disappears.



Notes:

- Pressing the MENU button at any time closes the menu.
- Selecting ← RETURN takes you back one menu, or closes the main menu.

- Items that are unavailable, due to the tape or card situation or the settings of other menu items, appear in purple.
- You may often find it more convenient to use the wireless controller to move around the menus. Press its MENU button to open/close the menu and use the arrow keys in place of pulling the selector dial up or down. Push the SET button to select.
- Pressing the start/stop button or the PHOTO button will close the menu and start recording.
- You can display the menus on a connected TV screen by turning TV SCREEN (173) on through the menu or using the wireless controller's TV SCREEN button. See p. 36 for TV connecting instructions.

List of Menus  

Turn to the referred page for a detailed explanation of each function.

● CAM. MENU

Set the POWER switch to **CAMERA** and the TAPE/CARD switch to **TAPE**. There are 6 submenus within the CAM. MENU.

- ① To card mix submenu
- ② To camera set up submenu
- ③ To VCR set up submenu
- ④ To display set up submenu
- ⑤ To system submenu
- ⑥ To My Camera settings submenu

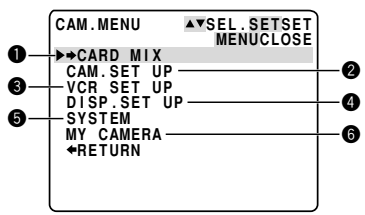

① Card mix submenu

- ① Mix type 144
- ② Animation type..... 145
- ③ Mix level..... 144

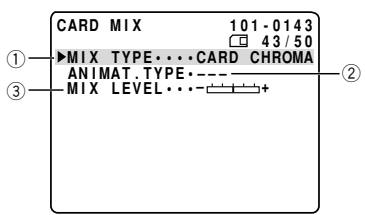

② Camera set up submenu

- ④ Shutter speed 79
- ⑤ Digital zoom..... 25
- ⑥ Image stabilizer 60
- ⑦ 16:9 effect 23
- ⑧ White balance 83
- ⑨ AF-Assist Lamp..... 82

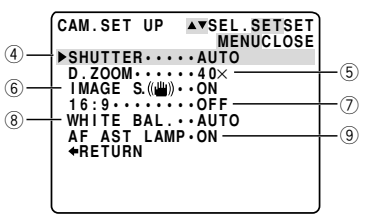

3 VCR set up submenu

- 10 Recording mode 22
- 11 Wind screen 74
- 12 Audio mode 73
- 13 AV or headphones 36

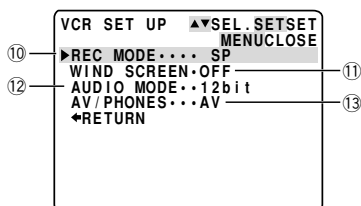

4 Display set up submenu

- 14 Brightness 28
- 15 LCD Mirror mode 29
- 16 TV screen 173
- 17 Date/time display 55
- 18 Card access display 110
- 19 Demo mode 24

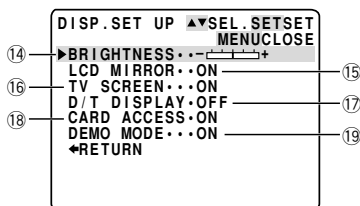

5 System submenu

- 20 Wireless controller 51
- 21 Tally lamp 23
- 22 Beep 24
- 23 Time zone/
Daylight saving time 53
- 24 Date/time set 55

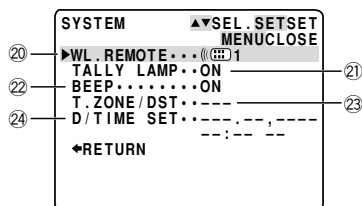

6 My Camera submenu

- 25 Shutter sound 151
- 26 Start-up sound 151
- 27 Start/stop sound 151
- 28 Self-timer sound 151

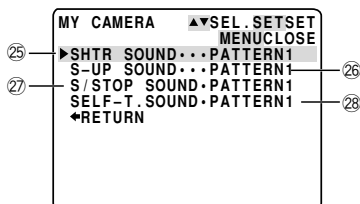

● VCR MENU

Set the POWER switch to **PLAY (VCR)** and the TAPE/CARD switch to **TAPE**. There are 6 submenus within the VCR MENU.

- ① To VCR set up submenu
- ② To card set up submenu
- ③ To card operations submenu
- ④ To display set up submenu
- ⑤ To system submenu
- ⑥ To My Camera settings submenu

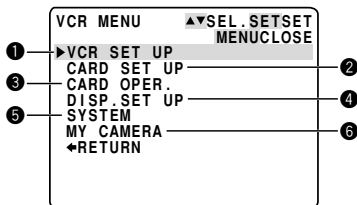

① VCR set up submenu

- ① Recording mode 22
- ② Output channel 105
- ③ Audio dubbing 101
- ④ Wind screen 74
- ⑤ Audio mode 73
- ⑥ AV or headphones 36
- ⑦ Analog-digital converter 96

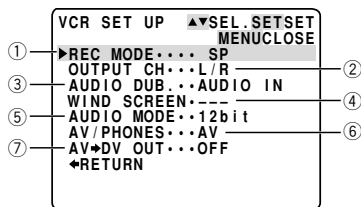

② Card set up submenu

- ⑧ Still image quality 109
- ⑨ Movie size 109
- ⑩ File numbers 111

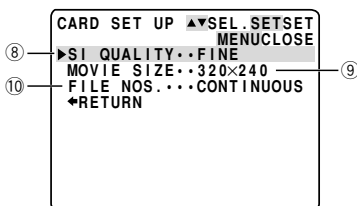

③ Card operations submenu

- ⑪ Copy from tape to card... 147

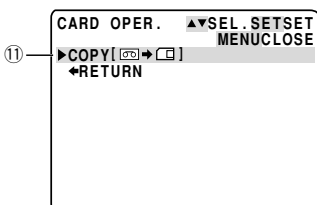

4 Display set up submenu

- 12 Brightness 28
- 13 Displays 173
- 14 6-second auto date 88
- 15 Data code 87
- 16 Date/time select 86
- 17 Card access display 110

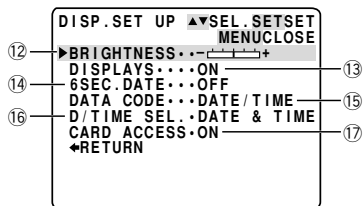

5 System submenu

- 18 Wireless controller 51
- 19 Tally Lamp 23
- 20 Beep 24
- 21 Time zone/
Daylight saving time 53
- 22 Date/time set 55

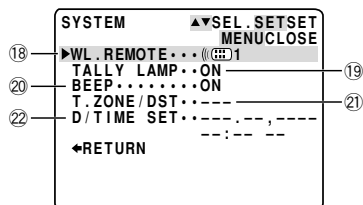

6 My Camera submenu

- 23 Shutter sound 151
- 24 Start-up sound 151
- 25 Start/stop sound 151
- 26 Self-timer sound 151

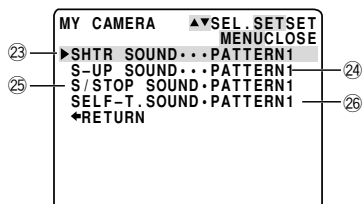

● C. CAM MENU

Set the POWER switch to **CAMERA** and the TAPE/CARD switch to **CARD**.
There are 7 submenus within the C. CAM. MENU.

- 1 To stitch assist mode
- 2 To camera set up submenu
- 3 To card set up submenu
- 4 To VCR set up submenu
- 5 To display set up submenu
- 6 To system submenu
- 7 To My Camera settings submenu

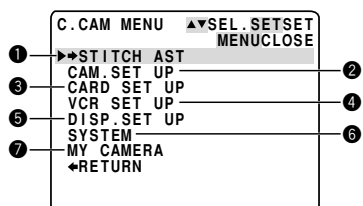

C. CAM. MENU, cont.

① **Stitch assist mode**..... 120

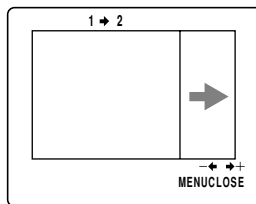

② Camera set up submenu

- ① Shutter speed 79
- ② Digital zoom 25
- ③ Image stabilizer 60
- ④ White balance 83
- ⑤ ND filter 113
- ⑥ AF-Assist Lamp 82

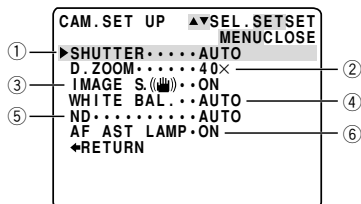

③ Card set up submenu

- ⑦ Continuous shooting 114
- ⑧ Still image quality 109
- ⑨ Still image size 109
- ⑩ Movie size 109
- ⑪ File numbers 111

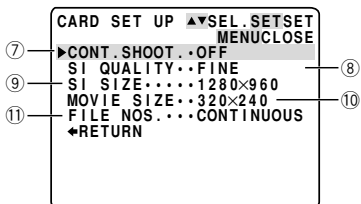

④ VCR set up submenu

- ⑫ Wind screen 74
- ⑬ AV or headphones 36

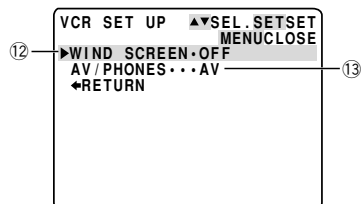

5 Display set up submenu

- 14 Brightness 28
- 15 LCD Mirror mode 29
- 16 TV screen 173
- 17 Date/time display 55
- 18 Card access display 110
- 19 Demo mode 24

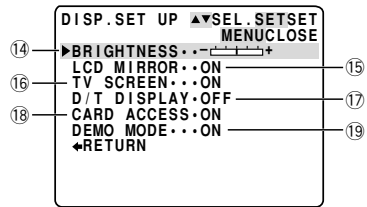

6 System submenu

- 20 Wireless controller 51
- 21 Tally lamp 23
- 22 Beep 24
- 23 Time zone/
Daylight saving time 53
- 24 Date/time set 55

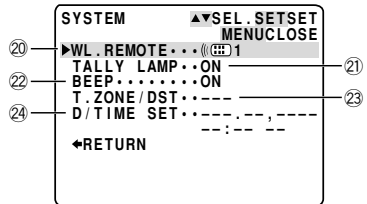

7 My Camera submenu

- 25 Shutter sound 151
- 26 Start-up sound 151
- 27 Start/stop sound 151
- 28 Self-timer sound 151

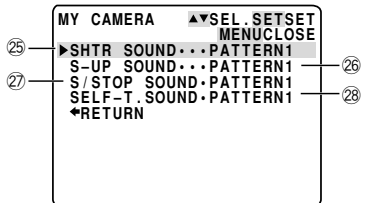

● C. PLAY MENU

Set the POWER switch to **PLAY (VCR)** and the TAPE/CARD switch to **CARD**.
There are 5 submenus within the C. PLAY MENU.

- 1 To card operations submenu
- 2 To VCR set up submenu
- 3 To display set up submenu
- 4 To system submenu
- 5 To My Camera settings submenu

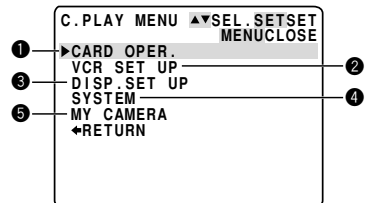

C. PLAY MENU, cont.

1-1 Card operations submenu (when playing back a single image)

- ① Copy from card to tape 148
- ② Erase all print marks 130
- ③ Image erase 131
- ④ Format 149

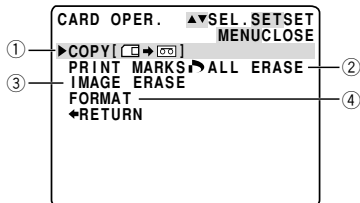

1-2 Card operations submenu (when displaying an index screen)

- ⑤ Image protect 128
- ⑥ Print mark 129

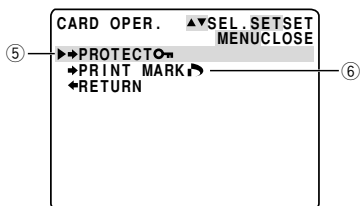

2 VCR set up submenu

- ⑦ Recording mode 22
- ⑧ AV or headphones 36

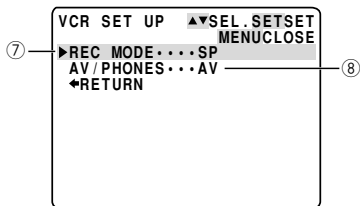

3 Display set up submenu

- ⑨ Brightness 28
- ⑩ Displays 173
- ⑪ Date/time select 86
- ⑫ Card access display 110

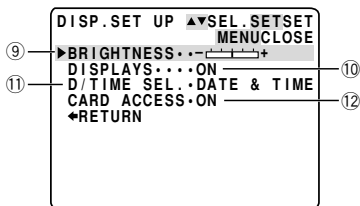

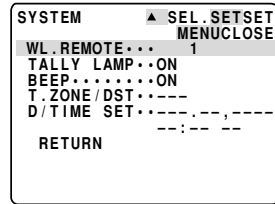

5 My Camera submenu

- 18 Create start-up image 151
- 19 Select start-up image..... 151
- 20 Shutter sound..... 151
- 21 Start-up sound 151
- 22 Start/stop sound 151
- 23 Self-timer sound 151

6 Direct Printing Mode (133)

(Appears when connecting a printer supporting the direct print function)

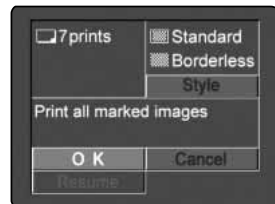
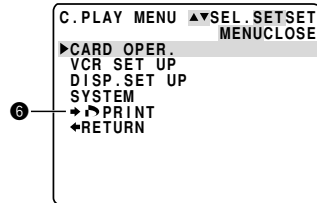

Using the Wireless Controller

E

The supplied wireless controller can operate the camcorder from a distance of up to 16 ft (5 m). Point it at the camcorder's remote sensor while you press the buttons.

There are some functions that can only be operated with the wireless controller:

- Special playback (33)
- Photo/date search (89)
- Zero set memory (90)
- Audio mix (104)
- Analog line-in (94)
- AV insert (98)
- Audio dubbing (99)

Insert two AA batteries, following the \oplus and \ominus markings. Be careful not to reverse the polarity of the batteries.

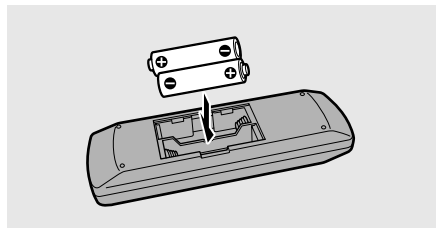
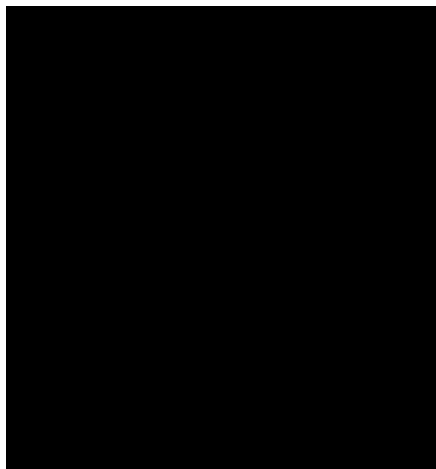

When Operating 2 Canon DV Camcorders (Remote Sensor Mode)



To prevent interference from other Canon wireless controllers being used nearby, there are 2 remote sensor modes and an off setting. The wireless controller and the camcorder have to be set to the same mode in order to be compatible.

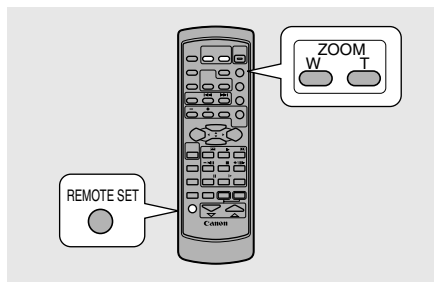

The wireless controller and the camcorder have been preset to mode 1. If you change the mode on the camcorder, be sure to change the mode on the wireless controller to the same mode.



MENU
(40)



A 1 : Mode 1
A 2 : Mode 2
OFFB : Sensor off

To turn the remote sensor off:

Open the menu and select SYSTEM. Then select WL.REMOTE, set it to OFF B and close the menu.

- B appears in the display.

To change the mode...
...on the camcorder:

Open the menu and select SYSTEM. Then select WL.REMOTE, set it to A 1 or A 2 and close the menu.

- The selected mode will appear on the display for 4 seconds.

...on the wireless controller:

Press and hold the REMOTE SET button on the wireless controller.

Simultaneously press the ZOOM W button for mode 1 or the ZOOM T button for mode 2. Continue to press simultaneously for over 2 seconds.

- Be sure to set the wireless controller to the same mode as the camcorder.

If your wireless controller is not working:

Make sure the camcorder and the wireless controller are both set to the same mode. Check the mode the camcorder is set to by pushing any button other than the REMOTE SET button on the wireless controller. The camcorder's mode appears in purple for about 4 seconds. Set the wireless controller's mode accordingly by pressing the aforementioned button combinations. If the wireless controller still does not work, change the batteries.

**Notes:**

- The mode of the camcorder also appears for 4 seconds when you turn the power on.
- When you replace the batteries, the wireless controller returns to mode 1. Change the mode again if necessary.

Setting the Date and Time

E

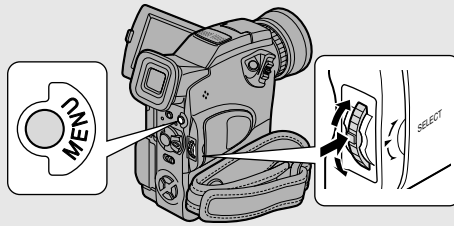

The date and/or time display forms part of the data code. You can choose to display or hide it during playback (86).

Set the date and time display when you first start using your camcorder.

Install the backup battery before you begin (160).

- Before you start setting the date and time, select your home time zone from the menu.

Setting the Time Zone/Daylight Saving Time



TAPE + CAMERA

TAPE + PLAY (VCR)

CARD + CAMERA

CARD + PLAY (VCR)

MENU

(40)

▶ SYSTEM

▶ T. ZONE / DST · N. Y.

1. Open the menu and select SYSTEM.

2. Select T.ZONE/DST.

- The time zone display appears on the screen.
- Your camcorder's time zone is factory-preset to New York. If you are at another time zone, select your time zone first and daylight saving time (DST) setting if necessary.

3. Move up or down the list of time zones with the selector dial.

Select the option that represents your time zone.

- If you are now in daylight saving time, select the time zone with the daylight saving time mark C next to the area.

4. Close the menu.

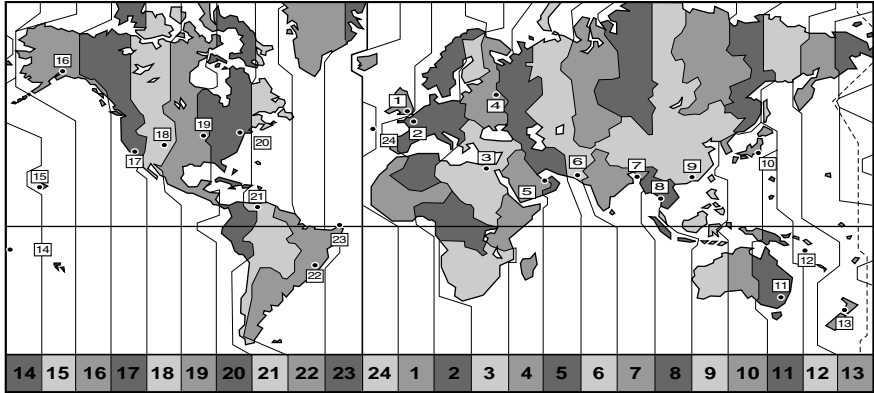

No.	Time zone	No.	Time zone
1	LONDON	13	WELLGTM (Wellington)
2	PARIS	14	SAMOA
3	CAIRO	15	HONOLU. (Honolulu)
4	MOSCOW	16	ANCHOR. (Anchorage)
5	DUBAI	17	L.A. (Los Angeles)
6	KARACHI	18	DENVER
7	DACCA	19	CHICAGO
8	BANGKOK	20	N.Y. (New York)
9	H. KONG (Hong Kong)	21	CARACAS
10	TOKYO	22	RIO (Rio de Janeiro)
11	SYDNEY	23	FERNAN. (Fernando de Noronha)
12	SOLOMON	24	AZORES

Notes:

- Once you have selected your time zone and set the date and time, you do not need to reset the clock each time you travel to another time zone. Just set the time zone to the one of your destination and the camcorder automatically changes the clock.
- The camcorder automatically accounts for the number of days in a month and leap year.

Setting the Clock



After you set the date and time, the date/time and home time zone will be displayed for about 4 seconds each time you turn the power on.



MENU

(40)



1. Open the menu and select **SYSTEM**.
2. Select **D/TIME SET**.
 - The year display starts to flash.
3. Pull the selector dial up or down to change the year. Press the dial in to move to another part of the display.
 - Once you move from the year, the next part of the display starts flashing.
4. Set the month, day, hours, and minutes in the same way.
5. Press the **MENU** button when finished, and to start the clock.



Notes:

- To make a change to part of the date and time, press the selector dial in at step 3 to move to the part to be changed. Use the dial to make the change, then close the menu.
- The date can be set to any year between 2002 and 2030.
- If you press the MENU button in the middle of setting the date and time, you leave the menu, and the clock starts.
- If you press the selector dial in after setting the minutes you can set the date and time again from the start.

Date and Time Display



You can choose to display or hide the date and time display during recording. When the date and time display is set to ON, the date and time appear in the lower left-hand corner of the display but the time zone disappears in about 4 seconds. The large, 4-second display will no longer appear when you turn on the power. It is not automatically superimposed on your recordings.



MENU

(40)



To turn it on, open the menu and select **DISP.SET UP**. Then select **D/T DISPLAY**, set it to **ON** and close the menu.



The camcorder records the still image when the exposure is automatically

card (147) for transferring printout. Also, starting your camcorder to find the beginning again later

the camcorder during regular video recording, or you can enter record pause mode first, before taking a still image.

Press the PHOTO button fully down and the still image will be recorded immediately.

The camcorder records the image immediately. It records the "photo" to the memory card for approximately 6 seconds. During this time the camcorder also records the audio, and the display shows the still image.

The camcorder display appears, and counts up as the camcorder records the still image.

After recording, the camcorder returns to record pause mode.

Record pause mode

Press the PHOTO button halfway down and hold it:

- "PHOTO" flashes at the bottom right of display.
- Exposure is locked.
- During autofocus F flashes white in the display as the camcorder adjusts the focus and it is displayed continuously as a green mark when the camcorder is ready to take the still image.

- If the subject is unsuitable for autofocus (☐ 166), the camcorder may not be able to focus, and F may continue to flash white in the display. Continue to hold the PHOTO button halfway down, then adjust the focus manually with the selector dial.
- If you are using manual focus (☐ 81), the F mark starts as a continuous green mark. Focus with the focus ring.

2. Press the PHOTO button fully down to record the still image.

- The camcorder takes the image immediately. It records the "photo" to the tape for approximately 6 seconds. During this time the camcorder also records the sound, and the display shows the still image.
- A counter display appears, and counts up as the camcorder records the picture. F disappears from the display.
- The camcorder returns to record pause mode.



Notes:

- The camcorder automatically returns to record pause mode after recording a still image for approximately 6 seconds. If you turn the POWER switch to OFF during that time, the camcorder will respond only after recording is complete.
- The wireless controller's PHOTO button has no half-way setting. Press the button fully and the camcorder immediately takes the "photo".



E

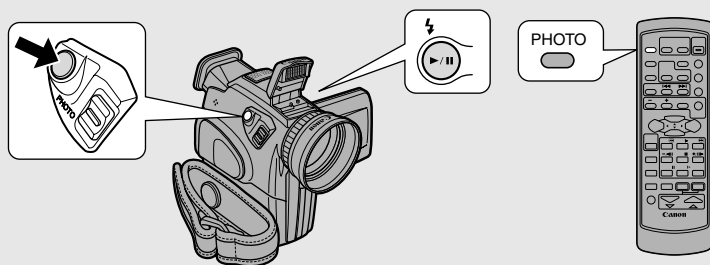

You can take natural-looking flash pictures with appropriate illumination even in dark places using the built-in flash. It also reduces the red-eye effect when shooting people at night or in dark indoor places.

- ⚡ (Auto): The flash automatically fires according to the brightness of the subject.
- 👁️ (Red-eye reduction auto): The Super Night LED lights up automatically before the flash to reduce the red-eye effect.
- ⚡ (Flash on): The flash is forced to fire regardless of the brightness of the subject.
- 🔌 (Flash off): The flash does not fire. Use this setting when you are shooting in places where flash photography is prohibited.

Changing The Setting of the Flash

TAPE + CAMERA, **CARD + CAMERA**

1. Press the ⚡ (flash) button.

- The display changes in the following order with each press of the button.
 ⚡ (Auto) → 👁️ (Red-eye reduction auto)
 ↖️ 🔌 (Flash off) ← ⚡ (Flash on) ←
- The selected mode appears in the display, with the exception of ⚡ (Auto), which disappears after 4 seconds.
- When you press the flash button while Auto is selected and ⚡ is not displayed, ⚡ appears. Then, when you press the button while it is displayed, you can change the setting.

During record pause mode

2. Press the PHOTO button halfway down and hold it.

- The flash automatically rises.
- ⚡ appears green in the display.

3. Press the PHOTO button fully down to take the still picture.

- The flash fires.
- During recording, the display shows the still image.

Returning the flash to the body

Press the flash down with your hand.





- Do not return the flash to the body while it is firing.

Caution:

- Do not fire the flash close to people's eyes.
- Do not fire the flash at drivers while they are driving.
- Do not fire the flash with the flash bulb covered with your hand.



Notes:

- The practical range of the flash is approximately from 3 ft 3 3/8 in (1 m) to 9 ft 10 1/8 in (3 m). Depending on the recording conditions, the range varies.
- Your camcorder automatically adjusts the flash exposure according to the brightness of the subject (Flash exposure compensation). The flash fires to perform flash exposure compensation before the main firing for taking photos. When  (Red-eye reduction auto) is set, the flash fires to perform flash exposure compensation between the Super Night LED for red-eye reduction and the main firing for taking photos. It takes about 1 second between the lighting of the Super Night LED for red-eye reduction and the main firing.
- In "Red-eye reduction auto" mode, the subject needs to look at the Super Night LED in order to have red-eye reduction effective. The degree of reduction varies on the distance to the subject and also on each individual.
- If the flash is forced to fire (Flash on) in a bright location, the effect of flash photography sometimes may not be obtained.
- The flash does not fire in the following cases:
 - When exposure is locked in Auto or Red-eye reduction auto mode. Flash display changes to purple:
 - When a shutter speed of 1/2000 or faster is set in the TAPE CAMERA mode. However, in the case that "Flash on" is selected, the display of the selected shutter speed flashes (in purple) for four seconds, then changes to "1/1000" (yellow), and the flash fires.
 The flash display flashes in red:
 - When an abnormality occurs during charging ( 165).
 The flash display disappears:
 - When multi-image screen is selected.
 - When you are recording movies onto a tape.
- The flash does not fire if  does not appear green in the display when you press the PHOTO button. Set it to "Flash on" mode when necessary.
- The  (red-eye reduction auto) cannot be used in stitch assist mode.
- The flash cannot be used in the Night or Super Night recording program.
- When the flash is fired with a lens hood or an optional tele-converter attached to the camcorder, its shadow may be recorded.
- When a tape recorded using a flash is played back on different equipment, the image may flicker.

Turning the Image Stabilizer Off

E

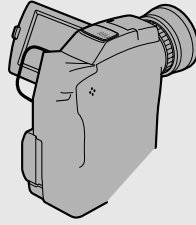

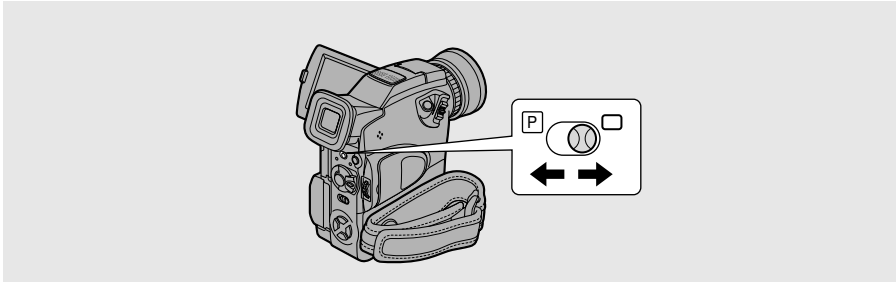

The camcorder provides you with a choice of 9 recording programs. They use different combinations of camcorder settings in order to adjust the exposure and other functions to match the recording situation.

- For simple point-and-shoot operation, select the Easy Recording program. Slide the program selector to the □ position.
- For normal shooting conditions, slide the program selector to Q (program AE) mode. Open the program menu and select AUTO (□ 62).
- For various other recording conditions, the camcorder has 7 more specialized AE (auto exposure) programs.

Availability of functions in each recording program

Position of program selector										
Recording Program	□ (Easy Recording)	Auto	Sports	Portrait	Spotlight	Sand & Snow	Low Light	Night	Super Night	
Digital Zoom	○	○						×		
Shutter speed	A	○	A							
Focus						○				
White balance						○				
Exposure						○				
Image stabilizer (ON/OFF)	ON					○				
Digital effects	×					○				○*
16:9	×					○				
Card mix	×					○				

○ : Available × : Not available A : Automatic function only

* You cannot use the multi-image screen in the Night or Super Night recording program.



1. Slide the program selector to Q (program AE) mode.
2. Press the selector dial in to display the program menu.
3. Pull the selector dial up or down and select the program.
4. Press the selector dial in to select the desired program.
 - The program appears in the display.



Notes:

- The name of your selected recording program appears constantly on the left of the display, with the exception of Auto, which disappears after 4 seconds.
- Avoid changing programs during recording as the brightness of the image may change suddenly.
- If you switch the camcorder from the □ program to the Q program, the camcorder returns to the Auto program.
- When recording in dark places, a bright light in the scene may cause a vertical light bar (“smear”) to appear. This is a normal feature of camcorders.



Easy Recording

The simplest way to use the camcorder is with the program selector set to the □ position. The camcorder will take care of focus, exposure and other adjustments, leaving you free to point and shoot.



Auto

This is the same as the Easy Recording program, except that you now have the option of using any of the camcorder's manual functions.



Sports

This program is useful for recording high-speed sports scenes in brightly lit conditions. Normal playback will be slightly jerky, but you will get clear images which can be analyzed frame by frame during slow or paused playback.



Portrait

Use this program outdoors to make subjects stand out from a softened foreground and background. It works well for still lives and close-ups. The effect is most noticeable when the zoom position is between the middle range and the telephoto end. Focus manually for maximum accuracy, and be careful when recording action scenes, as this program may cause fast moving objects to shudder.



Spotlight

This program is designed for recording spotlight scenes, such as on a stage. The exposure is automatically adjusted for glare-free recordings of subjects lit by a concentrated light source.



Sand & Snow

Use this program in places where the background is so bright that the subject appears underexposed in the display — a sunny beach or ski resort, for example. You may notice some shudder when recording moving subjects.



Low Light

This program allows you to record in dimly lit places. The shutter speed is fixed at a slow speed. It is generally best used for close-ups of slow or stationary subjects, as moving subjects may leave a trailing after-image. However, you can take advantage of this to create special effects, by rapid zooming or by panning along with a moving subject. Image quality will not be as good as in normal lighting conditions, and autofocus may not work as good as in other modes.



Night

This program automatically adjusts the shutter speed according to the brightness of the subject even in dark places (night time, etc.) to shoot subjects brightly in color. It is useful when you record in locations with dark and light places (such as in amusement parks).

- You can record subjects without after-image even in light places.



Super Night

Use this program to shoot in very dark places. The Super Night LED lights up, allowing you to shoot subjects in the center of the display brightly in colour.

- Use this recording program for recording at close range (up to 2 m).
- The range of the Super Night LED is limited. Check the picture on the screen when recording.





Notes:

Concerning Night and Super Night recording program:

- Night and Super Night cannot be used in CARD CAMERA mode.
- Moving subjects may leave a trailing after-image.
- Though subjects can be shot brightly, the image quality may not be as good as in normal lighting condition.
- White points etc. may appear in the display.
- Autofocus may not work as well as usual (in such case, adjust the focus manually).
- The flash does not fire when recording a still image.

Using Digital Effects

Use the camcorder's digital effects for more interesting productions.

- **Faders:** Start or end scenes on a tape with a fade to or from black ( 66). Fade Trigger, Wipe, Corner, Jump, Flip, Puzzle, Zigzag, Beam, Tide
- **Effects:** Add flavour to your recordings ( 68). Art, Black and White, Sepia, Mosaic, Ball, Cube, Wave, Color Mask, Mirror
- **Multi-image Screen:** Divides the display to show 4, 9 or 16 still images. Has 4 transition speed options: fast, moderate, slow and manual ( 71).

Availability of digital effects by mode

	TAPE CAMERA	PHOTO	TAPE PLAY (VCR)	CARD CAMERA	CARD PLAY (VCR)
Faders	○	×	○	×	×
Effects	○	○	○	○ ¹⁾	×
Multi-image Screen	○ ²⁾	○ ²⁾	○	×	×

○ : Available

× : Not available

¹⁾ : Black and White only

²⁾ : Cannot be used in Night and Super Night recording program.

- The types of digital effects you can use depends on the setting of the TAPE/CARD switch, the POWER switch and the recording program.

Notes:

- When you do not wish to use digital effects, press the DIGITAL EFFECTS button and select D.EFFECT **OFF** from the digital effects menu. Press the ON/OFF button to close the menu.
- The camcorder retains your chosen digital effect setting until you change it.
- Digital effects can be selected but not operated on a blank blue screen (appears in TAPE PLAY (VCR) mode). The display continues to flash.
- Digital effects operated during TAPE PLAY (VCR) mode are not recorded onto the original tape.
- Digital effects can be added to another tape when dubbing using the AV out terminal (TAPE PLAY (VCR) mode), but not the DV out terminal.
- You cannot operate digital effects while photo/date searching.
- If you slide the program selector to  (Easy Recording) while the digital effect display is flashing, it will disappear from the display and reappear when you return to Q (program AE) mode.
- The digital effect display will flash for 2 seconds after setting, even if DISPLAYS is set to OFF in the menu.

E

Using the Full
Range of Features

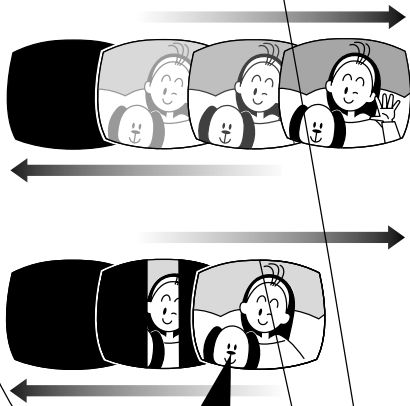

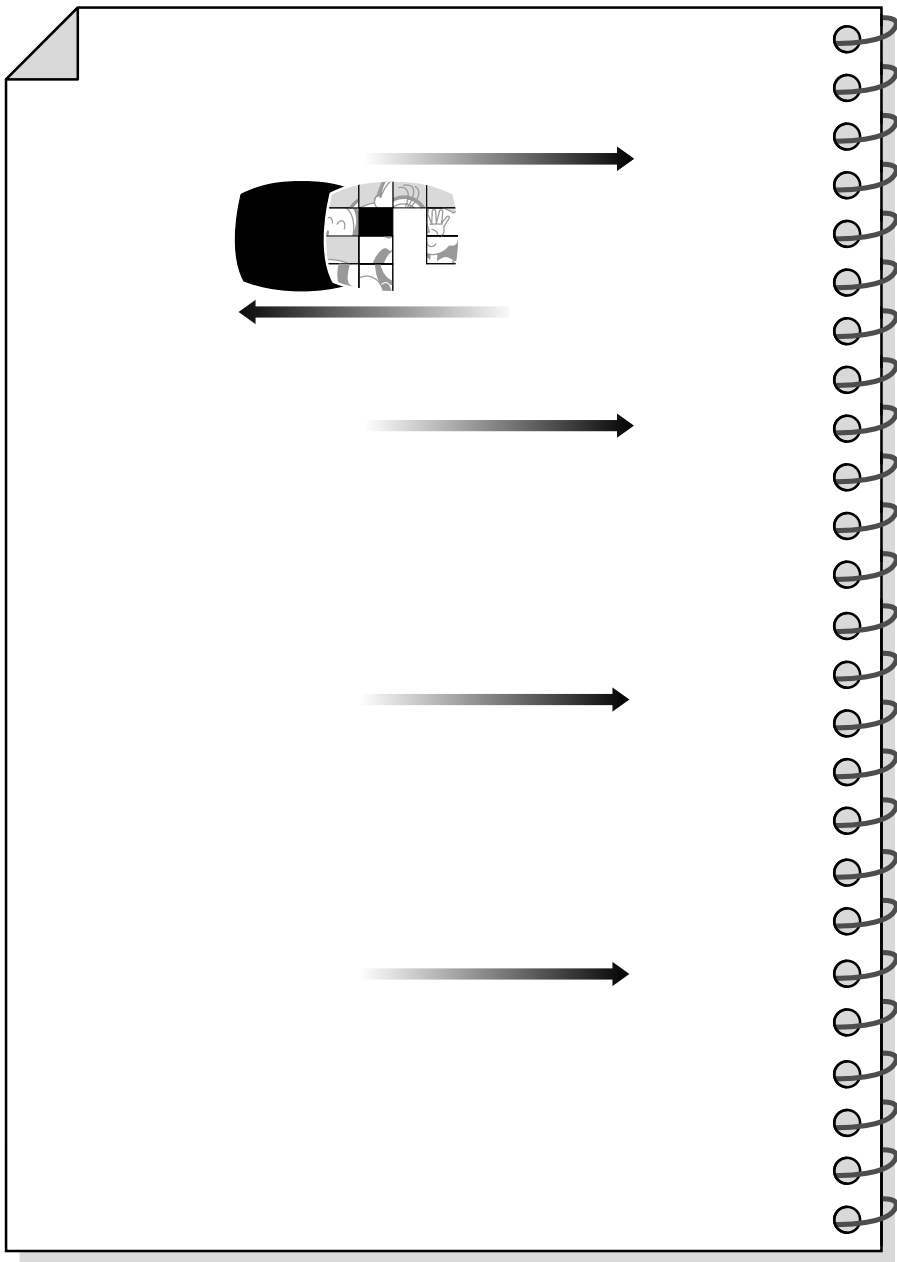



Digital effects can be set with the controls on the body of the camcorder or the wireless controller.

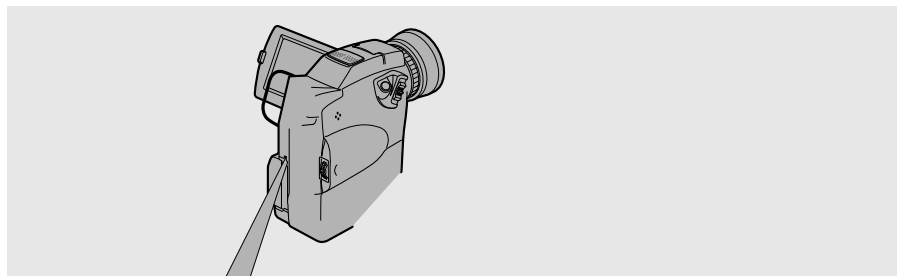

Sound and image fade together. When operating faders in TAPE CAMERA mode, make sure the program selector is set to Q.

TAPE + **CAMERA** , **TAPE** + **PLAY (VCR)**

Select fader

1. Press the **DIGITAL EFFECTS** button to open the digital effects menu.
 - D.EFFECT **OFF**, FADER, EFFECT and MULTI-S appear.
2. Select **FADER**.
 - The settings appear.
3. Select the desired setting.
 - You return to the digital effects menu.
4. Press the **DIGITAL EFFECTS** button to close the menu.
 - The name of your selected fader flashes in the display.

Fader on/off

5. Press the **ON/OFF** button.
 - The name of your selection stops flashing.
 - Each time you press the ON/OFF button, the chosen fader is activated (display lights continuously) or deactivated (display flashes).
6. In TAPE CAMERA mode:
 - Fade in-** Press the start/stop button.
 - Fade out-** Press the start/stop button.
- In TAPE PLAY (VCR) mode:
 - Fade in-** Press the ► (play) button.
 - Fade out-** Press the || (pause) button.

Operating Effects



Sound records/plays back normally.

When operating effects in TAPE CAMERA or CARD CAMERA mode, make sure the program selector is set to Q.

TAPE + **CAMERA** , **TAPE** + **PLAY (VCR)**

Select effect

1. **Press the DIGITAL EFFECTS button to open the digital effects menu.**
 - D.EFFECT **OFF**, FADER, EFFECT and MULTI-S appear.
2. **Select EFFECT.**
 - The settings appear.
3. **Select the desired setting.**
 - You return to the digital effects menu.
4. **Press the DIGITAL EFFECTS button to close the menu.**
 - The menu disappears and the name of your selected setting flashes in the display.

Effect on/off

5. **In TAPE PLAY (VCR) mode, press the ► (play) button.**
6. **Press the ON/OFF button.**
 - The name of your selection stops flashing and takes effect on the display.
 - Each time you press the ON/OFF button, the chosen effect is activated or deactivated.

CARD + **CAMERA**

1. **Press the DIGITAL EFFECT button.**
 - BLK&WHT flashes in the display.
2. **Press the ON/OFF button.**
 - The effect is activated and the image appears in black and white.

7. Select the desired setting.

- You return to the digital effects menu.

8. Press the DIGITAL EFFECTS button to close the menu.

- The digital effects menu disappears.
- MULTI-S flashes in the display.

Multi-image screen on/off

9. Push the ON/OFF button.

- MULTI-S stops flashing.
- Manual: As you press the ON/OFF button, scenes will be captured one after another the indicated number of times. If you push and hold the ON/OFF button for more than a second, the last image captured will be erased.
- The currently recording image is framed in blue. The frame disappears after the last image is captured.
- Automatic: The camcorder will capture the indicated number of images at the indicated speed.

10. In TAPE CAMERA mode, push the start/stop button or the PHOTO button to begin recording.

- The multi-image screen is recorded to the tape.

**Notes:**

- You can operate the multi-image screen from record or record pause mode.
- After all the images have been captured, press the ON/OFF button quickly to cancel the multi-image screen.
- If you are operating the multi-image screen in TAPE PLAY (VCR) mode and you stop or pause the tape, or press any other playback button or the date/photo search buttons, the multi-image screen will be canceled. (This does not apply with the MANUAL multi-image speed.)
- You cannot use digital zoom or the 16:9 mode when the multi-image screen is set. The display becomes “- - -”.

Audio

Selectin

The comco
and 12-bit
superior to
leaving tw

-bit
ly
(b 1),

E

MENU

(40)

To switch SET UP. T the men

- "16 bit"

CR
se



Notes:

- For deta
- For deta
p. 104.
- When yo
terminal
- In TAPE
line-in re
automat
camcord

e
bit
ing at
the settin
to the

Externa

 **Note:**

- When using an external microphone, use a microphone cable not longer than 9 ft 10 1/8 in (3 m) to avoid electromagnetic interference.

Wind Screen

The camcorder has an automatic wind screen to prevent wind noise from interfering with the sound track. Make sure it's off when you want the microphone to be as sensitive as possible. Use the wind screen when recording in windy places such as the beach or near buildings.

**MENU**

(40)

▶VCR SET UP



▶WIND SCREEN·OFF

To turn it on, open the menu and select VCR SET UP. Then select WIND SCREEN, set it to ON and close the menu.

- WS is shown in the display when you turn the wind screen on.

 **Notes:**

- The wind screen can be used for audio dubbing with the built-in microphone in TAPE PLAY (VCR) mode as well as recording (when AUDIO DUB. is set to MIC. IN in VCR SET UP submenu).
- The wind screen does not operate when an external microphone is connected to the MIC terminal.

Setting the Self-Timer

E

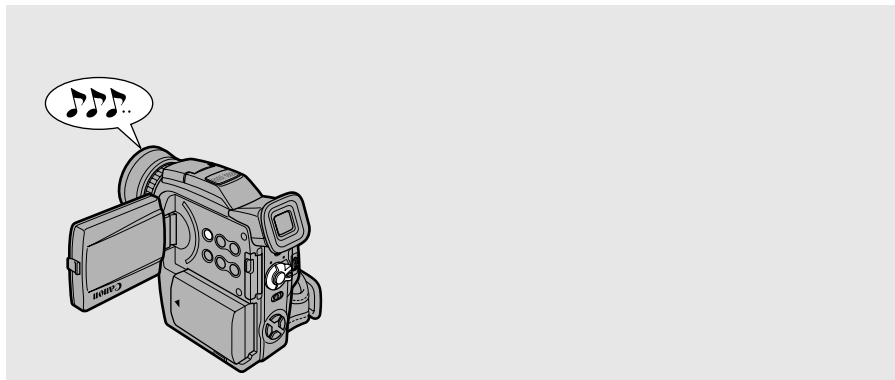

This is useful when you wish to include yourself in the picture when recording movies or still images to a tape or memory card.

1. Press the  self-timer button on the body of the camcorder
or
the **SELF TIMER** button on the wireless controller.

- SELF T appears in the display.
- To have the subject monitor recording, rotate the LCD panel 180° ( 29).

For movies

2. Press the **start/stop** button.

- The camcorder starts to record after a 10-second countdown period (or after 2 seconds when you use the wireless controller). The time remaining counts down in the display (e.g. "5 SEC").
- SELF T disappears from the display when recording begins.
- The tally lamp starts flashing.

3. Press the **start/stop** button to end recording.

For stills

2. Press the **PHOTO** button on the camcorder body or the wireless controller.

- The camcorder automatically adjusts the focus 2 seconds before the countdown is complete. The F mark flashes white then turns green after the focus and exposure are set. If you are using the wireless controller, the F mark starts flashing immediately after you press the PHOTO button.

- The camcorder takes the picture for approximately 6 seconds.
- In TAPE CAMERA mode, the camcorder returns to record pause mode after recording to a tape. If you're in CARD CAMERA mode, the currently recording image appears after recording onto a memory card.

**Note:**

- To cancel the self-timer, press the  self-timer button, start/stop button (when recording a movie) or PHOTO button (when recording a still image).

Adjusting Exposure Manually

TAPE + CAMERA , CARD + CAMERA

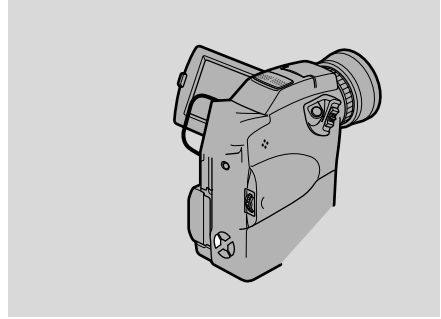

E

TAPE + CAMERA , CARD + CAMERA

To make the recorded image brighter, pull the selector dial up (to a maximum of +11). This may be necessary if the background is very bright, or if the subject is lit from behind.

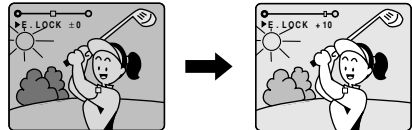

To make the recorded image darker, pull the selector dial down (to a minimum of -11). This may be necessary if the background is very dark, or if the subject is spotlighted.

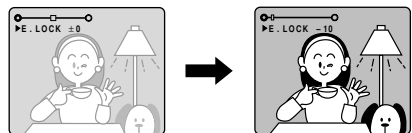

Using the Full
Range of Features

**Notes:**

- The standard exposure level depends on which recording program you have selected.
- Exposure lock is canceled if you change recording programs.
- You cannot use exposure lock or adjustment when the program selector is set to the (Easy Recording) position.
- If you zoom while the exposure is locked, the brightness of the scene may change.



Set the shutter speed manually to take stable shots of quickly moving subjects.

MENU

(40)

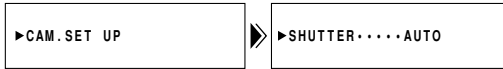

1. Make sure the camcorder is set to the \square (program AE) mode.
2. Press the selector dial in and choose **AUTO** from the program menu.
3. Open the menu and select **CAM.SET UP**.
4. Select **SHUTTER**.
5. Press the selector dial in to select the desired shutter speed.

<u>TAPE</u>		<u>CARD</u>
AUTO		AUTO
1/60	↑ slower ↑	1/60
1/100		1/100
1/250		1/250
1/500		
1/1000		
1/2000		
1/4000		
1/8000	↓ faster ↓	

- Only shutter speeds up to 1/250 are available when using a memory card.

6. Close the menu.

Concerning shooting in fluorescent lighting

When the camcorder is set to \square (Easy Recording), the Auto, Night or Super Night recording program in TAPE CAMERA mode, it automatically detects the flicker of fluorescent lighting and adjusts the shutter speed to compensate. However, if the brightness of the LCD or viewfinder display starts to flicker, make sure the camcorder is set to the Auto recording program and select the 1/100 shutter speed.

Guidelines for shooting using high shutter speeds

- When shooting with a shutter speed of 1/1000 or higher, do not shoot the sun directly.

Recommended shutter speeds when shooting:

- People doing outdoor sports such as golf or tennis



1/2000 or 1/4000
(or 1/8000 to freeze
the action even more
clearly)

- Moving cars or trains or other rapidly moving vehicles such as roller coasters



1/1000, 1/500 or
1/250

- People doing indoor sports such as basketball



1/100

Notes:

- You cannot set the shutter speed in any recording program other than AUTO.
- The image may not appear smooth when a high shutter speed is set.
- The camcorder returns to the auto shutter setting when you slide the program selector to (Easy Recording), or change the recording program.
- If you set the shutter speed to 1/500 or above in TAPE CAMERA mode and then switch the camcorder to CARD CAMERA mode, the shutter speed will automatically change to 1/250.

Adjusting Focus Manually



E

The camcorder focuses automatically. All you have to do is point and the subject in the center of the screen will usually be in sharp focus. It may happen that a subject is not suitable for autofocus. Use the manual focusing function to adjust the focus.

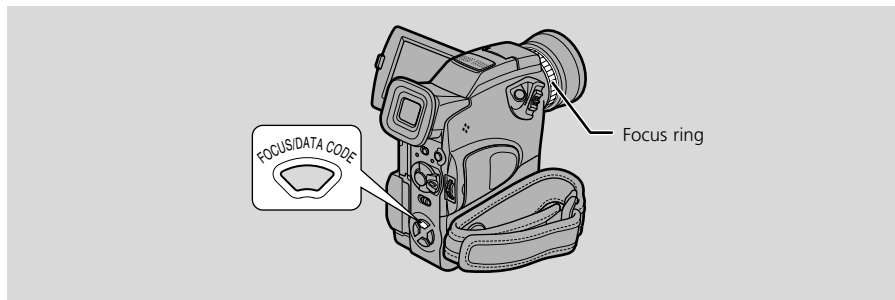

1. Press the FOCUS button to turn the autofocus off.

- MF appears in the display.
- The focus remains locked at the point set by autofocus.

2. Rotate the focus ring to set the focus.

- Rotate the focus ring clockwise to move the focus farther away.
- Rotate the focus ring counterclockwise to bring the focus nearer.
- If you zoom in on your subject after turning off the autofocus, it may not stay in focus. It is generally best to adjust the zoom first and then the focus.



Notes:

- The camcorder will return to autofocus when selecting the (Easy Recording) program.
- Autofocus can not be turned off in (Easy Recording) program.
- See "Troubleshooting" on p. 166 for a list of subjects that may not be suitable for autofocus.

Infinity Focus

Use this function when you wish to focus on faraway subjects such as mountains or fireworks.

Press the focus button more than 3 seconds in step 1 above to record in infinity focus mode. The MF ∞ icon will appear on the display. ∞ will disappear when you operate the zoom or the focus ring and the camcorder will change to manual focus.

Turning Off the AF-Assist Lamp

The AF-assist lamp (Super Night LED) lights up to illuminate the subject in the center of the screen if necessary to focus in dark places.

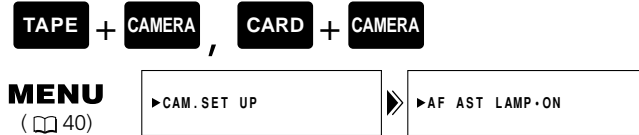

To turn the AF-assist light off, open the menu and select CAM.SET UP. Then select AF and set it to OFF.

Notes:

- The camcorder may not focus automatically even though the AF-assist lamp is lighting (in such cases, adjust the focus manually).
- The AF-assist lamp lights brightly. Consider turning off the AF-assist lamp in public places such as in restaurants or theaters.
- Turn the AF-assist lamp off in places where flash photography is prohibited.

Setting the White Balance



E

The camcorder's auto white balance system compensates for a wide range of lighting conditions. Although slight variations are unavoidable, colors will appear natural in virtually every situation.

In some cases, you will get better results by setting the white balance yourself, or using one of the two preset modes:

T Indoor Mode

- Under halogen or studio/video lighting
- Subject is of one dominant color
- Close ups

U Outdoor mode

- In daylight, especially for close-ups and when the subject is of one dominant color

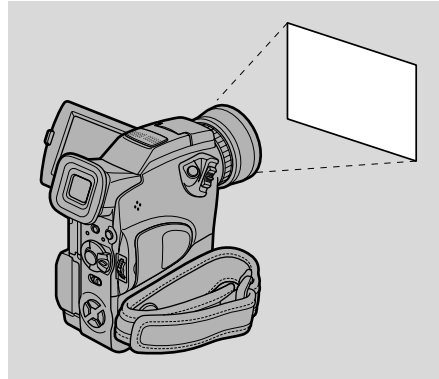

TAPE + **CAMERA** , **CARD** + **CAMERA**

MENU

(40)

▶CAM.SET UP

▶WHITE BAL...AUTO

1. Make sure the camcorder is set to the **Q** (program AE) mode.
2. Open the menu and select **CAM.SET UP**.
3. Select **WHITE BAL**.
4. a) For the indoor, outdoor or auto settings, press the selector dial in to choose the setting.
 - T/U appears in the display when you set the white balance to indoor/outdoor mode.b) To set the white balance yourself, point the camcorder at a white object (such as a sheet of paper) and zoom in until it fills the display. Then press the selector dial in to select **SET/VV**.
 - Make sure to continue pointing the camcorder at the white object until you have finished setting the white balance.
 - The **VV** display flashes then remains lit.
 - Depending on the light source, the flashing may at times continue. The result will still be better than with the auto setting and you can continue recording.
5. Close the menu.

E

Setting the white balance manually will probably work better than auto white balance when shooting:

Subjects with one dominant color, such as sky, sea or forest



Close-ups

In rapidly changing lighting conditions

In places lit by certain types of fluorescent or mercury vapor lights

Enlarging the Image during Playback



E

You can enlarge the image up to 5 times during TAPE PLAY (VCR) and CARD PLAY (VCR) mode. You can also move the image up, down, to the right or left.

- Movies played back from a memory card cannot be enlarged.

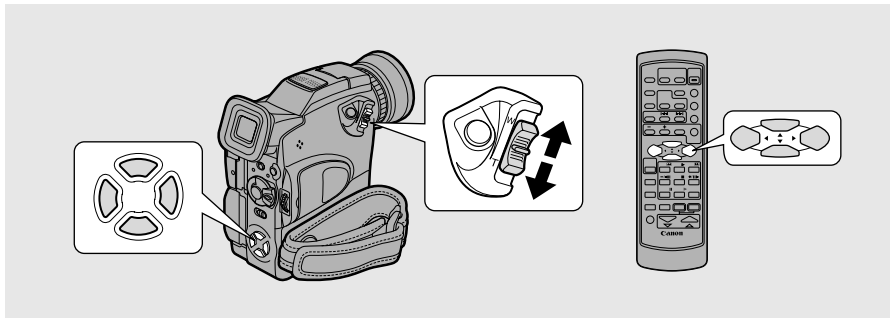

TAPE + PLAY (VCR), **CARD + PLAY (VCR)**

During Playback

1. Move the zoom lever toward T.

- The image is magnified by 2 times.
- To further enlarge the image, move the zoom lever toward T. To shrink the image below 2 times magnification, move the zoom lever toward W.
- A frame appears, indicating the enlarged portion of the image.

2. Move the image to the right and left by pressing the ◀ or ▶ button.

Move the image up and down by pressing the ▲ or ▼ button.

- The image and the frame indicating the position move.



3. To cancel, move the zoom lever toward W until the frame disappears.

Displaying Date, Time and Camcorder Data (Data Code)

E

A data code, containing the date and time the recording was made and other camcorder data (shutter speed and exposure settings) is automatically recorded on a special data section of the tape.

- Only the date and time appear in the data code when using a memory card.

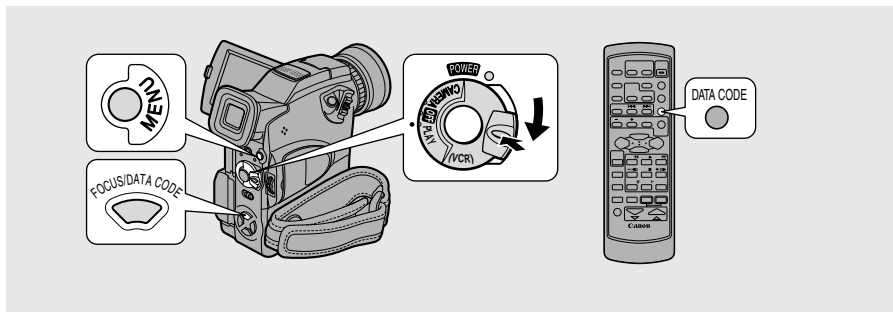

During TAPE PLAY (VCR) mode, the data code can be displayed or hidden while the camcorder is in play, slow or still mode.

Camcorder data may be displayed as “-- --” during fast forward, rewind, reverse playback, forward and reverse $\times 2$ playback.

Press the DATA CODE button. When using a cassette, press it while the camcorder is in play, slow or still mode.

- Press it once to display, once more to hide it.
- The data code will also be displayed on a TV screen connected to the camcorder.

Selecting Date/Time



Select whether you want the date, the time, or both to show up on your data code display.

TAPE + **PLAY (VCR)** , **CARD** + **PLAY (VCR)**

MENU
(40)

▶ DISP.SET UP



▶ D/TIME SEL..DATE & TIME

To change the date and time combination, open the menu and select DISP.SET UP. Then select D/TIME SEL., set it to DATE, TIME or DATE & TIME and close the menu.

Setting the Data Code



E

You can also choose to display camcorder data (shutter speed and exposure settings) in cassette data codes.



MENU

(40)

▶ DISP.SET UP

▶▶ DATA CODE...DATE/TIME

To change, open the menu and select **DISP.SET UP**. Then select **DATA CODE**, set it to **DATE/TIME**, **CAMERA DATA** or **CAM. & D/T** and close the menu.

Possible data code combinations for cassettes:

DATA CODE (tape only) D/TIME SEL.	Date/Time	Camcorder data	Date/Time & Camcorder data
Date	JAN. 1, 2002	F1.8 1/250	F1.8 1/250 JAN. 1, 2002
Time	12:00:00 AM	F1.8 1/250	F1.8 1/250 12:00:00 AM
Date & Time	12:00 AM JAN. 1, 2002	F1.8 1/250	F1.8 1/250 12:00 AM JAN. 1, 2002

Notes:

- The data code will read “— — —” in the following situations:
 - During playback of a blank section of tape.
 - If the tape was recorded before entering the date and time in the camcorder's memory.
 - If the tape was recorded on a camcorder without a data code function.
 - If noise or tape damage prevents the data code from being read.
- If a recording made on OPTURA200 MC is played back on a different DV camcorder, the data code may not be displayed correctly.
- The data code will appear in the display even if DISPLAYS (173) has been set to OFF through the menu.

Six-second Auto Date



The 6-second auto date appears for 6 seconds to mark the changeover of a day if the tape was being recorded at 12:00 midnight. It also appears for 6 seconds when you start playback and have the data code turned off. The 6-second auto date will adjust for any time zone changes you have indicated.



MENU

(40)



To turn the 6-second auto date on, open the menu and select **DISP.SET UP**. Then select **6SEC. DATE**, set it to **ON** and close the menu.

Notes:

- When 6SEC.DATE is turned on but DISPLAYS (173) is turned off, the 6-second auto date will still appear for 6 seconds.

Searching the Tape (Photo Search/Date Search)

E

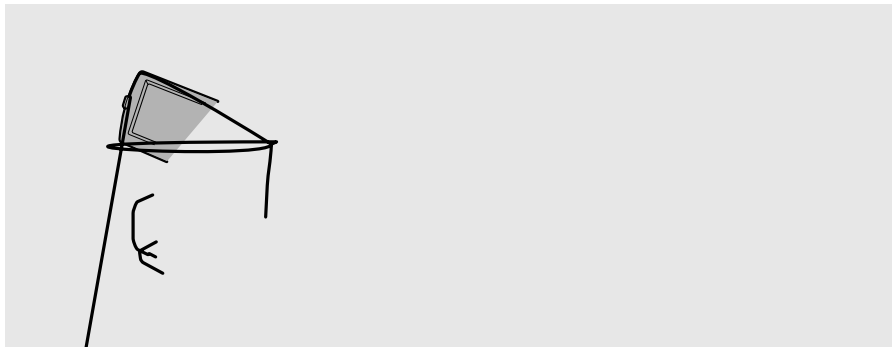

This allows you to move quickly through still pictures recorded anywhere on a tape (photo search) or between different days or areas of recording (date search) on a tape.

1. Press the **SEARCH SELECT** button to choose between photo/date search.

- PHOTO SEARCH or DATE SEARCH appears in the display for 4 seconds.

2. Press the **-** and **+** buttons to move backwards or forwards through the still images or between different days of recording.

- Press once to move to the start of the previous/next still image or day on the tape.
- You can press more than once to move to the corresponding still image or day (up to a maximum of 10 times), e.g. press the **+** button 5 times to move forward 5 still images or days.
- PHOTO SEARCH/DATE SEARCH appears in the middle of the display alongside the **-** or **+** mark and number to search through. You can change direction easily by pressing the button for the opposite direction.

Notes:

- Press **■** (stop) to stop searching.
- If you begin a search very close to the start of a recorded still image during photo search, the camcorder may skip straight past it.
- When you have set the time zone, date search also looks for the change in date based on the adjusted time.
- A date/time zone cannot be identified if the total recording time on that day/time zone was less than 1 minute.
- Date search playback may start just before or after the beginning of the located section.
- If the data code is not displayed correctly you will not be able to operate the date search correctly.

Returning to a Pre-Marked Position

E

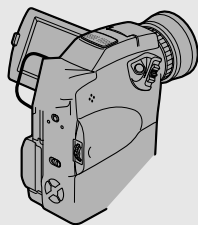

Use the wireless controller to mark a point on a tape that you want to return to following playback.

- 1. Press the ZERO SET MEMORY button on the wireless controller during playback at a point you want to return to later.**

- The time code is replaced by a tape counter that is set to zero with the **M** indication.
- Press the ZERO SET MEMORY button once more to cancel the zero set memory.

- 2. When you have finished playback, fast forward or rewind the tape. The tape stops automatically when it reaches the zero set position.**

- **RTN▶▶** or **◀◀RTN** appears in the display.
- The tape counter with **M** indication disappears from the display and the time code reappears.



Notes:

- The zero set memory may not function correctly where there is a break between recordings on the tape.
- You can also use zero set memory to mark a position on a tape in TAPE CAMERA mode. When you then play back the tape, pressing rewind will take you back to the pre-marked position.
- If you remove the tape while the zero set memory is set, the memory is canceled and the tape counter reverts to time code.
- The camcorder remembers your setting even if you turn it off and back on again or move the program selector.

Editing to a VCR

E

By connecting the camcorder to a VCR, you can edit your recordings in order to remove unwanted scenes — or combine different shots to create your own video productions.

Preparations

- 1. Connect the camcorder to the VCR.**
 - See “Connections for Playback on a TV Screen” on p. 36.
- 2. Prepare the TV and VCR.**
 - Turn on the TV and set the TV/VIDEO selector to VIDEO.
 - Turn on the VCR, and set its input selector to LINE. Load a blank cassette, and put the VCR in record pause mode.
 - See your TV and VCR instruction manuals for details.
- 3. Turn the camcorder’s POWER switch to PLAY (VCR), and move the camcorder’s TAPE/CARD switch to TAPE.**
 - Make sure the AV/headphone terminal is set to AV through the menu ( 36). If PHONES appears in the display, switch the terminal.
- 4. Load your recorded cassette.**

Editing



- 1. Find a point on your recorded cassette slightly before the section you wish to copy.**
- 2. Start to play it back while you monitor the picture on the TV.**
- 3. Start recording on the VCR as soon as the section you wish to copy appears on the screen.**
- 4. Pause the VCR at the end of the section you wish to copy, then stop playback on the camcorder.**
- 5. Repeat steps 1 to 4 until your edited recording is complete.**

Note:



- The quality of the edited tape will be slightly lower than that of the original.

(LANC) Terminal

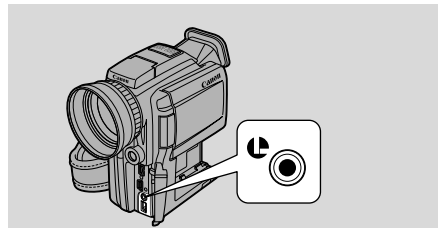
The  terminal allows you to connect the camcorder to equipment. Some buttons on editing equipment may operate differently from those on the camcorder.



Notes:

-  (LANC) is a trademark. It stands for Local Application Control Bus System.
- We cannot guarantee the results when connecting to equipment not bearing the LANC  symbol.

Dubbing to/from a Tape with Digital Video Equipment

E

Digital video equipment fitted with the DV terminal lets you edit, copy and transfer data digitally, with virtually no generation loss in image and sound quality. The DV terminal is for both line-in and line-out, since a single DV cable can handle data in both directions.

- If a digital VCR is connected and an anomalous signal is sent from the VCR, the images recorded on the tape may also be anomalous (although it may not appear so on the TV image), or not recorded at all.
- You are unable to dub tapes recorded with the copyright protective signal.

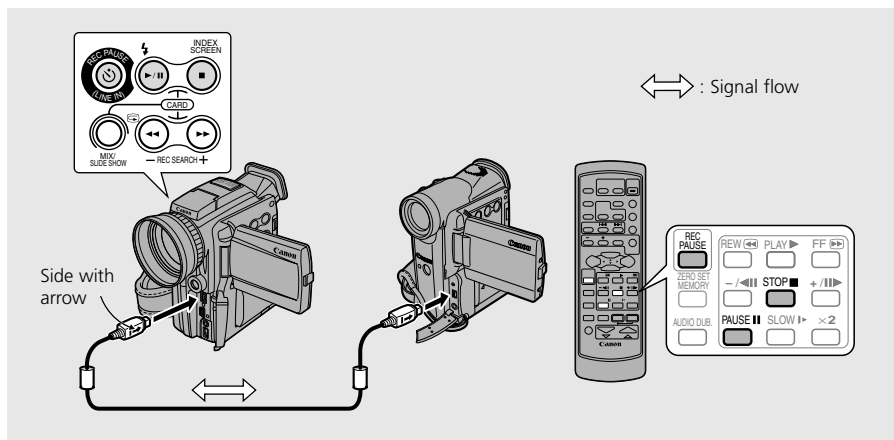

Preparations

Example dubbing to the camcorder

- 1. Connect the camcorder and the other digital device.**
 - Connect the Canon CV-150F DV cable (optional) with the sides of the plugs marked with the arrows facing as shown above.
- 2. Prepare the other device.**
 - Turn on the power and load a recorded cassette.
- 3. Turn the camcorder's POWER switch to PLAY (VCR), and move the camcorder's TAPE/CARD switch to TAPE.**
 - DV IN appears in the display.
- 4. Load a blank cassette.**

Editing

Dubbing



E

1. Find a point on your recorded cassette slightly before the section you wish to copy and set it to playback pause mode.
2. Press the **REC PAUSE** button on the wireless controller.
 - The camcorder enters record pause mode.
3. Start playback on the other digital device while you monitor the picture.
4. Press the **pause** button.
 - Recording starts.
5. When you get to the point where you wish to stop recording, press the **stop** button or the **pause** button.
 - Recording stops.
6. Stop playback on the other device.



Notes:

- Blanks between recordings on the playback tape are recorded as anomalous images on the tape that is being recorded to.
- When dubbing to a tape via the DV terminal, make sure that AV → DV is not displayed on the screen. If so, set AV → DV OUT to OFF (p.97).

Copyright Signal

Certain pre-recorded software tapes are copyright protected. If you try to play back such a cassette, "COPYRIGHT PROTECTED PLAYBACK IS RESTRICTED" appears in the display for a few seconds and then the camcorder displays a blank blue screen; you cannot view the contents of the cassette.

If you try to record from such a tape via the digital cable "COPYRIGHT PROTECTED DUBBING RESTRICTED" appears in the display; you cannot record the contents of the tape.

Recording from a VCR, TV or Analog Camcorder (Analog Line-in)

E

You can record a video played on your VCR or analog camcorder (for digital camcorders, see p. 92) or a TV program onto a tape in the OPTURA200 MC, if the TV or other device has audio/video outputs.

- If an anomalous signal is sent from the TV or VCR, the images recorded on the tape may also be anomalous (although it may not appear so on the TV image), not recorded at all, or COPYRIGHT PROTECTED DUBBING RESTRICTED may appear in the display.
- You are unable to dub tapes recorded with the copyright protective signal.

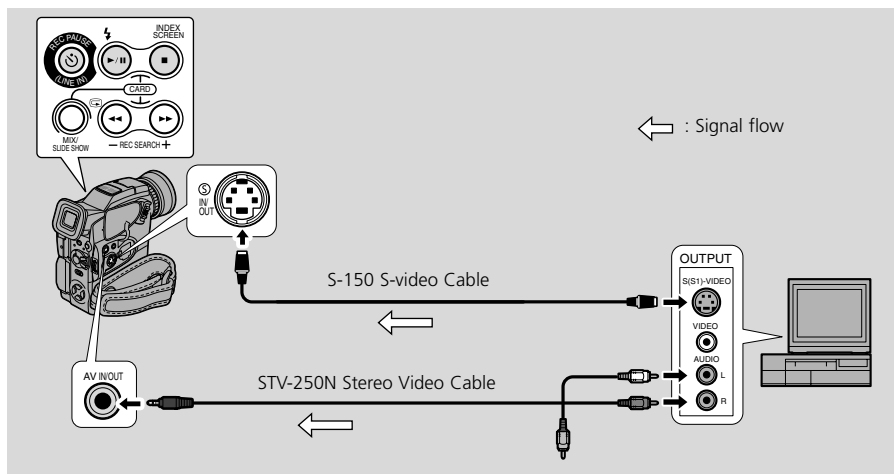

You cannot use headphones while doing analog line-in recording. If you have the AV/headphones terminal set to headphones, it will automatically switch to AV for analog line-in recording. PHONES disappears from the display.

Editing

Preparations

Example recording from a VCR

1. **Connect the camcorder to the VCR.**
2. **Prepare the device.**
 - Set the TV/Video selector on the television to Video. For further details, see "Connections for Playback on a TV Screen" on p. 36.
 - Turn on the VCR. Load your recorded cassette, and put the VCR in playback pause mode.
 - See your TV and VCR instruction manuals for details.
3. **Turn the camcorder's POWER switch to PLAY (VCR), and move the camcorder's TAPE/CARD switch to TAPE.**
4. **Load a blank cassette.**



- 1. Find a point on your recorded cassette slightly before the section you wish to copy and set it to playback pause mode.**
- 2. Press the REC PAUSE button on the wireless controller.**
 - S-video and AV IN/OUT terminals work as input terminals.
 - The camcorder enters record pause mode.
- 3. Start playback on the other device or turn on the TV to see the desired program while you monitor the picture.**
- 4. Press the pause button.**
 - Recording starts.
- 5. When you get to the point where you wish to stop recording, press the stop button or the pause button.**
 - Recording stops.
- 6. Stop playback on the other device.**

**Note:**

- You can monitor the picture in the viewfinder or LCD screen.

Digitally outputting analog video and audio signals (Analog-Digital Converter)

E

Connecting the camcorder to your VCR or 8 mm video camera allows conversion of recorded analog video and audio signals to digital signals in an instant. The digital signals can be output to the other equipment with a DV terminal. The camcorder's DV terminal works exclusively as an output terminal.

- There may be cases where analog-digital conversion cannot be done properly, depending on the signals output from the connected equipment. For example: Signals that include the copyright protective signal, or anomalous signals such as ones that include ghost signals, etc.
- You cannot use your headphones during digital conversion. Even if the AV/headphone terminal is set to "PHONES" through the menu, it will automatically be set to "AV", and "PHONES" will disappear from the display.
- You are recommended to use power from a household power socket with the power adapter.
- Do not operate with a cassette inserted to the camcorder.
- Turn off the power of all equipment before performing connections.
- Refer also to the instruction manuals of the other equipment connected.

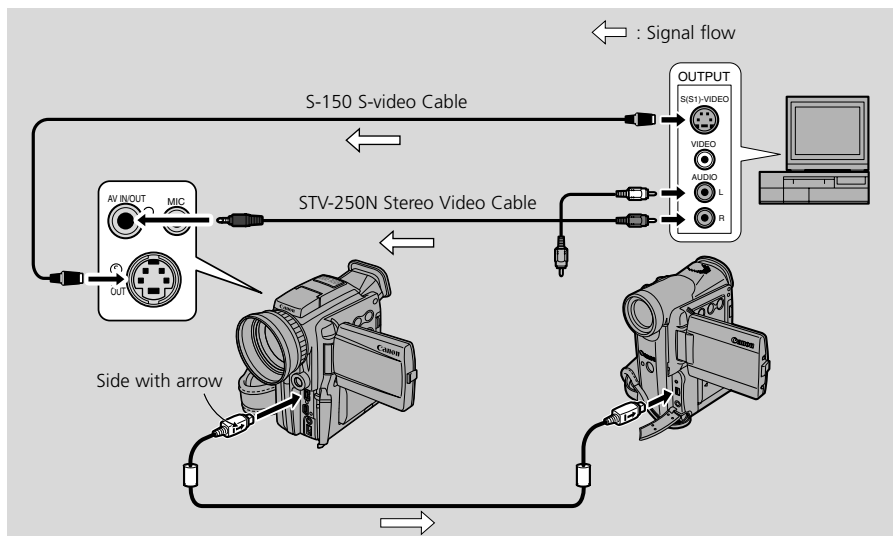

Above illustration shows the connection using a S-video cable. You can also connect to the VIDEO terminal instead (38).

Turning the Analog-Digital Converter On



MENU

(40)



To turn the analog-digital converter on, open the menu and select **VCR SET UP**. Then select **AV → DV OUT**, set it to **ON** and close the menu.

OR

Press the **AV → DV** button on the wireless controller.

Caution:

- For normal use, set **AV → DV OUT** to **OFF** (so that **AV → DV** does not appear in the display). If it is set to **ON**, you cannot input digital signals through the camcorder's DV terminal.
- When connecting to a PC equipped with a DV terminal, you may not be able to transfer converted signals to your PC, depending on the software you are using, and the specifications of your PC and its settings.

Recording Over Existing Scenes (AV Insert Editing)

E

You can insert and replace images/audio recorded on the camcorder's tape with other images/audio recorded with other video equipment using both, analog line-in or DV in terminals. Original video and audio will be replaced with the new video and audio.

Editing

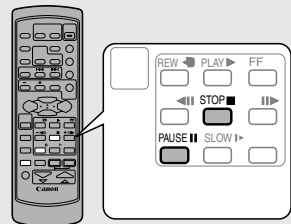
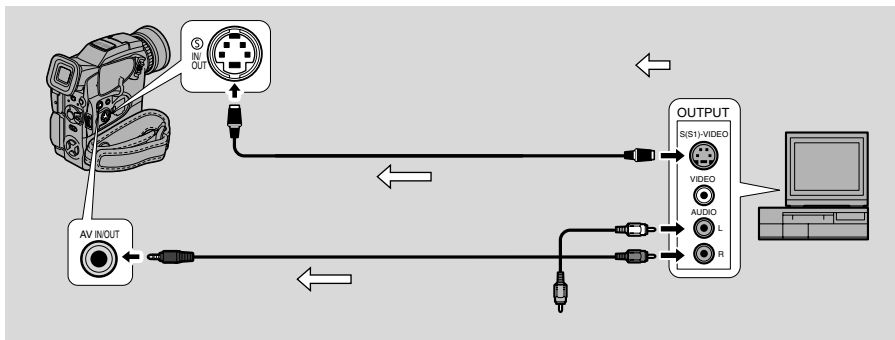

Preparations

The tape in the camcorder:

When using the OPTURA200 MC's AV insert function, only record to tapes recorded in SP mode.

If there are non-recorded portions or portions recorded in a mode other than SP mode on the tape, recording will stop.

The playback tape:

Use only tapes without non-recorded portions.

If there are non-recorded portions or changes in the recording mode, you may not be able to insert AV correctly.

You cannot insert AV in the following cases:

- The playback tape has been poorly recorded.
- During special playback: fast forward playback, rewind playback or slow playback etc. (analog only).

TV:

You cannot insert AV from a TV program with anomalous synchronized signals, such as when the program itself received poor signals.

Example recording from a VCR

1. Connect the camcorder to the VCR.

2. Prepare the VCR and TV.

- Set the TV/Video selector on the television to Video. For further details, see "Connections for Playback on a TV Screen" on p. 36.
- Turn on the VCR and load a recorded cassette.
- See your TV and VCR instruction manuals for details.

3. Turn the camcorder's POWER switch to PLAY (VCR) and load a recorded cassette.

- Make sure the REC/SAVE tab on the cassette has been slid to REC (closed position).

4. Move the camcorder's TAPE/CARD switch to TAPE.



1. **On the VCR, locate a point 3 seconds before the scene to be inserted. Set the VCR to playback pause mode.**
2. **On the camcorder, press PLAY and locate the recording start point. Set the camcorder to playback pause mode.**
 - You can use the playback buttons on the body of the camcorder or the special playback functions on the wireless controller in the same way as in playback mode.
3. **Press the AV INSERT button.**
 - AV INSERT and ●III appear in the display.
4. **Play back the cassette in the VCR.**
5. **To start inserting, press the PAUSE button on the camcorder.**
 - ●III changes to ●.
6. **To stop inserting, press the STOP button on the camcorder.**
 - Inserting stops and AV INSERT disappears from the display. The camcorder returns to stop mode.
 - If instead of pressing STOP you press PAUSE, the camcorder returns to the AV insert pause mode.
 - If you set the zero set memory at the position on the tape where you want to stop inserting, every time you return to that point, the camcorder will cancel its AV inserting and enter stop mode.
7. **Stop playback on the VCR.**

Audio Dubbing

E

You can add sound to the original sound on a pre-recorded tape from audio devices (AUDIO IN) or with the internal or external microphone (MIC. IN). The original sound will not be erased. For best results, add sound to tapes that have been recorded with this camcorder in SP mode with 12-bit sound. If there are non-recorded portions on the tape, or portions recorded in a mode other than SP mode, or with 16-bit or 12-bit 4-channel sound, dubbing will stop. If your tape has not been recorded in SP mode with 12-bit sound, we recommend dubbing your original tape onto a blank tape using the OPTURA200 MC's analog line-in function, then dubbing audio onto the new tape. Make absolutely sure to set the audio mode of the new tape to 12-bit and the recording mode to SP.

To connect other audio devices:

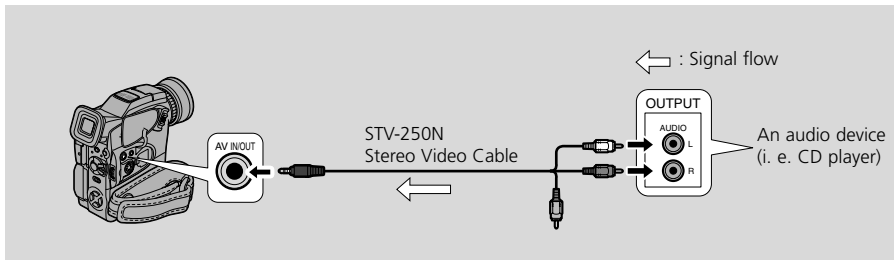

Notes:

- Do not use the yellow video terminal.
- The AV terminal doesn't put out any video, so connect the S-video terminals and check your TV, or check the LCD or the viewfinder as you add new sound. Always check the new sound with the speaker.

To connect an external microphone:

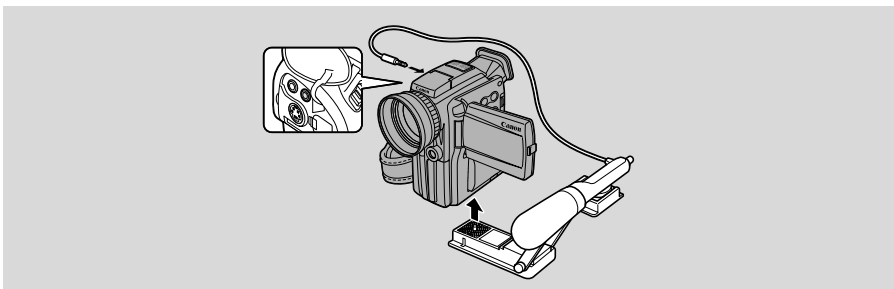

Editing

**MENU**

(40)

▶VCR SET UP





▶AUDIO DUB...AUDIO IN

1. Open the menu and select **VCR SET UP**.
2. Select **AUDIO DUB**.
3. Select **AUDIO IN** or **MIC. IN** and close the menu.
4. Locate the point where you wish to start audio dubbing, then press the **PAUSE** button.
 - You can use the playback buttons on the body of the camcorder or the special playback functions on the wireless controller in the same way as in playback mode.
 - The camcorder becomes set to playback pause mode.

5. Press AUDIO DUB.

- AUDIO DUB. and  appear on the display.

6. Press the PAUSE button (and start play on the other audio device if AUDIO IN).

- Audio dubbing starts.
- If MIC. IN, direct your voice into the microphone.
-  changes to .

7. When you get to the point where you wish to stop dubbing, press the STOP button (and then stop play on the other audio device if AUDIO IN).

- Audio dubbing stops and AUDIO DUB. disappears from the display.
- The camcorder returns to stop mode.
- You can also set zero set memory ( 90) at the place you want to stop audio dubbing, then every time you return to that position, audio dubbing will cancel.
- If instead of pressing STOP you press PAUSE, the camcorder will return to the playback pause mode.

 **Notes:**

- You cannot use the DV terminal while adding sound.
- You might want to adjust the audio mix ( 104) when playing back a tape with added sound.
- There may be a loss of sound quality if you add sound to a tape recorded on a camcorder other than the OPTURA200 MC.
- After adding sound 3 or more times to the same place on a tape, there may be some loss in sound quality.

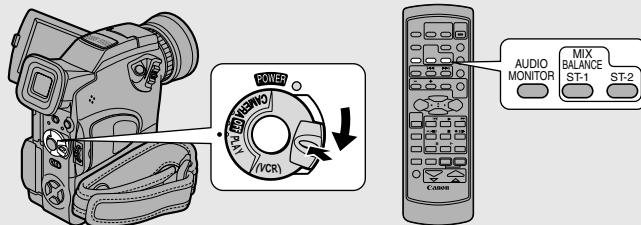
**E**

When you play back a tape that was recorded in 12-bit mode, you can set the audio output to play: stereo 1 (the original sound), stereo 2 (any new sound, dubbed to the tape after recording), or mix the balance between the two.

- Audio from the 16-bit mode only contains stereo 1 sound and so you cannot/do not need to select the audio mix. The same is true for the 12-bit stereo 1 mode, unless new sound has been added post-recording.

TAPE + **PLAY (VCR)**

Choose the output.

- Press AUDIO MONITOR on the wireless controller.
- Starting with the last selected setting, 4 settings appear as you push the button:
 - STEREO1 for just stereo 1.
 - STEREO2 for just stereo 2.
 - MIX/FIXED for an equal mix of stereo 1 and 2.
 - MIX/VARI. (mix variable) for when you wish to mix the balance between stereo 1 and 2.
- To simply choose STEREO1, STEREO2 or MIX/FIXED, make sure your choice appears on the display.
- If you choose MIX/VARI., you can go on to mix the balance.
- Use the ST-1/ST-2 keys to mix the balance. A bar showing the mix appears on the screen for 4 seconds.

Note:

- When you have chosen the output, STEREO1, STEREO2, MIX/FIXED or MIX/VARI. is shown in the top left of the display for a few seconds. If you turn the power off the output is set to STEREO1.

Selecting Audio Output Channels



E

When you play back a tape whose audio has been recorded on multiple channels, you can change the output channels of that sound.

TAPE + **PLAY (VCR)**

MENU
(40)

▶VCR SET UP



▶OUTPUT CH...L/R

1. Load a tape recorded with multiple-channel audio.
2. Open the menu and select VCR SET UP. Then select OUTPUT CH, set it to the desired setting and close the menu.
 - Refer to the following list.

Connecting to a PC Using a DV Cable

E

You can download still images/movies recorded onto a tape or memory card with your camcorder to a computer by connecting to a computer equipped with a DV (IEEE1394) terminal or IEEE1394 capture board. With Windows XP's Windows Messenger, you can use the supplied software to perform a videoconference over the Internet, or upload files from the computer to the memory card and use the camcorder as a card reader/writer.

- There are several requirements for using this software. For details, please refer to the DV NETWORK SOLUTION DISK Software Instruction Manual.
- While connected we recommend powering your camcorder from a household power socket using the power adapter.
- For transferring still images and movies from a memory card to your PC using a USB cable, see p. 150.

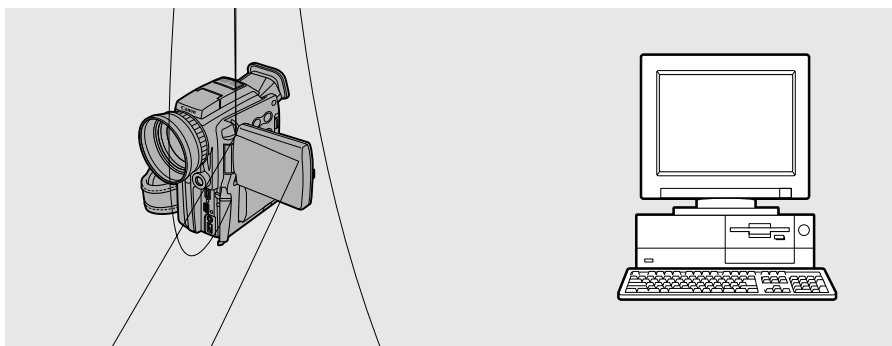

Editing



Notes:

- Operation may not work correctly, depending on the software you are using, and the specifications of your PC and its settings.
- See your PC instruction manual for details.

Cautions:















- Do not disconnect the DV cable, remove the memory card, or turn off the camcorder or the computer while data is being transferred (while the camcorder's card access indicator is flashing). Doing so may damage the memory card's data.
- The image files on your memory card and the image files you have stored (downloaded) to the hard disk drive of your computer are your valuable, original data files. If you wish to use image files on your computer, be sure to make copies of them first, and use the copied file, retaining the original.

Memory Card Introduction





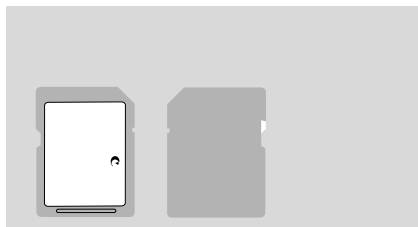

E

The camcorder can record, store and manage still images/movies on 2 types of memory cards: the SD Memory Card (supplied with the camcorder) or the MultiMediaCard (commercially available). The SD Memory Card has the protect switch to protect your recordings from accidental erasure. The SD Memory Card and the MultiMediaCard fit into the same slot.

You can find the explanations in the following order:

- Preparations ( 108-111)
- Recording Still Images to a Memory Card ( 112-116)
- Recording Movies to a Memory Card ( 117-119)
- Recording panoramic Images ( 120-121)
- Playing Back a Memory Card ( 122-124)
- Settings of Still Images/Movies ( 125-127)
- Preventing Accidental Erasure (Protect) ( 128)
- Marking a Still Image for Printing (Print Mark) ( 129)
- Erasing Still Images/Movies ( 131)
- Using Printers Supporting the Direct Print Function (Optional) ( 133-141)
- Combining Images and Recording Them to a Tape (Card Mix) ( 142-146)
- Copying Still Images to and from a Tape ( 147, 148)
- Formatting a Memory Card ( 149)
- Connecting to a PC Using a USB Cable ( 150)
- Using the My Camera Function ( 151)



You can use most of the camcorder's functions when recording to a memory card, such as the various recording programs ( 61), self-timer ( 75), shutter speed ( 79), white balance ( 83) and other manual adjustments. Available functions are marked with a the  or  icons.

- If you use memory cards other than the supplied one, make sure to format them with the camcorder ( 149).

Inserting and Removing the Memory Card

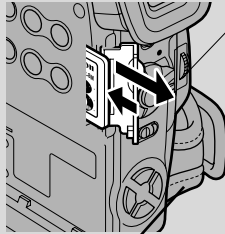

Selecting the Still Image Quality



Still image Quality: Superfine, Fine, Standard

TAPE + **PLAY (VGR)**, **CARD** + **CAMERA**

MENU
(40)

▶CARD SET UP ▶SI QUALITY...FINE

To change the image quality, open the menu and select **CARD SET UP**. Then select **SI QUALITY**, set it to **SUPER FINE** or **STANDARD**, and close the menu.

- The image quality may not differ between the settings depending on the subject.

Selecting the Image Size of Still Images and Movies



Image Size: Still image: 1280 × 960 pixels/640 × 480 pixels
Movie: 320 × 240 pixels/160 × 120 pixels

CARD + **CAMERA**

Still Image

MENU
(40)

▶CARD.SET UP ▶SI SIZE.....1280×960

To change the image size of a still image, open the menu and select **CARD SET UP**. Then select **SI SIZE**, set it to **"640 × 480"** and close the menu.

- "640" appears in the display.

Movie

MENU
(40)

▶CARD.SET UP ▶MOVIE SIZE...320×240

To change the image size of a movie, open the menu and select **CARD SET UP**. Then select **MOVIE SIZE**, set it to **"160 × 120"** and close the menu.

- "160" appears in the display.

Maximum Number of Still Images on an 8 MB Memory Card and Their File Sizes

Image Size	1280 × 960		640 × 480	
	No of Images	File Size per Image	No of Images	File Size per Image
Superfine	Approx. 6 images	850 KB	Approx. 34 images	175 KB
Fine	Approx. 10 images	550 KB	Approx. 50 images	120 KB
Standard	Approx. 18 images	300 KB	Approx. 84 images	65 KB

Maximum Recording Time of Movies on an 8 MB Memory Card and Their File Sizes

Image Size	Max. Recording Time	Total File Size	File Size per Second
320 × 240	10 seconds	1.7 MB	170 KB/sec
160 × 120	30 seconds	2.7 MB	90 KB/sec

* The actual number varies on the shooting conditions and subjects. Sample images already recorded on the supplied SD Memory Card are to be included in the total number.



Notes:

- Still images are compressed and recorded in the JPEG (Joint Photographic Experts Group) format, and movies in the Motion JPEG format.
- Refer to p. 176 for memory card display.
- The remaining number of images that can be recorded on the memory card may sometimes decrease by 2 images at once.

Card Access Display



The operating states of the memory card are shown in the center of the display.



MENU
(40)

▶ DISP. SET UP

▶▶ CARD ACCESS-ON

To turn the card access display off, open the menu and select DISP. SET UP. Then select CARD ACCESS, set it to OFF and close the menu.

File Numbers



E

The still images/movies are automatically assigned file numbers from 0101-9900 and stored in folders of 100 images each. Each folder is numbered from 101 to 998 and recorded on the memory card. Sample images have been pre-recorded on the supplied SD Memory Card, entering folder number 100 (folder name is "100canon").

Set the image file numbers so that they reset each time a new memory card is inserted, or so that they count up continuously.

1 CONTINUOUS

Numbering is continuous between cards, so that the first file number assigned on a new memory card is 1 more than the last file number assigned on the previous memory card. When the file numbers are set to CONTINUOUS, each image taken is assigned a different number, avoiding duplication of numbers. This is convenient when you want to manage your images on a PC. We recommend keeping the file numbers set to CONTINUOUS.

Three images are recorded on the card.

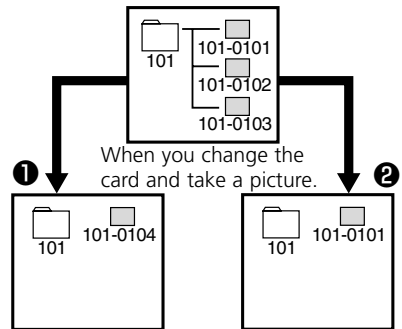

2 RESET

Each time you insert a new memory card, the file number resets to its default value (101-0101). If the card already contains files, the next available number is assigned.



MENU

(40)

▶ CARD SET UP

▶▶ FILE NOS. . . . CONTINUOUS

To change the file numbering, open the menu and select CARD SET UP. Then select FILE NOS., set it to RESET and close the menu.

Recording Still Images onto a Memory Card

E

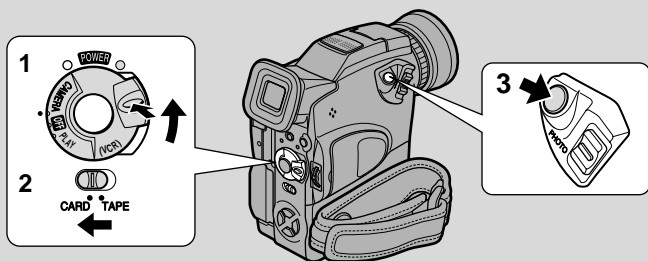

You can record still images onto a memory card. In addition to the still images you record directly onto the memory card, you can record images from a tape in the camcorder, or images input via the DV terminal or AV terminal onto the memory card.

- When you are using an SD Memory Card, make sure the protect switch is set to allow recording.
- Make sure a memory card with enough memory available is inserted into the camcorder.
- While the card access indicator flashes, do not disconnect the power source or remove the memory card. Doing so could damage the memory card.

Notes:

- To use the self-timer (75), set the self-timer before step 3, and then press the PHOTO button fully down.
- The wireless controller's PHOTO button has no half-way setting. Press the button fully and the camcorder immediately takes the image.
- When the subject is too bright (overexposure) in CARD CAMERA mode, OVEREXP. will flash in the display. We recommend that you use the built-in ND filter to reduce light entering lens.

MENU

(40)

▶CAM.SET UP

▶ND.....AUTO

Open the menu and select CAM. SET UP. Then select ND and set it to OFF and close the menu.

- When exposure is locked, OVEREXP. does not appear.

The indicators that appear in the display when recording to a memory card:

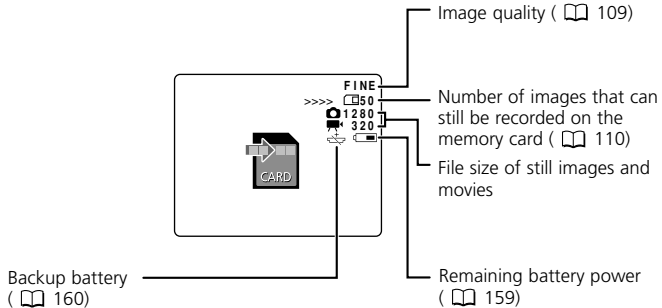

Memory Card Indication:

flashing in red: No card

in green: 6 or more images

in yellow: 1 to 5 images

in red: No more images

- All indicators light in green when a memory card is played back.
- The remaining capacity indication varies depending on the recording condition. The remaining number may sometimes not decrease or decrease by 2 images at a time.

Continuous Shooting

You can record still images shot continuously to a memory card.

CARD + **CAMERA**

MENU
(40)

▶CARD SET UP

▶▶CONT.SHOOT..OFF

1. Open the menu and select **CARD SET UP**. Then select **CONT.SHOOT.** and set it to **ON** and close the menu.
2. Press and hold the **PHOTO** button while you record still images.
 - While you press the **PHOTO** button, still images are continuously recorded onto the memory card.
3. Release the **PHOTO** button to finish recording.

Maximum continuous shots at one time

Still Images Size	Built-in Flash	Frames per Second	Maximum Continuous Shots
1280 × 960	Flash on/off	Approx. 2 frames	10 images
640 × 480	Flash on	Approx. 2 frames	10 images
	Flash off	Approx. 3 frames	30 images

* The actual number varies on the shooting conditions and subjects.



Note:

- The practical range of the flash is approx. from 3 ft 3 3/8 in (1 m) to 7 ft 6 1/2 in (2.3 m) when shooting continuously.

Recording Still Images from a Tape



E

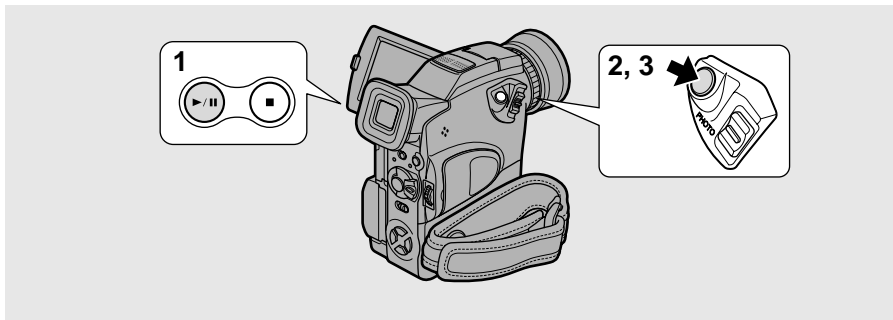

Record an image from a tape onto a memory card as still images. To automatically record multiple still images from a tape to a memory card, refer to "Copying Still Images from Tape to Memory Card" (147).

- The still image's data code will reflect the date and time it has been recorded to the memory card.
- The image size of a still image recorded from tape onto a memory card will be 640 × 480.

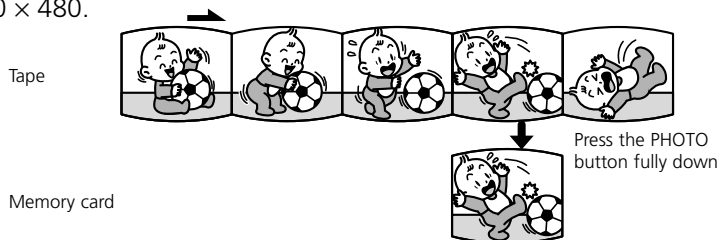

TAPE + **PLAY (VCR)**

- 1. Play back the tape.**
- 2. When the image you wish to record appears in the display, press the PHOTO button halfway down and hold it.**
 - The tape is set to playback pause mode and the number of images that can still be recorded on the memory card appears in the display.
- 3. Press the PHOTO button fully down to record the still image to the memory card.**
 - The card access indicator flashes.

Notes:

- You can also set the tape to playback pause mode in step 1 and record the image with only 1 full press of PHOTO button.
- If you record an image onto a memory card that was originally recorded in the 16:9 mode for wide screen TV's, the image will appear to be vertically "squashed" (compressed).
- The shutter sound doesn't sound in TAPE PLAY (VCR) mode.

Recording Still Images from Other Devices (VCR, TV or Other Digital Camcorders)



E

You can record images from a VCR or TV connected through the S-terminal or AV terminal (analog line-in), as well as images from other digital camcorders connected through the DV terminal onto the memory card as still images. Refer to p. 36, 92 for connecting instructions.

- The data code of the still image will reflect the date and time it has been recorded onto the memory card.
- The image size of a still image recorded from analog or digital devices onto a memory card will be 640 × 480.

Preparations



1. **Connect the camcorder to the other device.**
2. **Prepare the other device.**
3. **Load a memory card into the camcorder.**
4. **Turn the camcorder's POWER switch to PLAY (VCR) and the TAPE/CARD switch to TAPE.**
 - There is no need to load a cassette if you only record still images onto a memory card. If a cassette is inserted, make sure the cassette is in stop mode.

Recording

1. **Start playback on the other device.**
2. **When the image you wish to record appears in the display, press the PHOTO button halfway down and hold it.**
 - The image appears as a still image in the display.
 - The number of images that can still be recorded on the memory card appears in the display.
3. **Press the PHOTO button fully down to record the image to the memory card.**
 - The card access indicator flashes.



Notes:

- When dubbing to a tape via the DV terminal, make sure that AV → DV is not displayed on the screen. If so, set AV → DV OUT to OFF (p. 97).
- If you record an image onto a memory card that was originally recorded in the 16:9 mode for wide screen TV's, the image will appear to be vertically "squashed" (compressed).
- The shutter sound doesn't sound in TAPE PLAY(VCR) mode.
- The wireless controller's PHOTO button has no half-way setting. Press the button fully and the camcorder immediately takes the "photo".





E



Using a Memory Card

Recording Movies from Other Devices (VCR, TV or Other Digital Camcorders)



E

You can record images from a VCR or TV connected through the S-terminal or AV terminal (analog line-in), as well as images from other digital camcorders connected through the DV terminal onto the memory card as movies. Refer to p. 36, 92 for connecting instructions.

- The data code of the movie will reflect the date and time it has been recorded onto the memory card.

Preparations



1. **Connect the camcorder to the other device.**
2. **Prepare the device.**
3. **Insert a memory card into the camcorder.**
4. **Turn the camcorder's POWER switch to PLAY (VCR) and the TAPE/CARD switch to TAPE.**
 - There is no need to load a cassette if you only record a movie onto the memory card. If a cassette is inserted, make sure the cassette is in stop mode.

Recording

1. **Start playback on the other device.**
2. **When the image you wish to record appears in the display, press the START/STOP button.**
 - You can record up to 10 seconds in 320 × 240 and 30 seconds in 160 × 120.
 - Press the START/STOP to end recording.
 - The camcorder starts to write the movie to the memory card when recording is finished.
 - You can also start recording during record pause mode by pressing the Start/Stop button.



Notes:

- When dubbing to a tape via the DV terminal, make sure that AV ➔ DV is not displayed on the screen. If so, set AV ➔ DV OUT to OFF (p. 97).
- If you record a movie to a memory card that was originally recorded in the 16:9 mode for wide screen TVs, the image will appear to be vertically "squashed" (compressed).

Recording Panoramic Images (Stitch Assist)



E

You can merge separate images into one large panoramic scene using the supplied software (PhotoStitch) on a PC. You can shoot a subject that won't fit into a single frame, such as a landscape, and stitch it together later.

Recording

Photo Stitch detects the overlapping portions of adjoining images and merges them. When recording, try to include a distinctive item (landmark, etc.) in the overlapping portions.

CARD + **CAMERA**

MENU
(40)

▶▶STITCH AST

1. Turn the **POWER** switch to **CAMERA** and the **TAPE/CARD** switch to **CARD**.
2. Open the menu and select **▶ STITCH AST**.
 - Select the direction with the **CARD +/-** button. Press the **CARD +** button to move clockwise, press the **CARD -** button to move counter-clockwise.
3. Set the recording program and zoom on the subject.
 - If necessary, set the focus and exposure manually.
 - After the first image, recording program, zoom, exposure and flash mode cannot be changed.
4. Press the **PHOTO** button to record the first image.
 - Direction and number of recorded images will be shown on the display.
5. Orient the camcorder so that the second frame overlaps a small portion of the first image and press the **PHOTO** button to take the next image.



- Do not worry about minor discrepancies in the overlapped area because the computer software can compensate for them when the images are merged.
 - You can retake images by pressing the **CARD -** button to return to the previous image.
 - A maximum of 26 images may be recorded.
 - Follow the same steps to shoot subsequent images in the sequence.
6. Finish the sequence by pressing the **MENU** button after the last image has been recorded.
 - Refer to the **DIGITAL VIDEO SOLUTION DISK** Software Instruction Manual for instructions on how to stitch them together.

**Notes:**

- The overlapped area should be set between 30 to 50% of the frame. Discrepancies above and below the frame can be automatically compensated if within 10%.
- Make sure that no moving subject is included in the overlapping area.
- Do not try to stitch images that include both distant and close items. Objects may appear warped or doubled up.
- The  (red-eye reduction auto) of the flash cannot be used in stitch assist mode.
- There will be no continuous shooting even if it is set to ON.

Playing Back a Memory Card

E

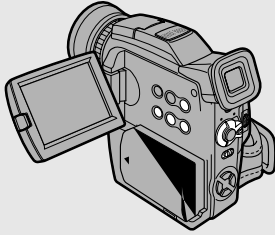

● Single Image



1. Turn the **POWER** switch to **PLAY (VCR)**.
2. Move the **TAPE/CARD** switch to **CARD**.
 - The last still image/movie recorded appears in the display.
 - Movies will be displayed with the first scene as a still image.
3. Search for the desired still image/movie by pressing the **CARD +/-** buttons.
 - Press + to view the next still image/movie and – to view the previous still image/movie.
 - Pressing + at the last still image/movie will take you to the first still image/movie. Pressing – at the first still image/movie will take you to the last still image/movie.

Movies: Pressing ►/|| plays back the movie and will show the last scene as a still image when playback ends. Pressing ►/|| during playback will stop the movie and the scene is shown as a still image. Pressing ►/|| again will restart the playback.

● Card Search Function

You can quickly search for still images/movies while viewing thumbnails (small images).



With a still image/movie in the display, press and hold the CARD +/- button.

- Press the + button to search forwards and press the – button to search backwards.
- When you release the button, the thumbnail displays as full size still image/movie.
- The image size is not displayed during the search.

● Slide Show



With a still image/movie in the display, press the **SLIDE SHOW** button.

- Still images are automatically played back one after another.
- Movies are played back normally.

To stop the slide show, press the SLIDE SHOW button.

- The slide show starts or stops each time you press the SLIDE SHOW button.

● Index Screen

Up to 6 still images/movies appear at once, allowing you to search quickly through the still images/movies. Movies will be displayed with the first scene as a still image, indicated by a movie frame.



1. With a still image/movie in the display, press the INDEX SCREEN button.

- Up to 6 images appear in the display.

2. Move the frame to the still image/movie you wish to view.

- Turn the selector dial downwards to go to the previous still image/movie and upwards to go to the next still image/movie.
- Turning the dial upwards at the last still image/movie will take you to the next index screen. Turning the dial downwards at the first still image/movie will take you to the previous index screen.
- Jump to the next/previous index screen with the CARD +/- buttons.

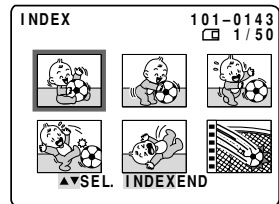

3. Press the INDEX SCREEN button.

- The still image/movie you have marked fills the whole display.

Settings of Still Images/Movies

E

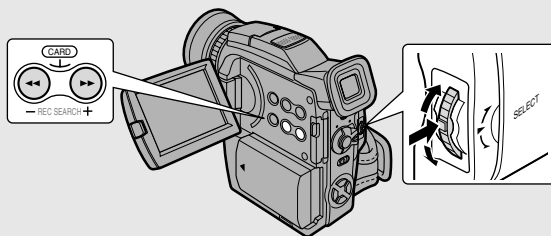

You can easily erase unwanted still images/movies recorded to the memory card while viewing them, protect them from accidental erasure, or mark a still image for printing. (File Operation)

- File Operation is set in CARD PLAY (VCR) mode.

● Preventing accidental erasure (Protect ON)

Select important still images/movies and protect them from accidental erasure.

- If a memory card is formatted, however, all still images/movies, including protected still images/movies, will be permanently erased.
- Movies can only be protected when the first or last scene is displayed as a still image. They cannot be protected during playback pause.
- The pre-recorded sample images provided on the supplied SD Memory Card are already protected.

There are 2 ways to protect still images/movies (including the ways to cancel the setting).

1. **CARD** + **PLAY (VCR)** \Rightarrow File Operation menu **SINGLE** (127)
2. **CARD** + **PLAY (VCR)** \Rightarrow Card Operations submenu **INDEX** (128)

● Marking a still image for printing (Print Mark ON)

A still image on a memory card must be marked before it can be printed. The camcorder supports the DPOF (Digital Print Order Format) print format.

Still images can be automatically printed on a DPOF-supporting Canon Printer.

- Movies cannot be marked for printing.
- The maximum number for print marks on the camcorder is limited to 200.

There are 3 ways to mark a still image for printing (including the ways to cancel the setting).

To mark a still image for printing or erase print marks one at a time

1. **CARD** + **PLAY (VCR)** \Rightarrow File Operation menu **SINGLE** (127)
2. **CARD** + **PLAY (VCR)** \Rightarrow Card Operations submenu **INDEX** (129)

To erase all print marks

3. **CARD** + **PLAY (VCR)** \Rightarrow Card Operations submenu **SINGLE** (130)

● Erasing still images/movies

Erase still images/movies singly or all at once.

- You cannot erase protected still images/movies. Cancel image protection first in order to erase an image.
- Erase still images/movies with caution. Once a still image/movie has been erased, it cannot be restored.
- When movies are displayed with the first and last scene as still images, you can erase them. When the camcorder sets to playback pause mode by press pause button during playing back movie, you cannot erase them.

There are 2 ways to erase a single still image/movie.

To erase still images/movies one at a time

1. **CARD** + **PLAY (VCR)** ⇒ File Operation menu **SINGLE** (127)



To erase still images/movies one at a time or erase all still images/movies on the memory card at once

2. **CARD** + **PLAY (VCR)** ⇒ Card Operations submenu **SINGLE** (131)





SINGLE: When playing back still images/movies in CARD PLAY (VCR) mode

INDEX: When displaying an index screen in CARD PLAY (VCR) mode







1. **With a still image/movie in the display, press the selector dial in to open the FILE OPER. menu.**
 - PROTECT , PRINT MARK , and IMAGE ERASE settings appear.
 - If you select RETURN, the menu disappears from the display.

To protect a still image/movie

2. **Select PROTECT  and press the selector dial in.**
 - The  protect mark appears on the still image/movie.
 - Now you are unable to erase this still image/movie.
 - Press the selector dial again to cancel it.
 - If you select RETURN, the menu disappears from the display.
 - To cancel image protection, select PROTECT  and press the selector dial in.  disappears and now you can erase this still image/movie.

To mark a still image for printing (Print Mark)

2. **Select PRINT MARK , set the number of prints with the selector dial and press the selector dial in.**
 - The  print mark appears on the still image.
 - If you select RETURN, the menu disappears from the display.
 - To cancel a print mark, select PRINT MARK , set the number of prints to 0 (Zero) with the selector dial and press the selector dial in.  disappears.

To erase a still image/movie

2. **Select IMAGE ERASE and press the selector dial in.**
 - ERASE THIS IMAGE? NO YES appears in the display.
 - If you select RETURN, the menu disappears from the display.
3. **Select YES and press the selector dial in.**
 - The still image/movie is erased.
 - One still image/movie before the erased still image/movie appears.

Preventing Accidental Erasure (Protect)

E

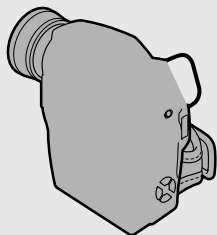

Marking a Still Image for Printing (Print Mark)



E

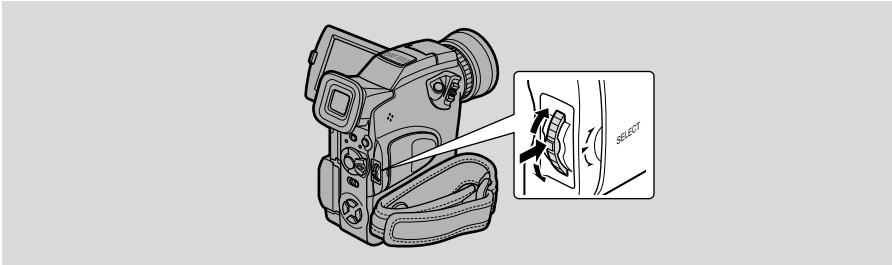

This section describes how to mark the still image for printing from Card operation submenu in CARD PLAY (VCR) mode (including the way to cancel the setting).

- When displaying an index screen, you can mark the still image for printing.
 - When playing back a single still image, you can erase all print marks.
 - Movies cannot be marked for printing. The frame on the index screen will turn purple, indicating that the movie cannot be selected for print mark.
 - The maximum number for print marks on the camcorder is limited to 200.
- You can also mark a still image for printing through File Operation menu (☞ 127).

Marking a Still Image for Printing While Viewing an Index Screen



MENU
(☞ 40)

▶CARD OPER.



▶▶PRINT MARK ▶

Make sure a memory card that has a still image recorded on it has been inserted into the camcorder.

- 1. With a still image in the display, press the INDEX SCREEN button.**
 - Up to 6 images appear in the display.
 - Move the frame to the still image that you wish to mark for printing (Index Screen ☞ 124).
- 2. Open the menu and select CARD OPER.**
- 3. Select ▶▶PRINT MARK ▶ and set the number of prints with the selector dial.**
- 4. Press the selector dial in.**
 - The ▶ print mark appears next to the still image.
- 5. Close the menu.**

 **Notes:**

- To cancel a print mark, move the frame to the print-marked still image, set the number of prints to 0 (Zero) with the selector dial and press the selector dial in. The  print mark disappears.
- If there are a large number of images recorded on the memory card, it may take time for a print mark to appear on a still image.

Erasing All Print Marks



MENU



( 40)

▶ CARD OPER.



▶ PRINT MARKS  ALL ERASE

Make sure a memory card that has a still image recorded on it has been inserted into the camcorder.

1. **With a still image in the display, open the menu and select CARD OPER.**
2. **Select PRINT MARKS  ALL ERASE.**
 - ERASE ALL PRINT MARKS  ? YES NO appears in the display.
3. **Select YES.**
 - The  print mark disappears from the still image.
4. **Close the menu.**

Erasing Still Images/Movies



E

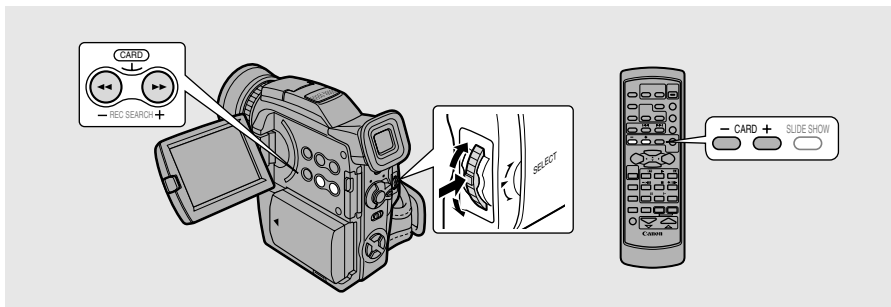

This section describes how to erase the still image/movie from the Card Operation submenu when playing back a single still image/movie in CARD PLAY (VCR) mode. (SINGLE or ALL)

You can also erase a still image/movie through File Operation menu (127).

CARD + **PLAY (VCR)**

MENU

(40)

▶CARD OPER.



▶IMAGE ERASE

Make sure a memory card that has still images/movies recorded on it is inserted into the camcorder.

To erase still images/movies one at a time

1. Select the still image/movie you wish to erase.

- Use the index screen (124) or card search function (123) if necessary and make sure the still image/movie you wish to erase fills the display.
- If you use the index screen, press the INDEX SCREEN button after selecting the still image/movie. The still image/movie you selected fills the whole display.

2. Open the menu and select CARD OPER.

3. Select IMAGE ERASE.

- CANCEL, SINGLE and ALL settings appear.
- To cancel erasing, select CANCEL and close the menu.

4. Select SINGLE.

- ERASE THIS IMAGE? NO YES appears in the display.

5. Select YES.

- The still image/movie erases and the previous still image/movie appears for erasing.
- To erase another single still image/movie, move to that still image/movie with the CARD +/- buttons, and select YES.
- If the still image/movie you are trying to erase is a protected still image/movie, YES appears in purple and is unselectable.
- If you select NO, you return to step 4.

6. Close the menu.

To erase all still images/movies on the memory card at once

1. Open the menu and select CARD OPER.**2. Select IMAGE ERASE.**

- CANCEL, SINGLE and ALL settings appear.
- To cancel erasing, select CANCEL and close the menu.

3. Select ALL.

- ERASE ALL IMAGES? [EXCEPT FOR  IMAGES] NO YES appears in the display.

4. Select YES.

- All still images/movies except the protected ones are erased.
- If you select NO, you return to step 2.

5. Close the menu.

Using Printers Supporting the Direct Print Function (Optional)

E

You can print still images by connecting the camcorder directly to a printer supporting the direct print function. It can also be used with the print mark settings (☞ 129).

- Printers supporting the direct print function (As of August 2002): Canon CP-10/CP-100 Card Photo Printer, Canon Bubble Jet Printer S820D/S830D/S530D.
- Two direct interface cables are supplied with the Card Photo Printer. Use the cable with the USB logo on the connector (DIF-100).
- We recommend that you use a household power source to power the camcorder when it is connected to the printer.
- Also refer to the instruction manual of the respective printer for further details.
- Observe following precautions during printing, otherwise printing may not be performed correctly.
 - Do not turn off the camcorder or the printer.
 - Do not change the position of the TAPE/CARD switch.
 - Do not detach the interface cable.
 - Do not open the memory card cover.
 - Do not remove the memory card.

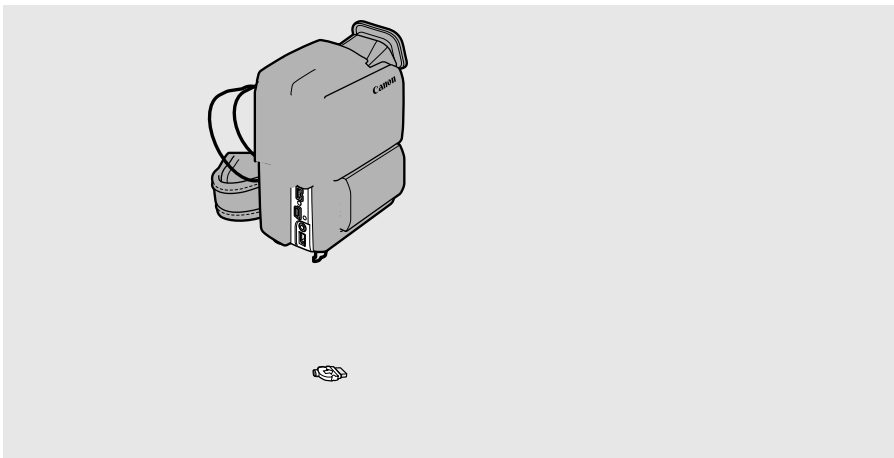

Connecting the printer to the camcorder

1. Turn the **POWER** switch of the camcorder to **OFF**.
2. Attach a power source to the printer.
3. Connect the printer to the camcorder using the interface cable.
4. Turn on the power of the printer.
 - If your printer is not equipped with a power switch, it turns on when attaching a power source. Move on to step 5.

5. Turn the POWER switch on the camcorder to PLAY (VCR) and the TAPE/CARD switch to CARD.

- "Print»SET" appears when the printer is correctly connected to the camcorder (does not appear with movies, or still images that cannot be played back with the camcorder).

Printing

You can set the number of copies (📖 135), standard/multiple (📖 136), paper size (📖 136) and bordered/borderless (📖 136), or trim the image (📖 138).



During Playback (Single Image)

1. Select the still image you wish to print.
2. Press the selector dial in.
 - The print dialog appears.



3. Make sure that [Print] is selected and press the selector dial in.

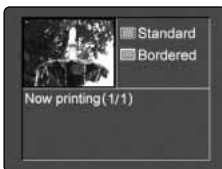

- Printing starts and, when it is completely finished, the display will return to playback mode.
- If you wish to continue printing, select the next still image with the CARD+ or CARD- button.

Printing Errors

- If an error occurs during printing, error messages such as "NO INK", "PAPER JAM" or "NO PAPER" will display. Select [Stop] or [Restart] with the selector dial and press the selector dial in.

- With the Card Photo Printer, the [Restart] setting may not appear with some error messages. In that case, select [STOP].
- With the BJ Printer, the [Continue] and [Stop] options may appear with some error messages. The error number is displayed on the operation panel of the Bubble Jet Printer. Please refer to the Bubble Jet Printer Quick Start Guide for the remedies corresponding to the error numbers.

Cancel Printing

Press the selector dial in while the [Now printing] dialog is displayed. A confirmation dialog displays. Make sure that [OK] is selected and press the selector dial in.

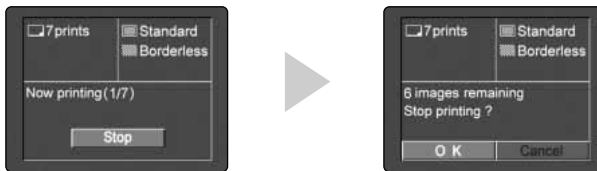

- With the Card Photo Printer, a print in progress cannot be stopped. Printing of the next still images will be cancelled and the display will return to playback mode. With the BJ Printer, printing stops even if it is incomplete and the paper is fed through.

Selecting the number of copies

You can set the number of copies to a maximum of 9 prints.

- 1. Pull the selector dial up or down so that [SET] appears next to [Copies] and press the selector dial in.**



- 2. Pull the selector dial up or down to specify the number of copies and press the selector dial in.**



Setting the print style

If you wish to change the print style, change the style settings before trimming.

Card Photo Printer:

Image	Standard	Prints 1 still image per page.
	Multiple*	Prints 8 copies of the same still image on one page.
Borders	Borderless	Prints right to the edges of the page.
	Bordered	Prints with a border.

* Can only be selected when printing on card size paper.

- [Borders] cannot be selected when the image style is set to [Multiple].

BJ Printer:

Paper Size*		Select the paper size from the following: [Card #1], [Card #2], [Card #3], [LTR] or [A4] Paper. For the usable paper type, refer to the Bubble Jet Printer User Guide.
Borders	Borderless	Prints right to the edges of the page
	Bordered	Prints with a border

* Recommended paper size: card size

1. On the print dialog, pull the selector dial up or down to select [Style] and press the selector dial in.

- The dialog for selecting the style appears.



Card Photo Printer: Selecting the Image Style (Standard/Multiple)

2. Press the select dial in.

- The dialog for selecting the image style appears.



3. Pull the selector dial up or down to select [Multiple] and press the selector dial in.



4. Press the Menu button.

BJ Printer: Selecting the Paper Size

2. Press the selector dial in.
 - The dialog for selecting the paper size appears.

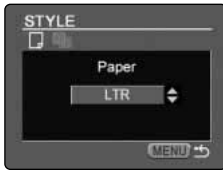

3. Pull the selector dial up or down to select the paper size and press the selector dial in.



4. Press the MENU button.

Selecting the Borders (Bordered/Borderless)

2. Pull the selector dial down.
 - The dialog for selecting the [Borders] appears.



3. Press the selector dial in.

- [Bordered] and [Borderless] settings appear.



4. Select [Borderless] and press the selector dial in.



5. Press the Menu button.

Notes:

- With the [Bordered] option, the area of the printed image is practically the same as the recorded image.
- If [Borderless] or [Multiple] is selected as the print style, the center portion of the recorded image is printed at an enlarged size. As a result, the image's top, bottom and sides may be cropped slightly.
- The [Borders] setting cannot be selected when the image style is set to [Multiple]. The image will be printed with the borders set to [Borderless].

Trimming (Printing a Portion of an Image)

If you wish to change the print style, change the style settings before trimming.

1. On the print dialog, select [Trimming] and press the selector dial in.

- The trimming frame appears at the center of the image.



2. Trim the image.

Changing the Size of the Trimming Frame:

Move the zoom lever toward T to shrink the frame, and toward W to enlarge the frame.

You can cancel the trimming setting by moving the zoom lever toward W when the trimming frame is already set to the maximum size. The trimming frame disappears. If you press the MENU button, you return to the print dialog.



Moving the Trimming Frame:

Use the ▲ and ▼ buttons to move the frame up or down, and the ► or ◀ buttons to move the frame to the right or left.



3. Press the MENU button.

- You return to the print dialog.
- The trimming setting is cancelled when you select another image using the CARD +/- buttons.



4. Pull the selector dial up or down to select [Print] and press the selector dial in.

- Printing starts and when it is completely finished, the display will revert to the playback mode.

About the Color of the Frame:

White: No trimming settings.

Green: Recommended trimming size.

Red: The image is magnified beyond recommended size. The image may print out coarsely.



MENU

(40)



1. Connect the printer to the camcorder.
2. Turn the POWER dial to PLAY (VCR) and the TAPE/CARD switch to CARD.
3. Press the MENU button.
 - C. PLAY MENU settings appear.
4. Pull the selector dial up or down to select ➔ PRINT and press the selector dial in.
 - The print dialog appears.
5. If you wish to print without changing the style settings, make sure [OK] is selected and press the selector dial in.
 - Printing starts and, when it is completely finished, the display will return to playback mode.
 - For changing the style settings, see "Setting the Print Style" (136).

Cancel Printing

Press the selector dial in while the [Now printing] dialog is displayed. A confirmation dialog displays. Make sure that [OK] is selected and press the selector dial in.

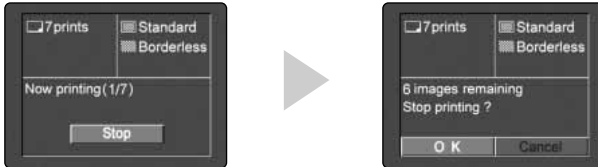

- With the Card Photo Printer, a print in progress cannot be stopped. Printing of the next still images will be cancelled and the display will return to playback mode. With the BJ Printer, printing stops even if it is incomplete and the paper is fed through.

Restarting Printing

- Open the C.PLAY menu and select **➔** **PRINT**. Select [Restart] on the print dialog and press the selector dial in. The remaining still images will be printed.
- Printing cannot be restarted in the following circumstances:
 - When you have changed the print mark settings.
 - If you have deleted a still image marked for printing.

Printing Errors

- If an error occurs during printing, error messages such as "NO INK", "PAPER JAM" or "NO PAPER" will display. Select [Stop] or [Continue] with the selector dial and press the selector dial in.
- With the Card Photo Printer, the [Restart] setting may not appear with some error messages. In that case, select [STOP].
- With the BJ Printer, the [Continue] and [Stop] options may appear with some error messages. The error number is displayed on the operation panel of the Bubble Jet Printer. Please refer to the Bubble Jet Printer Quick Start Guide for the remedies corresponding to the error numbers.

When Disconnecting the Interface Cable:

Follow below procedure when disconnecting the interface cable.

- 1. Disconnect the cable from the camcorder and printer.**
- 2. Turn off the camcorder.**



E

Enhance the appearance of your recordings by combining still images from the memory card with camcorder recordings. You may select from pre-recorded cartoon-like frames, or create personal frames and titles that can be layered over movies or still images. In addition, you can combine your recordings with animations from the memory card.

- You cannot combine movies recorded onto the memory card with the camcorder recordings.

This section explains following procedures:

Combining Still Images from a Memory Card with Camcorder Recordings (142)

Combining Animations from a Memory Card with Camcorder Recordings (145)

Recording the Combined Image onto a Tape (146)

Notes:

- Some card mix sample images have been pre-recorded onto the supplied memory card. However, you can add more sample images from the supplied DIGITAL VIDEO SOLUTION DISK.
Card Chroma Key: 3 Card Luminance: 3
Camera Chroma Key: 2 Card Animation: 4
- For instruction on how to add sample images to the memory card, refer to "Adding Still Images from Your Computer to the Memory Card" in the DIGITAL VIDEO SOLUTION DISK Software Instruction Manual.

Combining Still Images from a Memory Card with Camcorder Recordings

Select from 3 types of Card Mix effects:

CARD CHROMA (Card chroma key)

Combine the image you are recording with a still image as a frame. The image will be shown instead of the blue area of the still image. When recording your own "frame", make sure that the area you wish the other image to appear is blue.

Adjustment of the MIX LEVEL: blue area of the still image.

Image being recorded
by the camcorder

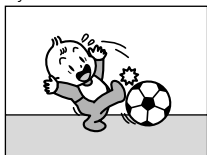

+

Still image



→



CARD LUMI. (Card luminance key)

Combine the image you are recording with illustrations or titles. The image will be shown instead of the light area of the still image. Create your own title or illustration by drawing or writing on a white paper and recording it to the memory card.

Adjustment of the MIX LEVEL: light area of the still image

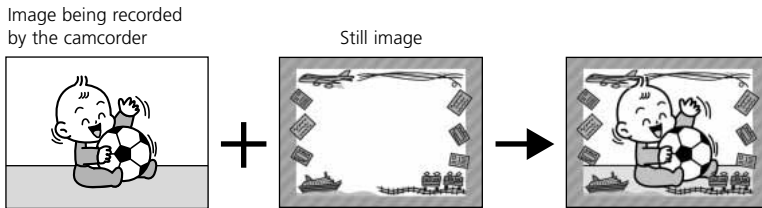

CAM. CHROMA (Camera chroma key)

Combine the image you are recording with a still image as the background. Shoot the subject in front of a blue background, such as a blue curtain, and the subjects not blue will be superimposed on the still image.

Adjustment of the MIX LEVEL: blue area of the image you are recording



Mix level

The mix level bar appears. Adjust the mix level using the – and + at the ends of the bar as guides.

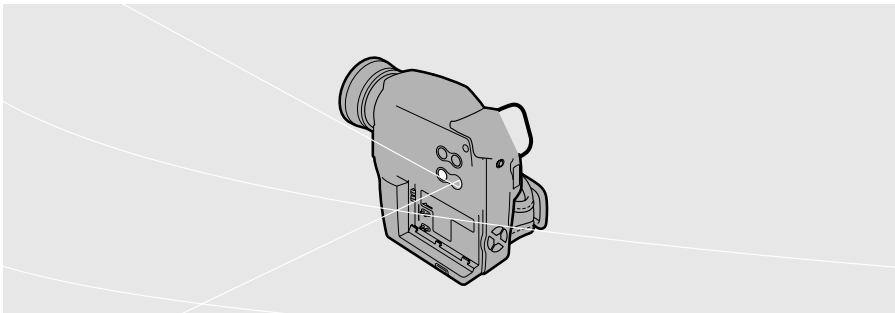

TAPE + CAMERA

MENU

(40)

▶▶CARD MIX

▶▶MIX TYPE...CARD CHROMA

▶▶MIX LEVEL...

Make sure a memory card that has images recorded on it and a cassette have been inserted into the camcorder.

Select

1. Make sure the camcorder is set to the \odot (program AE) mode.

- You cannot use Card Mix in the Night or Super Night recording program.

2. Open the menu and select \Rightarrow CARD MIX.

3. Press the CARD +/- buttons to select the still image to be combined.

4. Select MIX TYPE.

- CARD CHROMA, CARD LUMI., CAM. CHROMA and C.ANIMATION settings appear.

5. Select the desired setting.

- Your currently recording image is combined with the pre-recorded still image.

6. Select MIX LEVEL.

7. Adjust the mix level.

- Turning the selector dial upwards adjusts to the right and turning downwards adjusts to the left.

8. Close the menu.

- CARD MIX flashes in the display.

On/Off

9. Press the CARD MIX button.

- CARD MIX stops flashing.
- Your currently recording image is combined with the pre-recorded still image.
- Each time you press the card MIX button, your selection is activated (display lights continuously) or deactivated (display flashes).

Combining Animations from a Memory Card with Camcorder Recordings

Combine the image you are recording with animation.

Select from 3 types of Card Animation effects.

Corner: Animation appears on the upper left and the lower right corner in the display.

Straight: Animation appears on the top and bottom in the display and moves on the right and left.

Random: Animation moves randomly in the display.

Image being recorded
by the camcorder

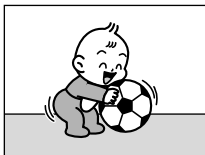

+

Animation

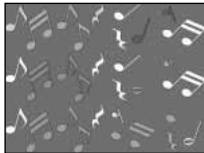

→



12 animation samples have been pre-recorded on the supplied memory card. These sample images are protected.

Adjustment of the MIX LEVEL: blue area of the animation image.

TAPE + **CAMERA**

MENU

(40)

▶CARD MIX

▶MIX TYPE...C.ANIMATION

▶ANIM TYPE...CORNER

Make sure a memory card that has animations recorded on it and a cassette have been inserted into the camcorder.

Select

1. Make sure the camcorder is set to the **Q** (program AE) mode.

- You cannot use Card Mix in the Night or Super Night recording program.

2. Open the menu and select **→ CARD MIX**.

3. Press the **CARD +/-** buttons to select the animation to be combined.

4. Select **C.ANIMATION**.

5. Select **ANIMAT.TYPE**.

- CORNER, STRAIGHT and RANDOM settings appear.

6. Select the desired setting.

- Your currently recording images is combined with the pre-recorded animation.

7. Select MIX LEVEL.**8. Adjust the mix level.****9. Close the menu.**

- CARD MIX flashes in the display.

On/Off

10. Press the card MIX button.

- CARD MIX stops flashing.
- Your currently recording image is combined with the pre-recorded animation.
- Each time you press the card MIX button, your selection is activated (display lights continuously) or deactivated (display flashes).

Recording the Combined Image onto a Tape

For movies

1. Press the start/stop button to start and stop recording.

- The combined images are recorded onto the tape.

For still images

1. Press the PHOTO button halfway down and hold it.

- F flashes white in the display as the camcorder adjusts the focus and it is displayed continuously as a green mark when the camcorder is ready to take the image.

2. Press the PHOTO button fully down to record the image to the tape.

- F disappears from the display.
- The combined images are recorded onto the tape for approximately 6 seconds.

**Note:**

- If you change the position of the POWER switch or TAPE/CARD switch, select your still image for Card Mix again.

Copying Still Images from Tape to Memory Card



E

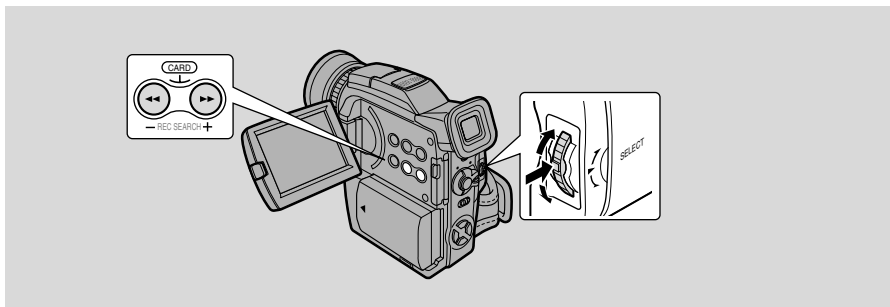

Copies multiple still images from a tape to the memory card, using the Photo Search function.

- The still images' data codes will reflect the date and time the copies are made.
- The image size of a still image copied from tape to memory card will be 640 × 480.



MENU
([] 40)



Make sure a memory card that has enough memory available and a recorded tape have been inserted into the camcorder.

1. Locate the first still image on the tape that you wish to copy and stop the tape at a point before that image.

- All the still images on the tape after that point will be copied onto the memory card.
- If you want to copy all the images on a tape, rewind the cassette to the beginning.

2. Open the menu and select **CARD OPER.**

3. Select **COPY [] []**.

- CANCEL and EXECUTE settings appear.

4. Select **EXECUTE.**

- Select CANCEL to stop copying.
- Tape and card information appear in the display and copying starts.
- NOW COPYING [] [] appears in the display.
- The camcorder automatically performs the Photo Search function to locate still images and copying starts. The currently copying image appears in the display.
- Copying stops when the tape is finished or the memory card is full. When the memory card is full, CARD FULL will appear in the display.

5. Press the stop button when your desired images have finished copying.

Copying Still Images from Memory Card to Tape

E



Using a Memory Card

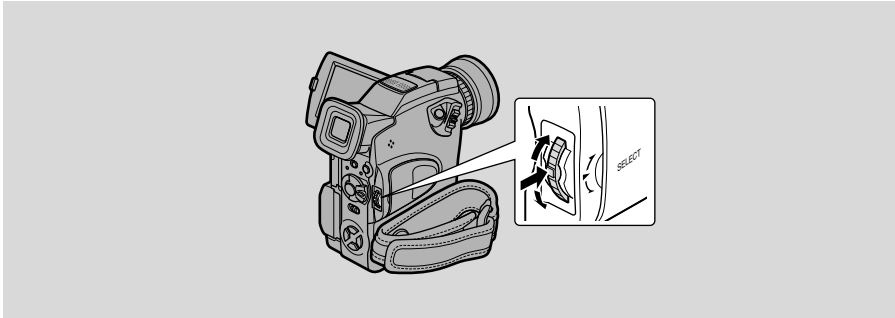

Format new memory cards, if you get the message CARD ERROR, or to permanently and quickly erase all the still images/movies on a memory card, including protected still images/movies (this includes the pre-recorded card mix sample images).

The SD Memory Card supplied with this camcorder has already been formatted for you.

- Be cautious when formatting recorded memory cards. All still images/movies will be permanently erased.
- If you use memory cards other than the supplied one, make sure to format them with the camcorder, not a PC or other device.



MENU
(40)



Make sure a memory card is inserted into the camcorder.

1. Open the menu and select CARD OPER.

2. Select FORMAT.

- CANCEL and EXECUTE settings appear.

3. Select EXECUTE.

- Select CANCEL to cancel formatting.
- FORMAT THIS CARD? NO YES appears to confirm.

4. Select YES.

- Formatting starts.
- If you select NO, you return to step 3.

5. Close the menu.

Connecting to a PC Using a USB Cable

E

You can download still images/movies from a memory card to a PC connected via the USB interface. By using the provided software, you can organize and store still images/movies and print out still images with added titles or frames.

Use the USB cable and the Canon DIGITAL VIDEO SOLUTION DISK/ArcSoft Camera Suite CD with the camcorder.

- For transferring still images and movies from tape or memory card to your PC using a DV cable, see p. 106.

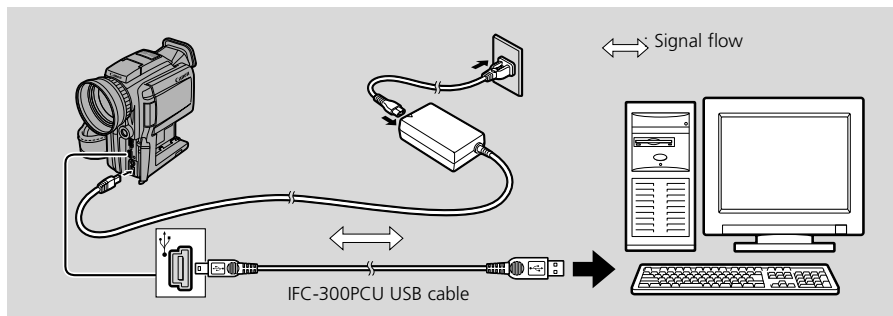

For details on how to connect the camcorder to a PC and install and operate the software, refer to the Canon DIGITAL VIDEO SOLUTION DISK Software Instruction Manual.

- Refer also to your PC manual.

"PC CONNECT [USB]" appears to indicate that the camcorder is connected to the PC with a USB cable.

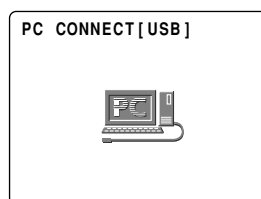

Cautions:

- Do not disconnect the USB cable, remove the memory card, or turn off the camcorder or the computer while data is being transferred (while the camcorder's card access indicator is flashing). Doing so may damage the memory card's data.
- The connection may not work properly depending on the specifications and settings of the software and PC.
- The image files on your memory card and the image files you have stored (downloaded) to the hard disk drive of your computer are your valuable, original data files. If you wish to use image files on your computer, be sure to make copies of them first, and use the copied file, retaining the original.

Using the My CAMERA Function

You can change the start-up image and sound, shutter sound, start/stop sound and self-timer sound.

E

Changing the Start-up Image, Start-up Sound, Start/Stop Sound, Shutter Sound or Self-Timer Sound

TAPE + CAMERA , TAPE + PLAY (VCR) , CARD + CAMERA , CARD + PLAY (VCR)

MENU

(40)

▶MY CAMERA

▶SEL.S-UP IMG·DEFAULT

▶SHTR SOUND···PATTERN1

▶S-UP SOUND···PATTERN1

▶S/STOP SOUND·PATTERN1

▶SELF-T SOUND·PATTERN1

1. Press the MENU button.

- The main menu appears.

2. Select MY CAMERA.

3. Select the item you wish to set.

- When you select the start-up image, OFF, DEFAULT, PATTERN1 and PATTERN2 appear. The image saved as DEFAULT cannot be changed.
- When you select an item other than the start-up image, PATTERN1, PATTERN2 and PATTERN3 appear. Moving the ▶ before the setting allows you to check the sound.

4. Select the setting and close the menu.

Creating a Start-up Image

You can create a start-up image by using a still image recorded on the memory card.

Record a still image with your camcorder, or download a still image from the ZoomBrowser EX (for Windows) or ImageBrowser (for Macintosh) contained in the DIGITAL VIDEO SOLUTION DISK, and set it as start-up image.

- For instructions on how to download the start-up image, refer to the DIGITAL VIDEO SOLUTION DISK Software Instruction Manual or the PDF manual "ZoomBrowser EX Software User Guide" or "ImageBrowser Software User Guide" contained in the DIGITAL VIDEO SOLUTION DISK.

Make sure a memory card with enough available memory is inserted into the camcorder.



MENU

(40)

▶MY CAMERA



▶CREATE START-UP IMAGE

1. Turn the **POWER** switch to **PLAY (VCR)** and the **TAPE/CARD** switch to **CARD**.
2. Open the menu.
3. Select **MY CAMERA**.
4. Select **CREATE START-UP IMAGE**.
 - SET THIS AS START-UP IMAGE? YES NO appears.
5. Select the image you wish to save as start-up image with the **CARD +/-** buttons.
 - SAVE AS ➔ ORIGINAL1, ➔ ORIGINAL2, CANCEL appears.
6. Select **ORIGINAL1 (ORIGINAL2)**.
 - OVERWRITE ORIGINAL1 (ORIGINAL2)? YES NO appears.
7. Select **YES**.
 - The start-up image will be saved. The start-up image that was saved in the same location will be erased.
 - If you select NO, you return to step 6.

Other Information and Precautions

E

The camcorder formats memory cards in DCF (Design rule for Camera File system).

Still images/movies recorded on a memory card with this camcorder can also be transferred to a PC with the use of the following products made for SD Memory Cards or MultiMediaCards:

PC Card Adapter: Holds a memory card then inserts into the PC card slot found on most types of laptop PCs.

FD Adapter: Holds a memory card then inserts into a PC's floppy disk drive.

Memory Cards confirmed to operate with this camcorder (as of June 2002)

SD Memory Card—

Panasonic: 8 MB, 16 MB, 32 MB, 64 MB

SanDisk: 8 MB, 16 MB, 32 MB, 64 MB

MultiMediaCard—

SanDisk: 8 MB, 16 MB, 32 MB, 64 MB

- However, we cannot guarantee that all of these memory cards work properly.

If you mistakenly erase the card mix sample images provided on the SD Memory Card, they can be downloaded from the following home page:*

<http://www.canondv.com>

*If you are unable to connect the camcorder to a PC using a USB cable, you will need a PC Card Adapter or USB Card Reader to be able to download to a memory card.

Memory Card Operating Precautions

- If you purchase additional memory cards, format them with the camcorder, not a PC or other device. There have been cases where memory cards formatted with a PC or other device do not function properly.
- We recommend saving backups of memory card images on your PC's hard drive or other external memory device. Image data may be damaged or lost due to a defect in a memory card, or if a memory card is exposed to static electricity. Contents of a memory card cannot be compensated for should data become damaged or lost.
- Do not remove the power source or the memory card while the card access indicator flashes.
- Do not use memory cards in places subject to strong magnetic fields.
- Do not disassemble memory cards.
- Do not bend or drop memory cards, or expose them to strong vibrations or external shocks.

E

- Do not get memory cards wet.
- Do not remove the memory card's label or affix other labels. Affix labels to the memory card's case.
- Do not leave memory cards in places subject to high temperature or high humidity.
- Moving a memory card rapidly between hot and cold temperatures may cause condensation to form on it, leading to malfunctions. Avoid this problem by placing the memory card in a plastic bag and letting it slowly adjust to temperature changes before removing it from the bag. If condensation should occur, maintain the memory card at a constant temperature and let the moisture evaporate naturally.
- Do not touch the memory card's terminals or let dust or dirt come in contact with the terminals. Store and carry memory cards in their case to protect the terminal area.
- There is only one correct way to insert memory cards into the camcorder. Do not forcefully insert the memory cards backwards or upside down. This could damage the memory card or the camcorder.

Sample Images

- The following are the sample images that have been pre-recorded on the supplied SD Memory Card. There are a total of 27 images: 8 card chroma key images, 5 card luminance key images, 2 camera chroma key images and 12 card animation images.

Card chroma key

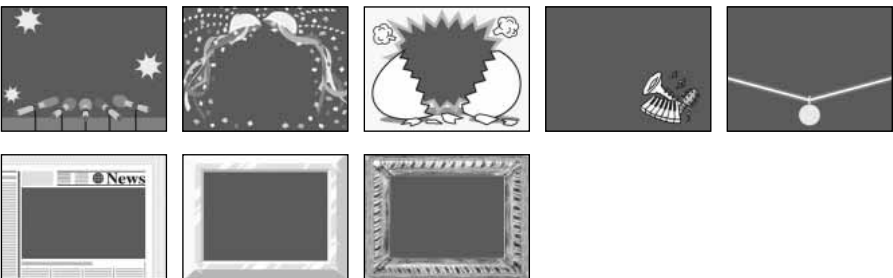

Card luminance key



Camera chroma key

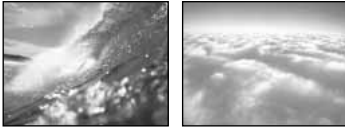

Card animation

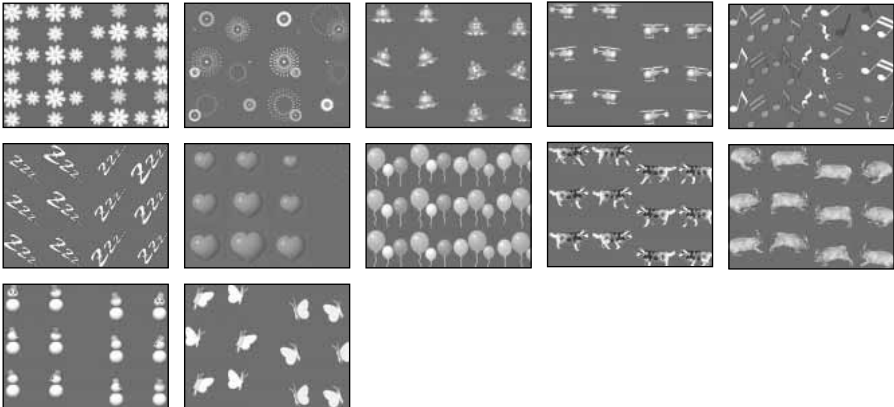

- The pre-recorded sample images on the supplied SD Memory Card are intended solely for the personal enjoyment gained from combining them with personal videos taken with this camcorder. Do not use the pre-recorded sample images for any other purpose.

SD Memory Card SDC-8M Specifications

Capacity	8 MB
Interface	SD Memory Card standard
Operating temperature range	32°F– 140°F (0°C–40°C)
Dimensions	1 1/4 × 1 × 1 1/8 in (32 × 24 × 2.1 mm)
Weight	1/8 oz (2 g)

Weight and dimensions are approximate.
 Errors and omissions excepted.
 Subject to change without notice.

PhotoEssentials - Royalty Free Stock Photography

The PhotoEssentials suite of royalty-free images on CD-ROM features premium quality assignment photography and is ideally suited for use in advertising, brochures, reports, multimedia, websites, books, packaging and more.

For more information, please visit their website www.photoessentials.com

Download from www.Somanuals.com. All Manuals Search And Download.

Preparing the Camcorder

E

Adjusting the Viewfinder

- Set the camcorder to TAPE CAMERA mode. Adjust the viewfinder focusing lever to suit your eyesight.
- To view with the viewfinder, make sure the LCD panel is either turned so that the subject can monitor viewing, or totally closed with the screen facing inwards.

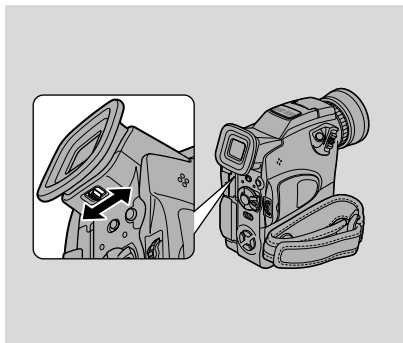

Be careful not to leave the viewfinder exposed to bright sunlight, or it will melt. (The light is concentrated by the viewfinder lens.) Do not direct the viewfinder to the sun.

Attaching the Lens Hood

Since the lens hood cuts stray light that may cause flare and ghost images and protects the lens, be sure to attach the hood when you are recording.

- 1. Align the hood to the lens with the Canon logo facing to the left.**
- 2. Twist it into position (clockwise), so that the Canon logo is to the top.**
 - Make sure attach the hood to the camcorder horizontally.



Preparing the Lens Cap

- Attach the cord to the grip belt, and then to the lens cap, passing the cord through the hole on the lens cap from front side.
- Hook the lens cap on to the grip belt while you are recording, and place it over the lens when you have finished.

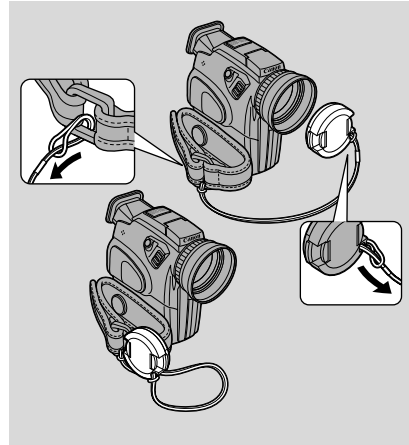

Fastening the Grip Belt

- Rotate the viewfinder downwards.
- Release the Velcro fastening and hold the camcorder with your right hand while you adjust the belt with your left.

Your index finger should reach the zoom control and photo button, and your thumb should reach the start/stop button comfortably.

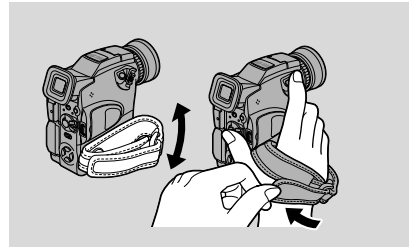

Notes on Using the Batteries

E

Charging and Recording Times

- These times vary — the safest policy is always to have 2 or 3 times as many battery packs as you think you will need.
- You will get more recording time if you turn the camcorder off between shots, instead of leaving it in record pause mode.
- Charge the battery pack in temperatures between 41°F and 104°F (5°C and 40°C).
- The charging time varies depending on the charging conditions.

Battery Pack	Time needed for full recharge
BP-512	1 hr. 20 min.
BP-511 (optional)	1 hr. 20 min.
BP-522 (optional)	2 hr. 15 min.
BP-535 (optional)	3 hr. 15 min.

Battery Pack	Max. Recording Time		Typical Recording Time*	
	Using the Viewfinder	Using the LCD Screen	Using the Viewfinder	Using the LCD Screen
BP-512	2 hr. 15 min.	1 hr. 50 min.	1 hr. 15 min.	60 min.
BP-511	2 hr. 15 min.	1 hr. 50 min.	1 hr. 15 min.	60 min.
BP-522	4 hr. 40 min.	3 hr. 50 min.	2 hr. 30 min.	2 hr 5 min.
BP-535	7 hr. 25 min.	6 hr. 10 min.	4 hr.	3 hr 25 min.

- You can use the battery pack between 32° and 104°F (0° to 40°C), but it works best between 50° and 86°F (10° to 30°C). Operating time will be shorter than usual at low temperatures like a ski ground. For better operating results, the battery pack can be warmed in your pocket or someplace and then used.
- If the battery pack starts to give you much less operating time than usual (at normal temperatures), it has reached the end of its life and must be replaced.
- These figures show how long you can view playback with the LCD, after attaching a fully-charged battery pack. Playback time will be shortened at low temperatures.

Additional Information

Battery pack	Playback time (using the LCD screen)
BP-512	1 hr. 50 min.
BP-511 (optional)	1 hr. 50 min.
BP-522 (optional)	3 hr. 50 min.
BP-535 (optional)	6 hr. 10 min.

How Much Power Is Left?

The indicator in the display shows you approximately how much charge the battery pack has left:

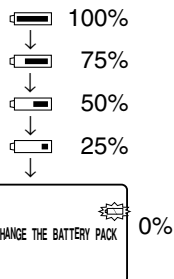

Notes:

- When the power is completely exhausted, “CHANGE THE BATTERY PACK” appears in the display for 4 seconds and the empty battery mark starts to flash. The power indicator light also flashes.
- The indicator is not constant — it varies with the condition under which battery pack and camcorder are used.

When to Recharge

You can recharge a lithium ion battery pack whenever it is convenient. Unlike a conventional battery pack, it does not have to be fully discharged first. However, as the battery pack will naturally discharge itself over time, it is best to charge it the same day you plan to use it, or the day before.

Taking Care of the Battery Pack

Always attach the terminal cover.

- Do not allow any metal objects to touch the terminals, as this can cause a short circuit and damage the battery pack. Attach the terminal cover whenever the battery pack is not being used.

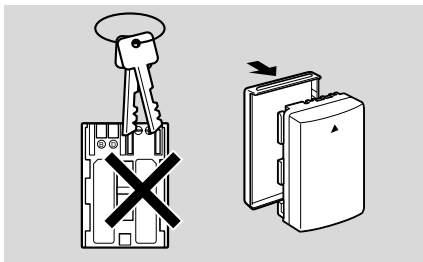

Keep the terminals clean.

- The camcorder adapter or battery pack will not work properly if the terminal are dirty. Attach the terminal cover whenever the battery pack is not being used.

Storing the battery pack

- If you do not use a battery pack for a period of more than a few months any remaining charge may cause damage to the battery pack, and reduce usage time. To prevent damage therefore, aim to use a battery pack's complete charge before storage. See the optional battery pack's instructions for further details.
- If you have some battery packs, do these things at the same time for them.

Installing the Backup Battery

Open the backup battery cover and insert the CR1616 lithium battery with the + side facing outwards. Click the cover back into place.

This backup battery allows the camcorder to retain the date and time and other settings when the main power source is removed. It has a life span of about a year. When it needs replacing (or if it has not been installed), the  mark flashes in the display. Remove the old battery by pushing it up, releasing and lifting it out. Make sure to attach a power source to the camcorder first, so it will retain your chosen settings when you change the battery.

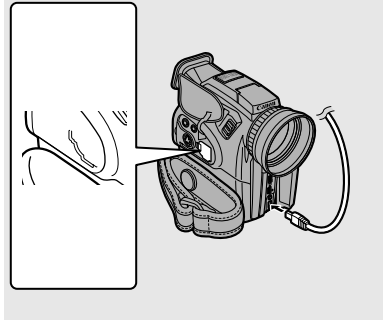

Maintenance

Cautions

E

Avoid high temperatures and high humidity.

- Do not leave the camcorder inside a car in hot weather, for example.
- Be careful of heat radiating from video lighting equipment.
- Do not take the camcorder into a humid room.

Avoid sudden changes in temperature.

- If you take the camcorder from a cold place to a warm place, condensation may form on the lens and internal parts ( 164).

Do not point the lens or viewfinder at strong light sources.

- Never point it at the sun, and do not leave it aimed at a bright subject.
- Be especially careful when leaving the camcorder on a tripod.

Avoid magnetic or electric fields.

- Do not use the camcorder close to TV transmitters, portable communication devices or other sources of electric or magnetic radiation. They may cause picture interference, or permanently damage the camcorder.

Do not expose the camcorder to water.

- The camcorder is not waterproof. If water, mud or salt (seawater) gets inside the camcorder or cassette, it may lead to damage.
- Cover the camcorder when you are recording in rain or mist.
- There is a risk of electric shock if water gets inside the camcorder — contact qualified service personnel as soon as possible.

Do not expose the camcorder to dust or sand.

- Do not use or store the camcorder in dusty or sandy places. If dust or sand gets inside the camcorder or cassette, it may lead to damage.
- Sand and dust can damage the lens — be especially careful on windy days. Always attach the lens cap after use.

Handle the camcorder gently.

- Vibration or shock can cause damage.
- Do not use the viewfinder or LCD panel as a carrying handle.

Do not disassemble the camcorder.

- This is very dangerous as there is a risk of electric shock — if the camcorder does not function properly, take it to qualified service personnel.

Storage

If you do not intend to use the camcorder for a longer time, store it in a dry place free of dust and at temperatures no higher than 85°F (30°C). After storage, check each part and function of your camcorder to make sure everything is still working properly.



Note:

- These cautions also apply to accessories such as battery packs and cassettes.

Maintenance

LCD

- Clean the LCD screen using a commercially available cleaning cloth for glasses.
- Moving the camcorder between hot and cold temperatures may cause condensation (water droplets) to form on the surface of the screen. Wipe the screen with a soft, dry cloth.
- At low temperatures, the display may appear to be much darker than usual. This is not a malfunction. As the screen warms up, the display will return to normal.

Camcorder body and lens

- Use a soft, dry cloth to clean the camcorder body or lens. Never use chemically treated cloth or volatile solvents such as paint thinner.

Video heads

- When mosaic-like noise appears on the playback picture, the video heads may be dirty. When the video heads are badly contaminated, the camcorder may show a blank blue screen or a warning.
- For the best picture possible, after using the camcorder for approximately 20 hours, clean the video heads using Canon's DVM-CL Digital Video Head Cleaning Cassette. If the "noise" remains, repeat the cleaning (up to maximum of 5 times).
- Do not use a wet-type cleaning cassette, as this can cause damage.



Using the Camcorder Abroad

E

Power sources

- You can use the compact power adapter to operate your camcorder and charge battery packs in any country where the electricity supply is between 100 and 240 V AC, 50/60 Hz. Contact your Canon dealer for information about plug adapters for overseas use.

TV playback

- Although you can always play back your recordings on the LCD screen, your camcorder can only be connected to TVs which use its NTSC system. This TV system is used in the following countries:
American Samoa, Bahama, Barbados, Bermuda, Bolivia, Canada, Chile, Columbia, Costa Rica, Cuba, Ecuador, El Salvador, Guam, Guatemala, Greenland, Haiti, Honduras, Jamaica, Japan, Korea, Mexico, Micronesia, Myanmar, Nicaragua, Panama, Peru, Philippines, Puerto Rico, Saint Lucia, Surinam, Taiwan, Trinidad and Tobago, USA, Venezuela.

Condensation

Condensation may form on the camcorder when it is moved from a cold place to a warm place. Using the camcorder while condensation is present can damage both the tape and the camcorder.

Condensation may become a problem:

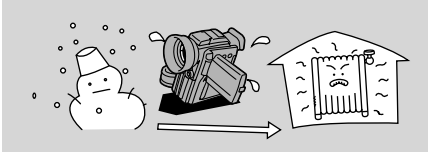

When you take the camcorder from a cold place to a warm room

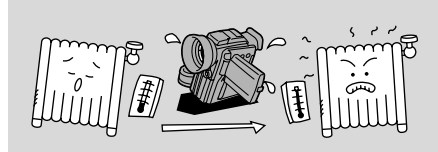

When a cold room is heated rapidly

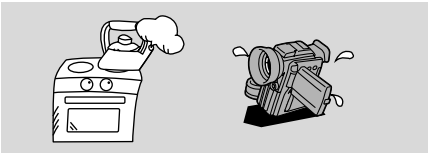

When the camcorder is left in a humid room

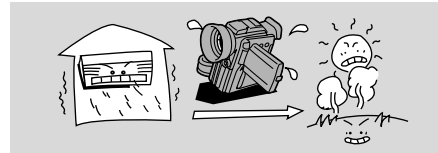



When the camcorder is taken from an air-conditioned room to a warm, humid place

Protecting the camcorder from condensation

- Before you take the camcorder to a warm or humid place where condensation is likely to be a problem, unload the cassette and put the camcorder in a plastic bag. Wait until the camcorder reaches room temperature before you take it out of the bag.

What happens when condensation is detected

- "CONDENSATION HAS BEEN DETECTED" is displayed for approximately four seconds. The power indicator flashes and the  mark flashes in the display. If there is a cassette in the camcorder, it stops automatically and "REMOVE THE CASSETTE" is displayed for approximately 4 seconds and  flashes in the display. If you have the beep turned on, it will sound. Remove the tape, otherwise it may be damaged.
- The camcorder may not detect the condensation immediately — the condensation warning may not start flashing for 10 to 15 minutes.
- You cannot load a cassette when condensation is detected.

What you should do

- Remove the cassette, leave the cassette compartment open, and turn the camcorder off.
- Leave it in a dry place until the condensation evaporates. After the condensation warning stops flashing, wait at least another hour before trying to use the camcorder.

Troubleshooting

E

Refer to this checklist first if you have any problems with your camcorder. Possible explanations are given for each problem on the list — turn to the page numbers in parentheses for more information.

Make sure that the camcorder is properly connected if you are using it with a TV or VCR. Consult your dealer or service outlet if problems persist.

Recording/Playback

Problem

- ❑ **Nothing happens when I press the buttons.**
- ❑ **The camcorder turned itself off.**
- ❑ **The cassette compartment stopped mid-operation while loading/unloading a cassette.**
- ❑ **The start/stop button does not work.**
- ❑ **The $\frac{1}{2}$ mark flashes red in the display during charging the flash.**
- ❑ **There is no picture in the display.**
- ❑ **There is a blank blue screen in the display.**

Cause and/or what to do about it

- The camcorder is not set to the appropriate mode ([□](#) 20, 32).
- The cassette is not loaded or is set for erasure prevention ([□](#) 18-19).
- The cassette has reached the end.
- The power source is not properly connected, or the battery pack is exhausted or not properly attached ([□](#) 13-17, 159).
- The function cannot be used in that recording program ([□](#) 61).
- The camcorder was in record pause mode for more than about 5 minutes ([□](#) 20, 112, 177).
- The battery pack is exhausted ([□](#) 14-17, 159).
- The battery pack's power is exhausted. Recharge or change to a new battery pack ([□](#) 14-17).
- The cassette is not loaded or is set for erasure prevention ([□](#) 18-19).
- The cassette has reached the end.
- The camcorder is malfunctioning. Remove and then replace power source.
- The camcorder is not set to the appropriate mode ([□](#) 20, 32).
- You are attempting to play back or record copyright protected material ([□](#) 93).
- The video heads are badly contaminated ([□](#) 162).

**Note:**

- Some subjects are not suitable for autofocus. In these situations, you will often get better results using manual focus (81). Focus on something which is about the same distance away, lock the focus, and then point the camcorder at your original, hard-to-focus subject.

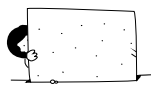

❓ There is no picture on the TV screen.

- AV/PHONES is not set to AV in the menu (□ 36).
- AV → DV OUT (Analog-digital converter) is not set to OFF.

❓ There is no picture on the TV screen, even though the tape is moving.

- The video heads need cleaning (□ 162).
- The TV/VIDEO selector on the TV isn't set to VIDEO (□ 37-38).

❓ There is no sound coming from the speaker during playback.

- The speaker has been turned off with the selector dial (□ 35).
- Headphones are being used.

Memory card operations

Problem

❓ The memory card will not insert.

Cause and/or what to do about it

- It is not turned the right way (□ 108). Turn it the right way and try inserting again.

❓ The □ mark flashes red in the display even though a memory card has been inserted.

- Turn the camcorder's power off and back on again and remove and reinsert the card. If the mark continues to flash, format the memory card.

❓ Nothing happens when I press the buttons.

- The camcorder is not set to CARD CAMERA or CARD PLAY (VCR) mode (□ 112, 123).
- The memory card is not inserted (□ 108).
- You are using an SD Memory Card and it is set for erasure prevention. Change the position of the protect switch.
- The memory card is full. Erase images (□ 131) or insert a new memory card.
- The power source is not properly connected, or the battery pack is exhausted or not properly attached (□ 13-17, 159).
- The function cannot be used in that recording program (□ 61).

❓ The PHOTO button does not work.

- The memory card is not loaded (📖 108).
- You are using an SD Memory Card and it is set for erasure prevention. Change the position of the protect switch.
- The memory card is full. Erase images (📖 131) or insert a new memory card.
- You have reached the maximum file number. Set the file numbering to RESET through the menu (📖 111) and insert a new memory card.
- You are using an unformatted memory card. Format the card (📖 149).

❓ The image cannot be erased.

- The image is protected (📖 128).
- You are using an SD Memory Card and it is set for erasure prevention. Change the position of the protect switch.

Miscellaneous

Problem

❓ The wireless controller does not work.

Cause and/or what to do about it

- The remote sensor mode is set to OFFB in the menu (📖 51).
- The remote sensor modes of the wireless controller and the camcorder itself are different (📖 51).
- The batteries are dead or not inserted.

❓ The power indicator is flashing.

- Check the screen displays (📖 173).

❓ The camcorder malfunctions.

- External interference may cause the camcorder's microprocessor to malfunction temporarily. If random letters appear in the display or if normal operation is interrupted, remove and then replace the power source.

❓ The DV cable is connected correctly, but there's nothing in the display.

- Remove the cable and then reconnect it or turn the power off and back on again.

❓ The camcorder becomes warm during use.

- This is not a malfunction.

The OPTURA200 MC System Diagram (Availability differs from area to area)

E

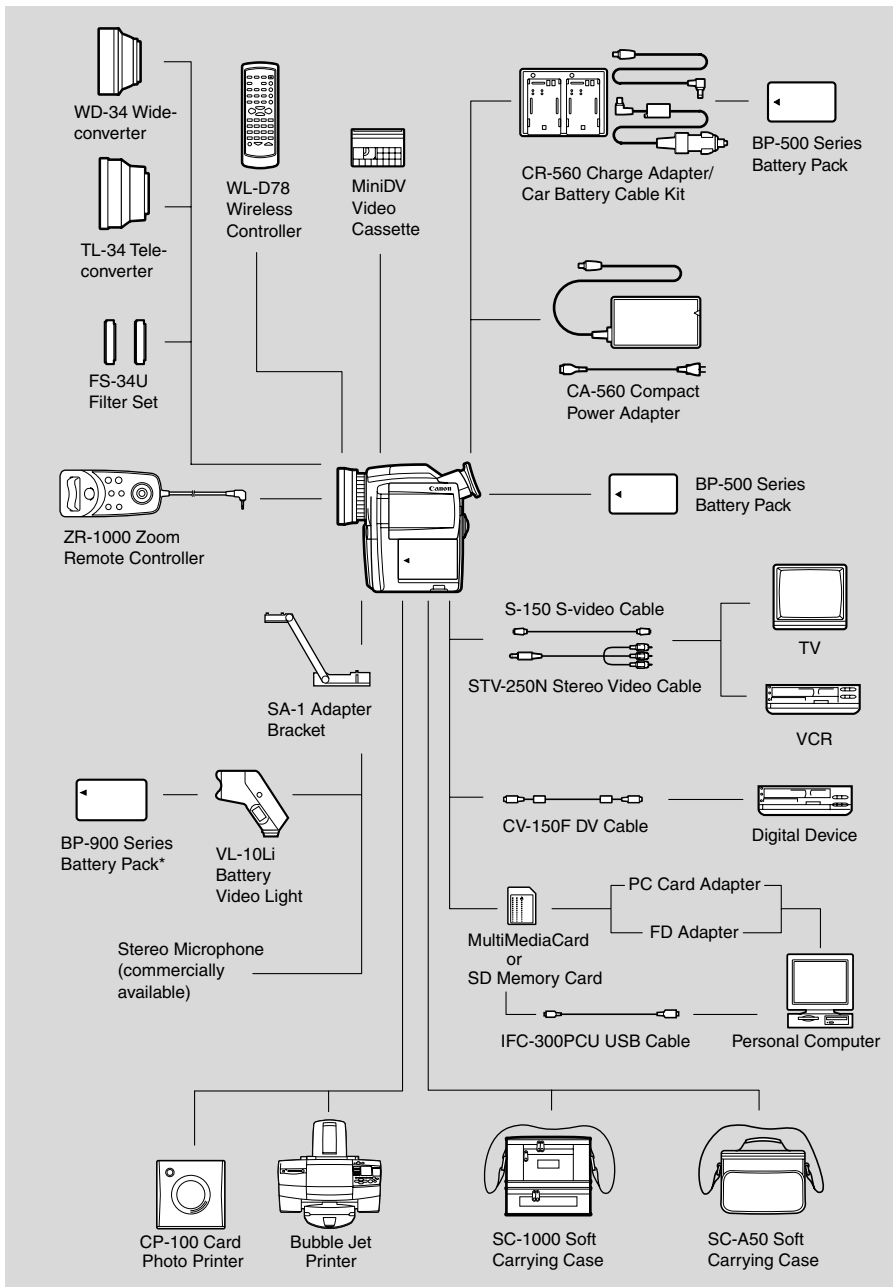

Additional Information

* Charging with the CA-920 Compact Power Adapter or CH-910 Dual Battery Charger/Holder (optional)

Optional Accessories

E

Call or visit your local retailer/dealer for genuine Canon video accessories. You can also obtain genuine accessories for your Canon camcorder by calling: 1-800-828-4040, Canon U.S.A. Information Center.

BP-500 Series Battery Packs

When you need extra battery packs, select from the following: BP-511, BP-512, BP-522 and BP-535.

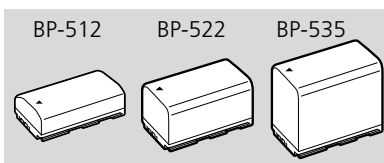

CR-560 Charge Adapter/Car Battery Cable Kit

Connect the car battery cable to power your camcorder or recharge battery packs on the move. The car battery cable plugs into your car's cigarette lighter socket and runs off a 12-24 V DC negative ground battery.

Also, when used with the CA-560 Compact Power Adapter, this charge adapter can charge the BP-500 series lithium ion battery packs from an AC outlet.

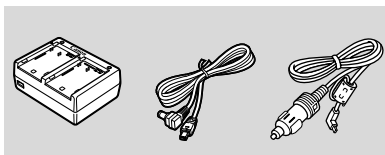

TL-34 Tele-converter

This tele-converter lens increases the focal length of the camcorder lens by a factor of 1.7.

- The image stabilizer is not as effective as usual when the tele-converter is attached.
- The minimum focusing distance with the Tele-converter is 9 ft 10 1/8 in (3 m); 11 3/4 in (3 cm) on maximum wide angle.

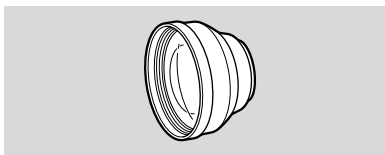

WD-34 Wide-converter

This lens decreases focal length by a factor of 0.7, giving you a wide perspective for indoor shots or panoramic views.

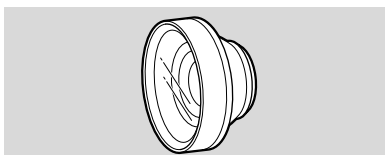

FS-34U Filter Set

Neutral density and MC protector filters to help you take control of difficult lighting conditions.

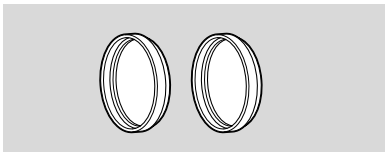

VL-10Li Battery Video Light

This compact yet powerful video light can be used for both indoor and outdoor shooting.

- Use the BP-900 Series battery packs to power the light. Approximate usage times are as follows:
BP-915 60 min. BP-930 120 min.
BP-945 170 min.
- Charge the BP-900 Series battery packs with the CA-920 Compact Power Adapter (optional).

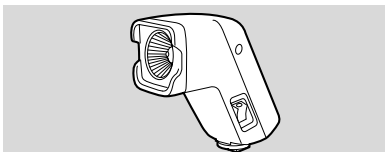

SA-1 Adapter Bracket

Attaches a video light or microphone securely to the camera.

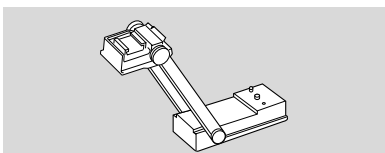

Zoom Remote Controller ZR-1000

When this product is plugged into the LANC  terminal of a Canon camcorder, it is possible to control functions such as the start and stop of recording and the zoom and focusing functions while the camcorder is mounted on a tripod, without touching the camcorder body itself.

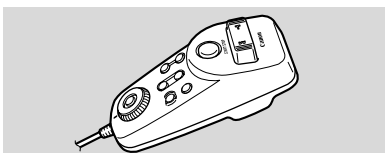

SC-1000 Soft Carrying Case

A handy camcorder bag with padded compartments and plenty of space for accessories.



SC-A50 Soft Carrying Case

This lightweight bag keeps the camcorder within easy reach without weighing you down or getting in the way. Genuine leather.



This mark identifies genuine Canon video accessories. When you use Canon video equipment, we recommend Canon-brand accessories or products bearing the same mark.

Provided accessories:

WL-D78 Wireless Controller	D83-0612-000
CA-560 Compact Power Adapter	3171A007AB
BP-512 Battery Pack	6760A002AA
STV-250N Stereo Video Cable	3067A002AA (D82-0590-201)
S-150 S-video cable	D82-0330-000
Lens cap	D52-0180-000
Lens hood	D52-0190-000

Optional accessories:

CR-560 Charge Adapter/Car Battery Cable Kit	3172A002AA (D82-0680-201)
BP-511 Battery Pack	3055A002AA (D85-1112-201)
BP-522 Battery Pack	3174A002AA (D85-1122-201)
BP-535 Battery Pack	6741A002AA
SC-1000 Soft Carrying Case	3083A001AA (D81-1200-201)
SC-A50 Soft Carrying Case	D81-1302-201
WD-34 Wide-converter	8080A001AA
TL-34 Tele-converter	8079A001AA
FS-34U Filter Set	8081A001AA
VL-10Li Battery Video Light	3140A002AA (D86-0081-201)
SA-1 Adapter Bracket	3002A002AA
JR 7.2V 10WF Halogen Bulb	3141A002AA (D86-0090-201)
ZR-1000 Zoom Remote Controller	3089A002AA (D83-0540-201)
DVM-CL Digital Video Head Cleaning Cassette	3134A002AA (D36-0032-201)

Screen Displays

To display the date and time, press the DATA CODE button. See also p. 86.

Press the wireless controller's TV SCREEN button or turn TV SCREEN on through the menu to see the other displays on the TV screen. (The displays appear white on-screen.) They will not be added to any recordings you make with the camcorder.

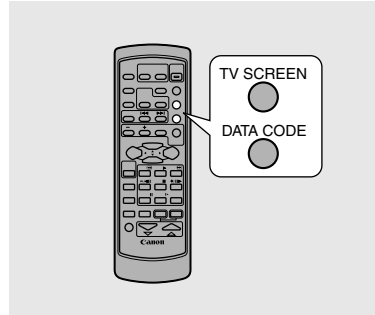

E

TAPE + **CAMERA** , **CARD** + **CAMERA**

MENU

(40)

▶DISP.SET UP

▶TV SCREEN...ON

To turn TV SCREEN off, open the menu and select DISP.SET UP. Then select TV SCREEN, set it to OFF and close the menu.

For instructions on how to hook the camcorder up to your TV, see p. 36.

Turning Off the LCD Screen Displays



You can turn off the displays to give you a clear screen for playback.

TAPE + **PLAY (VCR)** , **CARD** + **PLAY (VCR)**

MENU

(40)

▶DISP.SET UP

▶DISPLAYS...ON

To turn the displays off, open the menu and select DISP. SET UP. Then select DISPLAYS, set it to OFF <PLAYBK> and close the menu.

- If you turn the displays off, the LCD screen will be completely blank (including connected TV screen), but the camcorder will continue to show warning/caution displays when necessary, and the data code appears in the display if it is set to ON.
- When operating the camcorder, the displays appear for 2 seconds. However, the displays do not disappear when displaying an index screen.

 indicates a flashing display.

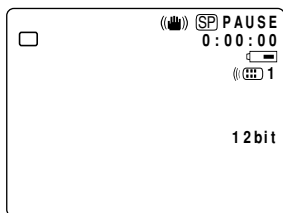





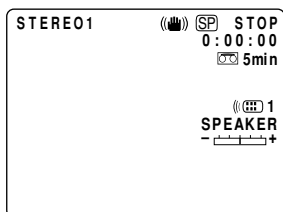









When inserting a tape in TAPE CAMERA mode (battery pack attached)

- The displays of remote sensor mode and audio mode disappear after 4 seconds.



When inserting a tape in TAPE PLAY (VCR) mode

- The displays of remote sensor mode and volume level disappear after 4 seconds.

REC	 / 	: Fast forward playback/ Rewind playback (M33)	RTN  /  RTN	: Zero set memory (forward and reverse) (M90)
PAUSE				: AV Insert Editing (M98)
STOP	 / 	: x2 playback (forward and reverse) (M34)		: Audio Dubbing (M101)
EJECT	 / 	: x1 playback (forward and reverse) (M32, 34)		
PLAY		: Slow playback (forward and reverse) (M33)		
FF ►►		: Frame advance playback/ Frame reverse playback (M33)		
◄◄ REW		: Playback pause (forward and reverse) (M33)		
		: Date Search/Photo Search (M89)		

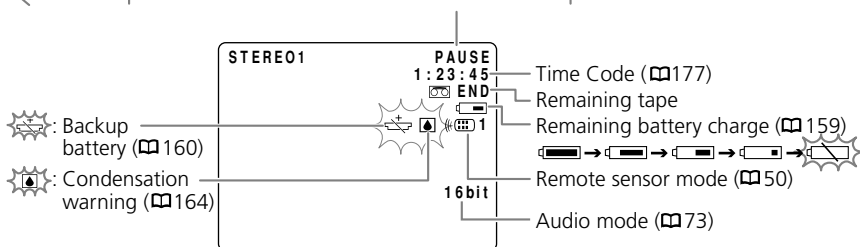

CARD CAMERA mode

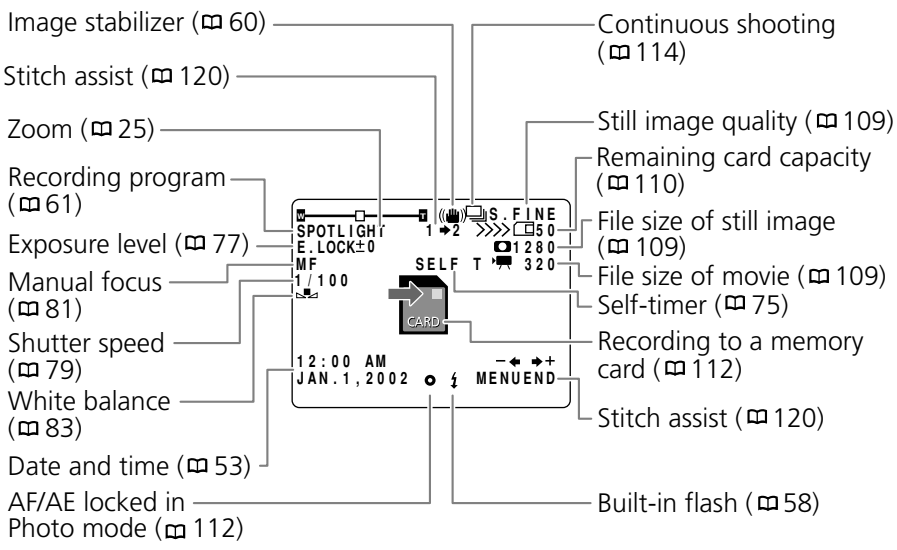

CARD PLAY (VCR) mode

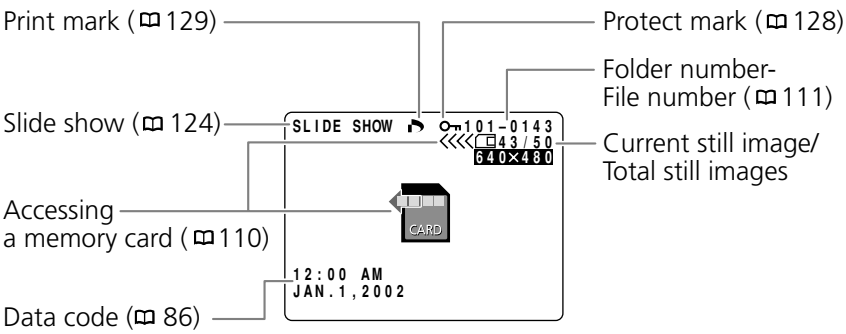

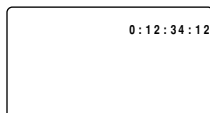

Time Code

This records counter information, including hour, minute, second, and frame number on a special data code area on the tape itself. It is reset automatically when a new tape is loaded. In TAPE CAMERA mode, the frame number doesn't appear in the display.

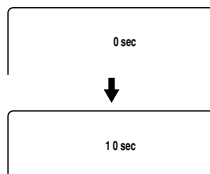

Recording reminder

When you start recording, the camcorder counts from 0SEC to 10SEC. Shots which are shorter than ten seconds may be difficult to edit later. On the other hand, if you are not planning to edit the recording, remember that a shot which does not contain action should generally last no longer than 10 seconds.



"ⓘ AUTO POWER OFF"

The camcorder will turn itself off if you leave it in record pause mode for more than about 5 minutes. This display appears 20 seconds (approx.) before the camcorder turns off.

Caution Phrases

The camcorder displays various caution phrases for approx. 4 seconds.

SET THE TIME ZONE,
DATE AND TIME

Time zone, date and time are not set. This message appears each time you turn the power on until you set the time zone, date and time (☞ 53).

CHANGE THE BATTERY PACK

Battery pack is exhausted. Replace or charge the battery pack (☞ 159).

THE TAPE IS SET FOR
ERASURE PREVENTION

Replace the tape or change the position of the protect switch on the cassette (☞ 19).

REMOVE THE CASSETTE

The camcorder stopped operating to protect the cassette. Remove the cassette and retry the operation from the beginning (☞ 164).

CHECK THE DV INPUT

DV cable is not connected, or the connected digital device is turned off (☞ 92).

CONDENSATION
HAS BEEN DETECTED

Condensation has been detected in the camcorder (☞ 164).

TAPE END

Tape reached the end. Rewind or remove the tape.

CHECK THE CASSETTE
[REC MODE]

Recording is made in a mode other than the SP mode. Audio dubbing or AV insert not possible (☞ 99, 101).

CHECK THE CASSETTE
[AUDIO MODE]

Recording is made in 16-bit or 12-bit 4-channel mode. Audio dubbing not possible (☞ 101).

CHECK THE CASSETTE
[BLANK]

Camcorder detected a blank section on the tape. Audio dubbing or AV insert not possible (☞ 99, 101).

HEADS DIRTY,
USE CLEANING CASSETTE

Displayed immediately after you start recording when the video heads are dirty. Clean the video heads (☞ 162).

COPYRIGHT PROTECTED
PLAYBACK IS RESTRICTED

You attempted to playback a copyright protected tape (☞ 93).

COPYRIGHT PROTECTED
DUBBING RESTRICTED

You attempted to copy a copyright protected tape. May also be displayed when an anomalous signal is sent during Analog Line-in recording (93, 94).

E

Memory card caution phrases

NO CARD

Memory card not inserted into the camcorder (108).



THE CARD IS SET FOR
ERASURE PREVENTION

The SD Memory Card is set for erasure prevention. Replace the card or change the position of the protect switch (107).

NO IMAGES

No images are recorded on the memory card (108).

CARD ERROR

A memory card error occurred. The camcorder cannot record/play back. The error may be temporary. If CARD ERROR disappears after 4 seconds and  flashes red, turn the camcorder's power off, remove the card and reinsert the card. If  changes to green, you can continue recording/playback (113).

CARD FULL

No free space remaining on the memory card. Replace with another memory card or erase images (131).

NAMING ERROR

File or folder numbers have already reached the maximum value (111).

UNIDENTIFIABLE
IMAGE

The image is recorded in a JPEG format or any format that is not compatible with the camcorder, or the image contains corrupted data (122).

PRINT MARK ERROR

The marked file cannot be edited (129).

THIS IMAGE CANNOT
BE RECORDED

Depending on the signal, some analog images cannot be recorded on the memory card as still image (116).

MEMORY CARD COVER
IS OPEN

The cover or the memory card compartment is open.

E

Below caution phrases may be displayed when the camcorder is connected

No Paper

Paper cassette is not correctly inserted or out of paper.

Paper Jam

The paper jammed during printing.

No Ink

The ink cartridge has not been inserted or has run out of ink.

Ink Cassette Error

The ink cassette is experiencing a problem.

Recharge the printer battery

The printer battery is depleted.

The printer is experiencing a data transmission error.

You attempted to use the DPOF print settings to print X images that are from another camcorder, that have a different format, or that have been edited on a computer.

You attempted to print an image from another camcorder, one recorded in a different format, or one that has been edited on a computer.

Set print mark

You attempted to print an unmarked still image from the CARD PLAY menu [➡ ▶ PRINT].

Cannot trim

You attempted to trim an image with an image size of 160 × 120.

Readjust trimming

The style has been changed after the trimming settings were set.

Paper has been changed

The paper size has been changed between print setting from the print dialog and the start of printing.

Incompatible paper size

You attempted to print on paper that cannot be used with the camcorder.

Paper and ink do not match

The ink cannot be used with the selected paper type.

Printer In Use

The printer is printing the data from a memory card inserted into the computer or printer. The printer automatically starts printing the images from the camcorder after completing the current printing.

Printer Warming Up

Printer is warming up. When it is ready, the printer starts printing automatically.

Low Ink Level

The ink tank needs to be replaced soon. Prepare a new ink tank. If you select [Continue] in the error screen, you can restart printing.

Paper Level Error

Adjust the paper selection lever to the proper position.

Waste Tank Full

You can restart printing by pressing the RESUME/CANCEL button on the BJ Printer. Please request replacement of the waste tank to the shop where you purchased the printer or the nearest Canon customer support center listed in the Bubble Jet Quick Start Guide.

Printer Cover Open

Close the front cover of the printer.

E

E**No Printhead**

Install a print head in the printer.

Printer Error

Turn off the printer, then turn it on again. If the error persists, please consult the nearest Canon customer support center listed in the Bubble Jet Quick Start Guide.

Media Type Error

Set the paper option in the style setting to a paper size that can be used with the printer.

Specifications

OPTURA200 MC

Power Supply (rated):	7.4 V DC
Power Consumption (while recording with the AF turned on):	3.9 W (Using viewfinder), 4.8 W (Using LCD screen)
Television system:	CCIR standard (525 lines, 60 fields) NTSC color signal
Video recording system:	2 rotary heads, helical scanning DV system (Consumer digital VCR SD system) Digital component recording
Audio recording system:	Tape: PCM digital sound 16 bit (48kHz/2ch), 12 bit (32kHz/4ch) Card: PCM digital sound 16 bit (16 kHz/1ch)
Image sensor:	1/4" CCD (charge coupled device), approx. 1,330,000 pixels (card: approx. 1,230,000 effective pixels, tape: approx. 690,000 effective pixels)
Tape format:	Videocassettes bearing the D mark.
Tape speed:	SP: 3/4 ips (18.81 mm/s), LP: 1/2 ips (12.56 mm/s)
Maximum recording time (with an 80 min. cassette):	SP: 80 min., LP: 120 min.
Fast forward/ rewind time:	Approx. 2 min. 20 sec. (with a 60 min. cassette)
Lens:	F/1.8–2.1, 10× power zoom, f=4.1–41 mm
Focusing system:	TTL autofocus, manual focusing possible
Minimum focusing distance:	3ft 33/8 in (1 m) (3/8 in (1 cm) on maximum wide angle)
Maximum shutter speed:	1/8,000 sec. (1/250 sec. when using a memory card)
Minimum illumination:	0.5 lx (using the Night program in TAPE CAMERA mode)
Recommended illumination:	More than 100 lx
Filter diameter:	34 mm
Viewfinder:	0.5 in, TFT colour LCD, approx. 113,000 pixels
LCD screen:	2.5 in measured diagonally, TFT colour, approx. 200,000 pixels
Microphone:	Stereo electret condenser microphone
Recording media:	SD Memory Card, MultiMediaCard
Number of recording pixels:	Still image: 1280 × 960, 640 × 480 pixels Movie: 320 × 240 pixels (approx. 10 sec.)*, 160 × 120 pixels (approx. 30 sec.)*, 15 frames/sec.
* The figures in brackets represent the maximum length of one movie clip.	
Image format:	Design rule for Camera File system (DCF), Exif 2.2 compliant* Digital Print Order Format (DPOF) compliant (only images marked for printing)
* This camcorder supports Exif 2.2 (also called "Exif Print"). Exif Print is a standard for enhancing the communication between camcorders and printers. By connecting to an Exif Print-compliant printer, the camcorder's image data at the time of shooting is used and optimized, yielding extremely high quality prints.	

E

Additional
Information

File format:	Still Image: JPEG (compression mode: Superfine, Fine, Standard), Movie: Motion JPEG
Estimated SD Memory Card SDC-8M capacities (approx.):*	1280 × 960: Superfine 6 images/Fine 10 images/Standard 18 images 640 × 480: Superfine 34 images/Fine 50 images/Standard 84 images
* The actual number you can record varies depending on the images. Remember that the sample images recorded on the supplied SD Memory Card are included in the total number.	
Maximum continuous shots:	1280 × 960: 10 images (2 frames/sec.) 640 × 480: Flash on: 10 images (2 frames/sec.), Flash off: 30 images (3 frames/sec.)
USB terminal:	mini-B
DV Terminal:	Special 4-pin connector (conforms to IEEE1394)
AV/headphones terminal:	ø 3.5 mm minijack Audio input: -10 dBV/at least 40 kohms, (L, R), unbalanced output: -10 dBV (47 kohm load)/ less than 3 kohms, unbalanced Video: 1 Vp-p/75 ohms unbalanced
S-video terminal:	1 Vp-p (Y signal), 0.286 Vp-p (C signal)
MIC terminal input:	ø 3.5 mm stereo minijack, - 57 dBV (with 600 ohm mic)/ at least 5 kohms
LANC terminal:	ø 2.5 mm mini minijack
Operating temperature:	32°-104°F (0°-40°C)
Dimensions:	2 3/8 × 4 5/8 × 4 5/8 in (60 × 119 × 118 mm)
Weight:	1lb 2 3/4 oz (530 g)

BP-512 Battery Pack

Battery type:	Rechargeable lithium ion battery
Rated voltage:	7.4 V DC
Operating temperature:	32°-104°F (0°-40°C)
Battery capacity:	1100 mAh
Dimensions:	1 1/2 × 7/8 × 2 5/8 in (38 × 21 × 55 mm)
Weight:	2 1/2 oz (70 g)

CA-560 Compact Power Adapter

Power supply:	100-240 V AC, 50/60 Hz
Power consumption:	34 W
Rated output:	9.5 V, 2.7 A DC
Operating temperature:	32°F-104°F (0°C-40°C)
Dimensions:	2 1/4 × 1 1/8 × 4 1/8 in (57 × 28 × 104 mm)
Weight:	6 3/8 oz (180 g) (without power cable)

Weight and dimensions are approximate.
Errors and omissions excepted.
Subject to change without notice.

Index

16:9 Wide Screen.....22
6-Second Auto Date.....88

A

Abroad, Using the
Camcorder 163
Accessories.....8, 170
AF-assist lamp82
Analog Line-in94
Analog-Digital Converter96
Audio Dubbing.....101
Audio Mix104
Audio Mode.....73
Auto62
Autofocus81
AV Insert98

B

Backup Battery.....160
Battery Charger14, 16
Battery Pack14, 158
Beep24
Brightness28
Built-in Flash.....58

C

Card Animation145
Card Mix142
Caution Phrases178
Condensation.....165
Connections
 PC.....106, 150
 TV or VCR.....36
Continuous Shooting114
Copying Still Images.....147, 148

D

Data Code86
Date and Time53
Date Search89
Demo mode24
Digital Effects65
Digital Zoom25
Direct Printing133
DV Dubbing92

E

Easy Recording62
Editing to a VCR.....91
Effects68
Enlarging Still Images85
Erasing Still Images.....131
Exposure77

F

Faders66
Fast Forward32
File Numbers111
Focusing.....81
Formatting149

G

Grip Belt.....157

H

Headphones.....35

I

Image Quality.....109
Image Stabilizer60
Index Screen.....124

L

LANC91
LCD Mirror Mode29
LCD Screen27
Lens Cap157
Lens Hood156
Low Light.....63
LP Mode.....22

M

Maintenance161
Manual Focus.....81
Memory Card.....107
Menus40
Microphone72, 101
Movie Size109
Multi-Image Screen71
My Camera Settings.....151

E

E

N

ND Filter 113
 Night 63

O

Output Channel 105

P

Photo Search 89
 Playback
 Memory Card 122
 Tape 32
 Playback Pause 33
 Portrait 63
 Power Adapter 13
 Print Mark 129
 Protect 128

R

Record Pause Mode 20
 Record Review 39
 Record Search 39
 Recording
 Movies (Memory Card) 117
 Movies (Tape) 20
 Still Images (Memory Card) 112
 Still Images (Tape) 56
 Recording Programs 61
 Remote Sensor 50
 Rewind 32

S

S1 video terminal 37
 Sample images 154
 Sand & Snow 63
 Screen Displays 173
 SD Memory Card 107
 Self-Timer 75
 Shutter Sound 151
 Shutter Speed 79
 Slide Show 124
 SP Mode 22
 Speaker 35
 Sports 63
 Spotlight 63
 Still Image Quality 109

Still Image Size 109
 Stitch Assist Mode 120
 Super Night 63
 S-video/S1-video 37

T

Tally Lamp 23
 Tape Protection 19
 Telephoto 25
 Time Code 177
 Time Zone 53
 Tripod 30
 Troubleshooting 165

V

Video Head 162
 Video ID-1 system 38
 Videocassettes 18
 Viewfinder 156

W

White Balance 83
 Wide-Angle 25
 Wide Screen 22
 Wireless Controller 50

Z

Zero Set Memory 90
 Zooming 25

Menu at a Glance

Use the list below to quickly navigate the camcorder's menu. Functions are listed alphabetically.

E

Function	First make sure the camera is set to...				Then select it from this submenu and set.
	TAPE + CAMERA	TAPE + PLAY (VCR)	CARD + CAMERA	CARD + PLAY (VCR)	
16:9 effect	<input type="radio"/>				CAM.SET UP
6-sec. Date		<input type="radio"/>			DISP.SET UP
AF-assist lamp	<input type="radio"/>		<input type="radio"/>		CAM.SET UP
Animation type	<input type="radio"/>				➔ CARD MIX
Audio dubbing		<input type="radio"/>			VCR SET UP
Audio mode	<input type="radio"/>	<input type="radio"/>			VCR SET UP
AV/headphones	<input type="radio"/>	<input type="radio"/>	<input type="radio"/>	<input type="radio"/>	VCR SET UP
AV → DV out		<input type="radio"/>			VCR SET UP
Beep	<input type="radio"/>	<input type="radio"/>	<input type="radio"/>	<input type="radio"/>	SYSTEM
Brightness	<input type="radio"/>	<input type="radio"/>	<input type="radio"/>	<input type="radio"/>	DISP.SET UP
Card access display	<input type="radio"/>	<input type="radio"/>			DISP.SET UP
Card mix	<input type="radio"/>				➔ CARD MIX
Continuous shooting			<input type="radio"/>		CARD SET UP
Copy - card to tape				<input type="radio"/>	CARD OPER.
Copy - tape to card		<input type="radio"/>			CARD OPER.
Create start-up image				<input type="radio"/>	MY CAMERA
Data code		<input type="radio"/>		<input type="radio"/> *	DISP.SET UP
Date/time display	<input type="radio"/>		<input type="radio"/>		DISP.SET UP
Date/time select		<input type="radio"/>		<input type="radio"/>	DISP.SET UP
Date/time set	<input type="radio"/>	<input type="radio"/>	<input type="radio"/>	<input type="radio"/>	SYSTEM

* Only the date and time appear in the data code when using a memory card.

Function	First make sure the camera is set to...				Then select it from this submenu and set.
	TAPE + CAMERA	TAPE + PLAY (VCR)	CARD + CAMERA	CARD + PLAY (VCR)	
Demo mode	<input type="radio"/>		<input type="radio"/>		DISP.SET UP
Digital zoom	<input type="radio"/>		<input type="radio"/>		CAM.SET UP
Displays		<input type="radio"/>		<input type="radio"/>	DISP.SET UP
Erase				<input type="radio"/>	CARD OPER.
Erase all print marks				<input type="radio"/>	CARD OPER.
File numbers		<input type="radio"/>	<input type="radio"/>		CARD SET UP
Format				<input type="radio"/>	CARD OPER.
Image stabilizer	<input type="radio"/>		<input type="radio"/>		CAM.SET UP
LCD Mirror mode	<input type="radio"/>		<input type="radio"/>		DISP.SET UP
Mix level	<input type="radio"/>				➔ CARD MIX
Mix type	<input type="radio"/>				➔ CARD MIX
Movie Size		<input type="radio"/>	<input type="radio"/>		CARD SET UP
ND filter			<input type="radio"/>		CAM.SET UP
Output channel		<input type="radio"/>			VCR SET UP
Print mark				<input type="radio"/>	CARD OPER.
Protect				<input type="radio"/>	CARD OPER.
Recording mode	<input type="radio"/>	<input type="radio"/>		<input type="radio"/>	VCR SET UP
Remote sensor mode	<input type="radio"/>	<input type="radio"/>	<input type="radio"/>	<input type="radio"/>	SYSTEM
Select start-up image				<input type="radio"/>	MY CAMERA
Self-timer sound	<input type="radio"/>	<input type="radio"/>	<input type="radio"/>	<input type="radio"/>	MY CAMERA
Shutter sound	<input type="radio"/>	<input type="radio"/>	<input type="radio"/>	<input type="radio"/>	MY CAMERA

U.S.A.

E

CANON® OPTURA200 MC DIGITAL VIDEO CAMCORDER LIMITED WARRANTY

The limited warranty set forth below is given by Canon U.S.A., Inc. ("CUSA") with respect to each Canon OPTURA200 MC Digital Video Camcorder ("DV Camcorder") purchased and used in the United States.

Each Canon DV Camcorder, when delivered to you in new condition in its original container, is warranted against defective material or workmanship as follows: for a period of one (1) year from the date of original purchase (three (3) months in the case of the video head part), defective parts or DV Camcorders returned to a CUSA factory service center ("CUSA Center") or an authorized DV Camcorder service facility ("Service Facility"), and proven to be defective upon inspection, will be repaired or exchanged for new or comparable rebuilt parts or DV Camcorders. The warranty period for repaired or replacement parts or DV Camcorders shall begin upon shipment of the same, but shall in no event exceed the original warranty period of the defective part or DV Camcorder.

Non-Canon brand peripheral equipment and software which may be distributed with Canon DV Camcorders are sold "AS IS", without warranty of any kind by CUSA, including any implied warranty regarding merchantability or fitness for a particular purpose. The sole warranty with respect to such non-Canon brand items is given by the manufacturer or producer thereof.

CUSA shall have no responsibility under this limited warranty for use of Canon DV Camcorders in conjunction with incompatible peripheral equipment and incompatible software.

In order to obtain warranty service, contact the authorized Canon retail dealer from whom you purchased the DV Camcorder or call the CANON INFORMATION CENTER AT 1-800-828-4040 (which is open from 9:00 a.m. to 5:00 p.m. (E.S.T.), Monday through Friday, excluding holidays). Have your unit serial number and your date of purchase available when you make the call to expedite service. In either case you will be directed to ship the DV Camcorder, postage prepaid, to the CUSA Center or Service Facility nearest to you. You must include a copy of the proof of purchase (bill of sale) and a complete explanation of the problem. DV Camcorders covered by this limited warranty will be repaired and returned to you without charge by the CUSA Center or the Service Facility. Repairs not under warranty will be at such cost as the CUSA Center or Service Facility may from time to time generally establish.

This limited warranty covers all defects encountered in normal use of the DV Camcorder, and does not apply in the following cases:

- (a) Loss of or damage to the DV Camcorder due to abuse, mishandling, improper packaging by you, alteration, accident, leaking batteries, exterior nicks, scratches or dents, electrical current fluctuations, failure to follow operating instructions, maintenance and environmental instructions prescribed in CUSA's instruction manual, or service performed by other than a CUSA Center or Service Facility.
- (b) Use of parts or supplies (other than those sold by CUSA) which cause damage to the DV Camcorder or cause abnormally frequent service calls or service problems.
- (c) If any DV Camcorder has had its serial number or dating altered or removed.

This limited warranty does not apply to accessories or consumables for the DV Camcorder, which are sold "AS IS", without warranty of any kind by CUSA.

NO IMPLIED WARRANTY, INCLUDING ANY IMPLIED WARRANTY OF MERCHANTABILITY OR FITNESS FOR A PARTICULAR PURPOSE, APPLIES TO THE DV CAMCORDER AFTER THE APPLICABLE PERIOD OF EXPRESS WARRANTY STATED ABOVE, AND NO OTHER EXPRESS WARRANTY OR GUARANTY, EXCEPT AS MENTIONED ABOVE, GIVEN BY ANY PERSON, FIRM OR CORPORATION WITH RESPECT TO THE DV CAMCORDER SHALL BIND CUSA. (SOME STATES DO NOT ALLOW LIMITATIONS ON HOW LONG AN IMPLIED WARRANTY LASTS, SO THE ABOVE LIMITATION MAY NOT APPLY TO YOU) CUSA SHALL NOT BE LIABLE FOR LOSS OF REVENUES OR PROFITS, EXPENSE FOR SUBSTITUTE EQUIPMENT OR SERVICE, STORAGE CHARGES, LOSS OF DATA, OR ANY OTHER SPECIAL, INCIDENTAL OR CONSEQUENTIAL DAMAGES CAUSED BY THE USE, MISUSE OR INABILITY TO USE THE DV CAMCORDER, REGARDLESS OF THE LEGAL THEORY ON WHICH THE CLAIM IS BASED, AND EVEN IF CUSA HAS BEEN ADVISED OF THE POSSIBILITY OF SUCH DAMAGES. NOR SHALL RECOVERY OF ANY KIND AGAINST CUSA BE GREATER IN AMOUNT THAN THE PURCHASE PRICE OF THE DV CAMCORDER SOLD BY CUSA AND CAUSING THE ALLEGED DAMAGE. WITHOUT LIMITING THE FOREGOING, YOU ASSUME ALL RISK AND LIABILITY FOR LOSS, DAMAGE OR INJURY TO YOU AND YOUR PROPERTY AND TO OTHERS AND THEIR PROPERTY ARISING OUT OF USE, MISUSE OR INABILITY TO USE THE DV CAMCORDER NOT CAUSED DIRECTLY BY THE NEGLIGENCE OF CUSA. (SOME STATES DO NOT ALLOW THE EXCLUSION OR LIMITATION OF INCIDENTAL OR CONSEQUENTIAL DAMAGES, SO THE ABOVE LIMITATION MAY NOT APPLY TO YOU.) THIS LIMITED WARRANTY SHALL NOT EXTEND TO ANYONE OTHER THAN THE ORIGINAL PURCHASER OF ANY DV CAMCORDER, OR THE PERSON FOR WHOM IT WAS PURCHASED AS A GIFT, AND STATES YOUR EXCLUSIVE REMEDY.

This limited warranty gives you specific legal rights, and you may also have other rights which vary from state to state.

Canon U.S.A., Inc.
One Canon Plaza
Lake Success, New York

11042

**Additional
Information**

CANON CONSUMER DIGITAL VIDEO EQUIPMENT LIMITED WARRANTY

The limited warranty set forth below is given by Canon Canada Inc. ("Canon Canada") with respect to Canon digital video equipment purchased in Canada. This limited warranty is only effective upon presentation of a bill of sale or other proof of purchase for this Canon digital video equipment to a Canon Service Facility when repairs are required.

Canon consumer video digital equipment is warranted under normal, non-commercial, personal use, against defective materials or workmanship as follows:

Parts: Defective parts will be exchanged for new parts or, at Canon Canada's option, comparable rebuilt parts for a period of one year from the date of original purchase, except Video Heads which will be exchanged for a period of 3 months from the date of purchase.

Labour: For a period of one year from the date of original purchase, labour will be provided free of charge by our Canon Service Facilities in Canada.

This limited warranty covers all defects except where:

- (a) The loss or damage to the product results from:
 - i) accident, natural disaster, mishandling, abuse, neglect, unauthorized product modification or failure to follow instructions contained in the instruction manual;
 - ii) the use of accessories, attachments, products, supplies, parts or devices with this Canon product that do not conform to Canon specifications or that cause abnormally frequent service problems;
 - iii) repairs or services performed by any party other than a Canon Service Facility;
 - iv) defective batteries or any exposure to water, sand or dirt;
 - v) shipping (claim must be presented to the shipper);
- (b) Any serial number on the video equipment is altered or removed.
- (c) The digital video equipment is used for commercial, professional or industrial purposes.

This limited warranty does not cover the cabinet (exterior finish) of the digital video equipment, video cassette tapes, head cleanings, nor does it apply to digital video equipment purchased outside Canada.

TO OBTAIN WARRANTY SERVICE

Ship your Canon digital video equipment in its original carton, box or equivalent, properly packed, fully insured with shipping charges prepaid, together with a copy of your bill of sale or other proof of purchase and a description of the problem to any of the Canon Service Facilities in Canada.

LIMITATIONS

Except as otherwise required by applicable legislation, this warranty is in lieu of all other warranties, conditions, guarantees or representations, express or implied, statutory or otherwise, relative to this Canon product, including implied warranties or conditions of merchantability or fitness for a particular purpose.

Canon Canada assumes no liability for special, consequential or incidental damages or loss that may arise, whether on account of negligence or otherwise, from the use, misuse or inability to use this Canon product (including loss of profit, revenue, video tapes or enjoyment) or from failure to conform to any express or implied warranties, conditions, guarantees or representations. Any recovery under this limited warranty shall not exceed the purchase price of the product. Canon Canada does not assume or authorize any other person to assume for Canon Canada any other liability with respect to this Canon product.

This warranty does not extend to any person other than the original purchaser of this Canon product or the person for whom it was purchased as a gift and states your exclusive remedy.

NOTICE TO CONSUMER

If you plan to take important videos or if the product has not been used for some time, please check all functions with the instruction book before using it.

Canon

CANON INC.

U.S.A. ————— **CANON U.S.A., INC. NEW JERSEY OFFICE**
100 Jamesburg Road, Jamesburg, NJ 08831 USA

CANON U.S.A., INC. CHICAGO OFFICE
100 Park Blvd., Itasca, IL 60143 USA

CANON U.S.A., INC. LOS ANGELES OFFICE
15955 Alton Parkway, Irvine, CA 92618 USA

CANON U.S.A., INC. HONOLULU OFFICE
210 Ward Avenue, Suite 200, Honolulu, HI 96814 USA

- **If you have any questions, call the Canon U.S.A. Information Center toll-free at 1-800-828-4040 (U.S.A. only).**

CANADA ————— **CANON CANADA INC. NATIONAL HEADQUARTERS**
6390 Dixie Road, Mississauga, Ontario L5T 1P7

CANON CANADA INC. CALGARY
2828, 16th Street, N.E. Calgary, Alberta T2E 7K7

CANON CANADA INC. MONTREAL
5990 Côte de Liesse, Quebec H4T 1V7

- **If you have any questions, call the Canon Canada Information Center toll-free at 1-800-828-4040. (Canada only)**
- **Si vous avez des questions, veuillez téléphoner sans frais au Canada 1-800-828-4040. (Canada seulement)**

MEXICO ————— **CANON MEXICANA, S. DE R.L. DE C.V.**
Periferico Sur No. 4124 Col. Ex-Rancho de Anzaldo C.P. 01900
México, D.F., México

CENTRO Y SURAMÉRICA ————— **CANON LATIN AMERICA, INC.**
703 Waterford Way Suite 400 Miami, FL 33126 USA

ASIA ————— **CANON HONGKONG COMPANY LTD.**
9/F, The Hong Kong Club Building, 3A Chater Road, Central, Hong Kong



Printed on 100% reused paper.
Document réalisé avec du papier recyclé à 100%.
El papel aqui utilizado es 100% reciclado.

Free Manuals Download Website

<http://myh66.com>

<http://usermanuals.us>

<http://www.somanuals.com>

<http://www.4manuals.cc>

<http://www.manual-lib.com>

<http://www.404manual.com>

<http://www.luxmanual.com>

<http://aubethermostatmanual.com>

Golf course search by state

<http://golfingnear.com>

Email search by domain

<http://emailbydomain.com>

Auto manuals search

<http://auto.somanuals.com>

TV manuals search

<http://tv.somanuals.com>