

E INSTRUCTIONS

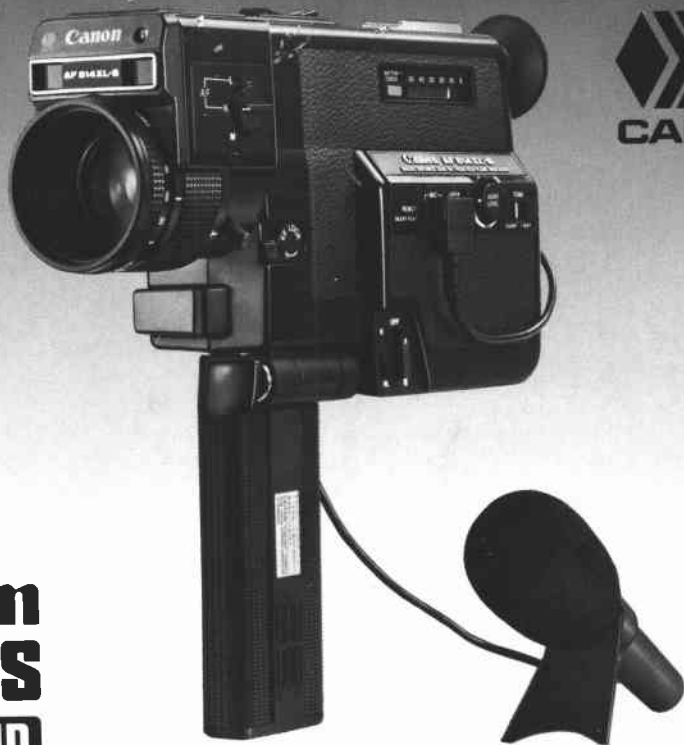

Canon
AF514XL-S
CANOSOUND

CONTENTS

Grip.....	p. 8
1 ADJUST THE CAMERA TO YOUR EYESIGHT	p. 9
2 LOAD THE BATTERIES	p. 10
3 CHECK THE BATTERIES	p. 11
4 BEFORE LOADING FILM, BECOME FAMILIAR WITH BASIC CONTROLS ..	p. 13
Main Switch and Shutter Trigger	
Focusing	
Zooming	
5 LOAD THE FILM.....	p. 18
Check that the Film Is Loaded Properly	
6 SET THE CCA FILTER SWITCH (TYPE A FILM ONLY).....	p. 20
7 SET THE FILMING SPEED.....	p. 22
8 SET THE AUDIO LEVEL DIAL (SOUND CARTRIDGE)	p. 23
9 SET THE TONE SWITCH (SOUND CARTRIDGE).....	p. 25
10 CONNECT THE MICROPHONE AND EARPHONE (SOUND CARTRIDGE) ..	p. 26
11 BEFORE STARTING TO FILM, CHECK THE EXPOSURE [AND MONITOR THE SOUND (SOUND CARTRIDGE)].....	p. 28
12 START FILMING.....	p. 30
Film End Warning	
13 AT THE END OF THE FILM, REMOVE THE CARTRIDGE	p. 34

Our congratulations on your purchase of a Canon AF 514XL-S. We know you are anxious to start filming with it. Our first hint for making good films? Read these few simple instructions. Follow steps one through thirteen, pages 9-34, in order, and become familiar with the camera. Then take a look into the section entitled **Making More of Your AF 514XL-S**. It contains a lot of information you won't find elsewhere. The short time you spend reading this booklet is a sound investment in satisfaction and enjoyment.

Make Full Use of this Booklet

* **Unfold the front and back cover flaps** for quick reference to camera parts while you are reading the instructions. Each camera part is given a number which also appears next to the name of the part in the text so that you can find it without delay.

* **Symbols:**



Signals an important DO.



Signals an important DON'T.

ACCESSORIES WHICH COME WITH THE CAMERA

Lens Cap C-52: This cap is on the lens of a new camera. Remove it by pressing in its side tabs. Make sure it is off the lens when you are using the camera. Make sure it is on the lens whenever you are not using the camera.

Finder Cover: You will find this covering the eyepiece ③ of a new camera. Remove it. For details on when to use it, see p. 47.

Rubber Guard: This is in the camera box. See p. 8 for its use.

Microphone DM30R (plus windscreen, microphone stand and clip): These are in the camera box. See pp. 26-27 for more information.

Earphone E: This is in the camera box. See pp. 26-27 for more information.

Remote Switch 60: In the camera box. See pp. 44-47 for details.

Soft Case and Neckstrap 8: These are in the camera box. Attach the neckstrap to the soft case. Insert the camera in the soft case for protection whenever you are not filming.

Head Cleaning Stick: This is a cotton swab which you will find in the camera box. It is for cleaning recording mechanisms. See p. 58.

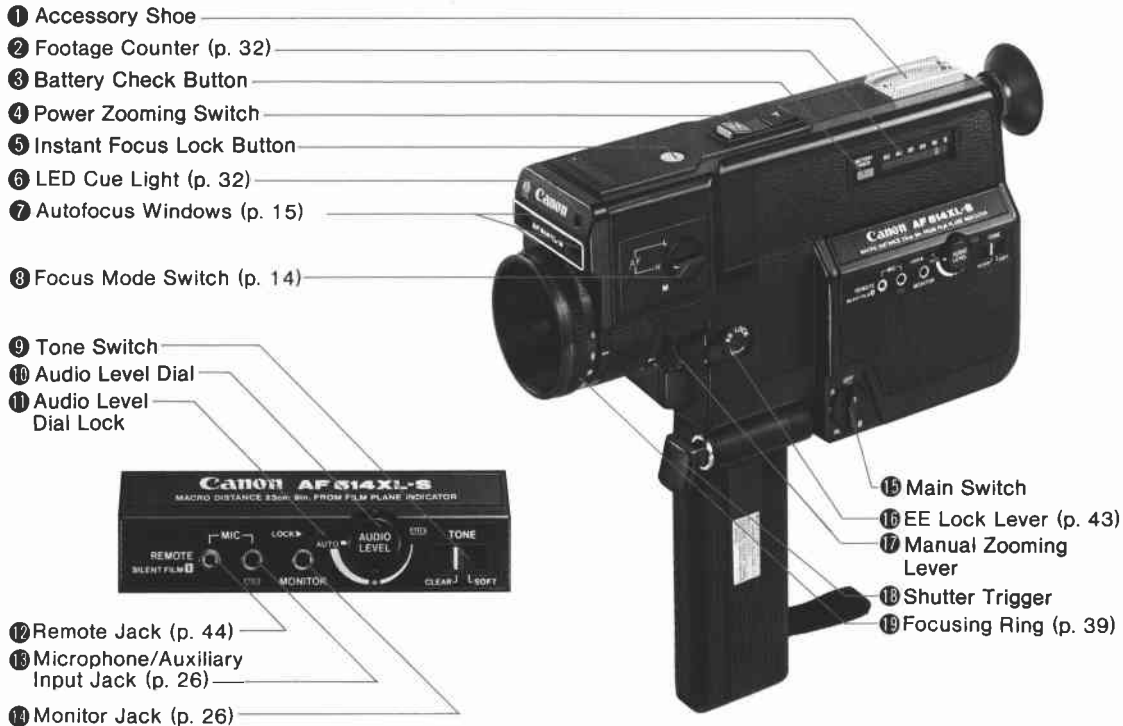

MAKING MORE OF YOUR AF 514XL-S

MORE ABOUT FOCUSING	p. 37
Automatic Focus Lock	
Instant Focus Lock Button	
Manual Focusing	
Subjects which Require Special Attention in Focusing	
FILMING WITH LIGHT BEHIND YOUR SUBJECT (AND OTHER UNUSUAL LIGHTING SITUATIONS)	p. 43
REMOTE CONTROL	p. 44
Finder Cover	
MOVING IN ON SMALL SUBJECTS (MACROCINEMATOGRAPHY)	p. 48
SINGLE-FRAME SHOOTING (SILENT CARTRIDGE ONLY)	p. 49
SOUND FADING (SOUND CARTRIDGE ONLY)	p. 51
AUXILIARY INPUT (SOUND CARTRIDGE ONLY)	p. 53
FILMING A TELEVISION SCREEN	p. 54
OTHER FEATURES	p. 55
Accessory Shoe	
External Power Jack	
FILMING IN VERY LOW TEMPERATURES	p. 56
CARE OF THE CAMERA	p. 57
OPTIONAL ACCESSORIES	p. 59
SPECIFICATIONS	p. 62



Unfold the flaps of the front and back covers for easy reference to camera parts while reading these instructions.

SIMPLE STEPS FOR NORMAL FILMING

1. Unfold the grip.



2. Load the batteries.

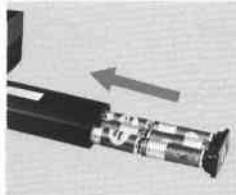

3. Check the batteries.



4. Adjust the eyepiece.



SOUND FILMING

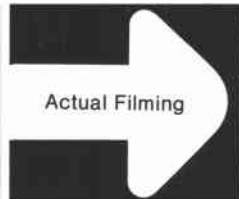

SILENT FILMING

10. Connect the microphone and earphone.



11. Set the focus mode switch on "N" and compose the picture so that your subject covers the auto-focus circle. Zoom manually if necessary.

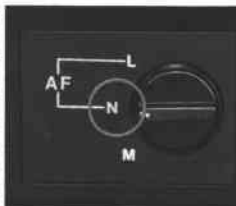

12. Turn the main switch to "R" and press the the eyepiece. While the lens focuses the sound.



8. Set the focus mode switch on "N" and compose the picture so that your subject covers the auto-focus circle. Zoom manually if necessary.

9. Turn the main switch to "R" and press the the eyepiece. While the lens focuses the sound.

5. Load a sound cartridge.



5. Load a silent cartridge.

6. Set the CCA filter switch.



6. Set the CCA filter switch.

7. Set the filming speed to 18.



7. Set the filming speed to 18.

8. Set the audio level dial on AUTO.



9. Set the tone switch on SOFT.



shutter trigger halfway while you look through automatically, check exposure and monitor

13. Turn the microphone switch ON and press the shutter trigger all the way in to start filming and recording. Zoom manually or automatically as required.

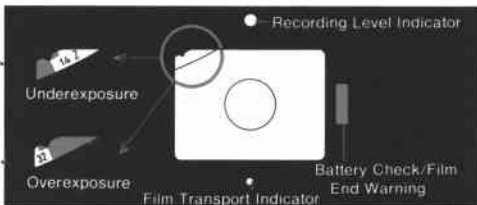

shutter trigger halfway while you look through automatically, check exposure.

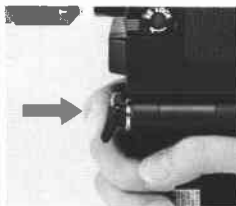

10. Press the shutter trigger all the way in to start filming. Zoom manually or automatically as required.



Grip

To hold the camera, rotate the grip ③ downwards until it locks. Make sure it is locked. Slip your right hand through the wrist strap ② and grasp the grip firmly. A rubber guard comes with the camera. It fits over the tripod socket ② to prevent irritation to your hand from the socket and to make holding the camera easier. To refold

the grip, push the grip release ③ down first.

Note

It is still possible to run the camera even if the grip is folded, such as when the camera is on a tripod.

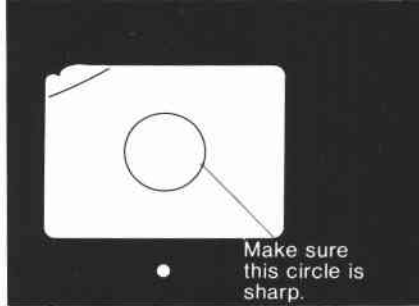

1 ADJUST THE CAMERA TO YOUR EYESIGHT

It is helpful to adjust the camera to your eyesight so that you will be able to see viewfinder information clearly.

1. Remove the lens cap and the finder cover.
2. Give the eyesight correction lock ring 25 a twist to the left.
3. Look through the eyepiece 23 and point the camera to the sky or some other bright area. Turn the eyecup 24 until the circle in the center of the viewfinder is perfectly sharp.
4. Turn the lock ring 25 to the right to lock the eyecup.

Notes

1. The range of eyesight correction is from -4 to $+2$ diopters.
2. If you plan to wear eyeglasses while filming, make the eyesight correction with them on.
3. Readjust the eyesight correction following a long period of not using the camera.

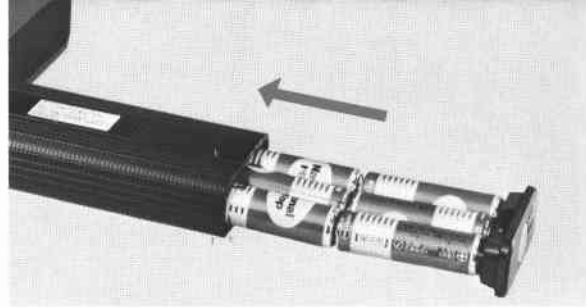

2 LOAD THE BATTERIES

THIS CAMERA WILL NOT WORK
WITHOUT BATTERIES

Correct Batteries: Six 1.5V (Size AA) penlight batteries which are all of the same type and brand. For filming in very low temperatures, alkaline-manganese (LR6) or Ni-Cd penlight batteries are recommended.

Wipe the battery poles with a clean, dry cloth before loading to prevent poor contact from dirt. Handle the batteries by their sides.

1. Unfold the grip ③③.
2. Using a coin, turn the lock ②② on the battery chamber cover to OPEN and remove the cover.
3. Load six new batteries so that their poles are in the directions indicated by the diagram on the side of the grip.
4. Replace the battery chamber cover, press it in and turn the lock ②② to CLOSE.

Note

If you find it difficult to reattach the battery chamber cover, it means that it is backwards. Turn it around. It attaches in only one direction.



Battery Check/Film End Warning Lamp

- Do not force the cover lock past OPEN or CLOSE.
- To avoid dangerous short-circuits, make sure the battery poles are facing in the correct directions.
- Remove the batteries if you do not expect to use the camera for a long time.

3 CHECK THE BATTERIES

1. Turn the main switch 15 to "R".
2. Look into the viewfinder 23 and press the battery check button 3.
 - * If a red lamp lights up on the right in the viewfinder, there is enough power.
 - * If the red lamp does not appear, replace all six batteries with new ones.

Notes

1. A set of new carbon-zinc penlight batteries will last through normal filming of about five cartridges or single-frame shooting of one cartridge in normal temperatures. Battery life may vary slightly depending on how often you use power zoom and sound cartridges.
2. It is particularly important to check the batteries:

After loading new batteries.

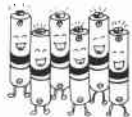

While filming in low temperatures.



Following a long period of storage.

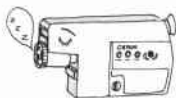

After filming about five cartridges.



3. It is impossible to film correctly if the batteries are weak.



To prevent battery waste, always turn the main switch **15** to OFF whenever you are not using the camera. At any other setting of the switch, the camera is always using power. A red mark appears next to every position of the switch except "OFF" as a warning of this.



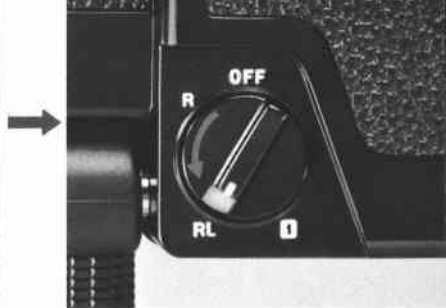
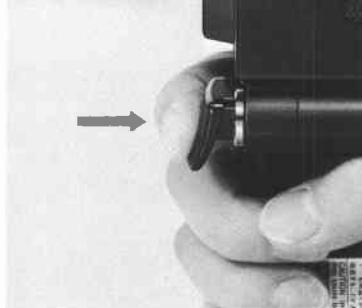

4 BEFORE LOADING FILM, BECOME FAMILIAR WITH BASIC CONTROLS

Main Switch and Shutter Trigger

1. To turn power on, turn the main switch 15 from OFF to "R".
The AF 514XL-S has a two-step shutter trigger 18 .
2. To check exposure in the viewfinder (pp. 28–29), to monitor the sound (pp. 29–30) and to focus automatically (pp. 14–15), press the trigger 18 HALFWAY.
3. To start filming, press the trigger 18 all the way in. Filming will continue as long as you hold it in.

4. For continuous filming, press the shutter trigger all the way and turn the main switch 15 from "R" to "RL" (Running Lock). On RL, filming will continue even if you release your finger from the shutter trigger. To release running lock, turn the main switch back to "R".

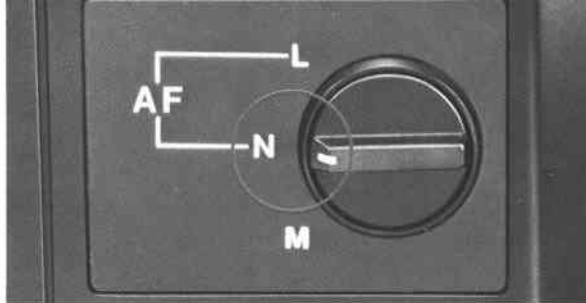

Notes

1. The position **1** of the main switch is for single-frame shooting with a silent cartridge (see pp. 49–50). Turn the main switch to **1** from the OFF setting. It is impossible to turn the switch between “RL” and **1**.
2. Always turn the main switch to OFF to prevent battery drain whenever you are not using the camera.

Focusing

This camera has an automatic focusing feature which will focus the vast majority of subjects perfectly. All you have to do is make sure your subject covers the autofocus circle in the center of the viewfinder at all times. The camera will then focus your subject automatically.

1. Turn the focus mode switch **8** to “N” (Normal Autofocus).
2. Look through the eyepiece **23** and compose the picture so that your subject covers the autofocus circle in the center of the viewfinder.
3. Press the shutter trigger **18** HALF-WAY. The lens will begin to focus automatically (you can see the focus-



ing ring (19) turn). It may take about one second before the lens finishes focusing after you press the trigger.

4. Begin filming. The lens will continue to focus automatically as long as you film. As you follow your subject, make sure it is still covering the autofocus circle.

⊗ Do not let the autofocus windows (7) get dirty and make sure nothing, such as one of your fingers, is covering them while you are filming.

⊗ Since there is a strong risk that a lens hood would block the autofocus windows, do not use one. The lens barrel itself acts as a hood.

Notes

1. Normal automatic focusing is not possible in single-frame shooting and in macrocinematography. Please see pp. 48–50.
2. There are some types of subjects to which autofocusing is not perfectly suited (see pp. 40–41).
3. It is also possible to lock the focus either instantly or more permanently and it is possible to focus manually. Please see pp. 37–39 for more details.
4. For focusing when you do not want your subject right in the center and for panning, see p. 37.

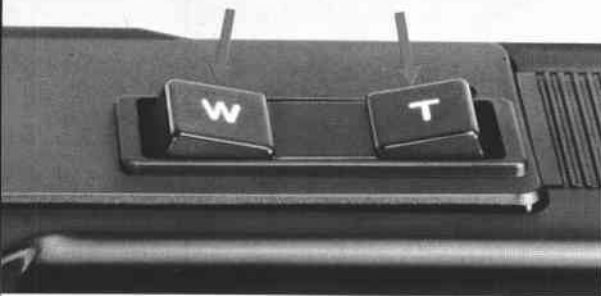

Zooming

The lens on this camera has a focal length range from 9mm (wide-angle) to 45mm (telephoto). You can vary the focal length continuously anywhere within this range either automatically or manually. This is called zooming. As you zoom towards 9mm, your subject will become smaller and you can fit more of the scene in the picture. Zooming towards 45mm has the opposite effect.

Power Zooming

1. Turn the main switch ⑮ to "R" or "RL" (remember: for turning it to "RL", you must press the shutter trigger all the way in).
2. To zoom towards 9mm, press "W" (Wide Angle) of the power zooming switch ④.
3. To zoom towards 45mm, press "T" (Telephoto) of the power zooming switch ④.

Notes

1. Power zooming takes place at a constant speed. To zoom all the way from "W" (9mm) to "T" (45mm) takes about eight seconds.
2. Zooming stops once the lens is zoomed all the way to 9mm (pressing "W") or once the lens is zoomed all the way to 45mm (pressing "T").
3. Power zooming is possible only when the camera is running.

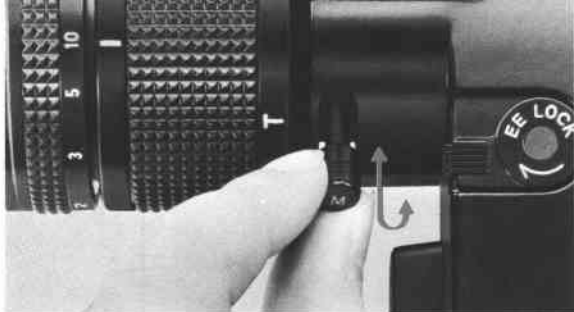

Manual Zooming

1. To zoom towards 9mm, rotate the manual zooming lever 17 towards "W" on the lens.
2. To zoom towards 45mm, rotate the manual zooming lever towards "T" on the lens.

Note

Manual zooming is useful whenever you want to zoom faster or slower than the constant speed of power zooming. It is especially convenient for composing or trimming the picture before you start filming.

 Do not pull up on the zooming lever 17 as you zoom manually. Pulling it up as you zoom towards "W" will lock the lens for close-up shooting (see p. 48).

Hint

Too much zooming in a single film can have a dizzying and monotonous effect.

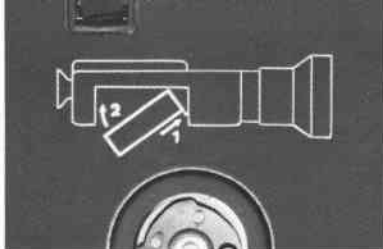

5 LOAD THE FILM

Correct Films: Super 8 sound or silent cartridges.

1. Unfold the film compartment latch 26 and turn it in the direction of the arrow. The side cover will slip downwards.
2. Hold the film with its label towards you and upright. Then, following the diagram inside the film compartment, insert the right side of the cartridge (the side with an opening where you can see the film) first. Press in the other side of the cartridge.
(Load silent film above the chrome magnetic head as illustrated.)

3. Close the side cover and lock it with the latch 26.

Notes



1. Each film has an ASA speed. The following film speeds can be used with this camera:

Type of Film	Film Speeds Available
Type A	ASA 40, ASA 160, ASA 250
Type G	ASA 160

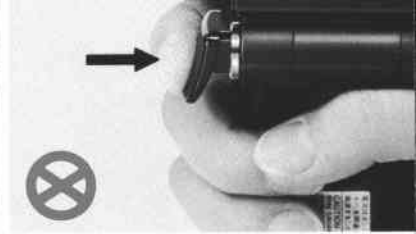
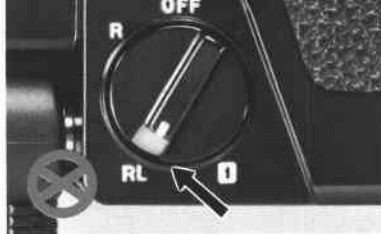
The camera automatically knows the film speed when you load the cartridge.



2. For filming outdoors in the daytime, a film with a low ASA rating, such as ASA 40, is recommended. For filming outdoors at night or indoors, a film with a high ASA rating, such as ASA 160, is recommended.
3. By looking through the small window **29** on the film compartment cover, you can tell whether or not film is loaded and, if so, what kind it is.

-  Never try to load or remove a sound cartridge when the main switch is set to "RL".
-  Even when the main switch is OFF, do not press the shutter trigger as you load a sound cartridge since it may tear the film.



Check that the Film is Loaded Properly

1. Turn the main switch ⑮ to "R".
 2. Look through the eyepiece ⑳ and press the shutter trigger ⑱ all the way in.
- * If the film transport indicator moves up and down, the film is advancing correctly.
 - * If the film transport indicator stays still, remove the cartridge (see p. 34). Turn the spindle on the side of the cartridge clockwise to take up film slack. Then reload the cartridge.

6 SET THE CCA FILTER SWITCH (TYPE A FILM)

Two types of Super 8 sound and silent films are available:

1. Type A (tungsten) film for filming in artificial tungsten lighting.
2. Type G (general-use) film for filming in either artificial or natural lighting.

If you were to use Type A film in daylight, the movie would have a bluish tinge. To solve this problem, this camera has a built-in CCA filter which will give Type A film natural colors whether you use it in artificial or natural lighting.

The CCA filter switch ㉓ has two positions: a sun symbol ☀ and a bulb symbol .

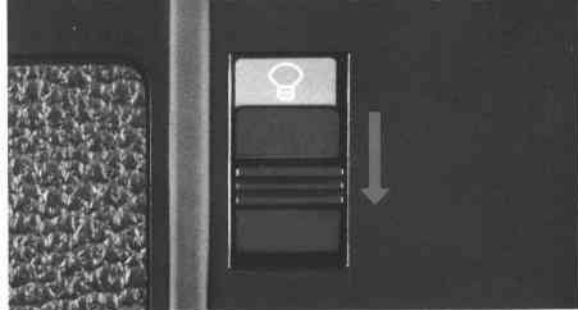

1. Push the switch up to uncover the sun symbol.
2. Push it down to uncover the bulb symbol.

Set the switch according to the following table.

Film Type \ Light Source	Daylight	Artificial Light
	Type A (Tungsten)	☀
Type G	Either ☀	or 💡

Notes

1. For type G film, you may ignore the CCA filter switch. The filter is automatically removed from the optical path.
2. The film type is indicated on the film carton and on the film cartridge. Do not forget what type of film is loaded.

7 SET THE FILMING SPEED

This camera has three filming speeds: 18 frames per second, 24 frames per second and one frame at a time (single-frame shooting). 18 fps is the normal speed for both sound and silent films.



Effects and Uses of Each Filming Speed

18 fps	24 fps	Single-frame
<ol style="list-style-type: none">1. NORMAL SPEED2. Sets a shutter speed of about 1/30 sec.3. For filming in slightly dimmer lighting than is possible at 24 fps.	<ol style="list-style-type: none">1. FOR OPTIMAL SOUND QUALITY2. Sets a shutter speed of about 1/40 sec.3. For filming in slightly brighter lighting than is possible at 18 fps.4. Film is used up slightly faster than at 18 fps.	<ol style="list-style-type: none">1. FOR SILENT CARTRIDGE ONLY2. For speeding up a slow process, such as the blooming of a flower.3. For filming animation.

1. To set a filming speed of 18 fps or 24 fps, turn the filming speed dial ⑩.
2. Set the camera for single-frame shooting by turning the main switch ⑮ from OFF to ①. It is impossible to turn this switch from "RL" to ① or vice versa.

Notes

1. Single-frame shooting is possible only with a silent cartridge. For more information, see p. 49.
2. Except for single-frame shooting, the film should be projected at the same speed you shoot it.

Hint

Changing the filming speed during the shooting of a single sound film will cause a change in sound pitch during projection. With a sound or silent cartridge, if your subject is moving, it will also cause a change in its speed of movement during projection.



8 SET THE AUDIO LEVEL DIAL (SOUND CARTRIDGE)

This dial ⑩ has three positions:

- AUTO:** For normal recording. The sound volume is controlled automatically to the most appropriate level.
- **(Low Level):** For recording very loud sounds, such as a jet plane or a train, without distortion. Also effective when there is loud background noise and the mike is very close to your subject's mouth, such as during an interview.



• (Low Level)



AUX

AUX: For recording directly from an auxiliary source, such as a stereo or a tape recorder. See pp. 53–54.

This dial has a lock button . When it is pushed to the left, you can rotate the dial to any of the three settings. Lock the dial on AUTO or “•” by pushing the lock button to the right. AUX is a click-stop setting. The dial is not lockable at AUX.

Note

It is recommended to lock the dial on AUTO or • while filming rather than to set it to an unlockable intermediate position (the intermediate positions between AUTO and • and • and AUX are for sound fading; see pp. 51-52).

Hint

You may not always wish to set the dial to • (Low Level) for recording very loud sounds. Setting it to AUTO instead will result in some distortion which you may wish to use for the tense effect.



9 SET THE TONE SWITCH (SOUND CARTRIDGE)

Simply push the tone switch ⑨ to CLEAR or SOFT. The SOFT setting is suitable for most recording situations.

SOFT: Covers a full range of sound frequencies, including low-frequency sounds. For most types of sounds when background noise and echoes are not present. Also suitable for music, drums, bells and similar sounds.

CLEAR: Filters out low-frequency sounds. Especially effective:

1. When there is background noise.
2. Inside a room where sounds echo.
3. When the subject is speaking right into the microphone.
4. Outdoors, in a windy or noisy area (outdoor interviews).



10 CONNECT THE MICROPHONE AND EARPHONE (SOUND CARTRIDGE)

The camera is supplied with Microphone DM30R and Earphone E.

1. Turn the main switch 15 to OFF.
2. Plug the microphone into the microphone 13 and remote 12 jacks.
3. Plug the earphone into the monitor jack 14.

Notes

1. The microphone can be used for filming by remote control. See pp. 44—46.

2. Keep these points in mind while you position the microphone:

- 1) The microphone picks up sounds from all directions. Keep it at least one meter (3.3 ft.) away from the camera so that it does not pick up the sound of the film drive.
- 2) Position it as closely as possible to your subject. The ideal is to have an assistant hold it. Instruct him not to pat, rub, pull (the cord) or swing it since these actions will produce static or other disturbing noises in the recording.
- 3) If you must film alone, use the microphone stand or clip which come with the camera. You can clip



Microphone Clip

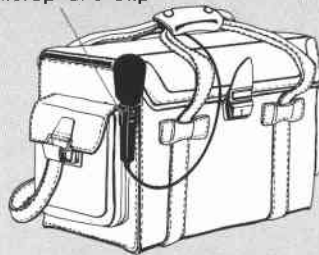

Boom Microphone
BM70



- the microphone to the camera case hanging from your shoulder, for instance. If you use the stand, make sure the microphone is securely positioned in it.
- 4) If necessary, improvise. You can, for instance, hang the microphone from a branch of a tree.
 3. Outdoors on a windy day, wind against the microphone may cause noise. In this case, attaching the microphone's windscreen will soften the noise. In fact, the windscreen may be left attached at all times.
 4. If you plan to handhold the camera for filming, it may be more convenient to use Canon Boom Microphone BM50 or BM70 (optional accessories) instead of Microphone DM30R.

11 BEFORE STARTING TO FILM, CHECK THE EXPOSURE [AND MONITOR THE SOUND (SOUND CARTRIDGE)]

1. Turn the main switch 15 to "R" and press the shutter trigger 18 HALFWAY. This turns the camera on for monitoring the sound (sound cartridge) and for exposure metering.
2. Keep pressing the trigger halfway and look into the viewfinder 23.

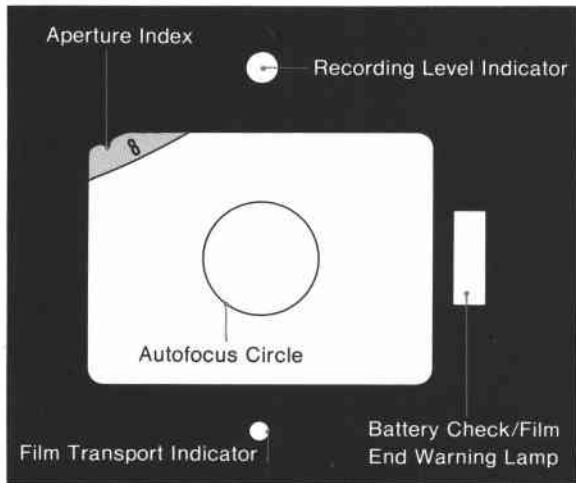

- * If a number from 1.4 to 32 is opposite the aperture index in the upper left corner of the viewfinder, exposure is correct.
 - * If the index points within the red warning zone to the left of 1.4, add light or switch to a film with a higher ASA rating.
 - * If the index points within the red warning zone to the right of 32, screw a 52mm-diameter neutral density (ND2L, ND4L or ND8L) filter into the thread at the front of the lens.
3. (Sound Cartridge) While still pressing the shutter trigger halfway, monitor the sound through the earphone and by checking the recording level indicator in the viewfinder. This indicator should blink on and off. If it glows steadily, it means that the volume is too loud. Set the audio level dial **10** to “●” (Low Level) and lock it. Reposition the microphone, if necessary, for the best sound with the least noise.

Unless there is very loud surrounding noise which makes it difficult to

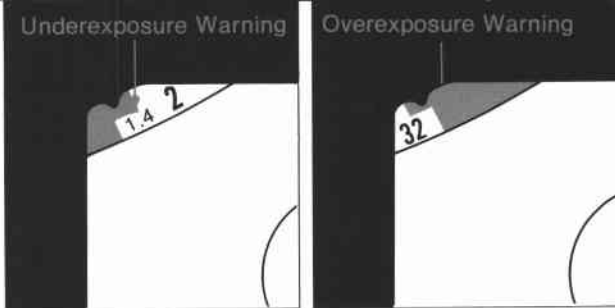

hear through the earphone, always be sure to monitor sound before filming with the earphone. When it is difficult to hear, pay particular attention to the recording level indicator.

If there is strong light, such as the sun or a window, behind your subject, see pp. 43–44 before you start to film.

Notes

1. A neutral density (ND) filter reduces the light intensity reaching the film. It has no effect on colors. The ND4L filter is twice as strong as the ND2L filter;

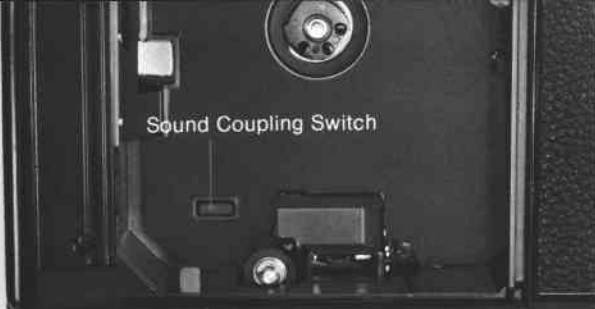

Sound Coupling Switch

the ND8L filter is three times stronger. Optional accessory.

2. It is impossible to monitor sound the usual way unless a sound cartridge is loaded in the camera. If you wish to monitor sound when a sound cartridge is not loaded, press the sound coupling switch (next to magnetic head) in the film compartment.
3. It is not necessary to turn the microphone switch ON for monitoring the sound.

 Do not use more than one filter (on lens) at a time. Using two or more may cause a darkening in the corners of the picture.

30

Download from Www.Somanuals.com. All Manuals Search And Download.

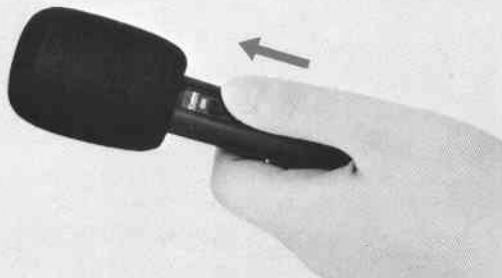

12 START FILMING

1. While checking the exposure (and monitoring the sound), focus (pp. 14–15) and compose the picture by zooming (p. 17).
2. If the microphone is connected, turn the microphone switch ON. Make sure the main switch is set to “R” and press the shutter trigger **18** all the way in to start filming (and recording).
3. Turn the main switch to “RL” (p. 13) if you wish. Zoom as desired.



If Microphone DM30R is connected, its switch must be ON or the camera will not run. If the microphone switch is

turned OFF during filming, the camera will stop running. Continue to monitor the sound while filming.

Hold the camera steady to prevent shaky movies. Suggestions: Put your right hand through the strap (for security) and around the grip, your right index finger on the shutter trigger. Use your left hand for steadying the upper part of the camera and for zooming. Press your right elbow against your body and keep your feet slightly apart, one ahead of the other. In panning to follow your subject's movement, shift only the upper part of your body. The ideal, when possible, is to mount the camera on a tripod (via tripod socket 20) and to use a remote switch (see pp. 44–46).

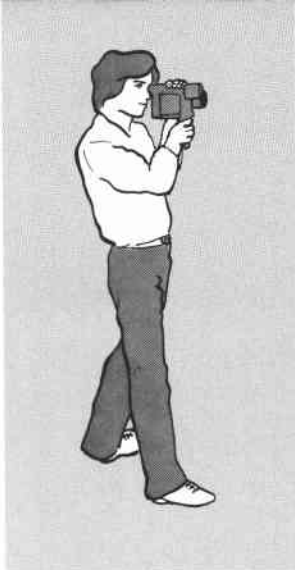

Panning

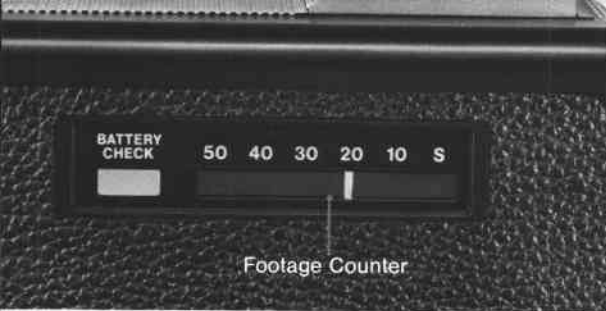

Notes

1. While filming, the film transport indicator (p. 20) bobs up and down to show that the film is advancing properly. The needle in the footage counter ② will move to show how many feet of film have been exposed. (It resets to “S” when the film cartridge is removed).
2. An LED (Light-Emitting Diode) cue light ⑥ glows on the front of the camera as long as the camera is running to let your subject know that he is being filmed.
3. If a sound cartridge is loaded and you do not want synchronized recording, disconnect the microphone before you begin to film.

Hints

1. *The sound is recorded 18 frames ahead of the corresponding picture frame. This means that, if you were to leave no room between cuts, the sound for the first eighteen frames of the new cut would be on the last eighteen frames of the cut before. For editing purposes, it is advisable to shoot one or two seconds longer than necessary at the end of each cut.*
2. *When you are recording sound while filming, plan ahead for how long you must film based on what you are recording. Essential sounds, such as conversations, explanations and announcements, for instance, must be*

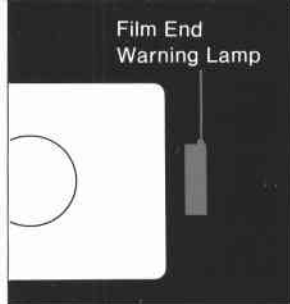

recorded in their entire length since cutting them midway will cause discontinuity and confusion in the final film.

- 3. Too much panning in the course of a single film can be monotonous.*

Film End Warning

About two feet before the end of the film, the battery check/film-end warning lamp will glow in the viewfinder. At the end of the film, the film transport indicator (p. 20) will stop moving and the footage counter ② should read "50" (unless a partially-used cartridge was reloaded).



13 AT THE END OF THE FILM, REMOVE THE CARTRIDGE

Open the side cover (p. 18) and push the film ejection lever in the direction of the arrow. The film will pop out for easy removal.

 Do not press the shutter trigger and make sure the main switch is not set to "RL" while you are removing a sound cartridge.

Notes

1. An exposed film is labeled "EXPOSED" to distinguish it from a new one.

2. It is best to have the film developed as soon as possible.
3. If you plan to edit a sound film, be sure to use an editing machine which has a sound head so that you don't cut necessary sound portions of the film.



Making More of Your AF514XL-S

Download from [Www.Somanuals.com](http://www.Somanuals.com). All Manuals Search And Download.

MORE ABOUT FOCUSING

The normal way to focus is described on pp. 14–15. Usually, the focus mode switch ⑧ should be set to “N” for normal automatic focusing.

Automatic Focus Lock

1. Set the focus mode switch ⑧ to “L” (Focus Lock).
2. Make sure your subject is covering the autofocus circle in the center of the viewfinder.
3. Press the shutter trigger ⑬ HALF-WAY. The lens will focus on your subject automatically once and then automatically lock at that subject distance.
4. Immediately press the shutter trigger all the way in to start filming.

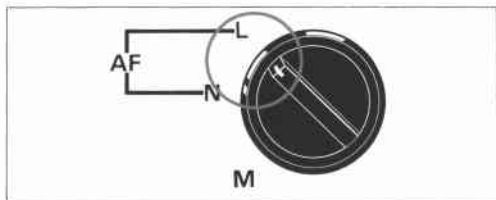

Notes

1. When you let go of the shutter trigger, the focus will automatically unlock. When you press the shutter trigger again, the lens will automatically refocus on your subject and then lock that focus. This process is repeated each time you release the shutter trigger and then press it again.
2. Use the focus lock feature:
 - 1) When you want to recompose the picture after the focus is locked so that your subject is not covering the autofocus circle.
 - 2) When you are panning to follow your subject's movement. (If you pan when the focus mode switch is on “N” and your subject, as it moves across a scene, passes behind an object closer to the camera, the camera will automatically focus on the closer object and your main subject will be blurred).
 - 3) To focus certain special types of subjects (see pp. 40–42).

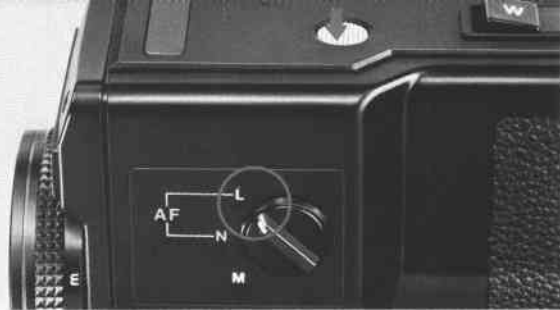
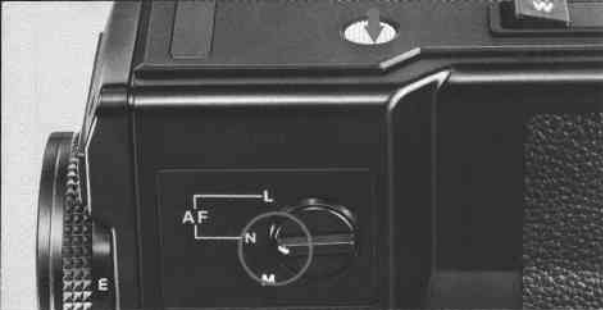

Instant Focus Lock Button ⑤

The effect upon focusing of pressing the instant focus lock button depends on where the focus mode switch ⑧ is set.

"N" Setting of Focus Mode Switch

The moment you press the instant focus lock button, the lens is locked at the point it was focused just before you pressed the button and it stays locked until you let go of the button. Use this feature when you suddenly wish to lock the focus during the course of normal autofocus filming.

"L" Setting of Focus Mode Switch

When you press the instant focus lock button, the focus unlocks, the camera refocuses automatically on the subject once and then locks on the new focus. When you let go of the button, the lens remains locked at the new focus. Use this feature if the subject distance suddenly changes while the focus is locked and you want to lock it on the new distance.

Note

The instant focus lock button has no effect when the focus mode switch is set to "M".



Manual Focusing

When you are shooting one frame at a time (p. 49) or doing macrocinematography (p. 48), you must focus manually.

1. Set the focus mode switch ⑧ to “M”.
2. Estimate the shooting distance and turn the focusing ring ①⑨ to align the distance index with that distance on the distance scale.

Notes

1. You should also focus manually on certain types of subjects (pp. 40–42).
2. You may also focus manually instead of setting the focus mode switch ⑧ to “L” when you do not want your subject in the center of the picture.

Subjects which Require Special Attention in Focusing

In the following cases, even if the subject covers the autofocus circle, it may not be focused exactly by the autofocus system.

1. The subject has little or no contrast.

2. The subject does not have any vertical lines.

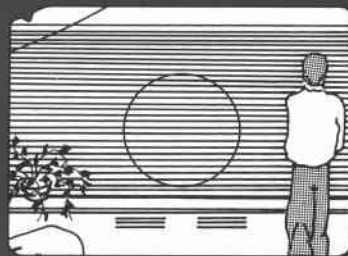
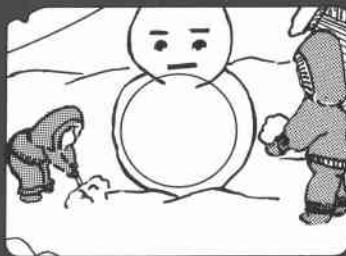
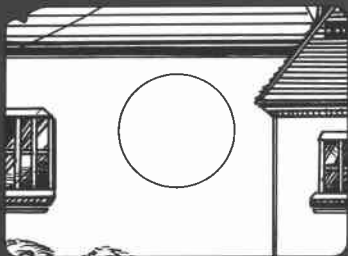

In these cases, using the instant focus lock button on the main subject may not help. Please see the next page for recommended ways to focus in these cases.



3. Two or more subjects at different distances fall within the autofocus circle at the same time.

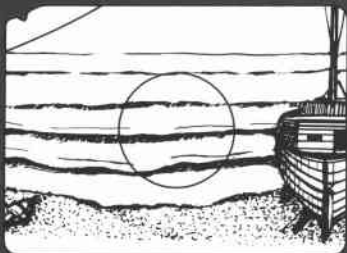

Others:

- a) The subject is very glossy or has bright light behind it, such as a glossy car or telephone or a subject which is backlit by the sun.
- b) The subject has only one pattern, such as a tile roof.
- c) The subject is composed of very small, uniform parts, such as a patch of grass or a bed of very small flowers.

To focus in these situations:

1. Either set the focus mode switch to "L", lock the focus on a substitute subject, which is at the same distance as your main subject, and then recompose the picture.
2. Or set the focus mode switch to "M" and focus manually.
3. Or leave the focus mode switch on "N", compose the picture so that a

substitute subject, which is at the same distance as your main subject, covers the autofocus circle in the viewfinder, press the instant focus lock button and then turn the camera to your main subject. You must hold in the instant focus lock button for as long as you are filming the special subject.

Focusing Chart

Setting of Focus Mode Switch ④	Effect	Effect of Instant Focus Lock Button ⑤
N (Normal Autofocus)	Autofocusing is continuous during filming.	Pressing this button locks the focus. Upon release of button, normal autofocusing resumes.
L (Focus Lock)	Autofocusing works once when shutter trigger is pressed halfway, then locks.	Pressing this button causes lens to refocus once, then lock.
M (Manual Focus)	Autofocusing does not work.	No effect.



Without Pushing EE Lock Lever



EE Lock Lever Pushed

FILMING WITH LIGHT BEHIND YOUR SUBJECT (AND OTHER UNUSUAL LIGHTING SITUATIONS)

If there is light, such as the sun, a lamp or a window, behind your subject, your subject may turn out too dark in the film. This can be corrected with the EE lock lever **16**.

1. Move close to your subject so that it fills the viewfinder.
2. Press the shutter trigger **HALFWAY** to meter the exposure, then push the EE lock lever **16** up and hold it there. This locks the exposure reading for your subject.
3. Now move back and compose the picture as you wish.

4. While still holding the EE lock lever up, start filming.

You must hold the EE lock lever up for as long as you are filming your backlit subject. As soon as you let go of the lever, the exposure is unlocked and the camera meters as usual.

Notes

1. If you cannot approach your subject, either zoom (pp. 16–17) up on it so that it fills the viewfinder or use a substitute subject, which has the same brightness as your main subject, for step one above.



Remote Switch 60



2. Using the EE lock lever may also help you to expose your subject correctly when it is surrounded by bright snow or a sand beach in summer. It is also helpful for preventing your subject from turning out too light when the subject itself is bright but surrounded by darkness, such as actors on a stage.

REMOTE CONTROL

There are two ways to control the camera without touching it. One way, which allows you to control the camera from quite a distance, is by the switch on Microphone DM30R. The other way, which is useful for reducing camera movement, is by Remote Switch 60. Remote Switch 60 comes with the camera.

1. Turn the main switch 15 to OFF. Make sure the microphone switch (or remote switch) is OFF.
2. (a) Connect the microphone to the microphone 13 and remote 12 jacks.

or

- (b) Plug the remote switch into the

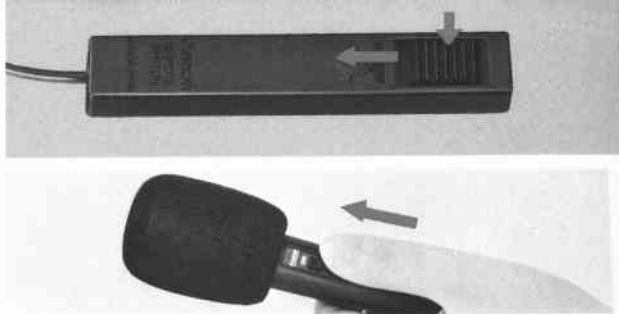
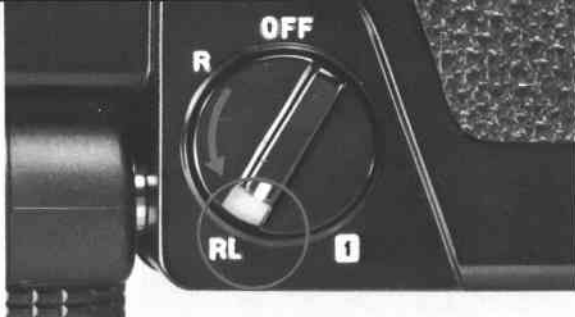

3. Press the shutter trigger all the way in and turn the main switch **15** until it click-stops on "RL".
4. Cover the eyepiece **23** with the finder cover (see p. 47) which comes with the camera.
5. (a) To start filming with the microphone, turn its switch ON. Turn it off to stop filming.
(b) To start filming with the remote switch, press down on its switch. Filming will continue as long as you press it. If you slide the switch in the direction of the arrow, filming will continue even if you take your finger off it.

6. When you are finished filming by remote control, first turn the main switch **15** off "RL". Then unplug the microphone or remote switch.

 Do not disconnect the microphone or remote switch before you turn the main switch away from "RL". Otherwise, the camera will still be on running lock and will continue to run.

 Do not set the focus mode switch **8** to "L" during filming by remote control.



Notes

1. To check that the camera is running during remote control, check the cue light ⑥. Note that the cue light will continue to glow as long as the camera is running, even if the film is ended.
2. The camera should be attached to a tripod for remote control shooting.
3. Since the microphone's cord is quite long, it is very convenient to use the microphone for remote control when you want to include yourself in the film. If the cord is not long enough, use Microphone Extension Cord E450Y (optional accessory). When you switch the microphone ON, do it as quietly as possible so that the click of it is not recorded. The microphone can be used for remote control with either a sound or a silent film.
4. The Remote Switch 60 is most useful for reducing camera movement which may lead to shaky movies. It is mainly for single-frame shooting (p. 49). If you wish to record sound while filming by remote control, use Microphone DM30R instead.
5. Remember that it is impossible to load or remove a sound cartridge when the main switch is on "RL".



Remote Control Chart

Film Type	Remote Control Device	
	Microphone DM30R	Remote Switch 60
Sound Cartridge	Possible	Possible with Canon Boom microphone or Electret Condenser Microphone CM100
Silent Cartridge	Possible	Possible

Finder Cover

This accessory comes with the camera (inserted in eyepiece 23 at purchase). Whenever you are filming and your eye is not to the eyepiece, such as during filming by remote control, cover the eyepiece with this accessory. Otherwise, light entering through the eyepiece may cause underexposure. At other times, the finder cover should be set aside.

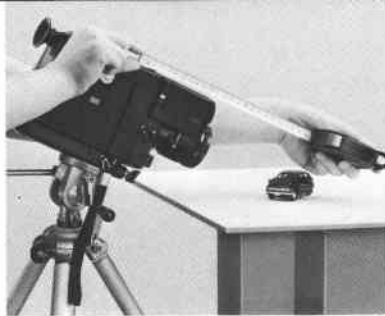

MOVING IN ON SMALL SUBJECTS (MACRO CINEMATOGRAPHY)

This camera has a feature that allows you to focus closely on small subjects. It is especially useful for filming small three-dimensional subjects and for shooting title shots for the film.

1. While lifting up the end of the manual zooming lever **17**, rotate it to the yellow dot past "W" and then let go of it. The zooming lever is now locked in the wide-angle macro range.
2. Turn the focus mode switch to "M" and turn the focusing ring **19** to infinity (∞).

3. Position the camera so that there are 23cm (9 in.) between the film plane indicator **27** and the subject. Start filming.

To cancel macrocinematography, lift up the end of the manual zooming lever and rotate it towards "T".

⊗ Do not do macrocinematography unless there is enough light so that, when you check the exposure, the aperture index points to 5.6 or a higher number.

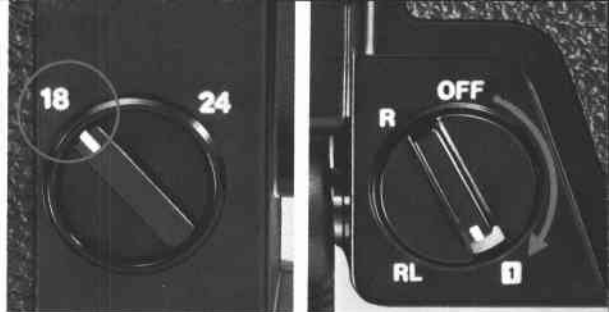

Shooting Data for Macrocinematography

Distance Scale of Lens	∞
Shooting Distance (Film Plane to Subject)	23cm (9 in.)
Approx. Field of View	7.4x10.2cm (3x4 in.)

SINGLE-FRAME SHOOTING (SILENT CARTRIDGE ONLY)

Single-frame shooting is useful for showing changes, which take place over a long period of time, in a much shorter period. It is also used for filming animated cartoons. Single-frame shooting is NOT possible with a sound cartridge.

1. Turn the main switch **15** to OFF and plug Remote Switch 60 (see p. 44) into the remote jack **12**.
2. Set the filming speed dial **30** to 18.



3. Turn the main switch clockwise from OFF all the way to **1**. Make sure it click-stops on **1**. Correct film transport is impossible if you set the switch to a position before **1**.
4. Compose the picture and focus manually (p. 39).
5. Look in the viewfinder **23** and check the exposure. (When the main switch is set to **1**, it is impossible to press the shutter trigger. It is not necessary to press it halfway as usual to check the exposure. The camera meters continuously.)
6. Press down on the remote switch to shoot. Each time you press the switch, one frame is exposed.

7. When you are finished shooting, first turn the main switch to OFF. Then unplug the remote switch.

⊗ Do not unplug the remote switch before you turn the main switch to OFF or you will waste one frame.

⊗ Do not set the filming speed dial to 24 fps. If you do, exposure will be incorrect.

⊗ Do not use the microphone switch for single-frame shooting. It may hinder film transport.

Notes

1. Automatic focusing is impossible during single-frame shooting.
2. To figure out how many frames you have to shoot to show, for instance, a flower blooming, you must first know how long it will take the flower to bloom and decide how long you want it to take during projection.

Ex.: If you know it takes one hour (3600 sec.) for the flower to bloom and if you want to show that in five seconds on film, first multiply the filming speed (18 frames/sec.) by the projection time (5 sec.)=90 frames. You must shoot 90 frames. Then divide the blooming time (3600 sec.) by the number of frames to be shot (90 frames)=40 sec./frame. Take one shot every 40 seconds.

When the interval between shots is less than sixty seconds, it is convenient to use Interval Timer E (optional accessory), which will take the shot automatically at the required interval, instead of the remote switch.



SOUND FADING (SOUND CARTRIDGE ONLY)

With this camera, it is possible to increase the sound volume gradually from silence to normal volume (fade-in) to begin a scene or to decrease the sound volume gradually from normal level to silence (fade-out) to end a scene.

Fade-in

1. Push the audio level dial lock button ① to the left.
2. Turn the audio level dial counterclockwise, but take care that it does not click-stop in the AUX setting.
3. Start filming and gradually turn the



dial **10** back towards AUTO. The sound volume will gradually increase towards the normal level.

Fade-out

1. Unlock the audio level dial.
2. While filming, gradually turn the dial counterclockwise from its starting position (AUTO or ●). Take care not to set it to AUX. The sound volume will gradually decrease.

Note

It is actually possible to begin fade-in or fade-out from any intermediate position of the audio level dial. The explanations

above are for full fade-in and full fade-out.

Hint

For best results, finish fading in or out in about four seconds.



When you are not fading sound, it is recommended to lock the audio level dial in either the AUTO or ● (Low Level) setting.



cord to the line-out jack or earphone jack of the auxiliary sound system.

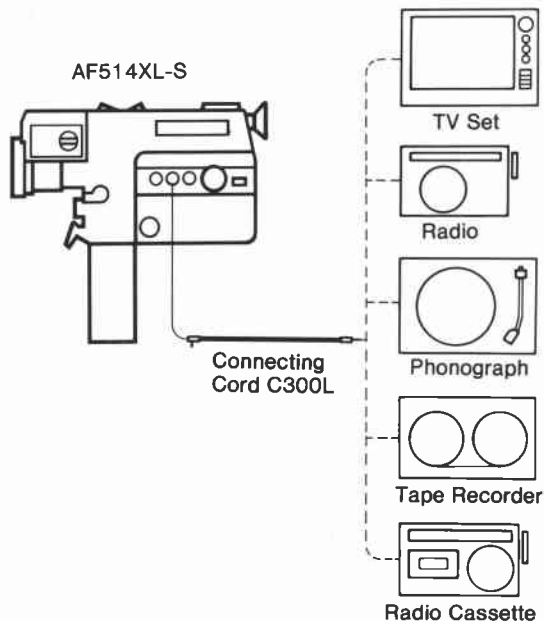

AUXILIARY INPUT (SOUND CARTRIDGE ONLY)

Since recording sounds from other sound systems, such as a stereo, a tape recorder or a television set, with the microphone would cause noise, this camera has a provision for recording sounds from these types of sources directly. To do this, you need Connecting Cord C300L, an optional accessory.

1. Unlock the audio level dial ⑩ and turn it counterclockwise until it click-stops on AUX.
2. Connect one end of Connecting Cord C300L to the camera's microphone jack ⑬. Connect the other end of the



Before you start filming, switch on the sound source and, with the earphone connected to the camera, monitor the sound by pressing the shutter trigger halfway. If the sound is too low or distorted, adjust the volume control of the auxiliary source (stereo, TV, etc.). Once you have made this adjustment, the volume will be controlled automatically by the camera to the most appropriate level.

Notes

1. Setting the tone switch **9** to CLEAR will have no effect upon sounds coming from an auxiliary source.
2. It is recommended to use Connecting Cord C300L. With a different cord, the sound may not be recorded. Check that sound is being recorded with the earphone.
3. Please follow the instructions for the auxiliary sound source.

FILMING A TELEVISION SCREEN

Since this camera has a wide shutter sector, it is very effective for filming a dimly-lit subject, such as the image from a TV screen.

1. Set the filming speed dial **30** to 18.
2. If you are filming a color TV and Type A film is loaded, set the CCA filter switch **28** to uncover the sun symbol  and adjust the TV image to a reddish tone.
3. To focus, turn the focus mode switch **8** to "L", compose the picture so that a side edge of the TV screen bisects the autofocus circle and press the shutter trigger halfway to lock the focus. Then start filming.

Notes

1. Avoid window reflections and light from other sources, such as a lamp.
2. Depending on the broadcasting system, some stripes may show up in a film of a TV image.
3. For synchronized sound recording from the TV, see p. 53.



OTHER FEATURES

Accessory Shoe ❶

The accessory shoe is for attaching a boom microphone, Lighting Adaptor LA-1 or certain other specific accessories (see **OPTIONAL ACCESSORIES**).

⊗ Never insert a movie light directly into the camera's accessory shoe. Attach it via Lighting Adaptor LA-1.

External Power Jack ❸

This is for attaching an external power source, such as the Canon Power Pack 9V (see **OPTIONAL ACCESSORIES**). An external power source is useful for filming under conditions, such as very low temperatures (see p. 56), when the camera's batteries might fail.

FILMING IN VERY LOW TEMPERATURES

The batteries may fail when you film in temperatures below about 0°C (32°F). Load new batteries and keep the camera warm inside your coat or by other means until you begin to film. It is recommended to use alkaline-manganese or Ni-Cd batteries in low temperatures and it is advisable to carry a spare set of batteries. Alternate the two sets of batteries, keeping the one which is not in use warm in a pocket. Do not throw the original set away. That the batteries do not work in the cold does not necessarily mean that they won't work normally again in warmer temperatures. The most reliable source of power for uninterrupted filming in low temperatures is the Canon Power Pack 9V (see p. 60).

Condensation forming on a camera and lens taken from cold outside temperatures into a warm room may cause corrosion. To prevent this, while still outdoors place the camera in a plastic bag.

Seal it and take it indoors. Leave the camera in the bag until it gradually reaches room temperature. It takes about one half hour for the temperature to change 10°C (18°F).

Note

Always remember to check the batteries when you are filming in low temperatures.

CARE OF THE CAMERA

The Canon AF 514XL-S is a precision instrument which should be handled with proper care. Observing the following few simple rules will help you to keep it in top condition at all times.

1. The best thing you can do for the camera is to use it regularly. In the event that it must be stored for a long time, first remove the batteries to prevent damage from battery leakage. Make sure the main switch is OFF. Place the camera in a cool, dry, dust-free area. Avoid storing it in a drawer with camphor or naphthalene. To keep the camera in top condition during prolonged storage, occasionally replace the batteries and operate the shutter trigger.
2. Keep the camera out of direct sunlight and other very hot spots, such as the trunk or glove compartment of a car or on top of a radiator.
3. Water, spray, excessive humidity, dust and sand are your camera's worst enemies. Keep it away from dust and humidity. Storing the camera in a very humid area may cause mildew to form on the lens. Clean the lens regularly during very humid seasons. If mildew does form, take the camera immediately to an authorized Canon service facility. Clean the camera especially well immediately after you use it on a beach. If you should accidentally drop it in water, it may not be repairable, but take it immediately to an authorized Canon service facility.
4. To clean the camera body, first remove dust with a blower brush (for cameras). Wipe off smudges with a silicone cloth or chamois leather. DO NOT use such cloths on the glass surfaces of the camera!
5. To clean glass surfaces and the lens, first remove dust with a blower brush. Then, to remove smudges, moisten lens tissue (for camera lens) with a couple of drops of lens cleaner (for camera lens) and gently wipe the surface.

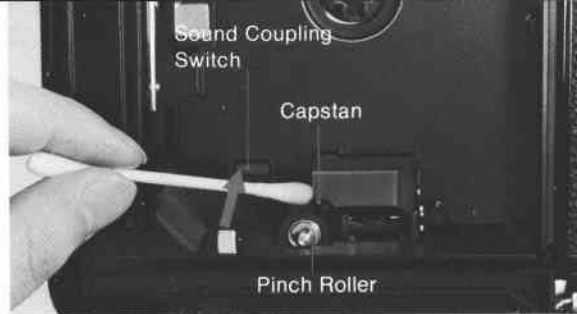
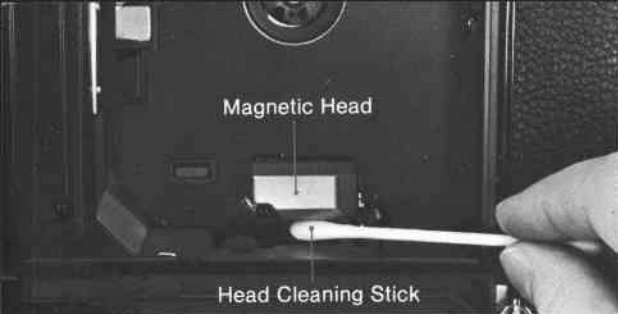

6. The recording head 38, pinch roller 36 and capstan 37 inside the film compartment become dirty from film passing through. Unless they are cleaned regularly, there may be a loss of picture or sound quality. It is important to clean the head at least once after every five cartridges. To clean the pinch roller and capstan, first set the main switch to "RL" and press the sound coupling switch 34 so that they begin rolling. Slightly moisten the head cleaning stick (cotton swab which comes with the camera) in a little alcohol and wipe the pinch roller and capstan while they are rolling. Use the

same cotton swab for wiping the underside of the chrome recording head.

7. Take care to keep anything metallic or magnetic away from the recording head and sound cartridges!
8. The film gate 35 must also be dusted out with a blower brush from time to time to remove accumulated film dust which may scratch the film.

BM 50**BM70****Electret Condenser Microphone
CM100****Wireless Microphone
Set Quartz****Microphone
WM-50****Receiver
WR-50**

OPTIONAL ACCESSORIES

Boom Microphones BM50 and BM70

These are unidirectional microphones, picking up sounds only where they are aimed, which mount in the camera's accessory shoe. It is possible to rotate the BM70 240° in 30° steps for picking up sounds from directions other than where the camera itself is aimed. The BM50, which does not rotate, is smaller and lighter. Both are extremely convenient for recording when you do not have an assistant to hold the mike or when you want to film unhindered by cords.

Electret Condenser Microphone CM 100

This high-performance, unidirectional microphone is designed to pick up sound in the direction it is pointed while minimizing sound pick-up from the sides and back. It is battery-powered.

Wireless Microphone Set Quartz

This cordless accessory consists of Wireless Microphone WM-50 Quartz and Wireless Receiver WR-50 Quartz which work by radio waves. With it, it is possible to record and/or film by remote control at distances up to forty meters (44 yds.) from the camera depending on environ-

Power Pack 9V



Lighting Adaptor
LA-1



Wireless Controller
LC-1

Receiver



Transmitter

mental conditions.

- * This accessory will be available only in the United States.

Power Pack 9V

This is an external power source which takes six 1.5V size-C batteries and plugs into the external power jack on the camera. The power pack can be kept warm in a pocket for filming uninterrupted by battery failure in low temperatures. It is also handy for long shooting sessions during which the camera's batteries might fail.

Lighting Adaptor LA-1

Attaching to the camera's accessory shoe, this accessory has a mount for attaching a movie light as well as an accessory shoe for mounting a boom microphone at the same time.



Never insert a movie light directly in the camera's accessory shoe.

Wireless Controller LC-1

This remarkable accessory is a cordless remote control device. It consists of a transmitter and a receiver which work by infrared rays. With it, you can control the camera at a distance as great as sixty meters (65.6 yds.) depending on environmental conditions.

Others

Canon's 8mm camera system includes many other accessories for the AF 514XL-S which will give you the means to do all sorts of special things in your films. Among them are Self-Timer E, Interval Timer E, Microphone Extension Cord E450Y, Connecting Cord C300L and a complete line of filters.

Self-Timer E



Interval Timer E



Microphone Extension Cord E450Y



Connecting Cord C300L



Filters

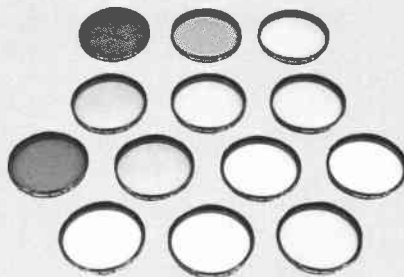

SPECIFICATIONS

Type: Super 8 movie camera for Super 8 XL sound or silent filming.

Size of Picture Frame: 5.8×4.2mm.

Lens: Canon 9-45mm f/1.4 with 5:1 zoom ratio. 13-element, 11-group construction. Spectra Coating. ϕ 52mm filter thread. Lens Cap: C-52.

Macrocinematography: Possible by locking manual zooming lever in wide-angle macro setting. When focus is on infinity (∞), the film-to-subject shooting distance is 230mm and the field of view, 74×102mm.

Focusing: By rotation of front component. Three methods possible: normal automatic focusing (N), automatic focus lock (L) and manual focusing (M). Instant focus lock button functions only when focus selector switch is on "N" or "L".

Distance Scale: m 1.2-10 ∞ .

Zooming: Power zooming by electric motor or manual zooming. Power zooming takes place at constant speed which covers entire zoom range in about 8 seconds.

Viewfinder: Single-lens-reflex type. Information includes recording level indicator, aperture scale and index with over/under exposure warnings, battery check/film end warning lamp, autofocus circle and film transport indicator.

Eyesight Correction: With eyecup. Possible over range of -4 to +2 diopters.

Light Metering System: Through-the-lens EE metering by CdS photocell. Automatic exposure, coupled to ASA film speed and filming speed.

Meter Coupling Range: ASA 250 at f/1.4 (18 fps) to ASA 25 at f/32 (24 fps).

Film Speeds:

Type A Film: ASA 40, 160, 250.

Type G Film: ASA 160.

Automatically set when film cartridge is loaded.

Color Temperature Conversion Filter: Built-in CCA filter. Automatically cancelled when daylight film is loaded. Must be cancelled manually by switch

when tungsten film is used in artificial lighting.

Exposure Correction: Possible to lock aperture with EE lock lever.

Shutter Release: Electromagnetic system. Remote control possible.

Filming Speeds: 18 and 24 frames per second (sound or silent cartridge) and single frame (silent cartridge only).

Shutter Sector Angle: 220°.

Main Switch: Settings include: OFF, R (running), RL (running lock) and **1** (single-frame shooting). A red indication appears at every setting except OFF to warn that power is on.

Power Source: Six 1.5V penlight batteries power autofocus, film drive, power zooming, exposure metering and recording systems. To be loaded in grip. External power pack (DC 9V) may be connected to external power jack.

Battery Check: An LED glows in viewfinder when battery check button is pressed if there is enough power.

Battery Life: When filming in normal

temperatures, about five cartridges at normal filming speed or about one cartridge in single-frame shooting.

Footage Counter: Indicates exposed film footage. Automatically returns to "S" upon cartridge removal.

Cue Light: Red LED on upper front end of camera glows as long as camera is running as a warning to the subject.

Film End Warning: Film end warning/battery check lamp glows in viewfinder about 2 ft. before end of film.

Sound Recording System: Sound fed into camera through connection to microphone jack or through boom microphone in accessory shoe is recorded simultaneously with filming on the magnetic stripe of a Super 8 sound film cartridge. Continuous film transport via capstan.

Capstan Motor: AC tacho generator.

Volume Control: Automatically controlled by camera's ALC (Automatic Level Control) circuit. Auto and low level settings and lock.

Tone Control: With tone switch. Two settings: SOFT and CLEAR.

Sound Fading: Possible with audio level dial.

Input Monitor: By earphone and by recording level indicator in viewfinder.

Microphone Input: Impedance, about $2k\Omega$. ϕ 3.5mm mini-jack. Minimum input sensitivity, -80 dB (0 dB = 0.775V).

Microphone: Impedance, $500\ \Omega$. Sensitivity (Dynamic Microphone DM30R): -78 dB (0 dB = $1V/\mu$ bar 1 kHz).

Auxiliary Input: Impedance, more than $100k\Omega$. ϕ 3.5mm mini-jack. Minimum input sensitivity, -20 dB (0 dB = 0.775V).

Earphone Output: Impedance, $8\ \Omega$.

Remote Control: With microphone switch for long-range remote control or with remote control switch for short-range control to prevent camera movement. ϕ 2.5mm mini-jack.

Film Compartment: Accepts sound and silent Super 8 cartridges. Opened by film compartment opening knob.

Grip: Collapsible. Serves as battery compartment.

Accessory Shoe: For attaching a boom microphone, receivers for Wireless Microphone or Wireless Controller or Lighting Adapter LA-1.

Dimensions: $234 \times 136 \times 64$ mm. ($9\text{-}3/16'' \times 5\text{-}3/8'' \times 2\text{-}1/2''$).

Weight: 1660 g (3 lbs. 11 ozs.), including batteries.

Accessories:

Provided: Soft Case, Lens Cap C-52, Dynamic Microphone DM30R (with windscreen, stand and clip), Earphone E, Remote Switch 60, Finder Cover 6, Rubber Guard, Neckstrap, Head Cleaning (cotton swab) Stick.

Optional: Boom Microphone BM70 or BM50, Electret Condenser Microphone CM100, 52mm Filters, Self-timer E, Interval Timer E, Power Pack 9V, Connecting Cord C300L, Microphone Extension Cord E450Y, Wireless Controller LC-1, Headphone HP-M (availability differs from area to area), Wireless Microphone Set Quartz

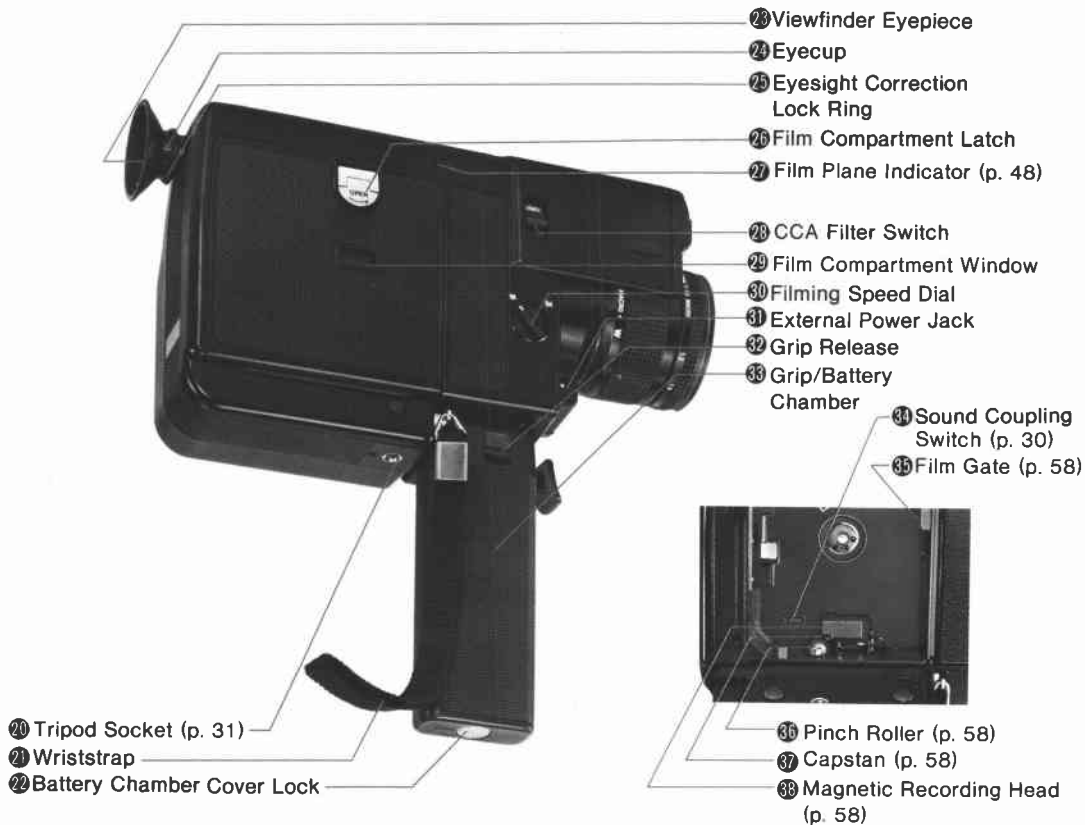

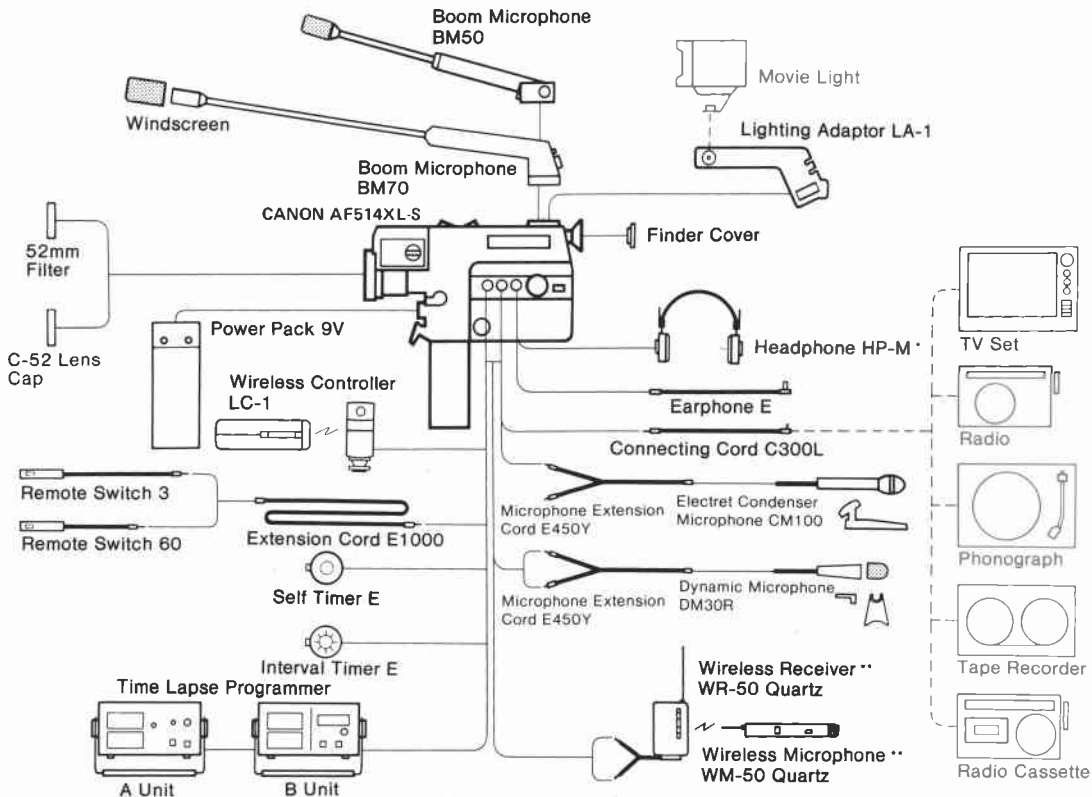

* Availability differs from area to area.

** Available only in the U.S.A.

Download from Www.Somanuals.com. All Manuals Search And Download.

(available in the near future and only in the U.S.A.).

Subject to change without notice.

For your own convenience in the event of loss or theft, may we suggest that you fill in the serial numbers of your AF 514XL-S equipment on this form.

Name of the Camera:

Canon AF 514XL-S

Body Number: _____

Additional Accessories: _____

Name: _____

Address: _____

Country: _____

Telephone Number: _____

Canon

CANON INC. 7-1, Nishi-Shinjuku 2-Chome, Shinjuku-ku, Tokyo 160, Japan
Mailing address: P.O. Box 5050, Dai-ichi Seimei Building, Tokyo 160, Japan

- U.S.A. **CANON U.S.A., INC. HEADQUARTERS**
One Canon Plaza, Lake Success, N.Y. 11042, U.S.A.
CANON U.S.A., INC. MANHATTAN SERVICE CENTER
600 Third Avenue, New York, N.Y. 10016, U.S.A.
CANON U.S.A., INC. ATLANTA BRANCH
6380 Peachtree Industrial Blvd., Norcross, Georgia 30071, U.S.A.
CANON U.S.A., INC. CHICAGO BRANCH
140 Industrial Drive, Elmhurst, Illinois 60126, U.S.A.
CANON U.S.A., INC. LOS ANGELES BRANCH
123 Paulerino Avenue East, Costa Mesa, California 92626, U.S.A.
CANON U.S.A., INC. LOS ANGELES SERVICE CENTER
3321 Wilshire Blvd., Los Angeles, California 90010, U.S.A.
CANON U.S.A., INC. SAN FRANCISCO OFFICE
776 Market Street, San Francisco, California 94102, U.S.A.
CANON U.S.A., INC. DALLAS OFFICE
2036, Royal Lane, Suite 290, Dallas, Texas 75229, U.S.A.
CANON U.S.A., INC. HONOLULU OFFICE
Bldg. B-2, 1050 Ala Moana Blvd., Honolulu, Hawaii 96814, U.S.A.
- CANADA **CANON CANADA INC. HEADQUARTERS**
3245 American Drive, Mississauga, Ontario L4V 1N4, Canada
CANON CANADA INC. MONTREAL SERVICE CENTRE
10652 Côte de Liesse, Lachine, Quebec H8T 1A5, Canada
CANON CANADA INC. CALGARY OFFICE
2828, 16th Street, N.E. Calgary, Alberta T2E 7K7, Canada
- EUROPE, AFRICA
& MIDDLE EAST **CANON EUROPA N.V.**
P.O. Box 7907, 1008 AC Amsterdam, The Netherlands
CANON FRANCE-PHOTO CINEMA S.A.
30, boulevard Vital-Bouhot, Ile de la Jatte, 92521 Neuilly-sur-Seine, France
CANON UK LTD.
Units 4 & 5, Brent Trading Centre, North Circular Road, London NW10 0JF, United Kingdom
- CENTRAL &
SOUTH AMERICA **CANON LATIN AMERICA, INC. DEPTO. DE VENTAS**
Apartado 7022, Panamá 5, República de Panamá
CANON LATIN AMERICA, INC. CENTRO DE SERVICIO Y REPARACION
Apartado 2019, Zona Libre de Colón, República de Panamá
- SOUTHEAST ASIA **CANON HONGKONG TRADING CO., LTD.**
Golden Beer Industrial Centre, 7/F, 66-82 Chai Wan Kok Street,
Tsuen Wan, New Territories, Hong Kong
CANON SINGAPORE PTE. LTD.
60-B Martin Road, #10-01/0B, Singapore Warehouse, Block C, Singapore 0923
- OCEANIA **CANON AUSTRALIA PTY. LTD.**
Unit 1/37, Waterloo Road, North Ryde (Macquarie Park), N.S.W. 2113, Australia
- JAPAN **CANON SALES CO., INC.**
11-28, Mita, 3-Chome, Minato-ku, Tokyo 108, Japan

Free Manuals Download Website

<http://myh66.com>

<http://usermanuals.us>

<http://www.somanuals.com>

<http://www.4manuals.cc>

<http://www.manual-lib.com>

<http://www.404manual.com>

<http://www.luxmanual.com>

<http://aubethermostatmanual.com>

Golf course search by state

<http://golfingnear.com>

Email search by domain

<http://emailbydomain.com>

Auto manuals search

<http://auto.somanuals.com>

TV manuals search

<http://tv.somanuals.com>