  
***fx-5800P******User's Guide***  



<http://world.casio.com/edu/>

## ■ Remove the insulation sheet!

Your calculator comes with a special insulation sheet, which isolates the battery from the contacts in the battery compartment, to keep the battery from running down during storage and shipment. Be sure to remove the insulation sheet before trying to use the calculator for the first time.

### To remove the insulation sheet

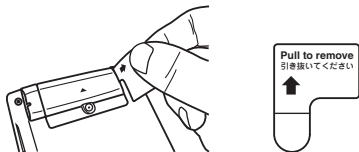
1. Pull the tab of the insulation sheet in the direction indicated by the arrow to remove it.



2. After removing the insulation sheet, press the P button on the back of the calculator with a thin, pointed object to initialize the calculator.

**Be sure to perform this step! Do not skip it!**

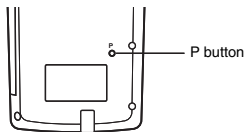

## ■ Resetting the Calculator to Initial Defaults

Perform the operation below to return the calculator to its initial default settings. Note that resetting the calculator will also delete all data currently stored in its memory.

### To reset the calculator to initial defaults

1. Press **[MODE]** **[>]** **[3]** (SYSTEM) **[3]** (Reset All).
  - This causes the “Reset All?” confirmation message to appear.
2. Press **[EXE]** (Yes).
  - If you do not want to reset the calculator to initial defaults, press **[EXIT]** (No) instead of **[EXE]** (Yes).

The following is what happens when you reset the calculator to initial defaults.

- The calculation mode and setup configuration return to the initial defaults described under “Clearing the Calculation Mode and Setup Settings (Reset Setup)” (page 13).
- Calculation history data, memory data, statistical calculation sample data, program data, and all other data input by you is deleted.

## About this Manual

- Most of the keys perform multiple functions. Pressing **SHIFT** or **ALPHA** and then another key will perform the alternate function of the other key. Alternate functions are marked above the keycap.



Alternate function operations are notated in this manual as shown below.

Example: **SHIFT** **sin** (**sin**<sup>-1</sup>) **1** **EXE**

The notation in parentheses indicates the function executed by the preceding key operation.

- The following shows the notation used in the manual for menu items that appear on the display.

Example: **FUNCTION** – {**PROG**} – {**→**}

The notation in braces ( { } ) indicates the menu item being selected.

- The following shows the notation used in the manual for menu items that appear on the display (which are executed by pressing a number key).

Example: **FUNCTION** – {**MATH**} **1** (**dX**)

The notation in parentheses indicates the menu item accessed by the preceding number key.

- The displays and illustrations (such as key markings) shown in this User's Guide are for illustrative purposes only, and may differ somewhat from the actual items they represent.
- The contents of this manual are subject to change without notice.
- In no event shall CASIO Computer Co., Ltd. be liable to anyone for special, collateral, incidental, or consequential damages in connection with or arising out of the purchase or use of this product and items that come with it. Moreover, CASIO Computer Co., Ltd. shall not be liable for any claim of any kind whatsoever by any other party arising out of the use of this product and the items that come with it.
- Company and product names used in this manual may be registered trademarks or trademarks of their respective owners.

## Symbols Used in Examples

Various symbols are used in the examples of this manual to alert you to settings that need to be configured in order to perform the example operation correctly.

- A mark like the ones shown below indicates that you need to change the calculator's display format setting.

If you see this:	Change the display format setting to:	If you see this:	Change the display format setting to:
<b>MATH</b>	Natural Display	<b>LINE</b>	Linear Display

For details, see "Selecting the Display Format (MthIO, LineIO)" (page 11).

- A mark like the ones shown below indicates that you need to change the calculator's angle unit setting.

If you see this:	Change the angle unit setting to:	If you see this:	Change the angle unit setting to:
<b>Deg</b>	Deg	<b>Rad</b>	Rad

For details, see "Specifying the Angle Unit" (page 12).

## Safety Precautions

Be sure to read the following safety precautions before using this calculator. Be sure to keep all user documentation handy for future reference.



### Caution

This symbol is used to indicate information that can result in personal injury or material damage if ignored.

### Battery

- After removing the battery from the calculator, put it in a safe place where it will not get into the hands of small children and accidentally swallowed.
- Keep batteries out of the reach of small children. If accidentally swallowed, consult with a physician immediately.
- Never charge the battery, try to take the battery apart, or allow the battery to become shorted. Never expose the battery to direct heat or dispose of it by incineration.
- Improperly using a battery can cause it to leak and damage nearby items, and can create the risk of fire and personal injury.
  - Always make sure that the battery's positive  $\oplus$  and negative  $\ominus$  ends are facing correctly when you load it into the calculator.
  - Remove the battery if you do not plan to use the calculator for a long time.
  - Use only the type of battery specified for this calculator in this manual.

### Disposing of the Calculator

- Never dispose of the calculator by burning it. Doing so can cause certain components to suddenly burst, creating the risk of fire and personal injury.

# Operating Precautions

- **Be sure to press the P button on the back of the calculator before using the calculator for the first time.** See page 1 for information about the P button.
- **Even if the calculator is operating normally, replace the battery at least once a year.** A dead battery can leak, causing damage to and malfunction of the calculator. Never leave a dead battery in the calculator.
- **The battery that comes with this unit discharges slightly during shipment and storage. Because of this, it may require replacement sooner than the normal expected battery life.**
- **Do not use an oxyride battery or any other type of nickel-based primary battery with this product.** Incompatibility between such batteries and product specifications can result in shorter battery life and product malfunction.
- **Low battery power can cause memory contents to become corrupted or lost completely.** Always keep written records of all important data.
- **Avoid use and storage of the calculator in areas subjected to temperature extremes.** Very low temperatures can cause slow display response, total failure of the display, and shortening of battery life. Also avoid leaving the calculator in direct sunlight, near a window, near a heater or anywhere else it might be exposed to very high temperatures. Heat can cause discoloration or deformation of the calculator's case, and damage to internal circuitry.
- **Avoid use and storage of the calculator in areas subjected to large amounts of humidity and dust.** Take care never to leave the calculator where it might be splashed by water or exposed to large amounts of humidity or dust. Such conditions can damage internal circuitry.
- **Never drop the calculator or otherwise subject it to strong impact.**
- **Never twist or bend the calculator.** Avoid carrying the calculator in the pocket of your trousers or other tight-fitting clothing where it might be subjected to twisting or bending.
- **Never try to take the calculator apart.**
- **Never press the keys of the calculator with a ballpoint pen or other pointed object.**
- **Use a soft, dry cloth to clean the exterior of the calculator.** If the calculator becomes very dirty, wipe it off with a cloth moistened in a weak solution of water and a mild neutral household detergent. Wring out all excess liquid before wiping the calculator. Never use thinner, benzene or other volatile agents to clean the calculator. Doing so can remove printed markings and can damage the case.

# Contents

Remove the insulation sheet! .....	1
Resetting the Calculator to Initial Defaults.....	1
About this Manual.....	2
Symbols Used in Examples.....	2
<b>Safety Precautions .....</b>	<b>3</b>
<b>Operating Precautions .....</b>	<b>4</b>
<b>Before starting a calculation... ..</b>	<b>9</b>
Turning On the Calculator.....	9
Key Markings.....	9
Reading the Display .....	9
<b>Calculation Modes and Setup .....</b>	<b>10</b>
Selecting a Calculation Mode.....	10
Calculator Setup.....	11
Clearing the Calculation Mode and Setup Settings (Reset Setup).....	13
<b>Using the Function Menu.....</b>	<b>14</b>
<b>Inputting Calculation Expressions and Values.....</b>	<b>14</b>
Inputting a Calculation Expression (Natural Input) .....	14
Using Natural Display .....	16
Editing a Calculation.....	19
Finding the Location of an Error.....	21
<b>Displaying Decimal Results while Natural Display is Selected as the Display Format .....</b>	<b>21</b>
Example Calculations.....	22
<b>Using the <math>\square \rightarrow \square</math> Key (S-D Transformation).....</b>	<b>22</b>
Examples of S-D Transformation.....	22
<b>Basic Calculations.....</b>	<b>23</b>
Arithmetic Calculations.....	23
Fractions.....	24
Percent Calculations.....	26
Degree, Minute, Second (Sexagesimal) Calculations .....	27
<b>Calculation History and Replay.....</b>	<b>28</b>
Accessing Calculation History.....	29
Using Replay .....	29
<b>Using Multi-statements in Calculations .....</b>	<b>30</b>
<b>Calculator Memory Operations .....</b>	<b>31</b>
Using Answer Memory (Ans).....	32
Using Independent Memory .....	33
Using Variables .....	34
Clearing All Memory Contents .....	35

<b>Reserving Variable Memory</b> .....	<b>35</b>
User Memory Area .....	35
Using Extra Variables .....	36
<b>Using <math>\pi</math> and Scientific Constants</b> .....	<b>37</b>
Pi ( $\pi$ ) .....	37
Scientific Constants .....	38
<b>Scientific Function Calculations</b> .....	<b>40</b>
Trigonometric and Inverse Trigonometric Functions .....	40
Angle Unit Conversion .....	41
Hyperbolic and Inverse Hyperbolic Functions .....	41
Exponential and Logarithmic Functions .....	41
Power Functions and Power Root Functions .....	42
Integration Calculation .....	43
Derivative .....	45
Second Derivative .....	46
$\Sigma$ Calculation .....	46
Coordinate Conversion (Rectangular $\leftrightarrow$ Polar) .....	47
Random Number Functions .....	49
Other Functions .....	50
<b>Using Engineering Notation</b> .....	<b>53</b>
Using $10^3$ Engineering Notation (ENG) .....	53
ENG Conversion Examples .....	54
Using Engineering Symbols .....	54
<b>Complex Number Calculations (COMP)</b> .....	<b>55</b>
Inputting Complex Numbers .....	55
Complex Number Display Setting .....	56
Complex Number Calculation Result Display Examples .....	56
Conjugate Complex Number (Conj) .....	57
Absolute Value and Argument (Abs, Arg) .....	57
Extracting the Real Part (ReP) and Imaginary Part (ImP) of a Complex Number .....	58
Overriding the Default Complex Number Display Format .....	58
<b>Matrix Calculations (COMP)</b> .....	<b>59</b>
Matrix Calculation Overview .....	59
About the Mat Ans Screen .....	59
Inputting and Editing Matrix Data .....	59
Performing Matrix Calculations .....	62
<b>Sequence Calculations (RECUR)</b> .....	<b>65</b>
Sequence Calculation Overview .....	65
Creating a Sequence Table .....	68
Sequence Calculation Precautions .....	69
<b>Equation Calculations (EQN)</b> .....	<b>69</b>
Equation Calculation Overview .....	69
Selecting an Equation Type .....	71
Inputting Values for Coefficients .....	71

Viewing Equation Solutions .....	72
<b>Statistical Calculations (SD/REG) .....</b>	<b>72</b>
Statistical Sample Data .....	72
Performing Single-variable Statistical Calculations .....	75
Performing Paired-variable Statistical Calculations .....	77
Statistical Calculation Examples .....	84
<b>Base-<i>n</i> Calculations (BASE-N) .....</b>	<b>86</b>
Performing Base- <i>n</i> Calculations .....	86
Converting a Displayed Result to another Number Base .....	87
Specifying a Number Base for a Particular Value .....	88
Performing Calculations Using Logical Operations and Negative Binary Values .....	89
<b>CALC .....</b>	<b>90</b>
Using CALC .....	90
<b>SOLVE .....</b>	<b>92</b>
Expressions Supported by SOLVE .....	92
Using SOLVE .....	92
<b>Creating a Number Table from a Function (TABLE) .....</b>	<b>94</b>
TABLE Mode Overview .....	94
Creating a Number Table .....	96
Number Table Creation Precautions .....	97
<b>Built-in Formulas .....</b>	<b>97</b>
Using Built-in Formulas .....	97
Built-in Formula Names .....	99
User Formulas .....	102
<b>Program Mode (PROG) .....</b>	<b>104</b>
Program Mode Overview .....	105
Creating a Program .....	105
Running a Program .....	109
File Screen Operations .....	111
Deleting a Program .....	112
<b>Command Reference .....</b>	<b>113</b>
Program Commands .....	113
Statistical Calculation Commands .....	121
Other PROG Mode Commands .....	122
<b>Data Communication (LINK) .....</b>	<b>124</b>
Connecting Two fx-5800P Calculators to Each Other .....	124
Transferring Data Between fx-5800P Calculators .....	124
<b>Memory Manager (MEMORY) .....</b>	<b>126</b>
Deletable Data Types and Supported Delete Operations .....	127
Using Memory Manager .....	127



<b>Appendix .....</b>	<b>128</b>
Calculation Priority Sequence .....	128
Stack Limitations .....	130
Calculation Ranges, Number of Digits, and Precision.....	130
Error Messages .....	132
Before assuming malfunction of the calculator... ..	135
Lower Battery Indicator .....	135
<b>Power Requirements .....</b>	<b>136</b>
<b>Specifications .....</b>	<b>137</b>

# Before starting a calculation...

## Turning On the Calculator

Press **AC/ON**. This displays the same screen that was on the display when you last turned off the calculator.

## Adjusting Display Contrast

If the figures on the display become hard to read, try adjusting display contrast.

1. Press **MODE**  $\blacktriangledown$  **3** (SYSTEM) **1** (Contrast).
  - This displays the contrast adjustment screen.



CONTRAST  
LIGHT [◀]                      DARK [▶]

2. Use **◀** and **▶** to adjust display contrast.
3. After the setting is the way you want, press **EXIT**.

### Note

You can also use **◀** and **▶** to adjust contrast while the calculation mode menu that appears when you press the **MODE** key is on the display.

## Turning Off the Calculator

Press **SHIFT** **AC/ON** (OFF).

## Key Markings

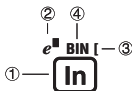

	Function	Key Marking Color	To perform the function:
①	In		Press the key.
②	e <sup>x</sup>	Orange	Press <b>SHIFT</b> and then press the key.
③	[	Red	Press <b>ALPHA</b> and then press the key.
④	BIN	Green	In the BASE-N Mode, press the key.

## Reading the Display

### Input Expressions and Calculation Results

This calculator can display both the expressions you input and calculation results on the same screen.

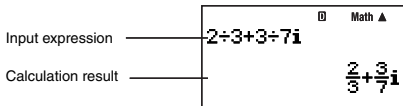

## Display Symbols

The symbols described below appear on the display of the calculator to indicate the current calculation mode, the calculator setup, the progress of calculations, and more.

The nearby sample screen shows the **D** symbol.

The **D** symbol turns on when degrees (Deg) are selected for the default angle unit (page 12).

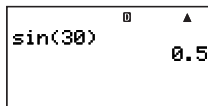

# Calculation Modes and Setup

## Selecting a Calculation Mode

Your calculator has 11 “calculation modes”.

### Selecting a Calculation Mode

- Press **MODE**.
  - This displays the calculation mode menu. Use **▼** and **▲** to switch between menu screen 1 and screen 2.

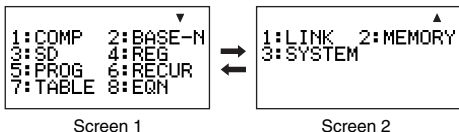

- Perform one of the following operations to select the calculation mode you want.

To select this calculation mode:	Go to this screen:	And press this key:
COMP (Computation)	Screen 1	<b>1</b> (COMP)
BASE-N (Base $n$ )		<b>2</b> (BASE-N)
SD (Single Variable Statistics)		<b>3</b> (SD)
REG (Paired Variable Statistics)		<b>4</b> (REG)
PROG (Programming)		<b>5</b> (PROG)
RECUR (Recursion)		<b>6</b> (RECUR)
TABLE (Tables)		<b>7</b> (TABLE)
EQN (Equations)		<b>8</b> (EQN)

To select this calculation mode:	Go to this screen:	And press this key:
LINK (Communication)	Screen 2	<b>[1]</b> (LINK)
MEMORY (Memory Management)		<b>[2]</b> (MEMORY)
SYSTEM (Contrast Adjustment, Reset)		<b>[3]</b> (SYSTEM)

- To exit the calculation mode menu without changing the calculation mode, press **[MODE]**.

## Calculator Setup

The calculator setup can be used to configure input and output settings, calculation parameters, and other settings. The setup can be configured using setup screens, which you access by pressing **[SHIFT] [MODE] (SETUP)**. There are two setup screens, and you can use **[▲]** and **[▼]** to navigate between them.

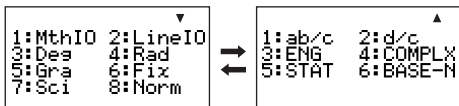

### Selecting the Display Format (MthIO, LineIO)

You can select either natural display (MthIO) or linear display (LineIO) for expressions you input and for calculation results.

#### Natural Display (MthIO)

Natural display displays fraction, square root, derivative, integral, exponential, logarithmic, and other mathematical expressions just as they are written. This format is applied both for input expressions and for calculation results. When natural display is selected, the result of a calculation is displayed using fraction, square root, or  $\pi$  notation whenever possible.

For example, the calculation  $1 \div 2$  produces the result  $\frac{1}{2}$ , while  $\pi \div 3$  results in  $\frac{1}{3} \pi$ .

#### Linear Display (LineIO)

With linear display, expressions and functions are input and displayed using a special format defined by your calculator. For example,  $\frac{1}{2}$  would be input as  $1 \downarrow 2$ , and  $\log_2 4$  would be input as  $\log(2,4)$ .

When linear display is selected all calculation results, except for fractions, are displayed using decimal values.

To select this display format:	Perform this key operation:
Natural Display (MthIO)	<b>[SHIFT] [MODE] [1]</b> (MthIO)
Linear Display (LineIO)	<b>[SHIFT] [MODE] [2]</b> (LineIO)

#### Note

For information about the input procedures when using the natural display and linear display, see "Inputting Calculation Expressions and Values" on page 14 of this manual and the sections of this manual that explanation of each type of calculation.

## ❑ Specifying the Angle Unit

To select this angle unit:	Perform this key operation:
Degrees	<b>SHIFT</b> <b>MODE</b> <b>3</b> (Deg)
Radians	<b>SHIFT</b> <b>MODE</b> <b>4</b> (Rad)
Grads	<b>SHIFT</b> <b>MODE</b> <b>5</b> (Gra)

$$(90^\circ = \frac{\pi}{2} \text{ radians} = 100 \text{ grads})$$

## ❑ Specifying the Display Digits

To specify this display digit setting:	Perform this key operation:
Number of Decimal Places	<b>SHIFT</b> <b>MODE</b> <b>6</b> (Fix) <b>0</b> (0) to <b>9</b> (9)
Significant Digits	<b>SHIFT</b> <b>MODE</b> <b>7</b> (Sci) <b>1</b> (1) to <b>9</b> (9), <b>0</b> (10)
Exponential Display Range	<b>SHIFT</b> <b>MODE</b> <b>8</b> (Norm) <b>1</b> (Norm1) or <b>2</b> (Norm2)

The following explains how calculation results are displayed in accordance with the setting you specify.

- From zero to nine decimal places are displayed in accordance with the number of decimal places (Fix) you specify. Calculation results are rounded off to the specified number of digits.

Example:  $100 \div 7 = 14.286$  (Fix = 3)  
 $14.29$  (Fix = 2)

- After you specify the number of significant digits with Sci, calculation results are displayed using the specified number of significant digits and 10 to the applicable power. Calculation results are rounded off to the specified number of digits.

Example:  $1 \div 7 = 1.4286 \times 10^{-1}$  (Sci = 5)  
 $1.429 \times 10^{-1}$  (Sci = 4)

- Selecting Norm1 or Norm2 causes the display to switch to exponential notation whenever the result is within the ranges defined below.

Norm1:  $10^{-2} > |x|, |x| \geq 10^{10}$

Norm2:  $10^{-9} > |x|, |x| \geq 10^{10}$

Example:  $100 \div 7 = 14.28571429$  (Norm1 or Norm2)  
 $1 \div 200 = 5. \times 10^{-3}$  (Norm1)  
 $0.005$  (Norm2)

## ❑ Specifying the Fraction Display Format

To specify this fraction format for display of calculation results:	Perform this key operation:
Mixed Fractions	<b>SHIFT</b> <b>MODE</b> <b>▼</b> <b>1</b> (ab/c)
Improper Fractions	<b>SHIFT</b> <b>MODE</b> <b>▼</b> <b>2</b> (d/c)

## ❑ Specifying the Engineering Symbol Setting

This setting lets you turn engineering symbols on and off. For more information, see “Using Engineering Symbols” on page 54.

To do this:	Perform this key operation:
Turn engineering symbols on	<b>SHIFT</b> <b>MODE</b> <b>▼</b> <b>3</b> (ENG) <b>1</b> (EngOn)
Turn engineering symbols off	<b>SHIFT</b> <b>MODE</b> <b>▼</b> <b>3</b> (ENG) <b>2</b> (EngOff)

While engineering symbols are turned on (EngOn), engineering symbols are used when a calculation result is outside of the range of  $1 \leq |x| < 1000$ .

## ❑ Specifying the Complex Number Display Format

You can specify either rectangular coordinate format or polar coordinate format for complex number calculation results.

To specify this complex number format for display of calculation results:	Perform this key operation:
Rectangular Coordinates	<b>SHIFT</b> <b>MODE</b> <b>▼</b> <b>4</b> (COMPLX) <b>1</b> ( $a+bi$ )
Polar Coordinates	<b>SHIFT</b> <b>MODE</b> <b>▼</b> <b>4</b> (COMPLX) <b>2</b> ( $r\angle\theta$ )

ENG conversion (page 53) is not possible while polar coordinate format is selected.

## ❑ Specifying the Statistical Frequency Setting

Use the key operations below to turn statistical frequency on or off during SD Mode and REG Mode calculations (page 72).

To select this frequency setting:	Perform this key operation:
Frequency On	<b>SHIFT</b> <b>MODE</b> <b>▼</b> <b>5</b> (STAT) <b>1</b> (FreqOn)
Frequency Off	<b>SHIFT</b> <b>MODE</b> <b>▼</b> <b>5</b> (STAT) <b>2</b> (FreqOff)

## ❑ Changing the BASE-N Mode Negative Value Setting

You can use the key operations below to enable or disable use of negative values in the BASE-N Mode.

To specify this setting:	Perform this key operation:
Negative values enabled	<b>SHIFT</b> <b>MODE</b> <b>▼</b> <b>6</b> (BASE-N) <b>1</b> (Signed)
Negative values disabled	<b>SHIFT</b> <b>MODE</b> <b>▼</b> <b>6</b> (BASE-N) <b>2</b> (Unsigned)

## ■ Clearing the Calculation Mode and Setup Settings (Reset Setup)

Perform the following key operation to reset the calculation mode and setup settings.

**MODE** **▼** **3** (SYSTEM) **2** (Reset Setup) **EXE** (Yes)

If you do not want to reset the calculator's settings, press **EXIT** (No) in place of **EXE** (Yes) in the above operation.

Calculation Mode.....COMP

### Setup Settings

Display Format.....MthIO  
Angle Unit.....Deg  
Exponential Display.....Norm1  
Fraction Format.....d/c  
Complex Number Format..... $a+bi$   
Engineering Symbol.....EngOff  
Statistical Frequency.....FreqOff  
BASE-N Negatives.....Signed

## Using the Function Menu

The function menu provides you with access to various mathematical functions, commands, constants, symbols, and other special operations.

### ▣ Displaying the Function Menu

Press **FUNCTION**. The function menu shown below will appear if you press **FUNCTION** while in the COMP Mode for example.

D Math▼	
1:MATH	2:COMPLX
3:PROG	4:CONST
5:ANGLE	6:CLR
7:STAT	8:MATRIX

### ▣ Exiting the Function Menu

Press **EXIT**.

## Inputting Calculation Expressions and Values

### ■ Inputting a Calculation Expression (Natural Input)

The natural input system of your calculator lets you input a calculation expression just as it is written and execute it by pressing **EXE**. The calculator determines the proper priority sequence for addition, subtraction, multiplication, division, fractions and parentheses automatically.

**Example:**  $2(5+4) - 2 \times (-3) =$

**LINE**

2 ( 5 + 4 ) - 2 × (-) 3 =

D ▲
2(5+4)-2×-3
24

## ❖ Inputting Scientific Functions with Parentheses (sin, cos, $\sqrt{\quad}$ , etc.)

Your calculator supports input of the scientific functions with parentheses shown below. Note that after you input the argument, you need to press  $\text{)}\text{}$  to close the parentheses.

sin(, cos(, tan(,  $\sin^{-1}$ (,  $\cos^{-1}$ (,  $\tan^{-1}$ (, sinh(, cosh(, tanh(,  $\sinh^{-1}$ (,  $\cosh^{-1}$ (,  $\tanh^{-1}$ (, log(, ln(,  $e^{\wedge}$ (,  $10^{\wedge}$ (,  $\sqrt{\quad}$ (,  $\sqrt[3]{\quad}$ (, Abs(, Pol(, Rec(,  $\int$ (,  $d/dx$ (,  $d^2/dx^2$ (,  $\Sigma$ (, P(, Q(, R(, Arg(, Conjg(, ReP(, ImP(, Not(, Neg(, Det(, Trn(, Rnd(, Int(, Frac(, Intg(, RanInt#(

**Example:**  $\sin 30 =$

**LINE**

$\text{sin}$   $\text{[3]}$   $\text{[0]}$   $\text{[)]}$   $\text{[EXE]}$

$\text{sin}(30)$   $\text{[0]}$   $\text{[▲]}$   
0.5

### Note

Some functions require a different input sequence when using natural input. For more information, see "Inputting Calculation Expressions Using Natural Display" on page 17.

## ❖ Omitting the Multiplication Sign

You can omit the multiplication sign in the following cases.

- Immediately before an open parenthesis:  $2 \times (5 + 4)$
- Immediately before a scientific function with parentheses:  $2 \times \sin(30)$ ,  $2 \times \sqrt{3}$
- Before a prefix symbol (excluding the minus sign):  $2 \times h123$
- Before a variable name, constant, or random number:  $20 \times A$ ,  $2 \times \pi$ ,  $2 \times i$

## ❖ Final Closed Parenthesis

You can omit one or more closed parentheses that come at the end of a calculation, immediately before the  $\text{[EXE]}$  key is pressed.

**Example:**  $(2 + 3)(4 - 1) = 15$

**LINE**

$\text{[ ( ]}$   $\text{[ 2 ]}$   $\text{[ + ]}$   $\text{[ 3 ]}$   $\text{[ ) ]}$   
 $\text{[ ( ]}$   $\text{[ 4 ]}$   $\text{[ - ]}$   $\text{[ 1 ]}$   $\text{[ EXE ]}$

$(2+3)(4-1$   $\text{[0]}$   $\text{[▲]}$   
15

## ❖ Calculation Expression Wrapping (Linear Display)

When using linear display, calculation expressions that are longer than 16 characters (numbers, letters, and operators) are wrapped automatically to the next line.

**Example:**  $123456789 + 123456789 = 246913578$

**LINE**

$\text{[1]}$   $\text{[2]}$   $\text{[3]}$   $\text{[4]}$   $\text{[5]}$   $\text{[6]}$   $\text{[7]}$   $\text{[8]}$   $\text{[9]}$   $\text{[+]}$   
 $\text{[1]}$   $\text{[2]}$   $\text{[3]}$   $\text{[4]}$   $\text{[5]}$   $\text{[6]}$   $\text{[7]}$   $\text{[8]}$   $\text{[9]}$   $\text{[EXE]}$

$123456789+123456$   $\text{[0]}$   $\text{[▲]}$   
 $789$   
246913578



## ❑ Number of Input Characters (Bytes)

As you input a mathematical expression, it is stored in memory called an “input area,” which has a capacity of 127 bytes. This means you can input up to 127 bytes for a single mathematical expression.

When linear display is selected as the display format, each function normally uses one or two bytes of memory. With the natural display format, each function use four or more bytes of memory. For more information, see “Inputting Calculation Expressions Using Natural Display” on page 17.

Normally, the cursor that indicates the current input location on the display is either a flashing vertical bar (|) or horizontal bar (—). When the remaining capacity of the input area is 10 bytes or less, the cursor changes to a flashing box (■).

If this happens, stop input of the current expression at some suitable location and calculate its result.

## ■ Using Natural Display

While natural display is selected as the display format (page 11), you can input fractions and some scientific functions just as they are written.

## ❑ Natural Display Basics

The table below lists the types of scientific functions that you can input using natural display format.

- The \*1 column shows the number of bytes of memory used up by each scientific function. See “Number of Input Characters (Bytes)” (page 16) for more information.
- For information about the \*2 column, see “Using Values and Expressions as Arguments” (page 18).

## Scientific Functions that Support Natural Display

Function	Key Operation	*1	*2
Improper Fraction		9	Yes
Mixed Fraction		14	No
$\log(a,b)$	- {MATH}   (logab)	7	Yes
$10^x$	( $10^x$ )	4	Yes
$e^x$	( $e^x$ )	4	Yes
Square Root ( $\sqrt{\quad}$ )		4	Yes
Cube Root ( $\sqrt[3]{\quad}$ )	( $\sqrt[3]{\quad}$ )	9	Yes
Square		4	No
Reciprocal	( $x^{-1}$ )	5	No
Power		4	Yes
Power Root	( $\sqrt[\quad]{\quad}$ )	9	Yes
Absolute Value (Abs)	- {MATH}  (Abs)	4	Yes
Integral	- {MATH}  ( $\int dx$ )	8	Yes

Function	Key Operation	*1	*2
Derivative	– {MATH} <b>2</b> (d/dX)	7	Yes
Second Derivative	– {MATH} <b>3</b> (d <sup>2</sup> /dX <sup>2</sup> )	7	Yes
Σ Calculation	– {MATH} <b>4</b> (Σ())	11	Yes

### Note

If you include values or expressions in parentheses ( $\left[ \right]$  and  $\left[ \right]$ ) while using natural display, the height of the parentheses will adjust automatically depending on whether they enclose one line or two lines. Regardless of their height, opening and closing parentheses take up one byte of memory each.

### Inputting Calculation Expressions Using Natural Display

- To input a specific function, perform the operation in the “Key Operation” column of the “Scientific Functions that Support Natural Display” table.
- At the input fields indicated by  $\square$ , input the required values and expressions.
  - Use the cursor keys to move between the input fields of the expression.

**Example:** To input  $\frac{1+2}{2 \times 3}$

#### MATH

Specify fraction input:

Input the numerator:  $\square$  **1** **+**  $\square$  **2**

Move the cursor to the denominator:  $\square$

Input the denominator:  $\square$  **2** **×**  $\square$  **3**

Execute the calculation:  $\square$  **EXE**

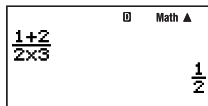

### Important!

- Certain types of expressions can cause the height of a calculation formula to be greater than one display line. The maximum allowable height of a calculation formula is two display screens (31 dots  $\times$  2). Further input will become impossible if the height of the calculation you are inputting exceeds the allowable limit.
- Nesting of functions and parentheses is allowed. Further input will become impossible if you nest too many functions and/or parentheses. If this happens, divide the calculation into multiple parts and calculate each part separately.

## ◀ Scrolling the Screen Left and Right

The screen will show up to 14 characters when inputting with natural display. When you input more than 14 characters, the screen will scroll automatically. If this happens, the ◀ symbol will turn on to let you know that the expression runs off the left side of the display.

**MATH**

Input expression \_\_\_\_\_  $1111 + 2222 + 3333 + 444$

Displayed expression \_\_\_\_\_  $\leftarrow 2222+3333+444$

Cursor \_\_\_\_\_

- While the ◀ symbol is turned on, you can use the ◀ key to move the cursor to the left and scroll the screen.
- Scrolling to the left causes part of the expression to run off the right side of the display, which is indicated by the ▶ symbol on the right. While the ▶ symbol is on the screen, you can use the ▶ key to move the cursor to the right and scroll the screen.

## ◀ Using Values and Expressions as Arguments

When inputting with natural display, in certain cases you can use a value or an expression that is enclosed in parentheses that you have already input as the argument of a scientific function (such as  $\sqrt{\quad}$ ), the numerator of a fraction, etc. For the sake of explanation here, a natural display function that supports the use of previously input values or parenthetical expressions is called an “insertable natural display function”.

**Example:** To insert the natural display function  $\sqrt{\quad}$  into the parenthetical expression in the following calculation:  $1 + (2 + 3) + 4$

**MATH**

(Move the cursor immediately to the left of the parenthetical expression.)

SHIFT DEL (INS)

√

### Note

- Not all natural display functions are insertable. Only the scientific functions for which “Yes” appears in the column of the table under “Scientific Functions that Support Natural Display” (page 16) are insertable.
- The cursor can be immediately to the left of a parenthetical expression, a numeric value, or a fraction. Inserting an insertable function will make the parenthetical expression, value, or fraction the argument of the inserted function.
- If the cursor is located immediately to the left of a scientific function, the entire function becomes the argument of the inserted function.

## ■ Editing a Calculation

### ❑ Insert Mode and Overwrite Mode

The calculator has two input modes. The insert mode inserts your input at the cursor location, shifting anything to the right of the cursor to make room. The overwrite mode replaces the key operation at the cursor location with your input.

Only the insert mode is available when natural display is selected as the display format. You cannot change to the overwrite mode. When linear display is selected as the display format, you can choose either the insert mode or overwrite mode for input.

	Original Expression	Pressing $\oplus$
Insert Mode	Cursor $1+2$ <b>B4</b>	$1+2+B4$
Overwrite Mode	Cursor $1+2$ <b>B4</b>	$1+2+4$

A vertical cursor (|) indicates the insert mode, while a horizontal cursor (—) indicates the overwrite mode.

### ■ Selecting an Input Mode

The initial default input mode setting is insert mode. If you have linear display selected as the display format and want to change to the overwrite mode, press: **SHIFT** **DEL** (INS).

### ❑ Editing a Key Operation You Just Input

When the cursor is located at the end of the input, press **DEL** to delete the last key operation you performed.

**Example:** To correct  $369 \times 13$  so it becomes  $369 \times 12$

**MATH** **LINE**      3 6 9 **X** 1 3      369×13 Math ▲

**DEL**      369×1| Math ▲

**2**      369×12 Math ▲

### ❑ Deleting a Key Operation

With the insert mode, use **←** and **→** to move the cursor to the right of the key operation you want to delete and then press **DEL**. With the overwrite mode, move the cursor to the key operation you want to delete and then press **DEL**. Each press of **DEL** deletes one key operation.

**Example:** To correct  $369 \times \times 12$  so it becomes  $369 \times 12$

Insert Mode  
**MATH** **LINE**      3 6 9 **X** **X** 1 2      369××12 Math ▲

Overwrite Mode

**LINE**

3 6 9 X X 1 2

369x12

DEL 369x1

369x12

369x\_12

369x\_2

## Editing a Key Operation within an Expression

With the insert mode, use and to move the cursor to the right of the key operation you want to edit, press to delete it, and then perform the correct key operation. With the overwrite mode, move the cursor to the key operation you want to correct and then perform the correct key operation.

**Example:** To correct cos(60) so it becomes sin(60)

Insert Mode

**MATH LINE**

cos(60)

DEL cos(6)

sin sin(60)

cos(60)

\_os(60)

sin sin(\_0)

Overwrite Mode

**LINE**

## Inserting Key Operations into an Expression

Be sure to select the insert mode whenever you want to insert key operations into an expression. Use and to move the cursor to the location where you want to insert the key operations and then perform them.

## Finding the Location of an Error

If your calculation expression is incorrect, an error message will appear on the display when you press **EXE** to execute it. Pressing the **EXIT**, **◀**, or **▶** key after an error message appears will cause the cursor to jump to the location in your calculation that caused the error so you can correct it.

**Example:** When you input  $14 \div 0 \times 2 =$  instead of  $14 \div 5 \times 2 =$   
(The following examples use the insert mode.)

**LINE**

**1** **4** **÷** **0** **×** **2** **EXE**

**Math ERROR**  
**Press: [EXIT]**

**EXIT** (or **▶**, **◀**)

**14****÷****0****×****2**  
Location of Error

**DEL** **5**

**14****÷****5****×****2**

**EXE**

**14****÷****5****×****2** **5.6**

- Instead of pressing **EXIT**, **▶** or **◀** while an error message is displayed to find the location of the error, you could also press **AC/ON** to clear the calculation.

## Displaying Decimal Results while Natural Display is Selected as the Display Format

Pressing **EXE** to execute a calculation while natural display is selected will display the result in natural format. Pressing **SHIFT** **EXE** will execute the calculation and display the result in decimal format.

To display the result in this format:	Perform this key operation:
Natural Format	<b>EXE</b>
Decimal Format	<b>SHIFT</b> <b>EXE</b>

### Note

When linear display is selected as the display format, execution of a calculation is always displayed in linear (decimal) format, regardless of whether you press **EXE** or **SHIFT** **EXE**.

## Example Calculations

Example:  $\sqrt{2} + \sqrt{8} = 3\sqrt{2}$

**MATH**

$\sqrt{\square}$  2  $\rightarrow$  +  $\sqrt{\square}$  8  $\square$  EXE

Math ▲  
 $\sqrt{2} + \sqrt{8}$   
 $3\sqrt{2}$

Produce the result in decimal format:

$\sqrt{\square}$  2  $\rightarrow$  +  $\sqrt{\square}$  8  $\square$  SHIFT  $\square$  EXE

Math ▲  
 $\sqrt{2} + \sqrt{8}$   
4.242640687

## Using the $\square$ Key (S-D Transformation)

You can use the  $\square$  key to transform a value between its decimal (D) form and its standard (S) form (fraction,  $\sqrt{\quad}$ ,  $\pi$ ).

### Important!

- Depending on the type of calculation result that is on the display when you press the  $\square$  key, the conversion process may take some time to perform.
- With certain calculation results, pressing the  $\square$  key will not convert the displayed value.

## Examples of S-D Transformation

**Example 1:** While linear display is selected as the display format, to perform the calculation  $111 \div 33$ , and then convert the result to fraction format

**LINE**

1 1 1  $\div$  3 3  $\square$  EXE

▲  
 $111 \div 33$   
3.363636364

$\square$

▲  
 $111 \div 33$   
37.11

$\square$

▲  
 $111 \div 33$   
3.363636364

## Note

- Each press of the  $\text{S}\blacktriangleright\text{D}$  key toggles the displayed result between the two forms.
- The format of the fraction depends on which fraction display format (improper or mixed) is currently selected (page 12).

**Example 2:** While natural display is selected as the display format, to perform the calculation  $111 \div 33$ , and then convert the result to decimal format

### MATH

$\boxed{1} \boxed{1} \boxed{1} \boxed{\div} \boxed{3} \boxed{3} \boxed{\text{EXE}}$

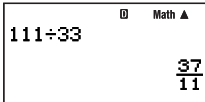

111 $\div$ 33  
 $\frac{37}{11}$

$\text{S}\blacktriangleright\text{D}$

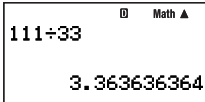

111 $\div$ 33  
3.363636364

$\text{S}\blacktriangleright\text{D}$

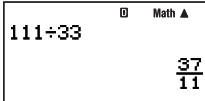

111 $\div$ 33  
 $\frac{37}{11}$

**Example 3:** While natural display is selected as the display format, to perform the  $\pi$  calculation shown below, and then convert the result to decimal format

### MATH

$\text{SHIFT}$   $\times 10^{\square}$  ( $\pi$ )  $\times$   $\frac{2}{5}$   $\blacktriangledown$   $\text{EXE}$

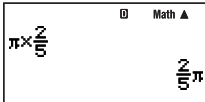

$\pi \times \frac{2}{5}$   
 $\frac{2}{5}\pi$

$\text{S}\blacktriangleright\text{D}$

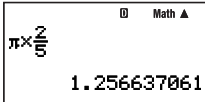

$\pi \times \frac{2}{5}$   
1.256637061

## Basic Calculations

Unless otherwise noted, the calculations in this section can be performed in any of the calculator's calculation mode, except for the BASE-N Mode.

### Arithmetic Calculations

Arithmetic calculations can be used to perform addition ( $\text{+}$ ), subtraction ( $\text{-}$ ), multiplication ( $\text{\times}$ ), and division ( $\text{\div}$ ).



**Example 1:**  $2.5 + 1 - 2 = 1.5$

**LINE**

2 . 5 + 1 - 2 = EXE

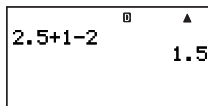

**Example 2:**  $7 \times 8 - 4 \times 5 = 36$

**LINE**

7 X 8 - 4 X 5 = EXE

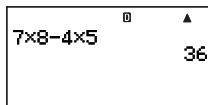

- The calculator determines the proper priority sequence for addition, subtraction, multiplication, and division automatically. See "Calculation Priority Sequence" on page 128 for more information.

## Fractions

Keep in mind when inputting fractions on your calculator that the input procedure you need to use depends on whether natural display or linear display is selected as the display format (page 11), as shown below.

### Natural Display:

Key Operation	Display
Improper Fraction 	$\frac{7}{3}$
Mixed Fraction 	$2\frac{1}{3}$

### Linear Display:

Key Operation	Display
Improper Fraction 	$  \begin{array}{c}  7 \text{ } \downarrow \text{ } 3 \\  \text{Numerator} \quad \text{Denominator}  \end{array}  $
Mixed Fraction 	$  \begin{array}{c}  2 \text{ } \downarrow \text{ } 1 \text{ } \downarrow \text{ } 3 \\  \text{Integer} \quad \text{Numerator} \quad \text{Denominator}  \end{array}  $

As you can see above, natural display lets you input fractions as they appear in your textbook, while linear display requires input of a special fraction symbol ( $\downarrow$ ).

### Note

- Under initial default settings, fractions are displayed as improper fractions.
- Fraction calculation results are always reduced automatically before being displayed. Executing  $2 \downarrow 4 =$ , for example, will display the result  $1 \downarrow 2$ .

## ◆ Fraction Calculation Examples

Example 1:  $\frac{2}{3} + \frac{1}{2} = \frac{7}{6}$

**MATH**

$\frac{2}{3}$

$\frac{2}{3}$

$+$

$\frac{2}{3} +$

$\frac{1}{2}$

$\frac{2}{3} + \frac{1}{2}$

**EXE**

$\frac{2}{3} + \frac{1}{2}$

$\frac{7}{6}$

**LINE**

$2 \frac{3}{3} + 1 \frac{2}{2}$

$2.3 + 1.2$

**EXE**

$2.3 + 1.2$

$7.6$

Example 2:  $3\frac{1}{4} + 1\frac{2}{3} = 4\frac{11}{12}$  (Fraction Display Format: ab/c)

**LINE**

$3 \frac{1}{4} + 1 \frac{2}{3}$

$3.1.4 + 1.2.3$   
 $4.11.12$

**MATH**

**SHIFT**  $\frac{a}{b}$   $3$   $+$   $1$   $\frac{2}{3}$   $+$

$3\frac{1}{4} +$

**SHIFT**  $\frac{a}{b}$   $1$   $2$   $\frac{2}{3}$  **EXE**

$3\frac{1}{4} + 1\frac{2}{3}$

$4\frac{11}{12}$

## Note

- If the total number of elements (integer digits + numerator digits + denominator digits + separator symbols) that make up a mixed fraction expression is greater than 10, the calculation result will be displayed in decimal form.
- If an input calculation includes a mixture of fraction and decimal values, the result will be displayed in decimal format.
- You can input integers only for the elements of a fraction.

## Switching between Improper Fraction and Mixed Fraction Format

To convert an improper fraction to a mixed fraction (or a mixed fraction to an improper fraction), press **SHIFT** **S $\frac{D$**  ( $a\frac{b}{c} \leftrightarrow \frac{d}{c}$ ).

## Switching between Fraction and Decimal Format

Use the procedure below to toggle a displayed calculation result between fraction and decimal format.

**Example:**  $1.5 = \frac{3}{2}$ ,  $\frac{3}{2} = 1.5$

**LINE**

**1** **.** **5** **EXE**

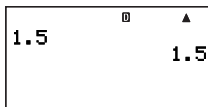

**S $\frac{D$**

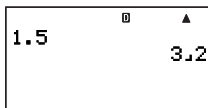

The current fraction display format setting determines if an improper or mixed fraction is displayed.

**S $\frac{D$**

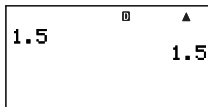

## Note

The calculator cannot switch from decimal to fraction format if the total number of elements (integer digits + numerator digits + denominator digits + separator symbols) that make up a mixed fraction is greater than 10.

## Percent Calculations

Inputting a value and with a percent (%) sign makes the value a percent. The percent (%) sign uses the value immediately before it as the argument, which is simply divided by 100 to get the percentage value.

## Percent Calculation Examples

All of the following examples are performed using linear display (**LINE**).

**Example 1:**  $2\% = 0.02$   $\left(\frac{2}{100}\right)$

2 SHIFT ▾ (%) EXE

2% 0.02

**Example 2:**  $150 \times 20\% = 30$   $\left(150 \times \frac{20}{100}\right)$

1 5 0 X 2 0 SHIFT ▾ (%) EXE

150×20% 30

**Example 3:** What percent of 880 is 660?

6 6 0 ÷ 8 8 0  
SHIFT ▾ (%) EXE

660÷880% 75

**Example 4:** Increase 2500 by 15%.

2 5 0 0 + 2 5 0 0 X  
1 5 SHIFT ▾ (%) EXE

2500+2500×15% 2875

**Example 5:** Reduce 3500 by 25%.

3 5 0 0 - 3 5 0 0 X  
2 5 SHIFT ▾ (%) EXE

3500-3500×25% 2625

## ■ Degree, Minute, Second (Sexagesimal) Calculations

You can perform calculations using sexagesimal values, and you can convert between sexagesimal and decimal.

### ◀ Inputting Sexagesimal Values

The following is basic syntax for inputting a sexagesimal value.

{Degrees} [°] {Minutes} ['] {Seconds} ["]

**Example:** To input  $2^{\circ}30'30''$

**LINE**

2 [°] 3 0 ['] 3 0 ["] EXE

2° 30' 30" 2° 30' 30"

- Note that you must always input something for the degrees and minutes, even if they are zero.

Example: To input  $0^{\circ}00'30''$ , press 0 [°] 0 ['] 3 0 ["].

## ❑ Sexagesimal Calculation Examples

- The following types of sexagesimal calculations will produce sexagesimal results.
  - Addition or subtraction of two sexagesimal values
  - Multiplication or division of a sexagesimal value and a decimal value

**Example 1:**  $2^{\circ}20'30'' + 39^{\circ}30'' = 3^{\circ}00'00''$

**LINE**

2 [DMS] 2 0 [DMS] 3 0 [DMS] +  
0 [DMS] 3 9 [DMS] 3 0 [DMS] EXE

2° 20' 30" + 0° 39' 30"  
3° 0' 0"

**Example 2:**  $2^{\circ}20'00'' \times 3.5 = 8^{\circ}10'00''$

**LINE**

2 [DMS] 2 0 [DMS] X  
3 . 5 EXE

2° 20' × 3.5  
8° 10' 0"

## ❑ Performing a Decimal Calculation to Obtain a Sexagesimal Result

You can use the "►DMS" command to execute a decimal calculation and obtain a sexagesimal result. The "►DMS" command can be used in the COMP Mode only.

**Example:** Perform the calculation  $100 \div 3$  so it produces a sexagesimal result

**LINE**

1 0 0 [DMS] ÷ 3 EXE  
FUNCTION - {ANGLE} 4 (►DMS) EXE

100÷3  
33.33333333  
Ans►DMS  
33° 20' 0"

## ❑ Converting between Sexagesimal and Decimal

Pressing [DMS] while a calculation result is displayed will toggle the value between sexagesimal and decimal.

**Example:** To convert 2.255 to sexagesimal

**LINE**

2 . 2 5 5 EXE

2.255  
2.255

[DMS]  
2.255  
2° 15' 18"

## Calculation History and Replay

You can use calculation history in the COMP and BASE-N Modes.

## ■ Accessing Calculation History

The ▲ symbol in the upper right corner of the display indicates that there is data stored in calculation history. To view the data in calculation history, press ▲. Each press of ▲ will scroll upwards (back) one calculation, displaying both the calculation expression and its result.

**Example:**

**MATH**

1 + 1 = 2    2 + 2 = 4    3 + 3 = 6

3+3  
6



2+2  
4



1+1  
2

While scrolling through calculation history records, the ▼ symbol will appear on the display, which indicates that there are records below (newer than) the current one. When this symbol is turned on, press ▼ to scroll downwards (forward) through calculation history records.

### Important!

- Calculation history records are all cleared when you change to a different calculation mode, or when you change the display format.
- Calculation history capacity is limited. Whenever you perform a new calculation while calculation history is full, the oldest record in calculation history is deleted automatically to make room for the new one.

### Note

A calculation that contains any of the following functions is not stored in calculation history when it is executed.

CALC, SOLVE, Built-in Formulas, User Formulas

## ■ Using Replay

While a calculation history record is on the display, press ◀ or ▶ to display the cursor and enter the editing mode. Pressing ▶ displays the cursor at the beginning of the calculation expression, while ◀ displays it at the end. After you make the changes you want, press = to execute the calculation.

**Example:**  $4 \times 3 + 2.5 = 14.5$   
 $4 \times 3 - 7.1 = 4.9$

**LINE**

4 × 3 + 2.5 = 14.5

4x3+2.5  
14.5

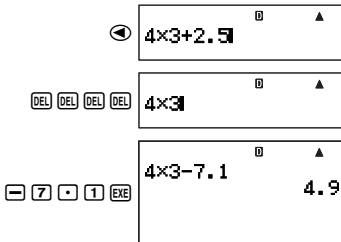

## Using Multi-statements in Calculations

A multi-statement is a statement that is made up of multiple calculation expressions separated by special separator codes (: and ▲). The following examples show how the two separator codes differ from each other.

**{expression 1} : {expression 2} : .... : {expression n}**

Pressing **EXE** executes each expression in sequence, starting with {expression 1} and ending with the final expression in the series. After that, the result of the final expression appears on the display.

**Example:** To perform the calculation  $123 + 456$ , and then subtract its result from 1000

**LINE**

1 2 3 + 4 5 6 SHIFT √ (:)  
 1 0 0 0 - SHIFT (←) (Ans)

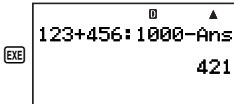
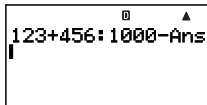

**{expression 1} ▲ {expression 2} ▲ .... ▲ {expression n}**

In this case, pressing **EXE** starts execution starting with {expression 1}. When execution reaches a ▲ separator, execution pauses and the calculation result up to that point appears on the display. Pressing **EXE** again will resume execution from the expression below the ▲ separator.

**Example:** To display the result of the calculation  $123 + 456$ , and then subtract it from 1000

**LINE**

1 2 3 + 4 5 6 SHIFT x<sup>2</sup> (▲)  
 1 0 0 0 - SHIFT (←) (Ans)

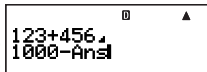

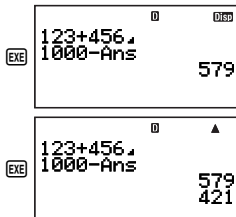

## Note

- The **Disp** symbol turns on in the upper right corner of the display when execution of a multi-statement calculation has been paused by a  $\blacktriangle$  separator.
- When performing a multi-statement calculation, Ans (Answer Memory) (page 32) is updated each time any of the statements that makes up a multi-statement produces a result.
- You can mix “ $\blacktriangle$ ” and “:” separators within the same calculation.

# Calculator Memory Operations

Your calculator includes the types of memory described below, which you can use for storage and recall of values.

Memory Name	Description
Answer Memory	Answer Memory contains the result of the last calculation you performed.
Independent Memory	Independent memory comes in handy when adding or subtracting multiple calculation results.
Variables	The letters A through Z can be assigned different values individually and used in calculations. Note that variable M is also used for storing independent memory values.
Extra Variables	You can create extra variables when you need storage for more values than provided by the 26 letters from A through Z. You can reserve up to 2372 extra variables, which are named Z[1], Z[2], etc.
Formula Variables	The following literal variables are used by the calculator's built-in formulas or user formulas. <ul style="list-style-type: none"> <li>• Lower-cast alphabetic characters: a through z</li> <li>• Greek characters: <math>\alpha</math> through <math>\omega</math>, A through <math>\Omega</math></li> <li>• Subscripted alphabetic and Greek characters: <math>A_1</math>, <math>a_0</math>, <math>\omega_t</math>, <math>\Delta_x</math>, etc.</li> </ul> For details about built-in formulas and formula variables, see “Built-in Formulas” (page 97).

The types of memory described above are not cleared when you press the **AC/ON** key, change to another mode, or turn off the calculator.



## ■ Using Answer Memory (Ans)

The result of any new calculation you perform on the calculator is stored automatically in Answer Memory (Ans).

### ◻ Automatic Insertion of Ans in Consecutive Calculations

If you start a new calculation while the result of a previous calculation is still on the display, the calculator will insert Ans into the applicable location of the new calculation automatically.

**Example 1:** To divide the result of  $3 \times 4$  by 30

**LINE**

$\boxed{3} \boxed{\times} \boxed{4} \boxed{=}$

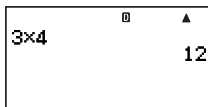

(Next)  $\boxed{\div} \boxed{3} \boxed{0} \boxed{=}$

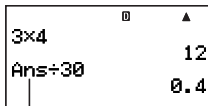

Pressing  $\boxed{\div}$  inputs Ans automatically.

**Example 2:** To determine the square root of the result of  $3^2 + 4^2$

**LINE**

$\boxed{3} \boxed{x^2} \boxed{+} \boxed{4} \boxed{x^2} \boxed{=}$

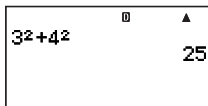

$\boxed{\sqrt{\quad}} \boxed{=}$

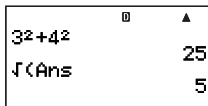

### Note

- As in the above examples, the calculator automatically inserts Ans as the argument of any calculation operator or scientific function you input while a calculation result is on the display.
- In the case of a function with a parenthetical argument (page 15), Ans automatically becomes the argument only in the case that you input the function alone and then press  $\boxed{=}$ . Note, however, that with natural display Ans may not become the argument automatically when using a function with a parenthetical argument.
- Basically, Ans is inserted automatically only when the result of the previous calculation is still on the display, immediately after you executed the calculation that produced it. If you want to insert Ans after clearing the display by pressing  $\boxed{AC/ON}$ , press  $\boxed{\text{SHIFT}} \boxed{(-)}$  (Ans).

## Inserting Ans into a Calculation Manually

You can insert Ans into a calculation at the current cursor location by pressing **SHIFT** **(←)** (Ans).

**Example 1:** To use the result of  $123 + 456$  in another calculation as shown below

$$123 + 456 = 579 \quad 789 - 579 = 210$$

**LINE**

**1** **2** **3** **+** **4** **5** **6** **EXE**

123+456	0	▲
		579

**7** **8** **9** **-** **SHIFT** **(←)** (Ans) **EXE**

123+456	0	▲
789- <b>Ans</b>		579
		210

**Example 2:** To determine the square root of  $3^2 + 4^2$  and then add 5 to the result

**LINE**

**3** **x<sup>2</sup>** **+** **4** **x<sup>2</sup>** **EXE**

3 <sup>2</sup> +4 <sup>2</sup>	0	▲
		25

**√** **SHIFT** **(←)** (Ans) **)** **+** **5** **EXE**

3 <sup>2</sup> +4 <sup>2</sup>	0	▲
√( <b>Ans</b> )+5		25
		10

## Using Independent Memory

Independent memory (M) is used mainly for calculating cumulative totals.

### Adding to Independent Memory

While a value you input or the result of a calculation is on the display, press **MEM+** to add it to independent memory (M).

**Example:** To add the result of  $105 \div 3$  to independent memory (M)

**LINE**

**1** **0** **5** **÷** **3** **MEM+**

105÷3M+	0	▲
		35

### Subtracting from Independent Memory

While a value you input or the result of a calculation is on the display, press **SHIFT** **MEM+** (M-) to subtract it from independent memory (M).

**Example:** To subtract the result of  $3 \times 2$  from independent memory (M)

**LINE**

**3** **X** **2** **SHIFT** **M+** (M-)

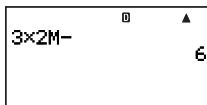

## Note

Pressing **M+** or **SHIFT** **M+** (M-) while a calculation result is on the display will add it to or subtract it from independent memory.

## Important!

The value that appears on the display when you press **M+** or **SHIFT** **M+** (M-) at the end of a calculation in place of **EXE** is the result of the calculation (which is added to or subtracted from independent memory). It is not the current contents of independent memory.

## Viewing Independent Memory Contents

Press **RCL** **9** (M).

## Clearing Independent Memory Contents (to 0)

**0** **SHIFT** **RCL** (STO) **9** (M)

## Calculation Example Using Independent Memory

Press **0** **SHIFT** **RCL** (STO) **9** (M) to clear independent memory contents before performing the following operation.

**Example:**  $23 + 9 = 32$

$53 - 6 = 47$

-)  $45 \times 2 = 90$

$99 \div 3 = 33$

-----  
(Total) 22

**2** **3** **+** **9** **M+**

**5** **3** **-** **6** **M+**

**4** **5** **X** **2** **SHIFT** **M+** (M-)

**9** **9** **÷** **3** **M+**

**RCL** **9** (M)

(Recalls value of M.)

## Using Variables

Your calculator supports the use of 26 variables, named A through Z.

## Assigning a Value or Calculation Result to a Variable

Use the procedure shown below to assign a value or a calculation expression to a variable.

**Example:** To assign  $3 + 5$  to variable A

**3** **+** **5** **SHIFT** **RCL** (STO) **i** (A)

## Viewing the Value Assigned to a Variable

To view the value assigned to a variable, press **RCL** and then specify the variable name. You could also press **ALPHA**, specify the variable name, and then press **EXE**.

**Example:** To view the value assigned to variable A

**RCL** **i** (A) or **ALPHA** **i** (A) **EXE**

## ❖ Using a Variable in a Calculation

You can use variables in calculations the same way you use values.

**Example:** To calculate  $5 + A$

**[5] [+]** **[ALPHA]** **[i]** **(A)** **[EXE]**

## ❖ Clearing the Value Assigned to a Variable (to 0)

**Example:** To clear variable A

**[0]** **[SHIFT]** **[RCL]** **(STO)** **[i]** **(A)**

## ❖ Clearing All Variables (to 0)

Use the MEMORY Mode screen to clear the contents of all the variables. See “Memory Manager (MEMORY)” on page 126 for more information.

## ■ Clearing All Memory Contents

Perform the operation below when you want to clear all variables (including variable M) and Answer Memory (Ans) to zero.

**[FUNCTION]** – **{CLR}** – **{Memory}** **[EXE]**

# Reserving Variable Memory

If you find that the calculator's default variables (A through Z) are not enough for your purposes, you can reserve variable memory and create “extra variables” for storage of value.

Extra variables work like array variables of an array named “Z” when assigning or recalling their values. An extra variable name consists of the letter “Z” followed by a value in brackets, like Z[5].

## ■ User Memory Area

Your calculator has a 28500-byte user memory area that you can use to reserve variable memory and add extra variables.

### Important!

- You can perform the procedure to reserve variable memory in the COMP Mode or in a COMP Mode program. All of the sample operations in this section are performed in the COMP Mode (**[MODE]** **[1]**).
- The 28500-byte user memory is used for storage of extra variables and programs. This means that increasing the number of extra variables reduces the amount of memory available for storing programs. So also, storing programs in memory reduces the amount of memory available for storing extra variables.

## ❖ Adding Extra Variables

**Example:** To increase the number of variables by 10

**LINE**

**1** **0** **FUNCTION** - {PROG} - {→} **SHIFT** **◻** (Dim Z) **EXE**

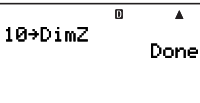

- When “Done” appears on the display, it means that the number of extra variables you specified has been added. At this point, zero is assigned to all of the extra variables.

(To check the value of Z[10])

**ALPHA** **In** **( )** **1** **0** **ALPHA** **x<sup>10</sup>** **( Z )**  
**AC/ON** **ALPHA** **x<sup>10</sup>** **( Z )**  
**ALPHA** **x<sup>n</sup>** **( )** **EXE**

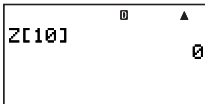

### Note

Reserving variable memory uses up a basic 26 bytes, plus 12 bytes for each of the extra variables that you add. Note that storing a complex number of an extra variable uses up 22 bytes. Adding 10 extra variables as shown above, for example, uses up  $26 + (12 \times 10) = 146$  bytes of the user memory area. Since user memory has a total capacity of 28500 bytes, the limit on the number of extra variables you can add is 2372 (assuming you do not have any complex numbers assigned to the extra variables).

## ■ Using Extra Variables

After creating extra variables, you can assign values to them and insert them into calculations just as you do with the default variables (from A through Z). Just remember that extra variable names consist of the letter “Z” followed by a value in brackets, like Z[5].

### Note

- The closing bracket ( ) of the extra variable name can be omitted.
- In place of a value inside the brackets of an extra variable name, you can use a calculation expression or a default array name (A to Z).
- Note that the value in the brackets of an extra variable name must be in the range of 1 and the number of extra variables that have been added. Trying to use a value that exceeds the number of extra variables will cause an error.

## ❖ Assigning a Value or Calculation Result to an Extra Variable

You can assign a value to an extra variable using the following command syntax: {value or expression} → Z[{extra variable value}] **EXE**.

**Example:** To assign  $3 + 5$  to variable Z[5]

**LINE**

**3** **+** **5** **FUNCTION** - {PROG} - {→} **ALPHA** **x<sup>10</sup>** **( Z )** **ALPHA** **In** **( )** **5** **ALPHA** **x<sup>n</sup>** **( )** **EXE**

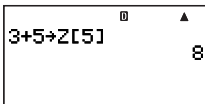

## Important!

You can write data to extra variables in the COMP Mode or in a COMP Mode program.

## ▣ Recalling the Contents of an Extra Variable

Input the name ( $Z[n]$ ) of the extra variable whose contents you want to recall, and then press **EXE**.

**Example:** To recall the contents of extra variable  $Z[5]$

**LINE**

**ALPHA** **x10<sup>0</sup>** **(Z)** **ALPHA** **In** **(I)** **5** **ALPHA** **x<sup>0</sup>** **(I)** **EXE**

Z[5]	0	▲
		8

## ▣ Using an Extra Variable in a Calculation

You can use extra variables in calculations the same way you use values.

**Example:** To calculate  $5 + Z[5]$

**LINE**

**5** **+** **ALPHA** **x10<sup>0</sup>** **(Z)** **ALPHA** **In** **(I)** **5** **ALPHA** **x<sup>0</sup>** **(I)** **EXE**

5+Z[5]	0	▲
		13

## ▣ Clearing Extra Variable Contents (to 0)

**Example:** To clear extra variable  $Z[5]$

**0** **FUNCTION** **-** **{PROG}** **-** **{→}** **ALPHA** **x10<sup>0</sup>** **(Z)** **ALPHA** **In** **(I)** **5** **ALPHA** **x<sup>0</sup>** **(I)** **EXE**

## ▣ Clearing All Extra Variables

Perform the operation below when you want delete all extra variables that are currently in calculator memory.

**0** **FUNCTION** **-** **{PROG}** **-** **{→}** **SHIFT** **▢** **(Dim Z)** **EXE**

### Note

You can also use the MEMORY Mode screen to delete all the extra variables. See “Memory Manager (MEMORY)” on page 126 for more information.

# Using $\pi$ and Scientific Constants

## ■ Pi ( $\pi$ )

Your calculator supports input of pi ( $\pi$ ) into calculations. Pi ( $\pi$ ) is supported in all modes, except for the BASE-N Mode. The following is the value that the calculator uses for  $\pi$ .

$\pi = 3.14159265358980$  (**SHIFT** **x10<sup>0</sup>** ( $\pi$ ))

## Scientific Constants

Your calculator has 40 often-used scientific constants built in. Like  $\pi$ , each scientific constant has a unique display symbol. Scientific constants are supported in all modes, except for the BASE-N Mode.

### Inputting a Scientific Constant

1. Press **FUNCTION** to display the function menu.
2. On the menu, select "CONST".
  - This displays page 1 of the scientific constant menu.

1: mP	2: mH
3: mE	4: mA
5: aO	6: h
7: $\mu$ H	8: $\mu$ E

- There are five scientific command menu screens, and you can use  $\blacktriangledown$  and  $\blacktriangle$  to navigate between them. For more information about scientific constants, see "List of Scientific Constants" on page 39.
3. Use  $\blacktriangledown$  and  $\blacktriangle$  to scroll through the pages and display the one that contains the scientific constant you want.
4. Press the number key (from **1** to **8**) that corresponds to the scientific constant you want to select.
  - This will input the scientific constant symbol that corresponds to the number key you press.

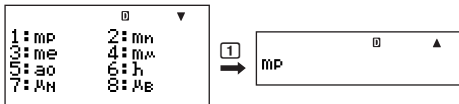

- Pressing **EXE** here will display the value of the scientific constant whose symbol is currently on the screen.

mP
1.67262171 $\times 10^{27}$

### Example Calculations Using Scientific Constants

**Example:** To calculate the constant for the speed of light in a vacuum ( $c_0 = 1/\sqrt{\epsilon_0\mu_0}$ )

**LINE**

**1**  $\div$   $\sqrt{()$

**1**  $\div$   $\sqrt{()$

**FUNCTION** - {CONST}  $\blacktriangledown$   $\blacktriangledown$   $\blacktriangledown$  **8** ( $\epsilon_0$ )

**1**  $\div$   $\sqrt{(\epsilon_0)}$

FUNCTION – {CONST} [▼] [▼] [▼] [▼] [1] ( $\mu_0$ ) [ ]

1 ÷ √(ε₀μ₀) |

1 ÷ √(ε₀μ₀)  
299792458

## ❑ List of Scientific Constants

The numbers in the “No.” column show the scientific constant menu page number on the left and the number key you need to press to select the constant when the proper menu page is displayed.

No.	Scientific Constant	No.	Scientific Constant
1-1	Proton mass	3-5	Muon magnetic moment
1-2	Neutron mass	3-6	Faraday constant
1-3	Electron mass	3-7	Elementary charge
1-4	Muon mass	3-8	Avogadro constant
1-5	Bohr radius	4-1	Boltzmann constant
1-6	Planck constant	4-2	Molar volume of ideal gas
1-7	Nuclear magneton	4-3	Molar gas constant
1-8	Bohr magneton	4-4	Speed of light in vacuum
2-1	Planck constant, rationalized	4-5	First radiation constant
2-2	Fine-structure constant	4-6	Second radiation constant
2-3	Classical electron radius	4-7	Stefan-Boltzmann constant
2-4	Compton wavelength	4-8	Electric constant
2-5	Proton gyromagnetic ratio	5-1	Magnetic constant
2-6	Proton Compton wavelength	5-2	Magnetic flux quantum
2-7	Neutron Compton wavelength	5-3	Standard acceleration of gravity
2-8	Rydberg constant	5-4	Conductance quantum
3-1	Atomic mass constant	5-5	Characteristic impedance of vacuum
3-2	Proton magnetic moment	5-6	Celsius temperature
3-3	Electron magnetic moment	5-7	Newtonian constant of gravitation
3-4	Neutron magnetic moment	5-8	Standard atmosphere

- The values are based on CODATA Recommended Values (2000). For details, see <#01> in the separate Supplement.



# Scientific Function Calculations

Unless otherwise noted, the functions in this section can be used in any of the calculator's calculation modes, except for the BASE-N Mode.

## Scientific Function Calculation Precautions

- When performing a calculation that includes a built-in scientific function, it may take some time before the calculation result appears. Do not perform any key operation on the calculator until the calculation result appears.
- To interrupt an on-going calculation operation, press  $\boxed{\text{AC/ON}}$ .

## Interpreting Scientific Function Syntax

- Text that represents a function's argument is enclosed in braces ( { } ). Arguments are normally {value} or {expression}.
- When braces ( { } ) are enclosed within parentheses, it means that input of everything inside the parentheses is mandatory.

## ■ Trigonometric and Inverse Trigonometric Functions

$\sin(, \cos(, \tan(, \sin^{-1}(, \cos^{-1}(, \tan^{-1}($

### ▣ Syntax and Input

$\sin(\{n\})$  (Other functions may be used in argument.)

**Example:**  $\sin 30 = 0.5$ ,  $\sin^{-1}0.5 = 30$

**LINE Deg**

$\boxed{\sin} \boxed{3} \boxed{0} \boxed{)} \boxed{\text{EXE}}$

$\sin(30)$  0.5

$\boxed{\text{SHIFT}} \boxed{\sin} (\sin^{-1}) \boxed{0} \boxed{.} \boxed{5} \boxed{)} \boxed{\text{EXE}}$

$\sin^{-1}(0.5)$  30

### ▣ Remarks

The angle unit you need to use in a calculation is the one that is currently selected as the default angle unit.

## Angle Unit Conversion

You can convert a value that was input using one angle unit to another angle unit. After you input a value, select **FUNCTION** – {ANGLE} to display the menu screen shown below.

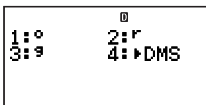

- 1 (°): Degrees
- 2 (r): Radians
- 3 (g): Grads

**Example:** To convert  $\frac{\pi}{2}$  radians to degrees

**LINE** **Deg**

**FUNCTION** – {ANGLE} 2 (r) **EXE**

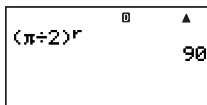

## Hyperbolic and Inverse Hyperbolic Functions

sinh(, cosh(, tanh(, sinh<sup>-1</sup>(, cosh<sup>-1</sup>(, tanh<sup>-1</sup>(

### Syntax and Input

sinh({n}) (Other functions may be used in argument.)

**Example:** sinh 1 = 1.175201194

**LINE**

**FUNCTION** – {MATH} (sinh) 1 **EXE**

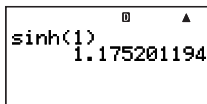

### Remarks

To input a hyperbolic or inverse hyperbolic function, perform the following operation to display a menu of functions: **FUNCTION** – {MATH} (sinh) (sinh).

## Exponential and Logarithmic Functions

10<sup>^</sup>(, e<sup>^</sup>(, log(, ln(

### Syntax and Input

10 <sup>^</sup> ({n})	10 <sup>{n}</sup>	(Same as e <sup>^</sup> (
log({n})	log <sub>10</sub> {n}	(Common Logarithm)
log({m},{n})	log <sub>{m}</sub> {n}	(Base {m} Logarithm)
ln({n})	log <sub>e</sub> {n}	(Natural Logarithm)

**Example 1:**  $\log_2 16 = 4$ ,  $\log 16 = 1.204119983$

**LINE**

$\log$   $2$   $\rightarrow$   $1$   $6$   $\rightarrow$   $\text{EXE}$

$\log(2,16)$   
4

$\log$   $1$   $6$   $\rightarrow$   $\text{EXE}$

$\log(16)$   
1.204119983

Base 10 (common logarithm) is assumed when no base is specified.

**MATH**

$\text{FUNCTION}$   $\rightarrow$   $\{\text{MATH}\}$   $\rightarrow$   $7$  (logab)  
 $2$   $\rightarrow$   $1$   $6$   $\rightarrow$   $\text{EXE}$

$\log_2(16)$   
4

**Example 2:**  $\ln 90$  ( $= \log_e 90$ ) = 4.49980967

**LINE**

$\ln$   $9$   $0$   $\rightarrow$   $\text{EXE}$

$\ln(90)$   
4.49980967

## Power Functions and Power Root Functions

$$x^2, x^{-1}, \wedge, \sqrt{\quad}, \sqrt[3]{\quad}, x\sqrt{\quad}$$

### Syntax and Input

$\{n\} x^2$ .....	$\{n\}^2$	(Square)
$\{n\} x^{-1}$ .....	$\{n\}^{-1}$	(Reciprocal)
$\{(m)\} \wedge \{(n)\}$ .....	$\{m\}^{\{n\}}$	(Power)
$\sqrt{\quad} \{(n)\}$ .....	$\sqrt{\{n\}}$	(Square Root)
$\sqrt[3]{\quad} \{(n)\}$ .....	$\sqrt[3]{\{n\}}$	(Cube Root)
$\{(m)\} x \sqrt{\quad} \{(n)\}$ .....	$\{(m)\} \sqrt{\{n\}}$	(Power Root)

**Example 1:**  $(\sqrt{2} + 1)(\sqrt{2} - 1) = 1$ ,  $(1 + 1)^{2+2} = 16$

**LINE**

$($   $\sqrt{\quad}$   $2$   $\rightarrow$   $+$   $1$   $\rightarrow$   $)$   
 $($   $\sqrt{\quad}$   $2$   $\rightarrow$   $-$   $1$   $\rightarrow$   $)$   $\text{EXE}$

$(\sqrt{(2)+1})(\sqrt{(2)-1})$   
1

( 1 + 1 ) x^2 + 2 ) EXE

$$(1+1)^{(2+2)} = 16$$

### MATH

( √ 2 ) + 1 )  
( √ 2 ) - 1 ) EXE

$$(\sqrt{2}+1)(\sqrt{2}-1) = 1$$

( 1 + 1 ) x^2 + 2 ) EXE

$$(1+1)^{2+2} = 16$$

**Example 2:**  $(-2)^{\frac{2}{3}} = 1.587401052$

### LINE

( (-) 2 ) x^ ( 2 ) ( 3 ) ) EXE

$$(-2)^{(2/3)} = 1.587401052$$

## Integration Calculation

Your calculator performs integration using Gauss-Kronrod integration for approximation. The calculator uses the following function for integration.

$$\int f(x)$$

### Syntax and Input

$\int (f(x), a, b, tol)$

$f(x)$ : Function of  $x$  (Input the function used by variable X.)

- All variables other than X are viewed as constants.

$a$ : Lower limit of region of integration

$b$ : Upper limit of region of integration

$tol$ : Error tolerance range (Can be input only when linear display is being used.)

- This parameter can be omitted. In that case, a tolerance of  $1 \times 10^{-5}$  is used.

**Example:**  $\int (\ln(x), 1, e) = 1$  ( $tol$  value not input)

### MATH

FUNCTION - {MATH} 1 (∫dX)  
ln ALPHA 0 (X) ) ( 1 ) ( e^ ) 1 ) EXE

$$\int_1^e \ln(x) dx = 1$$

FUNCTION — {MATH} 1 (∫dx)  
 ln ALPHA 0 (X) ) , \* 1 \* SHIFT ln (e^x) 1 ) ) ) EXE

$\int(\ln(x), 1, e^{(1)})$   
 1

## Remarks

- Use of  $\int$  is supported in the COMP, SD, REG, and EQN Modes only.
- The following functions cannot be input for the  $f(x)$ ,  $a$ ,  $b$ , and  $tol$  parameters:  $\int$ ,  $d/dx$ ,  $d^2/dx^2$ ,  $\Sigma$ . In addition, the Pol( and Rec( functions, and the random number functions cannot be input for the  $f(x)$  parameter.
- The integration result will be negative when the limit of region of integration parameters are within the range  $a \leq x \leq b$  and  $f(x) < 0$ .  
 Example:  $\int(0.5x^2 - 2, -2, 2) = -5.333333333$
- In the case of integration of a trigonometric function, select Rad for the angle unit.
- Integration calculations can take a long time to complete.
- Specifying a smaller value for the  $tol$  parameter tends to improve precision, but it also causes the calculation to take more time. Specify a  $tol$  value greater than  $1 \times 10^{-14}$ .
- You will not be able to input a  $tol$  value while using natural display.
- The type of function being integrated, positive and negative values within the region of integration, and the region of integration being used can cause large error in integration values and errors.
- You can interrupt an ongoing integration calculation operation by pressing  $\square$ .

## Tips to for Successful Integration Calculations

- For periodic functions, and for positive and negative  $f(x)$  values due to the region of integration being used
  - Divide the integration into parts for each period, or between positive and negative parts, obtain integration values for each, and then add the values.

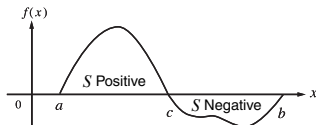

$$\int_a^b f(x)dx = \int_a^c f(x)dx + \left(-\int_c^b f(x)dx\right)$$

└──────────┘ └──────────┘  
 Positive Part      Negative Part  
 (S Positive)      (S Negative)

- For widely fluctuating integration values due to a minutely shifting region of integration
  - Divide the integration interval into multiple parts (in a way that breaks areas of wide fluctuation into small parts), perform integration on each part, and then combine the results.

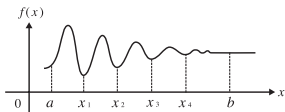

$$\int_a^b f(x)dx = \int_a^{x_1} f(x)dx + \int_{x_1}^{x_2} f(x)dx + \dots + \int_{x_4}^b f(x)dx$$

## Derivative

Your calculator performs differential calculations by approximating the derivative based on centered difference approximation. Calculation is performed using the function shown below.

$$d/dx($$

## Syntax and Input

$d/dx(f(x), a, tol)$

$f(x)$ : Function of  $x$  (Input the function used by variable X.)

- All variables other than X are viewed as constants.

$a$ : Value of point (derivative point) of desired derivative coefficient

$tol$ : Error tolerance range (Can be input only when linear display is being used.)

- This parameter can be omitted. In that case, a tolerance of  $1 \times 10^{-10}$  is used.

**Example:** To obtain the differential coefficient at point  $x = \frac{\pi}{2}$  for the function  $y = \sin(x)$   
( $tol$  value not input)

**Rad**     $\text{FUNCTION} - \{\text{MATH}\} \text{2} (\text{d/dX}) \text{sin} \text{ALPHA} \text{0} (\text{X}) \text{)} \dots \text{1}$

**MATH**

(Continuing from ①, above)

$\text{▶} \text{☐} \text{SHIFT} \text{x10}^{-1} (\pi) \text{▼} \text{2} \text{EXE}$

**LINE**

(Continuing from ①, above)

$\text{▶} \text{SHIFT} \text{x10}^{-1} (\pi) \text{☐} \text{2} \text{) EXE}$

## Remarks

- Use of  $d/dx($  is supported in the COMP, SD, REG, and EQN Modes only.
- The following functions cannot be input for the  $f(x)$ ,  $a$ , and  $tol$  parameters:  $\int($ ,  $d/dx($ ,  $d^2/dx^2($ ,  $\Sigma($ . In addition, the Pol( and Rec( functions, and the random number functions cannot be input for the  $f(x)$  parameter.
- In the case of differentiation of a trigonometric function, select Rad for the angle unit.
- Specifying a smaller value for the  $tol$  parameter tends to improve precision, but it also causes the calculation to take more time. Specify a  $tol$  value greater than  $1 \times 10^{-14}$ .
- You will not be able to input a  $tol$  value while using natural display.
- Non-consecutive points, abrupt fluctuation, extremely large or small points, inflection points, and the inclusion of points that cannot be differentiated, or a differential point or

- differential calculation result that approaches zero can cause poor precision or error.
- You can interrupt an ongoing differential calculation operation by pressing  $\boxed{\text{AC/ON}}$ .

## ■ Second Derivative

Your calculator lets you calculate the second derivative coefficient ( $d^2/dx^2(f(x))|_{x=a}$ ) for  $f(x)$  where  $x = a$ . Your calculator uses approximation based on the second order value differential equation of the Newton interpolation polynomial. Calculation is performed using the function shown below.

$$d^2/dx^2($$

### ◀ Syntax and Input

$$d^2/dx^2(f(x), a, tol)$$

$f(x)$ : Function of  $x$  (Input the function used by variable X.)

- All variables other than X are viewed as constants.

$a$ : Value of point (second derivative point) of desired second derivative coefficient

$tol$ : Error tolerance range (Can be input only when linear display is being used.)

- This parameter can be omitted. In that case, a tolerance of  $1 \times 10^{-10}$  is used.

**Example 1:** To obtain the second derivative coefficient for the function  $y = x^3 + 4x^2 + x - 6$  when  $x = 3$

#### MATH

$$\boxed{\text{FUNCTION}} \rightarrow \boxed{\text{MATH}} \rightarrow \boxed{3} \rightarrow \boxed{d^2/dX^2} \rightarrow \boxed{\text{ALPHA}} \rightarrow \boxed{0} \rightarrow \boxed{(X)} \rightarrow \boxed{x^3} \rightarrow \boxed{+} \rightarrow \boxed{\text{ALPHA}} \rightarrow \boxed{0} \rightarrow \boxed{(X)} \rightarrow \boxed{-} \rightarrow \boxed{6} \rightarrow \boxed{\text{▶}} \rightarrow \boxed{3} \rightarrow \boxed{\text{EXE}}$$

$$\frac{d^2}{dx^2}(x^3+4x^2+x-6.)$$

26

**Example 2:** To perform the same procedure as Example 1, specifying  $tol = 1 \times 10^{-12}$

Since you want to specify a value for  $tol$ , you will need to perform this calculation using linear display.

#### LINE

$$\boxed{\text{FUNCTION}} \rightarrow \boxed{\text{MATH}} \rightarrow \boxed{3} \rightarrow \boxed{d^2/dX^2} \rightarrow \boxed{\text{ALPHA}} \rightarrow \boxed{0} \rightarrow \boxed{(X)} \rightarrow \boxed{x^3} \rightarrow \boxed{+} \rightarrow \boxed{4} \rightarrow \boxed{\text{ALPHA}} \rightarrow \boxed{0} \rightarrow \boxed{(X)} \rightarrow \boxed{x^2} \rightarrow \boxed{+} \rightarrow \boxed{\text{ALPHA}} \rightarrow \boxed{0} \rightarrow \boxed{(X)} \rightarrow \boxed{-} \rightarrow \boxed{6} \rightarrow \boxed{\text{▶}} \rightarrow \boxed{3} \rightarrow \boxed{\text{▶}} \rightarrow \boxed{1} \rightarrow \boxed{\times 10^{\square}} \rightarrow \boxed{-} \rightarrow \boxed{12} \rightarrow \boxed{\text{EXE}}$$

$$\frac{d^2}{dx^2}(x^3+4x^2+x-6, 3, 1 \times 10^{-12})$$

26

### ◀ Remarks

See the remarks for derivative on page 45.

## ■ $\Sigma$ Calculation

This function determines the sum of an input  $f(x)$  for a specified range. Calculation is performed using the function shown below.

$$\Sigma($$

The following shows the calculation formula used for  $\Sigma$  calculations.

$$\Sigma(f(x), x, a, b) = f(a) + f(a+1) + \dots + f(b)$$

## ❖ Syntax and Input

$$\Sigma(f(x), x, a, b)$$

$f(x)$ : Function of  $x$  (parameter variable specified below)

$x$ : Parameter variable (Any letter from A through Z)

- If the variable name you specify here does not match the variable name used within the function of  $x$ , the variable in the function will be treated as a constant.

$a$ : Start point of calculation range

$b$ : End point of calculation range

- $a$  and  $b$  are integers in the range of  $-1 \times 10^{10} < a \leq b < 1 \times 10^{10}$ .
- The step for this calculation is fixed as 1.

**Example:**  $\Sigma(X + 1, X, 1, 5) = 20$

**MATH**

FUNCTION - {MATH} 4 (Σ) ALPHA 0 (X)  
 + 1 ALPHA 0 (X) 1 5 EXE

**LINE**

FUNCTION - {MATH} 4 (Σ) ALPHA 0 (X)  
 + 1 ALPHA 0 (X) 1 5 ) EXE

## ❖ Remarks

- Use of  $\Sigma$  is supported in the COMP, SD, REG, and EQN Modes only.
- The following functions cannot be input for the  $f(x)$ ,  $a$ , and  $b$  parameters:  $\int$ ,  $d/dx$ ,  $d^2/dx^2$ ,  $\Sigma$ . In addition, the Pol( and Rec( functions, and the random number functions cannot be input for the  $f(x)$  parameter.
- You can interrupt an ongoing  $\Sigma$  calculation operation by pressing  $\boxed{\text{AC/ON}}$ .

## ■ Coordinate Conversion (Rectangular $\leftrightarrow$ Polar)

Pol(, Rec(

Your calculator can convert between rectangular coordinates and polar coordinates.

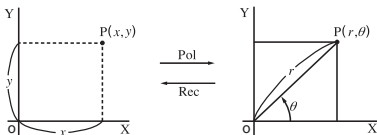

Rectangular Coordinates (Rec)

Polar Coordinates (Pol)



## ◆ Syntax and Input

### Rectangular-to-Polar Coordinate Conversion (Pol)

Pol( $x, y$ )

$x$ : Rectangular coordinate  $x$ -value

$y$ : Rectangular coordinate  $y$ -value

### Polar-to-Rectangular Coordinate Conversion (Rec)

Rec( $r, \theta$ )

$r$ : Polar coordinate  $r$ -value

$\theta$ : Polar coordinate  $\theta$ -value

**Example 1:** To convert the rectangular coordinates  $(\sqrt{2}, \sqrt{2})$  to polar coordinates

**LINE Deg**

SHIFT + (Pol) √ 2 )  
◀ √ 2 ) ) EXE

Pol(√(2),√(2))  
r= 2  
θ= 45

**MATH Deg**

SHIFT + (Pol) √ 2 )  
◀ √ 2 ) ▶ EXE

Pol(√2,√2)  
r=2, θ=45

**Example 2:** To convert the polar coordinates  $(2, 30^\circ)$  to rectangular coordinates

**LINE Deg**

SHIFT - (Rec) 2 )  
3 0 ) EXE

Rec(2,30)  
X= 1.732050808  
Y= 1

## ◆ Remarks

- These functions can be used in the COMP Mode.
- The  $r$ -value or  $x$ -value produced by the calculation is assigned to variable I, while the  $\theta$ -value or  $y$ -value is assigned to variable J (page 34).
- The values obtained for  $\theta$  when converting from rectangular coordinates to polar coordinates is within the range  $-180^\circ < \theta \leq 180^\circ$ .
- When executing a coordinate conversion function inside of a calculation expression, the calculation is performed using the first coordinate that the conversion produces ( $r$ -value or  $x$ -value).

Example: Pol  $(\sqrt{2}, \sqrt{2}) + 5 = 2 + 5 = 7$

## Random Number Functions

Your calculator comes with functions for generating ten-digit non-sequential random numbers, ten-digit sequential random numbers, or random integers within a specific range. The following are the random number generation functions.

Ran#, RanInt#(

### Non-sequential Random Numbers (Decimal Values)

The following generates ten-digit non-sequential fractional numbers in the range of 0 to 1.

Syntax: Ran#

**Example:** To generate ten-digit non-sequential random numbers

**MATH**

**FUNCTION** - {MATH} **6** (Ran#) **EXE**

Ran#

0.6196899081

Ran#

0.7042860201

Ran#

0.9671390699

The above values are provided for example only. The actual values produced by your calculator for this function will be different.

### Sequential Random Numbers (Decimal Values)

In this case, ten-digit sequential random numbers are generated in the range of 0 to 1 in accordance with nine sequences numbered from 1 through 9. The sequence is specified by the integer argument (1 through 9) of Ran#. The random numbers generated in accordance with the argument are generated in a fixed sequence.

Syntax: Ran#{*n*} (*n* is an integer from 1 to 9.)

**Example:** To generate sequential random numbers

**MATH**

Initialize the sequence:

**FUNCTION** - {MATH} **6** (Ran#) **0** **EXE**

Ran# 0

0

FUNCTION - {MATH} 6 (Ran#) 1 EXE

Ran# 1

0.1450073626

EXE

Ran# 1

0.1387437776

EXE

Ran# 1

0.866670424

## Random Integers

This function generates random integers within a specific range.

Syntax:  $\text{RanInt}\#(\{m\}, \{n\})$  ( $m$  and  $n$  are integers.  $m < n$ ;  $|m|, |n| < 1E10$ ;  $n - m < 1E10$ )

**Example:** To generate random integers in the range of 0 to 5

**MATH**

FUNCTION - {MATH} 8 (RanInt) 0 5 EXE

RanInt#(0,5)

2

EXE

RanInt#(0,5)

4

EXE

RanInt#(0,5)

0

The above values are provided for example only. The actual values produced by your calculator for this function will be different.

## Other Functions

$x!$ , Abs(,  $nPr$ ,  $nCr$ , Rnd(, Int(, Frac(, Intg(

## ❖ Factorial (!)

Syntax:  $\{n\}!$  ( $\{n\}$  must be a natural number or 0.)

**Example:**  $(5 + 3)!$

**LINE**

$\boxed{C}$   $\boxed{5}$   $\boxed{+}$   $\boxed{3}$   $\boxed{)}$   
FUNCTION - {MATH}  $\boxed{5}$  (X!) EXE

(5+3)!  
40320

## ❖ Absolute Value (Abs)

Syntax: Abs( $\{n\}$ )

**Example:**  $\text{Abs}(2 - 7) = 5$

**MATH**

FUNCTION - {MATH}  $\blacktriangledown$   $\boxed{1}$  (Abs)  $\boxed{2}$   $\boxed{-}$   $\boxed{7}$  EXE

|2-7|  
5

**LINE**

FUNCTION - {MATH}  $\blacktriangledown$   $\boxed{1}$  (Abs)  $\boxed{2}$   $\boxed{-}$   $\boxed{7}$   $\boxed{)}$  EXE

Abs(2-7)  
5

## ❖ Permutation ( $nPr$ )/Combination ( $nCr$ )

Syntax:  $\{n\}P\{m\}$ ,  $\{n\}C\{m\}$

**Example:** How many four-person permutations and combinations are possible for a group of 10 people?

**LINE**

$\boxed{1}$   $\boxed{0}$  FUNCTION - {MATH}  $\boxed{7}$  ( $nPr$ )  $\boxed{4}$  EXE

$10P4$   
5040

$\boxed{1}$   $\boxed{0}$  FUNCTION - {MATH}  $\boxed{8}$  ( $nCr$ )  $\boxed{4}$  EXE

$10C4$   
210

## ❖ Rounding Function (Rnd)

You can use the rounding function (Rnd) to round the value, expression, or calculation result specified by the argument. Rounding is performed to the number of significant digits in accordance with the number of display digits setting.

## Display Digit Setting: Norm1 or Norm2

The mantissa is rounded off to 10 digits.

## Display Digit Setting: Fix or Sci

The value is rounded to the specified number of digits.

**Example:**  $200 \div 7 \times 14 = 400$

**LINE**

**2** **0** **0** **÷** **7** **×** **1** **4** **EXE**

200÷7×14	400
----------	-----

(3 decimal places)

**SHIFT** **MODE** (SETUP) **6** (Fix) **3** **EXE**

200÷7×14	400.000
----------	---------

(Internal calculation uses 15 digits.)

**2** **0** **0** **÷** **7** **EXE**

200÷7	28.5714285714
-------	---------------

**×** **1** **4** **EXE**

200÷7	28.571
Ans×14	400.000

Now perform the same calculation using the rounding (Rnd) function.

**AC/ON** **2** **0** **0** **÷** **7** **EXE**

200÷7	28.571
-------	--------

(Calculation uses rounded value.)

**SHIFT** **0** (Rnd) **EXE**

200÷7	28.571
Rnd(Ans)	28.571

(Rounded result)

**×** **1** **4** **EXE**

Rnd(Ans)	28.571
Ans×14	399.994

## Integer Part Extraction (Int)

The Int( function extracts the integer part of the real number input as its argument.

Syntax:  $\text{Int}(\{n\})$

**Example:** To extract the integer part of  $-1.5$

LINE

$\text{FUNCTION}$  - {MATH}  $\blacktriangledown$  2 (Int)  $\leftarrow$  1  $\cdot$  5  $\text{D}$   $\text{EXE}$

```
Int(-1.5)
-1
```

## ▣ Fractional Part Extraction (Frac)

The Frac( function extracts the fractional part of the real number input as its argument.

Syntax:  $\text{Frac}(\{n\})$

**Example:** To extract the fractional part of  $-1.5$

LINE

$\text{FUNCTION}$  - {MATH}  $\blacktriangledown$  3 (Frac)  $\leftarrow$  1  $\cdot$  5  $\text{D}$   $\text{EXE}$

```
Frac(-1.5)
-0.5
```

## ▣ Largest Integer (Intg)

The Intg( function determines the largest integer that does not exceed the real number input as its argument.

Syntax:  $\text{Intg}(\{n\})$

**Example:** To determine the largest integer that does not exceed  $-1.5$

LINE

$\text{FUNCTION}$  - {MATH}  $\blacktriangledown$  4 (Intg)  $\leftarrow$  1  $\cdot$  5  $\text{D}$   $\text{EXE}$

```
Intg(-1.5)
-2
```

# Using Engineering Notation

## ■ Using $10^3$ Engineering Notation (ENG)

Engineering notation (ENG) expresses quantities as a product of a positive number between 1 and 10 and a power of 10 that is always a multiple of three. There are two functions that you can use to convert a number to engineering notation,  $\text{ENG}\rightarrow$  and  $\text{ENG}\leftarrow$ .

Function	Key Operation
$\text{ENG}\rightarrow$	$\text{SHIFT}$ $\text{E}^{\text{ENG}}$
$\text{ENG}\leftarrow$	$\text{SHIFT}$ $\text{E}^{\text{ENG}}$

## ENG Conversion Examples

**Example 1:** To convert 1234 to engineering notation using ENG→

**MATH**

The first screenshot shows the number 1234 on the display. Above the display, there is a small icon of a square with a circle inside and the text "Math ▲". Below the display, the number 1234 is repeated. To the left of the screen are four buttons labeled 1, 2, 3, and 4, followed by an EXE button.

The second screenshot shows the number 1234 on the display. Below the display, the number 1.234 is shown with a subscript 3. To the left of the screen are two buttons: SHIFT and a button with a square containing a circle and a horizontal line, followed by the text (ENG).

The third screenshot shows the number 1234 on the display. Below the display, the number 1234 is shown with a subscript 0. To the left of the screen are two buttons: SHIFT and a button with a square containing a circle and a horizontal line, followed by the text (ENG).

**Example 2:** To convert 123 to engineering notation using ENG←

**MATH**

The first screenshot shows the number 123 on the display. Above the display, there is a small icon of a square with a circle inside and the text "Math ▲". Below the display, the number 123 is repeated. To the left of the screen are four buttons labeled 1, 2, 3, and EXE.

The second screenshot shows the number 123 on the display. Below the display, the number 0.123 is shown with a subscript 3. To the left of the screen are two buttons: SHIFT and a button with a square containing a circle and a horizontal line, followed by the text (ENG).

The third screenshot shows the number 123 on the display. Below the display, the number 0.000123 is shown with a subscript 6. To the left of the screen are two buttons: SHIFT and a button with a square containing a circle and a horizontal line, followed by the text (ENG).

## Using Engineering Symbols

Your calculator supports the use of ten engineering symbols (m,  $\mu$ , n, p, f, k, M, G, T, P) that you can use for input of value or for calculation result display. You can use engineering symbols in calculations in all calculation modes, except for the BASE-N Mode.

### Displaying Calculation Results with Engineering Symbols

Use the calculator's setup screens to select "EngOn" for engineering symbols (page 13).

## Inputting Values Using Engineering Symbols

**Example:** To input 500 k

The sequence shows three calculator screens. The first screen shows the input '500' with a decimal point and an arrow. The second screen shows the 'FUNCTION' menu with 'MATH' selected, and a list of engineering symbols: 1:M, 2:k, 3:n, 4:P, 5:f, 6:k, 7:M, 8:G, 9:T, 0:F. The third screen shows the result '500k'.

## Using ENG (10<sup>3</sup>) Conversion while Engineering Symbols Turned on (EngOn)

Performing ENG conversion while "EngOn" is selected for engineering symbols (page 13) will move the decimal point three places to the right, and change the engineering symbol accordingly (from M to k, for example). Conversely, performing ←ENG conversion will move the decimal point three places to the left, and change the engineering symbol accordingly (from k to M, for example).

**Example:** To calculate 999 k (kilo) + 25 k (kilo) = 1.024 M (Mega) = 1024 (kilo)

**LINE**

The sequence shows three calculator screens. The first screen shows the input '999' followed by 'FUNCTION' and 'MATH', then '6 (k) +'. The second screen shows the result '999k+25k' and '1.024M'. The third screen shows the result '999k+25k' and '1024k' after pressing 'SHIFT' and 'ENG'.

(ENG conversion)

## Complex Number Calculations (COMP)

To perform the example operations in this section, first select COMP (MODE 1) as the calculation mode.

### Inputting Complex Numbers

#### Inputting Imaginary Numbers (*i*)

Use the **i** key to input imaginary number *i*.



**Example:** To input  $2 + 3i$

$2 + 3 i$

$2+3i$

## Inputting Complex Number Values Using Polar Coordinate Format

Complex numbers can also be input using polar coordinate format ( $r \angle \theta$ ).

**Example:** To input  $5 \angle 30$

$5 \angle 30$

$5\angle 30$

### Important!

When inputting argument  $\theta$ , enter a value that indicates an angle in accordance with the calculator's current default angle unit setting.

## Complex Number Display Setting

See "Specifying the Complex Number Display Format" (page 13).

## Complex Number Calculation Result Display Examples

### Rectangular Coordinate Format ( $a+bi$ )

$(\text{SHIFT}) (\text{MODE}) (\text{SETUP}) (4) (\text{COMPLX}) (1) (a+bi)$

**Example 1:**  $2 \times (\sqrt{3} + i) = 2\sqrt{3} + 2i = 3.464101615 + 2i$

**MATH Deg**

$2 \times (\sqrt{\phantom{x}}) 3 \text{ (right arrow)} + i \text{ (right arrow)} \text{ (EXE)}$

$2 \times (\sqrt{3} + i)$

$2\sqrt{3} + 2i$

**LINE**

$2 \times (\sqrt{\phantom{x}}) 3 \text{ (right arrow)} + i \text{ (right arrow)} \text{ (EXE)}$

$2 \times (\sqrt{(3)} + i)$

$3.464101615 + 2i$

When using linear display format, calculation results are displayed in two lines showing the real part and imaginary part.

**Example 2:**  $\sqrt{2} \angle 45 = 1 + i$

**MATH Deg**

$\sqrt{\phantom{x}} 2 \text{ (right arrow)} \text{ (SHIFT)} i (\angle) 45 \text{ (right arrow)} \text{ (EXE)}$

$\sqrt{2} \angle 45$

$1+i$

### Polar Coordinate Format ( $r \angle \theta$ )

$(\text{SHIFT}) (\text{MODE}) (\text{SETUP}) (4) (\text{COMPLX}) (2) (r \angle \theta)$

**Example 1:**  $2 \times (\sqrt{3} + i) = 2\sqrt{3} + 2i = 4 \angle 30$

**MATH Deg**

2  $\times$  (  $\sqrt{\square}$  ) 3  $\rightarrow$  +  $i$  )  $\rightarrow$  EXE

Math  $\blacktriangle$   
 $2 \times (\sqrt{3} + i)$   
 $4 \angle 30$

**LINE**

2  $\times$  (  $\sqrt{\square}$  ) 3 ) +  $i$  )  $\rightarrow$  EXE

Math  $\blacktriangle$   
 $2 \times (\sqrt{3} + i)$   
 $4$   
 $\angle 30$

When using linear display format, calculation results are displayed in two lines showing the absolute value and argument.

**Example 2:**  $1 + i = \sqrt{2} \angle 45$

**MATH Deg**

1 +  $i$  )  $\rightarrow$  EXE

Math  $\blacktriangle$   
 $1 + i$   
 $\sqrt{2} \angle 45$

## Conjugate Complex Number (Conjg)

You can perform the operation below to obtain conjugate complex number  $\bar{z} = a - bi$  for the complex number  $z = a + bi$ .

**Example:** Obtain the conjugate complex number of  $2 + 3i$

**MATH**

FUNCTION - {COMPLX} 3 (Conjg) 2 + 3  $i$  )  $\rightarrow$  EXE

Math  $\blacktriangle$   
 $\text{Conjg}(2+3i)$   
 $2-3i$

## Absolute Value and Argument (Abs, Arg)

You can use the procedure shown below to obtain the absolute value ( $|z|$ ) and argument ( $\text{Arg}(z)$ ) on the Gaussian plane for a complex number in the format  $z = a + bi$ .

**Example:** To obtain the absolute value and argument of  $2 + 2i$

**LINE Deg**

Imaginary axis

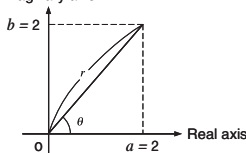

Absolute Value:

FUNCTION - {COMPLX} 1 (Abs) 2 + 2  $i$  )  $\rightarrow$  EXE

Math  $\blacktriangle$   
 $\text{Abs}(2+2i)$   
 $2.828427125$

Argument:

**FUNCTION** – {COMPLX} **2** (Arg) **2** **+** **2** **i** **)** **EXE**

Arg(2+2i) ▲  
45

## ■ Extracting the Real Part (ReP) and Imaginary Part (ImP) of a Complex Number

You can use the following operations to extract the real part ( $a$ ) or imaginary part ( $b$ ) of complex number  $a + bi$ .

**Example:** Obtain the real part and imaginary part of  $2 + 3i$

**MATH**

**FUNCTION** – {COMPLX} **4** (ReP) **2** **+** **3** **i** **)** **EXE**

ReP(2+3i) Math ▲  
2

**FUNCTION** – {COMPLX} **5** (ImP) **2** **+** **3** **i** **)** **EXE**

ImP(2+3i) Math ▲  
3

## ■ Overriding the Default Complex Number Display Format

You can use the procedures described below to override the default complex number display format and specify a particular display format for the calculation you are currently inputting.

### ◀ Specifying Rectangular Coordinate Format for a Calculation

Input **FUNCTION** – {COMPLX} **7** ( $\blacktriangleright a+bi$ ) at the end of the calculation.

**Example:**  $2\sqrt{2} \angle 45 = 2 + 2i$  (Angle Unit: Deg)

**MATH Deg**

**2** **√** **2** **▶** **SHIFT** **i** ( $\angle$ ) **4** **5**  
**FUNCTION** – {COMPLX} **7** ( $\blacktriangleright a+bi$ ) **EXE**

$2\sqrt{2} \angle 45 \blacktriangleright a+bi$  Math ▲  
 $2+2i$

### ◀ Specifying Polar Coordinate Format for a Calculation

Input **FUNCTION** – {COMPLX} **6** ( $\blacktriangleright r\angle\theta$ ) at the end of the calculation.

**Example:**  $2 + 2i = 2\sqrt{2} \angle 45$

**MATH Deg**

**2** **+** **2** **i** **FUNCTION** – {COMPLX} **6** ( $\blacktriangleright r\angle\theta$ ) **EXE**

$2+2i \blacktriangleright r\angle\theta$  Math ▲  
 $2\sqrt{2} \angle 45$

# Matrix Calculations (COMP)

To perform the example operations in this section, first select COMP (MODE 1) as the calculation mode.

## Matrix Calculation Overview

Matrix calculations are performed by first storing the matrices in one of six matrix memory areas named Mat A through Mat F, and then using the matrix area variables to perform the actual calculation. To perform a matrix calculation like  $\begin{bmatrix} 2 & 0 \\ 0 & 2 \end{bmatrix} + \begin{bmatrix} 1 & 2 \\ 3 & 4 \end{bmatrix}$ , for example, you would input  $\begin{bmatrix} 2 & 0 \\ 0 & 2 \end{bmatrix}$  into Mat A and  $\begin{bmatrix} 1 & 2 \\ 3 & 4 \end{bmatrix}$  into Mat B, when perform the calculation Mat A + Mat B. Matrix calculation results are displayed on a Mat Ans screen.

## About the Mat Ans Screen

Any calculation result that is a matrix is stored in Matrix Answer memory named "Mat Ans". You can use the Mat Ans screen to view the matrix that is currently stored in Mat Ans.

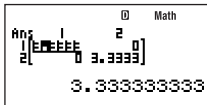

- Each of cells on the Mat Ans screen shows up to six digits of the value currently stored in the cell.
- To check the value stored in a cell, use the cursor keys to move the highlighting to the cell. This will cause the full value contained to appear in the value display area at the bottom of the screen.
- If a cell contains a fraction or sexagesimal value, the applicable cell on the Mat Ans screen will show the decimal format equivalent. When you move the highlighting to the cell, the value will appear in the applicable fraction or sexagesimal format in the value display area.
- Though the Mat Ans screen looks very similar to the matrix editor screen, you cannot edit a matrix on the Mat Ans screen.
- Pressing  $\square$  while the Mat Ans screen is on the display will switch to the calculation screen.
- You can press  $\oplus$ ,  $\ominus$ , or another operator key while the Mat Ans screen is on the display to start a calculation that uses the current Mat Ans contents (like "Mat Ans+"). This is similar to Answer Memory operations (page 32). For more information, see "Performing Matrix Calculations" (page 62).

## Inputting and Editing Matrix Data

You can input data for up to six matrices, named Mat A through Mat F, and then use the matrix names as variables in calculations. There are two methods you can use to input data into a matrix: using the matrix editor screen and using the value assignment command ( $\rightarrow$ ).

## Using the Matrix Editor Screen to Input Matrix Data

- Press  $\text{FUNCTION}$  – {MATRIX}  $\text{1}$  (EDIT) to display the matrix memory area menu.



- A memory area that already contains a matrix will show the dimensions of its matrix (like  $2 \times 2$ ), while an area that is empty will be indicated by "None".
- Use  $\blacktriangledown$  and  $\blacktriangle$  to move the highlighting to the matrix you want to use for data input.
  - Press  $\text{EXE}$ .
    - This displays a screen for specifying the dimensions of the matrix.  $m$  is the number of rows, while  $n$  is the number of columns.

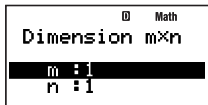

### Note

If you select a memory area that already contains a matrix in step 2, pressing  $\text{EXE}$  will display the matrix editor screen so you can edit the matrix. If you want to delete the existing matrix and make a new one with different dimensions, press  $\text{FUNCTION}$   $\text{1}$  (Dim) in place of  $\text{EXE}$  in step 3.

- Specify the dimensions of the matrix you want to create, up to a maximum of 10 rows and 10 columns.
  - To specify the number of rows, move the highlighting to  $m$ , input a value and then press  $\text{EXE}$ . This will cause the highlighting to move to  $n$ .
  - Input a value for  $n$  to specify the number of columns and then press  $\text{EXE}$ .
  - You can use  $\blacktriangledown$  and  $\blacktriangle$  to move the highlighting between  $m$  and  $n$ .
- After inputting the row and column values you want, press  $\text{EXE}$ .
  - This will display the matrix editor screen.

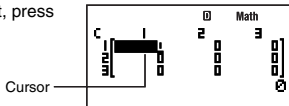

- On the matrix editor screen, input values into the cells of the matrix.
  - Use the cursor keys to move the cursor to the cell you want and then input a value. After inputting a value, press  $\text{EXE}$  to register it.
- After inputting all the values you want, press  $\text{EXIT}$ .

## Using the Value Assignment Command ( $\rightarrow$ ) to Input Matrix Data

- On the COMP Mode calculation screen, use the following syntax to input the matrix you want to input into matrix memory.

$$\begin{bmatrix} a_{11} & a_{12} & \dots & a_{1n} \\ a_{21} & a_{22} & \dots & a_{2n} \\ \vdots & \vdots & & \vdots \\ a_{m1} & a_{m2} & \dots & a_{mn} \end{bmatrix} \quad [[a_{11}, a_{12}, \dots, a_{1n}][a_{21}, a_{22}, \dots, a_{2n}] \dots [a_{m1}, a_{m2}, \dots, a_{mn}]]$$

- Inputting  $\begin{bmatrix} 1 & 2 \\ 3 & 4 \end{bmatrix}$ , for example, can be performed using the following key operation.



- Input the value assignment command ( $\rightarrow$ ).  
 $\boxed{\text{FUNCTION}} - \{\text{PROG}\} - \{\rightarrow\}$
- Specify the matrix memory (Mat A to Mat F or Mat Ans) where you want to store the matrix.
  - To store it in Mat A, for example, perform the following key operation:  $\boxed{\text{FUNCTION}} - \{\text{MATRIX}\} \boxed{2} (\text{Mat}) \boxed{\text{ALPHA}} \boxed{i} (\text{A})$ .

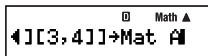

### Important!

If you specify a matrix memory that already contains matrix data, the existing data will be overwritten with the data you input here.

- To store the matrix, press  $\boxed{\text{EXE}}$ .
  - This displays the stored matrix on the screen. The display format is the same as that of the matrix editor screen, but you cannot edit the matrix on this screen.
  - Pressing  $\boxed{\text{EXIT}}$  will return to the COMP Mode calculation screen.

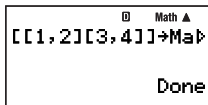
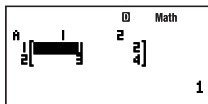

### Note

You can assign the contents of Matrix Answer memory to a matrix variable (such as Mat A) by executing the following: Mat Ans  $\rightarrow$  Mat A.

## ▣ Viewing the Contents of a Matrix

- On the COMP Mode calculation screen, press  $\boxed{\text{FUNCTION}} - \{\text{MATRIX}\} \boxed{1} (\text{EDIT})$  to display the matrix memory area menu.
- Use  $\blacktriangledown$  and  $\blacktriangle$  to move the highlighting to the matrix whose contents you want to view, and then press  $\boxed{\text{EXE}}$ .
- Now you can edit the cell contents of the matrix, if you want.
  - Use the cursor keys to move the cursor to the cell whose value you want to change and then input the new value. After inputting a value, press  $\boxed{\text{EXE}}$  to register it.
- After you finish making the changes you want, press  $\boxed{\text{EXIT}}$ .

## ▣ Deleting the Contents of a Particular Matrix Memory Area

- On the COMP Mode calculation screen, press  $\boxed{\text{FUNCTION}} - \{\text{MATRIX}\} \boxed{1} (\text{EDIT})$  to display the matrix memory area menu.
- Use  $\blacktriangledown$  and  $\blacktriangle$  to move the highlighting to the matrix memory whose contents you want to delete.
- Press  $\boxed{\text{DEL}}$  or  $\boxed{\text{FUNCTION}} \boxed{2} (\text{Del})$ .
  - This causes a confirmation message to appear.
- To delete all programs currently stored in calculator memory, press  $\boxed{\text{EXE}}$  (Yes). To cancel the operation without deleting anything, press  $\boxed{\text{EXIT}}$  (No).

## ■ Performing Matrix Calculations

This section presents a number of actual examples of matrix calculations.

- Before performing matrix calculations, you need to perform the procedure under “Inputting and Editing Matrix Data” (page 59) to input data into the matrices you plan to use in the calculations.
- The table below shows the matrix name notation used in this section. When you see a matrix name in a procedure, you need to perform one of the key operations shown below.

When you see this matrix name:	Perform this key operation:
[Mat A]	$\text{FUNCTION} - \{\text{MATRIX}\} \text{2} (\text{Mat}) \text{ALPHA} \text{i} (\text{A})$
[Mat B]	$\text{FUNCTION} - \{\text{MATRIX}\} \text{2} (\text{Mat}) \text{ALPHA} \text{B} (\text{B})$
[Mat C]	$\text{FUNCTION} - \{\text{MATRIX}\} \text{2} (\text{Mat}) \text{ALPHA} \text{C} (\text{C})$

- All of the examples in this section are performed using natural display.

### ▣ Adding and Subtracting Matrices

You can add or subtract matrices only if their dimensions are identical.

**Example:**  $\begin{bmatrix} 2 & 0 \\ 0 & 2 \end{bmatrix} + \begin{bmatrix} 1 & 2 \\ 3 & 4 \end{bmatrix}$

This example assumes that Mat A contains  $\begin{bmatrix} 2 & 0 \\ 0 & 2 \end{bmatrix}$  and Mat B contains  $\begin{bmatrix} 1 & 2 \\ 3 & 4 \end{bmatrix}$ .

$[\text{Mat A}] \oplus [\text{Mat B}]$

Ans 1 2  
2 3 4

### ▣ Multiplying Matrices

You can multiply two matrices only if they both have the same number of rows.

**Example:**  $\left( \begin{bmatrix} 2 & 0 \\ 0 & 2 \end{bmatrix} + \begin{bmatrix} 1 & 2 \\ 3 & 4 \end{bmatrix} \right) \times \begin{bmatrix} 3 \\ 5 \end{bmatrix}$

This example assumes that Mat A contains  $\begin{bmatrix} 2 & 0 \\ 0 & 2 \end{bmatrix}$ , Mat B contains  $\begin{bmatrix} 1 & 2 \\ 3 & 4 \end{bmatrix}$ , and Mat C contains  $\begin{bmatrix} 3 \\ 5 \end{bmatrix}$ .

$[\text{Mat A}] \oplus [\text{Mat B}] \text{EXE}$

Ans 1 2  
2 3 4

$\otimes [\text{Mat C}]$

Mat Ans x Mat C  
9 14



## Note

While a calculation screen is on the display, you can input the Mat Ans variable by pressing  $\text{FUNCTION}$  - {MATRIX}  $\text{2}$  (Mat)  $\text{SHIFT}$   $\text{C}$  (Ans).

## Calculating the Scalar Multiplication of a Matrix

Your calculator supports the following types of scalar multiplication calculations.

$$n \times \text{Mat A}, n \text{ Mat A}, \text{Mat A} \times n, \text{Mat A} \div n$$

- You can replace "Mat A" with any of the calculator's matrices, from Mat A to Mat F, or Mat Ans.
- For  $n$ , you can use a value, independent memory (M), variable, matrix name, constant ( $\pi$  or scientific constant), or scientific function value (like  $\sin(30)$ ).

**Example:**  $3 \times \left( \begin{bmatrix} 2 & 0 \\ 0 & 2 \end{bmatrix} + \begin{bmatrix} 1 & 2 \\ 3 & 4 \end{bmatrix} \right)$

This example assumes that Mat A contains  $\begin{bmatrix} 2 & 0 \\ 0 & 2 \end{bmatrix}$  and Mat B contains  $\begin{bmatrix} 1 & 2 \\ 3 & 4 \end{bmatrix}$ .

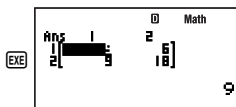
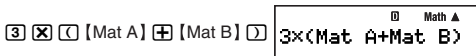

## Absolute Values of Matrix Elements

The following determines absolute values of the elements of a matrix and places them onto the Mat Ans screen.

**Example:** To determine the absolute values of the matrix  $\begin{bmatrix} 1 & -2 \\ 5 & 0 \end{bmatrix}$ .

This example assumes that Mat C contains  $\begin{bmatrix} 1 & -2 \\ 5 & 0 \end{bmatrix}$ .

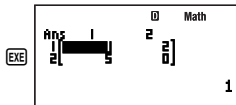



## Obtaining the Determinant of a Matrix

The  $\det()$  function can be used to obtain the determinant of a square matrix.

$$\det[a_{11}] = a_{11}$$

$$\det \begin{bmatrix} a_{11} & a_{12} \\ a_{21} & a_{22} \end{bmatrix} = a_{11}a_{22} - a_{12}a_{21}$$

$$\det \begin{bmatrix} a_{11} & a_{12} & a_{13} \\ a_{21} & a_{22} & a_{23} \\ a_{31} & a_{32} & a_{33} \end{bmatrix} = a_{11}a_{22}a_{33} + a_{12}a_{23}a_{31} + a_{13}a_{21}a_{32} - a_{13}a_{22}a_{31} - a_{12}a_{21}a_{33} - a_{11}a_{23}a_{32}$$

**Example:** To obtain the determinant of the matrix  $\begin{bmatrix} 1 & -2 \\ 5 & 0 \end{bmatrix}$ .

This example assumes that Mat C contains  $\begin{bmatrix} 1 & -2 \\ 5 & 0 \end{bmatrix}$ .

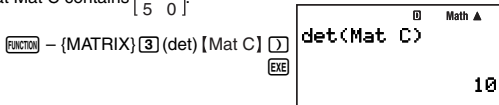

## Transposing a Matrix

Transposing a matrix basically means to change its rows in to columns and its columns into rows. Calculation is performed using the  $\text{Trn}()$  function as shown below.

**Example:** To transpose the matrix  $\begin{bmatrix} 1 & 2 & 3 \\ 4 & 5 & 6 \end{bmatrix}$ .

This example assumes that Mat B contains  $\begin{bmatrix} 1 & 2 & 3 \\ 4 & 5 & 6 \end{bmatrix}$ .

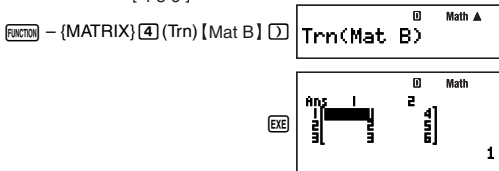

## Inverting a Matrix

You can use the procedure shown below to invert a square matrix.

$$[a_{11}]^{-1} = \left[ \frac{1}{a_{11}} \right]$$

$$\begin{bmatrix} a_{11} & a_{12} \\ a_{21} & a_{22} \end{bmatrix}^{-1} = \frac{1}{a_{11}a_{22} - a_{12}a_{21}} \begin{bmatrix} a_{22} & -a_{12} \\ -a_{21} & a_{11} \end{bmatrix}$$

$$\begin{bmatrix} a_{11} & a_{12} & a_{13} \\ a_{21} & a_{22} & a_{23} \\ a_{31} & a_{32} & a_{33} \end{bmatrix}^{-1} = \frac{\begin{bmatrix} a_{22}a_{33} - a_{23}a_{32} & -a_{12}a_{33} + a_{13}a_{32} & a_{12}a_{23} - a_{13}a_{22} \\ -a_{21}a_{33} + a_{23}a_{31} & a_{11}a_{33} - a_{13}a_{31} & -a_{11}a_{23} + a_{13}a_{21} \\ a_{21}a_{32} - a_{22}a_{31} & -a_{11}a_{32} + a_{12}a_{31} & a_{11}a_{22} - a_{12}a_{21} \end{bmatrix}}{a_{11}a_{22}a_{33} + a_{12}a_{23}a_{31} + a_{13}a_{21}a_{32} - a_{13}a_{22}a_{31} - a_{12}a_{21}a_{33} - a_{11}a_{23}a_{32}}$$

### Important!

- Matrix inversion is supported for a non-zero square matrix only.
- Use the  $\text{SHIFT}$   $\left[ \frac{1}{x} \right]$  ( $x^{-1}$ ) key to input  $x^{-1}$ .

**Example:** To invert the matrix  $\begin{bmatrix} 1 & -2 \\ 5 & 0 \end{bmatrix}$ .

This example assumes that Mat C contains  $\begin{bmatrix} 1 & -2 \\ 5 & 0 \end{bmatrix}$ .

[Mat C]  $\text{SHIFT}$   $\left[ \frac{1}{x} \right]$   $\text{EXE}$

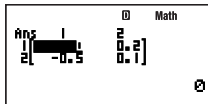

### ❖ Squaring a Matrix

You can use the procedure shown below to square a matrix.

### Important!

Use the  $\left[ x^2 \right]$  key to specify the squaring operation.

**Example:** To square the matrix  $\begin{bmatrix} 1 & -2 \\ 5 & 0 \end{bmatrix}$ .

This example assumes that Mat C contains  $\begin{bmatrix} 1 & -2 \\ 5 & 0 \end{bmatrix}$ .

[Mat C]  $\left[ x^2 \right]$   $\text{EXE}$

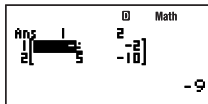

## Sequence Calculations (RECUR)

To perform the example operations in this section, first select RECUR ( $\text{MODE}$   $\left[ 6 \right]$ ) as the calculation mode.

### ■ Sequence Calculation Overview

You can use either of the two following sequence types to create a sequence table.

#### ① $a_n$ Type Sequence

With this sequence type, you input the general term of the sequence ( $a_n = f(n)$ ), along with a sequence start value and end value.

#### ② $a_{n+1}$ Type Sequence

With this sequence type, you input the recursion formula for two-term recursion ( $a_{n+1} = f(a_n)$ ), along with a sequence start value and end value.

## ❑ Selecting the Sequence Type

To select this sequence type:	Perform this key operation:
$a_n$ Type	<b>FUNCTION</b> - {TYPE} <b>1</b> ( $a_n$ )
$a_{n+1}$ Type	<b>FUNCTION</b> - {TYPE} <b>2</b> ( $a_{n+1}$ )

## ❑ Sequence Editor Screen

Either of the sequence editor screens shown below appears immediately after you enter the RECUR Mode and select the sequence type. Use this screen to input the expression that defines the expression (general term or recursion formula).

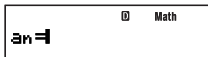

$a_n$  Type

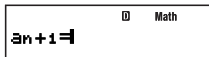

$a_{n+1}$  Type

## Inputting a Formula on the Sequence Editor Screen

**Example 1:** To input  $a_{n+1} = a_n + n + 1$

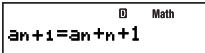
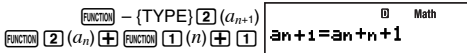

**Example 2:** To input  $a_n = n + 5$

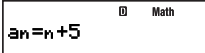
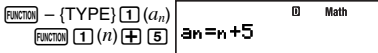

### Note

To clear the screen during input, press **AC/ON**.

## ❑ Table Range Screen

Pressing **EXE** to register the formula you input on the sequence editor screen displays either of the table range screens shown below.



$a_n$  Type Sequence

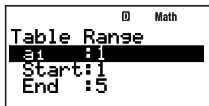

$a_{n+1}$  Type Sequence

Use this screen to specify the start value (Start) and end value (End) of  $n$  for sequence table creation.

## Specifying the Initial Term, Start Value, and End Value

- On the table range screen, use  $\blacktriangledown$  and  $\blacktriangle$  to move the highlighting to the setting you want to change.
- Input the values or expressions you want.
  - To clear the screen during input, press **AC/ON**.
  - Pressing **EXIT** during input will discard everything you have input up to that point, and restores the values that were previously input on the screen.

3. After inputting everything you want, press  $\boxed{\text{EXE}}$ .
- This registers your input. If you input expressions, the calculation result of the expression is registered.
  - While any setting is highlighted, press  $\boxed{\text{EXE}}$  to display the sequence table screen (page 67).

## Returning to the Sequence Editor Screen from the Table Range Screen

Press  $\boxed{\text{EXIT}}$ .

### Sequence Table Screen

When you press  $\boxed{\text{EXE}}$  in step 3 under “Specifying the Initial Term, Start Value, and End Value”, the calculator will perform the sequence calculation in accordance with the formula (general term or recursion formula), initial term, start value, and end value that you have input, and display the result on the sequence table screen.

$a_n$  Type Sequence

$a_{n+1}$  Type Sequence

- Each of cells on the sequence table screen shows up to six digits of the value currently stored in the cell.
- To see the full value in a cell, move the highlighting to it. The full value contained in the cell will appear in the value display area at the bottom of the screen.
- While a value is in the value display area, you can convert it using ENG conversion (page 53), sexagesimal-decimal conversion (page 27), or decimal-fraction format conversion (page 22).
- Note, however, that you cannot input into the value display area or edit the values displayed there.

## Sequence Table Columns

This column:	Contains this data:
$n$	Value from the start value to the end value specified for $n$ on the table range screen.
$a_n$	Value of $a_n$ for the $n$ -value in the same line.
$\Sigma a_n$	Sum of $a_n$ from start value of $n$ up to the $n$ -value in the same line
$n+1$	Value from the start value to the end value specified for $n+1$ on the table range screen.
$a_{n+1}$	Value of $a_{n+1}$ for the $n+1$ value in the same line.
$\Sigma a_{n+1}$	Sum of $a_{n+1}$ from $a_1$ to $n+1$ in the same line.

## Returning to the Table Range Screen from the Sequence Table Screen

Press  $\boxed{\text{EXIT}}$ .



Register the general term:

 (This displays the table range screen.)



Input Start = 2 and End = 6:





Create the sequence table:

 (This displays the sequence table screen.)

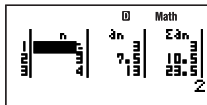

## Sequence Calculation Precautions

The following functions cannot be used during sequence calculations.

- CALC
- SOLVE
- Coordinate conversion (Pol(, Rec(
- $d/dx$ (,  $d^2/dx^2$ (,  $\int$ (,  $\Sigma$ (
- Independent memory add and subtract (, ) (M-)
- Assignment of values to variables () (STO)
- Multi-statement input

## Sequence Table Generation Errors

- A sequence table can have up to 199 lines. A Range ERROR occurs if a table range setting causes this to be exceeded.
- A "Memory Full" error also occurs if the calculator runs out of calculation result memory while performing a sequence table calculation.

## Math ERROR during Sequence Calculation

If a Math ERROR occurs during sequence table calculation, the sequence table screen appears on the display with "ERROR" in the cell that generated the error.

# Equation Calculations (EQN)

## Equation Calculation Overview

This section shows the general operational procedure for solving simultaneous linear equations with two unknowns. Natural display is used for this procedure.

$$X + 0.5Y = 3$$

$$2X + 3Y = 4$$

1. Press **MODE** **8** (EQN).

- This displays an initial EQN type menu like the one shown below.

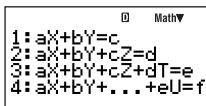

2. Press **1** (aX+bY=c) to select simultaneous linear equations with two unknowns.

- This displays a coefficient editor screen like the one shown below. You can use this screen to input values for the equation's coefficients.

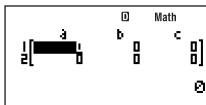

3. Input values for the coefficients.

**1** **EXE** **0** **.** **5** **EXE** **3** **EXE** **2** **EXE** **3** **EXE** **4** **EXE**

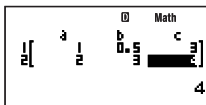

$$\begin{cases} X + 0.5Y = 3 \\ 2X + 3Y = 4 \end{cases}$$

These values will produce the simultaneous equations shown above.

4. To display the solutions, press **EXE**.

- This displays the solution for X.

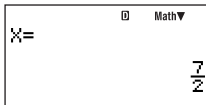

- Use **▼** and **▲** to switch the display between the solutions for X and Y.

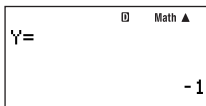

- To exit the solution screen and return to the coefficient editor screen, press **EXIT**.

## ■ Selecting an Equation Type

The following shows the operations you can use to select an equation type.

To select this equation type:	Perform this key operation:	EQN type menu item:
Simultaneous Linear Equations with Two Unknowns	<b>MODE</b> <b>8</b> (EQN) <b>1</b>	$aX+bY=c$
Simultaneous Linear Equations with Three Unknowns	<b>MODE</b> <b>8</b> (EQN) <b>2</b>	$aX+bY+cZ=d$
Simultaneous Linear Equations with Four Unknowns	<b>MODE</b> <b>8</b> (EQN) <b>3</b>	$aX+bY+cZ+dT=e$
Simultaneous Linear Equations with Five Unknowns	<b>MODE</b> <b>8</b> (EQN) <b>4</b>	$aX+bY+cZ+dT+eU=f$
Quadratic Equation	<b>MODE</b> <b>8</b> (EQN) <b>▼</b> <b>1</b>	$aX^2+bX+c=0$
Cubic Equation	<b>MODE</b> <b>8</b> (EQN) <b>▼</b> <b>2</b>	$aX^3+bX^2+cX+d=0$

### Note

Changing the equation type after you are already using the EQN Mode to perform a calculation will cause all values currently input on the coefficient editor screen to be cleared.

## ■ Inputting Values for Coefficients

Use the coefficient editor for inputting values for the coefficients of an equation. The coefficient editor screen has cells that you can use to input values for each coefficient. The number of cells that appear on the coefficient editor screen depends on the equation type you selected.

### ◀ Inputting and Editing Coefficient Values

- Use the cursor keys to move the cursor to the cell you want and then input a value. As you input a value or expression, it appears in the lower left corner of the display.
- To clear the contents of the cell where the cursor is currently located, press **AC/ON**.
- You must press **EXE** to finalize input into the cell where the cursor is located. This will register your input and move the cursor to the next cell. Up to six digits of the input value will be displayed in the cell when you press **EXE**.
- You can input a value or calculation expression into each cell. If you input a calculation expression, pressing **EXE** will execute the calculation and display only the result in the applicable cell.
- To edit the contents of a cell, use the cursor keys to move the cursor to the cell and then input what you want.



## ■ Viewing Equation Solutions

Pressing **EXE** while the coefficient editor is displayed will display the solutions of the equation.

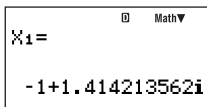

Calculator screen showing the solution  $X_1 = -1 + 1.414213562i$ . The screen also displays "Math" and a dropdown arrow.

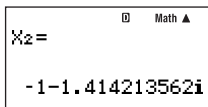

Calculator screen showing the solution  $X_2 = -1 - 1.414213562i$ . The screen also displays "Math" and an up arrow.

Equation solution

- You can use **▼** and **▲** to scroll forward and back through the solutions.
- You can also press **EXE** while a solution is displayed to cycle through all of the other available solutions. Pressing **EXE** while the final solution is displayed will return to the coefficient editor screen.
- To exit the solution screen and return to the coefficient editor screen, press **EXIT**.
- The display format of the solutions depends on the setup's display format settings and complex number display format settings.

## ||| Statistical Calculations (SD/REG) |||

Perform statistical calculations in the SD Mode or REG Mode. The SD Mode is for single-variable statistical calculations, while the REG Mode is for paired-variable regression calculations (linear, quadratic, logarithmic,  $e$  exponential,  $ab$  exponential, power, inverse).

## ■ Statistical Sample Data

Except for the number of variables, the procedure for inputting sample data is the same for both the SD Mode and the REG Mode. Use the STAT editor list screen to input sample data.

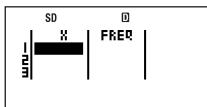

SD Mode STAT editor screen showing columns for X and FREQ.

SD Mode STAT editor

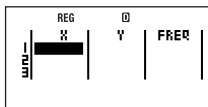

REG Mode STAT editor screen showing columns for X, Y, and FREQ.

REG Mode STAT editor

The applicable STAT editor screen appears first whenever you enter the SD Mode (**MODE** **3**) or REG Mode (**MODE** **4**).

## ▣ Sample Data Input Methods

You can input sample data either with statistical frequency turned on (FreqOn) or off (FreqOff). The calculator's initial default setting is FreqOff. You can select the input method you want to use with the setup screen statistical frequency setting (page 13).

The STAT editor screens include a FREQ column when statistical frequency is turned on (FreqOn). There is no FREQ column when statistical frequency is turned off (FreqOff).

## Inputting Sample Data

The following example shows how to input the following sample data in the SD Mode.

Class Value (X)	Frequency (FREQ)
24.5	4
25.5	6
26.5	2

Enter the SD Mode:

MODE 3 (SD)

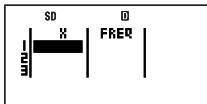

Input the class values in the X column:

2 4 . 5 EXE 2 5 . 5 EXE 2 6 . 5 EXE

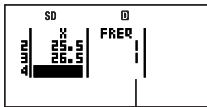

The initial default for all frequencies is 1.

Move the cursor to the top cell of the FREQ column:

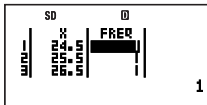

Input the frequency values in the FREQ column:

4 EXE 6 EXE 2 EXE

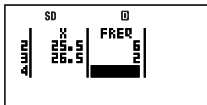

The only difference when inputting sample data in the REG Mode is that the STAT editor screen has three columns named X, Y, and FREQ.

### Note

- In the SD Mode, one set of sample data consists of an X value and FREQ value, while one set of REG Mode sample data consists of an X value, Y value, and FREQ value. Whenever you start input of a sample data set by inputting a value for any one of its columns on the STAT editor screen, the remaining column(s) in the same sample data set change(s) to their initial defaults (X = 0, Y = 0, FREQ = 1).
- Inputting a calculation expression into a cell and pressing **EXE** will register the result of the calculation.
- In both the SD Mode and REG Mode, you can input up to 199 STAT editor lines of sample data.
- Sample data you input is retained in memory until you delete it or reset the calculator. Changing to another calculation mode, changing the statistical frequency setting, or turning off the calculator does not affect sample data.

- Even though Y-data is not used and there is no indication of Y-data on the screen in the SD Mode, the calculator still maintains a Y-value (always zero) internally for each X-data. Because of this, if you perform a statistical calculation operation that involves Y-data (such as  $\Sigma y$ ) after inputting single-variable data in the SD Mode, the calculator will produce a result without displaying an error.

## Editing Sample Data

You can use the procedures in this section to perform the following STAT editor screen editing operations: replace cell contents, insert a line, insert a cell, delete a cell, and delete all STAT editor screen data.

### Replacing the Contents of a Cell

Use the cursor keys to move the cursor to the cell whose contents you want to replace and then input the value or calculation expression you want. After you are finished, press **EXE** to register your input.

### Inserting a Line

1. Move the cursor to the location where you want to insert the line.
2. Press **FUNCTION** **5** (STAT) **1** (Edit) **1** (Ins Row).
  - This shifts the line where the cursor is located and everything below it downwards, and inserts a new line.
  - All of the columns in the newly inserted lines are filled in with the applicable initial default values (X = 0, Y = 0 if applicable, FREQ = 1).

### Deleting all STAT Editor Data

1. Press **FUNCTION** **5** (STAT) **1** (Edit) **2** (Del All).
  - This causes the “Delete All Data?” confirmation message to appear.
2. To delete all STAT editor data, press **EXE** (Yes). To cancel the operation without deleting anything, press **EXIT** (No).

### Inserting a Cell

1. Move the cursor to the location where you want to insert the cell.
2. Press **FUNCTION** **5** (STAT) **1** (Edit) **3** (Ins Cell).
  - This shifts the cell where the cursor is located and everything below it downwards, and inserts a new cell. The cell at the bottom of the column where the new cell is inserted is deleted automatically.

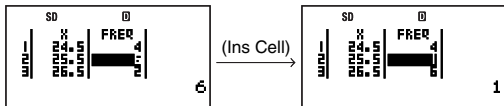

- The inserted cell is filled in with the applicable initial default value (X = 0, Y = 0, or FREQ = 1).

### Deleting a Cell

1. Move the cursor to the cell you want to delete.

2. Press **FUNCTION** **5** (STAT) **1** (Edit) **4** (Del Cell).

- This deletes the cell where the cursor is located and shifts everything below it upwards. A new cell is inserted at the bottom of the column where the cell is deleted.

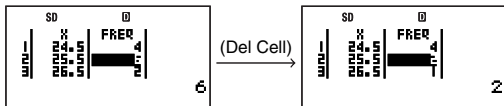

- The new cell that is inserted at the bottom of the column is filled in with the applicable initial default value (X = 0, Y = 0, or FREQ = 1).

## ■ Performing Single-variable Statistical Calculations

- To perform the example operations in this section, first select SD (**MODE** **3**) as the calculation mode.
- The following operation assumes that the sample data under “Inputting Sample Data” on page 73 is already input.

### ▣ Displaying the Statistical Calculation Result Screen

While the STAT editor screen (containing the sample data) is on the display, perform the following key operation.

**FUNCTION** **6** (RESULT)  
(Use **▼** and **▲** to scroll.)

SD	0	▼
1-Variable		
$\bar{x}$	=	25.0714285
$\Sigma x$	=	175.5
$\Sigma x^2$	=	4403.75
-----		
$x\sigma_n$	=	0.72843135
$x\sigma_{n-1}$	=	0.78679579
$n$	=	7
minX	=	24.5
maxX	=	26.5

This is one example of possible calculation results.

### Note

- Calculation results can be displayed up to 10 digits.
- To return to the STAT editor screen, press **EXIT**.
- For the meanings of the values that appear on the statistical calculation result screen and the formulas used to produce them, see “SD Mode Statistical Command Reference” (page 76).

### ▣ Performing a Specific Statistical Calculation

1. While the STAT editor screen is on the display, press **FUNCTION** **1** ( $\rightarrow$ COMP).
  - This displays the initial COMP Mode calculation screen.
2. Input the command for the statistical calculation you want to perform and then press **EXE**.
  - To determine the mean value ( $\bar{x}$ ) of the currently input sample data, for example, perform the operation shown below.

FUNCTION 7 (STAT) 2 (VAR)

1:n	2: $\bar{x}$
3: $x\sigma_n$	4: $x\sigma_{n-1}$
5: $\bar{y}$	6: $y\sigma_n$
7: $y\sigma_{n-1}$	

2 ( $\bar{x}$ ) EXE

$\bar{x}$	65.68
-----------	-------

This is one example of possible calculation results.

For more information about statistical calculation commands, see the following section.

## SD Mode Statistical Command Reference

**$n$**  FUNCTION 7 (STAT) 2 (VAR) 1

Obtains the number of samples.

$$n = (\text{number of } x_i\text{-data items})$$

**$\bar{x}$**  FUNCTION 7 (STAT) 2 (VAR) 2

Obtains the mean.

$$\bar{x} = \frac{\sum x_i}{n}$$

**$x\sigma_n$**  FUNCTION 7 (STAT) 2 (VAR) 3

Obtains the population standard deviation.

$$x\sigma_n = \sqrt{\frac{\sum(x_i - \bar{x})^2}{n}}$$

**$x\sigma_{n-1}$**  FUNCTION 7 (STAT) 2 (VAR) 4

Obtains the sample standard deviation.

$$x\sigma_{n-1} = \sqrt{\frac{\sum(x_i - \bar{x})^2}{n-1}}$$

**$\sum x^2$**  FUNCTION 7 (STAT) 2 (VAR) 1

Obtains the sum of squares of the sample data.

$$\sum x^2 = \sum x_i^2$$

**$\sum x$**  FUNCTION 7 (STAT) 2 (VAR) 2

Obtains the sum of the sample data.

$$\sum x = \sum x_i$$

**minX** FUNCTION 7 (STAT) 2 (VAR) 1

Determines the minimum value of the samples.

**maxX**

FUNCTION 7 (STAT) 2 (VAR) ▾ ▾ 2

Determines the maximum value of the samples.

**P(**

FUNCTION 7 (STAT) 3 (DISTR) 1

For the argument  $t$ , determines the probability of standard normal distribution  $P(t)$ .

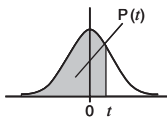

$$P(t) = \frac{1}{\sqrt{2\pi}} \int_{-\infty}^t e^{-\frac{x^2}{2}} dx$$

**Q(**

FUNCTION 7 (STAT) 3 (DISTR) 2

For the argument  $t$ , determines the probability of standard normal distribution  $Q(t)$ .

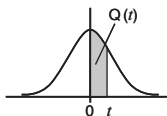

$$Q(t) = \frac{1}{\sqrt{2\pi}} \int_0^{|t|} e^{-\frac{x^2}{2}} dx$$

**R(**

FUNCTION 7 (STAT) 3 (DISTR) 3

For the argument  $t$ , determines the probability of standard normal distribution  $R(t)$ .



$$R(t) = \frac{1}{\sqrt{2\pi}} \int_t^{+\infty} e^{-\frac{x^2}{2}} dx$$

**►t**

FUNCTION 7 (STAT) 3 (DISTR) 4

Using the value (X) input immediately before the command as the argument, uses the following formula to determine standardized variate  $t$ .

$$X \blacktriangleright t = \frac{X - \bar{x}}{X\sigma_n}$$

## ■ Performing Paired-variable Statistical Calculations

- To perform the example operations in this section, first select REG (MODE 4) as the calculation mode.
- The following operation assumes that the sample data under "Inputting Sample Data" on page 73 is already input.

## ❑ Displaying the Statistical Calculation Result Screen

In the REG Mode, you can display a screen that lists the results of standard deviation and sum calculations. You can also display results for a specific type of regression calculation.

### Note

- Calculation results can be displayed up to 10 digits.
- To return to the STAT editor screen from the calculation result screen, press **EXIT**.
- For the meanings of the values that appear on the result screen and the formulas used to produce them, see “REG Mode Statistical Command Reference” (page 80).

## Displaying the Standard Deviation and Sum Calculation Result Screen

While the STAT editor screen (containing the sample data) is on the display, perform the following key operation.

**FUNCTION** **6** (RESULT) **1** (S-Var)  
(Use **▼** and **▲** to scroll.)

REG	0	▼
2-Variable		
$\bar{x}$	=	25.0714285
$\Sigma x$	=	175.5
$\Sigma x^2$	=	4403.75
-----		
$x\sigma_n$	=	0.72843135
$x\sigma_{n-1}$	=	0.78679579
$n$	=	7
$\bar{y}$	=	1.57142857
$\Sigma y$	=	11
$\Sigma y^2$	=	21
$y\sigma_n$	=	0.72843135
$y\sigma_{n-1}$	=	0.78679579
$\Sigma xy$	=	279.5
$\Sigma x^3$	=	110596.875
$\Sigma x^2y$	=	7108.75
$\Sigma x^4$	=	2780005.43
minX	=	24.5
maxX	=	26.5
minY	=	1
maxY	=	3

This is one example of possible calculation results.

## Displaying Regression Calculation Results

1. While the STAT editor screen (containing the sample data) is on the display, perform the following key operation.

**FUNCTION** **6** (RESULT) **2** (Reg)

REG	0
1:Line	2:Quad
3:Log	4:eExp
5:abExp	6:Power
7:Inv	

- This displays the regression type menu.

2. Press the key that corresponds to the type of regression whose results you want to display.

To display the results of this type of regression calculation:	Press this key:
Linear ( $y = ax + b$ )	<b>[1]</b> (Line)
Quadratic ( $y = ax^2 + bx + c$ )	<b>[2]</b> (Quad)
Logarithmic ( $y = a + b \ln x$ )	<b>[3]</b> (Log)
$e$ Exponential ( $y = ae^{bx}$ )	<b>[4]</b> (eExp)
$ab$ Exponential ( $y = ab^x$ )	<b>[5]</b> (abExp)
Power ( $y = ax^b$ )	<b>[6]</b> (Power)
Inverse ( $y = a + b/x$ )	<b>[7]</b> (Inv)

(Example screen when **[1]** is pressed)

	REG	0
$y = ax + b$		
a	=0.1347162	
b	=-4.6081604	
r	=0.90910777	

This is one example of possible calculation results.

## ☒ Performing a Specific Statistical Calculation

- While the STAT editor screen is on the display, press **FUNCTION** **[1]** ( $\rightarrow$ COMP).
  - This displays the initial COMP Mode calculation screen.
- Input the command for the statistical calculation you want to perform and then press **EXE**.
  - To determine the mean ( $\bar{x}$  and  $\bar{y}$ ) values of the current input sample data, for example, perform the operation shown below.

**FUNCTION** **[7]** (STAT) **[2]** (VAR)

	0	▼
1:n	2: $\bar{x}$	
3: $x\sigma n$	4: $x\sigma n-1$	
5: $\bar{y}$	6: $y\sigma n$	
7: $y\sigma n-1$		

**[2]** ( $\bar{x}$ ) **EXE**

	0	▲
$\bar{x}$		65.68

**FUNCTION** **[7]** (STAT) **[2]** (VAR) **[5]** ( $\bar{y}$ ) **EXE**

	0	▲
$\bar{y}$		4.24

This is one example of possible calculation results.



## ☒ Performing a Specific Regression Calculation

**Example:** To use the statistical data shown below to perform logarithmic regression to obtain the correlation coefficient and the estimated value of  $y$  when  $x = 100$

$x$	$y$
29	1.6
50	23.5
74	38.0
103	46.4
118	48.9

1. Display the logarithmic regression calculation result screen.

**FUNCTION** **6** (RESULT) **2** (Reg) **3** (Log)

REG	
$y=a+b \cdot \ln x$	
$a$	=-111.12839
$b$	=34.0201475
$r$	=0.99401394

2. Press **EXIT** to return to the STAT editor screen.
3. Press **FUNCTION** **1** ( $\rightarrow$ COMP) to display the COMP Mode calculation screen.
4. Determine correlation coefficient  $r$  and the estimated value of  $y$  when  $x = 100$ .
  - Correlation Coefficient

**FUNCTION** **7** (STAT) **2** (VAR)  
**4** (r) **EXE**

r	
	0.9940139466

- Estimated Value of  $y$  when  $x = 100$

**1** **0** **0** **FUNCTION** **7** (STAT) **2** (VAR)  
**7** ( $\hat{y}$ ) **EXE**

100 $\hat{y}$	
	45.54017135

### Note

- The  $r$  and  $\hat{y}$  values produced by this example are for logarithmic regression because we first displayed the logarithmic regression calculation screen in step 1 before using the commands to calculate the values we wanted. If you do not display a particular regression calculation result screen first, the values produced by the commands are for linear regression by default.
- For details about statistical calculation commands, see "REG Mode Statistical Command Reference" (page 80).

## ☒ REG Mode Statistical Command Reference

### Mean and Standard Deviation Commands

$n$

**FUNCTION** **7** (STAT) **2** (VAR) **1**

Obtains the number of samples.

$$n = (\text{number of } x_i\text{-data items})$$

$\bar{x}$ 

FUNCTION 7 (STAT) 2 (VAR) 2

Obtains the mean of the sample  $x$ -data.

$$\bar{x} = \frac{\sum x_i}{n}$$

 $x\sigma_n$ 

FUNCTION 7 (STAT) 2 (VAR) 3

Obtains the population standard deviation of the sample  $x$ -data.

$$x\sigma_n = \sqrt{\frac{\sum (x_i - \bar{x})^2}{n}}$$

 $x\sigma_{n-1}$ 

FUNCTION 7 (STAT) 2 (VAR) 4

Obtains the sample standard deviation of the sample  $x$ -data.

$$x\sigma_{n-1} = \sqrt{\frac{\sum (x_i - \bar{x})^2}{n-1}}$$

 $\bar{y}$ 

FUNCTION 7 (STAT) 2 (VAR) 5

Obtains the mean of the sample  $y$ -data.

$$\bar{y} = \frac{\sum y_i}{n}$$

 $y\sigma_n$ 

FUNCTION 7 (STAT) 2 (VAR) 6

Obtains the population standard deviation of the sample  $y$ -data.

$$y\sigma_n = \sqrt{\frac{\sum (y_i - \bar{y})^2}{n}}$$

 $y\sigma_{n-1}$ 

FUNCTION 7 (STAT) 2 (VAR) 7

Obtains the sample standard deviation of the sample  $y$ -data.

$$y\sigma_{n-1} = \sqrt{\frac{\sum (y_i - \bar{y})^2}{n-1}}$$

## Sum Commands

 $\sum x^2$ 

FUNCTION 7 (STAT) 2 (VAR) ▾ 1

Obtains the sum of squares of the sample  $x$ -data.

$$\sum x^2 = \sum x_i^2$$

 $\sum x$ 

FUNCTION 7 (STAT) 2 (VAR) ▾ 2

Obtains the sum of the sample  $x$ -data.

$$\sum x = \sum x_i$$

**$\Sigma y^2$** 

FUNCTION 7 (STAT) 2 (VAR) ▼ 3

Obtains the sum of squares of the sample  $y$ -data.

$$\Sigma y^2 = \Sigma y_i^2$$

 **$\Sigma y$** 

FUNCTION 7 (STAT) 2 (VAR) ▼ 4

Obtains the sum of the sample  $y$ -data.

$$\Sigma y = \Sigma y_i$$

 **$\Sigma xy$** 

FUNCTION 7 (STAT) 2 (VAR) ▼ 5

Obtains the sum of products of the sample  $x$ -data and  $y$ -data.

$$\Sigma xy = \Sigma x_i y_i$$

 **$\Sigma x^3$** 

FUNCTION 7 (STAT) 2 (VAR) ▼ 6

Obtains the sum of cubes of the sample  $x$ -data.

$$\Sigma x^3 = \Sigma x_i^3$$

 **$\Sigma x^2 y$** 

FUNCTION 7 (STAT) 2 (VAR) ▼ 7

Obtains the sum of squares of the sample  $x$ -data multiplied by the sample  $y$ -data.

$$\Sigma x^2 y = \Sigma x_i^2 y_i$$

 **$\Sigma x^4$** 

FUNCTION 7 (STAT) 2 (VAR) ▼ 8

Obtains the sum of the fourth power of the sample  $x$ -data.

$$\Sigma x^4 = \Sigma x_i^4$$

## Minimum and Maximum Value Commands

**minX**

FUNCTION 7 (STAT) 2 (VAR) ▼ ▼ 1

Obtains the minimum value of the sample  $x$ -data.**maxX**

FUNCTION 7 (STAT) 2 (VAR) ▼ ▼ 2

Obtains the maximum value of the sample  $x$ -data.**minY**

FUNCTION 7 (STAT) 2 (VAR) ▼ ▼ 3

Obtains the minimum value of the sample  $y$ -data.**maxY**

FUNCTION 7 (STAT) 2 (VAR) ▼ ▼ 4

Obtains the maximum value of the sample  $y$ -data.

## Regression Coefficient and Estimated Value Commands

The values obtained by the following commands depend on the regression formula used for the calculation. The regression formula used is the one that is applicable for the regression calculation result screen (page 78) that was last displayed in the REG Mode.

**a** FUNCTION 7 (STAT) 2 (VAR) ▼ ▼ ▼ 1

Obtains coefficient a of the regression formula.

**b** FUNCTION 7 (STAT) 2 (VAR) ▼ ▼ ▼ 2

Obtains coefficient b of the regression formula.

**c** FUNCTION 7 (STAT) 2 (VAR) ▼ ▼ ▼ 3

This command is supported for quadratic regression only.

It obtains coefficient c of the regression formula.

**r** FUNCTION 7 (STAT) 2 (VAR) ▼ ▼ ▼ 4

Obtains correlation coefficient r.

This command is not supported for quadratic regression.

$\hat{x}_1$  FUNCTION 7 (STAT) 2 (VAR) ▼ ▼ ▼ 5

Obtains the estimated value of  $x$  for a value of  $y$ , which is assumed to be the value input immediately before this command.

$\hat{x}_2$  FUNCTION 7 (STAT) 2 (VAR) ▼ ▼ ▼ 6

This command is supported for quadratic regression only.

It obtains the second estimated value of  $x$  for a value of  $y$ , which is assumed to be the value input immediately before this command. When used in a calculation that is not a quadratic regression calculation, this command produces the same results as the  $\hat{x}_1$  command.

$\hat{y}$  FUNCTION 7 (STAT) 2 (VAR) ▼ ▼ ▼ 7

Obtains the estimated value of  $y$  for a value of  $x$ , which is assumed to be the value input immediately before this command.

## ▣ Regression Coefficient and Estimated Value Calculations

The formulas used by the regression coefficient and estimated value commands depend on the regression calculation type. For details about regression calculation formulas, see <#02> and <#08> in the separate Supplement.

For more information about this type of regression calculation:	Go here:
Linear Regression	<#02>
Quadratic Regression	<#03>
Logarithmic Regression	<#04>
$e$ Exponential Regression	<#05>
$ab$ Exponential Regression	<#06>

<b>For more information about this type of regression calculation:</b>	<b>Go here:</b>
Power Regression	<#07>
Inverse Regression	<#08>

## Statistical Calculation Examples

This section provides some actual examples of statistical calculation examples as they are performed on your calculator.

**Example 1:** The nearby table shows the pulse rates of 50 students who attend a high school for boys that has a total enrollment of 1,000 students.

- Determine the mean and standard deviation of the sample data.
- Assuming that the population distribution is a normal distribution, determine the distribution probability of students with pulse rates of 70 of greater.

Pulse Rate	Students
54 – 56	1
56 – 58	2
58 – 60	2
60 – 62	5
62 – 64	8
64 – 66	9
66 – 68	8
68 – 70	6
70 – 72	4
72 – 74	3
74 – 76	2

### Operation Procedure

Select the SD Mode: **MODE** **3** (SD)

Select FreqOn for the statistical frequency setting:

**SHIFT** **MODE** (SETUP) **5** (STAT) **1** (FreqOn)

Input the pulse rate data into the X-column:

**5** **5** **EXE** **5** **7** **EXE** **5** **9** **EXE** **6** **1** **EXE** **6** **3** **EXE** **6** **5** **EXE**  
**6** **7** **EXE** **6** **9** **EXE** **7** **1** **EXE** **7** **3** **EXE** **7** **5** **EXE**

Input the number of students data into the FREQ-column:

**▼** **▶** **1** **EXE** **2** **EXE** **2** **EXE** **5** **EXE** **8** **EXE**  
**9** **EXE** **8** **EXE** **6** **EXE** **4** **EXE** **3** **EXE** **2** **EXE**

### (1) Mean and Standard Deviation

Obtain the mean:

**FUNCTION** **1** (→COMP)  
**FUNCTION** **7** (STAT) **2** (VAR) **2** ( $\bar{x}$ ) **EXE**

$\bar{x}$	65.68
-----------	-------

Obtain the sample standard deviation:

**FUNCTION** **7** (STAT) **2** (VAR) **4** ( $s\sigma_{n-1}$ ) **EXE**

$s\sigma_{n-1}$	4.635444632
-----------------	-------------

### (2) Distribution Probability

**FUNCTION** **7** (STAT) **3** (DISTR) **3** (R) **7** **0**  
**FUNCTION** **7** (STAT) **3** (DISTR) **4** ( $\rightarrow I$ ) **7** **EXE**

$R(70 \rightarrow t)$	0.17325
-----------------------	---------

**Example 2:** The nearby data shows how the weight of a newborn at various numbers of days after birth.

- Obtain the regression formula and correlation coefficient produced by linear regression of the data.
- Obtain the regression formula and correlation coefficient produced by logarithmic regression of the data.
- Predict the weight 350 days after birth based on the regression formula that best fits the trend of the data in accordance with the regression results.

Number of Days	Weight (g)
20	3150
50	4800
80	6420
110	7310
140	7940
170	8690
200	8800
230	9130
260	9270
290	9310
320	9390

### Operation Procedure

Select the REG Mode: **MODE** **4** (REG)

Select FreqOff for the statistical frequency setting:

**SHIFT** **MODE** (SETUP) **▼** **5** (STAT) **2** (FreqOff)

Input the number of day data into the X-column:

**2** **0** **EXE** **5** **0** **EXE** **8** **0** **EXE** **1** **1** **0** **EXE** **1** **4** **0** **EXE** **1** **7** **0** **EXE**  
**2** **0** **0** **EXE** **2** **3** **0** **EXE** **2** **6** **0** **EXE** **2** **9** **0** **EXE** **3** **2** **0** **EXE**

Input the weight data into the Y-column:

**▼** **▶** **3** **1** **5** **0** **EXE** **4** **8** **0** **EXE** **6** **4** **2** **0** **EXE** **7** **3** **1** **0** **EXE**  
**7** **9** **4** **0** **EXE** **8** **6** **9** **0** **EXE** **8** **8** **0** **0** **EXE** **9** **1** **3** **0** **EXE**  
**9** **2** **7** **0** **EXE** **9** **3** **1** **0** **EXE** **9** **3** **9** **0** **EXE**

### (1) Linear Regression

Display the linear regression calculation result screen:

**FUNCTION** **6** (RESULT) **2** (Reg) **1** (Line)

REG	D
y=a*x+b	
a	=18.8757575
b	=4446.57575
r	=0.90479356

### (2) Distribution Logarithmic Regression

Display the logarithmic regression calculation result screen:

**EXIT** **FUNCTION** **6** (RESULT) **2** (Reg) **3** (Log)

REG	D
y=a+b*lnx	
a	=-4209.3565
b	=2425.75622
r	=0.99149312

### (3) Weight Prediction

The absolute value of correlation coefficient r is close to 1, so logarithmic regression is used for its calculation.

Obtain  $\hat{y}$  when  $x = 350$ :

**EXIT** **FUNCTION** **1** ( $\rightarrow$ COMP) **3** **5** **0** **FUNCTION** **7** (STAT)  
**2** (VAR) **▼** **▼** **▼** **7** ( $\hat{y}$ ) **EXE**

D	▲
350	
	10000.56129

# Base-*n* Calculations (BASE-N)

To perform the example operations in this section, first select BASE-N (MODE 2) as the calculation mode.

## ■ Performing Base-*n* Calculations

When you press MODE 2 to enter the BASE-N Mode, the current setup appears on the display as shown below.

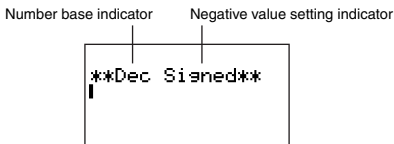

Number base indicator: Indicates the current number base (see table below).

Negative value setting indicator: Indicates whether the use of negative values is allowed (see "Changing the BASE-N Mode Negative Value Setting" on page 13).

## ▣ Specifying the Number Base

Use the keys shown below to specify the number base.



To select this number base:	Press this key:	Which displays this screen indicator:
Decimal	(DEC)	Dec
Hexadecimal	(HEX)	Hex
Binary	(BIN)	Bin
Octal	(OCT)	Oct

## ▣ Example Base-*n* Calculations

**Example:** To select binary as the number base and calculate  $1_2 + 1_2$

(BIN) 1 + 1

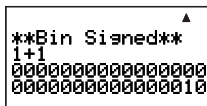

- Inputting an invalid value causes a Syntax ERROR.
- In the BASE-N Mode, input of fractional (decimal) values and exponential values is not supported. Anything to the right of the decimal point of the calculation results is cut off.

## Hexadecimal Value Input and Calculation Example

Use the following keys to input the letters required for hexadecimal values (A, B, C, D, E, F).



**Example:** To select hexadecimal as the number base and calculate  $1F_{16} + 1_{16}$

AC/ON log (HEX) 1 tan (F) + 1 EXE

```

**Hex Signed**
1F+1
00000020
    
```

## Effective Calculation Ranges

When the setup's negative value setting is "Signed"

Number Base	Effective Range
Binary	Positive: 00000000000000000000000000000000 $\leq x \leq 01111111111111111111111111111111$ Negative: 10000000000000000000000000000000 $\leq x \leq 11111111111111111111111111111111$
Octal	Positive: 0000000000 $\leq x \leq 1777777777$ Negative: 2000000000 $\leq x \leq 3777777777$
Decimal	$-2147483648 \leq x \leq 2147483647$
Hexadecimal	Positive: 00000000 $\leq x \leq 7FFFFFFF$ Negative: 80000000 $\leq x \leq FFFFFFFF$

When the setup's negative value setting is "Unsigned"

Number Base	Effective Range
Binary	00000000000000000000000000000000 $\leq x \leq 11111111111111111111111111111111$
Octal	0000000000 $\leq x \leq 3777777777$
Decimal	$0 \leq x \leq 4294967295$
Hexadecimal	00000000 $\leq x \leq FFFFFFFF$









- A Math ERROR occurs when a calculation result is outside of the applicable range for the current default number base.

## Converting a Displayed Result to another Number Base

Pressing  $\boxed{x^2}$  (DEC),  $\boxed{\log}$  (HEX),  $\boxed{\ln}$  (BIN), or  $\boxed{x^0}$  (OCT) while a calculation result is displayed will convert the result to the corresponding number base.



**Example:** To convert the decimal value 30<sub>10</sub> to binary, octal, and hexadecimal format





  (DEC)   	<pre> **Dec Signed** 30 30 </pre>
 (BIN)	<pre> **Bin Signed** 30 0000000000000000 00000000000011110 </pre>
 (OCT)	<pre> **Oct Signed** 30 000000000036 </pre>
 (HEX)	<pre> **Hex Signed** 30 0000001E </pre>

## ■ Specifying a Number Base for a Particular Value

You can specify a number base that is different from the current default number base while inputting a value.

### ◊ Specifying the Number Base during Input

Inputting a decimal value of 3, for example, can be performed using the following key operation.

  (BASE-N)	<pre> 1:d      2:h 3:b      4:o </pre>
 (d) 	<pre> **Bin Signed** d3 </pre>

## ❑ Example Calculation Using Base-*n* Specification

**Example:** To perform the calculation  $5_{10} + 5_{16}$ , and display the result in binary

AC/ON In (BIN)  
FUNCTION 1 (BASE-N) 1 (d) 5 +  
FUNCTION 1 (BASE-N) 2 (h) 5 EXE

```
▲  
**Bin Signed**  
d5+h5  
0000000000000000  
0000000000001010
```

## ■ Performing Calculations Using Logical Operations and Negative Binary Values

Your calculator can perform 32-digit (32-bit) binary logical operations and negative value calculations. All of the examples shown below are performed with binary (In (BIN)) set as the default number base.

### Note

Negative binary, octal, and hexadecimal values are produced by taking the binary two's complement and then returning the result to the original number base. With the decimal number base, negative values are displayed with a minus sign.

## ❑ Logical Product (and)

Returns the result of a bitwise product.

**Example:**  $1010_2$  and  $1100_2 = 1000_2$

1 0 1 0 FUNCTION 1 (BASE-N)  
▼ 3 (and) 1 1 0 0 EXE

```
▲  
**Bin Signed**  
1010and1100  
0000000000000000  
0000000000001000
```

## ❑ Logical Sum (or)

Returns the result of a bitwise sum.

**Example:**  $1011_2$  or  $11010_2 = 11011_2$

1 0 1 1 FUNCTION 1 (BASE-N)  
▼ 4 (or) 1 1 0 1 0 EXE

```
▲  
**Bin Signed**  
1011or11010  
0000000000000000  
0000000000011011
```

## ❑ Exclusive Logical Sum (xor)

Returns the result of a bitwise exclusive logical sum.

**Example:**  $1010_2$  xor  $1100_2 = 110_2$

1 0 1 0 FUNCTION 1 (BASE-N)  
▼ 5 (xor) 1 1 0 0 EXE

```
▲  
**Bin Signed**  
1010xor1100  
0000000000000000  
000000000000110
```

## ❑ Exclusive Logical Sum Negation (xnor)

Returns the result of the negation of a bitwise exclusive logical sum.



**Example:** To assign the values  $A = 5$ ,  $B = 3$  and  $A = 5$ ,  $B = 10$  for the expression  $3 \times A + B$

**LINE**

$\boxed{3}$   $\boxed{\times}$   $\boxed{\text{ALPHA}}$   $\boxed{i}$   $\boxed{(A)}$   $\boxed{+}$   $\boxed{\text{ALPHA}}$   $\boxed{\text{B}}$

$3 \times A + B$

$\boxed{\text{CALC}}$

(This displays the value assignment screen.)

$3 \times A + B$   
 $A = 5$   
 $B = 3$

Assign  $A = 5$  and  $B = 3$ :

$\boxed{5}$   $\boxed{\text{EXE}}$   $\boxed{3}$   $\boxed{\text{EXE}}$

$3 \times A + B$   
 $A = 5$   
 $B = 3$

Execute the calculation:

$\boxed{\text{EXE}}$

$3 \times A + B$  18

Display the value assignment screen again:

$\boxed{\text{CALC}}$

$3 \times A + B$   
 $A = 5$   
 $B = 3$

Leave  $A$  the way it is, and assign 10 to  $B$ :

$\boxed{\downarrow}$   $\boxed{1}$   $\boxed{0}$   $\boxed{\text{EXE}}$

$3 \times A + B$   
 $A = 5$   
 $B = 10$

Execute the calculation:

$\boxed{\text{EXE}}$

$3 \times A + B$  25

### Note

- If natural display is selected for the calculator's display format, the value assignment screen shows only one variable at a time.
- Use  $\boxed{\downarrow}$  and  $\boxed{\uparrow}$  to move the highlighting between variables and select the one you want to input.

### Important!

The following functions cannot be used on the value assignment screen.

- Input and display of complex numbers
- SOLVE

## Displaying Comment Text on the Value Assignment Screen

You can use the following syntax to add comment text to an expression you input with CALC: "comment text" : {calculation expression}. The comment text will appear in the top line of the value assignment screen in place of the expression.

**Example:** To use CALC and input "AREA":  $S = A \times B \div 2$ , assign the values  $A = 7$ ,  $B = 8$ , and then perform the calculation

**MATH**

SHIFT ALPHA (A) -LOCK (√) (") (i) (A) (÷) (R) (COS) (E)  
(i) (A) (√) (") SHIFT (√) (: ) ALPHA 1 (S) ALPHA RCL (=)  
ALPHA (i) (A) (X) ALPHA (B) (÷) 2

Math  
"AREA": S=A×B÷2

Math  
AREA  
A=7

Math  
S=A×B÷2  
28

7 EXE 8 EXE  
EXE

## SOLVE

SOLVE uses approximation based on Newton's Law to solve equations. SOLVE can be used only in the COMP Mode (MODE 1).

### Expressions Supported by SOLVE

SOLVE supports input of equations of the following formats

**Examples:**  $Y = X + 5$ ,  $X = \sin(M)$ ,  $X + 3 = B + C$ ,  $XY + C$  (Treated as  $XY + C = 0$ )

#### Important!

- The following is not supported by SOLVE equations.
  - Input of integration, differential,  $\Sigma$ , Pol (and Rec) functions
  - Multi-statement input
- SOLVE does not support input of complex number coefficients or display of complex number solutions.

### Using SOLVE

Inputting an equation and pressing the SOLVE key displays a "value assignment screen", which you can use to assign values to each variable. After assigning values to the variables, move the highlighting to the variable you want to solve for and then press EXE to solve.

### Using SOLVE to Solve an Equation

**Example:** To solve the equation  $y = ax^2 + b$  for  $x$ , when  $y = 0$ ,  $a = 1$ ,  $b = -2$

**MATH**

ALPHA (Y) ALPHA RCL (=) ALPHA (i) (A)  
ALPHA 0 (X) (x<sup>2</sup>) (+) ALPHA (B)

Math  
Y=AX<sup>2</sup>+B

(This displays the value assignment screen.)

**SOLVE**

$$Y=AX^2+B$$

$$Y=1$$

Assign 0 to Y:

Assign 1 to A:

Input an initial value for X (Here, input 1):

Assign -2 to B:

**0** **EXE**

**1** **EXE**

**1** **EXE**

**(-)** **2** **EXE**

$$Y=AX^2+B$$

$$X=-2$$

Specify the variable you want to solve for:

(Here we want to solve for X, so move the highlighting to X.)

**▲**

$$Y=AX^2+B$$

$$X=1$$

Solve the equation:

**SOLVE**

$$Y=AX^2+B$$

$$X=1.414213562, L \blacktriangleright$$

- Press **EXE** to return to the value assignment screen. Then you can assign different values to the variables, change the initial value, and solve again.
- An error message (Can't Solve) will appear if SOLVE is unable to solve the equation.

### Note

- If natural display is selected for the calculator's display format, the value assignment screen shows only one variable at a time.
- Use **▼** and **▲** to move the highlighting between variables and select the one you want to input.

### ☒ Scrolling the Equation on the Value Assignment Screen

If an equation is too long to fit on the variable assignment screen, you can scroll it left and right to bring other parts of it into view. To enable scrolling, press **FUNCTION** **6** (LOOK).

Use the **▶** and **◀** keys to scroll the equation right and left.

$$Y=\sin(X)+\cos(AX)$$

$$Y=0$$

To return the equation to its initial view after scrolling, press **EXIT**.

### ☒ SOLVE Precautions

- Depending on the initial value you input for the equation, SOLVE may not be able to produce a solution. If this happens, input a different initial value that you estimate is close to the actual value of the variable you are solving for, and try again.
- SOLVE may not be able to produce a solution for an equation, even though one actually exists.

• Due to the characteristics of Newton's Law, the following scientific functions tend to make it difficult to obtain solutions.

- Periodic functions (like  $y = \sin(x)$ )
- Functions that produce steep slopes when graphed (like  $y = e^x$ ,  $y = \frac{1}{x}$ )
- Discontinuous functions (like  $y = \sqrt{x}$ )

## ◆ Solution Screen Contents

The SOLVE solution screen displays the information shown below.

**LINE**

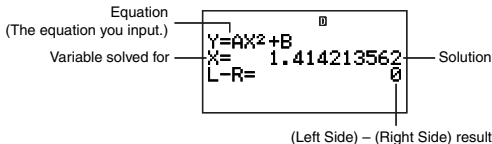

- Solutions are always displayed in decimal format.
- When natural display is selected as the calculator's display format, the two lines "X=" and "L-R" are displayed in one line. If any of the data in a line does not fit on the screen, use and to scroll.
- "(Left Side) - (Right Side) result" shows the result when the right side of the equation is subtracted from the left side, after assigning the obtained value to the variable being solved for. The closer this result is to zero, the higher the accuracy of the solution.

## ◆ Convergence in Progress Screen

The convergence in progress screen like the one shown below will appear on the display when SOLVE is unable to obtain a solution after a certain number of calculations. Pressing while this screen is displayed will resume with the calculation.

**LINE**

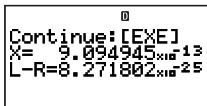

To interrupt an on-going calculation operation, press .

# Creating a Number Table from a Function (TABLE)

To perform the example operations in this section, first select TABLE ( ) as the calculation mode.

## ■ TABLE Mode Overview

The TABLE Mode lets you create an  $x$  and  $f(x)$  number table by specifying a range of values to be substituted for the function  $f(x)$  and for  $x$ .

## ❖ Expression Editor Screen

The expression editor screen appears first when you enter the TABLE Mode. You can use this screen to input the function of variable X, which will be used for generation of a number table.

### Inputting on the Expression Editor Screen

**Example:** To input  $f(x) = x^2 + \frac{1}{2}$

**MATH**

ALPHA 0 (X) x<sup>2</sup> + 1 2

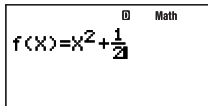

#### Note

- To clear the screen during input, press **AC/ON**.
- Any other variable other than X that is input on the expression editor screen is treated as a value (in accordance with the value currently assigned to it).

## ❖ Table Range Screen

Pressing **EXE** to register the expression you input on the expression editor screen displays the table range screen shown below.

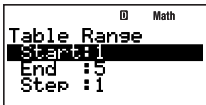

Use this screen to specify the start value (Start), end values (End), and the step (Step) of the  $x$  value, which will be used to generate the number table.

### Specifying the Start Value, End Value, and Step

1. On the table range screen, use **▼** and **▲** to move the highlighting to the setting you want to change.
2. Input the values or expressions you want.
  - To clear the screen during input, press **AC/ON**.
  - Pressing **EXIT** during input will discard everything you have input up to that point, and restores the values that were previously input on the screen.
3. After inputting everything you want, press **EXE**.
  - This registers your input. If you input expressions, the calculation result of the expression is registered.
  - While any setting is highlighted, press **EXE** to display the number table screen (page 96).

### Returning to the Expression Editor Screen from the Table Range Screen

Press **EXIT**.



## Number Table Screen

When you press **EXE** in step 3 under “Specifying the Start Value, End Value, and Step”, the calculator will perform the number table calculation in accordance with the function expression, start value, end value, and step that you have input, and display the result on the number table screen.

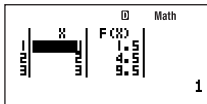

- Each of cells on the number table screen shows up to six digits of the value currently stored in the cell.
- To see the full value in a cell, move the highlighting to it. The full value contained in the cell will appear in the value display area at the bottom of the screen.
- While a value is in the value display area, you can convert it using ENG conversion (page 53), sexagesimal-decimal conversion (page 27), or decimal-fraction format conversion (page 22).
- Note, however, that you cannot input into the value display area or edit the values displayed there.

## Number Table Columns

This column:	Contains this data:
X	$x$ -values calculated in accordance with the start value, end value, and step specified on the table range screen
F(X)	Value of $x$ for the $f(x)$ value in the same line

## Returning to the Table Range Screen from the Number Table Screen

Press **EXIT**.

## Creating a Number Table

**Example:** To calculate the total principal and interest at the end of one year, three years, and five years on an original principal amount of \$100,000 with an annual interest rate of 3%, compounded annually

Total principal and interest after  $x$  years can be calculated using the formula  $100000 \times (1 + 0.03)^x$ . Input the above function, specify a start value of 1 for  $x$ , 5 for the end value, and 2 for the step, and then create the number table.

Enter the TABLE Mode:

**MODE** **7** (TABLE)

Input the function expression  $f(x) = 100000 \times (1 + 0.03)^x$ :

**1** **0** **0** **0** **0** **0** **0** **(** **1** **+** **0** **.** **0** **3** **)**  
**x<sup>^</sup>** **ALPHA** **0** **(X)**

**Math**  
**f(X) = 100000(1 + 0.03)^X**

Register the function expression:

(This displays the table range screen.)

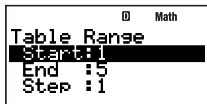

Input Start = 1, End = 5, and Step = 2:

1 [EXE] 5 [EXE] 2 [EXE]



Create the number table:

(This displays the number table screen.)

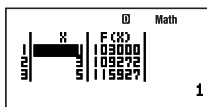

## Number Table Creation Precautions

The precautions for number table creation are identical to the RECUR Mode precautions. For more information, see “Sequence Calculation Precautions” on page 69.

# Built-in Formulas

Your calculator comes with 128 different mathematic and scientific formulas. Built-in formulas can be used only in the COMP Mode (MODE 1).

## Using Built-in Formulas

### Searching for a Built-in Formula by Inputting a Character

- Press [FMLA].
  - This displays an alphabetic menu of built-in formulas.
- Input the first letter of the name of the built-in formula you want.
  - If you want to recall the Sector Area formula for example, press [1] (S). This will jump to the section of the formula menu where the names start with the letter you specified (“S” in this example). The first formula with a name that starts with the letter will be highlighted, indicating that it is selected. Use [▼] and [▲] to scroll the highlighting to the formula you want (“Sector Area” in this example).



- The formula names that appear on the display are abbreviated due to space limitations. For a full list of formulas, their abbreviated names, and their full names, see “Built-in Formula Names” (page 99).

## 🔍 Searching for a Built-in Formula by Scrolling through the Menu

1. Press **FM/LA**.
2. Use **▼** and **▲** to scroll through the built-in formula names until the one you want to recall is selected.

## 🔍 Performing Calculation with a Built-in Formula

The following example shows how to use Heron's formula to determine the area of a triangle when the lengths of its three sides (8, 5, 5) are known.

### Operation Procedure

#### LINE

Search for Heron's formula:

**FM/LA** **]** (H) **▼** (HeronFormula)



Start the calculation:

(This displays a prompt for input of the first variable value.)

**EXE**

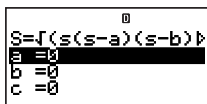

Input a = 8, b = 5, and c = 5:

**8** **EXE** **5** **EXE** **5** **EXE**

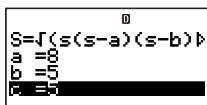

(This displays the calculation result.)

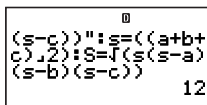

**EXE**



- As shown above, the calculation result appears after you assign values to all of the required variables.
- In the case of a formula that produces multiple results (such as  $\Delta \rightarrow Y$  Conversion), the **Disp** symbol will turn on when the first calculation result is on the display. Press **EXE** to display the other result(s) produced by the formula. The **Disp** symbol will turn off when the final result is on the display.
- Pressing **EXE** while the final calculation result is on the display (**Disp** symbol turned off) will re-execute the formula from the beginning.

## 🔍 Displaying a Built-in Formula

While a prompt for input of a value for a formula variable is on the display, you can display the entire formula by pressing **FUNCTION** **6** (LOOK).

Use the  and  keys to scroll the formula right and left.

$$S = \sqrt{(s(s-a)(s-b))}$$

$$a = 8$$

$$b = 5$$

$$c = 5$$

Press **EXIT** or **EXE** to return to the screen that was displayed before you pressed **FUNCTION** **6** (LOOK).

## Built-in Formula Names

For details about the calculation formula used by each built-in formula, see <#09> in the separate Supplement.

No.	Displayed Name	Formula Name
1	2-Line Int	Angle of Intersect for Two Straight Lines
2	Acceleration	Acceleration
3	Advance Dist	Distance of Advance
4	Area&IntAngl	Area and Interior Angle of a Triangle (3 Sides)
5	ArithProgSum	Sum of Arithmetic Progression
6	AvgGasMolSpd	Average Gaseous Molecular Speed
7	AxisMov&Rota	Movement and Rotation of a Coordinate Axis
8	Bernoulli 1	Bernoulli's Theorem (1)
9	Bernoulli 2	Bernoulli's Theorem (2)
10	Bernoulli 3	Bernoulli's Theorem (3)
11	Binomial PD	Probability Function of Binomial Distribution
12	C-PointCoord	Coordinate of a Center Point
13	CarnotCycEf1	Efficiency of Carnot's Cycle (1)
14	CarnotCycEf2	Efficiency of Carnot's Cycle (2)
15	CentriForce1	Centrifugal Force (1)
16	CentriForce2	Centrifugal Force (2)
17	ChordWarVel	Velocity of Wave Transmitted by a Chord
18	CircCone Lat	Lateral Area of a Circular Cone
19	CircCone Vol	Volume of a Circular Cone
20	CircCylinLat	Lateral Area of a Circular Cylinder
21	CircCylinVol	Volume of a Circular Cylinder
22	CircMotCyc 1	Cycle of Circular Motion (1)
23	CircMotCyc 2	Cycle of Circular Motion (2)
24	CircMotCyc 3	Cycle of Circular Motion (3)
25	Circle Area	Area of a Circle
26	ConductResis	Resistance of a Conductor
27	Cont Equa 1	Equation of Continuity (1)
28	Cont Equa 2	Equation of Continuity (2)
29	Conv Y→Δ	Y→Δ Conversion

No.	Displayed Name	Formula Name
30	Conv $\Delta \rightarrow Y$	$\Delta \rightarrow Y$ Conversion
31	Coord Calc	Coordinate Calculation (Direction Angle and Distance)
32	CosinTheorem	Cosine Theorem
33	Coulomb'sLaw	Coulomb's Law
34	Cubes Sum	Sum of Cubes
35	Current Gain	Current Gain
36	Deviation	Deviation
37	Dist&DirecAn	Distance and Direction Angle (Coordinates)
38	Doppler	Doppler Effect
39	DropDistance	Distance of Drop
40	Elastic Enr	Elastic Energy
41	ElecCap ES 1	Energy Stored in Electrostatic Capacity (1)
42	ElecCap ES 2	Energy Stored in Electrostatic Capacity (2)
43	ElecCap ES 3	Energy Stored in Electrostatic Capacity (3)
44	ElecFldEDS 1	Energy Density Stored in Electrostatic Field (1)
45	ElecFldEDS 2	Energy Density Stored in Electrostatic Field (2)
46	ElecFldStren	Strength of Electric Field
47	ElecOsciFreq	Frequency of Electric Oscillation
48	Ellipse Area	Area of an Ellipse
49	Enthalpy	Enthalpy
50	Exponent PD	Probability Function of Exponential Distribution
51	Geom PD	Probability Function of Geometric Distribution
52	GeomProg Sum	Sum of Geometric Progression
53	HeatQuantity	Quantity of Heat
54	HeronFormula	Heron's Formula
55	HyperGeom PD	Probability Function of Hyper-geometric Distribution
56	I E Force	Induced Electromotive Force
57	IdlGasStaEq1	Equation of State of Ideal Gas (1)
58	IdlGasStaEq2	Equation of State of Ideal Gas (2)
59	IdlGasStaEq3	Equation of State of Ideal Gas (3)
60	IdlGasStaEq4	Equation of State of Ideal Gas (4)
61	IncCritAngle	Critical Angle of Incidence
62	InducMagnEnr	Magnetic Energy of Inductance
63	IntsecCoord1	Intersection Coordinate (4 Points)
64	IntsecCoord2	Intersection Coordinate (3 Points and 1 Distance)
65	Joule Law 1	Joule's Law (1)
66	Joule Law 2	Joule's Law (2)
67	Kinetic Enr	Kinetic Energy
68	LC S-Cir CR	Composite Reactance in LC Series Circuit

No.	Displayed Name	Formula Name
69	LR S-Cirlmp	Impedance in LR Series Circuit
70	LRC P-Cirlmp	Impedance in LRC Parallel Circuit
71	LRC S-Cirlmp	Impedance in LRC Series Circuit
72	MagPolFrcExr	Force Exerting on Magnetic Pole
73	Magn Fld EKE	Electronic Kinetic Energy in Magnetic Field
74	Magn Force	Magnetic Force
75	MinLossMatch	Minimum Loss Matching
76	Module 1	Module (1)
77	Module 2	Module (2)
78	Module 3	Module (3)
79	Module 4	Module (4)
80	Normal Dist	Normal Distribution (Probability Density Function)
81	P-Reson Cir	Parallel Resonance Circuit
82	ParalleArea	Area of a Parallelogram
83	PlateElecCap	Electrostatic Capacity between Parallel Plates
84	Point-Line	Distance Between Point and Straight Line
85	Point-Point	Distance Between Two Points
86	Poisson PD	Probability Function of Poisson's Distribution
87	PotentialEnr	Potential Energy
88	Power Factor	Power Factor
89	Power Gain	Power Gain
90	Pyramid Vol	Volume of a Pyramid
91	Pythagorean	Pythagorean
92	Quad Area	Area of a Quadrangle (Coordinates)
93	R T-VoltChng	Change in Terminal Voltage of R in RC Series Circuit
94	RC S-Cirlmp	Impedance in RC Series Circuit
95	RadiTraverse	Radiation Traverse
96	RefracRelInd	Relative Index of Refraction
97	Repeat Combi	Repeated Combination
98	RepeatPermut	Repeated Permutation
99	Reynolds Num	Reynolds Number
100	RotatBodyEnr	Energy of Rotational Body
101	S-Reson Cir	Series Resonance Circuit
102	Scir&ArcArea	Area of a Segmental Circle and Arc (Chord and Radius)
103	Sector Area	Area of a Sector
104	ShearStress1	Shearing Stress (1)
105	ShearStress2	Shearing Stress (2)
106	Simp Pend 1	Simple Pendulum (1)
107	Simp Pend 2	Simple Pendulum (2)
108	SimpHarmMot1	Simple Harmonic Motion (1)

No.	Displayed Name	Formula Name
109	SimpHarmMot2	Simple Harmonic Motion (2)
110	SimpPendCyc	Cycle of Simple Pendulum
111	SineTheorem1	Sine Theorem (1)
112	SineTheorem2	Sine Theorem (2)
113	SineTheorem3	Sine Theorem (3)
114	Single Curve	Single Curve
115	Sound Intens	Sound Intensity
116	SphereS-Area	Surface Area of a Sphere
117	SphereVolume	Volume of a Sphere
118	SprngPendCyc	Cycle of Spring Pendulum
119	Squares Sum	Sum of Squares
120	Stadia Calc	Calculations Using a Stadia
121	T-Zoid Area	Area of a Trapezoid
122	Tension&Comp	Tension and Compression
123	Triangle 1	Area of a Triangle
124	Triangle 2	Area of a Triangle (Coordinates)
125	Uniform PD	Probability Function of Uniform Distribution
126	UnivGravitat	Law of Universal Gravitation
127	V-Line&Dist	Vertical Line and Distance (3 Points)
128	Voltage Gain	Voltage Gain

## ■ User Formulas

In addition to the calculator's built-in formula, you can also input your own formulas for later recall when you need them. You can also store built-in formulas under different names and edit their contents if you want. Formulas you create and save under the name you want are called "user formulas".

### Important!

A user formula actually is a program whose run mode is "Formula." When performing the following procedure also refer to "Program Mode (PROG)" (page 104).

### ❖ Saving a Built-in Formula Under a Different Name

- Press **[FMLA]** to display the built-in formula menu.
  - For details about this procedure, see "Using Built-in Formulas" (page 97).
- Press **[FUNCTION] [2]** (Save formula).
  - This will display the file name input screen, and automatically alpha-lock the calculator's keyboard (**[SHIFT] [ALPHA]**).

Math
File Name?
[ ]

- Enter up to 12 characters for the file name and then press **[EXE]**.
  - This saves the specified built-in formula as a program (user formula) and displays the Fmla List screen with the user formula you just saved highlighted.

- Here you can execute the user formula you just saved by pressing **EXE**.
4. Press **EXIT** to close the Fmla List screen.
  5. Press **MODE** **(5)** (PROG) to enter the PROG Mode.
  6. Press **(3)** (EDIT).
    - This displays the Prog Edit or Fmla Edit file menu.
    - If the Prog Edit file menu is displayed, press **(▶)** to change to the Fmla Edit file menu.

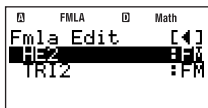
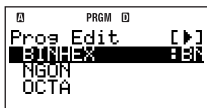

7. Use **(▼)** and **(▲)** to move the highlighting to the name of the program you entered in step 3, and then press **EXE**.
  - This displays the formula editing screen.

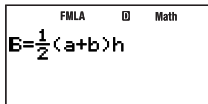

8. Use **(▶)** and **(◀)** to move the cursor around the formula, and perform the required operations to edit it.
9. After program contents are the way you want, press **EXIT**.
  - This returns to the Fmla Edit file menu.

## ❑ Creating and Saving a New Formula

1. Press **MODE** **(5)** (PROG) to enter the PROG Mode.
2. Press **(1)** (NEW).
  - This will display the file name input screen, and automatically alpha-lock the calculator's keyboard (**(SHIFT)** **(ALPHA)**).
3. Enter up to 12 characters for the file name and then press **EXE**.
  - This will register the file name and display the run mode selection screen.
4. Press **(3)** (Formula) to select the Formula Mode.
  - This displays the formula editing screen.
5. Input the formula.
  - See "Formula Editing Screen Operations" (page 104) for information about the expressions, variables, and characters that can be input.
6. After you are finished with your input, press **EXIT**.
  - This changes to the PROG Mode Fmla Edit file menu, which now displays the file name of the saved formula.

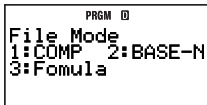

## ❑ Editing an Existing User Formula

See "Editing an Existing Program" (page 108).



## ❏ Formula Editing Screen Operations

The formula editing screen is used for saving a built-in formula under a new name, for editing a formula, and for creating a new formula. You can perform the following operations on the formula editing screen.

- The formula editing screen supports input for calculation formulas that can be input using CALC (page 90). As with CALC, you can also input comment text that appears when you display the calculation formula. For more information, see “Displaying Comment Text on the Value Assignment Screen” on page 92.
- The following types of character names can be used in a formula.
  - 1-character alphabetic or Greek character variables (like z or  $\alpha$ )
  - 2-character variables with indexes

To input a variable like this, press **FUNCTION** **4** (ALPHA) to display the menu shown below.

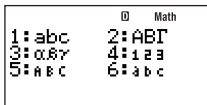

To input this character:	Press this key:
Lower-case Alphabetic	<b>1</b> (abc)
Upper-case Greek	<b>2</b> (ABΓ)
Lower-case Greek	<b>3</b> (αβγ)
Numeric Index	<b>4</b> (123)
Upper-case Alphabetic Index	<b>5</b> (ABC)
Lower-case Alphabetic Index	<b>6</b> (abc)

To input upper-case alphabetic characters, use normal upper-case input operations like **ALPHA** **i** (A).

## ❏ Performing Calculation with a User Formula

Since user formulas are saved as programs, they are executed using the same procedures as those for program execution. For details about the procedure, see “Running a Program from the Prog List or Fmla List Screen” (page 109).

Operation (assignment of values to variables) after executing a user formula is the same as those for the built-in formulas.

## Program Mode (PROG)

You can use the PROG Mode (**MODE** **5**) to create and store programs for calculations you need to perform on a regular basis. You can assign a name to a program when you store it, which simplifies recall, editing, deletion, and other file management operations.

## Program Mode Overview

### Specifying a Program Run Mode

Whenever you create a new program, you need to specify its “run mode”, which is the calculator mode where the program will run. There are three run modes: COMP, BASE-N, and Formula.

When your program contains this:	Select this run mode:
Calculations performed in the COMP Mode (including matrix, complex number, and statistical calculations)	COMP
Calculations performed in the BASE-N Mode	BASE-N
Built-in formula type calculations	Formula

The run mode of each program is indicated on file list screens (page 111). There are two types of file list screens, a “Prog List” screen that shows programs whose run mode is COMP or BASE-N, and the “Fmla List” screen that shows programs whose run mode is Formula.

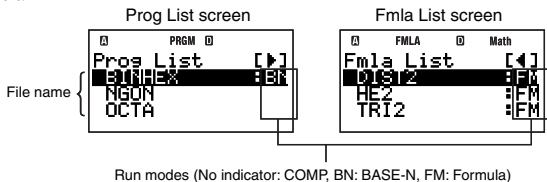

The examples use COMP or BASE-N as the run mode. For information about programs (user formulas) that use Formula as the run mode, see “User Formulas” (page 102).

### Program Memory

Your calculator has 28500 bytes of program memory.

#### Important!

The 28500-byte user memory is used for storage of extra variables and programs. This means that increasing the number of extra variables reduces the amount of memory available for storing programs. So also, storing programs in memory reduces the amount of memory available for storing extra variables.

## Creating a Program

### Creating a New Program

**Example:** To create a program that determines the surface area and volume of three regular octahedrons, the length of one side for each is 7 cm, 10 cm, and 15 cm

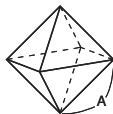

The following are the formulas for determining the surface area (S) and volume (V) of a regular octahedron when the length of one side (A) is known.

$$S = 2\sqrt{3} A^2, V = \frac{\sqrt{2}}{3} A^3$$

The following program prompts for input of A and then outputs S and V in accordance with the above programs.

```
"A" ?→A
2 × √(3) × A²
√(2) ÷ 3 × A³
```

- Specify COMP as the run mode for the program, and assign the file name "OCTAHEDRON".

## Operation Procedure

1. Press **MODE** **5** (PROG) to enter the PROG Mode.

- This displays the Program Menu screen.

```
PRGM
Program Menu
1:NEW 2:RUN
3:EDIT 4:DELETE
27482 Bytes Free
```

2. Press **1** (NEW).

- This displays the file name input screen, and automatically alpha-lock the calculator's keyboard (**SHIFT** **ALPHA**).

```
PRGM
File Name?
[ ]
```

3. Enter up to 12 characters for the file name and then press **EXE**.

- This registers the file name and displays the run mode selection screen.

```
5(O) 1(C) 2(T) i(A) (H) cos(E) sin(D)
(R) 5(O) 4(N) EXE
```

```
PRGM
File Mode
1:COMP 2:BASE-N
3:Formula
```

4. Press the number key that corresponds to the mode you want to assign as the program's run mode.

- Here, press **1** (COMP). This selects COMP as the run mode, and displays the program editing screen.

### Important!

A run mode can be assigned only when you are creating a new program. You cannot change the run mode of a program once it has been assigned.

5. Input the program.

- Here we will input the program shown below.

```
FUNCTION 3 (PROG) 1 (?) FUNCTION 3 (PROG) 2 (→) ALPHA i(A) EXE
2 X √ 3 ) X ALPHA i(A) X² SHIFT X² (▲)
√ 2 ) ÷ 3 X ALPHA i(A) X³ 3 )
```

```
PRGM
"A" ?→A
2×√(3)×A²
√(2)÷3×A³
```

- Pressing **EXE** inputs a newline symbol (↵).

6. After you finish inputting the entire program, press **[EXIT]**.
- This will display the Prog Edit file menu (page 108).  
The name of the program you just input will be highlighted (selected) on the screen.



7. Try running the program you just created (OCTAHEDRON). Press **[EXIT]** to display the Program Menu screen, and then press **[2]** (RUN).
- This displays the Prog List screen. Pressing **[EXE]** will run the program whose name is currently highlighted (selected) on the Prog List screen.



8. Since "OCTAHEDRON" is already highlighted, simply press **[EXE]** to run it.  
Run the program:



(This will display a prompt for input of a value for variable A.)

Input 7 for A:

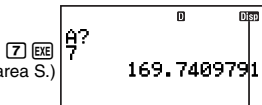

(This displays the calculated result of surface area S.)

The **▲** command in the program causes it to pause and display the calculation result up to that point.

Resume the program to perform the next calculation:

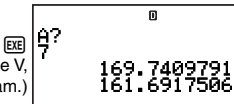

(This displays the calculated result of volume V, and ends the program.)

9. To calculate the surface area and volume of the second octahedron, press **[EXIT]** or **[EXE]** to return to the Prog List screen, and repeat step 8, inputting 10 for A. Do this one more time for the third octahedron, inputting 15 for A.
- You can return to the normal calculation screen by pressing **[MODE]** **[1]** (COMP) to enter the COMP Mode any time at the end of step 8.

## Note

- If the file name you input in step 3 of the above procedure is already used by another program, pressing **[EXE]** will display the editing screen for the existing program.
- There are a number of different ways to run a program in addition to the method described in this procedure. For more information, see "Running a Program" (page 109).

## Program Commands

Selecting **FUNCTION** – {PROG} on the program editing screen will display a menu of program commands that you can use for command input.

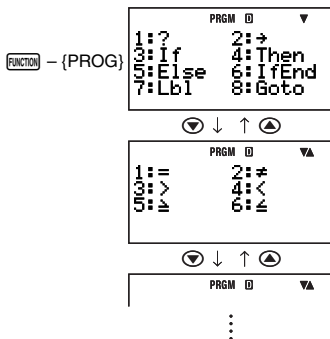

### Note

- The program commands that appear on the menu for input depend on the program run mode. For more information, see the “Command Reference” (page 113).
- You can also use the above procedure to input commands while the COMP Mode or BASE-N Mode calculation screen is on the display. Note, however, that only the variable assignment command (→) can be input in the COMP Mode when natural display is selected for the display format setting.
- Certain commands cannot be input on the BASE-N Mode calculation screen. For more information, see the “Command Reference” (page 113).

## Editing an Existing Program

1. Press **MODE** **[5]** (PROG) **[3]** (EDIT).
  - This displays the Prog Edit or Fmla Edit file menu.
2. Press **▶** or **◀** to switch between the Prog Edit and Fmla Edit file menu.

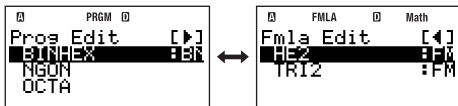

To edit a program with this run mode:	Display this screen:
COMP or BASE-N	Prog Edit file menu
Formula	Fmla Edit file menu

3. Use **▼** and **▲** to move the highlighting to the name of the program you want to edit and then press **EXE**.
  - This displays the program editing screen.

- Use **▶** and **◀** to move the cursor around the program, and perform the required operations to edit the contents of the program or to add new contents.
  - You can press **[SHIFT] ▲** to jump to the beginning of the program, while **[SHIFT] ▼** jumps to the end.
- After program contents are the way you want, press **[EXIT]**.

## ■ Running a Program

An existing program can be executed from the COMP Mode, BASE-N Mode, or PROG Mode.

### Note

- If you run a program from the PROG Mode, pressing **[EXE]** or **[EXIT]** after the program is complete will return to the Prog List or Fmla List screen. Since the name of the program you just ran will be highlighted on the Prog List or Fmla List screen, you can run it again by pressing **[EXE]**.
- If you run a program from the COMP Mode or BASE-N Mode, pressing **[EXE]** after the program is complete will run the same program again. Pressing **[EXIT]** will not perform any operation.
- To interrupt ongoing program execution, press **[AC/ON]**.

## ◀ Running a Program from the Prog List or Fmla List Screen

- Perform either of the following operations.
  - While the Program Menu screen is on the display in the PROG Mode, press **[2]** (RUN).
  - In the COMP or BASE-N Mode, press **[FILE]**.
 This displays the Prog List screen or Fmla List screen.
- Press **▶** or **◀** to switch between the Prog List and Fmla List screen.

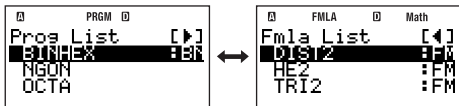

To run a program with this run mode:	Display this screen:
COMP or BASE-N	Prog List screen
Formula	Fmla List screen

- Use **▼** and **▲** to move the highlighting to the name of the program you want to run and then press **[EXE]**.
  - This runs the program.

### Note

After you run a program, you can press the **[AC/ON]** key to manually interrupt program execution. This displays a screen like the one shown below.

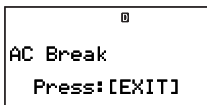

Pressing **EXIT** will display the program editing screen, with the cursor located at the point where execution was interrupted.

## Using the Prog Command to Run a Program

The Prog command can be used to specify a program file name and run that program directly from the COMP Mode or BASE-N Mode. Perform the procedure below in the COMP Mode or BASE-N Mode.

### Important!

An error (Go ERROR) will occur if there is no program with the file name you specify with the Prog command.

**Example:** To use the Prog command to execute the program named "OCTAHEDRON"

#### LINE

AC/ON SHIFT FILE (Prog) Prog |

SHIFT ALPHA (A-LOCK) ["] ("")
   
5 (O) ←→ (C) 2 (T) i (A) ] (H) cos (E)
   
sin (D) ⇄ (R) 5 (O) 4 (N) ["] ("")

(This runs the program.)

Prog |

Prog "OCTAHEDRON" |

Prog "OCTAHEDRON" |
  
A?

## What to do if an error message appears

If an error message appears, you can press any one of the following keys to clear it: **EXIT**, **◀**, or **▶**. What happens next depends on the calculator mode from which you are trying to run the program.

### COMP Mode or BASE-N Mode

Either of the following screens will appear, depending on how you executed the program.

If you executed the program this way:	This screen will appear:
Using the Prog command	<p> <span>Prog</span> <span>"OCTA"</span> <span> </span> </p> <p>The cursor is located at the end of the name of the program file that was being run.</p>
From the Prog List screen	
From the Fmla List screen	<p> <math display="block">I = \frac{V}{R}</math> <span> </span> </p> <p>The cursor is located at the end of the user formula.</p>

Now you can enter the PROG Mode and display the program editing screen of the program where the error occurred, and correct the cause of the error.

## Note

The mode that the calculator will enter automatically when you clear an error message depends on the program's run mode, as shown below.

Program Run Mode	Calculation Mode
COMP Mode or Formula Mode	COMP Mode
BASE-N Mode	BASE-N Mode

## PROG Mode

Clearing an error message will display the editing screen for the program, with the cursor located at the location where the error was generated so you can correct the problem.

## File Screen Operations

The Program Menu of the PROG Mode lets you select from among the following screens.

- **Prog List** screen/**Fmla List** screen: [2] (RUN)  
Use these screens to select a program or user formula, and run it.
- **Prog Edit** file menu/**Fmla Edit** file menu: [3] (EDIT)  
Use these menus to select a program or user formula, and edit it.
- **Prog Delete** file menu/**Fmla Delete** file menu: [4] (DELETE) [1] (One File)  
Use these menus to select a program or user formula, and delete it.

All of the operations in this section can be performed while any one of the above screens is on the display.

### Important!

The operations in this section assume that one of the six file screens is already on the display.

## Searching for a Program

### Searching for a File Name by Inputting a Character

On a file screen, input the first letter of the name of the program you want.

**Example:** To search for the file named "OCTAHEDRON"

Press [5] (O).

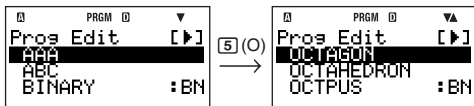

This will jump to the section of the file screen where the names start with the letter you specified ("O" in this example). The first program with a name that starts with the letter will be highlighted, indicating that it is selected. You can use [DOWN] and [UP] to scroll the highlighting to the program you want ("OCTAHEDRON" in this example).

### Searching for a Program by Scrolling through the List

On a file screen, use [DOWN] and [UP] to scroll through the program names until the one you want is highlighted.



## ❑ Adding a File Name to “Favorites”

You can add the file name of an often-used program to “Favorites”, which will cause the name to be displayed at the top of the file screens.

### Operation Procedure

1. On a file screen, highlight the name of the file you want to add to “Favorites”.
2. Press **FUNCTION** **1** (Favorite-Add).
  - This displays the file name at the top of the file screens.



### Note

- A file name added to “Favorites” is displayed both at the top of the file screens, and at its normal alphabetic location in the file screens.
- The names of the files in “Favorites” are not checked when you search for a file by inputting the first character of its file name.
- “Favorites” file names at the top of the file screens are separated from the other names by a line.
- File name added to “Favorites” are displayed in the order they are added (not in alphabetical order).

## ❑ Removing a File Name from “Favorites”

1. In the “Favorites” file name list (above the separator line) of a file screen, highlight the file name you want to remove.
2. Press **FUNCTION** **1** (Favorite-Off).

## ❑ Renaming a Program File

1. On a file screen, select the name of the file you want to rename.
2. Press **FUNCTION** **2** (Rename).
  - This displays a file name input screen.
3. Input the new name and then press **EXE**.

### Important!

An error message will appear if the file name you input already used for another program. If this happens, press **AC/ON**, **EXIT**, **◀**, or **▶** to return to the file name input screen, and input a different name.

## ■ Deleting a Program

### ❑ Deleting a Specific Program

1. Press **MODE** **5** (PROG) **4** (DELETE) **1** (One File).
  - This displays the Prog Delete or Fmla Delete file menu.
2. Press **▶** or **◀** to switch between the Prog Delete and Fmla Delete file menu.

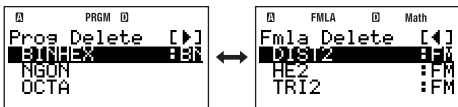

To delete a program with this run mode:	Display this screen:
COMP or BASE-N	Prog Delete file menu
Formula	Fmla Delete file menu

- Use and to move the highlighting to the name of the program you want to delete and then press **EXE**.
  - This will cause the "Delete File?" confirmation message to appear.
- To delete the specified program, press **EXE** (Yes). To cancel the operation without deleting anything, press **EXIT** (No).

## ❖ Deleting All Programs

- Press **MODE** **5** (PROG) **4** (DELETE) **2** (All Files).
  - This will cause the "Delete All Files?" confirmation message to appear.
- To delete all programs currently stored in calculator memory, press **EXE** (Yes). To cancel the operation without deleting anything, press **EXIT** (No).

# Command Reference

This section provides details on each of the commands that you can use in programs.

## Note

- When you see <variable> in a command syntax, it specifies any variable from A to Z, or an array (like Z[5]).
- When inputting commands on the program editing screen, you can use a newline symbol () or output command () in place of any separator code (:) within a syntax or example. To input a <newline> character into the program editing screen, press **EXE**.
- Except for the separator code (:) and output command (), none of the commands explained in this reference can be input into a program (user formula) that uses Formula as the run mode. For information about creating a user formula, see "User Formulas" on page 102.

## ■ Program Commands

There are two types of program commands: Those you input from the menu that appears when you select **FUNCTION** – {PROG}, and those you input using key operations: separator code (:) (**SHIFT** ), output command () (**SHIFT** ), and Prog (**SHIFT** **FILE**). This section provides details for each program command.

## Note

"(COMP)" to the right of a command name indicates a command that can be input only into a program that uses COMP as the run mode or onto the COMP Mode calculation screen (while linear display is selected as the display format).

## ❖ Basic Operation Commands

**:** (Separator Code)

(**SHIFT** )

Syntax <statement> : <statement> : ... : <statement>

Function Separates statements. Does not stop program execution.

Example ?  $\rightarrow$  A : A<sup>2</sup> : Ans<sup>2</sup>

### ▲ (Output Command)

(SHIFT) (x<sup>2</sup>)

Syntax <statement> ▲ <statement>

Function Pauses program execution and displays the result of the current execution. The **Disp** symbol is turned on while program execution is paused by this command.

Example ?  $\rightarrow$  A : A<sup>2</sup> ▲ Ans<sup>2</sup>

Note Program execution paused by the ▲ command can be resumed by pressing the **EXE** key, which will resume execution from the command following the ▲ command.

### ? (Input Prompt)

Syntax 1 ?  $\rightarrow$  <variable>

"<character string>?"  $\rightarrow$  <variable>

Function 1 Assigns a value to a variable. An input prompt "?" or "<character string>?" appears on the display when program execution reaches this command.

Example 1 ?  $\rightarrow$  A

Syntax 2 ?<variable>

"<character string>?"<variable>

Function 2 Assigns a value to a variable. The input prompt "<variable>?" or "<character string>?" appears on the display when program execution reaches this command.

Unlike the ?  $\rightarrow$  <variable> syntax, this syntax displays the current value of the variable along with prompt. If **EXE** is pressed without inputting anything in response to the prompt, program execution will proceed using the current value of the variable.

Example 2 ? A

### $\rightarrow$ (Variable Assignment)

Syntax <expression>  $\rightarrow$  <variable>

Function Assigns the value obtained by the element on the left to the variable on the right.

Example A + 5  $\rightarrow$  A

## ◻ Relational Operators

=,  $\neq$ , >,  $\geq$ , <,  $\leq$

Syntax <expression> <relational operator> <expression>

Function These commands evaluate the expressions on either side and return a value of true (1) or false (0). These commands are used in combination with the branching command  $\Rightarrow$ , and when structuring the <conditional expression> of If, While, and Do statements.

Example See the entries for  $\Rightarrow$  (page 115), If statement (page 116), While statement (page 117) and Do statement (page 117).

Note These commands evaluate the expressions on either side, and return 1 if true and 0 if false.

## Jump Commands

### Goto ~ Lbl

Syntax Goto  $n$  : ... : Lbl  $n$  or Lbl  $n$  : ... : Goto  $n$  ( $n$  is an integer from 0 to 9, or a variable name from A through Z.)

Function Execution of Goto  $n$  jumps to corresponding Lbl  $n$ .

Example ? → A : Lbl 1 : ? → B : A × B ÷ 2 ▲ Goto 1

Important! A Go ERROR occurs if there is no corresponding Lbl  $n$  in the same program where Goto  $n$  is located.

### Dsz (Decrement and Skip on Zero)

Syntax Dsz <variable> : <statement 1> : <statement 2> : ...

Function Decrements the value of <variable> by one. Then if the <variable> value is non-zero, <statement 1> is executed, followed by <statement 2> and everything after it in succession. If the <variable> value is zero, <statement 1> is skipped, and <statement 2> and everything after it is executed.

Example 10 → A : 0 → C : Lbl 1 : ? → B : B + C → C : Dsz A : Goto 1 : C ÷ 10

### Isz (Increment and Skip on Zero)

Syntax Isz <variable> : <statement 1> : <statement 2> : ...

Function Increments the value of <variable> by one. Then if the <variable> value is non-zero, <statement 1> is executed, followed by <statement 2> and everything after it in succession. If the <variable> value is zero, <statement 1> is skipped, and <statement 2> and everything after it is executed.

⇒

Syntax ① <expression> <relational operator> <expression> ⇒ <statement 1> : <statement 2> : ...

② <expression> ⇒ <statement 1> : <statement 2> : ...

Function This is a conditional branching command. Conditional branching command used in combination with relational operators (=, ≠, >, ≥, <, ≤).

Syntax ①: <statement 1> is executed if the condition to the left of the ⇒ command is true, and then <statement 2> and everything after it is executed in sequence. <statement 1> is skipped if the condition to the left of the ⇒ command is false, and then <statement 2> and everything after it is executed.

Syntax ②: A non-zero evaluation result of the condition to the left of the ⇒ command is interpreted as "true", so <statement 1> is executed, followed by <statement 2> and everything after it in succession. A zero evaluation result of the condition to the left of the ⇒ command is interpreted as "false", so <statement 1> is skipped, and <statement 2> and everything after it is executed.

Example      Lbl 1 : ? → A : A ≥ 0 ⇒ √(A) ▲ Goto 1

## ❖ Control Structure Commands: If Statements

The If statement is used to control program execution branching according to whether the expression following If (which is the branching condition) is true or false.

### If Statement Precautions

- An If statement must always be accompanied by a Then statement. Using an If without a corresponding Then will result in a Syntax ERROR.
- An expression, Return, or Stop command can be used for the <expression\*> following Then and Else.

<b>If ~ Then (~ Else) ~ IfEnd</b>
-----------------------------------

Syntax      If <conditional expression> : Then <expression\*> : Else <expression\*> : IfEnd : <statement> : ...

- Function
- The statements following Then are executed up to Else, and then the statements following IfEnd are executed when the conditional statement following If is true. The statements following Else and then the statements following IfEnd are executed when the conditional statement following If is false.
  - “Else<expression>” may be omitted.
  - Always include the “IfEnd”. Omitting it will not cause an error, but certain program contents can cause unexpected execution results by everything after the If statement.

Example 1    ? → A : If A < 10 : Then 10A ▲ Else 9A ▲ IfEnd : Ans×1.05

Example 2    ? → A : If A > 0 : Then A×10 → A : IfEnd : Ans×1.05

## ❖ Control Structure Commands: For Statements

The For statement repeats execution of the statements between For and Next as long as the value assigned to the control variable is within the specified range.

### For Statement Precautions

A For statement must always be accompanied by a Next statement. Using a For without a corresponding Next will result in a Syntax ERROR.

<b>For ~ To ~ Next</b>
------------------------

(COMP)

Syntax      For <expression (start value)> → <variable (control variable)> To <expression (end value)> : <statement> : ... <statement> : Next : ...

- Function
- Execution of the statements from For to Next repeats as the control variable is incremented by 1 with each execution, starting from the starting value. When the value of the control value reaches the ending value, execution jumps to the statement following Next. Program execution stops if there is no statement following Next.

Example      For 1 → A To 10 : A<sup>2</sup> → B : B ▲ Next

**For ~ To ~ Step ~ Next**

(COMP)

Syntax	For <expression (start value)> → <variable (control variable) > To <expression (end value)> Step <expression (step value)> : <statement> : ... <statement> : Next : ...
Function	Execution of the statements from For to Next repeats as the control variable is incremented by the step amount with each execution, starting from the starting value. Except for that, this command is the same as For~To~Next.
Example	For 1 → A To 10 Step 0.5 : A <sup>2</sup> → B : B ▲ Next

**❏ Control Structure Commands: While Statements****While ~ WhileEnd**

(COMP)

Syntax	While <conditional statement> : <statement> : ... <statement> : WhileEnd : ...
Function	The statements from While to WhileEnd are repeated while the conditional expression following While is true (non-zero). When the conditional expression following While becomes false (0), the statement following WhileEnd is executed.
Example	? → A : While A < 10 : A <sup>2</sup> ▲ A + 1 → A : WhileEnd : A ÷ 2
Note	<ul style="list-style-type: none"><li>• If the condition of the While statement is false the first time this command is executed, execution jumps directly to the statement following WhileEnd without executing the statements from While to WhileEnd even once.</li><li>• To input the WhileEnd command, select "W·End" on the function menu.</li></ul>

**Do ~ LpWhile**

(COMP)

Syntax	Do : <statement> : ... <statement> : LpWhile <conditional statement>
Function	The statements from Do to LpWhile are repeated while the conditional expression following LpWhile is true (non-zero). Since the condition is assessed following execution of LpWhile, the statements from Do to LpWhile are executed at least once.
Example	Do : ? → A : A × 2 → B : B ▲ LpWhile B > 10
Note	To input the LpWhile command, select "Lp·W" on the function menu.

**❏ Subroutine Call Commands****Prog**

(SHIFT FILE)

Syntax	... : Prog "file name" : ...
--------	------------------------------

Function Executes another separate program (subroutine) from the current program (main routine).

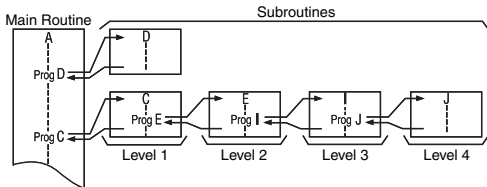

- A subroutine can be called up as many times as you like from the main routine. A subroutine can be called up from any number of main routines.
- Execution of the Prog "file name" command jumps to the subroutine and runs it from the beginning. When the end of the subroutine is reached, processing jumps back to the main routine and continues from the statement following the Prog "file name" command.
- You can use the Prog command inside of a subroutine to cause process to jump to another subroutine. This is called "nesting". You can nest subroutines up to 10 levels. Attempting to nest more than 10 levels causes an error (Ne ERROR).
- Note that a Goto ~ Lbl jump within a subroutine can be performed only within the same subroutine.
- An error (Go ERROR) will occur if the program specified by the Prog "file name" command cannot be found for some reason.

#### Important!

- A program that uses Formula as the run mode cannot be used as a subroutine.
- The main routine and the subroutine must be the same run mode. This means, for example, that a subroutine that is a program whose run mode is BASE-N cannot be called by a main routine that is a program whose run mode is COMP.

Example Ans → A : Prog "SUB1" : Prog "SUB2"

Note For information about using the Prog command outside of the PROG Mode, see "Using the Prog Command to Run a Program" (page 110).

## ❑ Program Control Commands

**Break**

(COMP)

Syntax ... : Break : ...

Function This command forces a break in a For, While, or Do loop, and jumps to the next command. Normally, this command is used inside of a Then statement in order to apply a Break condition.

Example While A > 0 : If A > 2 : Then Break : IfEnd : WhileEnd : A ▲

**Return**

(COMP)

Syntax ... : Return : ...

Function Returns from a subroutine to the program from the program that called the subroutine. In a main routine, this command terminates the program.

Example Main Routine Subroutine (File Name: SB)  
 1 → A : Prog "SB" : C ▲ For A → B To 10 :  
 B + 1 → C : Next : Return

**Stop**

(COMP)

Syntax ... : Stop : ...

Function Forces termination of program execution. Execution of this command in a subroutine terminates all execution, including all subroutines and the main routine.

Example For 2 → A To 10 : If A=5 : Then "STOP" : Stop : IfEnd : Next

**Input/Output Commands****Getkey**

Syntax ... : Getkey : ...

Function Returns one of the codes shown below, which corresponds to the last key pressed. 0 is returned when no key was pressed.

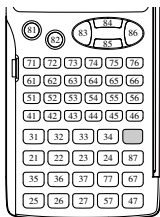

Note The Getkey command can be inserted into an expression the same as a mathematical function.

Example Do : Cls : Locate 1,1, Ran# : Locate 1,2, "PRESS 0" : LpWhile Getkey ≠ 25

**Display Screen Commands**

" "

Syntax ... : "&lt;character string&gt;" : ...

Function Displays the alphanumeric characters, command, or other text enclosed in the quotation marks (" ") as comment text.

If there are more than 16 characters, the text is wrapped to the next line. If the current line is the bottom line on the screen, screen contents will scroll upwards when text wrapping is performed.



**Cls**

Syntax ... : Cls : ...

Function Clears all expressions and calculation results from the display.

**Locate**

Syntax Locate <column number> , <row number> , <value>  
 Locate <column number> , <row number> , <expression>  
 Locate <column number> , <row number> , "<character string>"  
 ( $1 \leq \text{row number} \leq 4$ ,  $1 \leq \text{column number} \leq 16$ )

Function Displays the specified value or character string at the specified screen location.

- Screen location is specified as (<column number>, <line number>), with the location of the upper left corner being (1, 1) and the lower right corner (16, 4). An error (Argument ERROR) occurs if you specify a location that is outside of the range defined above.
- Specifying <expression> will cause the result of the expression to appear at the specified location. If the expression is a variable, the value assigned to the variable will appear. Note that an error (Math ERROR or Syntax ERROR) will occur if the calculation result is a complex number, list, or matrix.

Example Locate 5 , 2 , "CASIO fx"

**◻ Logical Operator Commands****And**

(COMP)

Syntax <expression> And <expression>

Function Evaluates the expressions (equality or inequality) on either side and returns true or false based on their logical product.

Example ? → A : ? → B : If A = 2 And B > 0 : Then A ÷ B : Else B : IfEnd

**Or**

(COMP)

Syntax <expression> Or <expression>

Function Evaluates the expressions (equality or inequality) on either side and returns true or false based on their logical sum.

Example While A < 10 Or B < 5 : A + B ▲ A + 1 → A : B + 1 → B : WhileEnd

**Not**

(COMP)

Syntax Not <expression>

Function Evaluates the expression (equality or inequality) immediately following and returns its negation.

Example Do : ? → A : A × 2 → B : B ▲ LpWhile Not B < 10



### Important!

List X, List Y, and List Freq correspond respectively to the X-column, Y-column, and the FREQ-column of the STAT Mode's STAT editor screen.

Function

The List command is used in combination with X (ALPHA  $\square$ ), Y (ALPHA  $\square$ ), Freq (FUNCTION) – {STAT}  $\square$  (LIST)  $\square$  to perform the operations described in parentheses, above.

Example

① ?  $\rightarrow$  A : {A , A + 2 , A + 3}  $\rightarrow$  List X

② ?  $\rightarrow$  A : ?  $\rightarrow$  B : A  $\rightarrow$  List Y [B]

③ ?  $\rightarrow$  A : List X [A]  $\blacktriangle$  List X [A + 1]

## ◀ Regression Commands: (FUNCTION) – {STAT} $\square$ (Reg)

LinearReg, etc.

(COMP)

Syntax

... : LinearReg : ... (Linear Regression)  
... : QuadReg : ... (Quadratic Regression)  
... : LogReg : ... (Logarithmic Regression)  
... : eExpReg : ... (*e* Exponential Regression)  
... : abExpReg : ... (*ab* Exponential Regression)  
... : PowerReg : ... (Power Regression)  
... : InverseReg : ... (Inverse Regression)

Function

These commands perform the specified regression calculation based on the data input in the STAT editor (List X, List Y, List Freq). The screens that appear when these commands are executed are identical to those described under "Displaying Regression Calculation Results" (page 78).

## ■ Other PROG Mode Commands

This section describes commands that can be used in the PROG Mode only. Note that each command can be used only in a program that uses the run mode indicated by "(COMP)" or "(BASE-N)" to the right of the command names.

## ◀ Setup Commands

These commands function the same way as the calculator's various setup settings. For more information, see "Calculator Setup" on page 11.

### Important!

With some setup commands, the settings you configure remain in effect even after you finish running the program.

## Angle Unit Setting Commands

Deg, Rad, Gra

(COMP)

Syntax

... : Deg : ...  
... : Rad : ...  
... : Gra : ...

Function

These commands specify the angle unit setting.

## Display Format Setting Commands

### Fix

(COMP)

Syntax ... : Fix < $n$ > : ... ( $n$  is an integer from 0 to 9.)  
Function Fixes the number of decimal places (from 0 to 9) for output of calculation results.

### Sci

(COMP)

Syntax ... : Sci < $n$ > : ... ( $n$  is an integer from 0 to 9.)  
Function Fixes the number of significant digits (from 1 to 10) for output of calculation results. 0 for  $n$  (Sci 0) will specify 10 significant digits.

### Norm

(COMP)

Syntax ... : Norm <1 ; 2> : ...  
Function Specifies either Norm 1 or Norm 2 for output of calculation results.

### ab/c, d/c

(COMP)

Syntax ... : ab/c : ...  
... : d/c : ...  
Function Specifies whether mixed fraction format (ab/c) or improper fraction format (d/c) should be used as the display format for a calculation results.

### EngOn, EngOff

(COMP)

Syntax ... : EngOn : ...  
... : EngOff : ...  
Function These commands turn engineering symbols on (EngOn) or off (EngOff).

### a+bi, $r\angle\theta$

(COMP)

Syntax ... : a+bi : ...  
... :  $r\angle\theta$  : ...  
Function Specifies whether rectangular coordinate format ( $a+bi$ ) or polar coordinate format ( $r\angle\theta$ ) should be used as the display format for a complex number calculation results.

## Statistical Frequency Setting Command

### FreqOn, FreqOff

(COMP)

Syntax ... : FreqOn : ...  
... : FreqOff : ...  
Function These commands turn statistical frequency on (FreqOn) or off (FreqOff).

## ◆ Base-*n* Commands

Dec, Hex, Bin, Oct

(BASE-N)

Syntax ... : Dec : ... / ... : Hex : ... / ... : Bin : ... / ... : Oct : ...

Function These commands specify the number base for Base-*n* calculations.

Signed, Unsigned

(BASE-N)

Syntax ... : Signed : ...  
... : Unsigned : ...

Function These commands specify whether Base-*n* calculation values are signed (negative values allowed) or unsigned (negative values not allowed).

## ◆ Rounding (Rnd) Command

Rnd(

(COMP)

Syntax ... : <expression> : Rnd(Ans : ...

Function Rounds the calculation result currently in Ans to the number of digits specified by the display format setting.

# Data Communication (LINK)

Data communication can be used to transfer program data between two fx-5800P calculators.

## ■ Connecting Two fx-5800P Calculators to Each Other

An optionally available data communication cable (SB-62) is required to connect two calculators.

### ◆ Connecting the Calculators

Connect the data communication cable as shown in the illustration below.

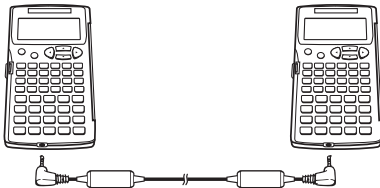

## ■ Transferring Data Between fx-5800P Calculators

After connecting the two fx-5800P calculators, perform the procedure below to transfer data.

## ☒ Transferring All Programs

1. Perform the following operation on the receiving calculator (Receiver).

**MODE** ▼ **1** (LINK) **2** (Receive)

Receivins...  
Cancel:[AC]

- This will put the Receiver into receive standby, which is indicated by "Receiving..." on its display.

2. Perform the following operation on the sending calculator (Sender).

**MODE** ▼ **1** (LINK) **1** (Transmit) **1** (All)

Transmit OK?  
Yes:[EXE]  
No:[EXIT]

3. To start data transfer, press the Sender's **EXE** key.

- During data transfer, the screen of the Sender will show the message shown to the right. The screen of the Receiver continues to shows the screen that appeared in step 1.

Transmittins...  
Cancel:[AC]

- After data transfer is complete, the screen of the both the Sender and Receiver will change to the message shown to the right.

Complete!  
Press:[EXIT]

## ☒ Transferring Specific Programs

1. Perform the following operation on the receiving calculator (Receiver) to put it into receive standby.

**MODE** ▼ **1** (LINK) **2** (Receive)

Receivins...  
Cancel:[AC]

2. On the sending calculator (Sender), perform the following operation.

**MODE** ▼ **1** (LINK) **1** (Transmit) **2** (Select)

Select Data ▼  
AAA  
BBB  
[1]:SEL [0]:TRAN

- On the Sender, use  $\blacktriangledown$  and  $\blacktriangle$  to move the highlighting to the program you want to transfer, and then press  $\boxed{1}$  (SEL).
  - This will cause a "▶" mark to appear to the left of the file name, indicating that it is selected for transfer. Each press of  $\boxed{1}$  (SEL) will toggle display of the "▶" mark next to the file name on (selected) and off (not selected).
  - Repeat step 3 until there is a "▶" mark next to the names of all the programs you want to transfer.
- After selecting all the files you want, press  $\boxed{0}$  (TRAN) on the Sender.
  - This will cause "Transmit OK?" to appear on the Sender's display.
- To start transfer of the programs, press  $\boxed{EXE}$  on the Sender.
  - During data transfer, the screen of the Sender will show the message shown to the right. The screen of the Receiver continues to show the screen that appeared in step 1.
  - After data transfer is complete, the screen of both the Sender and Receiver will change to the message shown to the right.

```
Transmitting...
Cancel: [AC]
```

```
Complete!
Press: [EXIT]
```

## ❖ Interrupting an Ongoing Data Transfer Operation

On either the sending or receiving fx-5800P calculator, press  $\boxed{AC/ON}$ .

## ❖ When there is already a program with the same file name on the receiving calculator

If the sending calculator (Sender) finds that the receiving calculator (Receiver) already has a program with the same name in its memory during data transfer, the Sender will display a message like the one shown to the right.

```
Already Exists
[AAA ]
Overwrite?
[1]:Yes [0]:No
```

To overwrite the program currently in Receiver memory with the program being transferred from the Sender, press  $\boxed{1}$  (Yes). If you do not want to overwrite the file in Receiver memory, press  $\boxed{0}$  (No). This will cause transfer of the applicable program to be skipped and start transfer of the next program.

# Memory Manager (MEMORY)

Memory Manager is a tool for deleting data stored in the memory of your calculator.

## Note

Here, the term "delete" has the following meanings.

- Initialization of Alpha Memory (to zeros) and Setup
- Deletion of all other data type and memory files

To perform the example operations in this section, first select MEMORY (MODE) (2) as the mode.

- This will display the Memory Manager screen, which provides a menu of the different types of data in memory.

```
Memory Manager
Setup
Alpha Memory
[1]:SEL [0]:DEL
```

## Deletable Data Types and Supported Delete Operations

The following lists the types of data you can delete using Memory Manager.

Data Type	Data Name	Supported Delete Operations
Programs	<PROGRAM>	Delete all or delete specific
User Formulas	<FORMULA>	Delete all or delete specific
Formula Variables	<FMLA Variable>	Delete all or delete specific
Matrix Data	<MATRIX>	Delete all or delete specific
Setup	Setup	Delete all
Variables	Alpha Memory	Delete all
Extra Variables	DimZ Memory	Delete all
Statistical Sample Data	STAT	Delete all
Recursion Data	Recursion	Delete all
Table Data	Table	Delete all
Equation Data	Equation	Delete all

- The "Data Name" column of the above table shows the data name that appears on the Memory Manager menu.
- Angle brackets (< >) around a data name indicates a data folder that supports both delete all and delete specific. Delete all deletes all of the data in the applicable folder, while delete specific deletes specific data items selected by you.

## Using Memory Manager

### Selecting the Data You Want to Delete

- Use (down arrow) and (up arrow) to move the highlighting to the name of the data or data folder you want to delete.
- Press (1) (SEL).

- This will cause a "▶" mark to appear to the left of the name, indicating that it is selected for deletion.

```
Memory Manager
▶Setup
Alpha Memory
[1]:SEL [0]:DEL
```

- Each press of (1) (SEL) will toggle display of the "▶" mark next to the name on (selected) and off (not selected).
- A data name enclosed in angle brackets (< >) indicates a data folder. Selecting a data folder here will delete all of the data in the folder.



3. Repeat steps 1 and 2 as required to select all of the data names you want.

### ❖ Selecting Specific Data Items within a Folder

1. Use  $\blacktriangledown$  and  $\blacktriangle$  to move the highlighting to the name of the data folder that contains the data want to delete.



2. Press  $\text{EXE}$  to enter the folder.

- This will display a menu of all the data items contained in the folder.



3. Use  $\blacktriangledown$  and  $\blacktriangle$  to move the highlighting to the name of the data you want to delete, and then press  $\text{T}$  (SEL).

- This will cause a "▶" mark to appear to the left of the name, indicating that it is selected for deletion.

4. Repeat step 3 as required to select all of the data names you want.

5. To exit the folder and return to Memory Manager screen, press  $\text{EXIT}$ .

#### Note

- If a folder name is selected (which is indicated when "▶" is in front of it) on the Memory Manager screen, all of the data inside the folder will be selected for deletion when you enter the folder in step 2 of the above procedure.
- When you enter a folder in step 2 of the above procedure, all currently selected data (except for the folder itself) becomes deselected automatically.
- The data you select inside of a folder becomes deselected when you exit the folder.

### ❖ Deleting the Currently Selected Data

After using the above procedures to select the data or folders you want to delete, display the Memory Manager screen and then press  $\text{D}$  (DEL).

## Appendix

### ■ Calculation Priority Sequence

The calculator performs calculations you input in accordance with the priority sequence shown below.

- Basically, calculations are performed from left to right.
- Calculations enclosed in parentheses are given priority.

Sequence	Operation Type	Description
1	Parenthetical Functions	Pol(, Rec( ∫(, d/dx(, d <sup>2</sup> /dx <sup>2</sup> (, Σ(, P(, Q(, R( sin(, cos(, tan(, sin <sup>-1</sup> (, cos <sup>-1</sup> (, tan <sup>-1</sup> (, sinh(, cosh( tanh(, sinh <sup>-1</sup> (, cosh <sup>-1</sup> (, tanh <sup>-1</sup> ( log(, ln(, e <sup>^</sup> (, 10 <sup>^</sup> (, √(, <sup>3</sup> √( Arg(, Abs(, ReP(, ImP(, Conjg( Not(, Neg(, Det(, Trn(, Rnd( Int(, Frac(, Intg(
2	Functions Preceded by Values Power, Power Root Standardized Variate Percent ENG Notation	x <sup>2</sup> , x <sup>-1</sup> , x!, °, °, °, °, °, ° √(, <sup>x</sup> √( ▶ t % m, μ, n, p, f, k, M, G, T, P
3	Fractions	a <sup>b</sup> /c
4	Prefix Symbols	(-) (minus sign) d, h, b, o (Base-n symbols)
5	Statistical Estimated Value Calculations	$\hat{x}$ , $\hat{y}$ , $\hat{x}_1$ , $\hat{x}_2$
6	Permutation, Combination Complex Number Symbol	$nPr$ , $nCr$ ∠
7	Multiplication, Division Omitted Multiplication Sign	x, ÷ Multiplication sign can be omitted immediately before π, variables, scientific constants (2π, 5A, πA, 3mp, 2i, etc.), and parenthetical functions (2√(3), Asin(30), etc.)
8	Addition, Subtraction	+, -
9	Relational Operators	=, ≠, >, <, ≥, ≤
10	Logical Product	and (bitwise operator) And (logical operation command)
11	Logical Sum, Exclusive Logical Sum, Exclusive Negative Logical Sum	or (bitwise operator) Or (logical operation command) xor (bitwise operator) xnor (bitwise operator)

### Note

- If a calculation contains a negative value, you may need to enclose the negative value in parentheses. If you want to square the value -2, for example, you need to input: (-2)<sup>2</sup>. This is because x<sup>2</sup> is a function preceded by a value (Priority 2, above), whose priority is greater than the negative sign, which is a prefix symbol (Priority 4).

     -2<sup>2</sup> = -4

     (-2)<sup>2</sup> = 4

- Multiplication and division, and multiplication where the sign is omitted are the same priority (Priority 7), so these operations are performed from left to right when both types are mixed in the same calculation. Enclosing an operation in parentheses causes it to be performed first, so the use of parentheses can result in different calculation results.

$$1 \div 2 \times (2) \text{ i } \text{EXE} \quad 1 \div 2i = 0.5i$$

$$1 \div (2) \text{ ( } 2 \text{ i ) } \text{ ) } \text{EXE} \quad 1 \div (2i) = -0.5i$$

## Stack Limitations

This calculator uses memory areas called “stacks” for temporary storage of lower calculation priority sequence values, commands, and functions. The “numeric stack” has 10 levels and the “command stack” has 26 levels as shown in the illustration below.

In the TABLE and RECUR Modes, the command stack has only 25 levels (one less than normal).

$$2 \times ((3 + 4 \times (5 + 4) \div 3) \div 5) + 8 =$$

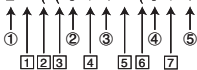

Numeric Stack

①	2
②	3
③	4
④	5
⑤	4
⋮	

Command Stack

1	×
2	(
3	(
4	+
5	×
6	(
7	+
⋮	

A Stack ERROR occurs when the calculation you are performing causes the capacity of a stack to be exceeded.

## Calculation Ranges, Number of Digits, and Precision

The following table shows the general calculation range (value input and output range), number of digits used for internal calculations, and calculation precision.

Calculation Range	$\pm 1 \times 10^{-99}$ to $\pm 9.999999999 \times 10^{99}$ and 0
Internal Calculation	15 digits
Precision	In general, $\pm 1$ at the 10th digit for a single calculation. Error in the case of a calculation result in exponential format is $\pm 1$ at the least significant digits of the mantissa. Errors are cumulative in the case of consecutive calculations.

## Function Calculation Input Ranges and Precision

Functions	Input Range	
$\sin x$	DEG	$0 \leq  x  < 9 \times 10^9$
	RAD	$0 \leq  x  < 157079632.7$
	GRA	$0 \leq  x  < 1 \times 10^{10}$

Functions	Input Range	
$\cos x$	DEG	$0 \leq  x  < 9 \times 10^9$
	RAD	$0 \leq  x  < 157079632.7$
	GRA	$0 \leq  x  < 1 \times 10^{10}$
$\tan x$	DEG	Same as $\sin x$ , except when $ x  = (2n-1) \times 90$ .
	RAD	Same as $\sin x$ , except when $ x  = (2n-1) \times \pi/2$ .
	GRA	Same as $\sin x$ , except when $ x  = (2n-1) \times 100$ .
$\sin^{-1} x$	$0 \leq  x  \leq 1$	
$\cos^{-1} x$		
$\tan^{-1} x$	$0 \leq  x  \leq 9.999999999 \times 10^{99}$	
$\sinh x$	$0 \leq  x  \leq 230.2585092$	
$\cosh x$		
$\sinh^{-1} x$	$0 \leq  x  \leq 4.999999999 \times 10^{99}$	
$\cosh^{-1} x$	$1 \leq x \leq 4.999999999 \times 10^{99}$	
$\tanh x$	$0 \leq  x  \leq 9.999999999 \times 10^{99}$	
$\tanh^{-1} x$	$0 \leq  x  \leq 9.999999999 \times 10^{-1}$	
$\log x / \ln x$	$0 < x \leq 9.999999999 \times 10^{99}$	
$10^x$	$-9.999999999 \times 10^{99} \leq x \leq 99.99999999$	
$e^x$	$-9.999999999 \times 10^{99} \leq x \leq 230.2585092$	
$\sqrt{x}$	$0 \leq x < 1 \times 10^{100}$	
$x^2$	$ x  < 1 \times 10^{50}$	
$1/x$	$ x  < 1 \times 10^{100}; x \neq 0$	
$\sqrt[3]{x}$	$ x  < 1 \times 10^{100}$	
$x!$	$0 \leq x \leq 69$ ( $x$ is an integer)	
$nPr$	$0 \leq n < 1 \times 10^{10}, 0 \leq r \leq n$ ( $n, r$ are integers) $1 \leq \{n!/(n-r)!\} < 1 \times 10^{100}$	
$nCr$	$0 \leq n < 1 \times 10^{10}, 0 \leq r \leq n$ ( $n, r$ are integers) $1 \leq n!/r! < 1 \times 10^{100}$ or $1 \leq n!/(n-r)! < 1 \times 10^{100}$	
$\text{Pol}(x, y)$	$ x ,  y  \leq 9.999999999 \times 10^{99}$ $\sqrt{x^2 + y^2} \leq 9.999999999 \times 10^{99}$	
$\text{Rec}(r, \theta)$	$0 \leq r \leq 9.999999999 \times 10^{99}$ $\theta$ : Same as $\sin x$	
o' "	$ a , b, c < 1 \times 10^{100}$ $0 \leq b, c$	
— o' "	$ x  < 1 \times 10^{100}$ Decimal $\leftrightarrow$ Sexagesimal Conversions: $0^\circ 0' 0'' \leq  x  \leq 99999999' 59'' 59'''$	

Functions	Input Range
$x^y$	$x > 0: -1 \times 10^{100} < y \log x < 100$ $x = 0: y > 0$ $x < 0: y = n, \frac{m}{2n+1}$ ( $m, n$ are integers) However: $-1 \times 10^{100} < y \log  x  < 100$
$x\sqrt[y]{x}$	$y > 0: x \neq 0, -1 \times 10^{100} < 1/x \log y < 100$ $y = 0: x > 0$ $y < 0: x = 2n+1, \frac{2m+1}{m}$ ( $m \neq 0; m, n$ are integers) However: $-1 \times 10^{100} < 1/x \log  y  < 100$
$a^b/c$	Total of integer, numerator, and denominator must be 10 digits or less (including separator symbols).

- $x^y$ ,  $x\sqrt[y]{x}$ ,  $\sqrt[n]{x}$ ,  $x!$ ,  $nPr$ ,  $nCr$  type functions require consecutive internal calculation, which can result in accumulation of errors that occur within each individual calculation.
- Errors are cumulative and tend to be large in the vicinity of a function's singular point and inflection point.

## ■ Error Messages

An error message will appear on the screen if you perform a calculation that causes a calculator's limit to be exceeded, or if you try to perform some operation that is not allowed.

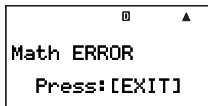

Sample Error Message

## ❑ Recovering from an Error Message

You can recover from an error message by performing the key operations described below, regardless of the error type.

- Press **[EXIT]**, **[←]** or **[→]** to display the editing screen for the calculation expression you input immediately before the error occurred, with the cursor positioned at the location that caused the error. For more information, see "Finding the Location of an Error" on page 21.
- Pressing **[AC/ON]** clears the calculation expression you input before the error message appeared. Note that in this case, the original calculation will not be retained in calculation history memory.

## ❑ Error Message Reference

This section lists all of the error messages that the calculator displays, as well as their causes and what you need to do to avoid them.

Error Message	Cause	Action
Math ERROR	<ul style="list-style-type: none"> <li>An intermediate or the final result of the calculation falls outside of the allowable calculation range.</li> <li>An input value is outside the allowable input range.</li> <li>You are trying to perform an illegal mathematical operation (such as division by zero).</li> <li>You input a complex number as an argument of a function.</li> </ul>	<ul style="list-style-type: none"> <li>Check your input values and reduce the number of digits, if required.</li> <li>When using independent memory or a variable as the argument of a function, make sure that the memory or variable value is within the allowable range for the function.</li> <li>Complex numbers cannot be used as arguments of trigonometric functions and other functions. Change the argument to a real number.</li> </ul>
Stack ERROR	<ul style="list-style-type: none"> <li>The calculation has causes the capacity of the numeric stack or the command stack to be exceeded.</li> <li>The calculation includes more than 10 matrices.</li> </ul>	<ul style="list-style-type: none"> <li>Simplify the calculation expression so it does not exceed the capacity of the stacks.</li> <li>Try splitting the calculation into two or more parts.</li> </ul>
Syntax ERROR	<ul style="list-style-type: none"> <li>The syntax of the calculation expression is wrong.</li> </ul>	<ul style="list-style-type: none"> <li>Check the syntax and make the required corrections.</li> </ul>
Argument ERROR	<ul style="list-style-type: none"> <li>The calculation is using the wrong argument.</li> </ul>	<ul style="list-style-type: none"> <li>Check how arguments are being used and make the required corrections.</li> </ul>
Dimension ERROR	<ul style="list-style-type: none"> <li>The matrix used in a calculation does not contain anything.</li> <li>You are trying to perform an addition or other operation with two matrices of different dimensions, or some other illegal matrix operation.</li> </ul>	<ul style="list-style-type: none"> <li>Change the matrix to one that contains data.</li> <li>Check the matrices and make sure they are within the limits for the type of calculation being performed.</li> </ul>
Can't Solve	<ul style="list-style-type: none"> <li>SOLVE (page 92) could not obtain a solution. (Example: <math>X = X + 1</math>)</li> </ul>	<ul style="list-style-type: none"> <li>Check the equation to make sure it does not contain any errors.</li> <li>Input an initial value that is close to the solution and try again.</li> </ul>
Time Out	<ul style="list-style-type: none"> <li>Integration or differential calculation executed, but the solution does not satisfy end conditions.</li> </ul>	<ul style="list-style-type: none"> <li>Increase the <i>tol</i> value to loosen the solution conditions and try again. Solution precision will be lower in this case.</li> <li>In the case of differentiation of a trigonometric function, select Rad for the angle unit.</li> </ul>

<b>Error Message</b>	<b>Cause</b>	<b>Action</b>
Memory ERROR	<ul style="list-style-type: none"> <li>An attempt was made to recall data (list, matrix, extra variable, formula variable, etc.) that does not exist.</li> </ul>	<ul style="list-style-type: none"> <li>Check to make sure that the name of the data you are trying to recall is correct.</li> </ul>
Go ERROR	<ul style="list-style-type: none"> <li>A "Goto n" in the program being executed does not have a corresponding "Lbl n".</li> <li>The file name being called up by the Prog command does not exist.</li> </ul>	<ul style="list-style-type: none"> <li>Either add a "Lbl n" for the "Goto n" command, or delete the applicable "Goto n" command.</li> <li>Check to make sure that the file name that way input following the Prog command is correct.</li> </ul>
Ne ERROR	<ul style="list-style-type: none"> <li>The number of nested If (page 116), For (page 116), While (page 117) or Do statements (page 117), or subroutines (page 117) in the program being executed exceeds 10.</li> <li>Too many nested functions or parentheses in a calculation.</li> </ul>	<ul style="list-style-type: none"> <li>Edit the program so the number of nested statements or subroutines is 10 or fewer.</li> <li>Divide the calculation into multiple parts and calculate each part separately.</li> </ul>
Transmit ERROR, Receive ERROR	<ul style="list-style-type: none"> <li>LINK Mode data communication was interrupted during send (Transmit ERROR) or receive (Receive ERROR).</li> </ul>	<ul style="list-style-type: none"> <li>Make sure that the cable is connected correctly.</li> <li>Check to make sure that the receiving calculator is in the receive standby mode.</li> </ul>
Memory Full	<ul style="list-style-type: none"> <li>Operation or memory storage operation exceeds remaining memory capacity.</li> </ul>	<ul style="list-style-type: none"> <li>Keep the number of memories you use within the currently specified number of memories.</li> <li>Simplify the data you are trying to store to keep it within the available memory capacity.</li> <li>Delete no longer needed data to make room for the new data.</li> </ul>
Already Exists	<ul style="list-style-type: none"> <li>During data communication, a program or file name in the data being sent already is used in receiving unit memory.</li> </ul>	<ul style="list-style-type: none"> <li>To overwrite the file currently in receiving unit memory with the program or file being sent, press <b>[T]</b> (Yes).</li> </ul>
Range ERROR	<p>In the TABLE or RECUR Mode:</p> <ul style="list-style-type: none"> <li>The table range specification is wrong.</li> <li>An attempt is being made to create a table with more than 199 lines.</li> </ul>	<ul style="list-style-type: none"> <li>Check the range specification and make the required corrections.</li> </ul>
No Variable	<ul style="list-style-type: none"> <li>There is no variable to be solved for in the equation you input for a SOLVE calculation.</li> </ul>	<ul style="list-style-type: none"> <li>Change the equation to one that has a variable to be solved for.</li> </ul>

## ■ Before assuming malfunction of the calculator...

Perform the following steps whenever an error occurs during a calculation or when calculation results are not what you expected. If one step does not correct the problem, move on to the next step. Note that you should make separate copies of important data before performing these steps.

- ① Check the calculation expression to make sure it does not include any errors.
- ② Make sure that you are using the correct mode for the type of calculation you are trying to perform.
- ③ Perform the following steps.
  - (1) Press **MODE** **▼** **3** (SYSTEM) to enter the SYSTEM Mode.
  - (2) Press **2** (Reset Setup).
  - (3) On the confirmation screen that appears, press **EXE** (Yes).
  - (4) Press **EXIT**.
  - (5) Press **MODE** to display the calculation mode menu, and select the appropriate calculation mode for the type of calculation you want to perform.
  - (6) Perform the calculation again.
- ④ Press the P button on the back of the calculator with a thin, pointed object to initialize the calculator. If you perform this procedure correctly, the calculator will return to the state it was in the last time you turned it off.

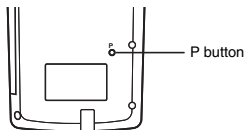

- ⑤ If step ④ does not restore normal operation, initialize all modes and settings by pressing **MODE** **▼** **3** (SYSTEM) **3** (Reset All) **EXE** (Yes).
  - For details, see “To reset the calculator to initial defaults” (page 1).

### Important!

- Calculation history data, memory data, statistical calculation sample data, program data, and all other input data is deleted.

## ■ Lower Battery Indicator

The message shown below appears when battery power goes low. When this happens, stop using the calculator, turn it off, and replace its battery.

**Low Battery**  
**Press: [EXIT]**

### Important!

- The calculator's data transfer function is disabled while the Low Battery message is on the display.



- Normally when you replace the calculator's battery, it stores its current memory contents in flash memory and restores them after battery replacement is complete. If you continue to use the calculator without replacing the battery after the above message appears, the calculator will eventually lose its ability to store data to flash memory. When this happens, the calculator will not be able to restore memory contents after battery replacement.

## Power Requirements

Your calculator runs on a single AAA-size alkaline battery (LR03). Using the wrong type of battery can result in greatly reduced battery life and calculator malfunction.

### ❑ Replacing the Battery

The Low Battery message will appear when battery power goes low. When this happens, stop using the calculator, turn it off, and replace its battery. You should also regularly replace the battery at least once a year, even if the calculator is operating normally.

#### Note

Your calculator uses flash memory to store data, so memory data is not lost when you remove the battery.

1. Press **SHIFT** **AC/ON** (OFF) to turn off the calculator.
  - Be sure to turn off the calculator before replacing the battery. Replacing the battery with power on will cause data in memory to be deleted.
  - Close the calculator cover before replacing the battery. This will help prevent turning on calculator power accidentally.
2. On the back of the calculator, loosen the screw that secures the battery cover in place.
  - The screw is designed so it can be loosened, without being removed from the cover. Loosen the screw as much as it can be loosened.
3. Slide the battery cover in the direction indicated by the arrow to remove it.
4. Remove the old battery.
5. Referring to the illustration inside the battery compartment, load a new battery so its positive  $\oplus$  and negative  $\ominus$  ends are facing correctly.

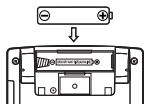
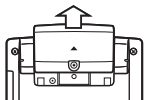
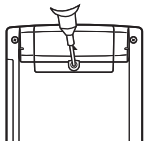

- Slide the battery cover back into its original position, and secure it in place with the screw.
- Press the P button on the back of the calculator with a thin, pointed object to initialize the calculator. ***Be sure to perform this step! Do not skip it!***

## ❖ Auto Power Off

Your calculator will turn off automatically if you do not perform any operation for about 10 minutes. If this happens, press the  key to turn the calculator back on.

# Specifications

**Power Requirements:** AAA-size battery (ALKALINE): LR03 × 1

**Approximate Battery Life:** 1 year (based on 1 hour of operation per day)

**Power Consumption:** 0.12W

**Operating Temperature:** 0°C to 40°C (32°F to 104°F)

**Dimensions:** 15.1 (H) × 81.5 (W) × 163 (D) mm  
 $\frac{5}{8}$ " (H) ×  $3\frac{1}{4}$ " (W) ×  $6\frac{3}{8}$ " (D)

**Approximate Weight:** 150g (5.3 oz)

# MEMO

# MEMO

# MEMO

# MEMO

# MEMO

# MEMO



# MEMO



CASIO Europe GmbH  
Bornbarch 10, 22848 Norderstedt,  
Germany



This mark applies in EU countries only.

**CASIO®**

**CASIO COMPUTER CO., LTD.**

6-2, Hon-machi 1-chome  
Shibuya-ku, Tokyo 151-8543, Japan

SA0606-A Printed in China

## Free Manuals Download Website

<http://myh66.com>

<http://usermanuals.us>

<http://www.somanuals.com>

<http://www.4manuals.cc>

<http://www.manual-lib.com>

<http://www.404manual.com>

<http://www.luxmanual.com>

<http://aubethermostatmanual.com>

Golf course search by state

<http://golfingnear.com>

Email search by domain

<http://emailbydomain.com>

Auto manuals search

<http://auto.somanuals.com>

TV manuals search

<http://tv.somanuals.com>