

# EXILIM

E

Digital Camera

**EX-Z77**

**User's Guide**

Thank you for purchasing this CASIO product.

- Before using it, be sure to read the precautions contained in this User's Guide.
- Keep the User's Guide in a safe place for future reference.
- For the most up-to-date information about this product, visit the official EXILIM Website at <http://www.exilim.com/>

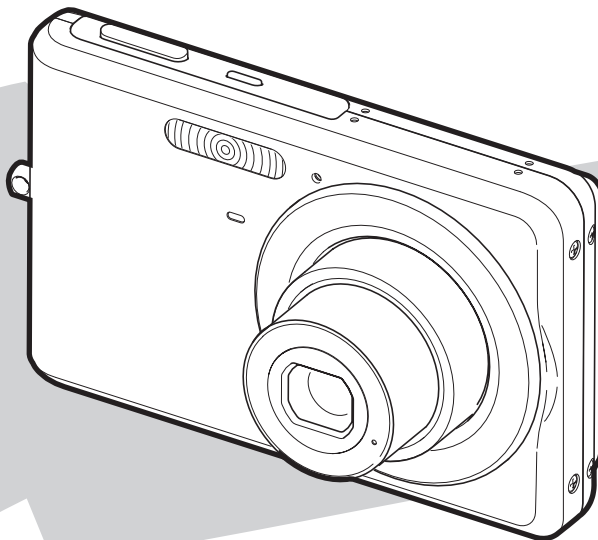

K828PCM2DMX

**CASIO**®

Download from [Www.Somanuals.com](http://www.Somanuals.com). All Manuals Search And Download.

# UNPACKING

As you unpack your camera, check to make sure that all items shown below are included. If anything is missing, contact your original retailer.

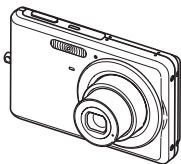

Digital Camera



Rechargeable Lithium Ion Battery  
(NP-20)

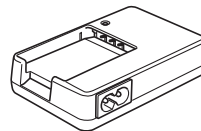

Battery Charger (BC-11L)

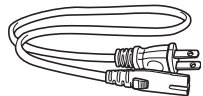

\* The shape of the AC power cord plug varies according to country or geographic area.

AC Power Cord \*



To attach the strap to the camera.

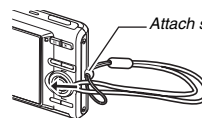

Strap

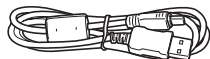

USB Cable

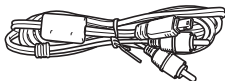

AV Cable

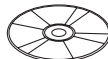

CD-ROM

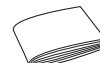

Basic Reference

# CONTENTS

## UNPACKING 2

### QUICK START BASICS 9

First, charge the battery .....	9
Configuring Display Language, Date, and Time Settings .....	11
Using a Memory Card .....	13
Shooting a Snapshot.....	15
Viewing Snapshots .....	17
Shooting a Movie.....	18
Viewing a Movie.....	20
Deleting a File .....	21

## INTRODUCTION 22

Features .....	22
Read this first! .....	23
Precautions during Use .....	27

## GETTING READY 36

<b>Charging the Battery .....</b>	<b>36</b>
■ To charge the battery .....	36
■ To load the battery .....	38
■ Replacing the Battery .....	41
■ Battery Precautions .....	41
<b>Using the Camera in another Country .....</b>	<b>42</b>
<b>Turning Power On and Off .....</b>	<b>43</b>
<b>Using a Memory Card .....</b>	<b>45</b>
■ Supported Memory Cards .....	46
■ Loading a Memory Card into the Camera .....	47
■ Replacing the Memory Card .....	48
■ Formatting a Memory Card .....	49
<b>Using On-screen Menus .....</b>	<b>50</b>
<b>Configuring Monitor Screen Settings .....</b>	<b>52</b>
■ Selecting a Screen Layout .....	52
■ Turning Display Information On and Off .....	56
<b>If you lose your way.....</b>	<b>57</b>

## SHOOTING A SNAPSHOT 58

---

<b>Holding the Camera Correctly</b> .....	58
<b>Shooting a Snapshot</b> .....	59
■ Specifying Image Size	62
■ Specifying Image Quality	64
■ Using the easy Mode	65
■ Snapshot Shooting Precautions	67
■ Auto Focus Restrictions	67
<b>Shooting with Zoom</b> .....	68
<b>Using Flash</b> .....	71
<b>Using the Self-Timer</b> .....	76
<b>Using Continuous Shutter</b> .....	78
■ Selecting the Continuous Shutter Mode	78
■ Recording with Normal-speed Continuous Shutter, High-speed Continuous Shutter, and Flash Continuous Shutter	79
■ Continuous Shutter Precautions	79
<b>Adding Audio to a Snapshot</b> .....	80
<b>Face Recognition</b> .....	82
■ Performing a face recognition recording operation (Normal Mode)	83
■ Using the Family First Mode to Give Priority to Particular Faces	84
■ Face Recognition Precautions	88

## SHOOTING A MOVIE 90

---

<b>Movie Image Quality</b> .....	90
<b>Shooting a Movie</b> .....	91
■ Movie Recording Precautions	92
<b>Using Short Movie</b> .....	93
<b>Using Past Movie</b> .....	95

## USING BEST SHOT 97

---

<b>Reducing the Effects of Hand and Subject Movement</b> .....	102
<b>Taking Bright Images without Flash</b> .....	104
<b>Shooting Images of Business Cards and Documents (Business Shot)</b> .....	105
<b>Shooting ID Photographs</b> .....	107
<b>Restoring an Old Photograph</b> .....	109
<b>Recording Snapshots into a Multi-image Layout (Layout Shots)</b> .....	112
<b>Auto Tracking a Moving Subject (Auto Framing)</b> .....	114

## ADVANCED SETTINGS 115

---

<b>Changing the Focus Mode</b> .....	<b>115</b>
■ Using Auto Focus	116
■ Using Macro Focus	117
■ Using Fixed Focus (Pan Focus)	123
■ Using Infinity Focus	123
■ Using Manual Focus	123
<b>Correcting Image Brightness (EV Shift)</b> .....	<b>125</b>
<b>Controlling White Balance</b> .....	<b>126</b>
<b>Specifying ISO Sensitivity</b> .....	<b>129</b>
<b>Specifying the Metering Mode</b> .....	<b>130</b>
<b>Reducing the Effects of Overexposure and Underexposure</b> .....	<b>131</b>
<b>Enhancing Human Skin Textures</b> .....	<b>132</b>
<b>Using the Camera's Color Filter Effects</b> .....	<b>133</b>
<b>Controlling Image Sharpness</b> .....	<b>133</b>
<b>Controlling Color Saturation</b> .....	<b>134</b>
<b>Adjusting Image Contrast</b> .....	<b>134</b>
<b>Date Stamping Snapshots</b> .....	<b>135</b>
<b>Using the On-screen Histogram to Check Exposure</b> .....	<b>136</b>

## Other Useful Recording Functions .....138

■ Using Key Customize to Assign Functions [◀] and [▶]	138
■ Displaying an On-screen Grid	139
■ Displaying the Image You Just Recorded (Image Review)	139
■ Using Icon Help	140
■ Using Mode Memory to Configure Power On Default Settings	141
■ Resetting the Camera to Its Initial Factory Defaults	143

## VIEWING SNAPSHOTS AND MOVIES 144

---

<b>Viewing a Snapshot</b> .....	<b>144</b>
■ Listening to the Audio of an Audio Snapshot	145
<b>Viewing a Movie</b> .....	<b>146</b>
■ Playing Back a Movie with Anti Shake	148
<b>Playing a Slideshow on the Camera</b> .....	<b>148</b>
<b>Viewing Camera Images on a TV</b> .....	<b>153</b>
<b>Zooming the Displayed Image</b> .....	<b>156</b>
<b>Using the 12-image Screen</b> .....	<b>157</b>
<b>Using the Calendar Screen</b> .....	<b>157</b>

## **EDITING IMAGES** **159**

---

Resizing a Snapshot .....	159
Cropping a Snapshot .....	160
Keystone Correction .....	161
Using Color Restoration to Correct the Color of an Old Photograph .....	162
Editing the Date and Time of an Image .....	164
Rotating an Image .....	165
Combining Multiple Snapshots into a Single Image (Layout Print) .....	166
Adjusting White Balance of a Recorded Image .....	167
Adjusting Image Brightness .....	169
Reducing the Effects of Underexposure .....	170
Editing a Movie on the Camera .....	171
Creating a Snapshot of a Movie Frame (MOTION PRINT) .....	174

## **USING AUDIO** **176**

---

Adding Audio to a Snapshot .....	176
Recording Audio Only (Voice Recording) .....	178

## **MANAGING YOUR FILES** **180**

---

Files and Folders .....	180
Protecting a File Against Deletion .....	181
Using the FAVORITE Folder .....	183
Copying Files .....	185



## **DELETING FILES** **187**

---

Deleting a Specific File .....	187
Deleting All Files .....	188
Deleting FAVORITE Folder Snapshots .....	188

## **OTHER SETTINGS** **189**

---

Configuring Camera Sound Settings . . . . .	189
Turning the Startup Screen On or Off . . . . .	191
Specifying the File Name Serial Number Generation Rule . . . . .	192
Changing the Camera Date and Time Setting . . . . .	193
Using World Time . . . . .	195
■ Configuring World Time Settings . . . . .	195
Changing the Display Language . . . . .	197
Changing the USB Port Protocol . . . . .	198
[  ] (REC) and [  ] (PLAY) Button Settings . . . . .	199
Formatting Built-in Memory . . . . .	200

## **PRINTING** **201**

---

Types of Printing . . . . .	201
Using Professional Print Service . . . . .	202
Using Your Printer to Print Images . . . . .	202
Using DPOF to Specify Images to be Printed and the Number of Copies . . . . .	206
■ Date Stamping . . . . .	208
Supported Protocols . . . . .	209

## **USING THE CAMERA WITH A COMPUTER** **211**

---

What you can do . . . . .	211
Using the Camera with a Windows Computer . . . . .	212
■ Viewing and Storing Images on a Computer . . . . .	214
■ Transfer of Images from the Camera and Management of Images on the Computer . . . . .	221
■ Playing Movies . . . . .	222
■ Uploading Movie Files to YouTube . . . . .	224
■ Transferring Images to the Camera . . . . .	226
■ Viewing User Documentation (PDF Files) . . . . .	229
■ User Registration . . . . .	230
■ Exiting the CD-ROM Menu . . . . .	230
Using the Camera with a Macintosh . . . . .	230
■ Viewing and Storing Images on a Macintosh . . . . .	231
■ Transfer of Images from the Camera and Management of Images on Your Macintosh . . . . .	235
■ Playing Movies . . . . .	236
■ Viewing User Documentation (PDF Files) . . . . .	236
■ Registering as a User . . . . .	236
Reading Files Directly from a Memory Card . . . . .	237
Memory Card Data . . . . .	238

## APPENDIX

241

---

<b>General Guide</b> .....	<b>241</b>
<b>Monitor Screen Contents</b> .....	<b>243</b>
<b>Menu Reference</b> .....	<b>246</b>
<b>Indicator Lamps</b> .....	<b>250</b>
■ Battery Charger Lamp Reference	251
<b>Troubleshooting Guide</b> .....	<b>252</b>
■ Finding the Problem and Fixing It	252
■ Display Messages	257
<b>Specifications</b> .....	<b>259</b>



# QUICK START BASICS

## First, charge the battery

### ■ Using the Battery Charger to Charge

#### 1. Load the battery into the battery charger.

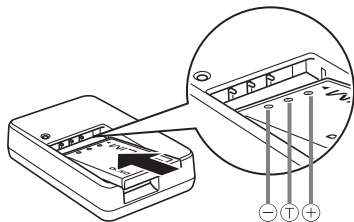

(page 36)

#### 2. Plug the battery charger into a household power outlet.

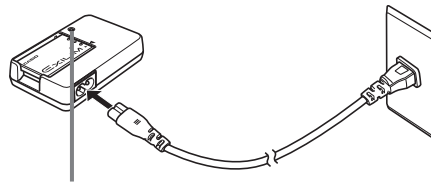

*[CHARGE] lamp lights red during charging.*

*[CHARGE] lamp goes out when charging is complete.*

- *It takes about 90 minutes to achieve a full charge.*

## ■ Loading the Battery into the Camera

### 1. Open the battery cover.

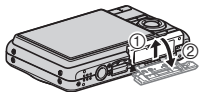

While pressing lightly on the cover, slide it in the direction indicated by the arrow to open.

### 2. Load the battery into the camera.

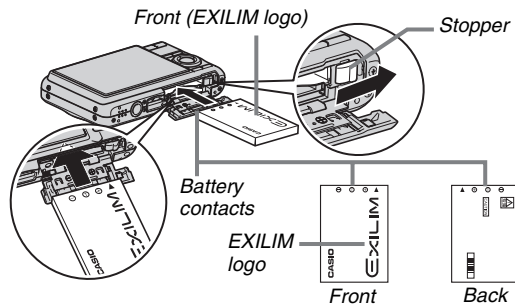

### 3. Close the battery cover.

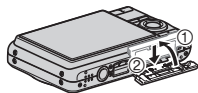

## Configuring Display Language, Date, and Time Settings

(pages 193, 197)

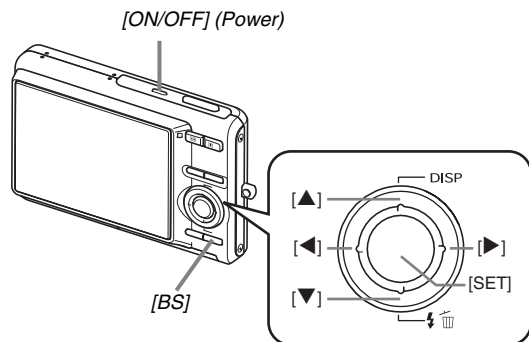

The settings on this page are required the first time you turn on the camera after purchasing it.

- If you make a mistake when configuring the language, date, and time settings, you can change the settings (pages 193, 197).

1. Press [ON/OFF] to turn on the camera.
2. Use [▲], [▼], [◀], and [▶] to select the language you want and then press [SET].
3. Use [▲], [▼], [◀], and [▶] to select the area where you will use the camera and then press [SET].
4. Use [▲] and [▼] to select the city where you will use the camera and then press [SET].
5. Use [▲] and [▼] to select the summer time (DST) setting you want and then press [SET].

**6. Use [▲] and [▼] to select the date format and then press [SET].**

Example: December 19, 2007

To display the date like this:	Select this option:
07/12/19	YY/MM/DD
19/12/07	DD/MM/YY
12/19/07	MM/DD/YY

**7. Set the date and the time.**

Use [◀] and [▶] to select the setting you want (year, month, day, hour, minute) and then use [▲] and [▼] to change the setting. To switch between 12-hour and 24-hour format, press [BS].

**8. When settings are completed, press [SET].**

**9. Press [ON/OFF] to turn off the camera.**

- After finishing this procedure, advance to the procedure on the next page.

## Using a Memory Card

### ■ Loading a Memory Card into the Camera

When a memory card is loaded, the camera stores images you shoot on the card.

#### NOTE

- Though the camera has built-in memory, using a memory card provides additional capacity you can use to store more images, high-quality and large-size images, and longer movies.
- The camera will store images in its built-in memory if there is no memory card loaded. If you prefer to use built-in memory, skip this procedure and go to "Shooting a Snapshot" on page 15.
- For information about memory card capacity, see page 259.

### 1. Open the battery cover.

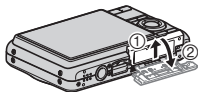

While pressing lightly on the cover, slide it in the direction indicated by the arrow to open.

### 2. Load a memory card into the camera.

(page 45)

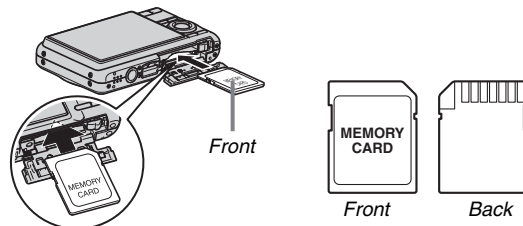

With the front of the memory card facing upwards (towards the monitor screen side of the camera), slide it into the card slot and press until it clicks securely into place.

### 3. Close the battery cover.



## ■ Formatting a Memory Card

Before you can use a memory card with your camera, you must format it.

### ★ **IMPORTANT!**

- Formatting a memory card that already has snapshots or other files on it, will delete its contents. Normally you do not need to format a memory card again. However, if storing to a card has slowed down or if you notice any other abnormality, re-format the card.
- Be sure to perform the following procedure on the camera to format the memory card.

1. Press [ON/OFF] to turn on the camera.
2. Press [MENU].
3. Use [◀] and [▶] to select the “Set Up” tab.
4. Use [▼] to select “Format” and then press [▶].

## 5. Press [▲] to select “Format” and then press [SET].

- To cancel formatting, select “Cancel” and then press [SET].
- Wait until the “Busy... Please wait...” message disappears from the monitor screen before doing anything else.

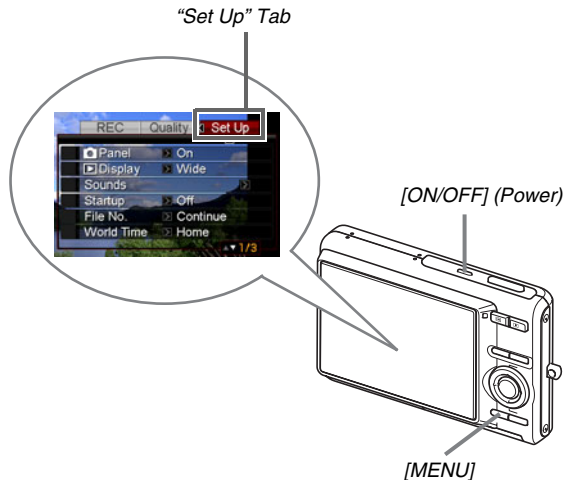

## Shooting a Snapshot

(page 58)

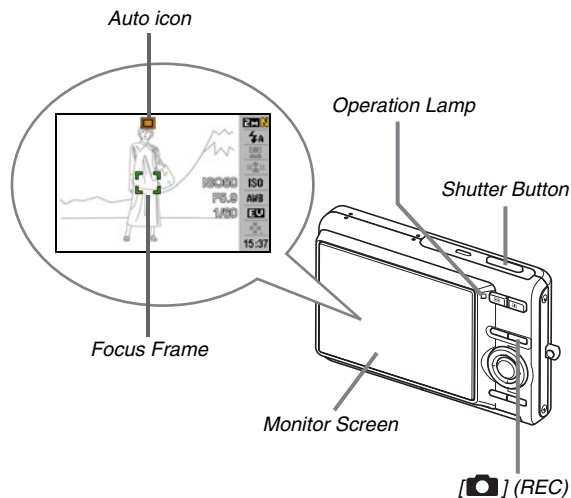

### 1. Press [📷] to turn on the camera.

This enters the REC mode and displays "📷" (Auto icon) on the monitor screen.

### 2. Point the camera at the subject.

### 3. While taking care to keep the camera still, half-press the shutter button.

When the image is in focus, the camera will beep, the operation lamp will light green, and the focus frame will turn green.

### 4. Continuing to keep the camera still, press the shutter button all the way down.

The recorded image will remain on the display for about one second, and then it will be stored in memory. After that, the camera will be ready to shoot the next image.

## Snapshot Image Size and Image Quality

Your camera lets you select from among various image size and quality settings. Note that image size and quality settings affect how many images can be stored in memory.

- You can change the image size and quality settings as required to shoot a smaller or lower-resolution image for attachment to an e-mail message, for publishing on a website, etc. You can also select an image size that suits the size of paper you plan to use for printing your images.

For details, see pages 62, 64, and 259.

## How do I half-press the shutter button?

The shutter button is designed to stop about half way down when you press it lightly. Stopping at this point is called a "half-press". When you half-press the shutter button, the camera automatically adjusts exposure and focuses on the subject it is currently pointed at.

Mastering how much pressure is required for a half-press and a full-press of the shutter button is an important technique for good-looking images.

### Half-press

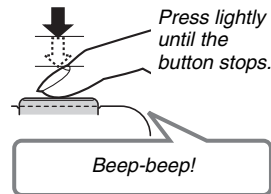

### Full-press

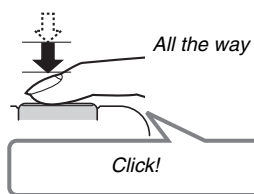



## ■ Fully pressing the shutter button without waiting for Auto Focus

Fully pressing the shutter button without waiting for Auto Focus to operate will record using Quick Shutter (page 122). Quick Shutter lets you capture exactly the moment you want.

- With Quick Shutter, the camera uses high-speed Auto Focus, which means you can capture quick moving action more easily. Note, however, that some images may be out of focus when Quick Shutter is used.
- Whenever possible, take a little extra time to half-press the shutter button in order to ensure proper focus.

## Viewing Snapshots

(page 144)

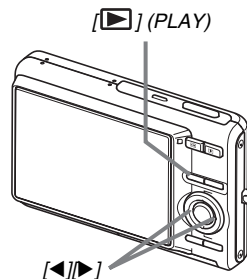

### 1. Press [▶] to enter the PLAY mode.

If there are multiple images in memory, use [◀] and [▶] to scroll through them.

### ■ To return to the REC mode

Press [📷].

## Shooting a Movie

(page 90)

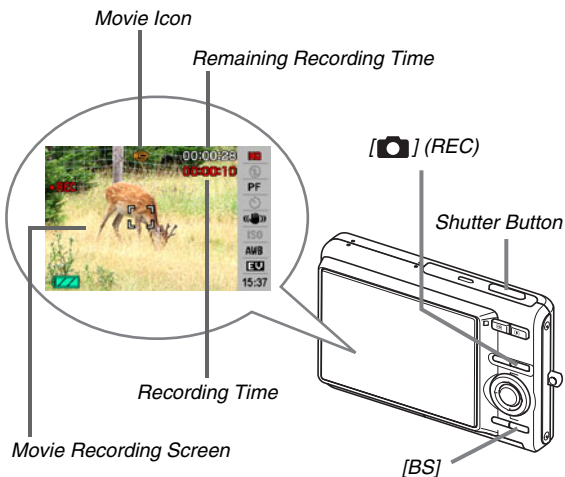

1. Press [**📷**] to enter the REC mode.
2. Press [**BS**] (BEST SHOT).
3. Use [**▲**], [**▼**], [**◀**], and [**▶**] to select the “**📷**” (Movie) scene and then press [**SET**].  
“**📷**” (movie icon) remains on the monitor screen.
4. Press the shutter button to start shooting the movie.
  - Audio is also recorded during movie recording.
5. Press the shutter button again to stop recording.

## Movie Image Quality

Your camera lets you select from among six image quality settings (UHQ, UHQ Wide, HQ, HQ Wide, Normal, LP) for movies. To get the most out of the imaging capabilities of your camera, use a quality setting of "HQ" (High Quality) or "HQ Wide" or better.

Movie quality is a standard that determines the detail, smoothness, and clarity of the image during playback.

Reducing image quality let's you shoot longer, so you can switch to "Normal", or "LP" conserve remaining memory capacity if you start to run low.

For details, see pages 90 and 260.

## Viewing a Movie

(page 146)

The film-like frame that appears on the monitor screen indicates that this is an image from a movie.

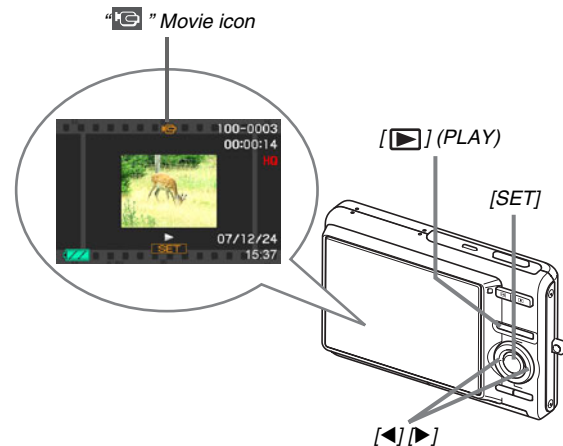

**1. Press [▶] to enter the PLAY mode.**

**2. Use [◀] and [▶] to select the movie you want to play.**

When scrolling through images, a movie is displayed on the monitor screen by showing its first frame.

**3. Press [SET] to start playback.**

The monitor screen will return to the image selection screen in step 2 after the end of the movie is reached.

- During movie playback, you can adjust volume, skip forward and back, and perform other operations (page 147).

■ **To return to the REC mode**

Press [📷].

## Deleting a File

(page 187)

You can use the following procedure to delete files you have transferred to your computer's hard disk, images you have printed, or files you simply no longer need. This frees up memory for recording more images.

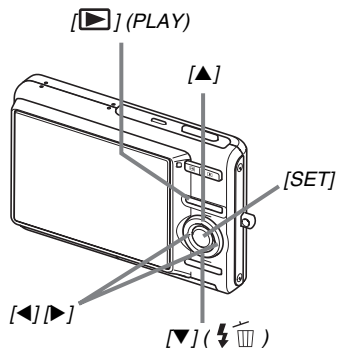

**1. Press [PLAY].**

**2. Press [▼] (⚡🗑️).**

**3. Use [◀] and [▶] to select the snapshot or movie you want to delete.**

**4. Press [▲] to select “Delete”.**

- To cancel the delete operation, select “Cancel”.

**5. Press [SET].**

This deletes the selected snapshot or movie.

- If you want to delete more, repeat the above procedure from step 3.
- To quit the delete operation, press [MENU].

# INTRODUCTION

## Features

### ■ BEST SHOT for beautiful shots simply by selecting a sample image built into the camera

Simply select the scene that is similar to what you want to shoot (Night Scene Portrait, Flower, etc.), for instant camera setups. A dedicated [BS] button gives you direct access to the BEST SHOT library of sample scenes.

*Example: Select for beautiful portraits.*

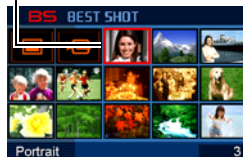

### ■ Direct Mode Power On

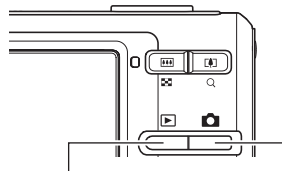

To view images, press [▶] To record, press [📷] to power up in the PLAY mode.

### ■ A powerful collection of useful recording features

- Face recognition during image recording (page 82)
- Hand movement and subject movement reduction using high shutter speed (page 102)
- High-sensitivity recording avoids dark images, even when the flash is not being used (page 104)
- Quick Shutter, which helps you capture exactly the moment you want (page 122)
- High quality (H.264) movie recording (page 90)

## ■ Powerful Print Features

- DPOF feature for easy specification of date stamping and the number of copies (page 206)
- Timestamp feature that stamps the date into the image data (page 135)
- Support for PictBridge and USB DIRECT-PRINT for easy at-home printing on a printer that supports one of these standards, without a computer (page 202)

## Read this first!

### ■ LCD Panel

The liquid crystal panel of the monitor screen uses high-precision technology that provides a pixel yield in excess of 99.99%.

This means that some pixels may not light or may remain lit at all times. This is due to the characteristics of the liquid crystal panel, and does not indicate malfunction.

## ■ Copyrights

Except for your own personal enjoyment, unauthorized use of snapshots or movies of images recorded with this camera without the permission of the applicable right holder is forbidden by copyright laws. In some cases, shooting of public performances, shows, exhibitions, etc. may be restricted entirely, even if it is for your own personal enjoyment.

Regardless of whether such files are purchased by you or obtained for free, posting them on a website, a file sharing site, or any other Internet site, or otherwise distributing them to third parties without the permission of the copyright holder is strictly prohibited by copyright laws and international treaties.

Uploading or distributing on the Internet images of TV programs, live concerts, music videos, etc. that were photographed or recorded by you may infringe upon the rights of others. Note that CASIO COMPUTER CO., LTD. shall not be held liable for any use of this product that infringes on the copyrights of others or that violates copyright laws.

The trademarks and registered trademarks shown below are used in an editorial fashion in the explanatory text of this manual without trademark <sup>™</sup> or registered trademark <sup>®</sup> symbols. No infringement on trademarks is intended.

- The SDHC Logo is a trademark.
- Microsoft, Windows, Internet Explorer, Windows Media, Windows Vista, and DirectX are either registered trademarks or trademarks of Microsoft Corporation in the United States and/or other countries.
- Macintosh, Mac OS, QuickTime, QuickTime logo, and iPhoto are trademarks of Apple Inc. in the United States and/or other countries.
- MultiMediaCard is a trademark of Infineon Technologies AG of Germany, and licensed to the MultiMediaCard Association (MMCA).
- MMC*plus* is a trademark of the MultiMediaCard Association.
- Adobe and Reader are either registered trademarks or trademarks of Adobe Systems Incorporated in the United States and/or other countries.
- HOTALBUM and the HOT ALBUM logo are registered trademarks or trademarks of Konica Minolta Photo Imaging, Inc., and licensed to HOTALBUMcom, Inc.
- YouTube, the YouTube logo and "Broadcast Yourself" are either registered trademarks or trademarks of YouTube, LLC.
- EXILIM, Photo Loader, Photo Transport, and YouTube Uploader for CASIO are registered trademarks or trademarks of CASIO COMPUTER CO., LTD.



- Photo Loader with HOT ALBUM was developed based on HOT ALBUM, which is copyrighted by HOTALBUMcom, Inc., and Photo Loader, which is copyrighted by CASIO COMPUTER CO., LTD. All copyrights and other rights revert to original copyright holders.
- All other company or product names mentioned herein are registered trademarks or trademarks of their respective companies.

Any and all unauthorized commercial copying, distribution, and copying of the bundled software over a network are prohibited.

This product contains PrKERNELv4

Real-time OS of eSOL Co., Ltd.

Copyright© 2007 eSOL Co., Ltd.

PrKERNELv4 is a registered trademark of eSOL Co., Ltd. in Japan.



This product's YouTube upload functionality is included under license from YouTube, LLC. The presence of YouTube upload functionality in this product is not an endorsement or recommendation of the product by YouTube, LLC.

- The contents of this manual are subject to change without notice.
  - The content of this manual has been checked at each step of the production process. Please contact us if you notice anything that is questionable, erroneous, etc.
  - Any copying of the contents of this manual, either in part or its entirety, is forbidden. Except for your own personal use, and other use of the contents of this manual without the permission of CASIO COMPUTER CO., LTD. is forbidden under copyright laws.
  - CASIO COMPUTER CO., LTD. shall not be held liable for any damages or loss suffered by you or any third party due to the use or malfunction of this product.
  - CASIO COMPUTER CO., LTD. shall not be held liable for any damages or loss suffered by you or any third party due to the use of Photo Loader with HOT ALBUM, Photo Transport, and/or YouTube Uploader for CASIO.
  - CASIO COMPUTER CO., LTD. shall not be held liable for any damages or loss caused by deletion of memory contents due to malfunction, repair, or any other reason.
- Note that the example screens and product illustrations shown in this manual may differ somewhat by the screens and configuration of the actual camera.

## Precautions during Use

### ■ Take test shots before shooting the final shot.

- Before shooting your final image, shoot a test shot to ensure that the camera is recording correctly.

### ■ Avoid Use While In Motion

- Never use the camera to record or play back images while operating an automobile or other vehicle, or while walking. Looking at the monitor while in motion creates the risk of serious accident.

### ■ Directly Viewing the Sun or Bright Light

- Never look at the sun or any other bright light through the camera's viewfinder. Doing so can damage your eyesight.

### ■ Flash

- Never use the flash unit in areas where flammable or explosive gas may be present. Such conditions create the risk of fire and explosion.
- Never fire the flash in the direction of a person operating a motor vehicle. Doing so can interfere with the driver's vision and creates the risk of accident.
- Never fire the flash too close to the eyes of the subject. Doing so creates the risk of loss of eyesight.

## ■ Display Panel

- Do not apply strong pressure to the LCD panel surface or subject it to strong impact. Doing so can cause the display panel glass to crack.
- Should the display panel ever become cracked, never touch any of the liquid inside the panel. Doing so creates the risk of skin inflammation.
- Should display panel liquid ever get into your mouth, immediately rinse your mouth out and contact your physician.
- Should display panel liquid ever get into your eyes or onto your skin, immediately rinse with clean water for at least 15 minutes and contact your physician.

## ■ Connections

- Never plug any devices that are not specified for use with this camera into connectors. Connecting a non-specified device creates the risk of fire and electric shock.

## ■ Transport

- Never operate the camera inside of an aircraft or anywhere else where operation of such devices is restricted. Improper use creates the risk of serious accident.

## ■ Smoke, abnormal odor, overheating, and other abnormalities

- Continued use of the camera while it is emitting smoke or strange odor, or while it is overheating creates the risk of fire and electric shock. Immediately perform the following steps whenever any of the above symptoms are present.
  1. Turn off the camera.
  2. Remove the battery from the camera, taking care to protect yourself against burn injury.
  3. Contact your dealer or nearest CASIO authorized service center.

## ■ Water and Foreign Matter

- Water, other liquids, or foreign matter (especially metal) getting inside the camera creates the risk of fire and electric shock. Immediately perform the following steps whenever any of the above symptoms are present. Particular care is required when using the camera where it is raining or snowing, near the ocean or other body of water, or in a bathroom.
  1. Turn off the camera.
  2. Remove the battery from the camera.
  3. Contact your dealer or nearest CASIO authorized service center.

## ■ Dropping and Rough Treatment

- Continued use of the camera after it is damaged by dropping or other rough treatment creates the risk of fire and electric shock. Immediately perform the following steps whenever any of the above symptoms are present.
  1. Turn off the camera.
  2. Remove the battery from the camera.
  3. Contact your dealer or nearest CASIO authorized service center.

## ■ Keep Away From Fire

- Never expose the camera to fire, which can cause it to explode and creates the risk of fire and electric shock.

## ■ Disassembly and Modification

- Never try to take the camera apart or modify it in any way. Doing so creates the risk of electric shock, burn injury, and other personal injury. Be sure to leave all internal inspection, maintenance, and repair up to your dealer or nearest CASIO authorized service center.

## ■ Locations To Be Avoided

- Never leave the camera in any of the following types of locations. Doing so creates the risk of fire and electric shock.
  - Areas subject to large amounts of humidity or dust
  - Food preparation areas or other locations where oil smoke is present
  - Near heaters, on a heated carpet, in areas exposed to direct sunlight, in a closed vehicle parked in the sun, or other areas subject to very high temperatures
- Never place the camera on an unstable surface, on a high shelf, etc. Doing so can cause the camera to fall, creating the risk of personal injury.

## ■ Backing Up Important Data

- Always keep backup copies of important data in camera memory by transferring it to a computer or other storage device. Note that data can be deleted in the case of camera malfunction, repair, etc.

## ■ Memory Protection

- Whenever replacing the battery, be sure to follow the correct procedure as described in the documentation that comes with the camera. Incorrectly replacing the battery can result in corruption or loss of data in camera memory.

## ■ Rechargeable Battery

- Use only the specified charger unit or the specified device to charge the battery. Attempting to charge the battery by an unauthorized means creates the risk of battery overheating, fire, and explosion.
- Do not expose or immerse the battery in fresh water or salt water. Doing so can damage the battery, and cause deterioration of its performance and loss of service life.
- This battery is intended for use with a CASIO Digital Camera only. Use with any other device creates the risk of the battery damage, or deterioration of battery performance and service life.
- Failure to observe any of the following precautions creates the risk of battery overheating, fire, and explosion.
  - Never use or leave the battery near open flame.
  - Do not expose batteries to heat or fire.
  - Make sure the battery is oriented correctly when it is connected to the charger unit.
  - Never carry or store the battery together with items that can conduct electricity (necklaces, pencil lead, etc.)
  - Never disassemble the battery, pierce it with a needle, or expose it to strong impact (hit it with a hammer, step on it, etc.), and never apply solder to it. Never place the battery into a microwave oven, heater, high-pressure generating device, etc.
- Should you ever notice leakage, strange odor, heat generation, discoloration, deformation, or any other abnormal condition while using, charging, or storing a battery, immediately remove it from the camera or charger unit and keep it away from open flame.
- Do not use or leave the battery under direct sunlight, in an automobile parked in the sun, or in any other area subject to high temperatures. Doing so can damage the battery, and cause deterioration of its performance and loss of service life.
- If the battery charging does not end normally within the specified charging time, stop charging anyway and contact your local CASIO authorized service center. Continued charging creates the risk of battery overheating, fire, and explosion.
- Battery fluid can damage your eyes. Should battery fluid get into your eyes accidentally, immediately rinse them with clean tap water and then consult a physician.
- Be sure to read the user documentation that comes with the camera and special charger unit before using or charging the battery.

- If a battery is to be used by young children, make sure that a responsible adult makes them aware of the precautions and proper handling instructions, and make sure that they handle battery correctly.
- Should fluid from a battery accidentally get onto clothing or your skin, immediately rinse it off with clean tap water. Prolonged contact with battery fluid can cause skin irritation.

## ■ Battery Life

- Battery continuous operation times provided in this manual represent the approximate amount of time before the camera turns off due to low battery power when being powered by the special battery under normal temperature (23°C (73°F)). They do not guarantee that you will be able to achieve the indicated level of operation. Actual battery life is greatly affected by ambient temperature, battery storage conditions, the amount of time spent in storage, etc.
- Leaving the camera on can run down battery and cause the low battery warning to appear. Turn off the camera whenever you are not using it.
- The low battery warning indicates that the camera is about to turn off due to low battery power. Charge the battery as soon as possible. Leaving low or dead batteries in the camera can lead to battery leakage and data corruption.



## ■ Data Error Precautions

- Your digital camera is manufactured using precision digital components. Any of the following creates the risk of corruption of data in camera memory.
  - Removing the battery or memory card from the camera while the camera is performing an operation
  - Removing the memory card from the camera while the operation lamp is flashing green after turning off the camera
  - Disconnecting the USB cable while a data communication operation is being performed
  - Using a battery that is low
  - Other abnormal operations

Any of the above conditions can cause an error message to appear on the monitor screen (page 257). Perform the action indicated by the message that appears.

## ■ Operating Environment

- The operating temperature range of the camera is 0°C to 40°C (32°F to 104°F).
- Do not place the camera in any of the following locations.
  - In an area exposed to direct sunlight, or large amounts of moisture or dust
  - Near an air conditioner or in other areas subjected to extreme temperature or humidity
  - Inside of a motor vehicle on a hot day, or in an area subjected to strong vibration

## ■ Condensation

- Sudden and extreme temperature changes, such as when the camera is moved from the outdoors on a cold winter day into a warm room, can cause water droplets called “condensation” to form on the interior and the exterior of the camera. Note that condensation can cause malfunction of the camera. To avoid condensation, place the camera into a plastic bag before subjecting it to sudden temperature change. Wait until the air in the bag has had enough time to become acclimated to the new temperature before removing the camera. After that, open the battery cover and leave it open for a few hours.

## ■ Power Supply

- Use only the special rechargeable lithium ion battery (NP-20) to power this camera. Use of any other type of battery is not supported.
- The camera does not have a separate battery for the clock. The date and time settings of the camera are cleared about two days after power is cut off from the battery. If this happens, be sure to reconfigure these settings after power is restored (page 193).

## ■ Lens

- Never apply too much force when cleaning the surface of the lens. Doing so can scratch the lens surface and cause malfunction.
- You may sometimes notice some distortion in certain types of images, such as a slight bend in lines that should be straight. This is due to the characteristics of lens, and does not indicate malfunction of the camera.

## ■ Caring for your camera

- Fingerprints, dirt, and other foreign matter on the lens surface can interfere with proper operation of the camera. Avoid touching the lens surface. To clean the lens surface, use a blower to blow off dust or foreign matter and then wipe with a soft, dry cloth.
- Fingerprints, dirt, and other foreign matter on the flash can interfere with proper operation of the camera. Avoid touching the flash. If the flash becomes dirty, wipe it clean with a soft, dry cloth.
- To clean the camera, wipe it with a soft, dry cloth.

## ■ Monitor Screen Images

- The images that normally appear on the monitor screen during image playback are smaller than normal, and so you cannot see all of the detail of the actual image. Your camera has an image zoom feature (page 156) which you can use to enlarge the monitor screen image. You can use this feature for on-the-spot checks of important images.

## ■ Other Precautions

- The camera becomes slightly warm during use. This is normal and does not indicate malfunction.

# GETTING READY

## Charging the Battery

Your camera is powered by a rechargeable lithium ion battery (NP-20).

### **IMPORTANT!**

- Use of any type of battery other than NP-20 is not supported.

The battery is not fully charged when you use the camera for the first time after purchasing it. You need to charge the battery before using the camera for the first time.

## To charge the battery

1. **Correctly positioning the positive and negative terminals of the battery, load the battery into the battery charger.**

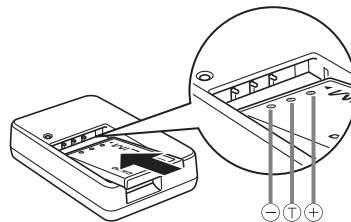

- Making sure that the positive and negative contacts are aligned correctly, load the battery into the battery charger. Note that the battery will not charge properly if it is not positioned correctly in the battery charger.

## 2. Plug the battery charger into a household power outlet.

This will cause the [CHARGE] lamp to turn red.

- It takes about 90 minutes to achieve a full charge. Actual charging time depends on current battery capacity, remaining power, and charging conditions.

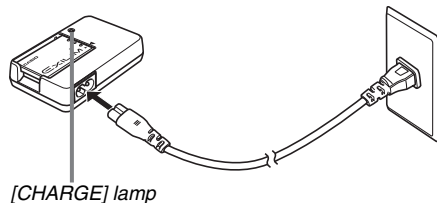

### When charging is complete

The [CHARGE] lamp will go out. Unplug the power cord from the power outlet and then remove the battery from the charger.

### If the [CHARGE] lamp does not light red

Charging cannot be performed because ambient temperature or temperature of the charger is too hot or too cold. Wait until the camera returns to normal temperature. When the camera returns to a temperature where charging can be performed, the [CHARGE] lamp will light red.

### If the [CHARGE] lamp flashes red

The battery is faulty or the battery is loaded in the charger incorrectly. Remove the battery from the charger and check if its contacts are dirty. If they are, wipe them off with dry cloth and then reload the battery into the charger. When experiencing charging problems, also check to make sure that the power cord is not disconnected from the power outlet or charger.

If an error still continues to occur after you perform the above steps, it could mean that the battery is faulty. Contact your nearest CASIO authorized service center.

## **IMPORTANT!**

- Use the special charger (BC-11L) to charge the special lithium ion battery (NP-20). Never use any other type of charger device. Attempting to use a different charger can result in unexpected accident.
- Charging the battery while it is still warm immediately after removing it from the camera can result in only partial charging. Give the battery time to cool before charging it.
- Battery discharges slightly even when it is left without loading it into the camera. Because of this, it is recommended that you charge the battery immediately before you need to use it.
- Charging the battery may cause interference with TV and radio reception. If this happens, plug the charger into an outlet that is further away from the TV or radio.

## To load the battery

### 1. Open the battery cover.

While pressing the battery cover, slide it in the direction indicated by the arrow.

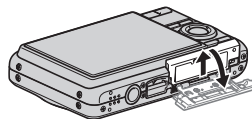

## 2. Load the battery into the camera.

With the EXILIM logo on the battery facing upwards (in the direction of the monitor screen), hold the stopper in the direction indicated by the arrow as you slide the battery into the camera. Press the battery in until the stopper secures it in place.

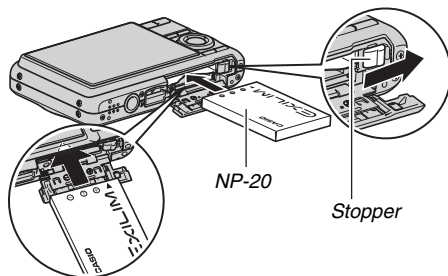

## 3. Close the battery cover.

Swing the battery cover closed, and then slide it securely into place as you press it against the camera.

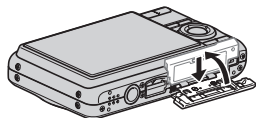

## ■ Battery Life and Number of Images between Charges





See page 263 for details.

## ■ Battery Power Conservation Tips

- When you do not need to use the flash, select “” (flash off) for the flash setting (page 71).
- Enable the Auto Power Off and the Sleep features to protect against wasting battery power when you forget to turn off the camera (page 44).

## ■ Checking Remaining Battery Power

As battery power is consumed, a battery indicator on the monitor screen indicates remaining power as shown below.

<b>Remaining Power</b>	High ←————→ Low
<b>Battery Indicator</b>	 →  →  → 
<b>Indicator Color</b>	Light blue → Orange → Red → Red

“” indicates that battery power is low. Charge the battery as soon as possible.

Recording is not possible when “” is indicated. Charge the battery immediately.

## ★ IMPORTANT!

- Due to differences in the power requirements of each mode, the battery indicator may show a lower level in the PLAY mode than what it shows in the REC mode. This is normal, and does not indicate malfunction.
- Leaving the camera for about two days with no power supplied while the battery is dead will cause its date and time settings to be cleared. You will have to re-configure the settings after power is restored.



## Replacing the Battery

1. Open the battery cover.
2. With the camera oriented with its monitor screen facing upwards as shown in the illustration, slide the stopper in the direction indicated by the arrow and hold it there.
  - This will cause the battery to come out part way.

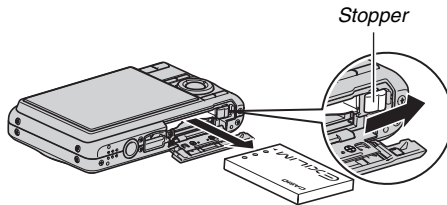

3. While still holding the stopper, pull the battery out the rest of the way.
4. Load a new battery.

## Battery Precautions

### ■ Precautions during Use

- Operation provided by a battery under cold conditions is always less than operation under normal temperatures. This is due to the characteristics of the battery, not the camera.
- Charge the battery in an area where the temperature is within the range of 5°C to 35°C (41°F to 95°F). Charging outside this temperature range can cause charging to take longer than normal or even cause charging to fail.
- If a battery provides only very limited operation following a full charge, it probably means that the battery has reached the end of its service life. Replace the battery with a new one.

## ■ Storage Precautions

- Though a rechargeable lithium ion battery provides high capacity in a compact configuration, long-term storage while charged can cause it to deteriorate.
  - If you do not plan to use a battery for some time, fully use up its charge before storing it.
  - Always remove the battery from the camera when you are not using it. Leaving a battery in the camera can cause it to discharge and go dead, which will require longer charging when you need to use the camera.
  - Store batteries in a cool, dry place (20°C (68°F) or lower).

## Using the Camera in another Country

Note the following precautions.

- The bundled battery charger is designed for operation with any power supply in the range of 100V to 240V AC, 50/60Hz. Note, however, that the shape of the power cord plug depends on each country or geographic area. Before taking the camera and charger along on a trip, check with travel agent about the power supply requirements in your destination(s).
- Do not connect the battery charger to a power supply through a voltage converter or similar device. Doing so can lead to malfunction.

## ■ Extra Batteries

Taking along extra fully charged batteries (NP-20) is recommended while on a trip in order to avoid not being able to shoot images due to the battery going dead.

## Turning Power On and Off

### ■ Turning Power On

#### To turn power on and enter the REC mode

Press [ON/OFF] (Power) or [📷] (REC).

#### To turn power on and enter the PLAY mode

Press [▶] (PLAY).

Pressing a button causes the operation lamp to light green momentarily and turns on power.

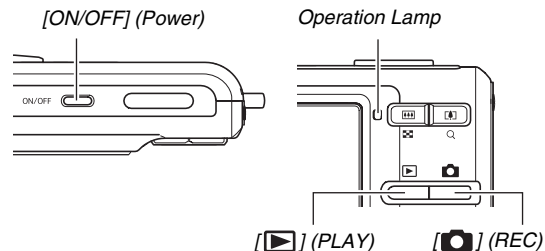

### ★ IMPORTANT!

- Pressing [ON/OFF] or [📷] (REC) to turn on power also causes the lens to extend. Take care there is nothing pressing against or hitting the lens. Holding the lens with your hand so it cannot extend creates the risk of malfunction.

### NOTE

- Pressing [▶] (PLAY) while in the REC mode switches to the PLAY mode. The lens retracts about 10 seconds after switching modes.
- Auto Power Off (page 44) will turn off power automatically if you do not perform any operation for a preset amount of time. If this happens, turn power back on.

## ■ Turning Power Off

Press [ON/OFF] (Power).

### NOTE

- You can configure the camera so power does not turn on when you press [📷] (REC) or [▶] (PLAY). You can also configure the camera to turn off when you press [📷] (REC) or [▶] (PLAY) (page 199).

### Turning On Power for the First Time

The first time you load a battery into the camera, a screen appears for configuring screen text language, date, and time settings. Use the procedure under “Configuring Display Language, Date, and Time Settings” (page 11) to configure the settings correctly.



### IMPORTANT!

- Failure to set the date and time will cause the wrong date and time data to be recorded with images.
- If you make a mistake when configuring the language, date, and time settings, you can change the settings (pages 193, 197).

## ■ Battery Power Conservation Features

This camera is equipped with a sleep function and auto power off function to conserve battery power. You can configure these settings in the REC mode as described below.

Feature Name	Description	Settings
Sleep	The monitor screen turns off (goes into a sleep state) if no operation is performed for a preset amount of time. Press any button to turn the monitor screen back on.	30 sec 1 min 2 min Off
Auto Power Off	Power turns off if no operation is performed for a preset amount of time.	1 min 2 min 5 min

- Sleep and Auto Power Off always operate as described below in the PLAY mode, regardless of their current PLAY mode settings.
  - Sleep does not function in the PLAY mode.
  - The Auto Power Off trigger time is always five minutes.

**1. Press [MENU].**

**2. Use [◀] and [▶] to select the “Set Up” tab.**

**3. Use [▲] and [▼] to select the item you want to configure (“Sleep” or “Auto Power Off”) and then press [▶].**

**4. Use [▲] and [▼] to select the sleep or Auto Power Off trigger time and then press [SET].**

Selecting “Off” for the sleep setting disables the sleep feature.

#### NOTE

- When both sleep and Auto Power Off have the same time settings, Auto Power Off takes priority.
- Sleep and Auto Power Off are disabled under the following conditions.
  - When there is a connection between the camera and computer or other device
  - During Voice Recording playback or recording
  - During movie recording and playback

## Using a Memory Card

You can store images you shoot with the camera on a memory card. It is up to you to purchase a commercially available memory card. In addition to memory card storage, the camera also has built-in memory, which is enough to hold a few snapshots or a short movie. Use built-in memory for test purposes, emergency use, etc.

#### NOTE

- Images can be copied between the camera’s built-in memory and a memory card (page 185).
- The following data is stored in built-in memory. It cannot be copied to a memory card.
  - Face Recognition data saved with Record Family
  - BEST SHOT mode user image information
  - FAVORITE folder
  - Mode memory settings
  - Start-up screen image

## Supported Memory Cards

Your camera supports use of the following types of memory cards.

SD Memory Card

SDHC Memory Card

MMC (MultiMediaCard)

MMC*plus* (MultiMediaCardplus)

- For information about memory card capacity, see page 259.





### Memory Used for Storage

Images recorded while a memory card is loaded are saved to the memory card. When no memory card is loaded, images are saved in built-in memory.

- Note that you cannot save images in built-in memory while a memory card is loaded in the camera.

### **IMPORTANT!**

- See the instructions that come with the memory card for information about how to use it.
- Certain types of cards can slow down processing speeds. If you are using a slow memory card, you may not be able to record a movie using the “UHQ”, “UHQ Wide”, “HQ”, or “HQ Wide” image quality setting. Because of this, use of a memory card with a maximum transfer speed of at least 10MB per second is recommended.

- Certain types of memory cards take longer to record data, which can cause movie frames to be dropped. “ ” and “ ” flash on the monitor screen during recording to let you know when a frame has been dropped. Use of a memory card with a maximum transfer speed of at least 10MB per second is recommended.
- SD memory cards and SDHC memory cards have a write protect switch. Use it when you need to guard against accidentally deleting data. Note, however, if you write protect a memory card you must then turn write protection off whenever you want to record to the card, format it, or delete any of its images.
- Electrostatic charge, electrical noise, and other phenomena can cause data to become corrupted or even lost. Make sure that you always back up important data on other media (CD-R, CD-RW, MO disk, hard disk, etc.).

## Loading a Memory Card into the Camera

### **IMPORTANT!**

- Make sure you always turn off the camera before loading or removing a memory card.
- Be sure to orient the card correctly when loading it. Never try to force a memory card into the slot when you feel resistance.

### **1. Open the battery cover.**

While pressing the battery cover, slide it in the direction indicated by the arrow.

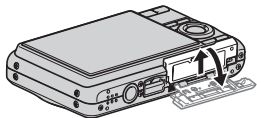

### **2. Load a memory card into the camera.**

Positioning the memory card so its front is facing upwards (towards the monitor screen side of the camera), slide it into the card slot all the way in until you hear it click securely into place.

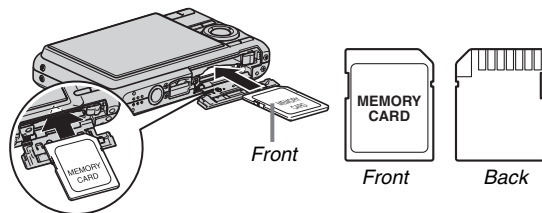

### **3. Close the battery cover.**

Swing the battery cover closed, and then slide it securely into place as you press it against the camera.

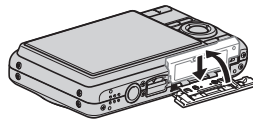

## Replacing the Memory Card

### 1. Remove the memory card from the camera.

Press the memory card and then release it, so it comes part way out. Pull the card out the rest of the way by hand.

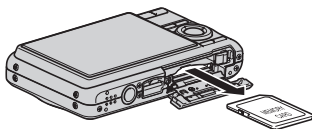

### 2. Load the other memory card.

### **IMPORTANT!**

- Never insert anything besides a supported memory card (page 46) into the memory card slot.
- Should water or any foreign object ever get into the card slot, immediately turn off the camera, remove the battery, and contact your retailer or nearest CASIO authorized service center.
- Never remove a card from the camera while the operation lamp is flashing green. Doing so can cause the image save operation to fail and even damage the memory card.



## Formatting a Memory Card

Before using a new memory card for the first time, you need to format it. Once you format a memory card, you will not need to format it each time you use it.

Formatting a memory card that already has files on it will delete its contents.

### **IMPORTANT!**

- Note that data deleted by a memory card format operation cannot be recovered. Double-check to make sure that you really want to delete all the contents of the memory card before proceeding with the format operation.
- Even if the file data on a memory card is protected (page 181), formatting the card will delete all its data.
- Be sure to use the camera to format a memory card. Formatting a memory card on a computer and then using it in the camera can slow down data processing by the camera. In the case of an SD memory card or SDHC memory card, formatting on a computer can result in non-conformity with the SD format, causing problems with compatibility, operation, etc.

1. Load the memory card you want to format into the camera.
2. Turn on the camera and press [MENU].
3. On the “Set Up” tab, select “Format” and then press [▶].
4. Use [▲] and [▼] to select “Format” and then press [SET] to start formatting.

After formatting is complete, enter the PLAY mode and check to make sure the “There are no files.” message appears on the monitor screen.

- To exit the format operation without formatting, select “Cancel”.

## ■ Memory Card Precautions

- If a memory card starts to behave abnormally, you can restore normal operation by reformatting it. However, it is recommended that you always take along more than one memory card whenever using the camera far away from the home or office.
- If you experience problems while trying to playback recorded images, try re-formatting the memory card.
- As you record data to and delete data from a memory card a number of times, it loses its ability to retain data. Because of this, periodic re-formatting of a memory card is recommended.
- Make sure that the battery is charged fully before starting a formatting operation. Formatting may not be performed correctly and the memory card may be damaged if the camera powers down while formatting is in progress.
- Never open the battery cover while formatting is in progress. Doing so can damage the memory card.

## Using On-screen Menus

The following are menu operations you will need to use to configure camera settings. Take a few moments to become familiar with them.

- See “Menu Reference” on page 246 for information about menu contents.
- You also can use the Operation Panel (page 53) to configure some of the settings that appear on the menu screen. In any case where the same setting can be configured both on the Operation Panel and on the menu screen, the Operation Panel operation is always shown.

### Example Menu Screen

Press [MENU] to display the menu screen.

- Menu contents are different in the REC mode and PLAY mode. This screen shows the REC mode menu.

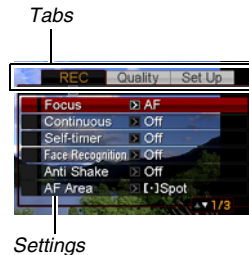

## Menu Screen Operation Buttons

[◀] [▶]	Select tabs. [▶] is also used to apply a setting.
[▲] [▼]	Select a setting option.
[SET]	Applies the selected settings.
[MENU]	Exits the menu screen.

The following is the procedure for menu operations in the REC mode.

### 1. In the REC mode, press [MENU].

This displays the menu screen.

### 2. Use [◀] and [▶] to select the tab where the item you want to configure is located.

Here, we will select the "REC" tab.

### 3. Use [▲] and [▼] to select the item you want to configure and then press [▶].

Example: Select "Focus" and then press [▶].



### 4. Use [▲] and [▼] to select the setting you want.

### 5. Apply the setting.

- Pressing [SET] applies the selected setting and exits the menu screen.
- Pressing [◀] instead of [SET] applies the selected setting and returns to the menu screen. You can then continue configuring other settings, if you want.
- To select another tab, press [◀], use [▲] to return to the tab and then use [◀] and [▶] to switch to another tab.



### IMPORTANT!

- Entering the easy mode (page 65) changes display contents to four menu items each, using larger size characters. The easy mode also displays simple onscreen help.

## Configuring Monitor Screen Settings

You can use the display menu to configure various monitor screen settings.

### Selecting a Screen Layout

The contents of the layout setting menu depend on whether the camera is in the REC mode or the PLAY mode.

#### ■ REC Mode Screen Layout

For the REC mode, the screen layout settings let you select the layout of icons.

1. In the REC mode, press [MENU].
2. Use [◀] and [▶] to select the “Set Up” tab.
3. Use [▲] and [▼] to select “ Panel” and then press [▶].
4. Use [▲] and [▼] to select the setting you want, and then press [SET].

Panel setting	Description
On	<p>Pressing [SET] in the REC mode while “On” is selected will cause the top icon of the Operation Panel to become highlighted (selected). You can then use the Operation panel to change settings. Since there are few icons superimposed on the displayed image, they do not interfere with recording.</p> 

Panel setting	Description
Off	<p>With this option, the image being composed completely fills the monitor screen. This setting is best when you want to display the subject on a large 16:9 aspect ratio monitor screen (page 63). Icons are superimposed on the displayed image.</p> 

All screen shots in this manual show what appears when the Operation Panel is turned on.

## Panel (Operation Panel)

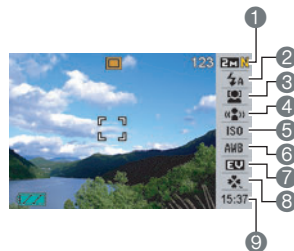

- ① Image Size/Quality\*<sup>1</sup> (pages 62, 64)
- ② Flash mode (page 71)
- ③ Face Recognition (page 82)
- ④ Anti Shake (page 102)
- ⑤ ISO sensitivity (page 129)
- ⑥ White balance (page 126)
- ⑦ EV shift (page 125)
- ⑧ easy Mode (page 65)
- ⑨ Date/Time\*<sup>2,3</sup> (page 193)

- \*1 Image quality cannot be changed using Panel (Operation Panel).
- \*2 You can select date or time display.
- \*3 You can use the “Date Style” to select either month/day or day/month for date display (page 194).  
The time display format is always 24 hours, regardless of the current settings of the camera’s “Adjust” (page 194).

The following procedure shows how to use Panel (Operation Panel).

**1. In the REC mode, press [SET].**

This highlights (selects) the top icon of the Operation Panel.



**2. Use [▲] and [▼] to select the icon of the setting you want to change.**

**3. Use [◀] and [▶] to change the setting.**

- If you want to configure other settings, repeat steps 2 and 3.

**4. After all the settings are the way you want, press [SET].**

- This will apply the settings and return to normal operation (no Operation Panel icon selected).



**★ IMPORTANT!**

- Panel (Operation Panel) is not displayed while Voice Recording is being used.

## ■ PLAY Mode Screen Layout



The PLAY mode screen layout settings let you select how display images are shown on the monitor screen.

1. In the PLAY mode, press [MENU].
2. Use [◀] and [▶] to select the “Set Up” tab.
3. Use [▲] and [▼] to select “ Display” and then press [▶].
4. Use [▲] and [▼] to select the setting you want, and then press [SET].

Display setting	Description
Wide	<p>With this setting, the display image is the maximum possible size that allows the entire image to be displayed horizontally. With some aspect ratios, the top and bottom of the image will be cut off.</p> 
4:3	<p>With this setting, 100% of the display image is always visible. With some aspect ratios, black bands may appear above and below, or to the left and right of the image.</p> 

## Turning Display Information On and Off

You can turn display information on and off by pressing [▲] (DISP). You can configure separate settings for the REC mode and PLAY mode.

Display Information Setting	Description
Show	Turns on display of camera setting and other information. 
+Histogram	Turns on display of camera setting and other indicators, along with a histogram (page 136). 

Display Information Setting	Description
Hide	Turns off display of all information. 

### ★ IMPORTANT!

- You cannot turn display information on or off while an audio snapshot record operation is standing by or in progress.
- The following shows the display information options available during voice recording.

In this voice recording mode:	You can select these display information options:
REC mode	Display information or monitor screen off
PLAY mode	Display information or hide information



## If you lose your way...

Perform one of the following operations if you find that you have gotten lost while performing button operations during recording or playback.

### REC mode

Current Screen	To return to the normal snapshot or movie recording screen, press:
Menu screen	[MENU] or [📷]
BEST SHOT screen	[BS] or [📷]
"There are no files." screen	Press [📷].
PLAY mode screen	Press [📷].

### PLAY mode

Current Screen	To return to the normal playback screen
Menu screen	[MENU] or [▶]
REC mode screen	Press [▶]
Delete screen	Press [▶]. You could also select "Cancel" and then press [SET].

# SHOOTING A SNAPSHOT

## Holding the Camera Correctly

Holding the camera with one hand can result in accidental hand movement. Hold the camera securely with both hands when shooting snapshots.

- To protect against accidentally dropping the camera, attach the wrist strap and make sure it is around your fingers or wrist while you are operating the camera.
- The supplied strap is intended for use with this camera only. Never use it for any other purpose.
- Never swing the camera around by its strap.

### Horizontal

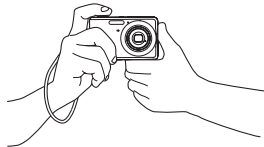

Hold the camera as shown in the illustration, with your arms firmly against your sides.

### Vertical

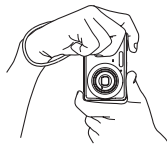

Hold the camera so the flash is above the lens.

## IMPORTANT!

- Take care that your fingers and the strap do not cover any of the areas indicated in the illustration.

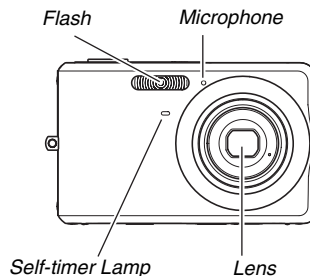

## NOTE

- Good-looking images are impossible if you move the camera when you press the shutter button or while the Auto Focus operation is being performed. Holding the camera correctly, carefully press the shutter button and take care that you do not move the camera as the shutter releases. This is especially important when available lighting is low, which slows down the shutter speed.

## Shooting a Snapshot

### 1. Press [ ] (REC) to enter the REC mode.

Confirm that the subject (people, scenery, etc.) and the Auto icon " " are displayed on the monitor screen.

If any icon other than the Auto icon " " is displayed, switch to "Auto" (page 97).

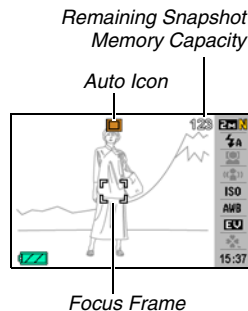

## 2. Focus the image.

While the focus frame is aligned with the subject, half-press the shutter button.

Auto Focus will focus the image automatically, and the focus frame and operation lamp will turn green. The aperture, shutter speed, and ISO sensitivity also will be set automatically.

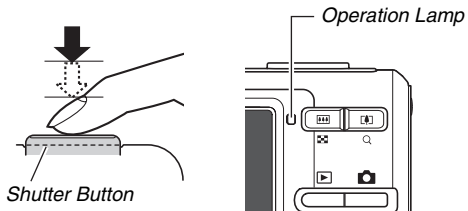

## 3. Shoot the image.

When the image is focused, press the shutter button the rest of the way.

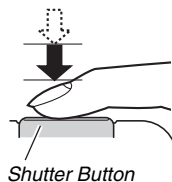

This will shoot the snapshot and save it to the memory card or the camera's built-in memory.

## NOTE

- The aperture value indicates the size of the opening that lets light into the camera. A larger aperture value indicates a smaller opening. The camera adjusts this setting automatically.
- Shutter speed indicates the amount of time that light is allowed into the camera. A slower shutter speed means that light is allowed in for a longer time. Shutter speed is indicated on the monitor screen as seconds (1/1000 second, etc.) The camera adjusts this setting automatically.

## If the image does not focus...

If the focus frame stays red and the operation lamp is flashing green, it means that the image is not in focus (because the subject is too close, etc.). Point the camera at the subject and try to focus again.

### Checking a Snapshot

A snapshot will remain on the monitor screen for a short while after you shoot it and then disappear when the camera gets ready for the next image.

Perform the following operation to view a snapshot after you shoot it.

**Press** [▶].

This will display the snapshot you just shot.

Use [◀] and [▶] to scroll through other images in memory.

To return to the REC mode, press [📷].

## ■ Fully pressing the shutter button without waiting for Auto Focus

You can shoot snapshots by pressing the shutter button all the way without waiting for Auto Focus. What the camera does in this case depends on whether Quick Shutter (page 122) is on or off.

### When Quick Shutter is turned on

High-speed Auto Focus is enabled, which helps you capture exactly the moment you want. Quick Shutter comes in handy when shooting a fast-moving subject.

- Some images may be out of focus when Quick Shutter is used.
- Quick Shutter is turned on as the initial factory default setting.

### When Quick Shutter is turned off

Normal Auto Focus is performed and then the image is recorded.

- If you keep the shutter button depressed, images will continue to be shot without focus.
- Whenever possible, take a little extra time to half-press the shutter button in order to ensure proper focus.

## Specifying Image Size

A digital camera image is a collection of small dots (pixels). The size of an image indicates how many pixels it contains, and is expressed as horizontal pixels × vertical pixels. The initial factory default image size setting is 7M (3072 × 2304 pixels). Note that a larger image takes up more memory.

- For information about image size, image quality, and number of images that can be stored, see page 259.  
This setting applies to snapshots only.
- For information about movie image size, see page 90.

1. In the REC mode, press [SET].
2. Use [▲] and [▼] to select the top option in the operation panel (Image Size).
3. Use [◀] and [▶] to select an image size and then press [SET].

## NOTE

- The following information changes on the display during the image size selection operation.
  - Image size in pixels (1600 × 1200, etc.)
  - Optimum print paper size
  - Remaining snapshot memory capacity

Image Size (Pixels)		Print Paper Size	
Larger	7M	3072 × 2304	A3 Print
	3:2	3072 × 2048	A3 Print
↕	16:9	3072 × 1728	HDTV
	5M	2560 × 1920	A3 Print
	3M	2048 × 1536	A4 Print
	2M	1600 × 1200	3.5" × 5" Print
	Smaller	VGA	640 × 480

- Selecting 3:2 (3072 × 2048 pixels) records images with an aspect ratio of 3:2, which matches the standard aspect ratio (3:2) of print paper.
- The letters “HDTV” stand for “High Definition Television”. An HDTV screen has an aspect ratio of 16:9, which makes them wider than the usual 4:3 aspect ratio of television screens of the past. Your camera can record images that are compatible with the aspect ratio of an HDTV screen.
- VGA (640 × 480 pixels) is the optimum size when attaching images to e-mail.
- Print paper sizes should be thought of as rough estimates only (200 dpi print resolution).

## Specifying Image Quality

Your camera lets you select “Fine” (maximum image quality), “Normal”, or “Economy” (maximum memory economy) for the image quality setting. The initial setting is “Normal”. Select “Fine” if you want to give priority to image quality, or “Economy” to give priority to the number of images you can store in memory.

- For information about image size, image quality, and number of images that can be stored, see page 259.

This setting applies to snapshots only.

- For information about movie image quality, see page 90.

- 1. In the REC mode, press [MENU].**
- 2. On the “Quality” tab, select “ Quality” and then press [▶].**
- 3. Use [▲] and [▼] to select the image quality setting you want and then press [SET].**

### NOTE

- The “Fine” setting helps to bring out details when shooting a finely detailed image of nature that includes dense tree branches or leaves, or an image of a complex pattern.



## Using the easy Mode

The easy mode eliminates troublesome setups. This mode is recommended for those who are new to digital imaging.

- 1. In the REC mode, press [SET].**
- 2. Use [▲] and [▼] to select the second option from the bottom in the operation panel (easy mode).**
- 3. Use [◀] and [▶] to select “ ON” and then press [SET].**

This enters the easy mode.

- 4. Focus the image.**

While the focus frame is aligned with the subject, half-press the shutter button.

- 5. Shoot the image.**

When the image is focused, press the shutter button the rest of the way.

## ■ Using the easy Menu

The easy menu contains flash, self-timer, and image size settings, plus an item for exiting the easy mode.

While the camera is in the easy mode, all the other settings (besides Self-timer, Image Size, and easy Mode) on the REC tab menu (page 246) and Quality tab menu (page 247) are fixed at preset optimum values. Any settings you configured on these tabs are not used in the easy mode.



### IMPORTANT!

- To use the Set Up tab menu (page 248), you need to exit the easy mode. To do this, select the “easy Mode” item in step 2 of the following procedure, and then select **OFF** in step 3. After that, you can use the Setup tab menu as you normally do.

## 1. Press [MENU].

The easy menu displays larger text than standard menus.



## 2. Use [▲] and [▼] to select the menu item you want, and then press [SET].

## 3. Use [▲] and [▼] to select the setting you want, and then press [SET].

Menu Item:	Available Settings:
Flash	(Auto Flash)* /  (Flash On) /  (Flash Off)
Self-timer	(10-second self-timer) / <b>OFF</b> *
Image Size	<b>7M</b> * / <b>3M</b> / <b>U6A</b>
easy Mode	<b>ON</b> / <b>OFF</b> *
Exit Menu	Exit the easy menu

- An asterisk (\*) indicates reset default settings.
- See the following sections for full details about the “Flash”, “Self-timer”, or “Image Size” settings.
  - Using the Flash (page 71)
  - Using the Self-timer (page 76)
  - Specifying Image Size (page 62)
- The following are the settings you can select for “easy Mode”.

To do this:	Select this setting:
Stay in the easy mode, without switching to another recording type	<b>ON</b>
Switch from the easy mode to a standard recording type	<b>OFF</b>

- On-screen pop-up help text provides a brief explanation of each setting.

## Snapshot Shooting Precautions

### ■ Operation

- Never open the battery cover while the operation lamp is flashing green. Doing so can result in incorrect storage of the image you just shot, damage to other images stored in memory, malfunction of the camera, etc.
- If unneeded light is shining directly onto the lens, shade the lens with your hand when shooting an image.

### ■ Monitor Screen when Shooting Snapshots

- The image that appears on the monitor screen is for image composition. The actual image will be recorded at the quality set for the image quality setting.
- Subject brightness conditions can cause monitor screen response to slow and can cause digital noise in the monitor screen image.

### ■ Shooting Indoors under Fluorescent Lighting

- Minute flickering of fluorescent lighting can affect the brightness or color of an image.

## Auto Focus Restrictions

- Proper focus may not be possible when shooting the following types of subjects.
  - Solid color wall or other very low contrast subject
  - Strongly back lit subject
  - Very shiny subject
  - Blinds or other subject with a repeating horizontal pattern
  - Multiple subjects at varying distances from the camera
  - Subject in a dark location
  - Fast-moving subject
  - Subjects outside the focus range of the camera
- Proper focus may not be possible if the camera is moved while shooting.
- An image may be out of focus even though the operation lamp is lit green and the focus frame is green.  
If you cannot focus properly, try using focus lock (page 121) or manual focus (page 123).

## Shooting with Zoom

Your camera provides you with 3X optical zoom (which changes the lens focal distance), which can be used in combination with digital zoom (which digitally process the center portion of the image to enlarge it) for total zoom capabilities of 12 - 45.2X.

### **IMPORTANT!**

- Generally speaking, the higher the digital zoom factor, the coarser the image that is recorded. However, digital zoom can be used up to a certain point without causing deterioration of the image.
- Digital zoom is not supported while "Timestamp" (page 135) is turned on.

### 1. Enter the REC mode.

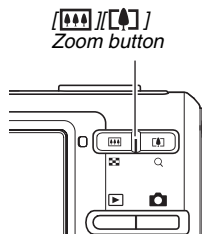

### 2. Press the zoom button to change the zoom factor.

To do this:	Press this side of the zoom button:
Enlarge the subject and narrow the range	[ [ ] ] (telephoto)
Reduce the size of the subject and broaden the range	[ [ ] ] (wide angle)

- For more information, see "Optical Zoom and Digital Zoom Switch Point" on page 69.

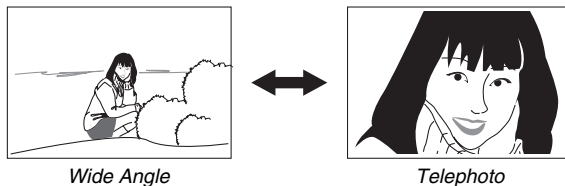



### 3. Press the shutter button to shoot.

## NOTE

- Performing a zoom operation changes the lens aperture.
- Use of a tripod is recommended to protect against hand movement when using the telephoto setting (zoom in).
- Optical zoom is disabled while shooting a movie. Digital zoom only is available while shooting a movie. Make sure you select the optical zoom setting you want to use before you press the shutter button to start shooting your movie.

## ■ Optical Zoom and Digital Zoom Switch Point

If you hold down the [] side of the zoom button in step 2 of the above procedure, the zoom operation will stop when the optical zoom factor reaches its maximum. Momentarily releasing the zoom button and then holding down its [] side will switch to digital zoom, which you can use to set an even higher zoom factor.

- When the zoom pointer moves past the maximum limit of optical zoom. Also, the zoom bar indicates the approximate zoom factor.

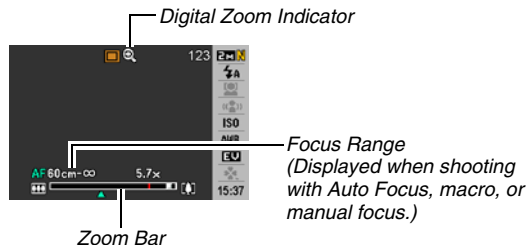

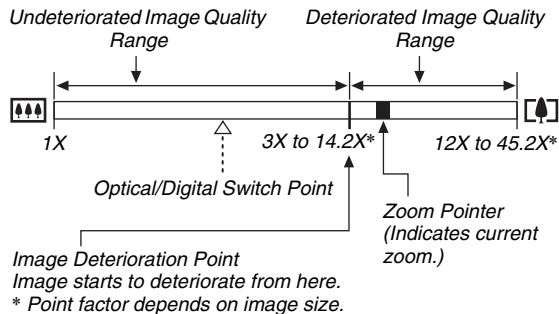

### ● Zoom Values for Each Image Size

	Undeteriorated Image Quality Range	Deteriorated Image Quality Range
7M	1X	3X      12X
3:2	1X	3X      12X
16:9	1X	3X      12X
5M	1X	3.6X      14.2X
3M	1X	4.5X      17.9X
2M	1X	5.7X      22.6X
VGA	1X	14.2X      45.2X

- The image deterioration point depends on the image size (page 62). The smaller the image size, the higher the zoom factor you can use before reaching the image deterioration point.
- Though digital zoom generally causes a deterioration of image quality, some digital zoom without image deterioration is possible with image sizes of “5M (2560 × 1920 pixels)” and smaller. The range in which you can use digital zoom without image deterioration is indicated on the display. The deterioration point depends on the image size.
- The digital zoom range of the zoom indicator is shown on the monitor screen only while “Digital Zoom” is turned on.





## ■ Turning Off Digital Zoom

You can turn off digital zoom if you want to use optical zoom only. This will help to avoid deteriorated images due to accidentally switching over from optical zoom to digital zoom when shooting snapshots.

1. In the REC mode, press [MENU].
2. On the “REC” tab, select “Digital Zoom” and then press [▶].
3. Use [▲] and [▼] to select “Off” and then press [SET].
  - If you want to show the entire digital zoom range, select “On” here.

## Using Flash

Perform the following steps to select the flash mode you want to use.

Flash Setting	Description
 Auto Flash	Flash fires automatically in accordance with exposure (amount of light and brightness) conditions. <ul style="list-style-type: none"><li>• Initial factory default setting.</li></ul>
 Flash Off	Flash does not fire.
 Flash On	Flash always fires. <ul style="list-style-type: none"><li>• This setting can be used to brighten a subject that normally comes out dark due to daylight or backlight (daylight synchro flash).</li></ul>
 Soft Flash	Always use soft flash, regardless of exposure conditions. <ul style="list-style-type: none"><li>• Use this setting when you want to suppress the flash to avoid reflection, etc.</li></ul>
 Red Eye Reduction	Flash fires automatically in accordance same conditions as Auto Flash. This setting can be used to reduce the red eye effect that occurs in images of people shot with flash.

## Approximate Flash Range (ISO Sensitivity: Auto)

Wide Angle : 0.1 m to 3.5 m (0.3' to 11.5')

Telephoto : 0.6 m to 1.9 m (2.0' to 6.2')

- The flash range changes in accordance with optical zoom.

1. In the REC mode, press [SET].
2. Use [▲] and [▼] to select the second option from the top in the operation panel (Flash).

3. Use [◀] and [▶] to select the flash setting you want and then press [SET].

This causes an indicator identifying the selected flash mode to appear on the monitor screen.



4. Press the shutter button to shoot.

## NOTE

- When operation panel setting is turned off (page 52), you can cycle through the flash modes by pressing [▼] ( ⚡🗑️ ).

## IMPORTANT!

- When using flash, take care that the flash window is not blocked by your fingers or the camera strap.

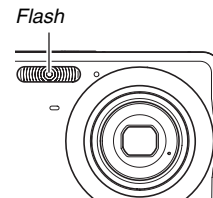



## Red-eye reduction

Using the flash to shoot at night or in a dimly lit room can cause red spots inside the eyes of people who are in the image. This is caused when the light from the flash reflects off of the retina of the eye. When red-eye reduction is selected as the flash mode, the camera fires a pre-flash to cause the irises in the eyes of any people in the image to close, which reduces the chance of red eye.

### **IMPORTANT!**

- Note the following important points when using red-eye reduction.
  - Red-eye reduction does not work unless the people in the image are looking directly at the camera (flash). Before pressing the shutter button, call out to the subjects so they all look at the camera.
  - Red-eye reduction may not work very well if the subjects are located far away from the camera.

## ■ Checking the Flash Mode

The current flash mode is indicated on the monitor screen and by the operation lamp when you half-press the shutter button.

### Operation Lamp

*Flashes orange while the flash is charging.*



“” indicates flash will fire.

- You will not be able to take another flash snapshot until the operating lamp stops flashing orange, which indicates that charging is complete.

## ■ Changing the Flash Intensity

1. In the REC mode, press [MENU].
2. On the “Quality” tab, select “Flash Intensity” and then press [▶].
3. Use [▲] and [▼] to select the flash intensity setting you want and then press [SET].

You can set one of five levels, from -2 (weakest) to +2 (strongest).

### ★ IMPORTANT!

- Flash intensity may not change when the subject is too far away or too close.

## ■ Using Flash Assist

The subject in an image will look too dark if flash intensity is not enough to reach a subject that is too far away. When this happens, you can use flash assist to supplement the brightness of the subject so it appears as if flash illumination was sufficient.



*Flash assist not used*



*Flash assist used*

Flash assist is turned on as the initial factory default setting. Use the following procedure to turn off flash assist when you do not want to use it.

1. In the REC mode, press [MENU].
2. On the “Quality” tab, select “Flash Assist” and then press [▶].
3. Use [▲] and [▼] to select “Off” and then press [SET].

When you want to use flash assist, select “Auto” here.

### **IMPORTANT!**



- Flash assist may not produce the desired result for some types of subjects.
- Any of the following can result in the flash assist effect being canceled out.
  - Changing the flash intensity (page 74)
  - Correcting brightness (EV shift) (page 125)
  - Changing ISO sensitivity (page 129)
  - Changing the contrast setting (page 134)

### ■ **Flash Precautions**

- The desired effect may not be obtained when the subject is too far away or too close.
- Flash charging time depends on operating conditions (battery condition, ambient temperature, etc.) With a fully charged battery, it takes anywhere from a few seconds to 7 seconds.
- Shooting with flash turned off when lighting is dim results in a slow shutter speed, which can cause image blur due to hand movement. Secure the camera with a tripod, etc.
- With red eye reduction, the flash is fired automatically in accordance with exposure. It does not fire in areas where lighting is bright.
- The presence of outdoor sunlight, fluorescent lighting, or some other light source can cause abnormal image colors.

## Using the Self-Timer

With the self-timer, pressing the shutter button starts a timer, and the shutter is released and the image is shot after a fixed amount of time.

Self-Timer Type	Description
 10 sec	10-second self-timer
 2 sec	2-second self-timer <ul style="list-style-type: none"><li>When shooting under conditions that slow down the shutter speed, you can use this setting to prevent blur due to hand movement.</li></ul>
 X3 (Triple Self-timer)	This option shoots three images: one image 10 seconds after the shutter button is pressed, the next image one second after the camera gets ready to shoot after the first image, and the final image one second after the camera gets ready to shoot after the second image.
Off	Self-timer is disabled.

1. In the REC mode, press [MENU].
2. On the “REC” tab, select “Self-timer” and then press [▶].
3. Use [▲] and [▼] to select the self-timer type and then press [SET].

This causes an indicator identifying the selected self-timer type to appear on the monitor screen.

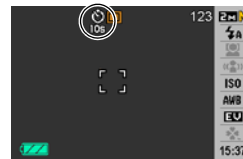

4. Press the shutter button to shoot.

### NOTE

- You can use the Operation Panel (page 53) to change the self-timer setting in the movie mode only.

## Using the Self-timer to Shoot an Image

- The image is not shot right away after you press the shutter button. Instead, shooting starts after the preset time elapses. The self-timer lamp flashes while the countdown is being performed.
- You can interrupt an ongoing self-timer countdown by fully pressing the shutter button while the self-timer lamp is flashing red.

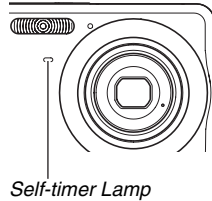



## NOTE

- The indicator "1sec" appears on the monitor screen between Triple Self-timer shots. How long it takes for the camera to get ready to shoot again after it shoots an image depends on the image size and quality settings, whether or not a memory card is loaded in the camera, and the flash charge condition.
- No self-timer operation can be performed when recording with the any of the following settings.
  - Normal-speed continuous shutter mode or high-speed continuous shutter mode
  - Recording with certain BEST SHOT scenes (Short Movie, Past Movie, Layout, Auto Framing, Voice Recording)
- The Triple Self-timer cannot be used when performing the following recording operations.
  - Recording with Flash Continuous Shutter
  - Recording with certain BEST SHOT scenes (Business Cards and Documents, Whiteboard, etc., Old Photo, ID Photo, Movie, For YouTube)

## Using Continuous Shutter

Your camera has three continuous shutter modes.

Continuous Shutter Mode	Description
 Normal Speed (Normal-speed Continuous Shutter)	Continually records images until memory becomes full.
 High Speed (High-speed Continuous Shutter)	Continually records images at a speed that is faster than Normal-speed Continuous Shutter, until memory becomes full. Image size is fixed at 2M (1600 × 1200 pixels).
 Flash Cont. (Flash Continuous Shutter)	Use this mode to record up to three consecutive images, firing the flash for each one.

## Selecting the Continuous Shutter Mode

1. In the REC mode, press [MENU].
2. On the “REC” tab, select “Continuous” and then press [▶].
3. Use [▲] and [▼] to select the mode you want and then press [SET].

This enables the continuous shutter mode you selected and displays its icon on the monitor screen.

To turn off continuous shutter, select “Off”.

## Recording with Normal-speed Continuous Shutter, High-speed Continuous Shutter, and Flash Continuous Shutter

### 1. Press the shutter button to shoot.



- With Normal-speed continuous shutter and High-speed continuous shutter, images continue to be shot as long as you keep the shutter button depressed. Releasing the shutter button stops shooting.
- Flash continuous shutter can shoot up to three images. Shooting stops if you release the shutter button before three images are recorded.



#### **IMPORTANT!**

- The speed of normal speed continuous shutter and high-speed continuous shutter depend on the type of memory card being used and the amount free space available in memory. When shooting to built-in memory, continuous shutter shooting is relatively slow.

## Continuous Shutter Precautions

- Starting a continuous shutter operation causes the exposure and focus settings to be fixed at the levels for the first image. The same settings are applied to all subsequent images.
- Continuous shutter cannot be used in combination with any of the following features.
  - Face recognition
  - Some BEST SHOT scenes (Layout, Auto Framing, Business Cards and Documents, Whiteboard, etc., Old Photo, ID Photo, Movie, Short Movie, Past Movie, For YouTube, Voice Recording)
- When using a continuous shutter mode, keep the camera still until all recording is finished.
- A continuous shutter operation may stop part way through if memory capacity runs low.
- The continuous shutter rate depends on the current image size and image quality settings.
- You can select the flash mode you want with normal-speed continuous shutter mode.
- With high-speed continuous shutter, the flash mode automatically becomes “” (flash off).
- With the flash continuous shutter mode, the flash mode automatically becomes “” (flash on).

- Note that the resolution of images recorded with the high-speed continuous shutter mode or flash continuous shutter mode is somewhat lower resolution and more prone to digital noise than images recorded with the normal-speed continuous shutter mode.
- “Auto” ISO sensitivity always is used for the high-speed continuous shutter mode or flash continuous shutter mode, regardless of the current ISO sensitivity setting.
- With the flash continuous shutter mode, the flash range is narrower than normal.

## Adding Audio to a Snapshot

You can add an audio recording to snapshots, if you want. Use this feature to add a verbal explanation or a description of the mood to a snapshot, or to capture the sounds of the people in the snapshot.

- You can record up to about 30 seconds of audio for a single snapshot.

### ■ Turning on Audio Snapshot

- 1. In the REC mode, press [MENU].**
- 2. On the “REC” tab, select “Audio Snap” and then press [▶].**
- 3. Use [▲] and [▼] to select “On” and then press [SET].**



## ■ Recording Audio for a Snapshot

### 1. Press the shutter button to shoot.

This monitor screen will show the image you just shot, along with the “” icon.

- If you do not want to record audio at this time, press [MENU]. This will display the monitor screen for shooting the next image.



*Remaining Recording Time*

### 2. Press the shutter button to start audio recording.

### 3. Press the shutter button again to stop audio recording.

Recording will stop automatically after about 30 seconds if you do not press the shutter button.

- To turn off the audio snapshot feature, select “Off” in step 3 of the procedure under “Turning on Audio Snapshot”.

## Playing Back Snapshot Audio

Audio snapshots in the PLAY mode are indicated by the “” icon.

Press [SET] while an audio snapshot is displayed to play back its audio.

- For information about the playback operation, see page 145.



### **IMPORTANT!**

- Take care that you do not block the camera's microphone with your fingers while recording.
- Good recording results are not possible when the camera is too far away from what you are trying to record.

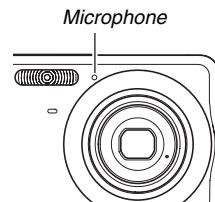



## NOTE

- After transferring an audio snapshot to your computer's hard disk, you can play back the audio using QuickTime (page 222).
- The following shows the formats used for storing audio snapshot data.
  - Image Data: JPEG (.JPG extension)
  - Audio Data: WAVE/ADPCM (.WAV extension)
  - Approximate Audio File Size: 165 KB (30-second recording at 5.5KB per second)
- You cannot turn off the monitor screen by pressing [▲] (DISP) while audio recording is in progress.
- Audio snapshot capabilities are disabled while shooting with the Triple Self-timer or with a continuous shutter mode. You can, however, add audio to such a snapshot after you record it (page 176).

## Face Recognition

The face recognition feature gives priority to the human faces in an image for focus and brightness settings. The following describes two available face recognition modes.

Face Recognition Mode	Description
 Normal mode	Detects human faces and adjusts focus and brightness accordingly. <ul style="list-style-type: none"><li>• When multiple faces are detected, image is given to any relatively large face located in the center of the image.</li></ul>
 Family First mode	Detects human faces. When multiple faces are detected, this mode gives setting priority to the faces of family members whose faces have been registered using Record Family.

## Performing a face recognition recording operation (Normal Mode)

1. In the REC mode, press [SET].

2. Use [▲] and [▼] to select the third option from the top in the operation panel (Face Recognition).



3. Use [◀] and [▶] to select “ Face Detection: Normal” and then press [SET].

4. Point the camera at the subjects.

The camera will detect the faces of any people in the image. The detected faces all will be bounded by frames after detection is complete.



5. Half-press the shutter button.

The focus frame of the face that is focused becomes green.

6. When you are ready to shoot, press the shutter button the rest of the way.

The camera will adjust its settings so the framed faces are of proper brightness.

### NOTE

- Half pressing the shutter button to perform face recognition while “ (Tracking)” (page 119) is selected for the AF area will cause the focus frame to follow the movement of the face.

## Using the Family First Mode to Give Priority to Particular Faces

### ■ Using Record Family to Pre-record Face Data

To use the Family First mode, you need to pre-record facial data for the friends and family members to which you want to give priority.

1. In the REC mode, press [SET].
2. Use [▲] and [▼] to select the third option from the top in the operation panel (Face Recognition).
3. Use [◀] and [▶] to select “ Record Family” and then press [SET].
4. Point the straight at the person whose face you want to record, adjust as required to the face fits within the frame on the monitor screen, and then press the shutter button.

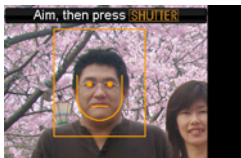

5. When the message “Face recognition successful!” appears, use [▲] and [▼] to select “Save” and then press [SET].

This will record the face data and return to the recording screen.

- To re-record the face data, select “Cancel”.

### NOTE

- You can have up to six sets of face data recorded in the camera.
- Face data is stored in the camera's built-in memory, in a folder named “FAMILY” (page 238). Any manipulation of the data in the “FAMILY” folder can cause the camera to stop operating properly. Never delete or edit any data in the “FAMILY” folder.

## ■ Using Edit Family to Assign a Priority Level to Recorded Face Data

After recording face data, you can assign a name and a priority level that controls how the data is applied when shooting a snapshot.

1. In the REC mode, press [SET].
2. Use [▲] and [▼] to select the third option from the top in the operation panel (Face Recognition).
3. Use [◀] and [▶] to select “👤 Edit Family” and then press [SET].  
This display the face data editing screen.
4. Use [▲], [▼], [◀], and [▶] to select the face data you want to edit, and then press [SET].
5. Use [◀] and [▶] to select a name, and then press [▼].
  - You can select any one of 12 preset names to face data.



## 6. Use [◀] and [▶] to select the priority level you want and then press [SET].

- You can select any one of four levels, from “• • ★” (Lowest) to “★ ★ ★” (Highest). Selecting “• • •” (Disabled) will disable face recognition.

### Deleting recorded face data

Perform the following steps when you want to delete recorded face data.

1. In the REC mode, press [SET].
2. Use [▲] and [▼] to select the third option from the top in the operation panel (Face Recognition).
3. Use [◀] and [▶] to select “👤 Edit Family” and then press [SET].
4. Press [MENU].

## 5. Use the procedures under “Deleting a Specific File” (page 187) and “Deleting All Files” (page 188) to delete the face data you want.

- You can exit this procedure by pressing [MENU].

### NOTE

- Formatting the camera’s built-in memory (page 200) deletes all the recorded face data.

## ■ Shooting a Snapshot using Recorded and Edited Face Data

After you record and edit face data, you can use it to shoot photographs. The camera will record images in accordance with the priority levels you configured for each set of face data.

1. In the REC mode, press [SET].
2. Use [▲] and [▼] to select the third option from the top in the operation panel (Face Recognition).
3. Use [◀] and [▶] to select “ Face Recognition: Family First” and then press [SET].

#### 4. Point the camera at the subjects.

The camera will detect the faces of the people whose face data has been saved in camera memory. The detected faces all will be bounded by frames after detection is complete.

- The frames will be colored according to the priority level of the face: White (lowest), yellow, or green (highest). A green frame indicates the highest priority face when the image is recorded.

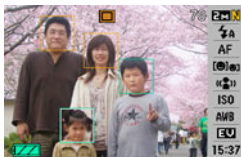

#### 5. Half-press the shutter button.

This will focus on the face with the highest priority (the one with the green frame) and adjust its brightness. When focusing is complete, a green focus frame will appear at the faces that were indicated by green frames in step 4 above.

#### 6. When you are ready to shoot, press the shutter button the rest of the way.

#### NOTE

- The “ (Tracking)” is selected for the AF area whenever “Family First” is selected as the face recognition mode (page 119).

#### Selecting the Face Detection Method (Priority)

Use the following procedure to specify whether you want to give priority to faster speed or a higher number of faces during face detection.

1. In the REC mode, press [SET].
2. Use [▲] and [▼] to select the third option from the top in the operation panel (Face Recognition).
3. Use [◀] and [▶] to select “ Priority” and then press [SET].

4. Use [▲] and [▼] to select the setting you want, and then press [SET].

To do this:	Select this setting:
Minimize face detection time. Up to five faces can be detected.	Speed
Allow detection of a maximum of five to ten faces.	Quantity

**NOTE**

- Selecting “Quantity” while using the Normal mode will make it possible to detect smaller faces at a greater distance than when “Speed” is selected.

## Face Recognition Precautions

- The maximum number of faces that can be detected at one time is five when “Speed” is selected for the “Priority” setting, and ten when “Quantity” is selected.
- Detection of the following types of faces is not supported.
  - A face that is partially obstructed by hair, sunglasses, a hat, etc
  - A face that is shaded from the light
  - A profile of a face that is not shot straight on
  - A face that is tilted left or right
  - A face that is very far away or very small
  - A face that is very close or very large
  - A face in an area that is very dark
- Face detection is not supported for animals or other non-human subjects.
- Even if you have the face of a family member recorded, the person’s facial expression, shooting conditions, or other factors can make proper recognition (highest priority assignment) impossible.
- Face recognition can be improved by recording multiple versions of the same person’s face indoors and outdoors, with different expressions, and at different angles.



- Face recognition in the Family First mode may be slower than in the Normal mode because the camera needs time to determine whether the faces in the image are the same as the recorded faces. Also, compared with the Normal mode, the Family First mode will not be able to recognize faces that are far away and small.
- If the camera is unable to find a face when you press the shutter button, it will focus on the center of the screen.
- Always make sure that Auto Focus (AF) is selected as the focus mode when shooting with face recognition. Use of no other focus mode is supported.
- When shooting with the camera held sideways (for a portrait orientation shot), face recognition may take more time when shooting with the camera held normally (landscape orientation).
- Face recognition cannot be used in combination with any of the following features.
  - Images recorded with certain BEST SHOT scenes (Business cards and documents, White board, etc., Old Photo, ID Photo, Movie, Short Movie, Past Movie, For YouTube, Layout, Auto Framing, Voice Recording)
- The following functions are disabled when shooting with face recognition.
  - Multi AF
  - Continuous Shutter

# SHOOTING A MOVIE



## Movie Image Quality

Before shooting a movie, you should specify a movie image quality setting. Movie image quality is a standard that determines the detail, smoothness, and clarity of a movie during playback. Shooting with the high-quality (HQ) setting will result in better image quality, but it also shortens the amount of time you can shoot.

- Each movie can be up to 10 minutes long. Movie recording stops automatically after 10 minutes of recording.

Image Quality (pixels)		Approximate Data Rate	Frame Rate
UHQ	640 × 480	5.8 Megabits/second	30 frames/second
UHQ Wide	848 × 480	7.0 Megabits/second	30 frames/second
HQ	640 × 480	2.8 Megabits/second	30 frames/second
HQ Wide	848 × 480	3.4 Megabits/second	30 frames/second
Normal	640 × 480	1.4 Megabits/second	30 frames/second

Image Quality (pixels)		Approximate Data Rate	Frame Rate
LP	320 × 240	545 Kilobits/second	15 frames/second

1. In the REC mode, press [MENU].
2. On the “Quality” tab, select “ Quality” and then press [▶].
3. Use [▲] and [▼] to select the quality setting you want and then press [SET].
  - The “ WIDE” indicator is on the monitor screen while “UHQ Wide” or “HQ Wide” is selected for the quality setting.

## Movie File Formats

Movies are recorded using H.264/AVC MOV format. Movies you shoot with your camera can be played back on a computer using QuickTime 7.

## Movie Size

The following shows the approximate movie file size for a one-minute movie.

Image Quality	Approximate Size
UHQ	43.3 MB
UHQ Wide	52.3 MB
HQ	20.8 MB
HQ Wide	25.3 MB
Normal	10.4 MB
LP	4.1 MB

## Shooting a Movie

Audio is also recorded while you shoot a movie. Audio is monaural.

1. In the REC mode, press [BS].
2. Use [▲], [▼], [◀], and [▶] to select the “” (Movie) scene and then press [SET].

This causes “” to appear on the monitor screen.

3. Press the shutter button to start shooting the movie.

- “REC” is displayed while movie recording is in progress.

*Remaining Recording Time*



*Recording Time*



#### 4. Press the shutter button again to stop shooting.

Each movie can be up to 10 minutes long. Movie recording stops automatically after 10 minutes of recording. Movie recording also will stop automatically if memory becomes full before you stop movie recording by pressing the shutter button.

#### Anti Shake Movie Recording

Turning on Anti Shake for movie recording causes the view angle to become smaller. Anti Shake reduces the effects of hand movement only. It does not limit the effects of subject movement (page 102).

### Movie Recording Precautions

- You cannot use flash while shooting a movie.
- The camera also records audio. Note the following points when shooting a movie.
  - Take care that the microphone is not blocked by your fingers, etc.
  - Good results are not possible when the camera is too far away from what you are trying to record.
  - Operating camera buttons while shooting can cause button noise to be picked up in the audio.
- Shooting a very bright subject can cause a vertical band to appear in the monitor screen image. This does not indicate malfunction. The band will be recorded in the case of a movie.
- Certain types of memory cards take longer to record data, which can cause movie frames to be dropped. “” and “” flash on the monitor screen during recording to let you know when a frame has been dropped. Use of a memory card with a maximum transfer speed of at least 10MB per second is recommended.

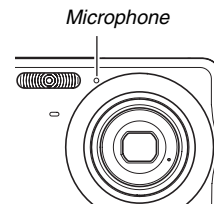

- Optical zoom is disabled while shooting a movie. Digital zoom only is available while shooting a movie. If you want to use a particular optical zoom setting, make sure you select it before you press the shutter button to start movie recording (page 69).
- The effects of camera movement in an image become more pronounced when you shoot close up or a large zoom factor. Because of this, use of a tripod is recommended under these conditions.
- When the subject is outside the camera's focus range, focusing is not possible and the image will be out of focus.

## Using Short Movie

Short Movie shoots a movie that starts four seconds before the shutter button is pressed and ends four seconds after it is pressed.

- Since four seconds of action before the shutter button is pressed are recorded, Short Movie is a good way to make sure you don't miss the action of kids or other active subjects.
- You can also use MOTION PRINT (page 174) to extract still images of Short Movie scenes.

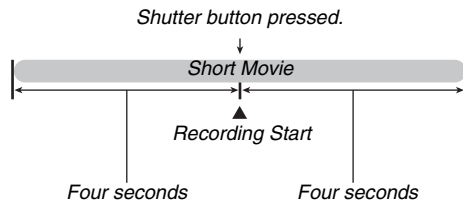

**1. In the REC mode, press [BS].**

**2. Use [▲], [▼], [◀], and [▶] to select the “Short Movie” scene and then press [SET].**

This causes “” to appear on the monitor screen.

Pressing the shutter button at this point will shoot a Short Movie with a 4-second first part and a 4-second second part.

**3. With the camera pointed at the subject, press the shutter button.**

This will shoot a Short Movie that for about four seconds, and then stop shooting automatically. The total length of the Short Movie will be eight seconds (four seconds before the shutter button was pressed plus four seconds after it was pressed). To stop movie recording, press the shutter button again.





#### **IMPORTANT!**

- Movie data is continually recorded and stored in a buffer before you press the shutter button. Keep the camera pointed at the subject. Then at the right moment, press the shutter button. When you press the shutter button, the remaining recording time of part two of the Short Movie counts down on the monitor screen.

## Using Past Movie

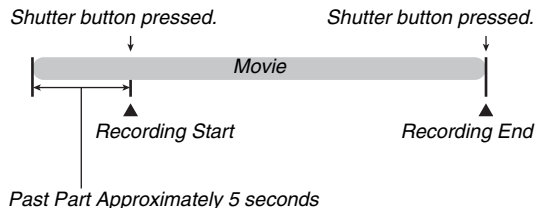
Past Movie is similar to a normal movie, except that it captures about five seconds of whatever happened in front of the lens before the shutter button was pressed to start shooting. Past Movie is a great way to make sure that you never just miss that special moment because you press the shutter button too late.



1. In the REC mode, press [BS].
2. Use [▲], [▼], [◀], and [▶] to select the “Past Movie” scene and then press [SET].  
This causes “” to appear on the monitor screen, which indicates that Past Movie is enabled.
3. With the camera pointed at the subject, press the shutter button.
4. Press the shutter button again to stop shooting.

Movie recording also will stop automatically if memory becomes full before you press the shutter button.

## **IMPORTANT!**

- When Past Movie is selected, the camera continually updates an internal buffer that holds about five seconds of movie images of what has happened in front of the camera's lens. When you press the shutter button, your movie will start with the buffer's current contents and continue from there. Be sure to keep the camera still and pointed in the direction of the subject for some time before you press the shutter button to start shooting.



# USING BEST SHOT

With BEST SHOT, you simply select the sample scene that is like the one you are trying to shoot, and the camera sets up automatically. Even difficult backlight scenes (which result in the main subject being too dark if set up improperly) come out looking great!

## ■ Some Sample Scenes

- Portrait



- Scenery



- Night Scene



- Night Scene Portrait



## ■ Selecting a Sample Scene

### 1. In the REC mode, press [BS].

This enters the BEST SHOT mode and displays a screen showing thumbnails of 15 sample scenes.

- The initial default selection is “” (Auto).

*Boundary  
(Currently Selected Sample Scene)*

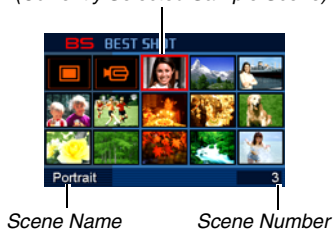

## 2. Use [▲], [▼], [◀], and [▶] to move the boundary to select the scene you want to select.

- Pressing [▲] or [▼] while the boundary is at the edge of the screen will scroll to the next screen of BEST SHOT scenes.
- Pressing the zoom button will display text that explains the settings configured by the selected scene (page 100). Press the zoom button again to return to the scene selection screen.
- To return to "Auto", select Scene 1, which is "□" (Auto). Pressing [MENU] while the scene selection screen or scene description text is on the monitor screen will cause the boundary to jump directly to "□" (Auto).

## 3. Press [SET] to apply the settings of the selected scene and return to the recording screen.

- The settings of the scene you selected remain in effect until you select a different scene.
- To select a different BEST SHOT scene, repeat the above procedure from step 1.

## 4. Press the shutter button.

- While the "📷" (Movie) scene is selected, pressing the shutter button starts and stops movie recording.

## **IMPORTANT!**

- Night Scene, Fireworks scenes use slow shutter speeds. Since a slow shutter speed increases the chance of digital noise in the image, the camera automatically performs a digital noise reduction process on slow shutter images. Because of this, such images take longer to store after you press the shutter button. Do not perform any key operation while an image is being stored. Also, it is a good idea to use a tripod to avoid image blur due to camera movement when shooting at slow shutter speeds.
- Your camera includes a sample scene that optimizes settings for auction site images. Depending on your camera model, the sample scene is named either “For eBay” or “Auction”. Images you record using the auction site sample scene are stored in a special folder so you can easily find them on your computer (page 239).
- The BEST SHOT “For YouTube” scene sets up the camera for recording movies that are optimized for uploading to YouTube. Movies recorded with the “For YouTube” scene are stored in a special folder to make them easy to locate for uploading (page 239). Note that the image quality of movies recorded with the “For YouTube” scene is always “Normal”. Maximum recording time is 10 minutes.
- BEST SHOT scenes were not shot using this camera.

- Images shot using a BEST SHOT scene may not produce the results you expected due to shooting conditions and other factors.
- You can change the camera settings that are made when you select a BEST SHOT scene. Note, however, that the BEST SHOT settings revert to their defaults when you select another BEST SHOT scene or turn off the camera. If you think you will later need to use a particular camera setup you configured, save it as a BEST SHOT user setup (page 101).

## Displaying Detailed Information about a BEST SHOT Scene

To display detailed information about a BEST SHOT scene, select it with the boundary on the scene selection screen and then press the zoom button.

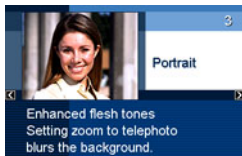

The following are the different operations you can perform while the scene description screen is on the display.

- To return to the scene selection screen, press the zoom button again.
- To scroll through available BEST SHOT scenes, use [◀] and [▶].
- To select the currently displayed scene and configure the camera with its settings, press [SET].

### NOTE

- If you select a scene by pressing [SET] while the description screen is displayed, the same description scene will appear the next time you press [BS] to view BEST SHOT sample scenes.

## ■ Creating Your Own BEST SHOT Scenes

You can use the procedure below to save the setups of snapshots that you shot as BEST SHOT scenes. After that, you can recall a setup whenever you want to use it.

1. In the REC mode, press [BS].
2. Use [▲], [▼], [◀], and [▶] to select “BEST SHOT” (Register User Scene) and then press [SET].
3. Use [◀] and [▶] to select the snapshot whose setup you want to register.
4. Use [▲] and [▼] to select “Save” and then press [SET].

Your BEST SHOT scene will be assigned the name “Recall User Scene”, along with a scene number.



### IMPORTANT!



- Formatting the camera’s built-in memory (page 200) deletes all the user BEST SHOT scene files.

### NOTE

- You can check the settings of the currently selected BEST SHOT scene by displaying the camera’s setting menus and looking at its settings.
- User scenes are assigned numbers in the sequence: U1, U2, and so on.
- The following are the settings that are included in a user scenes:  
Face Recognition, Focus, EV Shift, White Balance, Flash, ISO, Metering, Flash Intensity, Flash Assist, Color Filter, Sharpness, Saturation, Contrast
- You can store up to 999 BEST SHOT user scenes.
- User snapshot scenes are stored in camera built-in memory in the folder named “SCENE” (page 238).

## Deleting a BEST SHOT User Scene

Perform the following steps when you want to delete a BEST SHOT user scene.

- 1. In the REC mode, press [BS].**
- 2. Press the zoom button to display its explanation screen.**
- 3. Use [◀] and [▶] to select the BEST SHOT user scene you want to delete.**
- 4. Press [▼] (   ).**
- 5. Use [▲] and [▼] to select “Delete” and then press [SET].**

This will delete the BEST SHOT user scene you selected and display the next screen (either the next user scene or the Register User Scene).
- 6. Use [◀] and [▶] to select another scene and then press [SET].**
  - This returns to the recording state.

## Reducing the Effects of Hand and Subject Movement

You can turn on the camera's Anti Shake feature to reduce image blur due to subject movement or hand movement when shooting a moving subject using telephoto, when shooting a fast-moving subject, or when shooting under dim lighting conditions.

You can turn on Anti Shake using BEST SHOT or by performing a Panel operation.

### ■ Turning on Anti Shake Using BEST SHOT

- 1. In the REC mode, press [BS].**
- 2. Use [▲], [▼], [◀], and [▶] to select the “Anti Shake” scene and then press [SET].**

Anti Shake will remain selected until you select a different BEST SHOT scene.

## ■ Turning on Anti Shake Using the Panel (Operation Panel)

1. In the REC mode, press [SET].
2. Use [▲] and [▼] to select the fourth option from the top in the operation panel (Anti Shake).
3. Use [◀] and [▶] to select “Auto” and then press [SET].
  - This turns on Anti Shake and displays “” on the monitor screen.
  - In this case, Anti Shake will remain on until you turn it off on the Panel.

## **IMPORTANT!**

- Anti Shake will not work unless the ISO setting (page 129) is set to “Auto”.
- Though “” (Anti Shake) is displayed on the monitor screen following an automatic flash operation using the “Auto Flash” or “Red Eye Reduction” setting, or while the flash setting is “Flash On” or “Soft Flash”, Anti Shake is disabled.
- Shooting with Anti Shake can cause an image to appear somewhat coarser than normal and can cause slight deterioration of image resolution.
- Anti Shake may not be able to eliminate the effects of hand or subject movement when movement is severe.
- You can also use Anti Shake to reduce the effects of hand movement only while recording a movie. The effects of subject movement are not limited (page 92).
- Anti Shake may not work with a very low shutter speed. If this happens, use a tripod to stabilize the camera.
- The camera sometimes performs an automatic noise reduction operation to reduce digital noise in images recorded under certain lighting conditions. This operation causes the camera to take longer than normal to store the image and be ready for the next shot.

## Taking Bright Images without Flash

The BEST SHOT “High Sensitivity” scene makes it possible for you to take natural looking images without using the flash, even when lighting is low

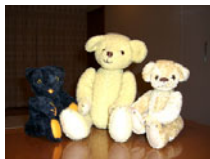

*Normal Snapshot (With flash)*    *Snapshot with High Sensitivity*

- 1. In the REC mode, press [BS].**
- 2. Use [▲], [▼], [◀], and [▶] to select the “High Sensitivity” scene and then press [SET].**
- 3. Press the shutter button to shoot the image.**

High Sensitivity will remain selected until you select a different BEST SHOT scene.

## ★ IMPORTANT!

- High Sensitivity is disabled following an automatic flash operation using the “Auto Flash” or “Red Eye Reduction” setting, or while the flash setting is “Flash On” or “Soft Flash”.
- Shooting with High Sensitivity can cause an image to appear somewhat coarser than normal and can cause slight deterioration of image resolution.
- The desirable level of image brightness may not be possible under very dark conditions.
- When shooting with slow shutter speeds, use a tripod to protect against the effects of hand movement.
- The camera sometimes performs an automatic noise reduction operation to reduce digital noise in images recorded under certain lighting conditions. This operation causes the camera to take longer than normal to store the image and be ready for the next shot.



## Shooting Images of Business Cards and Documents (Business Shot)

Shooting a business card, document, whiteboard, or similarly shaped object from an angle can cause the subject to appear misshaped in the resulting image. The BEST SHOT Business Shot scenes correct the shape of rectangular objects so they appear natural.



Before Keystone Correction

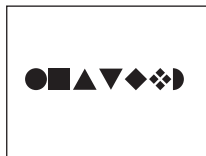

After Keystone Correction

BEST SHOT has two Business Shot scenes from which to choose.

- Business cards and documents
- White board, etc.



### ■ Selecting a Business Shot Scene

1. In the REC mode, press [BS].
2. Use [▲], [▼], [◀], and [▶] to select the “Business cards and documents” or the “White board, etc.” scene and then press [SET].

Whichever you select will remain in effect until you select a different BEST SHOT scene.

## ■ Shooting an Image Using a Business Shot Scene

1. After selecting either of the **BEST SHOT Business Shot** scenes, compose the image and press the shutter button to shoot.

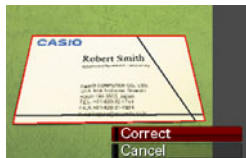

This displays a screen that shows all of the rectangular shapes in the image that qualify as candidates for keystone correction.

A red boundary will surround the currently selected correction candidate. If there is a black boundary, it means that the black boundary is indicating a second possible candidate. If there is no second candidate (black boundary), jump directly to step 3.

- If the camera is unable to detect any keystone correction candidate at all, the message "Cannot correct image!" will appear on the monitor screen momentarily and then the camera will save the image as-is (uncorrected).

2. Use [◀] and [▶] to select the candidate you want to use for correction.
3. Use [▲] and [▼] to select "Correct" and then press [SET].

This will correct the image and store the resulting (corrected) image.

- To cancel the correction operation, select "Cancel".

## **IMPORTANT!**

- Make sure the entire object you are trying to shoot (correct) is enclosed within the monitor screen. The camera will not be able to detect the shape of the object correctly unless it is enclosed entirely within the monitor screen.
- Correction will not be possible if the subject is the same color as its background. Make sure the object is against a background that allows its outline to stand out.
- Digital zoom is disabled while shooting with a Business Shot scene. However, you can use optical zoom.
- The maximum Business Shot image size is 2M (1600 × 1200 pixels), even if the camera is configured for a larger image size. When the camera is configured to record images smaller than 2M (1600 × 1200 pixels), Business Shot scenes will produce images in accordance with the currently specified image size.

## Shooting ID Photographs

You can use this procedure to shoot a portrait and then print it out in a variety of different standard ID photo sizes.

The following are the ID photo sizes that are included on the printout.

30 × 24mm, 40 × 30mm, 45 × 35mm, 50 × 40mm, 55 × 45mm

### ■ Selecting the ID Photo Scene

1. In the REC mode, press [BS].
2. Use [▲], [▼], [◀], and [▶] to select the “ID Photo” scene and then press [SET].

ID Photo will remain selected until you select a different BEST SHOT scene.

## ■ Shooting an Image Using the ID Photo Scene

1. On the monitor screen, compose the image by positioning the subject within the on-screen frame and then press the shutter button to shoot an initial temporary image.

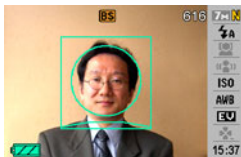

- The initial temporary image is not saved in memory. The final image is saved in memory when you perform step 3, below.

2. Align the guidelines that appear on the monitor screen with the subject in the recorded image.



Align the subject so the head fills the oval boundary. Also make sure that the subject's head is within the head line and the chin line.

To do this:	Perform this operation:
Move the subject up, down, left, and right	Use [▲], [▼], [◀], [▶].
Enlarge the subject	Press the zoom button [🔍].
Reduce the size of the subject	Press the zoom button [🔍].

3. When everything is the way you want, press [SET].

This saves the image in memory.

## **IMPORTANT!**

- The size of the ID photo image for this operation is fixed automatically at 7M (3072 × 2304 pixels).

### ■ **Printing an ID Photo**

Printing an ID photo image will print the same image in various sizes on a single sheet of paper. Then you can cut out the image(s) you want to use.

## **IMPORTANT!**

- The ID photo sizes provided here are not exact. Actual sizes may be slightly larger.
- When printing an ID photo, be sure to print on 4" × 6" size paper. Images may not print at the proper sizes if another size of paper is used.
- When printing an ID photo, be sure to set up your printer for "borderless print". For full details, see the user documentation that comes with your printer.

## **Restoring an Old Photograph**

With Old Photo, you can record the image of an old, faded photograph and then use the camera's built-in advanced digital camera technology to restore it.

### ■ **Before Recording with Old Photo**

- Make sure the entire photograph you are trying to record is enclosed within the monitor screen.
- Make sure the photograph is against a background that allows its outline to stand out, and that it fills the monitor screen to the maximum extent possible.
- Make sure that light is not reflecting off the surface of the original photograph when recording it.
- If the old photograph is portrait orientation, be sure to compose the image with the camera in landscape (horizontal) orientation.

## NOTE

- When the camera is at an angle to the photograph you are recording, the shape of the photograph may appear distorted in the recorded image. Auto keystone correction corrects for this distortion, which means that a photograph appears normal even if you record it at an angle.

## ■ Selecting the Old Photo Scene

- In the REC mode, press [BS].
- Use [▲], [▼], [◀], and [▶] to select the “Old Photo” scene and then press [SET].

“Old Photo” will remain selected until you select a different BEST SHOT scene.

## ■ Recording an Image with Old Photo

- Press the shutter button to shoot the image.

- This displays a photograph contour confirmation screen and then saves the original recorded image.

An error message will appear (page 257), without displaying the photograph contour confirmation screen, if the camera is unable to find the contour of the photograph.

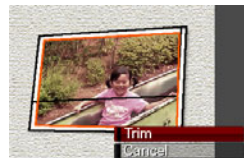

- Use [◀] and [▶] to select the candidate you want to correct.
- Use [▲] and [▼] to select “Trim” and then press [SET].

This displays a cropping boundary on the monitor screen.

- To cancel the correction operation, select “Cancel”.

4. Use the zoom button to change the cropping boundary to the desired size.



5. Use [▲], [▼], [◀], and [▶] to move the selection boundary to the desired location and then press [SET].

The camera will correct color automatically and save the corrected image.

- If you do not want a border around the resulting image, select an area that is smaller than the original image.
- To cancel the restoration operation at any point and save the image as-is, press [MENU].

### ★ **IMPORTANT!**

- Digital zoom is disabled while recording with Old Photo. However, you can use optical zoom.
- When recording the image of a photograph, the camera will not be able to recognize the shape of the photograph in the following cases.
  - When part of the photograph extends outside of the monitor screen
  - When the subject is the same color as the background it is placed upon
- The maximum Old Photo image size is 2M (1600 × 1200 pixels). When the camera is configured to record images smaller than 2M (1600 × 1200 pixels), Old Photo will produce images in accordance with the currently specified image size.
- Under certain conditions, restored colors may not produce the desired results.

## Recording Snapshots into a Multi-image Layout (Layout Shots)

You can create a multi-snapshot image by recording snapshots into the frames that are arranged in a preset pattern. This lets you create album-like arrangements of related images in a single image. BEST SHOT scenes are available with three frames and two frames.

- Layout (Two Images)



- Layout (Three Images)



1. In the REC mode, press [BS].
2. Use [▲], [▼], [◀], and [▶] to select “Layout”, and then press [SET].
3. Use [◀] and [▶] to select a background color.
4. Press the shutter button to record the first image.

The camera will record the first snapshot and then get ready for the next one.



Frame



## 5. Press the shutter button again to record the next snapshot.

- If you are shooting into a three-frame layout, press the shutter button a third time to record the third image.
- Pressing [SET] during steps 4 or 5 of the above procedure will toggle between the layout screen (the one with the frames on it) and a screen that uses the entire display area to compose the image you are shooting.
- To clear the currently recorded Layout images and restart an ongoing Layout operation, press [MENU]. Next, continue from step 4 above.
- You cannot save a multi-snapshot image unless there are snapshots recorded in each of the available frames.



### **IMPORTANT!**

- Only the final multi-snapshot image is saved in camera memory. The individual snapshots are not saved.
- The size of the multi-snapshot image for this operation is fixed automatically at 7M (3072 × 2304 pixels).
- While Layout Shot is being used, the setup of the camera is changed automatically as shown below.
  - ISO Sensitivity: Auto (fixed)
  - AF Area: Spot (fixed)
- The following functions are disabled during Layout Shot.
  - Digital Zoom
  - Self-timer
  - Continuous Shutter
  - Face Recognition

## Auto Tracking a Moving Subject (Auto Framing)

With auto tracking, a boundary area follows a moving subject, making it easy to snap an image with the subject in the center.

1. In the REC mode, press [BS].
2. Use [▲], [▼], [◀], and [▶] to select “Auto Framing”, and then press [SET].
3. Align the focus frame with the subject you want to focus on and then half-press the shutter button.

- The focus frame and the cropping boundary will follow the subject as it moves.
- Focusing of the subject continues to be performed while you keep the shutter button half pressed.

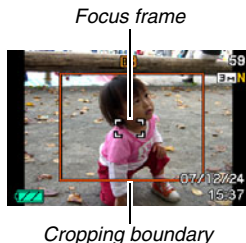

## 4. Press the shutter button all the way to record the image.

- This will record the area enclosed within the cropping boundary.

### IMPORTANT!

- Only the part of the image within the cropping boundary will be recorded.
- The image size for this operation is fixed automatically at 3M (2048 × 1536 pixels).
- The following functions are disabled during Auto Framing.
  - Timestamp
  - Self-timer
  - Continuous Shutter
  - Face Recognition
- Auto Framing may not be able to follow a fast-moving subject. If this happens, release the shutter button, re-align the focus frame with the subject, and then half-press the shutter again.
- When shooting with “Auto Framing”, the image size is fixed at 3M (2048 × 1536 pixels) and the Undeteriorated Image Quality Range is 3X (page 70).

# ADVANCED SETTINGS

## Changing the Focus Mode

Your camera provides you with the five focus modes described below. The initial factory default focus mode is Auto Focus.

Focus Mode	Description	Focus Range*						
<b>AF</b> Auto Focus	Automatic focus when the shutter button is half-pressed. During movie recording, the Auto Focus mode is disabled.	Auto adjustment (Approximately 40 cm to $\infty$ (1.3' to $\infty$ )) <ul style="list-style-type: none"><li>• Minimum distance position varies with optical zoom.</li></ul>						
<b>MF</b> Macro (Close-up)	Used for close-up shooting. Macro Focus becomes fixed focus while shooting a movie.	Auto adjustment (10 cm to 50 cm (3.9" to 19.7")) <ul style="list-style-type: none"><li>• Minimum distance position varies with optical zoom.</li></ul>						
<b>PF</b> Pan Focus	Fixed focus for relatively wide-range focusing. Use Pan Focus (PF) under conditions where Auto Focus is difficult.	Fixed distance <ul style="list-style-type: none"><li>• Focus range varies with optical zoom position.</li></ul>						
<b><math>\infty</math></b> Infinity	Focus is fixed at infinity. Use this mode when shooting scenery and other faraway images.	Infinity						
<b>MF</b> Manual Focus	Focus is performed manually.	<ul style="list-style-type: none"><li>• Focus range varies with optical zoom factor.</li></ul> <table border="1"><thead><tr><th>Optical Zoom Factor</th><th>Range</th></tr></thead><tbody><tr><td>1X</td><td>10 cm to <math>\infty</math> (0.3' to <math>\infty</math>)</td></tr><tr><td>3X</td><td>60 cm to <math>\infty</math> (2.0' to <math>\infty</math>)</td></tr></tbody></table>	Optical Zoom Factor	Range	1X	10 cm to $\infty$ (0.3' to $\infty$ )	3X	60 cm to $\infty$ (2.0' to $\infty$ )
Optical Zoom Factor	Range							
1X	10 cm to $\infty$ (0.3' to $\infty$ )							
3X	60 cm to $\infty$ (2.0' to $\infty$ )							

\* "Focus Range" indicates distance from the lens surface.

Perform the following steps to change the focus mode.

1. In the REC mode, press [MENU].
2. On the “REC” tab, select “Focus” and then press [▶].
3. Use [▲] and [▼] to select the focus mode setting you want and then press [SET].

An icon appears on the monitor screen to indicate the current focus mode.

- See the following pages of this section for details about shooting with each focus mode.

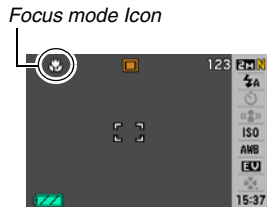

## Using Auto Focus

1. Align the monitor screen's focus frame with the subject you want to focus and then half-press the shutter button.

This camera will perform the focus operation.

You can tell if the image is in focus by checking the operation lamp and the focus frame color.

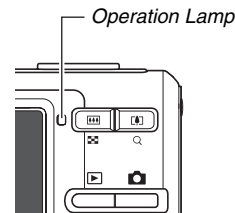
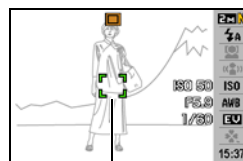

Status	Operation Lamp	Focus Frame
Focusing Complete	Lit Green	Green
Not Focused	Flashing Green	Red

## 2. When the image is focused, press the shutter button the rest of the way to shoot.

### **IMPORTANT!**

- During movie recording, the Auto Focus mode is disabled.

### **NOTE**

- When proper focusing is not possible because the subject is closer than the Auto Focus range, the camera will switch to the Macro Focus range automatically (Auto Macro).
- Whenever you perform an optical zoom operation while shooting with Auto Focus, a value will appear on the monitor screen as shown below to tell you the focus range.

Example: ○○ cm – ∞

\* ○○ will be replaced by the actual focus range value.

## Using Macro Focus

### 1. Half-press the shutter button to focus the image.

The focus operation is the same as that for Auto Focus.

### 2. When the image is focused, press the shutter button the rest of the way to shoot.

### **IMPORTANT!**

- Use of the flash along with Macro Focus can cause the light of the flash to become blocked, which can produce unwanted lens shadows in your image.
- Macro Focus becomes fixed focus while shooting a movie.

## NOTE

- When Macro Focus cannot focus properly because the subject is too far away, the camera will switch to the Auto Focus range automatically (Auto Macro).
- Whenever you perform an optical zoom operation while shooting with Macro Focus, values will appear on the monitor screen as shown below to tell you the focus range.

Example: ○○ cm – ○○ cm



\* ○○ will be replaced by the actual focus range values.

## Auto Focus and Macro Focus Shooting Tips

### Changing the Auto Focus Area

Use the following procedure to change the metering area used for Auto Focus (AF).

1. In the REC mode, press [MENU].
2. On the “REC” tab, select “AF Area” and then press [▶].
3. Use [▲] and [▼] to select the setting you want and then press [SET].

To do this:	Select this setting:
Use a small area in the center of the screen for metering <ul style="list-style-type: none"><li>• This setting is best when you want to use focus lock (page 121).</li></ul>	 Spot
When the shutter button is half-pressed, have the camera automatically select one or more of nine possible focus frames <ul style="list-style-type: none"><li>• If the camera is able to focus on multiple points, all applicable focus frames turn green.</li></ul>	 Multi

To do this:	Select this setting:
Half-pressing the shutter button focuses the subject and also starts a focus tracking operation that keeps the focus frame on the subject as it moves.	 Tracking

## NOTE

- When you select “ Multi” as the focus area, nine focus frames appear on the monitor screen. The camera will automatically determine the optimum focus frame(s), which will change to green on the monitor screen.

 Spot /  Tracking

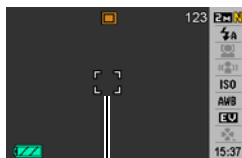

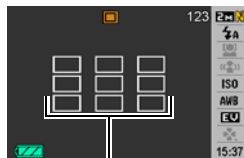

*Focus Frame*

 Multi



*Focus Frame*

- “ Multi” cannot be used in the Face Recognition Normal mode or the Family First mode (page 82).
- If you select “ Tracking” while using continuous shutter or self-timer, subject will be tracked until image recording starts.



## Using Focus Lock

“Focus lock” is the name of a technique you can use when you want to shoot an image in which the subject to be focused on is not within the focus frame in the center of the screen.

- Use focus lock with “[L/AF-ON] Spot” or “[L/AF-ON] Tracking” focus.

- 1. Align the monitor screen’s focus frame with the subject you want to focus on and then half-press the shutter button.**

*Subject to be focused on*

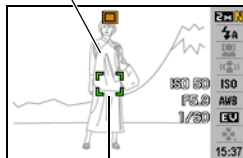

*Focus Frame*

- 2. Keeping the shutter button half-pressed, re-compose the image as you like.**

- When “[L/AF-ON] Tracking” is selected as the Auto Focus area, the focus frame will move automatically and follow the subject.

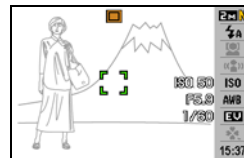

- 3. When the image is focused, press the shutter button the rest of the way to shoot.**

### NOTE

- Focus lock also causes exposure (AE) to be locked.

## Quick Shutter

If you press the shutter button all the way without waiting for Auto Focus while Quick Shutter is turned on, the camera will record the image using a high-speed focus operation that is much faster than normal Auto Focus. This helps to avoid missing a special moment while you wait for the camera to Auto Focus.

- Some images may be out of focus when Quick Shutter is used.

- 1. In the REC mode, press [MENU].**
- 2. On the “REC” tab, select “Quick Shutter” and then press [▶].**
- 3. Use [▲] and [▼] to select the setting you want and then press [SET].**

To do this:	Select this setting:
Turn on Quick Shutter	On
Turn off Quick Shutter	Off

## 4. Press the shutter button all the way down without pausing.

Pressing the shutter button all the way without pausing at the halfway type will record with Quick Shutter, without performing the normal Auto Focus operation.



### **IMPORTANT!**

- Quick Shutter will not work when you are using a very high zoom factor. In this case, you should use Auto Focus instead.

## Using Fixed Focus (Pan Focus)

Pan Focus (PF) fixes focus for a relatively wide focus range, which means you can shoot without waiting for the Auto Focus operation to finish.

1. When you are ready to shoot, press the shutter button all the way, without pausing.

## Using Infinity Focus

As its name suggests, Infinity Focus fixes focus at infinity ( $\infty$ ). Use this mode when shooting scenery and other faraway subjects. Infinity Focus also comes in handy when shooting from a car or train window, or when shooting scenery or other subjects that are difficult to focus properly with Auto Focus.

1. While Infinity Focus is selected as the focus mode, press the shutter button to shoot.

## Using Manual Focus

With Manual Focus, the camera automatically enlarges the subject on the monitor screen, which helps you manually adjust focus. Manual focus can be used for shoot such images as moving trains. Before the train arrives, manually focus on an electric pole or some other object. Then when the train passes the object you focused on, you can shoot without worrying about focus.

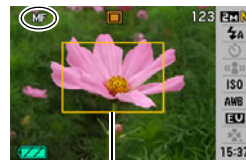

*Yellow Boundary*

1. While Manual focus is selected as the focus mode, compose the image on the monitor screen so the subject you want to focus on is within the yellow boundary.

## 2. Use [◀] and [▶] to focus the image, as you view the results on the monitor screen.

At this time the image that is within the boundary will enlarge and fill the monitor screen, which aids in focusing.

For this:	Press this button:
Closer focus	[◀]
More distant focus	[▶]

- The monitor screen will return to step 1 if you do not perform any operation for about two seconds.

## 3. Press the shutter button to shoot.

### NOTE

- Whenever you perform an optical zoom operation (page 68) while shooting with manual focus, a value will appear on the monitor screen as shown below to tell you the focusing range.

Example: MF ○○ cm – ∞

\* ○○ will be replaced by the actual focus range values.



### IMPORTANT!

- While Manual Focus is selected as the focus mode, the [◀] and [▶] keys are used to adjust the focus setting. Any other functions assigned to the [◀] and [▶] keys with Key Customize (page 138) are not performed when you press the keys during manual focus.

## Correcting Image Brightness (EV Shift)

You can manually adjust an image's exposure value (EV value) before shooting it. This feature helps to achieve better results when shooting a backlit subject, a strongly lit subject indoors, or a subject that is against a dark background.

Exposure Compensation Value:  $-2.0\text{EV}$  to  $+2.0\text{EV}$

Unit:  $1/3\text{EV}$

**1. In the REC mode, press [SET].**

**2. Use [▲] and [▼] to select the third option from the bottom in the operation panel (EV Shift) .**

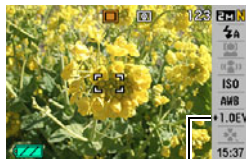

EV Shift Value

**3. Use [◀] and [▶] to adjust the exposure compensation value.**

[▶]: Increases the EV value. A higher EV value is best used for light-colored subjects and backlit subjects.

\* Increasing the EV value also works well with the BEST SHOT "Backlight" scene.

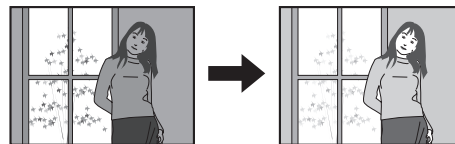

[◀]: Decreases the EV value. A lower EV value is best for dark-color subjects and for shooting outdoors on a clear day.

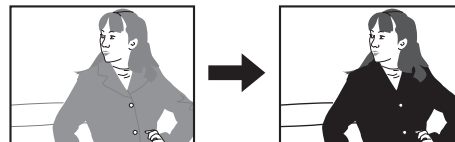

To cancel exposure compensation, adjust the value until it becomes 0.0.

#### 4. After the EV value is the way you want, press [SET] to apply it.

The exposure compensation value you set remains in effect until you change it.

#### IMPORTANT!

- When shooting under very dark or very bright conditions, you may not be able to obtain satisfactory results even after performing exposure compensation.









#### NOTE

- Performing an EV shift operation while using multi-pattern metering will cause the metering mode to switch automatically to center weighted metering. The metering mode will return to multi-pattern metering when you change the exposure compensation value to 0.0 (page 130).
- You can use the key customization feature to configure the [◀] and [▶] buttons so they control EV shift (page 138). This comes in handy when adjusting exposure compensation while viewing the on-screen histogram (page 136).

## Controlling White Balance

Shooting on a cloudy day can give your subject a blue cast, while shooting under white fluorescent lighting can give your subject a green cast. White balance corrects for different types of lighting so the colors in your images always look natural.

1. In the REC mode, press [SET].
2. Use [▲] and [▼] to select the fourth option from the bottom in the operation panel (White Balance).
3. Use [◀] and [▶] to select the white balance setting you want and then press [SET].

To do this:	Select this setting:
Let the camera adjust white balance automatically	 Auto WB
Shoot outdoors on a clear day	 Daylight
Shoot outdoors on an overcast rainy day, in the shade, etc.	 Overcast
Shoot in the shadow of a building, in the shade of trees, etc. on a clear day	 Shade
Suppress color cast when shooting under white or day white fluorescent lighting	 Day White Fluorescent
Suppress color cast when shooting under daylight fluorescent lighting	 Daylight Fluorescent
Suppress the appearance of light bulb lighting	 Tungsten
Manually adjust white balance to suit a particular light source <ul style="list-style-type: none"> <li>For details, see “Configuring the White Balance Setting Manually” (page 128).</li> </ul>	 Manual WB

## NOTE

- When “Auto” is selected for the white balance setting, the camera automatically determines the white point of the subject. Certain subject colors and light source conditions can cause problems when the camera tries to determine the white point, which makes proper white balance adjustment impossible. If this happens, select the white balance setting that matches your shooting conditions (Daylight, Overcast, etc.)
- You can use the key customization feature to configure the [◀] and [▶] buttons so they control the white balance setting (page 138).
- To select “Auto” with the control key (when the control key is configured to select the auto white balance setting), scroll through the settings until “ ” appears on the monitor screen.

## ■ Configuring the White Balance Setting Manually

Under complex lighting conditions, the preset white balance settings may not be able to produce natural looking colors. When this happens, you can configure the white balance setting manually for particular lighting conditions. Note that you will need to have a plain white sheet of paper on hand when performing the following procedure.

1. In the REC mode, press [SET].
2. Use [▲] and [▼] to select the fourth option from the bottom in the operation panel (White Balance).
3. Use [◀] and [▶] to select “**MWB** Manual WB”.  
This will display the subject that the lens is aimed at on the monitor screen using the current manual white balance settings. If you want to use the current settings, jump directly to step 5.

4. Under the lighting conditions you plan to use when shooting, point the camera at a blank white piece of paper so it fills the entire monitor screen and then press the shutter button.

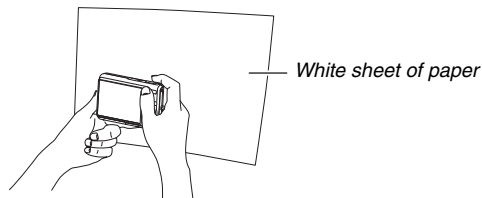

The camera will adjust white balance settings for the current conditions, and display “Complete” when it is finished.

5. Press [SET] to register the white balance settings and return to the shooting screen.
  - The white balance setting is retained even if you turn off the camera.



## Specifying ISO Sensitivity

ISO sensitivity is a value that expresses sensitivity to light. A larger value indicates higher sensitivity, which is better for shooting when available lighting is dim. If you want to use faster shutter speeds, you should use a higher ISO sensitivity value. Under certain conditions, a fast shutter speed in combination with a high ISO sensitivity setting can cause digital noise, which makes an image appear rough. For clean, good-quality images, use the lowest possible ISO sensitivity setting.

1. In the REC mode, press [SET].
2. Use [▲] and [▼] to select the fifth option from the top in the operation panel (ISO Sensitivity).

3. Use [◀] and [▶] to select the setting you want and then press [SET].

To shoot with this level of sensitivity:	Select this setting:
Automatically selected by camera.	Auto
Low ↑ ↓ High	ISO 50
	ISO 100
	ISO 200
	ISO 400
	ISO 800



### IMPORTANT!

- Using flash with high ISO sensitivity can cause problems with subjects that close to the camera.
- “Auto” ISO sensitivity always is used for movies, regardless of the current ISO sensitivity setting.
- You can use the key customization feature to configure the [◀] and [▶] buttons so they control the ISO sensitivity setting (page 138).

## Specifying the Metering Mode

The metering mode determines what part of the subject is metered for exposure.

1. In the REC mode, press [MENU].
2. On the “Quality” tab, select “Metering” and then press [▶].
3. Use [▲] and [▼] to select the setting you want and then press [SET].

### Multi (Multi Metering)

Multi-pattern metering divides the image into sections and measures the light in each section for a balanced exposure reading. The camera automatically determines shooting conditions according to the measured lighting pattern, and makes exposure settings accordingly. This type of metering provides error-free exposure settings for a wide range of shooting conditions.



### Center Weighted

Center weighted metering concentrates on the center of the focus area to measure light. Use this metering method when you want to exert some control over exposure, without leaving settings totally up to the camera.



### Spot

Spot metering takes readings at a very small area. Use this metering method when you want exposure to be set according to the brightness of a particular subject, without being affected by surrounding conditions.



## **IMPORTANT!**

- The metering mode will change to “Center Weighted” automatically if you change the EV shift value (page 125) to anything other than 0.0 while “Multi” is selected. The metering mode will change back to “Center Weighted” when the EV shift value is changed back to 0.0.
- When “Multi” is selected as the metering mode, the  icon will not be displayed on the monitor screen when you return to the REC mode information display (page 243).

## **NOTE**

- You can use the key customization feature to configure the [◀] and [▶] buttons so they control the metering mode setting (page 138).

## **Reducing the Effects of Overexposure and Underexposure**

You can use the procedure below to expand the dynamic range, which makes it possible to capture the bright areas of an image while reducing the chance of overexposure and underexposure. When shooting a subject that is back lit, for example, an expanded dynamic range minimizes overexposure and underexposure.

- 1. In the REC mode, press [MENU].**
- 2. On the “Quality” tab, select “Dynamic Range” and then press [▶].**

**3. Use [▲] and [▼] to select the setting you want and then press [SET].**

When you want to do this:	Select this setting:
Apply Dynamic Range to a greater extent than “Expand +1”	Expand +2
Suppress overexposure and underexposure	Expand +1
Do not suppress overexposure and underexposure	Off

- You can also correct the dynamic range of a photograph you have already shot (page 170).

## Enhancing Human Skin Textures

You can use the procedure below to reduce digital noise from human skin in the recorded image and enhance its texture.

- 1. In the REC mode, press [MENU].**
- 2. On the “Quality” tab, select “Portrait Refiner” and then press [▶].**
- 3. Use [▲] and [▼] to select the setting you want and then press [SET].**

When you want to do this:	Select this setting:
Enhance skin texture more than “Noise Filter +1”	Noise Filter +2
Enhance skin texture	Noise Filter +1
Turn off skin texture enhancement	Off

## Using the Camera's Color Filter Effects

The camera's filter feature lets you add color tints to your images as you shoot them. The color effect look just like what you would get by installing a color filter on the lens of the camera.

- 1. In the REC mode, press [MENU].**
- 2. On the "Quality" tab, select "Color Filter" and then press [▶].**
- 3. Use [▲] and [▼] to select the setting you want and then press [SET].**

Available filter settings are: Off, B/W, Sepia, Red, Green, Blue, Yellow, Pink, and Purple

## Controlling Image Sharpness

Use the following procedure to adjust the sharpness of subject outlines in your images.

- 1. In the REC mode, press [MENU].**
- 2. On the "Quality" tab, select "Sharpness" and then press [▶].**
- 3. Use [▲] and [▼] to select the setting you want and then press [SET].**

You can specify one of five sharpness settings from +2 (sharpest) to -2 (least sharp).

## Controlling Color Saturation

Use the following procedure to adjust the saturation of colors in your images.

1. In the REC mode, press [MENU].
2. On the “Quality” tab, select “Saturation” and then press [▶].
3. Use [▲] and [▼] to select the setting you want and then press [SET].

You can specify one of five saturation settings from +2 (most saturated) to -2 (least saturated).

## Adjusting Image Contrast

Use the following procedure to adjust the contrast of your images.

1. In the REC mode, press [MENU].
2. On the “Quality” tab, select “Contrast” and then press [▶].
3. Use [▲] and [▼] to select the setting you want and then press [SET].

You can specify one of five contrast settings from +2 (most contrast between light and dark) to -2 (least contrast between light and dark).

## Date Stamping Snapshots

You can have the snapshot's recording date only, or date and time stamped in the lower right corner of the image.

1. In the REC mode, press [MENU].
2. On the "Set Up" tab, select "Timestamp" and then press [▶].
3. Use [▲] and [▼] to select the setting you want and then press [SET].

Example: December 24, 2007, 1:25 p.m.

To do this:	Select this setting:
Display the date only (2007/12/24)	Date
Display the date and time (2007/12/24 1:25pm)	Date&Time
Display nothing	Off



### IMPORTANT!

- Even if you do not stamp the date and/or time with Timestamp, you can do so later using the DPOF function and the printing software function (page 208).
- Once date and time information is stamped in a print, it cannot be edited or deleted.
- Use the "Date Style" setting (page 194) to specify the Year/Month/Day format of the date.
- The recording date and time are determined in accordance with the camera's clock settings (pages 11, 193) when the snapshot is recorded.
- Digital zoom is not supported while date stamping is turned on.
- Date stamping is not supported for the following types of images.
  - Some BEST SHOT images (Auto Framing, Business cards and documents, White board, etc., Old Photo, ID Photo)

## Using the On-screen Histogram to Check Exposure

The on-screen histogram that provides a graphic representation of the current exposure of the image. You can also display the histogram in the PLAY mode for information about the exposure levels of images.



### 1. Press [▲] (DISP) as many times as necessary to display the histogram (page 56).

#### NOTE

- You can use key customization to configure the [◀] and [▶] buttons so they control the EV shift setting. Then you can perform EV shift while viewing the results on the on-screen histogram (page 138).

## ■ How to Use the Histogram

A histogram is a graph that represents the lightness of an image in terms of the number of pixels. The vertical axis indicates the number of pixels, while the horizontal axis indicates lightness. If the histogram appears too lopsided for some reason, you can use EV shift to move it left or right in order to achieve better balance. Optimum exposure can be achieved by EV shifting so the graph is as close to the center as possible. For snapshots, you can even display individual histograms for R (red), G (green), and B (blue). These lines can be used to determine whether there is too much or too little of each of the color components in an image.

### Example Histograms

A histogram towards the left side results when the overall image is dark. A histogram that is too far to the left may result in “black out” of the dark areas of an image, as shown in the nearby image.





A histogram towards the right side results when the overall image is light. A histogram that is too far to the right may result in "white out" of the light areas of an image, as shown in the nearby image.



An overall well-balanced histogram results when the overall image is at optimal lightness.



### **IMPORTANT!**

- A centered histogram does not necessarily guarantee optimum exposure. If you intentionally want to over expose or under expose the image, you may not want a centered histogram.
- Due to the limitations of exposure compensation, you may not be able to achieve an optimum histogram configuration.
- Use of the flash and certain shooting conditions can cause the histogram to indicate exposure that is different from the actual exposure of the image when it was shot.

## Other Useful Recording Functions

The following functions are also available in the REC mode to help make your digital image more efficient and enjoyable.

- Assign functions to the [◀] and [▶] keys
- Display an on-screen grid for easy image composition
- Review an image you just recorded
- Register initial power up settings
- Reset settings

## Using Key Customize to Assign Functions [◀] and [▶]

Key Customize lets you assign any one of the five functions listed below to the [◀] and [▶] keys. Once you do, you will be able to use the assigned functions while shooting snapshots or movies, without going through the menus. For details about each of the functions, see the referenced page numbers.

When this function is assigned:	You can use [◀] and [▶] to do this:
Metering (page 130)	Change the metering setting
EV Shift (page 125)	Perform EV shifting for exposure compensation
White Balance (page 126)	Change the white balance setting

When this function is assigned:	You can use [◀] and [▶] to do this:
ISO (page 129)	Change the ISO sensitivity setting
Self-timer (page 76)	Select the self-timer time

- 1. In the REC mode, press [MENU].**
- 2. On the “REC” tab, select “L/R Key”, and then press [▶].**
- 3. Use [▲] and [▼] to select the function you want to assign and then press [SET].**  
After you assign a function, you can control its setting using the [◀] and [▶] keys.  
Selecting “Off” leaves the [◀] and [▶] keys with no function assigned.

## Displaying an On-screen Grid

The on-screen grid can be displayed on the REC mode monitor screen for easy alignment when composing images.

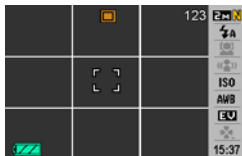

1. In the REC mode, press [MENU].
2. On the “REC” tab, select “Grid” and then press [▶].
3. Use [▲] and [▼] to select the setting you want and then press [SET].

To do this:	Select this setting:
Display the grid	On
Hide the grid	Off

## Displaying the Image You Just Recorded (Image Review)

When you purchase your camera, it is initially configured with the Image Review feature turned on. Image Review displays the image you just recorded so you can check it.

1. In the REC mode, press [MENU].
2. On the “REC” tab, select “Review” and then press [▶].
3. Use [▲] and [▼] to select the setting you want and then press [SET].

To configure the camera to do this after an image is recorded:	Select this setting:
Display the image for about one second	On
Nothing	Off

## Using Icon Help



Icon help displays guidance text about an icon when you select it on the monitor screen while in the REC mode (page 243).

- Icon help text is displayed for the following functions: Recording mode, metering, flash mode, white balance, self-timer, EV shift. Note, however, that metering, white balance, self-timer and EV shift icon help text appears only when “Metering”, “White Balance”, “Self-timer” or “EV shift” respectively is assigned to the [◀] and [▶] keys with the key customization feature (page 138).

1. In the REC mode, press [MENU].
2. On the “REC” tab, select “Icon Help” and then press [▶].
3. Use [▲] and [▼] to select the setting you want and then press [SET].

To do this:	Select this setting:
Display icon help text next to the icon of a function when you select the function	On
Turn off icon help	Off

### IMPORTANT!

- The icons listed below do not appear on the display while icon help is turned off.
  - Flash mode  icon (page 71)
  - White balance  icon (page 126)
  - Metering mode  icon (page 130)

## Using Mode Memory to Configure Power On Default Settings

You can configure the camera so it saves certain settings in “mode memory” whenever it is turned off, and restores the settings the next time you turn the camera back on. This keeps you from having to configure the camera each time you turn it off and on.

See step 4 of the setting procedure below for information about the settings you can save with mode memory.

1. In the REC mode, press [MENU].
2. On the “REC” tab, select “Memory” and then press [▶].
3. Use [▲] and [▼] to select the item you want to configure and then press [▶].

4. Use [▲] and [▼] to select the setting you want and then press [SET].

To do this:	Select this setting:
Save the current setting when the camera turned off, and restore it when the camera is turned back on	On
Restore the optimum default when the camera is turned on	Off

Setting	Mode Memory On	Mode Memory Off
BEST SHOT*1	Setting at power off	Exits BEST SHOT when camera is turned off.
Flash		Auto
Focus		Auto
White Balance		Auto
ISO		Auto
AF Area		Spot
Metering		Multi
Self-timer		Off
Flash Intensity		0
Digital Zoom		On
MF Position		Focus mode before manual focus was selected.
Zoom Position*2		Full wide

\*1 "On" restores the selected BEST SHOT scene when the camera is turned back on. "Off" exits BEST SHOT when the camera is turned off.

\*2 Optical zoom position only.



### **IMPORTANT!**

- Turning the camera off while mode memory for the BEST SHOT mode is on will restore the settings of the BEST SHOT scene what was selected when you last turned off the camera. This is true, regardless of any of the mode memory on/off settings of each individual setting, except for Zoom Position.

## Resetting the Camera to Its Initial Factory Defaults

Use the following procedure when you want to return to the camera to its initial factory default settings, which are the ones that are configured when you first purchase the camera. See “Menu Reference” on page 246 for the initial factory default setting for each menu item.

- 1. Press [MENU].**
- 2. On the “Set Up” tab, select “Reset” and then press [▶].**
- 3. Use [▲] and [▼] to select “Reset” and then press [SET].**
  - To cancel the procedure without resetting, select “Cancel”.



### **IMPORTANT!**

- The following are not initialized when you reset the camera (page 248).
  - Home Time setup
  - World Time setup
  - Adjust
  - Date Style
  - Language
  - Video Out

# VIEWING SNAPSHOTS AND MOVIES

## Viewing a Snapshot

Use the following procedure to view snapshots on the camera's monitor screen.

### 1. Press [▶] to enter the PLAY mode.

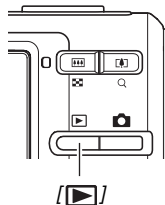

- This will display one of the snapshots in memory, along with some information about the settings used to shoot it (page 245).

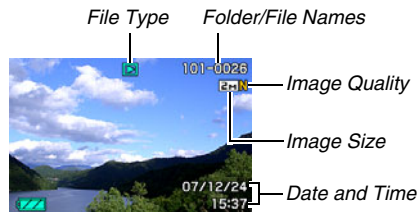

- The file type icon that appears at the top of the monitor screen depends on the type of file (snapshot, movie, audio only, etc) that is currently displayed.
  - [▶] : Snapshot (page 144)
  - [🎥] : Movie (page 146)
  - [🔊] : Audio snapshot (page 145)
- See page 56 information about how to hide the image information and view the image alone.

### 2. Use [◀] and [▶] to scroll between images.

Press [▶] to scroll forward and [◀] to scroll back.





## NOTE

- Holding down [◀] or [▶] scrolls at high speed.
- The image that initially appears when scrolling may appear to be a bit rough at first, but it will soon be replaced by an image with better definition. Note that if you copy an image from another type of digital camera, only a rough image may be shown on the monitor screen.

### To switch to the REC mode

Press [📷].

## Listening to the Audio of an Audio Snapshot

You can use the following procedure to play the audio of an audio snapshot. An audio snapshot is indicated by the “🔊” file type icon.

1. Enter the PLAY mode and then use [◀] and [▶] to display the audio snapshot whose audio you want to play.



2. Press [SET] to play the snapshot's audio from the camera's built-in speaker.

## Audio Playback Controls

To do this:	Do this:
Fast forward or fast reverse playback	Hold down [▶] or [◀].
Pause or restart playback	Press [SET].
Adjust volume	Press [▼] and then use [▲] and [▼].
Change on-screen indicators	Press [▲] (DISP).
Stop playback	Press [MENU].

You can adjust volume while playback is in progress or paused only.

## Viewing a Movie

Use the following procedure to view a movie on the camera's monitor screen.

### 1. Enter the PLAY mode and then use [◀] and [▶] to display the movie you want to play.

- Check the file type icon. The file type icon of a movie is “” (Movie) icon (page 245).

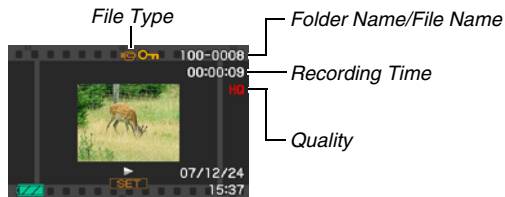

The film-like frame that appears on the monitor screen indicates that this is an image from a movie.

### 2. Press [SET] to start playback.

- The monitor screen will return to the selection screen in step 1 after the end of the movie is reached.

## To switch to the REC mode

Press [].

## Movie Playback Controls

To do this:	Do this:
Fast forward or fast reverse playback. <ul style="list-style-type: none"><li>Each press of either button increases the speed of the fast forward or fast reverse operation up to three steps.</li></ul>	Hold down [▶] or [◀].
Return from fast forward/fast reverse to normal playback	Press [SET].
Pause or restart playback	Press [SET].
When paused, scroll forward or back frame-by-frame <ul style="list-style-type: none"><li>Hold down either button to scroll non-stop.</li></ul>	Press [▶] or [◀].
Adjust volume <ul style="list-style-type: none"><li>Volume can be adjusted only while movie playback is in progress.</li></ul>	Press [▼] and then use [▲] and [▼].
Toggle on-screen indicators on or off	Press [▲] (DISP).

To do this:	Do this:
Zoom in up to 4.5X <ul style="list-style-type: none"><li>While an image is zoomed, you can use [▲] [▼] [◀] and [▶] to move around and view the parts of the image that do not fit on the monitor screen.</li></ul>	Press the zoom button (  ).
Stop playback	Press [MENU].



### **IMPORTANT!**

- Playback may not be possible for movies not recorded with this camera.

## Playing Back a Movie with Anti Shake

Use the following procedure when you want to play back a movie with Anti Shake. Anti Shake is particularly useful when you have the camera connected to a TV for viewing, since the effects of camera movement are more evident on a big screen.

1. In the **PLAY** mode, press [MENU].
2. Select the “**PLAY**” tab, select “ Anti Shake”, and then press [▶].
3. Use [▲] and [▼] to select “On”, and then press [SET].
  - When Anti Shake is turned on, the area of the monitor screen used for playback is slightly smaller than normal.
4. After the setting is the way you want, press [SET].









## Playing a Slideshow on the Camera





The slideshow feature lets you play the files stored in memory in sequence, automatically.

You can configure the slideshow so it plays the files the way you want.

1. In the **PLAY** mode, press [MENU].
2. On the “**PLAY**” tab, select “**Slideshow**” and then press [▶].
3. **Configure the slideshow settings.**

Use [▲] and [▼] to select an item and then configure it as described below.

<b>Images</b> <b>(Select the files you want to include in the slideshow.)</b>	<ul style="list-style-type: none"> <li>• All images: Includes all snapshots, movies, and audio in memory.</li> <li>•  Only: Includes snapshots and audio snapshots only.</li> <li>•  Only: Includes movies only.</li> <li>• One Image: Includes only one specific image (selected using [] and []).</li> <li>• Favorites: Includes snapshots in the FAVORITE folder (page 183).</li> </ul>
<b>Time</b> <b>(Specify the time of the slideshow, from start to finish.)</b>	<p>Use [] and [] to select one of the following times (in minutes): 1, 2, 3, 4, 5, 10, 15, 30, 60.</p>
<b>Interval</b> <b>(Select the interval between slides.)</b>	<p>Use [] and [] to select a value from 1 to 30 seconds, or "MAX".</p> <ul style="list-style-type: none"> <li>– If you specify a value from 1 to 30 seconds, images change at the specified interval, but the audio portion of movies and audio snapshots will continue to play until the end, regardless of the interval setting.</li> <li>– When "MAX" is selected, only the first frame of each movie is displayed, without any playback of the audio.</li> </ul>

<b>Effect</b> <b>(Select a special effect.)</b>	<p>Use [] and [] to select the effect you want.</p> <ul style="list-style-type: none"> <li>• Pattern 1, 2, 3, 4, 5: Plays background music and applies an image change effect. <ul style="list-style-type: none"> <li>– Pattern 1 through 4 use the same special effects but each use different background music. Pattern 5 uses different effects from patterns 1 through 4.</li> <li>– Selecting "Pattern 5" changes the "Images" setting to " Only" and disables the "Interval" setting.</li> </ul> </li> <li>• Off: No background music plays and no image change effect is performed. The current effect setting is disabled automatically in following cases. <ul style="list-style-type: none"> <li>– When the "Images" setting is " Only", "One Image", or "Favorites".</li> <li>– When the "Interval" setting is "MAX", one second, or two seconds.</li> <li>– When the slideshows changes to or from a movie file or a voice recording file.</li> </ul> </li> </ul>
--	---

#### 4. Use [▲] and [▼] to select “Start” and then press [SET] to start the slideshow.

The slideshow is performed in accordance with the settings you configured above.

- You can also scroll through images during a slideshow by pressing [▶] (forward) and [◀] (back). Note that this operation is not possible when “Pattern 5” is selected for the “Effect” setting.
- During audio playback, you can adjust volume by pressing [▼] and then using [▲] and [▼].

#### To stop a slideshow

Press [SET]. This will return to the PLAY mode.

- Pressing [MENU] instead of [SET] stops the slideshow and returns to the menu screen.
- Pressing [📷] instead of [SET] stops the slideshow and switches to the REC mode.



#### IMPORTANT!

- All button operations are disabled while the slideshow is switching from one image to another. Wait until an image is stopped on the display before performing a button operation. If a button does not work, wait a bit and try again.

#### NOTE

- Selecting a movie when “One Image” is selected for “Images” and then selecting a movie for the slideshow will cause the movie to play back repeatedly within the time specified by the slideshow “Time” setting.
- In image copied from a computer or an image recorded with a different type of digital camera may remain on the screen longer than the time specified by “Interval”.

## ■ Changing the Background Music

You can change from the built-in background music that plays when you execute “Effect” to other background music.

- Supported File

File Types: IMA ADPCM format WAV files

Sampling Frequencies: 22.05 kHz/44.1 kHz

Audio: monaural

- Number of Files: 9

- File names: SSBGM001.WAV to SSBGM009.WAV

- Store the music files on your computer using the above names.



### **IMPORTANT!**

- Regardless of which effect pattern is selected, the background music is looped.
- Depending on the BGM file format, some background music data may not be playable.

## Transferring Background Music to the Camera

You can select background music after its file has been saved to the memory card or the camera’s built in memory.

### **1. Connect the camera to your computer (pages 215, 231).**

- If you save a background music file to a memory card, load the card into the camera.

### **2. Perform one of the following operations to open the memory card or built-in memory.**

- Windows
  - ① Based on your operating system, perform one of the following steps.  
Windows XP users: Click “Start” and then “My Computer”.  
Windows Vista users: Click “Start” and then “Computer”.  
Windows 2000/Me/98SE/98 users: Double-click “My Computer”.
  - ② Double-click “Removable Disk”.  
Your computer recognizes the memory card loaded in the camera (or built-in memory if there is no card) as a removable disk.
- Macintosh
  - ① Double-click the camera’s drive icon.  
Your computer recognizes the memory card loaded in the camera (or built-in memory if there is no card) as a drive.

3. Create a folder named “SSBGM”.
4. Double-click the “SSBGM” folder you created and copy the background music file to it.
5. Disconnect the camera from the computer (pages 220, 235).

### **IMPORTANT!**

- The background music files will be loop played in sequence.
- If both the memory card loaded in the camera and the camera’s built-in memory contain background music files, the files on the memory card are played.
- See the user documentation that comes with your computer for information about moving, copying, and deleting files.

#### ● **Folder Structure**

Memory Card or Built-in Memory

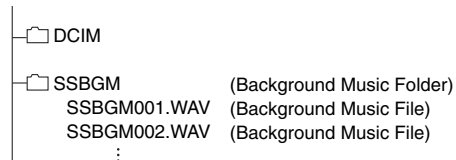



## Viewing Camera Images on a TV

Use the procedure below to view snapshots and movies on a TV screen.

### 1. Use the AV cable that comes with the camera to connect the camera to a TV.

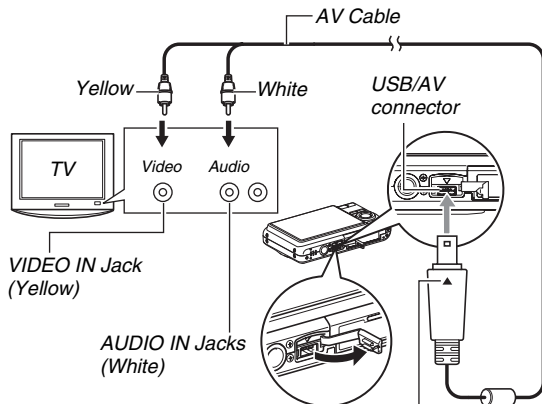

Making sure that the ▼ mark on the camera is aligned with the ▲ mark of the AV cable plug, connect the cable to the camera.

- When connecting the bundled AV cable to the camera's USB/AV port, insert the plug into the port until you feel it click securely into place. Failure to insert the plug fully can result in poor communication or malfunction of the connected components.
- Some metal of the plug is visible even when the plug is inserted correctly.

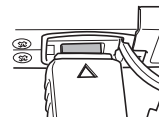

### 2. Turn on the TV and select its video input mode.

If the TV has more than one video input, select the one where the camera is connected.

### 3. Press [▶] (PLAY) to turn on the camera and enter the PLAY mode.

When the camera turns on in the PLAY mode, an image will appear on the TV screen. The camera's monitor screen will not turn on.



- Pressing [ON/OFF] or [RECORD] (REC) will not turn on the camera.

#### 4. Now you can perform the applicable operation on the camera for the type of file you want to play.

##### To turn off the camera

You can turn off the camera by pressing the camera's [ON/OFF] button.

##### **IMPORTANT!**

- When connecting to a TV to display images, be sure to configure the camera's [] (REC) and [] (PLAY) buttons for "Power On" or "Power On/Off" (page 199).
- All icons and indicators that appear on the monitor screen also appear on the TV screen.  
You can use [] (DISP) to change the display contents.
- Audio is monaural.
- Certain TVs may cut off part of the images.
- Audio is initially output by the camera at maximum volume.  
When you first start displaying images, set the TV volume control at a relatively low level and then adjust it as required.

##### **NOTE**

- You can use the camera to connect to a DVD recorder or video deck and record images from the camera. There are various different methods you can use in order to connect to another device when recording images. The following describes one method for connection using the AV cable that comes with the camera.
  - DVD recorder or video deck: Connect to the VIDEO IN and AUDIO IN terminals.
  - Camera: Connect to the USB/AV connectorYou can play a slideshow of snapshots and movies on the camera and record it on a DVD or video tape. You can record movies by selecting " Only" for the slideshow "Images" setting (page 149). When recording to DVD recorder or video deck, you can turn off display information (page 56) so indicators and other information is not recorded along with the image.  
To view the image that is being recorded, connect a TV or other monitor to the DVD recorder or video deck that is connected to the camera. For information about connecting a monitor to the DVD recorder or video deck and about how to record, see the user documentation that comes with the DVD recorder or video deck you are using.

## ■ Selecting the Screen Aspect Ratio and Video Output System

You can use the procedure in this section to select either NTSC or PAL as the video output system. You can also specify an aspect ratio of 4:3 or 16:9.

1. Press [MENU].
2. On the “Set Up” tab, select “Video Out” and then press [▶].
3. Use [▲] and [▼] to select the setting you want and then press [SET].

For this type of TV:	Select this video output system:
Standard aspect ratio screen NTSC TV (Japan, U.S., and other countries)	NTSC 4:3
Wide aspect ratio screen NTSC TV (Japan, U.S., and other countries)	NTSC 16:9
Standard aspect ratio screen PAL TV (Europe and other areas)	PAL 4:3
Wide aspect ratio screen PAL TV (Europe and other areas)	PAL 16:9



### IMPORTANT!

- Select the aspect ratio (4:3 or 16:9) that matches the type of TV you plan to use. You may also need to configure the aspect ratio setting on your TV as well. Incorrect aspect ratio settings on the camera and/or the TV can result in abnormal image display.
- Images will not display correctly unless the camera’s video signal output setting matches the video signal system of the TV or other video equipment.
- Images will not display correctly on a TV or video equipment that is not NTSC or PAL.

## Zooming the Displayed Image

Perform the following procedure to zoom the image currently on the monitor screen up to eight times its normal size.

**1. In the PLAY mode, use [◀] and [▶] to display the snapshot you want to zoom.**

**2. Press the zoom button (🔍).**

Each press of this button zooms the image more. You can use [▲], [▼], [◀], and [▶] to move to a different part of the image after zooming.

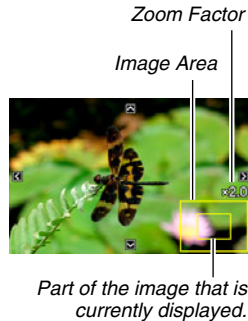

**To zoom back out, press the zoom button (🔍).**

- If display indicators are turned on, an indicator in the lower right corner of the monitor screen shows what part of the zoomed image is currently displayed.

**To return to image to normal size**

Press [MENU] or [BS].

### **IMPORTANT!**

- Depending on the image size, some images may not be able to be zoomed to the full 8 times normal size.

## Using the 12-image Screen

You can use the procedure below to display a screen that shows 12 images.

### 1. In the **PLAY** mode, press the zoom button ( ).

This displays the 12-image screen with a selection boundary around the last image that was on the monitor screen.

*Selection Boundary*

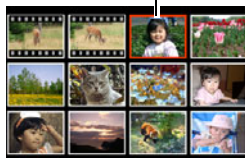

### 2. Select the image you want.

- Use [**◀**] and [**▶**] to scroll between 12-image screens.
- To view the full-screen version of a particular image, use [**▲**], [**▼**], [**◀**], and [**▶**] to move the selection boundary to it and then press [**SET**].

## Using the Calendar Screen

Use the following procedure to display a calendar, which shows the first image recorded on each date of a particular month. This screen helps to make searching for an image quicker and easier.

### 1. In the **PLAY** mode, press the zoom button ( ) twice.

This displays the calendar screen.

- You can also display the calendar by pressing [**MENU**], selecting the “PLAY” tab, selecting “Calendar”, and then pressing [**▶**] to display the calendar.
- To exit the calendar screen, press [**MENU**] or [**BS**].

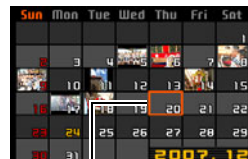

*Year/Month*

*Selection Boundary*

### 2. Use [**▲**], [**▼**], [**◀**], and [**▶**] to move the selection boundary to the date whose image you want to view and then press [**SET**].

This will display the first image recorded on that date.

## NOTE

- The year and month on the calendar is displayed using the same format as you selected for the “Date Style” setting (page 194).



## IMPORTANT!

- Note following points about how certain editing functions of the camera affect the date with which the image is associated on the calendar screen.

<b>Performing this type of editing operation:</b>	<b>Will associate the resulting image with this date:</b>
Keystone, Color Correction, Resize, Trimming, Copy, MOTION PRINT	The date that the editing operation was performed
Editing the date and time of an image	The date that the original image was recorded

# EDITING IMAGES

## Resizing a Snapshot

You can reduce the size of a snapshot and save the result as a separate snapshot. The original snapshot is also retained. You can resize a snapshot to any one of the following sizes.

Image Size (Pixels)		Print Size	
Larger ↑	5M*	2560 × 1920	A3 Print
	3M	2048 × 1536	A4 Print
↓ Smaller	VGA	640 × 480	E-Mail • Optimum size for an image to be attached to e-mail.

\* M stands for “Mega”, which means “million”.

1. In the **PLAY** mode, press [MENU].
2. On the “PLAY” tab, select “Resize” and then press [▶].
3. Use [◀] and [▶] to scroll through images and display the one you want to resize.

4. Use [▲] and [▼] to select an image size, and then press [SET].

- When you select an image size, it will start to cycle through the following information:

Image Size → Number of Pixels → Print Size → .

The print size indicates the optimum paper size for printing a snapshot of the selected image size.

5. After you press [SET] in step 4 to resize the image, the monitor screen returns to step 3. From there you can repeat steps 3 and 4 to resize another image if you want.

To exit the resize operation, select “Cancel”.

## **IMPORTANT!**

- You cannot resize a VGA (640 × 480 pixels) size image.
- Resizing a snapshot shot with an aspect ratio of 16:9 or 3:2 will cause the left and right sides of the image to be cut off. The aspect ratio of the resulting image will be 4:3.
- The recording date of the resized version of the snapshot will be the same as the recording date of the original snapshot.

## **Cropping a Snapshot**

You can crop a snapshot to trim parts you do not need, and save the result in a separate file. The original snapshot is also retained.

- 1. In the PLAY mode, use [◀] and [▶] to scroll through images and display the snapshot you want to crop.**
- 2. Press [MENU].**
- 3. On the “PLAY” tab, select “Trimming” and then press [▶].**
  - This operation can be performed only while a snapshot is on the monitor screen.

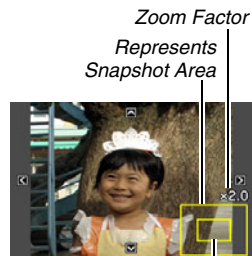

*Part of image that is currently displayed.*



4. Use the zoom button to zoom, and [▲], [▼], [◀], and [▶] to move around the zoomed image to display the part you want to extract.

5. Press [SET] to extract the displayed part and save it as a separate file.

- To exit the cropping procedure at any time before you press [SET], press [MENU].



#### **IMPORTANT!**

- The image produced by cropping a 3:2 or 16:9 image will have an aspect ratio of 4:3.
- The recording date of the extracted image will be the same as the recording date of the original snapshot.

## **Keystone Correction**

Use the following procedure to correct the snapshot of a blackboard, document, poster, photograph, or other rectangular object that is out of square because it was recorded at an angle. Performing keystone correction on an image causes a new (corrected) 2M (1600 × 1200 pixels) size image to be stored as a separate file.

1. In the **PLAY** mode, use [◀] and [▶] to scroll through images and display the snapshot you want to correct.

2. Press [MENU].

3. On the “**PLAY**” tab, select “**Keystone**” and then press [▶].

This displays screen that shows all of the rectangular shapes in the image that qualify as candidates for keystone correction.

- Note that the above step is possible only when there is a snapshot displayed on the monitor screen.

4. Use [**◀**] and [**▶**] to select the candidate you want to correct.



5. Use [**▲**] and [**▼**] to select “Correct” and then press [**SET**].

- Select “Cancel” to exit the procedure without performing keystone correction.



#### **IMPORTANT!**

- If the original image is smaller than 2M (1600 × 1200 pixels) size, the new (corrected) version will be the same size as the original one.
- When you display a corrected image on the camera’s monitor screen, the date and time indicate when the image was originally recorded, not when the image was corrected.

## Using Color Restoration to Correct the Color of an Old Photograph

Color restoration let you correct the old color of a photograph shot with a digital camera. This function is useful for correcting existing old photographs, posters, etc.

- Performing color restoration on an image causes a new (restored) 2M (1600 × 1200 pixels) size image to be stored as a separate file.

1. In the **PLAY** mode, use [**◀**] and [**▶**] to scroll through images and display the snapshot you want to correct.

2. Press [**MENU**].

3. On the “**PLAY**” tab, select “**Color Correction**” and then press [**▶**].

4. Use [**◀**] and [**▶**] to select the photograph candidate you want.

5. Use [**▲**] and [**▼**] to select “**Trim**”, and then press [**SET**].

This displays a cropping boundary on the monitor screen.

- To exit color restoration without storing anything, select “Cancel”.

6. Use the zoom button to change the cropping boundary to the desired size.
7. Use [▲], [▼], [◀], and [▶] to move the selection boundary to the desired location and then press [SET].

The camera will correct color automatically and save the corrected image.

- If you do not want a border around the resulting image, select an area that is smaller than the original image.
- To exit color restoration without saving anything, press [MENU].



#### **IMPORTANT!**

- If the original image is smaller than 2M (1600 × 1200 pixels) size, the new (restored) version will be the same size as the original one.
- When you display a restored image on the camera's monitor screen, the date and time indicate when the image was originally recorded, not when the image was corrected.

#### **NOTE**

- If you want to record the image of an old photograph with this camera and restore the resulting image, see "Restoring an Old Photograph" on page 109.

## Editing the Date and Time of an Image

Use the procedure in this section to change the date and time of a previously recorded image.

1. In the **PLAY** mode, use [**◀**] and [**▶**] to display the image whose date and time you want to edit.
2. Press [**MENU**].
3. On the “**PLAY**” tab, select “**Date/Time**” and then press [**▶**].
4. Set the date and the time you want.

To do this:	Do this:
Change the value at the cursor location	Press [ <b>▲</b> ] or [ <b>▼</b> ].
Move the cursor between settings	Press [ <b>◀</b> ] or [ <b>▶</b> ].
Toggle between 12-hour and 24-hour timekeeping	Press [ <b>BS</b> ].

5. When all the settings are the way you want, press [**SET**] to apply them.

- After editing the time and date, display the image to confirm that the date and time are correct.



### **IMPORTANT!**

- The date and time stamped into an image using the Time Stamp feature cannot be edited (page 135).
- You cannot edit the date and time of an image that is protected. Unprotect the image and then edit the date and time.
- You can specify any date in the range of January 1, 1980 to December 31, 2049.

## Rotating an Image

Perform the following procedure to rotate the image (snapshot or movie) currently on the monitor screen. This feature comes in handy with a snapshot that you shot using portrait (vertical) orientation. After rotating a snapshot, you can return it to its original orientation, if you want.

- Note that this procedure does not actually change the image data. It simply alters how the snapshot is displayed on the camera's monitor screen.

- 1. In the PLAY mode, press [MENU].**
- 2. On the "PLAY" tab, select "Rotation" and then press [▶].**
  - This operation can be performed only while a snapshot or movie image is on the monitor screen.
- 3. Use [◀] and [▶] to select the snapshot whose display image you want to rotate.**
- 4. Use [▲] and [▼] to select "Rotate" and then press [SET].**
  - Each press of [SET] will rotate the displayed image 90 degrees left.
- 5. When the displayed image is at the orientation you want, press [MENU].**



### IMPORTANT!

- You cannot rotate an image that is protected. To rotate a protected snapshot, first remove its protection (page 181).
- Zoomed images cannot be rotated.
- The original (unrotated) version of a snapshot's image will be displayed on the 12-image screen and the calendar screen.
- Movies can be rotated on the camera's monitor screen only. The movie is not rotated when played on a computer screen.

## Combining Multiple Snapshots into a Single Image (Layout Print)

You can use the following procedure to insert snapshots into the frames of a layout and produce a new image that contains multiple snapshots.

- Layout pattern (Two Images)
- Layout pattern (Three Images)



1. In the PLAY mode, use [◀] and [▶] to select the first snapshot you want to include in the layout.
2. Press [MENU].

3. On the “PLAY” tab, select “Layout Print”, and then press [▶].

- This operation can be performed only while a snapshot is on the monitor screen.



4. Use [◀] and [▶] to select the type of layout you want and then press [SET].



5. Use [◀] and [▶] to select a background color.
6. Press [SET].

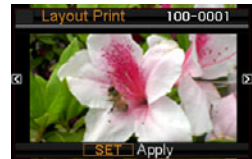

7. Use [◀] and [▶] to select the snapshot for the layout and then press [SET].

8. Repeat steps 6 and 7 for all of the other frames in the layout.

The final layout image will be saved after you insert the final snapshot into it.

- Pressing [MENU] returns to the PLAY mode screen without saving the layout image.
- You will not be able to save the new image unless there is a snapshot in all of the layout frames.



#### **IMPORTANT!**

- Layout Print is not supported when the image size is “3:2 (3072 × 2048 pixels)” or “16:9 (3072 × 1728 pixels)”.
- When you display a layout image on the camera’s monitor screen, the date and time indicates when the last image added to the layout was originally recorded, not when the image was laid out.
- The size of the multi-snapshot image for this operation is fixed automatically at 7M (3072 × 2304 pixels).

## Adjusting White Balance of a Recorded Image

You can use the white balance setting to select a light source type for a recorded image, which will affect the colors of the image.







1. In the **PLAY** mode, use [◀] and [▶] to display the image whose white balance setting you want to change.

2. Press [MENU].

3. Select the “**PLAY**” tab, select “**White Balance**”, and then press [▶].

- Note that the above step is possible only when there is a snapshot displayed on the monitor screen.

**4. Use [◀] and [▶] to select a white balance setting, and then press [SET] to apply it.**

When you want the image to appear like it was recorded under these conditions:	Select this setting:
Outdoors, fair weather	 (Daylight)
Outdoors, cloudy to rain, in tree shade, etc.	 (Overcast)
In a location where color temperature is very high, like in the shade of a building, etc.	 (Shade)
Under white or daylight white fluorescent lighting, without suppressing color cast	 (Day White Fluorescent)
Under daylight fluorescent lighting, while suppressing color cast	 (Daylight Fluorescent)
Under incandescent lighting, while suppressing color cast	 (Tungsten)
Cancel white balance adjustment	Cancel

- Normally, the initially selected white balance setting on the above menu is the one that was used when you originally recorded the image. If you used the “Auto” or “Manual” white balance setting when you recorded the image, “Cancel” will be selected (page 126).
- If you select the same white balance setting as the one you selected when you originally recorded the image, pressing [SET] will exit the white balance adjustment menu without changing the image.



**IMPORTANT!**

- Adjusting the white balance of an image creates a new image with the new white balance setting. The original image also remains in memory.
- When you display an image whose white balance has been adjusted on the camera’s monitor screen, the date and time indicates when the image was originally recorded, not when the white balance was adjusted.



## Adjusting Image Brightness

Use the following procedure to adjust the brightness of snapshots.

1. In the **PLAY** mode, use [**◀**] and [**▶**] to scroll through images and display the one whose brightness you want to adjust.
2. Press [**MENU**].
3. Select the “**PLAY**” tab, select “**Brightness**”, and then press [**▶**].
  - Note that the above step is possible only when there is a snapshot displayed on the monitor screen.

4. Use [**▲**] and [**▼**] to select the setting you want, and then press [**SET**].

To get this:	Select this setting:
Brighter  ↑ ↓  Darker	+2
	+1
	0
	-1
	-2

- To cancel the brightness adjustment operation, press [**◀**] or [**MENU**].

### **IMPORTANT!**

- Adjusting the brightness of an image creates a new image with the new brightness level. The original image also remains in memory.
- When you display a brightness adjusted image on the camera’s monitor screen, the date and time indicates when the image was originally recorded, not when the brightness was adjusted.

## Reducing the Effects of Underexposure

You can use the following procedure to reduce underexposure only, while maintaining the bright areas of an image.

1. In the **PLAY** mode, use [**◀**] and [**▶**] to select the image you want to correct.
2. Press [**MENU**].
3. On the “**PLAY**” tab, select “**Dynamic Range**”, and then press [**▶**].
4. Use [**▲**] and [**▼**] to select the setting you want and then press [**SET**].



When you want to do this:	Select this setting:
Apply Dynamic Range to a greater extent than “Expand +1”	Expand +2
Reduce underexposure	Expand +1

### **IMPORTANT!**

- Performing Dynamic Range correction on an image causes the new (corrected) version to be stored as a separate file.
- When you display a corrected image on the camera’s monitor screen, the date and time indicates when the image was originally recorded, not when the image was corrected.

## Editing a Movie on the Camera

You can perform the following cut operations on the camera to edit movies you have recorded.

Operation	Description
 Cut (To-Point Cut)	Cuts everything from the current location to the beginning of the movie.
 Cut (Point-To-Point Cut)	Cuts everything between two points.
 Cut (From-Point Cut)	Cuts everything from the current location to the end of the movie.

### **IMPORTANT!**

- When you edit a movie, only the result is saved. The original movie is not retained. Once you perform an editing operation, you will not be able to undo it.
- A movie that is shorter than five seconds cannot be edited.
- The movie editing operation is supported only for movies that were recorded with this camera.
- You will not be able to edit a movie if the amount of remaining memory capacity is less than the size of the movie file you want to edit. If there is not enough memory available, delete any files you no longer need to free up more.
- Cutting a movie into two parts or splicing of two movies in to a single movie cannot be performed on the camera.

### 1. Play back the movie you want to edit.

### 2. Press [SET] to pause playback.

- Check to make sure that “▼” (cut icon) is displayed on the monitor screen. If it isn't, press [SET] again.

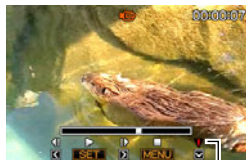

Cut icon

### 3. Press [▼].

- You could also perform the following steps in place of steps 1 through 3 above.
  - ① In the PLAY mode, select the movie you want to edit and then press [MENU].
  - ② On the “PLAY” tab, select “Movie Editing” and then press [▶].

### 4. Use [▲] and [▼] to select the cut operation and then press [SET].

- To cancel movie editing, select “Cancel” and then press [SET]. This will return to the paused movie playback screen.

### 5. Select the frame (point) where you want to cut the movie.





Cut range (red)

To do this:	Press this button:
Fast forward or fast reverse playback	[▶] or [◀]
Pause or unpause movie playback	[SET]
Scroll paused playback one frame forward or back	[▶] or [◀]

- To cancel the cut operation, press [MENU]. This will return to the screen in step 3.

**6. Press [▼] to perform the required cut operation(s).**



<b>For this type of cut operation:</b>	<b>Do this:</b>
 Cut (To-Point Cut)	Select the point up to which you want to cut and then press [▼].
 Cut (From-Point Cut)	Select the point from which you want to cut and then press [▼].
 Cut (Point-To-Point Cut)	<ol style="list-style-type: none"><li>1. Select the start point of the center segment and then press [▼].</li><li>2. Select the end point of the center segment and then press [▼].</li></ol>

**7. In response to the confirmation message that appears, use [▲] and [▼] to select “Yes” and then press [SET].**

- To cancel movie editing, select “No” instead of “Yes” and then press [SET]. This will return to the paused movie playback screen.
- The selected cut operation will take considerable time to complete. Wait until the “Busy... Please wait...” message disappears from the monitor screen before performing any operation on the camera. Note that a cut operation can take a very long time if the movie being edited is long.

## Creating a Snapshot of a Movie Frame (MOTION PRINT)

MOTION PRINT lets you capture a movie frame and use it to create a snapshot. The snapshot you create can be either of the two formats described below.

<b>9-frame Snapshot</b>	This format puts the selected movie frame in the center, the four frames that precede it along top and the four frames that follow it along the bottom.	
<b>1-frame Snapshot</b>	This format creates a snapshot using the selected movie frame only.	

1. In the **PLAY** mode, use [**◀**] and [**▶**] to scroll through images and display the movie that contains the frame you want to use.
2. Press [**MENU**].
3. On the “**PLAY**” tab, select “**MOTION PRINT**”, and then press [**▶**].
4. Use [**▲**] and [**▼**] to select either “**9 frames**” or “**1 frame**”.
5. Use [**◀**] and [**▶**] to scroll through the movie frames and search for the one you want to use as the image of the snapshot.
  - Holding down [**◀**] or [**▶**] scrolls at high speed.

**6. After displaying the movie frame you want, press [SET].**

- If you selected “9 frames” in step 4, the camera will create a 9-frame snapshot with the frame you selected in step 6 in the center.
- If you selected “1 frame” in step 4, the camera will create a snapshot of the frame you selected in step 6.

 **IMPORTANT!**

- MOTION PRINT is not possible using a movie that was recorded on a different type of camera.

# USING AUDIO

## Adding Audio to a Snapshot

The dubbing feature of your camera lets you add audio to a snapshot after you shoot it. A snapshot that includes audio (regardless of whether the audio was recorded on the spot or added later) is indicated by the “” icon.

You can re-record a snapshot’s audio whenever you want. You can record up to about 30 seconds of audio for a snapshot.

**1. In the PLAY mode, use [◀] and [▶] to scroll through images and display the snapshot to which you want to add audio.**

**2. Press [MENU].**

**3. On the “PLAY” tab, select “Dubbing” and then press [▶].**

- This operation can be performed only while a snapshot is on the monitor screen.



**4. Press the shutter button to start audio recording.**

**5. Press the shutter button again to stop audio recording.**

Recording will stop automatically after about 30 seconds if you do not press the shutter button.

### To play back snapshot audio

Perform the steps under “Listening to the Audio of an Audio Snapshot” on page 145.



## ■ Re-recording Snapshot Audio

### **IMPORTANT!**

- Note that you cannot restore the original audio once you delete or re-record the audio of a snapshot.

- 1. In the PLAY mode, use [◀] and [▶] to scroll through images and display the snapshot whose audio you want to re-record.**
- 2. Press [MENU].**
- 3. On the “PLAY” tab, select “Dubbing” and then press [▶].**
- 4. Use [▲] and [▼] to select “Delete” and then press [SET].**
  - If you just want to delete the audio of the snapshot without re-recording anything, press [MENU] here and skip the rest of this procedure.

## **5. Press the shutter button to start audio recording.**

This deletes the previous recording and replaces it with the new one.

## **6. Press the shutter button again to stop audio recording.**

Recording will stop automatically after about 30 seconds if you do not press the shutter button.

### **NOTE**

- Your camera supports the following audio data formats.
  - Audio Format: WAVE/ADPCM (.WAV extension)
  - Approximate Audio File Size: 165KB (30-second recording at 5.5KB per second)
- See page 81 for recording precautions.
- Adding audio (dubbing) is not possible for the following types of images.
  - Images created using MOTION PRINT
  - Protected images

## Recording Audio Only (Voice Recording)

Voice Recording lets you record audio only, without a snapshot or movie.

Using built-in memory only, you get up to about 35 minutes of Voice Recording.

**1. In the REC mode, press [BS].**

**2. Use [▲], [▼], [◀], and [▶] to select “Voice Recording” and then press [SET].**

This causes “” to appear on the monitor screen.

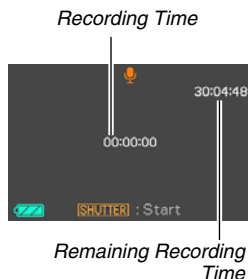

**3. Press the shutter button to start recording.**

- The operation lamp flashes green while recording is in progress.
- Pressing [SET] during recording will insert a marker into the recording. During later playback, you will be able to jump to the markers in the recording.

**4. Press the shutter button again to stop audio recording and return to the screen in step 3.**

- Recording also will stop automatically if memory becomes full.

**5. Now you can repeat steps 3 and 4 to record more, or you can exit this procedure by pressing [BS] and selecting another BEST SHOT scene.**

When exiting this procedure, select “Auto” for normal image recording.

## NOTE

- You can also play back Voice Recording data on your computer using QuickTime.
- Your camera supports the following audio data formats.
  - Audio Data: WAVE/ADPCM (.WAV extension)
  - Approximate Audio File Size: 165 KB (30-second recording at 5.5KB per second)
- See page 81 for recording precautions.

## ■ Playing Back Voice Recording Data

### 1. Enter the PLAY mode, and then use [◀] and [▶] to display the Voice Recording file you want to play.

“” is displayed in place of an image for a Voice Recording file.

### 2. Press [SET] to start playback.



## Voice Recording Playback Controls

To do this:	Do this:
Fast forward or fast reverse playback.	Hold down [▶] or [◀].
Pause or restart playback	Press [SET].
Jump to a marker in the audio data while playback is paused.	Press [▶] or [◀].
Adjust volume <ul style="list-style-type: none"><li>• You can adjust volume only while playback is in progress or paused.</li></ul>	Press [▼] and then use [▲] and [▼].
Toggle on-screen indicators on or off	Press [▲] (DISP).
Stop playback	Press [MENU].

# MANAGING YOUR FILES

## Files and Folders

Your camera treats each snapshot, movie, and Voice Recording, as a separate file.

You can delete, protect, and copy files as required.

Files are grouped in folders that are created automatically by the camera.

Files and folders have their own unique names, which are assigned automatically by the camera.

- For details about how folders are organized in memory, see "Memory Folder Structure" (page 238).

	Name and Maximum Number Allowed	Example
<b>File</b>	<p>Each folder can contain up to 9999 files named CIMG0001 through CIMG9999. The extension on the file name depends on the file type.</p> <ul style="list-style-type: none"><li>• If a folder already contains 9999 files, recording another file will cause a new folder to be created automatically.</li></ul>	<p>26th file name:</p> <p style="text-align: center;">CIMG<u>0026</u>.<u>JPG</u></p> <p style="text-align: center;"><i>Serial number      Extension</i> <i>(4 digits)</i></p>
<b>Folders</b>	<p>Folders are named from 100CASIO* to 999CASIO*</p> <ul style="list-style-type: none"><li>• There can be up to 900 folders.</li><li>* The BEST SHOT mode (page 97) includes a sample scene that optimizes settings for auction site images. Depending on your camera model, the sample scene is named either "For eBay" or "Auction".<ul style="list-style-type: none"><li>– Images recorded with the eBay scene are stored in a folder named "100_EBAY".</li><li>– Images recorded with the Auction scene are stored in a folder named "100_AUCT".</li></ul></li><li>* The BEST SHOT mode (page 97) also has a scene (named "For YouTube") that optimizes movie settings for YouTube. Images recorded with the YouTube scene are stored in a folder named "100YOUTB".</li></ul>	<p>100th folder name:</p> <p style="text-align: center;"><u>100</u>CASIO*</p> <p style="text-align: center;"><i>Serial number (3 digits)</i></p>

## NOTE

- You can view folder and file names on your computer. For details about how file names are displayed on the camera's monitor screen, see page 245.
- The total number of folders and files that is allowed depends on the image size and quality, and capacity of the memory card being used for storage.

## Protecting a File Against Deletion

You can protect an important file to ensure that it cannot be deleted accidentally.

### **IMPORTANT!**

- Note that even if a file is protected, it will be deleted if you perform the format operation (pages 14, 49, 200).

### ■ Protecting a Specific File

1. In the **PLAY** mode, press [MENU].
2. On the “PLAY” tab, select “Protect” and then press [▶].
3. Use [◀] and [▶] to scroll through images until the one you want to protect is on the monitor screen.

4. Use [▲] and [▼] to select “On” and then press [SET].

An image that is protected is indicated by the “

5. Now you can repeat steps 3 and 4 to protect another image or exit this procedure by pressing [MENU].

#### To unprotect a specific file

Perform the procedure under “Protecting a Specific File”, but in step 4 select “Off” instead of “On”.

#### ■ Protecting All Files in Memory

1. In the PLAY mode, press [MENU].
2. On the “PLAY” tab, select “Protect” and then press [▶].
3. Use [▲] and [▼] to select “All Files : On” and then press [SET].

This protects all files currently in memory.

4. Press [MENU].

#### To unprotect all files in memory

Perform the procedure under “Protecting All Files in Memory”, but in step 3 select “All Files : Off” instead of “All Files : On”.

## Using the FAVORITE Folder

The FAVORITE folder is located in the camera's built-in memory, and you can use it to store personal snapshots that you do not want displayed during normal PLAY mode operations. FAVORITE folder snapshots remain in camera memory, even if you change to a different memory card.

### IMPORTANT!

- The FAVORITE folder can be used for snapshots only. Saving an audio snapshot in the FAVORITE folder will save the snapshot part only.

### ■ Copying a File to the FAVORITE Folder

1. In the **PLAY** mode, press [MENU].
2. On the “PLAY” tab, select “Favorites” and then press [▶].
3. Use [▲] and [▼] to select “Save” and then press [SET].
4. Use [◀] and [▶] to select the snapshot you want to copy to the FAVORITE folder.

5. Use [▲] and [▼] to select “Save”, and then press [SET].

This saves a copy of the snapshot to the FAVORITE folder.

6. Now you can repeat steps 4 and 5 to save another image, or press [MENU] twice to exit this procedure.

### IMPORTANT!

- The snapshot copied to the FAVORITE folder is converted to QVGA size (320 × 240 pixels). A snapshot in the FAVORITE folder cannot be restored to its original size.
- Snapshots in the FAVORITE folder cannot be copied to a memory card.

### NOTE

- The number of snapshots that can be stored in the FAVORITE folder depends on the image quality of each one, and how much built-in memory capacity is remaining.

## ■ Viewing Snapshots in the FAVORITE Folder

1. In the PLAY mode, press [MENU].
2. On the “PLAY” tab, select “Favorites” and then press [▶].
3. Use [▲] and [▼] to select “Show” and then press [SET].
4. Use [◀] and [▶] to scroll through the snapshots in the FAVORITE folder.



*FAVORITE folder icon*

5. After you are finished viewing the FAVORITE folder snapshots, press [MENU] twice to exit this procedure.

Perform the following steps to view FAVORITE folder contents on your computer.

1. Remove the memory card from the camera.
2. Connect the camera to the computer.
3. Perform the required operations on your computer to navigate to the camera’s memory and display the FAVORITE folder contents.



## Copying Files

Files can be copied from the camera's built-in memory to a memory card, or from a memory card to built-in memory.

This makes it possible, for example, to perform the following steps and copy a file from your memory card to another person's memory card.

- ① Copy the file from your memory card to the camera's built-in memory.
- ② Remove your memory card and insert the other person's memory card.
- ③ Copy the file from built-in memory to the other memory card.



### IMPORTANT!

- You can copy snapshots, movies, audio snapshots, or Voice Recording files you recorded with your camera.
- You cannot copy a snapshot that is in the FAVORITE folder.
- When a copied file image appears on the full-month calendar screen, it is displayed on the date that it was copied (page 157).

## ■ Copying All Files in Built-in Memory to a Memory Card

The following operation copies all files from built-in memory to a memory card. You cannot copy files individually.

- 1. Load the memory card to which you want to copy the files into the camera.**
- 2. Turn on the camera, enter the PLAY mode and then press [MENU].**
- 3. On the “PLAY” tab, select “Copy” and then press [▶].**
- 4. Use [▲] and [▼] to select “Built-in → Card” and then press [SET].**

This starts the copy operation. Wait until the “Busy... Please wait...” message disappears from the monitor screen before performing any operation on the camera.

- After the copy operation is complete, the last file copied will be displayed on the monitor screen.

## ■ Copying a Single File from a Memory Card to Built-in Memory

With this procedure, files must be copied one-by-one.

- 1. Load the memory card that contains the file you want to copy into the camera.**
- 2. Turn on the camera, enter the PLAY mode and then press [MENU].**
- 3. On the “PLAY” tab, select “Copy” and then press [▶].**
- 4. Use [▲] and [▼] to select “Card → Built-in” and then press [SET].**
- 5. Use [◀] and [▶] to select the file you want to copy.**
- 6. Use [▲] and [▼] to select “Copy” and then press [SET].**

This starts the copy operation. Wait until the “Busy... Please wait...” message disappears from the monitor screen before performing any operation on the camera.

- The copied image reappears on the monitor screen after the copy operation is complete.

- 7. Now you can repeat steps 5 and 6 to copy another file, or you can exit this procedure by pressing [MENU].**

### NOTE

- Files are copied to the folder in built-in memory whose name has the largest serial number.

# DELETING FILES

You can delete files you no longer need, or after you transfer them to your computer's hard disk or print them. This frees up memory for new files.

You can delete one specific file, or you can delete all files currently in memory.

Here we will explain the different file delete procedures, including how to delete snapshots from the FAVORITE folders.

## **IMPORTANT!**

- Remember that a file delete operation cannot be undone. Always make sure that you really no longer need a file before deleting it.
- A protected file cannot be deleted. To delete a protected file, first remove its protection (page 181).
- Deleting an audio snapshot deletes both the snapshot and the audio file.

## Deleting a Specific File

1. In the **PLAY** mode, press [**▼**] (   ).

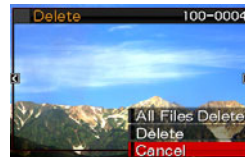

2. Use [**◀**] and [**▶**] to scroll through the images until the one for the file you want to delete is on the monitor screen.
3. Use [**▲**] and [**▼**] to select “Delete” and then press [**SET**].
  - To exit the delete operation without deleting anything, select “Cancel”.
4. Now you can repeat steps 2 and 3 to delete another file.
  - You can exit this procedure by pressing [**MENU**].

## Deleting All Files

1. In the **PLAY** mode, press [**▼**] (  ).
2. Use [**▲**] and [**▼**] to select “All Files Delete” and then press [**SET**].
3. In response to the confirmation message that appears, use [**▲**] and [**▼**] to select “Yes”.
  - To cancel the delete operation, select “No” instead of “Yes”.
4. Press [**SET**].
  - This deletes all of the files and displays the message “There are no files.”

## Deleting FAVORITE Folder Snapshots

You can delete a single snapshot, or you can delete all the snapshots currently in the FAVORITE folder.

1. In the **PLAY** mode, press [**MENU**].
2. On the “PLAY” tab, select “Favorites” and then press [**▶**].
3. Use [**▲**] and [**▼**] to select “Show” and then press [**SET**].
4. Press [**▼**] (  ).
5. Use the procedures under “Deleting a Specific File” and “Deleting All Files” to delete the snapshots you want.
  - You can exit this procedure by pressing [**MENU**] twice.

# OTHER SETTINGS

## Configuring Camera Sound Settings

Your camera lets you configure the following sound settings.

- Type of sound and volume for shutter release and other operations
- Volume level for movie and Voice Recording playback

### ■ Selecting the Operation Sound

1. Press [MENU].
2. On the “Set Up” tab, select “Sounds” and then press [▶].
3. Use [▲] and [▼] to select the operation whose sound you want to configure (Startup, Half Shutter, Shutter, Operation) and then press [▶].

4. Use [▲] and [▼] to select the setting you want and then press [SET].

To do this:	Select this setting:
Sound one of the built-in sounds (1 through 5)	Sound 1 - 5
Turn sound off	Off

## ■ Setting the Operation Tone Volume Level

1. Press [MENU].
2. On the “Set Up” tab, select “Sounds” and then press [▶].
3. Use [▲] and [▼] to select “ Operation”.
4. Use [◀] and [▶] to specify the playback volume setting you want and then press [SET].
  - You can set the volume to one of eight levels in the range of 0 (lowest) to 7 (highest).
  - Setting a volume level of 0 mutes the sound.

### NOTE

- The volume setting you configure here is also applied to video output (page 153).

## ■ Setting the Playback Volume Level

You can use this procedure to set the playback volume level for movies and audio snapshots, independent of the operation tone volume.

1. Press [MENU].
2. On the “Set Up” tab, select “Sounds” and then press [▶].
3. Use [▲] and [▼] to select “ Play”.
4. Use [◀] and [▶] to specify the operation tone volume setting you want and then press [SET].
  - You can set the volume to one of eight levels in the range of 0 (lowest) to 7 (highest).
  - Setting a volume level of 0 mutes the sound.



### IMPORTANT!

- The volume setting you configure here does not affect the video output (page 153).

## Turning the Startup Screen On or Off

You can configure the camera to display a startup screen of an image you recorded, whenever you turn it on.

- Even if you configure startup screen settings in the PLAY mode, the startup screen does not appear when turn on the camera by pressing [▶] (PLAY).

1. Press [MENU].
2. On the “Set Up” tab, select “Startup” and then press [▶].
3. Use [◀] and [▶] to scroll through the images until the one you want to use as the startup screen is on the monitor screen.
4. Use [▲] and [▼] to select the setting you want and then press [SET].

To do this:	Select this setting:
Use the selected image as the startup screen	On
Turn off the startup screen	Off

### NOTE

- The following are the types of images that you can select for the startup screen.
  - Special startup screen images built into the camera
  - Snapshots
  - Audio snapshots (Audio does not play.)
- Only one startup screen image can be in effect at any time. To change the startup screen to another image, simply overwrite the current image with the new one.
- Formatting built-in memory (page 200) will delete the current startup screen image.

## Specifying the File Name Serial Number Generation Rule

Use the following procedure to specify the rule that governs generation of the serial number used in file names (page 180).

1. Press [MENU].
2. On the “Set Up” tab, select “File No.” and then press [▶].
3. Use [▲] and [▼] to select the setting you want and then press [SET].

To have the camera do this:	Select this setting:
<p>Remember the numbers used for files. Files will be named using the next sequential number, even if files are deleted or if a blank memory card is loaded.</p> <ul style="list-style-type: none"><li>• If a memory card is loaded that already has files stored on it and the largest sequential number in the existing file names is greater than the largest sequential number remembered by the camera, numbering of new files will start from the largest sequential number in the existing file names plus 1.</li></ul>	Continue
<p>Restart the serial number from 0001 whenever all files are deleted or when the memory card is replaced with a blank one.</p> <ul style="list-style-type: none"><li>• If a memory card is loaded that already has files stored on it, numbering of new files will start from the largest sequential number in the existing file names number plus 1.</li></ul>	Reset



## Changing the Camera Date and Time Setting

When changing the date and time setting, be sure to do so for your Home City (the location where you normally use the camera). If you already have your Home City setting configured correctly, you can use the procedure under “Setting the Date and Time for Your Home City” (page 194) to change the current time setting only, if you want.

### IMPORTANT!

- Changing the time and date setting without correctly configuring your Home City setting first will cause all of the World Time (page 195) dates and times to be off.

### ■ Selecting Your Home City

1. Press [MENU].
2. On the “Set Up” tab, select “World Time” and then press [▶].

This displays the current World Time settings.

3. Use [▲] and [▼] to select “Home” and then press [▶].
4. Use [▲] and [▼] to select “City” and then press [▶].
5. Use [▲], [▼], [◀], and [▶] to select the area where your Home City is located and then press [SET].
6. Use [▲] and [▼] to select your home city and then press [SET].
7. After the setting is the way you want, press [SET] to exit the setting screen.

## ■ Setting the Date and Time for Your Home City

1. Press [MENU].
2. On the “Set Up” tab, select “Adjust” and then press [▶].
3. Set the date and the time.

To do this:	Do this:
Move the cursor between settings	Press [◀] or [▶].
Change the setting at the cursor location	Press [▲] or [▼].
Toggle between 12-hour and 24-hour format	Press [BS].

4. After all of the settings are the way you want, press [SET] to exit the setting screen.

## ■ Changing the Date Format

You can select from among three different formats for the date.

1. Press [MENU].
2. On the “Set Up” tab, select “Date Style” and then press [▶].
3. Use [▲] and [▼] to select the setting you want and then press [SET].

Example: December 19, 2007

To display the date like this:	Select this format:
07/12/19	YY/MM/DD
19/12/07	DD/MM/YY
12/19/07	MM/DD/YY

## NOTE

- This setting also affects the Operation Panel date format as shown below (page 53).

When this date format setting is selected:	The Operation Panel date appears as:
YY/MM/DD or MM/DD/YY	MM/DD
DD/MM/YY	DD/MM

## Using World Time

You can use the World Time screen to view the current time in zone that is different from your Home City when you go on a trip, etc. World Time displays the current time in 162 cities in 32 time zones around the globe.

### Configuring World Time Settings

1. Press [MENU].
2. On the “Set Up” tab, select “World Time” and then press [▶].
3. Use [▲] and [▼] to select “World” and then press [▶].

**4. Use [▲] and [▼] to select “City” and then press [▶].**

- To configure the summer time setting, use [▲] and [▼] to select “DST” and then select “On”.
- Summer time is used in some areas to advance the current time setting by one hour during the summer months.
- Use of summer time depends on the local customs and laws.



**5. Use [▲], [▼], [◀], and [▶] to select the area where the city you want to view is located and then press [SET].**

**6. Use [▲] and [▼] to select the city you want and then press [SET].**

**7. After the setting is the way you want, press [SET] to exit the setting screen.**

**■ Switching between the Home Time and World Time Screens**

- 1. Press [MENU].**
- 2. On the “Set Up” tab, select “World Time” and then press [▶].**
- 3. Use [▲] and [▼] to select “World” for the World Time screen, or “Home” for the Home Time screen.**
- 4. After selecting the screen you want, press [SET] to exit the setting screen.**

## Changing the Display Language

You can use the procedure below to select a display text language.

- The number and types of languages depend on the geographic area where the camera was marketed.

1. Press [MENU].
2. On the “Set Up” tab, select “Language” and then press [▶].
3. Use [▲], [▼], [◀], and [▶] to select the setting you want and then press [SET].

### ■ If the display contents are in the wrong language

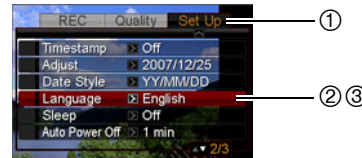

- ① : Select this tab.  
② : Select the “Language” item.  
③ : Select the language you want.

## Changing the USB Port Protocol

You can use the procedure below to change the USB communication protocol that is used when exchanging data with a computer, printer, or other external device. Select the protocol that suits the device to which you are connecting.

1. Press [MENU].
2. On the “Set Up” tab, select “USB” and then press [▶].

3. Use [▲] and [▼] to select the setting you want and then press [SET].

When you want to connect to this type of device:	Select this setting:
Computer or a printer that supports USB DIRECT-PRINT (page 202) With this setting, the computer sees the camera as an external storage device. Use this setting for normal transfer of images from the camera to a computer (using the bundled Photo Loader with HOT ALBUM application).	Mass Storage (USB DIRECT-PRINT)
Printer that supports PictBridge (page 202) This setting simplifies the transfer of image data to the connected device.	PTP (PictBridge)

## [RECORD] (REC) and [PLAY] (PLAY) Button Settings

You configure the camera so it does not turn on when you press the [RECORD] (REC) or [PLAY] (PLAY) button, or to turn off when you press the [RECORD] (REC) or [PLAY] (PLAY) button.

1. Press [MENU].
2. On the “Set Up” tab, select “REC/PLAY” and then press [▶].
3. Use [▲] and [▼] to select the setting you want and then press [SET].

To configure the button to do this when pressed:	Select this setting:
Turn on the camera	Power On
Turn on or turn off the camera	Power On/Off
Do not turn on the camera	Disable

### NOTE

- With “Power On/Off”, the camera turns off when you press [RECORD] (REC) in the REC mode or [PLAY] (PLAY) in the PLAY mode.
- The initial factory default for this setting is “Power On”.
- Change this setting to anything besides “Disable” before connecting to a TV for image viewing.

## Formatting Built-in Memory

Formatting built-in memory deletes any data stored in it.

### IMPORTANT!

- Note that data deleted by a format operation cannot be recovered. Check to make sure you do not need any of the data in built-in memory before you format it.
- Formatting built-in memory also deletes the following.
  - Face Recognition data saved with Record Family
  - Protected images
  - FAVORITE folder images
  - BEST SHOT mode user setups
  - Startup screen
- Make sure that the battery is charged fully before starting a formatting operation. Formatting may not be performed correctly and the camera may stop operating normally if the camera powers down while formatting is in progress.
- Never open the battery cover while formatting is in progress. Doing so can cause the camera to stop operating normally.

### 1. Check to make sure there is no memory card loaded in the camera.

- If there is a memory card loaded in the camera, remove it.

### 2. Press [MENU].

### 3. On the “Set Up” tab, select “Format” and then press [▶].

### 4. Use [▲] and [▼] to select “Format” and then press [SET].

This formats built-in memory.

- To exit the format operation without formatting, select “Cancel”.
- Entering the PLAY mode after formatting the built-in memory will cause the message “There are no files.” to appear.



# PRINTING

## Types of Printing

There are three different methods you can use for printing images.

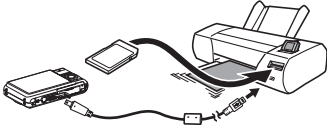
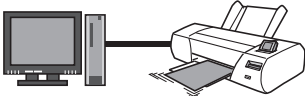
<b>Professional Print Service</b> (page 202)		<p>Take the memory card that contains the images you want to print to a professional print service.</p> <ul style="list-style-type: none"><li>• You can use DPOF settings to specify which images you want to print, the number of copies, and date stamp settings before taking the card in for printing.</li></ul>
<b>Printing at Home</b>	<p>Printing on a Printer (page 202)</p> 	<p>Print on a printer that supports PictBridge or USB DIRECT-PRINT, or on a printer equipped with a memory card slot.</p> <ul style="list-style-type: none"><li>• You can use DPOF settings to specify which images you want to print, the number of copies, and date stamp settings before printing.</li></ul>
	<p>Printing with a Computer</p> 	<p>■ <b>Windows Computer</b></p> <p>Install the software (Photo Loader with HOT ALBUM) that comes bundled with the camera.</p> <p>See "Using the Camera with a Windows Computer" on page 212.</p> <p>■ <b>Macintosh</b></p> <p>After transferring the images to your Macintosh, use commercially available software to print.</p> <p>See "Using the Camera with a Macintosh" on page 230.</p>

## ■ Printing Precautions

- See the documentation that comes with your printer for information about print quality and paper settings.
- Contact the manufacturer of your printer to find out if it supports PictBridge or USB DIRECT-PRINT, for new printer versions, etc.
- Never disconnect cables or perform any camera operation while printing is in progress. Doing so can cause a printer error.

## Using Professional Print Service

Take a memory card that contains the images you want to print to the professional print service. Before taking in a memory card, you can use the camera's DPOF settings (page 206) to specify which images you want printed, the number of copies, and whether or not the images should include a date stamp.

## Using Your Printer to Print Images

If your printer is either of the types described below, you can use it to print without going through a computer.

- Printer equipped with a card slot for the type of memory card you are using
- Printer that support PictBridge or USB DIRECT-PRINT

## ■ Printing on a Printer with a Memory Card Slot

Remove a memory card from the camera and insert it directly into the printer's memory card slot. Depending on what type of printer you are using, it also may be able to read the settings (images to be printed, number of copies, date stamping) you configure with the camera's DPOF settings (page 206). For details, see the user documentation that comes with your printer.

## ■ Printing on a Printer that Supports PictBridge or USB DIRECT-PRINT

You can connect the camera directly to a PictBridge or USB DIRECT-PRINT compliant printer and print images without going through a computer.

- The camera also allows easy connection to a printer. Before connecting to a printer, be sure to perform the following procedure first.

1. Press [MENU].
2. On the “Set Up” tab, select “USB” and then press [▶].
3. Use [▲] and [▼] to select the setting that suits your printer and then press [SET].

For this type of printer:	Select this setting:
USB DIRECT-PRINT compatible	Mass Storage
PictBridge compatible	PTP

4. Check the battery level indicator to make sure that the battery is fully charged, and then turn off the camera.

- If battery power is low, replace the battery.
- The camera does not draw power over the USB cable.

5. Use the USB cable that comes with the camera to connect the camera to a printer.

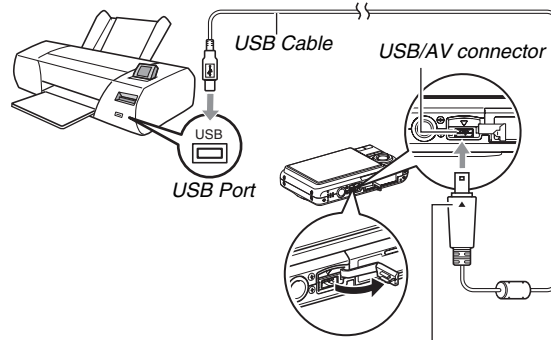

*Making sure that the ▼ mark on the camera is aligned with the ▲ mark of the USB cable plug, connect the cable to the camera.*

- When connecting the bundled USB cable to the camera's USB/AV port, insert the plug into the port until you feel it click securely into place. Failure to insert the plug fully can result in poor communication or malfunction of the connected components.
- Some metal of the plug is visible even when the plug is inserted correctly.
- Take care when connecting the USB cable to the camera or your printer. USB ports and cable plugs are shaped for proper positioning.

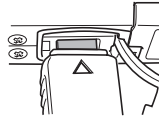

## 6. Turn on the printer.

## 7. Load paper into the printer.

## 8. Turn on the camera.

This displays a print menu on the camera's monitor screen.

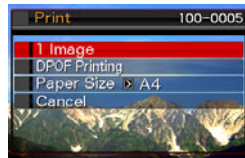

## 9. Use [▲] and [▼] to select “Paper Size” and then press [▶].

## 10. Use [▲] and [▼] to select a paper size and then press [SET].

- The following are the available paper sizes.  
3.5" × 5", 5" × 7", 4" × 6", A4, 8.5" × 11", By Printer
- Selecting “By Printer” prints using a paper size selected on the printer.
- Available paper settings depend on the connected printer. For full details, see the user documentation that comes with your printer.

## 11. Use [▲] and [▼] to specify the print option you want.

If you want to print a specific image:

Select “1 Image” and then press [SET]. After that, use [◀] and [▶] to display the image you want to print.

If you want to print multiple images:

Select “DPOF Printing” and then press [SET]. Next, use the DPOF settings (page 206) to specify the images you want to select.

- To toggle date stamping on and off, press [BS]. The date stamp will be printed when “On” is indicated on the monitor screen.



## 12. Use [▲] and [▼] to select “Print” and then press [SET].

Printing will start and the message “Busy... Please wait...” will appear on the monitor screen. The message will disappear after a short while, even though printing is still being performed. Pressing any camera button will cause the printing status message to re-appear.

The print menu screen will re-appear when printing is complete.

- If you selected “1 Image” in step 11, you can repeat the procedure from step 11 to print other images, if you want.

## 13. After printing is complete, turn off the camera and then disconnect the USB cable from the camera.

## Using DPOF to Specify Images to be Printed and the Number of Copies

DPOF (Digital Print Order Format) lets you specify which images you want to print, the number of copies, and whether date stamping is turned on or off. The settings you configure are recorded on the memory card. After configuring settings you can use the memory card to print on a home printer that supports DPOF or take the memory card to a professional print service. With DPOF, you can configure settings while viewing the actual images on the camera's monitor screen, so there is no need to recall hard-to-remember files names, etc.



### **IMPORTANT!**

- Some printers may ignore time stamp settings or may not support DPOF at all. Check the user documentation that comes with your printer for details.
- Certain print service providers may not support DPOF or may support different printing protocols. In this case, you will need to perform printing in accordance with the instructions provided by the print service you are using.

## ■ Configuring DPOF Settings Individually for Each Image

1. In the **PLAY** mode, press [MENU].
2. On the “**PLAY**” tab, select “**DPOF Printing**” and then press [▶].

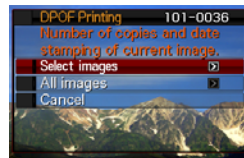

3. Use [▲] and [▼] to select “**Select images**” and then press [▶].
4. Use [◀] and [▶] to scroll through the images until the one you want to print is on the monitor screen.

**5. Use [▲] and [▼] to specify the number of copies.**

- You can specify up to 99 for the number of copies. Specify 0 if you do not want to print the image.

**6. If you want to include the date in the image, press [BS] to change the displayed date stamping setting to “On”.**

- To turn off date stamping, press [BS] so “Off” is displayed.
- Repeat steps 4 through 6 to configure settings for other images, if you want.

**7. After everything is the way you want, press [SET] to save the settings.**

**■ Configuring the Same DPOF Settings for All the Images**

**1. In the PLAY mode, press [MENU].**

**2. On the “PLAY” tab, select “DPOF Printing” and then press [▶].**

**3. Use [▲] and [▼] to select “All images” and then press [▶].**

**4. Use [▲] and [▼] to specify the number of copies.**

- You can specify up to 99 for the number of copies. Specify 0 if you do not want to print.

**5. If you want to include the date in the images, press [BS] to change the displayed date stamping setting to “On”.**

- To turn off date stamping, press [BS] so “Off” is displayed.

**6. After everything is the way you want, press [SET] to save the settings.**

### **Clear DPOF settings when you no longer need them!**

DPOF settings are not cleared automatically after printing is complete. This means that if you perform another printing operation without clearing DPOF settings, printing will be performed in accordance with the last settings you configured. If you no longer need the currently configured DPOF settings, use the procedure under “Configuring the Same DPOF Settings for All the Images” to change the number of copies setting for all the images to 00.

### **Tell your print service about your DPOF settings!**

If you take a memory card to a professional print service, be sure to tell them that it includes DPOF settings for the images to be printed and the number of copies. If you don't, the print service may print all the images without regard to your DPOF settings, or they may ignore your date stamp setting.

## **Date Stamping**

You can use any one of the following three methods to include the recording date in the printout of an image.

- **Configure DPOF settings on the camera to specify date stamping (page 206)**
  - If an image already has the date or time stamped into it using the camera's Date Stamping feature, turning on DPOF date stamping will cause the two dates to be stamped in the same location. Be sure to turn off DPOF date stamping when printing an image that is stamped with the camera's Date Stamping function.
  - Some printers may ignore time stamp settings or may not support DPOF at all. Check the user documentation that comes with your printer for details.
  - Note that some professional print services do not support DPOF printing. Check with your service before ordering prints.
- **The camera's Date Stamping feature stamps the date and time directly into the image data (page 135).**



- You can insert dates using the bundled Photo Loader with HOT ALBUM (page 213) software (Windows only).
- Request date stamping when ordering prints from a professional print service
  - Some print services do not support date printing. Check with your service for more information.

## Supported Protocols

Your camera supports the protocols described below.

### ■ PictBridge and USB DIRECT-PRINT

- PictBridge  
Camera and Imaging Products Association  
(CIPA)
- USB DIRECT-PRINT  
Seiko Epson Corporation



### ■ PRINT Image Matching III

Using image editing software and printing on a printer that also supports PRINT Image Matching III makes it possible to use information about shooting conditions that is recorded with the image, and produce exactly the type of image you want.

PRINT Image Matching and PRINT Image Matching III are trademarks of Seiko Epson Corporation.



## ■ Exif Print

Printing on a printer that also supports Exif Print (Exif 2.2) uses information about shooting conditions recorded with the image to enhance printed image quality.

Contact your printer manufacturer for information about models that support Exif Print, printer upgrades, etc.



# USING THE CAMERA WITH A COMPUTER

## What you can do

Connecting the camera to a computer provides you with the capabilities described below.

<b>View and store images*</b>	You can use your computer to view camera images and for long-term storage of images.
<b>Manage, edit, and print images</b>	You can manage, edit, and print images stored on your computer. <ul style="list-style-type: none"><li>• Refer to the explanations later in this section and install the required software on your computers.</li></ul>
<b>Transfer images to the camera</b>	On a Windows computer (only), you can transfer images from your computer to camera memory. <ul style="list-style-type: none"><li>• You can even transfer images that were not originally recorded with the camera. You can capture (cut) a portion of the image (web page, map, etc.) currently on your computer screen and transfer it to camera memory.</li></ul>

- \* You can also transfer images to a computer for viewing and storage without connecting the camera, by removing the memory card from the camera and reading the contents of the card with your computer (page 237).

The procedures you need to perform when using the camera with your computer and when using the bundled software are different for Windows and the Macintosh.

- Windows users should refer to “Using the Camera with a Windows Computer” on page 212.
- Macintosh users should refer to “Using the Camera with a Macintosh” on page 230.

## Using the Camera with a Windows Computer

Install the required software in accordance with what version of Windows you are running and what you want to do.

Objective	Windows Version	Install this software:	See page:
<ul style="list-style-type: none"> <li>Viewing images on a computer</li> <li>Storing images on a computer</li> </ul>	Vista/XP/2000/Me	– (USB driver not required.)	–
	98SE/98	<b>USB driver Type B</b> <ul style="list-style-type: none"> <li>You can download the USB driver from the official EXILIM Website at <a href="http://www.exilim.com/">http://www.exilim.com/</a></li> </ul>	214
Transfer of images from the camera and management of images on the computer	Vista/XP/2000	<b>Photo Loader with HOT ALBUM 3.1</b> <b>DirectX 9.0c</b> (When DirectX 9.0 or higher is not installed on the computer already.)	221
Play movies	XP/2000	<b>QuickTime 7</b>	222
Edit movies	Vista/XP/2000/Me/98SE/98	– <ul style="list-style-type: none"> <li>Use commercial software as required.</li> </ul>	–
Upload movie files to YouTube	Vista/XP (SP2)/2000 (SP4)	<b>YouTube Uploader for CASIO</b>	224

Objective	Windows Version	Install this software:	See page:
Transfer images to the camera	Vista/XP/2000/Me/98SE/98	<b>Photo Transport 1.0</b>	226
View the User's Guide	Vista/XP/2000 (SP4)	<b>Adobe Reader 8</b> (Not required if already installed.)	229
	2000/Me/98SE/98	– <ul style="list-style-type: none"> <li>If your computer does not already have Adobe Reader or Adobe Acrobat Reader installed, go to the Adobe Systems Incorporated website to download and the version of Adobe Reader or Adobe Acrobat Reader that is compatible with your computer's operating system.</li> </ul>	–

## ■ Computer System Requirements for Bundled Software

Computer system requirements are different for each of the applications. Be sure to check the requirements for the particular application you are trying to use. Note that the values provided here are minimum requirements for running each application. Actual requirements are greater, depending on the number of images and the sizes of the images being handled.

### Photo Loader with HOT ALBUM 3.1

HD : At least 2GB

Other: Internet Explorer 5.5 or higher

DirectX 9.0 or higher

Windows Media Player 9 or higher

QuickTime 7 or higher

### DirectX 9.0c

HD: 65MB for installation (18MB on hard disk)

### YouTube Uploader for CASIO

- Sufficient memory to run the operating system
- Computer configuration that enables playback of movies on the YouTube site
- Computer configuration that enables upload of movies to the YouTube site

### Photo Transport 1.0

Memory: At least 64MB

HD : At least 2MB

### Adobe Reader 8

CPU : Pentium III Class Processor

Memory: At least 128MB

HD : At least 180MB

Other : Internet Explorer 6.0 or higher

### QuickTime 7

CPU : Pentium or higher

Memory: At least 128MB

OS : Windows 2000 Service Pack 4 / XP



### IMPORTANT!

- For details about the minimum system requirements for each software application, see the “Read me” files on the CD-ROM that comes bundled with the camera.

## ■ Precautions for Windows Vista Users

- Photo Transport will not run under Windows Vista 64 bit Version.
- Photo Transport can be used only by users logged in with Administrator privileges.
- Operation on a self-made computer or under a dual-processor environment is not supported.
- Operation may not be possible under certain computer environments.
- Photo Loader with HOT ALBUM provides a function for migrating image data previously saved with Photo Loader, which means you still will have access to your existing image archives.

## Viewing and Storing Images on a Computer

You can view and store images (snapshot and movie files) on your computer by connecting to the camera.

- You can connect the camera to your computer to view and store images (snapshot and movie files).
  - USB driver installation is not required in the case of Windows Vista, XP, 2000, and Me. Simply connect the camera to your computer.
  - If your computer is running Windows 98SE or 98, you need to install the USB driver (page 212). You can download the USB driver from the official EXILIM Website at <http://www.exilim.com/>

**If your computer is running Windows 98SE or 98, do not try to establish a connection between the camera and computer before installing the USB driver on the computer.**

If you do, the computer will not be able to recognize the camera.

If your computer is running Windows 98SE or 98, be sure to install the USB driver.

Do not connect the camera to your computer without installing the USB driver first.

#### General Procedure

1) Connecting the camera to your computer (page 215).



2) View and copy the images you want (page 218).

#### ■ Connecting the Camera to Your Computer the First Time

- 1. Make sure the camera's battery is fully charged.**
- 2. Turn on the camera, and then press [MENU].**
  - It makes no difference whether the camera is in the REC mode or the PLAY mode.
- 3. Select the "Set Up" tab, select "USB", and then press [▶].**
- 4. Use [▲] and [▼] to select "Mass Storage", and then press [SET].**

**5. Turn off the camera, and connect the USB cable that comes bundled with the camera to the camera's USB/AV connector and your computer's USB port.**

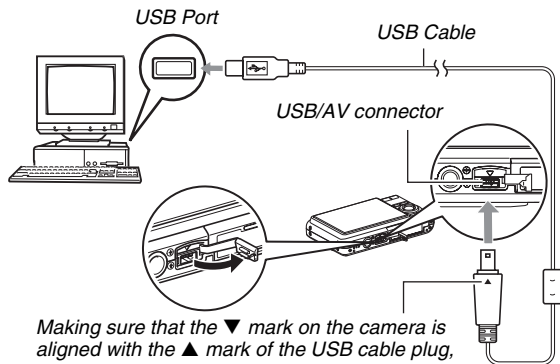

*Making sure that the ▼ mark on the camera is aligned with the ▲ mark of the USB cable plug, connect the cable to the camera.*

- When connecting the bundled USB cable to the camera's USB/AV port, insert the plug into the port until you feel it click securely into place. Failure to insert the plug fully can result in poor communication or malfunction of the connected components.

- Some metal of the plug is visible even when the plug is inserted correctly.
- Take care when connecting the USB cable to the camera or your computer. USB ports and cable plugs are shaped for proper positioning.

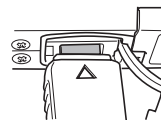

**6. Turn on the camera.**



## Camera-Computer Connection

Pressing the camera's [ON/OFF] button puts it into the USB mode, which is indicated by the camera's operation lamp lighting green. In this mode, your computer recognizes the memory card loaded in the camera (or the camera's built-in memory if it does not have a memory card loaded) as a removable disk.

From now on, you will not have to perform steps 3 through 5 in the above procedure when you connect the camera to your computer (unless you change the camera's USB settings for some reason).

- With some Windows setups, you may see a guidance message appear on your display to let you know about the new removable disk. If this happens, simply close the guidance message dialog box.

### **IMPORTANT!**

- Never disconnect the USB cable without exiting the USB mode first. Doing so can corrupt image data. See "Disconnect the camera from the computer" on page 220 for the correct steps you need to perform to disconnect the camera from the computer safely.

## ■ Connecting the Camera to Your Computer after the First Time

Since you need to configure menu settings only the first time you connect the camera to your computer, later connections are much simpler.

### **1. Turn off the camera, and connect the USB cable that comes bundled with the camera to the camera and your computer.**

### **2. Turn on the camera.**

Pressing the camera's [ON/OFF] button puts it into the USB mode, which is indicated by the camera's operation lamp lighting green.

## ■ Viewing Camera Images on Your Computer

After connecting the camera to your computer, you can view camera images on your computer screen.

**1. Windows XP users: Click “Start” and then “My Computer”.**

**Windows Vista users: Click “Start” and then “Computer”.**

**Windows 2000/Me/98SE/98 users: Double-click “My Computer”.**

**2. Double-click “Removable Disk”.**

- Your computer recognizes the memory card loaded in the camera (or built-in memory if there is no card) as a removable disk.

**3. Double-click the “DCIM” folder.**

**4. Double-click the folder that contains the image you want to view.**

**5. Double-click the file that contains the image you want to view.**

This displays the image.

- For information about file names, see “Memory Folder Structure” on page 238.

### NOTE

- An image that was rotated on the camera will be displayed on your computer screen in its original (unrotated) orientation.

## ■ Saving an Image on Your Computer

In order to work on an image or put it into an album, you must first save it to your computer. To save a camera image to your computer, you must first establish a connection between them.

### **1. Windows XP users: Click “Start” and then “My Computer”.**

**Windows Vista users: Click “Start” and then “Computer”.**

**Windows 2000/Me/98SE/98 users: Double-click “My Computer”.**

### **2. Double-click “Removable Disk”.**

- Your computer recognizes the memory card loaded in the camera (or built-in memory if there is no card) as a removable disk.

### **3. Right-click the “DCIM” folder.**

### **4. On the shortcut menu that appears, click “Copy”.**

### **5. Windows XP users: Click “Start” and then “My Documents”.**

**Windows Vista users: Click “Start” and then “Documents”.**

**Windows 2000/Me/98SE/98 users: Double-click “My Documents” to open it.**

- If you already have a “DCIM” folder in “My Documents”, the next step will overwrite it. If you want to keep the existing “DCIM” folder, you need to change its name or move it to a different location before performing the next step.

### **6. On the “My Documents” “Edit” menu, select “Paste”.**

This will paste the “DCIM” folder (and all the image files it contains) into your “My Documents” folder. You now have a copy of the files that are in camera memory on your computer.

## **IMPORTANT!**

- Never use your computer to modify, delete, move, or rename any image files that are in the camera's built-in memory or memory card. Doing so can cause problems with the camera's image management data, which will make it impossible to play back images on the camera and can drastically alter remaining memory capacity. Whenever you want to modify, delete, move, or rename an image, do so only on images that are stored on your computer.
- Never unplug the USB cable or operate the camera while viewing or storing images. Doing so can cause data to become corrupted.

## ■ **Disconnect the camera from the computer**

### **Windows Vista/XP/98SE/98 Users**

Press the camera's [ON/OFF] button. After making sure that the camera's operation lamp is not lit green, disconnect the camera from the computer.

### **Windows 2000/Me Users**

Click card services in the task tray on your computer screen, and disable the drive number assigned to the camera. Next, disconnect the USB cable from the camera, and then turn off the camera.

## Transfer of Images from the Camera and Management of Images on the Computer

To manage images on your computer, you need to install the Photo Loader with HOT ALBUM application from the CD-ROM that comes with the camera.

Photo Loader with HOT ALBUM lets you import images from the camera to your computer automatically, to arrange images by recording date, and to display images in a calendar format.

### ■ Installing Photo Loader with HOT ALBUM

#### 1. Start up your computer, and place the bundled CD-ROM into its CD-ROM drive.

- Normally, this should cause the menu screen to appear automatically. If your computer does not display the menu screen automatically, navigate to the CD-ROM on your computer and then double-click the "AutoMenu.exe" file.

#### 2. On the menu screen, click the "Language" down arrow button and then select the language you want.

#### 3. Click "Photo Loader with HOT ALBUM 3.1" to select it and then click "Read me."

- "Read me" files contain important information about installation, including installation conditions and computer system requirements.

#### 4. Click "Install" for Photo Loader with HOT ALBUM.

#### 5. Follow the instructions that appear on your computer screen to install Photo Loader with HOT ALBUM.

### Checking Your Computer's DirectX Version

In order to manage images using Photo Loader with HOT ALBUM, your computer also needs to have Microsoft DirectX 9.0 or higher installed. You can check the installed version of Microsoft DirectX using your PC's DirectX Diagnostic Tool.

- 1. On your computer, click “Start”, “All Programs”, “Accessories”, “System Tools” and then “System Information”.**
- 2. On the “Tools” menu, select “DirectX Diagnostic Tool”.**
- 3. On the “System” tab, check to make sure that the “DirectX Version” is 9.0 or higher.**
- 4. Click “Exit” to exit the DirectX Diagnostic Tool.**
  - If your PC already has Microsoft DirectX 9.0 or higher installed, you do not need to install Microsoft DirectX 9.0c from the bundled CD-ROM.
  - If your computer does not have Microsoft DirectX 9.0 or higher installed, install Microsoft DirectX 9.0c from the bundled CD-ROM.

## Playing Movies

You can play back movies on a computer that has QuickTime 7 or higher installed. To play back a movie, first copy it to your computer and then double-click the movie file.



- 1. Start up your computer, and place the bundled CD-ROM into its CD-ROM drive.**
  - Normally, this should cause the menu screen to appear automatically. If your computer does not display the menu screen automatically, navigate to the CD-ROM on your computer and then double-click the “AutoMenu.exe” file.
- 2. On the menu screen, click the tab for the language you want.**

**3. Click “QuickTime 7” to select it and then click “Read me”.**

- “Read me” files contain important information about installation, including installation conditions and computer system requirements.

**4. Click “Install” for QuickTime 7.**

**5. Follow the instructions that appear on your computer screen to install QuickTime 7.**

**■ Minimum Computer System Requirements for Movie Playback**

The minimum system requirements described below are necessary to play back movies recorded with this camera on a Windows computer.

Operating System : Windows Vista/XP/2000

Memory : Pentium M, 1GHz or higher  
Pentium 4, 2GHz or higher

Required Software : QuickTime 7  
DirectX 9.0c



**IMPORTANT!**

- The above is the recommended environment. Configuring this environment does not guarantee proper operation.
- Even if your computer meets the minimum requirements described above, certain settings and other installed software may interfere with proper playback of movies.

## Uploading Movie Files to YouTube

To simplify uploading of movie files you recorded with the “For YouTube” BEST SHOT scene, install YouTube Uploader for CASIO from the CD-ROM that comes with the camera.

### What is YouTube?

YouTube is a site managed by YouTube, LLC. At YouTube, you can upload movies you recorded and view movies that have been uploaded by others. You need to register as a YouTube user before you can upload movies there.

### ■ Installing YouTube Uploader for CASIO

#### 1. Start up your computer, and place the bundled CD-ROM into its CD-ROM drive.

- Normally, this should cause the menu screen to appear automatically. If your computer does not display the menu screen automatically, navigate to the CD-ROM on your computer and then double-click the “AutoMenu.exe” file.

#### 2. On the menu screen, click the “Language” down arrow button and then select the language you want.

#### 3. Click “YouTube Uploader for CASIO” to select it and then click “Read me.”

- “Read me” files contain important information about installation, including installation conditions and computer system requirements.

#### 4. Click “Install” for YouTube Uploader for CASIO.

#### 5. Follow the instructions that appear on your computer screen to install YouTube Uploader for CASIO.



## ■ Uploading a movie file to YouTube

### **IMPORTANT!**

- Before you can use YouTube Uploader for CASIO, you need to go to the YouTube website (<http://www.youtube.com/>) and register as a user there.
- Do not upload any video that is copyrighted (including neighboring copyrights) unless you yourself own the copyright or you have obtained the permission of the applicable copyright holder(s).

- 1. Record the movie you want to upload using the “For YouTube” BEST SHOT scene.**
- 2. If it isn’t already, connect your computer to the Internet.**
- 3. Connect the camera to your computer.**
  - See page 215 for information about connecting the camera to your computer.
- 4. Turn on the camera.**
  - YouTube Uploader for CASIO will start up automatically.
  - The first time you start up YouTube Uploader, a dialog box will appear and ask you to enter your YouTube user ID and your password, and to configure network environment settings. Follow the instructions on the dialog box and then click the [OK] button.

- 5. The left side of the display will have an area for inputting a title, category, and other information required for uploading to YouTube. Enter the required information.**
- 6. The right side of the display shows a list of movie files in camera memory. Select the check box next to the movie file you want to upload.**
- 7. After everything is the way you want, click the [Upload] button to upload the file.**
  - After uploading is complete, click the [Exit] button to exit the application.

### **IMPORTANT!**

- The maximum file size for upload to the YouTube website is 100MB.

## Transferring Images to the Camera

In order to return images from your computer memory back to the camera, install Photo Transport on your computer from the CD-ROM that comes with the camera.

### ■ Installing Photo Transport

#### 1. Start up your computer, and place the bundled CD-ROM into its CD-ROM drive.

- Normally, this should cause the menu screen to appear automatically. If your computer does not display the menu screen automatically, navigate to the CD-ROM on your computer and then double-click the "AutoMenu.exe" file.

#### 2. On the menu screen, click the "Language" down arrow button and then select the language you want.

- Regardless of the language you select, the English version of Photo Transport is installed.

#### 3. Click "Photo Transport" to select it and then click "Read me."

- "Read me" files contain important information about installation, including installation conditions and computer system requirements.

#### 4. Click "Install" for Photo Transport.

#### 5. Follow the instructions that appear on your computer screen to install Photo Transport.

### ■ Transferring image files to the camera

#### 1. First, connect the camera to your computer.

- See page 215 for information about connecting the camera to your computer.

#### 2. On your computer, click "Start", "All Programs", "Casio" and then "Photo Transport".

This starts up Photo Transport.

### 3. Drop the image data you want to transfer to the camera onto the Photo Transport Transfer button.

Move your mouse pointer to the image file you want to transfer, and then hold down your mouse button. Keeping your mouse button depressed, drag the mouse pointer and the image file along with it to the Photo Transport Transfer button, and then release the mouse button.

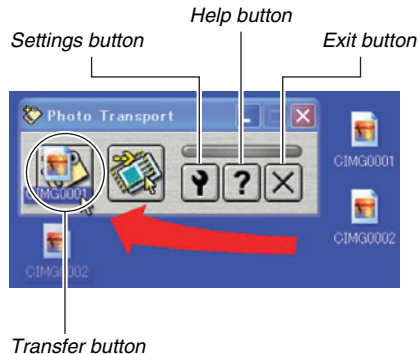

### 4. Follow the instructions that appear on the display to transfer the image file to the camera.

- The image transfer method and detailed image settings used depend on the Photo Transport settings. For details, see Photo Transport help (page 229).

#### **IMPORTANT!**

- Certain types of images may not be able to be transferred.
- You cannot transfer movies to the camera.
- Only image files of the following formats can be transferred to the camera: JPG, JPEG, JPE, and BMP. The transfer operation converts BMP files to JPEG format.

## ■ Transferring screen captures to the camera

### 1. First, connect the camera to your computer.

- See page 215 for information about connecting the camera to your computer.

### 2. On your computer, click “Start”, “All Programs”, “Casio” and then “Photo Transport”.

This starts up Photo Transport.

### 3. Display the screen whose screen capture you want to transfer.

### 4. Click the Photo Transport Capture button.

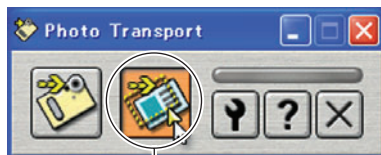

*Capture button*

### 5. Use your mouse to select the area of the screen you want to capture.

Move your mouse pointer to the upper left corner of the area you want to capture and then hold down your mouse button. Keeping your mouse button depressed, drag the pointer down to the right corner of the area and then release the mouse button.

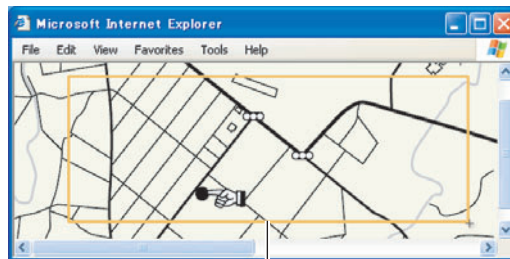

*Capture area*

## 6. Follow the instructions that appear on the display to transfer a capture of the selected area to the camera.

- The image transfer method and detailed image settings used depend on the Photo Transport settings. For details, see Photo Transport help (page 229).

### **IMPORTANT!**

- The transfer operation converts screen captures to JPEG format.

## ■ Photo Transport Setup and Help

Clicking the Settings button will display a dialog box that you can use to configure image transfer settings, to specify the transfer method, etc. For detailed information about the setup, operational procedures, and troubleshooting, click the Help button.

## Viewing User Documentation (PDF Files)

### 1. Start up your computer, and place the bundled CD-ROM into its CD-ROM drive.

- Normally, this should cause the menu screen to appear automatically. If your computer does not display the menu screen automatically, navigate to the CD-ROM on your computer and then double-click the "AutoMenu.exe" file.

### 2. On the menu screen, click the "Language" down arrow button and then select the language you want.

### 3. Click "Manual" to select it and then click "Camera".

### **IMPORTANT!**

- You must have Adobe Reader or Adobe Acrobat Reader installed on your computer in order to view the contents of a PDF file. If you do not already have Adobe Reader or Adobe Acrobat Reader installed, install Adobe Reader from the bundled CD-ROM.

## User Registration

You can perform user registration over the Internet. To do so, of course, you need to be able to connect to the Internet with your computer.

### 1. Click the “Register” button.

- This starts up your Web browser and accesses the user registration website. Follow the instructions that appear on your computer screen to register.

## Exiting the CD-ROM Menu

On the CD-ROM menu, click “Exit”.

## Using the Camera with a Macintosh

Install the required software in accordance with what version of the Macintosh OS you are running and what you want to do.

Objective	OS Version	Install this software:	See page:
<ul style="list-style-type: none"><li>• Viewing images on your Macintosh</li><li>• Storing images on your Macintosh</li></ul>	OS 9/OS X	<ul style="list-style-type: none"><li>• USB driver not required.</li></ul>	231
Transfer of images from the camera and management of images on your Macintosh	OS 9	<ul style="list-style-type: none"><li>• Use commercially available software.</li></ul>	235
	OS X	<ul style="list-style-type: none"><li>• Use iPhoto, which comes bundled with your operating system.</li></ul>	235

Objective	OS Version	Install this software:	See page:
Play movies	OS 9	<ul style="list-style-type: none"> <li>Movie file playback not supported.</li> </ul>	236
	OS X	<ul style="list-style-type: none"> <li>Movie file playback supported under OS X v10.3.9 or higher when QuickTime 7 or higher is installed.</li> </ul>	
View the User's Guide	OS 9/OS X	<ul style="list-style-type: none"> <li>Use Adobe Reader or Adobe Acrobat Reader, which comes bundled with your operating system.</li> </ul>	236

## Viewing and Storing Images on a Macintosh

You can view and store images (snapshot and movie files) on your Macintosh by connecting to the camera.



### **IMPORTANT!**

- Connection is not supported to a Macintosh running Mac OS 8.6 or lower, or Mac OS X 10.0. Connection is supported to a Macintosh running Mac OS 9 or OS X (10.1, 10.2, 10.3, 10.4) only. Use the standard USB driver that comes with the operating system for connection.

### ■ **Connecting the Camera to Your Macintosh the First Time**

- 1. Make sure the camera's battery is fully charged.**
- 2. Turn on the camera, and then press [MENU].**
  - It makes no difference whether the camera is in the REC mode or the PLAY mode.

3. Select the “Set Up” tab, select “USB”, and then press [▶].
4. Use [▲] and [▼] to select “Mass Storage”, and then press [SET].
5. Turn off the camera, and connect the USB cable that comes bundled with the camera to the camera’s USB/AV connector and your computer’s USB port.

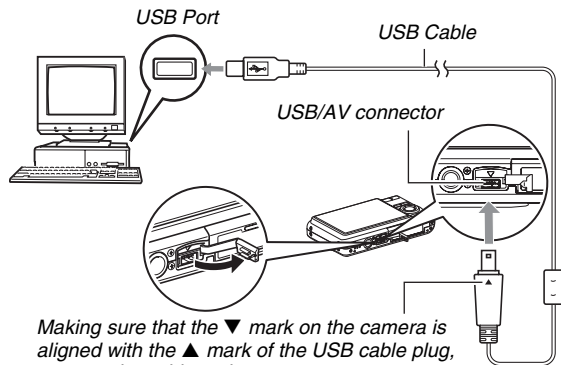

- When connecting the bundled USB cable to the camera’s USB/AV port, insert the plug into the port until you feel it click securely into place. Failure to insert the plug fully can result in poor communication or malfunction of the connected components.
- Some metal of the plug is visible even when the plug is inserted correctly.
- Take care when connecting the USB cable to the camera or your computer. USB ports and cable plugs are shaped for proper positioning.

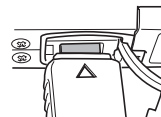

## 6. Turn on the camera.



## Camera-Macintosh Connection

Pressing the camera's [ON/OFF] button puts it into the USB mode, which is indicated by the camera's operation lamp lighting green. In this mode, your Macintosh recognizes the memory card loaded in the camera (or the camera's built-in memory if it does not have a memory card loaded) as a drive.

The appearance of the drive icon depends on the Mac OS version you are using.

From now on, you will not have to perform steps 3 through 5 in the above procedure when you connect the camera to your Macintosh (unless you change the camera's USB settings for some reason).

### **IMPORTANT!**

- Never disconnect the USB cable without exiting the USB mode first. Doing so can corrupt image data. See "Disconnect the camera from the Macintosh" on page 235 for the correct steps you need to perform to disconnect the camera from the Macintosh safely.

## ■ Connecting the Camera to Your Macintosh after the First Time

Since you need to configure menu settings only the first time you connect the camera to your Macintosh, later connections are much simpler.

- 1. Turn off the camera, and connect the USB cable that comes bundled with the camera to the camera and your Macintosh.**
- 2. Turn on the camera.**

Pressing the camera's [ON/OFF] button puts it into the USB mode, which is indicated by the camera's operation lamp lighting green.

## ■ Viewing Camera Images on Your Macintosh

After connecting the camera to your Macintosh, you can view camera images on your Macintosh screen.

- 1. Double-click the camera's drive icon.**
- 2. Double-click the "DCIM" folder.**
- 3. Double-click the folder that contains the image you want to view.**
- 4. Double-click the file that contains the image you want to view.**

This displays the image.



### **IMPORTANT!**

- Do not leave the same image displayed on your Macintosh screen for a long time. Doing so can cause image "burn in".

### **NOTE**

- An image that was rotated on the camera will be displayed on your Macintosh screen in its original (unrotated) orientation.

## ■ Saving an Image on Your Macintosh

In order to work on an image to put it into an album, you must first save it to your Macintosh. To save a camera image to your Macintosh, you must first establish a connection between them.

- 1. Double-click the camera's drive icon.**
- 2. Drop the "DCIM" folder into the folder where you want to store it.**

This copies the "DCIM" folder to the folder on your Macintosh.

## **IMPORTANT!**

- Never use your computer to modify, delete, move, or rename any image files that are in the camera's built-in memory or memory card. Doing so can cause problems with the camera's image management data, which will make it impossible to play back images on the camera and can drastically alter remaining memory capacity. Whenever you want to modify, delete, move, or rename an image, do so only on images that have been copied to your Macintosh.
- Never unplug the USB cable or operate the camera while viewing or storing images. Doing so can cause data to become corrupted.

## ■ **Disconnect the camera from the Macintosh**

- 1. On your Macintosh screen, drag the camera drive to Trash.**
- 2. Press the camera's [ON/OFF] button. After making sure that the camera's operation lamp is not lit, disconnect the camera from the Macintosh.**

## **Transfer of Images from the Camera and Management of Images on Your Macintosh**

If you are running Mac OS X, you can manage snapshots using iPhoto, which comes bundled with your operating system.

### **NOTE**

- If you are running Mac OS 9, use commercially available software.

## Playing Movies

You can use QuickTime, which comes bundled with your operating system, to play back movies. To play back a movie, first copy the movie to your Macintosh and then double-click the movie file.



### ■ Minimum Computer System Requirements for Movie Playback

The minimum system requirements described below are necessary to use your Macintosh to play back movies recorded with this camera.

OS : OS X 10.3.9 or greater

Required Software : QuickTime 7 or greater

### ★ IMPORTANT!

- The above is the recommended environment. Configuring this environment does not guarantee proper operation.
- Even if your computer meets the minimum requirements described above, certain settings and other installed software may interfere with proper playback of movies.
- Movie file playback is not supported under OS 9.

## Viewing User Documentation (PDF Files)

You must have Adobe Reader or Adobe Acrobat Reader installed on your computer in order to view the contents of a PDF file. If you don't, go to the Adobe Systems Incorporated website and install Acrobat Reader.

- 1. On the CD-ROM, open the “Manual” folder.**
- 2. Open the “Digital Camera” folder and then open the folder for the language whose user’s guide you want to view.**
- 3. Open the file named “camera\_xx.pdf”.**
  - “xx” is the language code (Example: camera\_e.pdf is for English.)

## Registering as a User

Internet registration only is supported. Visit the following CASIO website to register:

<http://world.casio.com/qv/register/>

## Reading Files Directly from a Memory Card

The method you should use to read files from a memory card depends on the type of computer you have. Some typical examples are shown below. After you connect, use the same procedures as those that you use when the camera is connected to your computer.

### ■ If your computer has a memory card slot

After checking to make sure that your computer's card slot is compatible with the memory card you are using to store images, insert the memory card into the slot.

### ■ If your computer has a PC card slot

Use a commercially available PC card adapter that is appropriate for the memory card. For full details, see the user documentation that comes with the PC card adapter and your computer.

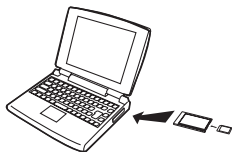

### ■ Other types of computers

Use either of the method described below.

- Use a commercially available memory card reader/writer that is appropriate for the memory card you are using. See the user documentation that comes with the memory card reader/writer for details about how to use it.
- Use a commercially available PC card reader/writer and a commercially available PC card adapter that is appropriate to the type of memory card you are using. See the user documentation that comes with the PC card reader/writer and PC card adapter for details about how to use them.

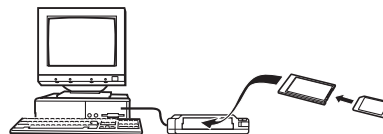
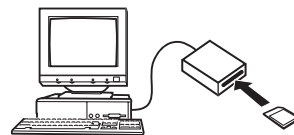

## Memory Card Data

The camera stores images you shoot and other data in accordance with the Design Rule for Camera File System (DCF).

### About DCF

DCF is a system that defines both image file formats and the structure of the folders that store data. This makes it possible for a digital camera, printer, or other DCF-compliant device to display or print image data from another DCF device.

### Memory Folder Structure

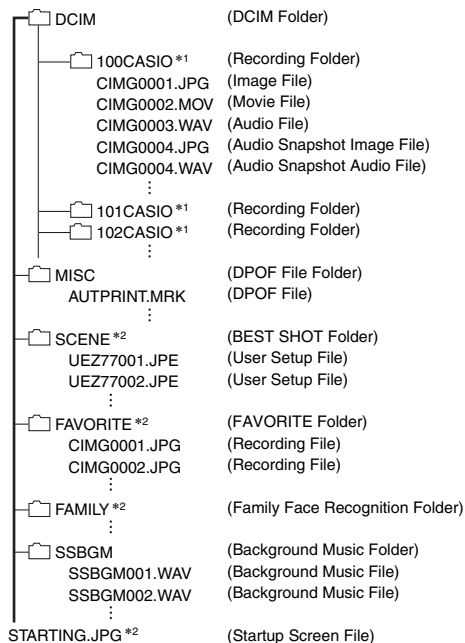

\*1 Other folders are created when the following BEST SHOT scenes are used for recording: "For eBay" or "Auction" (scene name depends on camera model), or "For YouTube".

The following shows the name of the folder created for each scene.

- eBay scene: 100\_EBAY
- Auction scene: 100\_AUCT
- YouTube scene: 100YOUTB

\*2 Indicates files that can be created in built-in memory only.

### Folder and File Contents

- DCIM Folder  
Folder that contains all of the camera files
- Recording Folder  
Folder that contains files recorded with the camera
- Image File  
File of an image shot with the camera. Extension is "JPG".
- Movie File  
File of a movie shot with the camera. Extension is "MOV".
- Audio File  
Audio recording file. Extension is "WAV".
- Audio Snapshot Image File  
Image file of an audio snapshot. Extension is "JPG".
- Audio Snapshot Audio File  
Audio recording file of an audio snapshot. Extension is "WAV".

- DPOF File Folder  
Folder that contains DPOF files, etc.
- BEST SHOT Folder  
Folder that contains BEST SHOT user setup files
- User Setup File  
File of a BEST SHOT user setup
- FAVORITE Folder  
Folder that contains Favorites image files. Size of images is 320 × 240 pixels.
- Family Face Recognition Folder  
Folder that contains face members recorded for family members. Any manipulation of the data in the "FAMILY" folder can cause the camera to stop operating properly. Never delete or edit any data in the "FAMILY" folder.
- Background Music Folder  
Folder created when you switch to your own choice of background music.
- Startup Screen File  
File for storing the startup screen image. This file is created when you specify an image for use as the startup screen image.

## ■ Supported Image Files

- Image files shot with this camera
- DCF-compliant image files

Even if an image is DCF-compliant, this camera still may not be able to display it. When displaying an image recorded on another camera, it may take a long time for the image to appear on this camera's monitor screen.

## ■ Built-in Memory and Memory Card Data Handling Precautions

- When saving camera data to a computer hard disk, MO disk, or other medium, be sure to transfer the entire DCIM folder and its contents. Changing the name of the DCIM to a date or something similar after you copy it to your computer is a good way to keep track of multiple DCIM folders. When moving the folder back to the camera, however, be sure to change its name back to DCIM. This camera does not recognize any folder name besides DCIM.

All of the other folders inside the DCIM folder must also have their original names if you transfer them back to the camera.

- Folders and files must be stored in accordance with the "Memory Folder Structure" shown on page 238 in order for the camera to be able to recognize them correctly.



# APPENDIX

## General Guide

The numbers in parentheses indicate the pages where each part is explained.

### ■ Camera

#### Front

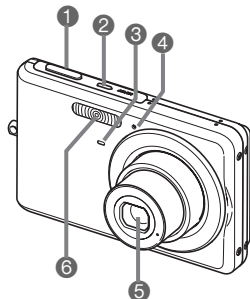

- 1 Shutter (page 60)
- 2 [ON/OFF] (Power) (page 43)
- 3 Self-timer Lamp (pages 58, 76, 250)
- 4 Microphone (pages 58, 81, 92)
- 5 Lens
- 6 Flash (page 71)

#### Back

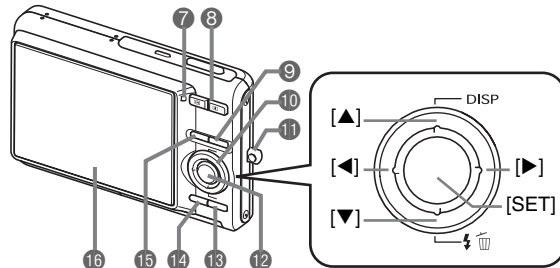

- 7 Operation Lamp (pages 43, 60, 250)
- 8 Zoom Button (pages 68, 156, 157)
- 9 [CAMERA] (REC) Button (pages 43, 199)
- 10 Control Button ([▲], [▼], [◀], [▶])
- 11 Strap Hole (page 2)
- 12 [SET] Button
- 13 [BS] Button (page 97)
- 14 [MENU] Button (page 50)
- 15 [▶] (PLAY) Button (pages 43, 199)
- 16 Monitor Screen (page 52)

## Bottom

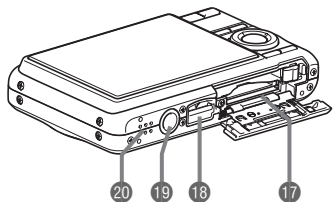

- 17 Battery/Memory Card Slots (pages 36, 47)
- 18 USB/AV Connector (pages 203, 216, 232)
- 19 Tripod Hole  
Use this hole when attaching to a tripod.
- 20 Speaker (page 145)

## ■ Battery Charger

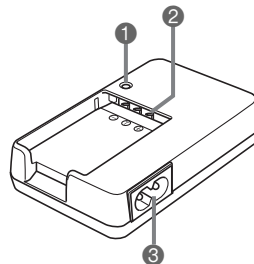

- 1 [CHARGE] lamp
- 2 Contacts
- 3 AC jack

## Monitor Screen Contents

The monitor screen uses various indicators, icons, and values to keep you informed of the camera's status.

- The sample screens in this section are intended to show you the locations of all the indicators and figures that can appear on the monitor screen in various modes. They do not represent screens that actually appear on the camera.

### ■ Snapshot Recording Mode

Panel : On

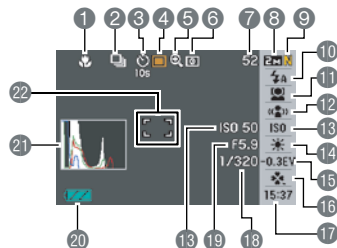

- 1 Focus Mode (page 115)
- 2 Continuous Shutter Mode (page 78)
- 3 Self-timer Mode (page 76)
- 4 Recording Mode
- 5 Digital zoom indicator (page 69)
- 6 Metering Mode (page 130)
- 7 Remaining Snapshot Memory Capacity (page 259)
- 8 Snapshot Image Size (page 62)

Panel : Off

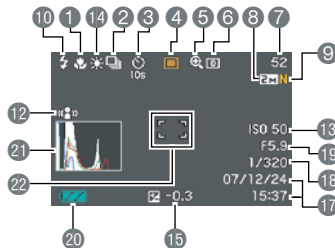

- 9 Snapshot Image Quality (page 64)
- 10 Flash Mode (page 71)
- 11 Face Recognition Setting (page 82)
- 12 Anti Shake Indicator (page 102)
- 13 ISO Sensitivity (page 129)
- 14 White Balance Setting (page 126)
- 15 Exposure Compensation (page 125)
- 16 easy Mode (page 65)
- 17 Date/Time (page 193)

easy Mode

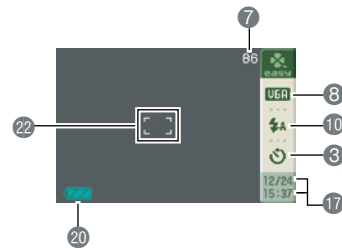

- 18 Shutter Speed (page 61)
- 19 Aperture Value (page 61)
- 20 Battery Level Indicator (page 40)
- 21 Histogram (page 136)
- 22 Focus Frame (pages 59, 120)

## IMPORTANT!

- The aperture value, shutter speed, and ISO sensitivity will all turn orange if any one of them is not correct when the shutter button is half-pressed.

## ■ Movie Recording Mode

### Panel : On

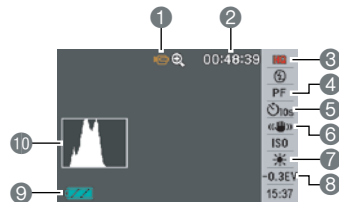

### Panel : Off

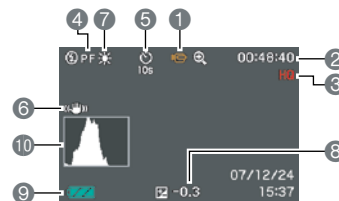

- 1 Recording Mode
- 2 Remaining Movie Memory Capacity (page 91)
- 3 Movie Image Quality (page 90)
- 4 Focus Mode (page 115)
- 5 Self-timer Mode (page 76)
- 6 Anti Shake Indicator (page 102)
- 7 White Balance Setting (page 126)
- 8 Exposure Compensation (page 125)
- 9 Battery Level Indicator (page 40)
- 10 Histogram (page 136)

## ■ Snapshot Playback Mode

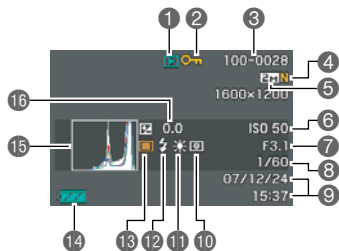

- 1 File Type (page 144)
- 2 Protect Indicator (page 181)
- 3 Folder Name/File Name (page 180)
- 4 Snapshot Image Quality (page 64)
- 5 Snapshot Image Size (page 62)
- 6 ISO Sensitivity (page 129)
- 7 Aperture Value (page 61)
- 8 Shutter Speed (page 61)
- 9 Date/Time (page 193)
- 10 Metering Mode (page 130)
- 11 White Balance Setting (page 126)
- 12 Flash Mode (page 71)
- 13 Recording Mode
- 14 Battery Level Indicator (page 40)
- 15 Histogram (page 136)
- 16 Exposure Compensation (page 125)

## ■ Movie Playback Mode

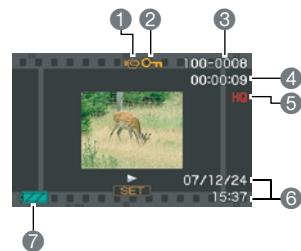

- 1 File Type (page 146)
- 2 Protect Indicator (page 181)
- 3 Folder Name/File Name (page 180)
- 4 Movie Recording Time (page 146)
- 5 Movie Image Quality (page 90)
- 6 Date/Time (page 193)
- 7 Battery Level Indicator (page 40)





## Menu Reference

The tables in this section show the items that appears on the menus that appear on the monitor screen when you press [MENU]. The items included on the menus depend on whether the camera is in the REC mode or PLAY mode.

- An asterisk (\*) indicates reset default settings.









### ■ REC Mode

#### REC Tab Menu

<b>Focus</b>	<b>AF</b> (Auto Focus)* /  Macro / <b>PF</b> (Pan Focus) /  (Infinity) / <b>MF</b> (Manual Focus) <ul style="list-style-type: none"> <li>• <b>AF</b> (Auto Focus) indicator is not displayed during movie recording.</li> </ul>
<b>Continuous</b>	Normal Speed / High Speed / Flash Cont. / Off*
<b>Self-timer</b>	10 sec / 2 sec / X3 / Off*
<b>Face Recognition</b>	Family First / Normal / Off* / Priority / Record Family / Edit Family
<b>Anti Shake</b>	Auto / Off*
<b>AF Area</b>	 Spot* /  Multi /  Tracking
<b>easy Mode</b>	On / Off*
<b>L/R Key</b>	Metering / EV Shift / White Balance / ISO / Self-timer / Off*





<b>Quick Shutter</b>	On* / Off
<b>Audio Snap</b>	On / Off*
<b>Grid</b>	On / Off*
<b>Digital Zoom</b>	On* / Off
<b>Review</b>	On* / Off
<b>Icon Help</b>	On* / Off
<b>Memory</b>	<b>[BS]</b> BEST SHOT: On / Off* Flash: On* / Off Focus: On / Off* White Balance: On / Off* ISO: On / Off* AF Area: On* / Off Metering: On / Off* Self-timer: On / Off* Flash Intensity: On / Off* Digital Zoom: On* / Off MF Position: On / Off* Zoom Position: On / Off*

## Quality Tab Menu

<b>Size</b>	7M (3072 × 2304)* / 3:2 (3072 × 2048) / 16:9 (3072 × 1728) / 5M (2560 × 1920) / 3M (2048 × 1536) / 2M (1600 × 1200) / VGA (640 × 480)
<b>Quality (Snapshots)</b>	Fine / Normal* / Economy
<b>Quality (Movies)</b>	UHQ / UHQ Wide / HQ* / HQ Wide / Normal / LP
<b>EV Shift</b>	-2.0 / -1.7 / -1.3 / -1.0 / -0.7 / -0.3 / 0.0* / +0.3 / +0.7 / +1.0 / +1.3 / +1.7 / +2.0
<b>White Balance</b>	Auto* /  (Daylight) /  (Overcast) /  (Shade) /  (Day White Fluorescent) /  D (Daylight Fluorescent) /  (Tungsten) / Manual
<b>ISO</b>	Auto* / ISO 50 / ISO 100 / ISO 200 / ISO 400 / ISO 800
<b>Metering</b>	 Multi* /  Center weighted /  Spot
<b>Dynamic Range</b>	Expand +2 / Expand +1 / Off*
<b>Portrait Refiner</b>	Noise Filter +2 / Noise Filter +1 / Off*
<b>Color Filter</b>	Off* / B/W / Sepia / Red / Green / Blue / Yellow / Pink / Purple

<b>Sharpness</b>	+2 / +1 / 0* / -1 / -2
<b>Saturation</b>	+2 / +1 / 0* / -1 / -2
<b>Contrast</b>	+2 / +1 / 0* / -1 / -2
<b>Flash Intensity</b>	+2 / +1 / 0* / -1 / -2
<b>Flash Assist</b>	Auto* / Off

## Set Up Tab Menu











 <b>Panel</b>	On* / Off
 <b>Display</b>	Wide* / 4:3
<b>Sounds</b>	Startup* / Half Shutter / Shutter / Operation /  Operation /  Play
<b>Startup</b>	On (Selectable image) / Off*
<b>File No.</b>	Continue* / Reset
<b>World Time</b>	Home* / World
	Home Time setup (city, DST, etc.)
	World Time setup (city, DST, etc.)
<b>Timestamp</b>	Date / Date&Time / Off*
<b>Adjust</b>	Time setting
<b>Date Style</b>	YY/MM/DD / DD/MM/YY / MM/DD/YY
<b>Language</b>	Changes the screen text language. <ul style="list-style-type: none"> <li>The number and types of languages depend on the geographic area where the camera was marketed.</li> </ul>
<b>Sleep</b>	30 sec / 1 min* / 2 min / Off
<b>Auto Power Off</b>	1 min* / 2 min / 5 min
<b>REC / PLAY</b>	Power On* / Power On/Off / Disable

<b>USB</b>	Mass Storage (USB DIRECT-PRINT)* / PTP (PictBridge)
<b>Video Out</b>	NTSC 4:3 / NTSC 16:9 / PAL 4:3 / PAL 16:9
<b>Format</b>	Format / Cancel*
<b>Reset</b>	Reset / Cancel*



## ■ PLAY Mode

### PLAY Tab Menu

<b>Slideshow</b>	Start* / Images / Time / Interval / Effect / Cancel
<b>Calendar</b>	–
<b>Layout Print</b>	–
<b>MOTION PRINT</b>	9 frames* / 1 frame / Cancel
 <b>Anti Shake</b>	On / Off*
<b>Movie Editing</b>	 Cut (Before) /  Cut (Between) /  Cut (After) / Cancel*
<b>Dynamic Range</b>	Expand +2 / Expand +1 / Cancel*
<b>White Balance</b>	 (Daylight) /  (Overcast) /  (Shade) /  (Day White Fluorescent) /  (Daylight Fluorescent) /  (Tungsten) / Cancel*
<b>Brightness</b>	+2 / +1 / 0* / -1 / -2
<b>Keystone</b>	–
<b>Color Correction</b>	–
<b>Favorites</b>	Show* / Save / Cancel
<b>DPOF Printing</b>	Select images* / All images / Cancel
<b>Protect</b>	On* / All Files : On / Cancel

<b>Date/Time</b>	–
<b>Rotation</b>	Rotate* / Cancel
<b>Resize</b>	5M (2560 × 1920)* / 3M (2048 × 1536) / VGA (640 × 480) / Cancel
<b>Trimming</b>	–
<b>Dubbing</b>	–
<b>Copy</b>	Built-in → Card* / Card → Built-in / Cancel

### “Set Up” Tab

- The contents of the “Set Up” tab are the same in the REC mode and PLAY mode.

## Indicator Lamps

The camera has lamps: an Operation Lamp and an Self-timer Lamp. These Lamps light and flash to indicate the current operational status of the camera.

Operation Lamp

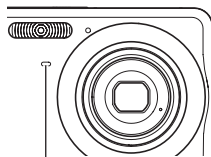
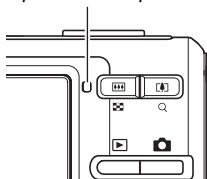

Self-timer Lamp

## REC Mode

Operation Lamp		Meaning
Color	Status	
Green	Lit	Operational (Power on). / Auto Focus operation was successful. / LCD is off or in sleep state.
	Flashing	Storing movie or processing image. / Image is being stored. / Cannot Auto Focus. / Card is being formatted. / Powering down.
Red	Lit	Memory card is locked. / Cannot create folder. / Memory is full. / Write error.
	Flashing	Memory card problem. / Memory card is unformatted. / BEST SHOT setup cannot be registered. / Low battery alert.
Amber	Flashing	Flash is charging.

Self-timer Lamp		Meaning
Color	Status	
Red	Flashing	Self-timer countdown.

## IMPORTANT!

- Never remove the memory card from the camera while the operation lamp is flashing green. Doing so will cause the image you shot to be lost.

## PLAY mode

Operation Lamp		Meaning
Color	Status	
Green	Lit	Operational (Power on).
	Flashing	One of the following operations is in progress: Delete, DPOF, protect, copy, format, resize, trimming, adding audio to snapshot, keystone correction, color correction, MOTION PRINT, Layout Print, movie editing, power down.
Red	Lit	Memory card is locked. / Cannot create folder. / Memory is full. / Write error.
	Flashing	Memory card problem. / Memory card is unformatted. / Low battery alert.

## Battery Charger Lamp Reference

The battery charger has a [CHARGE] lamp that lights or flashes in accordance with the battery charger operation that is being performed.

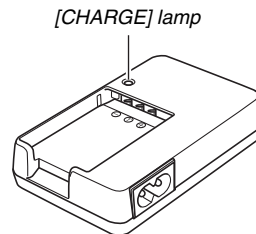





[CHARGE] lamp	Meaning
Lit Red	Charging
Flashing Red	Battery charger or battery abnormality
Off	Charging complete or charge standby state (Ambient temperature is too high or too low.)

## Troubleshooting Guide

### Finding the Problem and Fixing It

Problem	Possible Causes and Action
<b>Power Supply</b>	
Power does not turn on.	<ol style="list-style-type: none"><li>1) The battery may not be oriented correctly (page 38).</li><li>2) The battery may be dead. Charge the battery (page 36). If the battery goes dead soon after being charged, it means the battery has reached the end of its life and needs to be replaced. Purchase a separately available CASIO NP-20 rechargeable lithium ion battery.</li></ol>
Camera suddenly powers down.	<ol style="list-style-type: none"><li>1) Auto Power Off may have activated (page 44). Turn power back on.</li><li>2) The battery may be dead. Charge the battery (page 36).</li><li>3) The camera's protection function may have activated because camera temperature is too high. Turn off the camera and wait until it cools down before trying to use it again.</li></ol>
Power does not turn off. Nothing happens when a button is pressed.	Remove the battery from the camera and then reinsert it.
<b>Image Recording</b>	
Image is not recorded when the shutter button is pressed.	<ol style="list-style-type: none"><li>1) If the camera is in the PLAY mode, press [  ] (REC) to enter the REC mode.</li><li>2) If the flash is charging, wait until the charge operation finishes.</li><li>3) If the message "Memory Full" appears, transfer images to your computer, delete images you no longer need, or use a different memory card.</li></ol>
Auto Focus does not focus properly.	<ol style="list-style-type: none"><li>1) If the lens is dirty, clean it off.</li><li>2) The subject may not be in the center of the focus frame when you compose the image.</li><li>3) The subject you are shooting may not be a type that is not compatible with Auto Focus (page 67). Use manual focus (page 123).</li><li>4) You may be moving the camera when shooting. Try shooting with Anti Shake (page 102) or use a tripod.</li><li>5) You may be using Quick Shutter and pressing the shutter button all the way, resulting in poor focus. Half-press the shutter button and allow enough time for Auto Focus to focus.</li></ol>

Problem	Possible Causes and Action
The subject is out of focus in the recorded image.	The image may not be focused properly. When composing the image, make sure the subject is located inside the focus frame.
The flash does not fire.	<ol style="list-style-type: none"> <li>1) If “” (Flash Off) is selected as the flash mode, change to another mode (page 71).</li> <li>2) If the battery is dead, charge it (page 36).</li> <li>3) If a BEST SHOT scene that uses the “” (Flash Off) flash mode is selected, change to a different flash mode (page 71) or select a different BEST SHOT scene (page 97).</li> </ol>
Camera powers down during self-timer countdown.	The battery may be dead. Charge the battery (page 36).
The monitor screen image is out of focus.	<ol style="list-style-type: none"> <li>1) You may be using Manual Focus and have not focused the image. Focus the image (page 123).</li> <li>2) You may be using the macro mode  for scenery or portraits. Use Auto Focus for scenery and portrait shots (page 116).</li> <li>3) You may be trying to use Auto Focus or the Infinity mode  when shooting a close-up shot. Use the Macro mode for close ups (page 117).</li> </ol>
There is a vertical line on the monitor screen.	Shooting a very brightly lit subject can cause a vertical band to appear in the monitor screen image. This is a CCD phenomenon known as “vertical smear”, and does not indicate malfunction of the camera. Note that vertical smear is not recorded with the image in the case of a snapshot, but it is recorded in the case of a movie.
There is digital noise in images.	<ol style="list-style-type: none"> <li>1) Sensitivity may have been increased automatically for a dark subject, which increases the chance of digital noise. Use a light or some other means to illuminate the subject.</li> <li>2) You may be attempting to shoot in a dark location while “” (Flash Off) is selected as the flash mode, which can increase digital noise and make images appear coarse. In this case, change to a different flash mode (page 71) or use lights for illumination.</li> <li>3) Flash assist may be enabled for snapshots, which can cause an increase in digital noise. Use a light or some other means to illuminate the subject.</li> </ol>

Problem	Possible Causes and Action
An image I shot was not saved.	1) Camera power may have been turned off before the save operation was complete, which will result in the image not being saved. When the battery indicator shows "🔋", charge the battery as soon as possible (page 36). 2) You may have removed the memory card from the camera before the save operation was complete, which will result in the image not being saved. Do not remove the memory card before the save operation is complete.
Though available lighting is bright, the faces of people in the image are dark.	Not enough light is reaching the subjects. Change the flash mode setting to "🔦" (Flash On) for daylight synchro flash (page 71), or use adjust EV shift to the + side (page 125).
Subjects are too bright when shooting images in a seashore or ski area.	Sunlight reflected by water, sand, or snow, can cause underexposure of images. Change the flash mode setting to "🔦" (Flash On) for daylight synchro flash (page 71), or use adjust EV shift to the + side (page 125).
Digital zoom does not work. The zoom bar indicates zoom only up to a zoom factor of 3.0.	1) The digital zoom setting may be turned off. Turn on digital zoom (page 71). 2) Time stamping may be turned on, which will cause digital zoom to be disabled. Turn off time stamping (page 135).
Recognition of a family member's face is not recognized correctly, even though the face has been recorded.	Though face characteristics were recorded for your family member, the data may have been faulty, or the angle to the face or its expression may be making recognition difficult. Re-record the face of the family member who is not being recognized (page 84).
The image is out of focus during movie recording.	1) Focusing is not possible because the subject is outside the focus range. Shoot within the allowable range. 2) The lens may be dirty. Clean the lens (page 34).

Problem	Possible Causes and Action
<b>Playback</b>	
The color of the playback image is different from what appears on the monitor screen when shooting.	Sunlight or light from another source may be shining directly into the lens when you are shooting. Position the camera so sunlight does not shine directly into the lens.
Images are not displayed.	This camera cannot display non-DCF images recorded onto a memory card using another digital camera.
I can't edit images (resizing, trimming, keystone correction, color restoration, rotation, date/time editing).	<p>Note that you cannot edit the following types of images.</p> <ul style="list-style-type: none"> <li>• Images created with MOTION PRINT</li> <li>• Movies</li> <li>• Images recorded with another camera</li> </ul>
<b>Other</b>	
The wrong date and time are displayed.	The date and time setting is wrong. Set the correct date and time (page 193).
The messages on the display are in the wrong language.	The wrong display language is selected. Change the display language setting (page 197).
I can't transfer images over a USB connection.	<ol style="list-style-type: none"> <li>1) The USB cable may not be connected securely. Check all connections.</li> <li>2) If your computer is running Windows 98SE or 98, the USB driver may not be installed. Install the USB driver (page 215), which you can download from the official EXILIM Website at <a href="http://www.exilim.com/">http://www.exilim.com/</a></li> <li>3) If your computer is running Windows 98SE or 98, the USB driver may be installed incorrectly. Reinstall the USB driver correctly (page 215).</li> <li>4) The wrong USB communication protocol may be selected. Select the correct USB communication protocol in accordance with the type of device you are connecting (page 198).</li> <li>5) If the camera is not turned on, turn it on.</li> </ol>

Problem	Possible Causes and Action
<p>Display language setting screen appears when the camera is turned on.</p>	<p>1) You did not configure initial settings after purchasing the camera or the battery may have been left with a dead battery. Check the camera setup (pages 11, 193).</p> <p>2) There may be a problem with the camera's built-in memory management area. If this is the case, perform the reset operation to initialize the camera's setup (page 143). After that, configure each setting. If the language selection screen does not re-appear when you turn the camera on, it means that the camera's built-in memory management area has been restored.</p> <p>If the same message appears after you turn power back on, contact your retailer or a CASIO service center.</p>



## Display Messages

<b>ALERT</b>	<p>The camera's protection function may have activated because camera temperature is too high. Turn off the camera and wait until it cools down before trying to use it again.</p> <ul style="list-style-type: none"> <li>Any of the following may occur after the "ALERT" message appears.             <ol style="list-style-type: none"> <li>Power turns off.</li> <li>Movie recording is impossible or movie length is limited.</li> </ol> </li> </ul>
<b>Battery is low.</b>	Battery power is low.
<b>Cannot correct image!</b>	Keystone correction of the image cannot be performed for some reason. The image will be stored as-is, without correction (page 106).
<b>Cannot find the file.</b>	The image you specified with the slideshow "Images" setting cannot be found. Change the "Images" setting (page 149) and try again.
<b>Cannot register any more files.</b>	<ul style="list-style-type: none"> <li>You are attempting to save a BEST SHOT scene when there are already 999 scenes in the "SCENE" folder (page 101).</li> <li>You are attempting to copy a FAVORITE file when the "FAVORITE" folder already contains 9999 files (page 183).</li> </ul>

<b>Card ERROR</b>	<p>There is something wrong with the memory card. Turn off the camera, remove the memory card, and then reload it into the camera. If this message re-appears when you turn the camera back on, format the memory card (page 49).</p> <p> <b>IMPORTANT!</b></p> <ul style="list-style-type: none"> <li>Formatting the memory card deletes all its files. Before formatting, try transferring recoverable files to a computer or some other storage device.</li> </ul>
<b>Check connections!</b>	<ul style="list-style-type: none"> <li>You are attempting to connect the camera to a printer while the camera's USB settings are not compatible with the USB system of the printer (page 202).</li> <li>If your computer is running Windows 98SE or 98, the USB driver may not be installed (page 215).</li> </ul>
<b>Files could not be saved because battery is low.</b>	Battery power is low, so an image file could not be saved.
<b>Folder cannot be created.</b>	You are trying to record a file while there are already 9,999 files stored in the 999th folder. If you want to record more, delete files you no longer need (page 187).
<b>LENS ERROR</b>	This message appears and the camera turns off whenever lens performs some unexpected operation. If the same message appears after you turn power back on, contact your retailer or a CASIO service center.

<b>Load paper!</b>	The printer ran out of paper while printing.
<b>Memory Full</b>	Memory is full with images you recorded and/or of files saved by editing operations. Delete files you no longer need (page 187).
<b>No Favorites file!</b>	The FAVORITE folder does not contain any files.
<b>Printing Error</b>	An error occurred while printing. <ul style="list-style-type: none"> <li>• The printer is turned off.</li> <li>• The printer generated an error, etc.</li> </ul>
<b>Record Error</b>	Image compression could not be performed for some reason during image data storage. Shoot the image again.
<b>Replenish ink!</b>	During printing, the printer is running low on ink or is out of ink.
<b>RETRY POWER ON</b>	If the lens comes into contact with some obstacle, this message appears and the camera turns off. Take action to remove the obstacle, and try turning on power again.
<b>SYSTEM ERROR</b>	Your camera system is corrupted. Contact your retailer or an authorized CASIO service center.
<b>The card is locked.</b>	The LOCK switch of the SD memory card or SDHC memory card loaded in the camera is in the locked position. You cannot store images to or delete images from a memory card that is locked.
<b>There are no files.</b>	There are no files in built-in memory or on the memory card.

<b>There are no printing images. Set up DPOF.</b>	There are currently no files specified for printing. Configure the required DPOF settings (page 206).
<b>There is no image to register.</b>	The setup you are trying to save is for an image that cannot be saved as a user BEST SHOT scene.
<b>This card is not formatted.</b>	The memory card loaded in the camera is not formatted. Format the memory card (page 49).
<b>This file cannot be played.</b>	The file you are trying to access is corrupted or is a type that cannot be displayed by this camera.
<b>This function cannot be used.</b>	You attempted to copy images from built-in memory to a memory card while there is no memory card loaded in the camera (page 185).
<b>This function is not supported for this file.</b>	The function you are trying to use cannot be performed for some reason.

## Specifications

### ■ Main Specifications

**Product Type** Digital Camera

**Model** EX-Z77

### ■ Camera Functions

**Image Files Format** Snapshots:  
JPEG (Exif Version 2.2); DCF (Design Rule for Camera File System) 1.0 standard; DPOF compliant  
Movies: H.264/AVC MOV format  
Audio: WAV

**Recording Media** Built-in Memory 11.4 MB  
SDHC Memory Card  
SD Memory Card  
MMC (MultiMediaCard)  
MMC*plus* (MultiMediaCard*plus*)

### Storage Capacity

- Snapshots

Image Size (Pixels)	Image Quality	Approximate Image File Size	Approximate Built-in Memory (11.4 MB) Capacity	Approximate SD Memory Card (1 GB) Capacity
7M (3072 × 2304)	Fine	4.3 MB	2 images	224 images
	Normal	2.31 MB	4 images	418 images
	Economy	1.57 MB	7 images	616 images
3:2 (3072 × 2048)	Fine	3.73 MB	3 images	259 images
	Normal	2.02 MB	5 images	478 images
	Economy	1.38 MB	8 images	700 images
16:9 (3072 × 1728)	Fine	3.02 MB	3 images	320 images
	Normal	1.66 MB	6 images	582 images
	Economy	1.14 MB	10 images	848 images
5M (2560 × 1920)	Fine	2.99 MB	3 images	323 images
	Normal	1.62 MB	7 images	597 images
	Economy	1.12 MB	10 images	863 images
3M (2048 × 1536)	Fine	2.0 MB	5 images	483 images
	Normal	1.15 MB	10 images	841 images
	Economy	720 KB	16 images	1343 images

Image Size (Pixels)	Image Quality	Approximate Image File Size	Approximate Built-in Memory (11.4 MB) Capacity	Approximate SD Memory Card (1 GB) Capacity
2M (1600 × 1200)	Fine	1.26 MB	9 images	767 images
	Normal	790 KB	14 images	1224 images
	Economy	470 KB	24 images	2057 images
VGA (640 × 480)	Fine	330 KB	34 images	2930 images
	Normal	190 KB	60 images	5090 images
	Economy	140 KB	82 images	6908 images

- Movies

Image Quality (Pixels)	Approximate Data Rate (Frame Rate)	Approximate Recording Time for Built-in Memory 11.4 MB	Approximate Recording Time for SD Memory Card 1 GB
UHQ 640 × 480	5.8 Megabits/second (30 frames/second)	16 seconds	22 minutes, 50 seconds
UHQ Wide 848 × 480	7.0 Megabits/second (30 frames/second)	13 seconds	18 minutes, 55 seconds
HQ 640 × 480	2.8 Megabits/second (30 frames/second)	33 seconds	47 minutes, 30 seconds
HQ Wide 848 × 480	3.4 Megabits/second (30 frames/second)	27 seconds	39 minutes, 4 seconds
Normal 640 × 480	1.4 Megabits/second (30 frames/second)	67 seconds	94 minutes, 54 seconds
LP 320 × 240	545 Kilobits/second (15 frames/second)	172 seconds	241 minutes, 8 seconds

- \* The number of image values is approximate and are provided for reference only. The actual number of images you may be able to record may be less than that indicated on the monitor screen.
- \* Image files sizes are approximate and are provided for reference only. Actual image file sizes vary depending on subject type.
- \* The above values are based on use of a Matsushita Electric Industrial Co., Ltd. PRO HIGH SPEED SD memory card. The number of images you can save depends on the type of memory card you are using.
- \* To determine the number of images that can be stored on a memory card of a different capacity, multiply the capacities in the table by the appropriate value.
- \* Each movie can be up to 10 minutes long. Movie recording stops automatically after 10 minutes of recording.

<b>Delete</b>	Single-file, all files (with protection)
<b>Effective Pixels</b>	7.2 million
<b>Imaging Element</b>	1/2.5-inch square pixel color CCD (Total pixels: 7.38 million)
<b>Lens/Focal Distance</b>	Lenses: F3.1 (W) to 5.9 (T); f=6.3 (W) to 18.9mm (T) (equivalent to approximately 38 (W) to 114mm (T) for 35mm film) 6 lenses in 5 groups, with aspherical lans

<b>Zoom</b>	3X optical zoom; 4X digital zoom (Image Size: 7M (3072 × 2304 pixels)) (12X in combination with optical zoom)
<b>Focusing</b>	Contrast Detection Auto Focus Focus Modes: Auto Focus, Macro mode, Pan Focus, Infinity mode, manual focus AF Area: Spot, Multi, or Tracking
<b>Approximate Focus Range (from lens surface)</b>	Auto Focus: 40 cm to ∞ (1.3' to ∞) Macro: 10 cm to 50 cm (3.9" to 19.7") Infinity: ∞ Manual: 10 cm to ∞ (3.9" to ∞) • Using optical zoom causes the above ranges to change.
<b>Exposure Control</b>	Light Metering: Multi-pattern, center-weighted, spot by CCD Exposure: Program AE Exposure Compensation: -2EV to +2EV (in 1/3EV steps)
<b>Shutter</b>	CCD electronic shutter; mechanical shutter Snapshot mode (Auto): 1/2 to 1/2000 second • Shutter speed is different for the following BEST SHOT scenes. Night Scene: 4 to 1/2000 second
<b>Aperture</b>	F3.1/4.4 auto switching • Using optical zoom causes the aperture to change.
<b>White Balance</b>	Auto WB, fixed (6 modes), manual switching

<b>Sensitivity</b>	Snapshots: Auto, ISO 50, ISO 100, ISO 200, ISO 400, ISO 800 <ul style="list-style-type: none"> <li>• Snapshots (When “Anti Shake” setting is “Auto”): ISO 800 (maximum)</li> <li>• Snapshots (When BEST SHOT scene is “Anti Shake”): ISO 800 (maximum)</li> <li>• Snapshots (When BEST SHOT scene is “High Sensitivity”): ISO 1600 (maximum)</li> </ul> Movies: Auto
<b>Self-timer</b>	10 seconds, 2 seconds, Triple Selftimer
<b>Built-in Flash</b>	Flash Modes: Auto Flash, ON, OFF, Red eye reduction, Soft Flash Flash Range: Wide Angle Optical Zoom: 0.1 to 3.5 meters (0.3' to 11.5') Telephoto Optical Zoom: 0.6 to 1.9 meters (2.0' to 6.2') <ul style="list-style-type: none"> <li>• Flash Continuous Shutter</li> </ul> Wide Angle Optical Zoom: 0.4 to 1.7 meters (1.3' to 5.6') Telephoto Optical Zoom: 0.6 to 0.9 meters (2.0' to 3.0') * ISO Sensitivity: “Auto” * Depends on zoom factor.

<b>Recording Functions</b>	Snapshot; audio snapshot; macro; self-timer; Continuous shutter; BEST SHOT mode; Face recognition; movie with audio (Movie, Short Movie, Past Movie, YouTube); Voice Recording <ul style="list-style-type: none"> <li>• Audio recording is monaural.</li> </ul>
<b>Audio Recording Time</b>	Audio Snapshot: Approximately 30 seconds maximum per image Voice Recording: Approximately 35 minutes with built-in memory After Recording: Approximately 30 seconds maximum per image
<b>Monitor Screen</b>	2.6-inch Wide TFT color LCD 114,960 pixels (479 × 240 pixels)
<b>Viewfinder</b>	Monitor Screen
<b>Timekeeping Functions</b>	Built-in quartz digital clock Date and Time: Recorded with image data, Time stamp Auto Calendar: To 2049 World Time: City; Date; Time; Summer time; 162 cities in 32 time zones
<b>Input/Output Terminals</b>	USB/AV connector
<b>USB</b>	USB 2.0 (Full-Speed) compatible
<b>Microphone</b>	Monaural
<b>Speaker</b>	Monaural

## ■ Power Requirements

---

<b>Power Requirements</b>	Rechargeable Lithium Ion Battery (NP-20) × 1
---------------------------	--

---

### Approximate Battery Life:

The values below indicate the amount of time under the conditions defined below, until power automatically turns off due to battery failure. They do not guarantee that you will be able to achieve this level of operation. Low temperatures shorten battery life.

Operation	Approximate Battery Life
Number of Shots (CIPA Standard)*1	190 shots
Continuous Snapshot Playback*2	190 minutes
Continuous Movie Recording	75 minutes
Continuous Voice Recording*3	190 minutes

Supported Battery: NP-20 (Rated Capacitance: 700mAh)

Storage Medium: SD Memory Card 1GB (The above values are based on use of a Matsushita Electric Industrial Co., Ltd. PRO HIGH SPEED SD memory card.)

#### \*1 Number of Shots (CIPA Standard)

- Temperature: 23°C (73°F)
- Monitor Screen: On
- Zoom operation between full wide to full telephoto every 30 seconds, during which two images are recorded, one image with flash; power turned off and back on every time 10 images are recorded.

#### \*2 Continuous Snapshot Playback Conditions

- Temperature: 23°C (73°F)
- Scroll one image about every 10 seconds

#### \*3 Voice recording times are based on continuous recording.

- The above values are based a new battery, starting from a full charge. Repeated charging shortens battery life.
  - Frequency of flash, zoom, and Auto Focus usage, and the time the camera is on greatly affects recording time and number of shots values.
-

<b>Power Consumption</b>	3.7 V DC Approximately 4.0 W
<b>Dimensions</b>	95 (W) × 59 (H) × 19.8 (D) mm (3.7"(W) × 2.3"(H) × 0.78"(D)) (excluding projections; 16.2 mm (0.64") at thinnest point)
<b>Weight</b>	Approximately 118 g (4.2 oz) (excluding battery and accessories)
<b>Bundled Accessories</b>	Rechargeable lithium ion battery (NP-20); Battery charger (BC-11L); AC power cord; USB cable; AV Cable; Strap; CD-ROM; Basic Reference

## ■ Rechargeable Lithium Ion Battery (NP-20)

<b>Rated Voltage</b>	3.7 V
<b>Rated Capacitance</b>	700 mAh
<b>Operating Temperature</b>	0 to 40°C (32 to 104°F)
<b>Dimensions</b>	33.0 (W) × 50.0 (H) × 4.7 (D) mm (1.3"(W) × 2.0"(H) × 0.19"(D))
<b>Weight</b>	Approximately 16 g (0.56 oz)

## ■ Battery Charger (BC-11L)

<b>Power Requirement</b>	100 to 240V AC, 80mA, 50/60Hz
<b>Output</b>	4.2V DC, 600 mA
<b>Charging Temperature</b>	5°C to 35°C (41°F to 95°F)
<b>Chargeable Battery type</b>	Rechargeable lithium ion battery (NP-20)
<b>Full Charge Times</b>	Approximately 90 minutes
<b>Dimensions</b>	55 (W) × 20 (H) × 86 (D) mm (2.2"(W) × 0.79"(H) × 3.4"(D)) (excluding projections)
<b>Weight</b>	Approximately 58 g (2.0 oz)

- Power cord precautions for use in Singapore  
The power cord set is not supplied. The power cord used must comply with relevant national and/or international standards.



# **CASIO®**

**CASIO COMPUTER CO.,LTD.**  
6-2, Hon-machi 1-chome  
Shibuya-ku, Tokyo 151-8543, Japan

M10

MA0709-B

## Free Manuals Download Website

<http://myh66.com>

<http://usermanuals.us>

<http://www.somanuals.com>

<http://www.4manuals.cc>

<http://www.manual-lib.com>

<http://www.404manual.com>

<http://www.luxmanual.com>

<http://aubethermostatmanual.com>

Golf course search by state

<http://golfingnear.com>

Email search by domain

<http://emailbydomain.com>

Auto manuals search

<http://auto.somanuals.com>

TV manuals search

<http://tv.somanuals.com>