

KL-100E

User's Guide



CASIO®

Important Safety Precautions

Note of the following safety precautions before using the label printer for the first time. Keep these safety precautions and operating instructions on hand for future reference.

About safety precaution symbols

The following symbols are used in this manual and on the product itself to alert you and others to the risk of personal and material injury.



Warning

This symbol indicates an item that can result in death or serious personal injury if ignored.



Caution

This symbol indicates an item that can result in serious personal injury or material damage if ignored.

Examples



A triangle indicates something you should be careful about. This symbol warns against electrical shock.



A circle indicates something you should not do. This symbol indicates you should not try to take something apart.



A black circle indicates something you must do. This symbol indicates you should unplug something.



Warning

Power supply and voltage



- Use only a power source whose output matches the rating marked on the plate on the bottom of the label printer. Also, avoid plugging too many appliances into the same extension cord. The wrong voltage or overloading of an AC outlet creates the danger of fire and electrical shock.

Serious malfunction



- Continued use of the unit when smoke or a strange odor is coming from it creates the danger of electrical shock. Immediately turn power off and unplug the power cord from the wall outlet. Request servicing from your original dealer.

AC adaptor



- Do not allow the power cord to become damaged or broken, and never modify, over bend, twist, or pull it. Never place heavy objects on the power cord, and never expose it to direct heat. A damaged power cord creates the danger of fire and electrical shock.



- Use only the AC adaptor specified for this unit (optional AD-A95100). Use of another AC adaptor creates the danger of fire and electrical shock.



- Should the power cord become seriously damaged (internal wiring is exposed or cut), request servicing from your original dealer. Use of a seriously damaged power cord creates the danger of fire and electrical shock.



- Never touch the AC adaptor when your hands are wet. Doing so creates the danger of electrical shock.

Never try to take the unit apart



- Never try to take the unit apart or modify it in any way. Doing so creates the danger of electrical shock, burn injury, or other personal injury.
- Never remove the outer cover of the unit. Exposure of high-voltage components inside creates the danger of electrical shock.

Packaging



- Keep the plastic bag that the unit comes in out of the reach of small children. Plastic bags create the danger of suffocation for small children.

Avoid dropping



- Should the unit ever become damaged by falling down, immediately turn off power and unplug the power cord from the wall socket. Request servicing from your original dealer. Use of a damaged unit creates the danger of fire and electrical shock.

Batteries



- Never charge batteries, try to take batteries apart, or allow batteries to become shorted. Never expose batteries to direct heat or dispose of them by incineration.

Tape Cutter



- Never touch the tape cutter while a tape cut operation is being performed. Doing so can result in cuts and other personal injury.



Caution

AC Adaptor



- Do not leave the power cord near stoves or other sources of intense heat. Doing so can melt power cord insulation and create the danger of fire and electrical shock.



- When unplugging the power cord from the wall socket, grasp the plug. Never pull on the cord itself. Doing so can damage the power cord and create the danger of fire and electrical shock.



- Whenever leaving the unit unattended for long periods, be sure to unplug it from the wall socket.



- Whenever moving the unit, be sure to unplug it from the wall socket. Leaving the unit plugged in when it is being moved can result in damage to the power cord and create the danger of fire and electrical shock.



- Whenever cleaning the unit, be sure to unplug it from the wall socket.



- When you are through using the unit, use its power switch to turn it off and then unplug it from the wall socket.

Avoid unstable areas



- Never place the unit on a wobbly table or a high shelf. Doing so can cause it to fall, resulting in personal injury.

Water and other foreign matter



- Never allow coffee, juice, or other drinks, or flower vases to spill on the unit. Liquid spilled on the unit creates the danger of fire and electrical shock. Should liquid ever spill onto the unit, immediately turn off power and unplug the power cord from the wall socket. Request servicing from your original dealer.



- Never allow metal objects or combustible materials to get into the air vents of the unit. Doing so creates the danger of fire and electrical shock.

Location



- Avoid leaving the unit in areas subjected to high humidity and large amounts of dust. Such conditions create the danger of fire and electrical shock.



- Avoid leaving the unit on a kitchen table, next to a humidifier, or in any other area where it might come into contact with oil vapors or steam. Such conditions create the danger of fire and electrical shock.



- Never place heavy objects on the unit. Doing so creates the danger of the unit falling, resulting in personal injury.

Batteries



- Misuse of batteries can cause them to leak acid that can cause damage to nearby items and creates the possibility of personal injury.



- Be sure that the plus (+) and minus (-) sides of each battery are facing correctly.



- Never mix batteries of different types.



- Never mix new batteries and dead batteries.



- Remove the batteries if you do not plan to use KL-100E for a long time.



- Use only the battery type specified for this label printer in this manual.

Memory



- Always keep separate written copies of any information you store in the memory of this label printer. Data stored in memory can be unexpectedly lost due to malfunction, repair, dead battery, etc.

Loading and replacing batteries



- Do not touch the springs inside the battery compartment cover with your fingers while loading or replacing batteries. The springs have sharp areas and can cut your fingers.

Introduction

Congratulations on your selection of the CASIO KL-100E Label Printer. This CASIO Label Printer makes it possible for you to print adhesive labels for a wide variety of applications, such as: name tags, cassette tape labels, floppy disks, binders, and other applications.

You can produce attractive, original labels thanks to such features as:

- Variable tape sizes (6mm, 9mm, 12mm, 18mm)
- Attractive sans-serif font
- Font effects (shading, underline, box)
- Conversion
- Built-in symbols
- Text memory

You can even use tapes with optionally available holders to create your own stamps.

All of this makes the CASIO label Printer the perfect tool for just about all of your labeling needs!

Important!

- Contact a nearby dealer whenever you require servicing.
- Note that the manufacturer shall not be held liable for any loss or claims by third parties which may arise out of the use of this product.
- Note that the manufacturer shall not be held liable for any damages incurred as a result of data loss caused by malfunctions, repairs, or interruption of power supply.
- It is up to the user to keep backup records of important data.
- Keep this manual on hand for future reference.

Contents

Important Safety Precautions	1
Part 1 Getting Acquainted	4
Important Precautions	4
General Guide	5
Label Printer Menus	5
Part 2 Getting Ready	5
Power Supply	5
Replacing Batteries	6
To load the batteries	6
AC Adaptor	7
AC Adaptor Cap	7
To connect the AC adaptor	7
Turning Power On and Off	7
Resetting the Memory	7
To reset the memory	7
Auto Power Off Function	7
Tape Cartridges	7
To load a tape cartridge	8
Tape Width Specification	8
To specify 6mm tape width	8
Part 3 Inputting Characters and Symbols	9
Display Symbols and Indicators	9
Basic Alpha-Numeric Input	10
To input alpha-numeric characters	10
About the CODE key... ..	10
Special Symbols	10
To input special symbols	10
Part 4 Deleting and Inserting Characters	11
Moving the Cursor	11
To move the cursor	11
Deleting Individual Characters	11
To delete characters using the BS key	11
To delete characters using the DEL key	11
Clearing the Display	11
To clear the display	11
Text Editing	11
To insert new characters	11
To change existing characters to different ones	12

Part 5 Character Size and Text Effects	12
Character Size	12
To change the character size	12
Text Effects	13
To specify a text effect	13
Part 6 Printing	13
Printing a Tape	14
To print a tape	14
Stamp Printing	14
To print a stamp tape	14
Mirror Image Printing	14
To turn mirror image printing on and off	14
Other Printing Features and Operations	15
Auto Feed	15
To turn auto feed on and off	15
To manually feed tape	15
Print Density	15
To adjust the print density	15
Part 7 Memory	15
To store data	15
To recall text from memory	16
To delete text from memory	16
Part 8 Currency Conversion	17
To set the conversion rate	17
To specify the number of decimal places	17
To set the name of CURRENCY A	17
To set the name of CURRENCY B	17
To select a label format	18
To perform a conversion and print a label	18
Printing a Bargain Label	18
To perform the calculation and print the label	18
Part 9 Reference	18
Cleaning the Printer Head and Roller	18
To clean the printer head and roller	18
Initial Power On Settings	19
Initializing the Label Printer	19
To initialize the Label Printer	19
Troubleshooting	19
Error Messages	21
Alpha Characters	22
Symbols	22
Specifications	23

Part 1 Getting Acquainted

This part of the manual provides you with important information you need to know in order to use the Label Printer to its full potential. Be sure to read it carefully before using the Label Printer for the first time.

Important Precautions

- Keep your Label Printer out of areas subject to temperature extremes, moisture and direct sunlight. The recommended temperature range is 10° to 35°C (50° to 95°F).
- Don't let coffee, juice or other liquids splash onto the Label Printer.
- Never let paper clips, pins or other foreign objects get into the tape outlet slot or printer of the Label Printer.
- Do not pile heavy objects on top of the Label Printer.
- Never try to take the Label Printer apart or attempt your own maintenance.
- Do not drop your Label Printer and avoid strong impact.
- Do not pull on the tape or try to force it back into the Label Printer.
- Do not use benzine, thinner, or other volatile chemicals to clean the exterior of the Label Printer. Use a soft, dry cloth or a cloth dampened in a weak solution of a mild, neutral detergent and water. Wring the cloth out until all excess moisture is removed.
- A dirty printer head can cause printing to become smudged. When this happens, clean off the printer head by wiping it with a cotton swab moistened with alcohol (page 18).
- Use of the Label Printer next to a television or radio may interfere with reception.

General Guide

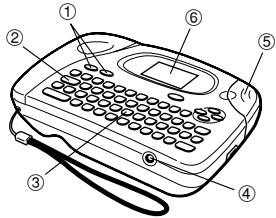

- ① **Power Keys**
Turn power on and off.
- ② **Function key**
- ③ **Letter keys**

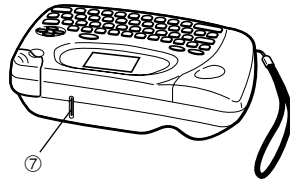

- ④ **Optional AC Adaptor connector**
- ⑤ **Tape cutter button**
- ⑥ **Liquid crystal display (LCD)**
- ⑦ **Tape outlet**

Using the Strap

Attach the strap to the Label Printer as shown in the illustration, and pull it tight.

To remove the strap, reverse the procedure shown in the illustration.

- Be sure to always hold on to the Label Printer itself when carrying it. Never allow the Label Printer to hang or swing from the strap. Doing so creates the danger of the Label Printer being damaged by surrounding objects or possibly causing injury to yourself or others.
- Take care to check the strap periodically for damage. Use of a damaged strap creates the danger of dropping the Label Printer, which can damage it.

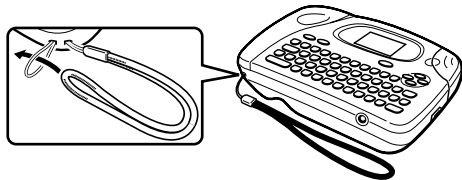

Label Printer Menus

Label Printer operation is designed to be as simple as possible, thanks to on-screen menus that you can use to select the settings you need. Each menu is described in detail in the sections that follow in this manual, but note the following general points when using them.

- The item that is underlined in a menu is the one that is currently selected.

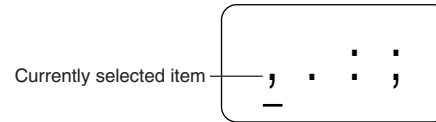

- Use **◀**, **▶**, **▲** and **▼** to move the underlining left, right, up and down and change the selected item.
- Press **SET** to execute the underlined item, or **ESC** to exit the displayed menu (and return to the previous menu or screen) without selecting anything.
- When you press **SET** to execute a menu item, the Label Printer either moves on to the next menu, or it executes the selected function and returns to the text input screen that you started from.

Part 2 Getting Ready

This part of the manual tells you how to load batteries and the tape cartridge, and how to perform other basic setups for the Label Printer.

Important!

- Be sure to read this section before attempting to use the Label Printer.

Power Supply

The Label Printer can be powered by six AA-size alkaline batteries or an optional AC adaptor (AD-A95100).

Replacing Batteries

A handy low battery power indicator lets you know when battery power is getting too low for proper operation. The message "BATT" appears on the display if battery power is low when you perform any of the following operations.

- Turn power on
- Execute a print operation

Whenever the "BATT" message appears, press **SET** to clear it from the display. You should still be able to perform some Label Printer operations, but some power intensive operations (like printing) may become impossible if battery power is too low. In any case, you should replace batteries as soon as possible or switch to the AC adaptor as soon as possible after the "BATT" message appears.

Important!

- All data stored in memory is deleted whenever batteries go dead and when you replace batteries. Be sure to keep written backup copies of all important data (text and documents).
- Batteries can burst or leak and damage your unit if you do not use them correctly. Note the following important points.
- Be sure that the plus (+) and minus (-) sides of each battery are facing correctly.
- Never mix batteries of different types
- Never leave dead batteries in the Label Printer.
- Remove the batteries if you do not plan to use the Label Printer for a long time.
- Replace the batteries in accordance with the battery life marked on the side of the battery.

Warning!

- Never use recharged batteries with the unit.
- Do not expose batteries to direct heat, do not short circuit them, and do not try to take them apart.
- **Keep batteries out of the reach of small children. If swallowed, consult with a physician immediately.**
- Be sure to replace the batteries in accordance with the battery life printed on the side of the battery itself.

To load the batteries

⚠ Caution

- Do not touch the springs inside the battery compartment cover with your fingers while loading or replacing batteries. The springs have sharp areas and can cut your fingers.



1. Turn power off.
- If you are using the optional AC adaptor for power, you should also unplug it from the Label Printer.
2. Turn over the label printer and remove the cover as shown in the illustration.

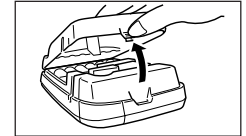

3. Load batteries into the battery compartment.
- Be sure to use alkaline batteries.
- Make sure the positive (+) and negative (-) ends of the batteries are facing correctly when you load them.

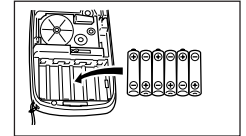

4. Replace the back cover.
- As shown in the illustration, hook the cover on the battery side of the compartment first, and then close the cover.
- Make sure that the tape cartridge is securely in place and that the back cover is closed securely before using the label printer. A loose tape cartridge can cause print quality problems.

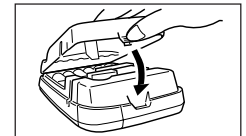

AC Adaptor

Note the following important precautions when using an AC adaptor to power your Label Printer.

- Use only a genuine CASIO AD-A95100 AC adaptor with the same voltage rating as the household current in your area. Using a wrong adaptor can damage your Label Printer.
- Be sure to turn the Label Printer off before you connect the adaptor. Do not turn power on until the adaptor is connected to the Label Printer and plugged into and AC outlet.
- Be sure to unplug the AC adaptor from the AC outlet whenever you are not using the Label Printer.

AC Adaptor Cap

Remove the ADAPTOR CAP before connecting the AC adaptor.

Insert the adaptor cap into the ADAPTOR CAP holder located inside the back cover to avoid losing the cap.

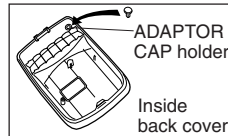

To connect the AC adaptor

Connect the adaptor to the Label Printer as shown in the illustration. Plug the other end into a standard household AC outlet.

Turning Power On and Off

Press **ON** to turn power on, and **OFF** to turn power off.

Important!

- If you are using the Label Printer for the first time, you should reset it first.

Resetting the Memory

You should reset the memory of the Label Printer before using it for the first time, after you have not used it for a long time, or if nothing happens when you turn power on, even after you change the batteries.

Important!

- Resetting Label Printer memory clears its memory of all input data.

To reset the memory

1. Make sure that Label Printer power is off.
 2. While holding down the **PRINT** and **ESC** keys, press **ON** to turn power on.
 3. Keeping **PRINT** and **ESC** held down, release the **ON** key only.
 4. Press **SET** to initialize the Label Printer or **ESC** to abort the reset operation without initializing anything.
- See "Initializing the Label Printer" on page 19 for information on the initial default settings of the Label Printer following the reset operation.



Auto Power Off Function

If you do not perform any key operation for about six minutes, the Label Printer automatically turns power off. To restore power, press **ON**.

Tape Cartridges

Use the procedures described below to load a tape cartridge into the Label Printer. After you load the tape cartridge, be sure to use the procedure described under "Tape Width Specification" on page 8 to tell the Label Printer what is the width of the tape you are using.

Important!

- Never try to push the tape back into the cassette. Once tape is out of the cassette, there is no way to wind it back in. Trying to do so can cause operational problems with the Label Printer.
- The following are the tape widths that can be used with this printer: 6mm, 9mm, 12mm, 18mm.

To load a tape cartridge

1. Make sure that the Label Printer is turned off.
2. Open the back cover.
 - If there is a cartridge already in the Label Printer, remove it by grasping the cartridge on both sides with your thumb and forefinger, and lift straight up.
3. Remove the stopper from a new tape cartridge and check to see that the tape is ready to use.

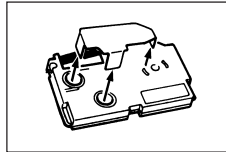
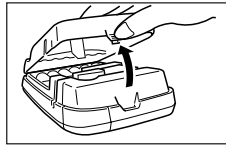

- Make sure that the tape is under the tape guide and that it is not bent or twisted.

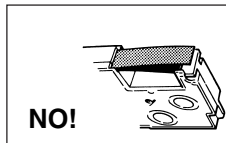
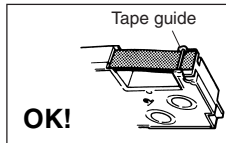

- Make sure that the tape does not extend too far past the tape guide. If it does, cut off the end with a pair of scissors.

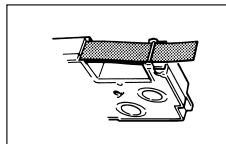

4. Use a pencil or some other thin object to take up slack in the ink ribbon as shown in the illustration. Note that the tape does not move at this time.
 - If the ink ribbon is slack when you load it into the Label Printer, it can break or cause some other problem.
 - Be sure to turn the ink ribbon take up spool only in the direction indicated by the arrow (a).
 - Turn the spool until the other spool (b) starts turning in the direction noted by the arrow. This indicates there is no slack in the ribbon.
5. Load the tape cartridge into the Label Printer, making sure that the tape and ink ribbon pass between the head and roller.
6. Close the back cover.

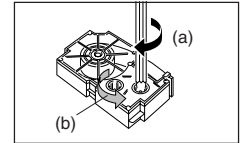
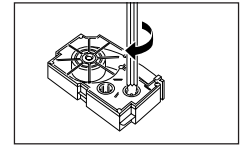

7. Turn on Label Printer power and press **FUNCTION** and then **PRINT (FEED)** two or three times to make sure that the tape comes out without any problem.
 - If the tape does not come out normally, turn off power and start again from step 1 above.

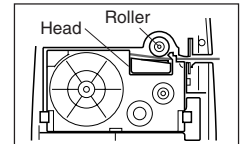

Tape Width Specification

Important!

- When using 6mm tape, using certain character sizes can cause characters to run off the top or bottom of the tape. Be sure to use the following procedure to tell the Label Printer when you are using 6mm tape.

To specify 6mm tape width

1. Turn power on.
2. Press **FUNCTION** and then **9** (6mm).
3. Press **◀**, **▶**, **▲** or **▼** to change the setting shown on the display between ON (6mm tape) and OFF (other tape width).
4. When the tape width setting is the way you want it, press **SET** to register it.
 - The tape width you set remains in effect until you change it, press **ON** or reset the Label Printer's memory.

Part 3 Inputting Characters and Symbols

This part of the manual tells you how to input characters. To make things easier to understand, we call everything you input a character, regardless of whether it is actually a letter, number, or symbol. Explanations here all use the default settings that are in effect from the initial power-on screen. For information on using other character styles, effects and sizes, see page 12.

Important!

- You can input up to 63 characters per label. Further input becomes impossible after you input the 63rd character.

Display Symbols and Indicators

Before getting into actual input, you should first become acquainted with the symbols and indicators used on the Label Printer display.

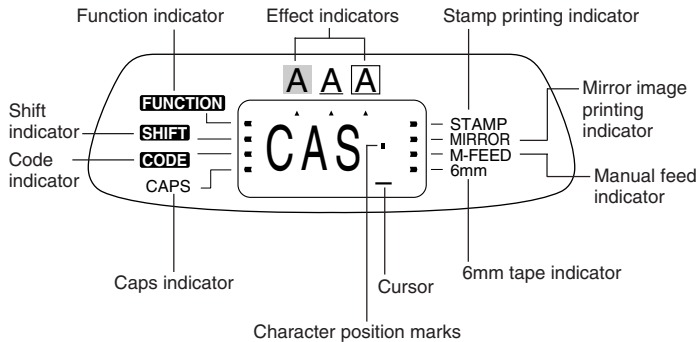

• Function indicator

This indicator appears when you press the **FUNCTION** key. Pressing a key while this indicator is on the display causes the function marked above that key to be executed.

• Shift indicator

This indicator appears when you press the **SHIFT** key. While this indicator is on the display, the keyboard is shifted, so the letter keys input upper-case alpha characters. The number keys input the punctuation symbols marked in the upper right corners of the keys.

If both the caps mode indicator and the shift indicator are shown on the display, the keyboard is shifted to lower-case input.

The keyboard automatically unshifts (and the shift indicator disappears) as soon as you input a character.

• Code indicator

This indicator appears when you press the **CODE** key. While this indicator is on the display, number keys **1** through **0** input the accents marked above them and the **U, O, P, A, S, J, K, L, Z, C** and **N** keys input the special characters marked in their lower right corners.

The keyboard automatically returns to normal (and the code indicator disappears) as soon as you input an accent.

• Caps indicator

This indicator appears when the Label Printer is in the caps (upper-case) mode. All letters you input in the caps mode are upper-case. When the caps mode indicator is not shown on the display, all letters are input as lower-case.

Note that the Label Printer stays in the caps mode until you press the **CAPS** key again.

If both the caps mode indicator and the shift indicator are shown on the display, the keyboard is shifted to lower-case input.

• Effect indicators

These indicators point to the character effect that is currently in use. You can select between shading, underline, and box.

• Stamp printing indicator

This indicator appears when the Label Printer is set up for stamp printing. Labels you create with stamp printing can be attached to an optionally available stamp holder and then used as a pre-inked stamp.

• Mirror image printing indicator

This indicator appears when the Label Printer is set up for mirror image printing. Normal (non mirror image) printing is performed when this indicator is not shown.

• Manual feed indicator

This indicator appears when you are using manual feed instead of auto feed. Auto feed is in effect when this indicator is not on the display.

Important!

- After you finish printing when using manual feed, be sure to always press **FUNCTION** and then **PRINT** (FEED) to feed the tape before cutting it. If you don't you will cut off part of the printed text.

• 6mm tape indicator

This indicator appears when you use the procedure on page 8 to specify you are using 6mm tape. No indicator is shown when you are using other (9mm, 12mm, 18mm) tape.

• Cursor

The cursor shows the next input position. Any character you input appears at the point where the cursor is located.

• Character position marks

These marks show where characters will appear as you input them. This part of the display is always blank when you turn power on.

Basic Alpha-Numeric Input

The following operation shows you the basic procedures for inputting letters and numbers. We will explain the procedure by inputting the following characters using the default initial power-on screen.

ABXYZ Computer Company
1234567890

Note

- If you hold down any key, it will repeat its operation or input at high speed until you release it.

To input alpha-numeric characters

1. Turn power on.
2. Input the first line of characters.
 - To input the upper-case letters, you can use either **SHIFT** or **CAPS**. With **SHIFT** you must shift the keyboard for each character. With **CAPS** the keyboard stays in upper-case until you press **CAPS** again.
 - Press **SPACE** to input spaces.

E-10

- If you input a wrong character, press **BS** to delete it and input again. See page 11 for other details on editing text.

3. When you reach the end of a line of text, press **↵** (the **▼** cursor key) to input a newline mark.

- A newline operation is indicated on the display by the **↵** symbol. This shows where you changed lines.

4. Input the characters in the second line.

5. To print the text that you input, press **PRINT**. For details on printing, see page 13.

About the CODE key...

The **CODE** key makes it possible to input punctuation needed for a number of different languages. The following shows the key operations you should use for each of the characters formed using the **CODE** key.

Key Operation	Input	Key Operation	Input	Key Operation	Input
CODE U	Ü	CODE L	Ø	CODE 4	~
CODE O	Œ	CODE Z	Ž	CODE 5	^
CODE P	À	CODE C	Ç	CODE 6	∨
CODE A	Æ	CODE N	Ñ	CODE 7	°
CODE S*	ß	CODE 1	'	CODE 8	/
CODE J	Ö	CODE 2	·	CODE 9	“
CODE K	Ä	CODE 3	“	CODE 0	€

* Lower case only.

Example: To input á.
CODE 1 A

Special Symbols

You can also access a menu of special symbols by pressing **FUNCTION 4** (SYMBOL).

To input special symbols

Example: To input the special symbol #.

1. With the cursor at the location where you want to input a special symbol, press **FUNCTION 4** (SYMBOL).

- The symbol that is underlined on the display is the one that is currently selected.

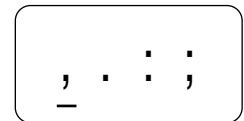

- Use the ◀, ▶, ▲ and ▼ cursor keys to move the underlining to the symbol you want.
 - Not all of the available symbols fit on the display. The menu will scroll when you press the cursor keys.
 - In this example, underline #.
- After you underline the symbol you want, press **SET**.
 - This returns to the input screen, with the symbol you selected input at the location where the cursor was located when you displayed the symbol list.



Part 4 Deleting and Inserting Characters

This section describes everything you need to know about deleting and editing characters you have already input.

Moving the Cursor

Use the cursor keys to move the cursor around the display and position it for deleting and editing characters.

To move the cursor

- Press ◀ to move the cursor to the left, and ▶ to move the cursor to the right.
- Press **FUNCTION** and then ◀ to make the cursor jump to the beginning (far left) of the characters on the display.
- Press **FUNCTION** and then ▶ to make the cursor jump to the end (far right) of the characters on the display.
- Holding down the ◀ or ▶ cursor key moves the cursor at high speed.

Deleting Individual Characters

You can delete individual characters with either the **BS** key or the **DEL** key (which is the ▲ cursor key). The only difference between the operation of these two keys is the location of the cursor.

To delete characters using the BS key

Example: To change the word “commmputer” to “computer”.

- Use ◀ and ▶ to move the cursor under “p”.



- Press **BS** twice to delete the two m's to the left of the cursor, shifting “puter” to the left as you do.
- Press **FUNCTION** and then ▶ to jump back to the end of the characters for more input.

To delete characters using the DEL key

Example: To change the word “commmputer” to “computer”.

- Use ◀ and ▶ to move the cursor under the first (far left) “m”.
- Press **DEL** twice to delete the two m's at the cursor's position, shifting “mputer” to the left as you do.
- Press **FUNCTION** and then ▶ to jump back to the end of the characters for more input.

Clearing the Display

Use the following procedure to clear all input text from the display.

To clear the display

Press **FUNCTION** and then **BS** (CLS).

At this time the message CLS? appears on the display to confirm that you want to clear the display. Press **SET** to clear or **ESC** to abort the operation without clearing anything.

Text Editing

You can use the following procedures to edit text on the display.

To insert new characters

Example: To change the text “ABCDEF” to “ABCXYZDEF”.

- With the original text on the display, move the cursor under the letter “D”.

2. Input the new characters (XYZ).

- Inputting the new characters causes them to be inserted at the cursor position. The existing characters are opened up to make room for the new characters.

To change existing characters to different ones

Example: To change the text "ABCDEF" to "XYZDEF".

1. With the original text on the display, use either the **BS** key or **DEL** key to delete the characters to be changed (ABC).
 - Remember to use the correct cursor location for the key you plan to use to delete the characters. See page 11 for details.
2. Input the new characters (XYZ).

Part 5 Character Size and Text Effects

This part of the manual explains how to change the size of characters. It also tells you how to assign text effects like underlining, shading, and box printing.

Character Size

The following table shows the six character sizes that are available.

Character Size Indicator	Actual Size (mm)
1×1	3×3
1×2	3×6
1×3	3×9
2×1	6×3
2×2	6×6
2×3	6×9

Character size changes are applied to printed text only. The size of the displayed text does not change.

Important!

- Any character size specification you make is applied to all the characters on the display. You cannot make multiple specifications for specific characters.
- The Label Printer automatically adjusts the character size whenever you input a ↵ symbol to create a 2-line label as shown below. Deleting the ↵ symbol with a backspace or delete operation reverts to the initial (unadjusted) character size.

Initial Size	Size After ↵ Operation
JUST	1×1
2×1	1×1
2×2	1×2
2×3	1×3

Note that you cannot input a ↵ symbol if you are using 6mm wide tape.

- The Label Printer automatically adjusts the character size whenever you delete a ↵ symbol to change a two-line label to a 1-line label.

Initial Size	Size After Delete of ↵
JUST	2×2

To change the character size

Example: To input "ABXYZ" as 2×2 characters.

1. Input the text.
2. Press **FUNCTION 2 (SIZE)** to display the current character size setting.



3. Use ▲ and ▼ (◀ and ▶) to change the displayed size in the following sequence.

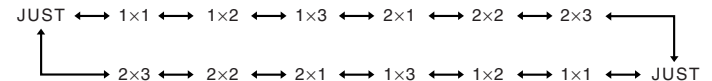

- When the character size you want to specify is on the display, press **SET** to select it and return to the text display.

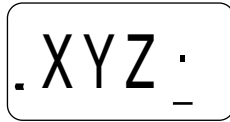

Note

- You could also perform the above procedure in reverse, specifying the character size first and then inputting the text.

Text Effects

There are three text effects that you can assign: shading, underlining, and boxed text. The following shows examples of each.

Shading: **ABC.XYZ**

Underlining: ABC.XYZ

Boxed Text: **ABC.XYZ**

Text effect changes are applied to printed text only. The appearance of the displayed text does not change, but the text effect indicators will show you when a text effect is being used.

Important!

- Any text effect specification you make is applied to all the characters on the display. You cannot make multiple specifications for specific characters.

To specify a text effect

Example: To shade the text "ABXYZ".

- Input the text.
- Press **FUNCTION 3** (EFFECT) to display a menu of text effects.

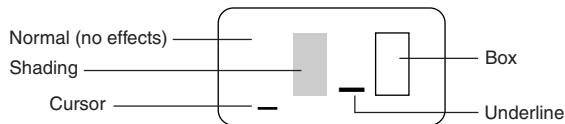

- Use ◀ and ▶ to move the cursor to the effect you want to use.
- When the cursor is located under the effect you want to specify, press **SET** to select it and return to the text display.



Note

- You could also perform the above procedure in reverse, specifying the text effect first and then inputting the text.

Part 6 Printing

This part of the manual includes all the information you need to print tapes. It also tells you how to print special stamp tapes that you can attach to an optional stamp holder to create your own original stamps.

Printing Precautions

- Never turn power off while printing is being performed.
- Make sure that the tape outlet is not blocked before you start printing.
- Never operate the tape cutter while printer is being performed (indicated by the message "PRNT" on the display).
- During printing at very high density, printing of very long text, or repeat printing of the same text a number of times, the Label Printer may stop printing for about five seconds. This is not a malfunction, and normal printing should resume shortly (indicated by the message "P R N T" on the display).

Important!

- Never touch the tape cutter while a tape cut operation is being performed. Doing so can result in cuts and other personal injury.

Printing a Tape

Printing a tape is as easy as pressing the **PRINT** key.

To print a tape

1. Press the **PRINT** key to print a tape of the text you have input and laid out.
 - To stop a print operation that is in progress, press **ESC**.
2. After the print operation is complete, press down on the tape cutter button to cut the tape.
3. Use scissors to trim the tape to the size you want, if necessary.
 - After you print a tape, you can peel off its paper backing and stick the tape onto the object you want. Note that the tape will not stick on coarse, wet, oily, or soiled surfaces. Also, you should not try to use the tape where it is exposed to direct sunlight or rain. Do not stick the tape onto human skin.
 - An easy way to remove the backing from a tape and expose the adhesive surface is to bend the tape near one of its ends. This should cause the tape and its backing to separate, allowing you to pull them apart.

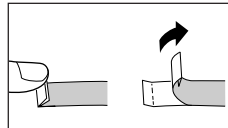
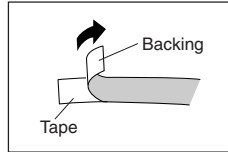

Stamp Printing

The stamp printing feature lets you print on special stamp tape. You can then attach the finished stamp tape to an optionally available stamp holder to create your own original pre-inked stamps. The following is the type of stamp holder currently available for use with stamp tapes.

Type	Maximum Stamp Size	Example
ST-15	5.5cm	

Note the following important points about stamp printing.

- Stamp printing prints text in mirror image.
- Stamp printing is impossible while 6mm is specified as the tape width.
- An error message (ERR!) appears on the display and the Label Printer refuses to print whenever you try to print text that is longer than the maximum length you specify.

To print a stamp tape

1. Input the text you want to print.
2. Press **FUNCTION** and then **5** (STAMP).



- A mark appears next to the STAMP indicator on the display when mirror printing is turned on.
 - If the text you input in step 1 is too long to fit within the maximum length you specified, an error message (page 21) appears when you press **SET**.
3. Press **SET** to print the stamp tape or **ESC** to abort the print operation and return to the text input display in step 1.
 - After the printing is complete, the Label Printer returns to the input display in step 1.
 4. Cut off the tape and affix it to the optional stamp holder.
 - See the instructions that come with the optional stamp holder for information about how to attach the stamp tape.

Mirror Image Printing

When you specify mirror image for text, it is printed in reverse image. Use mirror image when you plan to print on transparent tape, with the printing on the inside. When viewed through the transparent tape, the text will appear normal. You can also use mirror image printing when using iron-on transfer tape to print iron-on transfers.

Normal

ABC.XYZ

Mirror Image

ZYX.CBA

To turn mirror image printing on and off

1. Press **FUNCTION** and then **6** (MIRROR).



2. Press ◀, ▶, ▲ or ▼ to change the setting shown on the display between ON (mirror printing) and OFF (normal).
3. When the mirror image printing setting is the way you want it, press **SET** to register it.
 - A mark appears next to the MIRROR indicator on the display when mirror printing is turned on.
 - After you turn printing on, input text and perform the print operation as you normally do (page 14) to produce mirror image tapes.

Other Printing Features and Operations

The following are other operations and settings that you may need to use when printing.

Auto Feed

You can turn the Label Printer's auto feed feature on and off. When auto feed is on, the Label Printer automatically feeds the tape about 17.1mm at the beginning and end of each print operation. This creates identical margins on both sides of your text.

Important!

- After you finish printing when using manual feed, be sure to always press **FUNCTION** and then **PRINT** (FEED) to feed the tape before cutting it. If you don't you will cut off part of the printed text.

To turn auto feed on and off

1. Press **FUNCTION** and then 7 (M-FEED).

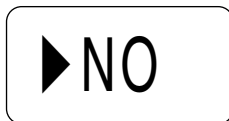

2. Press ◀, ▶, ▲ or ▼ to change the setting shown on the display between YES (manual feed) and NO (auto feed).
3. When the feed setting is the way you want it, press **SET** to register it.

To manually feed tape

Press **FUNCTION** and then **PRINT** (FEED) to feed the tape 18.1mm.

Print Density

The print density setting controls how darkly figures are printed on your tapes.

To adjust the print density

1. Press **FUNCTION** and then 8 (DENSITY).

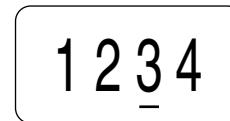

2. Use ◀ and ▶ to move the underlining to the density setting that you want.
 - The lightest setting is 1, while the darkest setting is 5. The standard setting is 3.
 - Only four of the five settings that are available can appear on the display. The display scrolls left and right when necessary to show all of the available settings.
3. When the density setting is the way you want it, press **SET** to register it.

Part 7 Memory

This part of the manual tells you how to store text data in memory for instant recall when you need it. You can store two blocks of text in memory, each containing up of 63 characters, for a total of 126 characters.

Important!

- All data stored in memory is deleted whenever batteries go dead and when you replace batteries. Be sure to keep written backup copies of all important data (text and documents).
- When using the optional AC adaptor, never disconnect the adaptor while batteries are not loaded in the Label Printer or when batteries are dead. Doing so causes all data stored in memory to be deleted.

To store data

1. Input the text you want to store.
2. Press **FUNCTION** and then 1 (MEMO).
3. Press ▼ a number of times to change to the text store prompt.



- Press **SET** to store the text in memory or **ESC** to abort the store procedure without storing anything.
- If there is nothing in memory yet, your text is automatically stored in Area 1. If Area 1 already contains data, your new input is automatically stored in Area 2.
- If there is not enough room for your text to fit in memory, the message "FUL!" appears when you press **SET** in step 4.

OK

. EFG _

To recall text from memory

Example: To recall the contents of Area 2 while memory contains the following text.

Area 1: ABCDEFG

Area 2: CASIO

- While the input screen is on the display, press **FUNCTION** and then 1 (MEMO).
- Note that text recalled from memory will replace any text currently on the display.
- Press ▼ a number of times to change to the text recall prompt.

CAL?

- Press **SET**.
- If all of the text does not fit on the display, you can use ◀ and ▶ to scroll it to the left and right.

. ABCD

Area 1 text

- Press ▼ to change to Area 2.
- Use ▲ and ▼ to switch between Area 1 and Area 2.

. CASI

Area 2 text

- Press **SET** to recall the text from the area that is currently on the display.
- Note that recalling data from memory replaces anything that is currently on the input display. Memory text cannot be appended.

. CASI

To delete text from memory

- While the input screen is on the display, press **FUNCTION** and then 1 (MEMO).
- Press ▼ a number of times to change to the text delete prompt.

DEL?

- Press **SET**.
- If all of the text does not fit on the display, you can use ◀ and ▶ to scroll it to the left and right.

. ABCD

Area 1 text

- Use ▲ and ▼ to select Area 1 or Area 2 then press **SET**.

OK?

- Press **SET** to delete the text from the area that is currently on the display.

Part 8 Currency Conversion

Your Label Printer can perform currency conversion calculations according to a rate preset by you, and print the results on a label.

Label Formats



Important!

- You can input text (and specify its style, attributes and size), which is printed to the left of the conversion result ("SALE!" in the above examples). Default style, attributes, and size are used if you do not specify any. Only the conversion result is printed if you do not input any text.
- You cannot change the style, attributes, and size of calculation result printing.
- You can select rounding to no decimal places or to two decimal places for currency conversion calculations.
- You can specify the direction of the conversion as either CURRENCY A → CURRENCY B or CURRENCY B → CURRENCY A.

Converting a National Currency to Euros

- Selecting [PRINT A → B] performs the conversion according to the following formula: Value ÷ Rate.

Converting Euros to a National Currency

- Selecting [PRINT B → A] performs the conversion according to the following formula: Value × Rate.

Example



(Round to two decimal places)

To set the conversion rate

- Press **FUNCTION Z** (RATE).
- Input the rate you want to use. (ex. 1.2345678)
 - You can input up to eight digits plus decimal point, or a leading decimal point plus seven digits.
 - Remember to input the correct value for the conversion direction (PRINT A → B, PRINT B → A) you plan to use.
- Press **SET**.

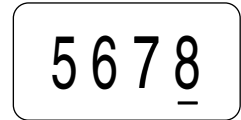

To specify the number of decimal places

- Press **FUNCTION X** (ROUND).
- Use ◀ and ▶ to select the decimal place setting you want to use.
 - 0 ... Rounding to integer
 - 2 ... Rounding to two decimal places
- Press **SET**.

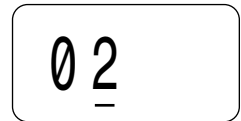

To set the name of CURRENCY A

- Press **FUNCTION C** (CURR A).
- Input the name you want to use. (ex. DM)
 - You can input up to five characters for the currency name.
- Press **SET**.

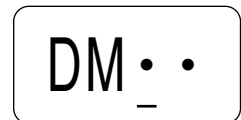

To set the name of CURRENCY B

- Press **FUNCTION V** (CURR B).
- Input the name you want to use. (ex. EUR)
 - You can input up to five characters for the currency name.
 - The initial default name of CURRENCY B is "€".
- Press **SET**.



To select a label format

1. Press **FUNCTION B** (FORMAT).
2. Use ◀ and ▶ to select the number of the format you want to use.
 - There are eight formats (1 through 8: page 17), though only four numbers are displayed at one time. Use ◀ and ▶ to scroll the available display numbers left and right.
3. Press **SET**.

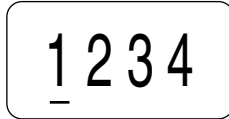

To perform a conversion and print a label

1. Input the text you want to include in the label.
 - In this example, we will use the text "SALE!".
2. Press **FUNCTION M** (PRINT A → B).
3. Input the value you want to convert from. (ex. 10.00)
 - You can input up to eight digits plus decimal point, or a leading decimal point plus seven digits.
 - If you want zeros included to the right of the decimal point, you must input them as well. Inputting "123" prints "123" only. To print "123.00" you must input all five digits and the decimal point.
4. Press **SET**.
 - Pressing **SET** performs the conversion, inserts it into the format you selected, and prints the label.
 - You can repeat the above procedure with the current RATE, ROUND, CURRENCY A, CURRENCY B, and FORMAT settings as many times as you want.

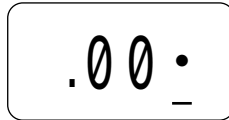

Printing a Bargain Label

The following example shows how you can print a discount label that calculates a mark down rather than a currency conversion.



Label for 30% discount

To perform the calculation and print the label

CURRENCY A	NOW
CURRENCY B	(Blank)
RATE	0.7 (-30%)
ROUND	2 (Round to two decimal places)
FORMAT	1
PRINT	PRINT B → A

1. Press **FUNCTION Z** (RATE), input the value that the original price should be multiplied by in order to produce the discounted price, and then press **SET**.
 - In our example, we want to produce a 30% (.30) discount, so we specify a multiplier of .70.
2. Press **FUNCTION X** (ROUND), use ◀ and ▶ to select the rounding, and then press **SET**.
3. Press **FUNCTION C** (CURR A), input the name of currency ("NOW" in this example), and then press **SET**.
4. Press **FUNCTION V** (CURR B), make sure it is blank (nothing is input), and then press **SET**.
5. Press **FUNCTION B** (FORMAT), select the format, and then press **SET**.
6. Input the text you want to use ("SPECIAL!" in this example).
7. Press **FUNCTION** and then ▶ (PRINT B → A), input the original price (10.00 in this example), and then press **SET**.

Part 9 Reference

This section contains information about the Label Printer that you can use as reference when you need it.

Cleaning the Printer Head and Roller

A dirty printer head and roller can result in poor printing quality. If you have problems with print quality, use the following procedure to clean the printer head and roller.

To clean the printer head and roller

1. Make sure the Label Printer is turned off.
2. Turn over the Label Printer, and open the back cover while pressing down on its lock.

- Remove the tape cartridge.
- Use a cotton swab dipped in alcohol to clean the printer head and roller as shown in the illustration.

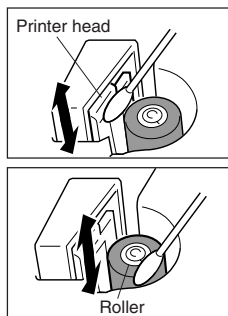

- Replace the tape cartridge and close the back cover.

Initial Power On Settings

The following are the initial settings of the Label Printer whenever you turn it power on.

Item	Power On
SIZE	JUST (2x2)
EFFECT	CANCEL
MIRROR	OFF
M-FEED	NO
6mm	OFF

Initializing the Label Printer

If you experience serious malfunction of the Label Printer or if operation fails completely, try performing the following operation to initialize the printer.

Important!

- Initializing the Label Printer deletes all memory contents. Make sure you have a back-up copy of text stored in memory if you need it.

To initialize the Label Printer

- Turn power off.
- While holding down the **PRINT** and **ESC** keys, press **ON** to turn power on.
- Keeping **PRINT** and **ESC** held down, release the **ON** key only.
 - This prompt confirms whether or not you want to initialize the Label Printer.
- Press **SET** to initialize the Label Printer or **ESC** to abort the reset operation.
 - The following table shows the initial settings.



Item	Reset
Display	Cleared
Memory	Cleared
SYMBOL	,
EFFECT	CANCEL
M-FEED	NO
MIRROR	OFF
MEMO	STR?
DENSITY	3
6mm	OFF
CURRENCY B	€
FORMAT	1
ROUND	2

Troubleshooting

• Power Supply

Nothing appears on the display.	
Possible Cause	Action
Low batteries	Replace batteries.
Batteries loaded incorrectly	Remove batteries and reload them correctly.
AC adaptor is not connected correctly.	Make sure the AC adaptor is connected correctly.

• Text Input

Cannot input text.	
Possible Cause	Action
FUNC key has been pressed.	Press ESC to clear FUNC key operation.

Tape does not come out when PRINT is pressed.	
Possible Causes	Action
Back cover is not closed completely.	Securely close the back cover.
No more tape left in the cartridge.	Replace the tape cartridge with a new one.
Tape jam	Remove the tape cartridge and pull out the jammed tape by hand. Cut off excess tape with scissors, and carefully replace the cartridge into the label printer. Important! Never allow the tape outlet to become blocked and never touch tape as it is being fed during printing.

Tape comes out when PRINT is pressed, but nothing is printed on it.	
Possible Cause	Action
Only blank spaces were input.	Input the text you want to print.

Printing is blurred, blotched, broken, etc.	
Possible Causes	Action
Improper print density setting	Adjust the print density setting.
Improper loading of the cartridge	Remove the tape cartridge and reload it correctly.
Dirty print head or rubber roller	Clean the printer head and roller.

Ink ribbon is being fed from the tape outlet along with the tape.	
Possible Cause	Action
Ink ribbon cassette loaded while the ink ribbon is slack.	Remove the ink ribbon cassette and check to make sure the ink ribbon is not broken. Next, take up any slack in the ink ribbon and then reload the tape cartridge. Important! <ul style="list-style-type: none"> • Before loading an ink ribbon cassette into the label printer, always make sure you take up any slack in the ink ribbon first. • If the ink ribbon is broken, you must change to another ink ribbon cassette.

• Tape Cutting

Cannot cut tape.	
Possible Cause	Action
Tape cutter blade is dull.	Take the label printer to the dealer from whom you purchased it to have the tape cutter blade replaced.

Printed text is cut off by tape cut operation.	
Possible Causes	Action
The printer is set up for manual tape feed.	Be sure to press the FEED key before performing the tape cut operation. Important! When the printer is set up for manual tape feed, the tape is not fed automatically after printing is complete.
Out of tape	Replace the tape cartridge with a new one.

• Using Labels

Label will not adhere to a surface.	
Possible Causes	Action
The backing paper is still on the back of the tape.	Peel the backing paper from the back of the tape to expose the adhesive.
Surface is unsuitable for affixing a tape.	Labels do not adhere well to surfaces that are rough, wet, oily, or dirty.

Error Messages

Message	Possible Causes	Action
<p>ERR!</p> <p>*This message appears on the screen for about one second.</p>	<ul style="list-style-type: none"> • Attempt to input two ↵ marks within the same text. • Attempt to input ↵ mark while 6mm is specified as the tape width. • Label text containing a ↵ mark was input and then tape width specification was changed to 6mm. (ERR! message appears when you try to perform a print operation.) • Text that is longer than 5.5cm when stamp printing is selected. • Attempt to print a stamp while 6mm is specified for the tape width. • Input of any of the following for while using the currency conversion functions: RATE, PRINT A → B (+), or PRINT B → A (×). <ul style="list-style-type: none"> • A value with more than eight digits or more than seven digits with a leading decimal point. • More than one decimal point character 	<ul style="list-style-type: none"> • Use only one ↵ mark. Only two lines of text can be input, so text can contain only one ↵ mark. • Do not use ↵ marks. 6mm tape can have only one line of text, so text cannot contain any ↵ marks. • Delete the ↵ mark to print on 6mm tape or switch back to a wider tape. • Shorten the text to be printed and try again. • Change the tape width setting to OFF and try printing the stamp again. • Input the value correctly.

Message	Possible Causes	Action
FUL! *This message appears on the screen for about one second.	• Both text memory areas (AREA 1 and AREA 2) already contain text.	• Delete text from one of the text memory areas and then store the new text.
BATT	• Battery power is too low.	• Replace batteries.
ERR!	• Memory data has become corrupted for some reason.	• Initialize the Label Printer.

Alpha Characters

A B C D E F G H I J K L M
N O P Q R S T U V W X Y Z
a b c d e f g h i j k l m
n o p q r s t u v w x y z
Œ œ Æ æ ß Ž ž Ç ç

É é Ý ý Ú ú Í í Ó ó
Á á Š š Ž ž Ć ć Ń ń
È è Ù ù Ĭ ĭ Ò ò Ä à
Ë ë Ü ü Ī ī Ö ö Ä ä
Õ õ ã ã Ñ ñ
Ê ê Û û Î î Ô ô Â â
Ě ě Ř ř Ť ť Ā ā Š š
Ď ď Ž ž Ć ć Ń ń
Û û Ā ā Ø ø Ł ł
Ú ú Ó ó Ę ę Ą ą

Symbols

, . : ; • ‘ ’ “ ” „
? ! ¿ ¡ / ~ () + -
± × ÷ = < > \$ € £ ¥
& * @ § ° ª º

Specifications

Model: KL-100E

Input

Keyboard Layout: Typewriter (QWERTY)

Character Types

Alpha (English and other languages): 151

Numbers: 10

Symbols: 41

Display

Type: Liquid crystal display

Columns: 4

Character matrix: 5×7-dot

Printing

Type: Thermal transfer

Speed: Approximately 6.76mm/second

Width: 4mm (6mm tape) or 8mm (9mm, 12mm and 18mm tapes)

Character Matrix: 24×24-dot

Character font: Sans-serif

Character effects: Shade, underline, box

Character sizes: 1×1, 1×2, 1×3, 2×1, 2×2, 2×3

Number of lines: 1 (6mm tape); 1 or 2 (other tapes)

Memory

Text: Up to approximately 126 characters (total storage for AREA 1 and AREA 2)

General

Power supply: Six AA-size alkaline batteries or optional AD-A95100 AC adaptor

Battery life: Approximately 2 tape cartridges (continuous printing)

Power consumption: 9W

Auto Power Off: Approximately six minutes after last key operation.

Dimensions: 53 (H) × 178 (W) × 111 (D)mm (2 1/16"H × 7"W × 4 3/8"D)

Weight: 360g

Ambient Temperature: 10°C~35°C (50°F~95°F)

CASIO®

CASIO COMPUTER CO., LTD.

6-2, Hon-machi 1-chome
Shibuya-ku, Tokyo 151-8543, Japan

Free Manuals Download Website

<http://myh66.com>

<http://usermanuals.us>

<http://www.somanuals.com>

<http://www.4manuals.cc>

<http://www.manual-lib.com>

<http://www.404manual.com>

<http://www.luxmanual.com>

<http://aubethermostatmanual.com>

Golf course search by state

<http://golfingnear.com>

Email search by domain

<http://emailbydomain.com>

Auto manuals search

<http://auto.somanuals.com>

TV manuals search

<http://tv.somanuals.com>