

accelTM
NEWBORN/TODDLER
CAR SEAT *series*

Instruction Manual

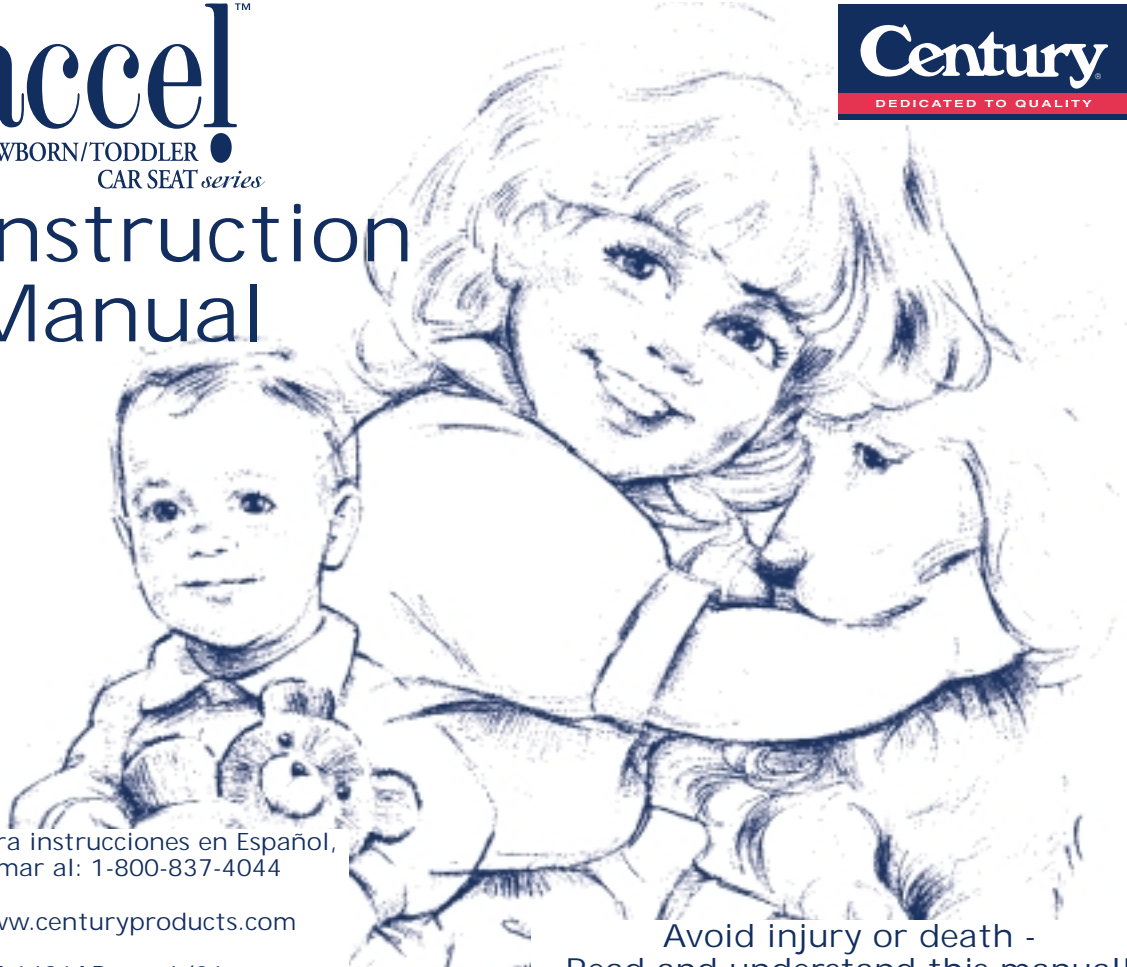

Para instrucciones en Español,
llamar al: 1-800-837-4044

www.centuryproducts.com

PM-1421AB

6/01

Download from [Www.Somanuals.com](http://www.Somanuals.com). All Manuals Search And Download.

**Avoid injury or death -
Read and understand this manual!**

TABLE OF CONTENTS

Instruction manual is for:

- Accel™ 5-Point Newborn/Toddler Car Seat
- Accel™ Overhead Newborn/Toddler Car Seat

Instructions for these models *are the same* unless otherwise noted.

Operations and Adjustments.....	10
• Harness Straps	
• Harness Tie	
• Buckle	
• Recline / Upright Positions	
• 5-Point Crotch Strap Adjustment	
• Overhead Shield Adjustment	
• Changing Harness Strap Slots	

Before You Begin

Important Information.....	1
Warnings.....	2
Basic Information.....	4

Use

Height & Weight Limits.....	5
Rear-facing Installation.....	6
Forward-facing Installation.....	7
Placing Child in Car Seat.....	8

Special Information

Vehicle Seat Belts.....	14
• Locking Clip.....	19
Additional Information	20
• Installation of Anchor Hardware	
• Tether Storage	
• Care and Cleaning	
• Aircraft Use	
• Second Hand Car Seat	
Storage.....	Back Cover
• Locking Clip	
• Instruction Manual	
Help Information.....	Back Cover

IMPORTANT INFORMATION

No car seat can guarantee protection from injury in every situation, but proper use helps reduce the risk of serious injury or death.

Registration Information

Child restraints (car seats) could be recalled for safety reasons. You must register this restraint to be reached in a recall. Fill out the registration card attached to car seat and mail today or send your name, address, and the restraint's model number and manufacturing date to:

Century Products
P.O. Box 551
Elverson, PA 19520-9973
or call 1-888-224-6549

For recall information:

- Call the U.S Government's Auto Safety Hotline at 1-800-424-9393 (202-366-0123 in D.C. area)
- www.nhtsa.dot.gov
- Call Century Products at 1-800-837-4044

Safety First Check List

- ✓ Read and understand instruction manual and car seat labels.
- ✓ Infants less than 20 lbs. (9.1 kg) **must** use car seat **rear-facing**.
- ✓ Do not use car seat **rear-facing** in vehicle seat with air bag.
- ✓ Secure children in back seat whenever possible.
- ✓ Never leave child unattended.
- ✓ Install car seat securely.
- ✓ Do not use after date shown on back of car seat.
- ✓ Do not allow anyone (babysitter, relatives, etc.) to use car seat without first understanding all instructions.

WARNINGS - Prevent serious injury or death:

Failure to follow these instructions and car seat labels can result in child striking the vehicle's interior during a sudden stop or accident. Secure child restraint with a vehicle seat belt as shown in this manual.

Infants less than 20 lbs. (9.1 kg) must use this car seat **rear-facing**. Serious crippling injury or death can result if infant faces front of vehicle.

Vehicle seat belt system **MUST** hold car seat securely. Not all vehicle seat belts can be used with a car seat. If vehicle seat belt does not hold car seat securely, read "Vehicle Seat Belts" section.

DO NOT use **rear-facing** child restraint in a vehicle seating position equipped with an air bag. Child's head and neck may be seriously injured when an inflating air bag hits back of child restraint.

Never put a car seat in a front vehicle seat unless recommended by vehicle owner's manual. National Highway Traffic Safety Administration (NHTSA) alerts vehicle owners that according to accident statistics, children up to age 12 are safer in the back seat. For vehicles with air bags, refer to vehicle owner's manual for child restraint installation information.

If car seat is in a crash, it must be replaced. **DO NOT use it again!** A crash can cause unseen damage and using it again could result in serious injury or death.

⚠ WARNINGS - Prevent serious injury or death (continued):

DO NOT use car seat if it is damaged or has missing parts.

DO NOT use accessories or parts other than those provided by Century or Graco. Their use could alter the performance of the car seat.

Rear-facing car seat must be properly leveled:

- Too reclined can result in injury or ejection.
- Too upright can result in breathing difficulties.

Never leave child unattended, even when sleeping. Child may become tangled in harness straps and suffocate.

If car seat has a cup holder, **DO NOT** put hard or sharp objects in cup holder.

BASIC INFORMATION

Certification

This car seat meets or exceeds all applicable requirements of Federal Motor Vehicle Safety Standard 213 for use in motor vehicles and aircraft.

Unoccupied Car Seat

Always secure car seat with a vehicle seat belt, even when unoccupied. An unsecured car seat can injure passengers.

Car Seat Useful Life

DO NOT use after date shown on back of car seat due to changing requirements and normal wear and tear.

Look for:

Do not use this car seat after December

Year

Warm Weather

Car seat parts can get very hot in the sun or warm weather.

To avoid burns, always check before putting child in car seat.

Dangerous Vehicle Seats

Do not use car seat on rear-facing or side-facing vehicle seats.

Vehicle Seat Protection

Protect vehicle seat. Use a car seat mat, towel or thin blanket under and behind car seat.

HEIGHT & WEIGHT LIMITS

Rear-facing: Birth to 30 lbs. (13.6 kg)

- Infants from birth to 20 lbs. (9.1 kg) **MUST** be **rear-facing**.
- Infants or toddlers 20 to 30 lbs. (9.1 to 13.6 kg) may be **rear-facing**.

IMPORTANT: This car seat is certified for use **rear-facing** with children up to 30 lbs. (13.6 kg). However, some children approaching 30 lbs. (13.6 kg) may be too tall to fit comfortably **rear-facing**. When child can no longer comfortably fit and knees remain bent, child should use car seat forward-facing only if child is over 20 lbs. (9.1 kg) and can sit upright unassisted ✱.



Forward-facing: 20 to 40 lbs. (9.1 to 18.1 kg)

- Toddlers 20 to 30 lbs. (9.1 to 13.6 kg) who are capable of sitting upright unassisted may be forward-facing ✱. If unable to sit unassisted, use **rear-facing**.
- Toddlers 30 to 40 lbs. (13.6 to 18.1 kg) and up to 40 inches (101.6 cm) tall **MUST** be forward-facing.

✱ The American Academy of Pediatrics recommends that children should be at least one year of age before being positioned forward facing.

Preterm or Low Birth Weight Infants

A preterm infant or low birth weight infant may be at special risk in a vehicle or aircraft.

According to the American Academy of Pediatrics, these infants may suffer breathing difficulties if improperly reclined in a car seat.

Century advises that you have your physician or hospital staff evaluate your infant and recommend the proper car seat or car bed **before** you and your infant leave the hospital.

Outgrowing Car Seat

WARNING

Prevent serious injury or death:

- Top of child's ears must be below top edge of car seat.
- Child's shoulders **MUST** not be above top harness slots.

REAR-FACING INSTALLATION

- 1 Adjust car seat to **recline** position and place **rear-facing** on vehicle seat.
- 2 Thread vehicle seat belt through openings and buckle belt.
- 3 Press down firmly in center of car seat to compress vehicle seat cushion while tightening vehicle seat belt (**fig. a**).
- 4 Pull front to back and left to right to check for secure installation (**fig. b**). Vehicle lap belt **MUST** stay tight.
If not secure, see "Vehicle Seat Belts" section.
- 5 Check level indicator on car seat.

Ball **MUST** be entirely in green zone (**fig. c**). If necessary, place rolled towels under car seat, at vehicle seat crease, until entire ball is in green zone. Then re-check level indicator.

NOTE: Vehicle **must** be on level ground and child in car seat when checking level indicator.

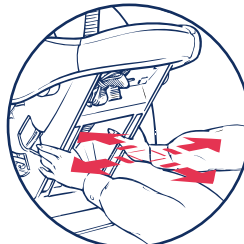
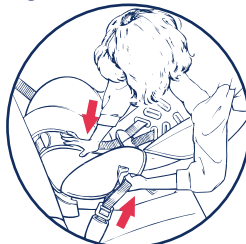
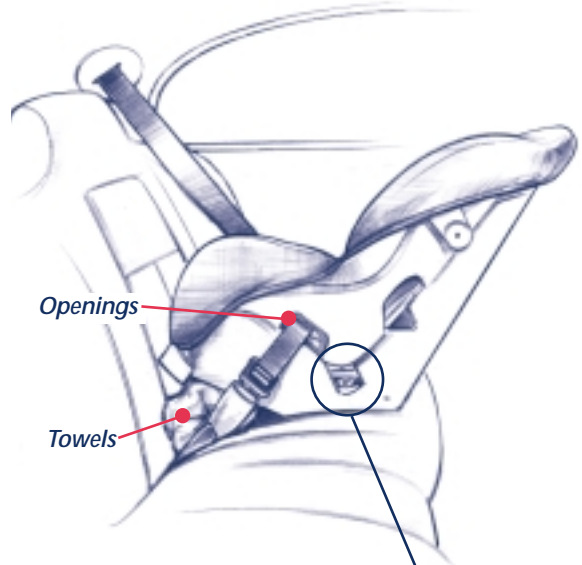

FORWARD-FACING INSTALLATION

- 1 Adjust car seat to **upright** position and place **forward-facing** on vehicle seat.
- 2 Lift seat pad flap (available on some models). Thread vehicle seat belt through openings. Buckle belt (*fig. a*).
- 3 Press down firmly in center of car seat to compress vehicle seat cushion while tightening vehicle seat belt.

HINT: Use your knee to press down in center of car seat (*fig. b*).

- 4 Pull front to back and left to right to check for secure installation (*fig. c*). Vehicle lap belt **MUST** stay tight.

If not secure, see "Vehicle Seat Belts" section.

- 5 Attach tether strap hook (A) to anchor hardware (B) and tighten strap to remove any slack (*fig. d*).
If tether anchor hardware (B) is not available, see "Installation of Anchor Hardware" section.

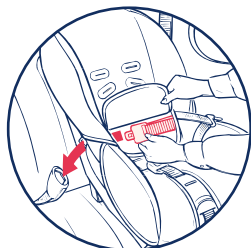
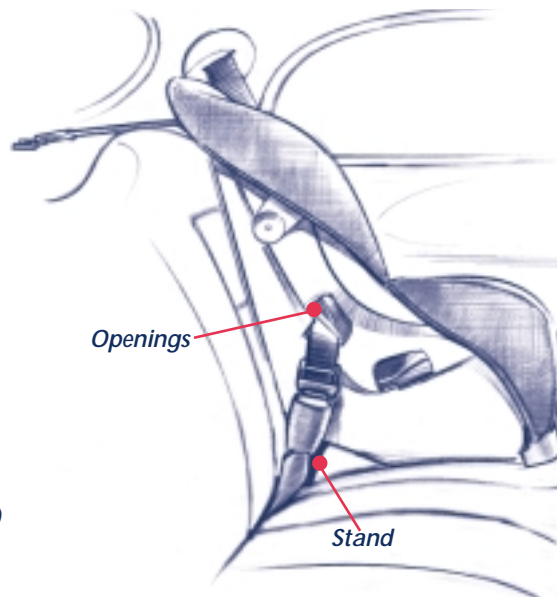

(fig. a)

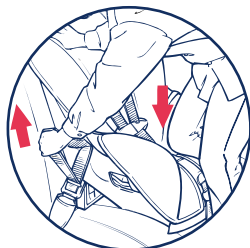

(fig. b)

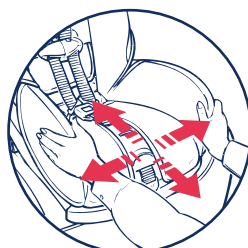

(fig. c)

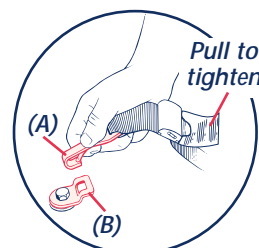

(fig. d)

PLACING CHILD IN CAR SEAT

WARNING

To prevent serious injury or death:

- Keep harness straps snug and positioned on shoulders.
- Do not use strap covers, blankets cushions, or padding under harness straps or child unless provided by Century or Graco.
- Child must be dressed in clothing with arms and legs that will not interfere with buckling harness.

Check harness system:

- **Rear-facing** - Harness straps must be through bottom or middle slots **at** or **below** shoulders.
- **Forward-facing** - Harness straps must be through middle or top slots **at** or **above** shoulders.
DO NOT use middle slots for child over 30 lbs. (13.6 kg).

5-Point Models Only:

- Crotch strap **must** be in opening closest to but not under child.

Overhead Shield Models Only:

- Harness tongue **must** be in opening closest to but not under child.

5-Point Models Only:

Place harness straps tongues in Twist Guards (available on some models) (*fig. a*).

- 1 Place child in car seat with child's back flat against back of car seat.
- 2 Remove harness straps from Twist Guards (*fig. a*) and place over child's shoulders and insert tongue(s) into buckle.

Pull up on tongue(s) to be sure they are locked.

- 3 Close harness tie:
Position harness tie at arm pit level.
- 4 Adjust harness straps to be snug with just enough room to insert one finger between child's chest and harness straps (*fig. b*).
For 5-Point models, check that harness straps on chest and **thighs** are snug.
- 5 A rolled towel can be used on each side to support small children (*fig. c*). Be sure towels do not interfere with harness system.

PLACING CHILD IN CAR SEAT (continued)

5-Point Models

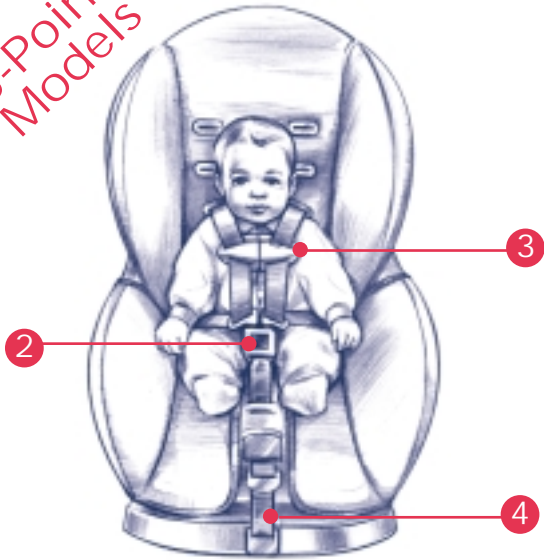

Overhead Shield Models

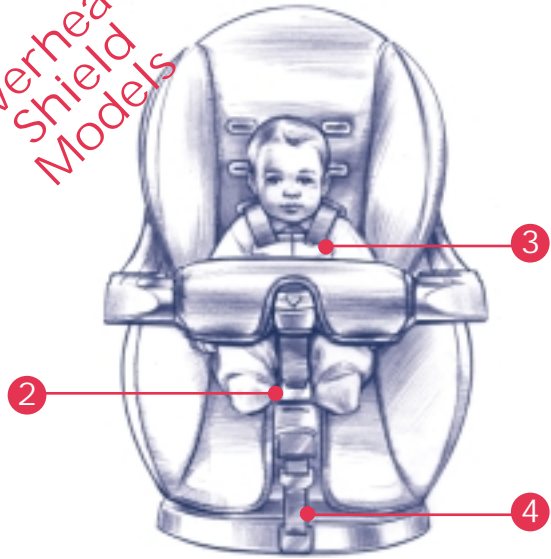

Twist Guards

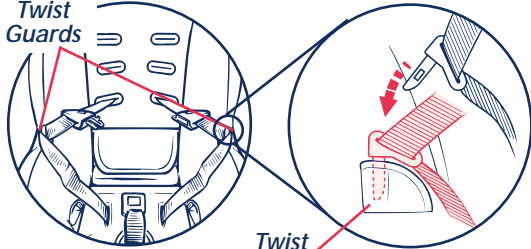

(fig. a)

Twist Guards



(fig. b)



(fig. c)

OPERATIONS and ADJUSTMENTS

1 **Harness Straps (fig. a):**

- To tighten: Pull lower belt tab.
- To loosen: Pull and hold upper belt tab while pulling harness straps.

2 **Harness Tie:**

- To open: Press tab and pull apart.
- To close: Snap halves together. Make sure harness tie is locked by pulling out on each half.

3 **Buckle:**

MUST be in opening closest to but not under child.

5-Point Models

- To buckle: Insert both tongues into buckle. Pull up on tongues to be sure they are locked.
- To unbuckle: Press red button and pull tongues out of buckle.

Overhead Shield Models

- To buckle: Push tongue into opening. Pull up on tongue to be sure it is locked.
- To unbuckle: Press red button, pull tongue out of opening and lift shield over top of car seat.

4 **Recline / Upright Positions (fig. b):**

Rear-facing - **MUST use Recline position.**

Forward-facing - **MUST use Upright position**

Upright Position: Rotate stand out and push into car seat (**fig. b**).

Recline Position: Pull stand out and rotate into car seat.

Harness straps **MUST** move freely. Make sure harness straps are not pinched by recline stand.

5 **5-Point Crotch Strap Adjustment (fig. c):**

- From bottom of car seat, pull crotch strap clip out and remove clip from crotch strap loop.
- From top of car seat, pull crotch strap out and thread through desired slot. Make sure red button is facing away from child.
- From bottom of car seat, re-attach clip to crotch strap loop exactly as shown.

6 **Overhead Shield Adjustment (fig. d):**

- To adjust: Press button down and slide shield to desired position closest to child. Release button to lock shield into one of 5 positions.

NOTE: Shield does not need to contact child when in closest position; harness system restrains child.

OPERATIONS and ADJUSTMENTS (continued)

5-Point Models

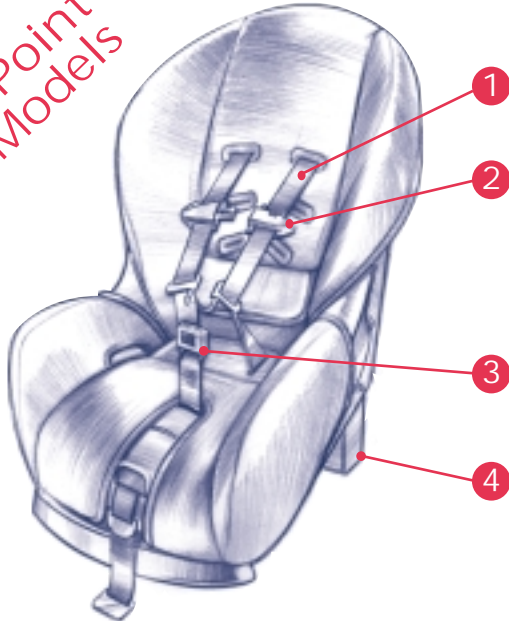

Overhead Shield Models

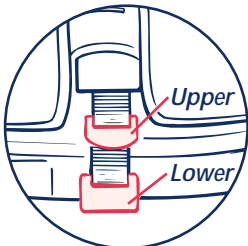
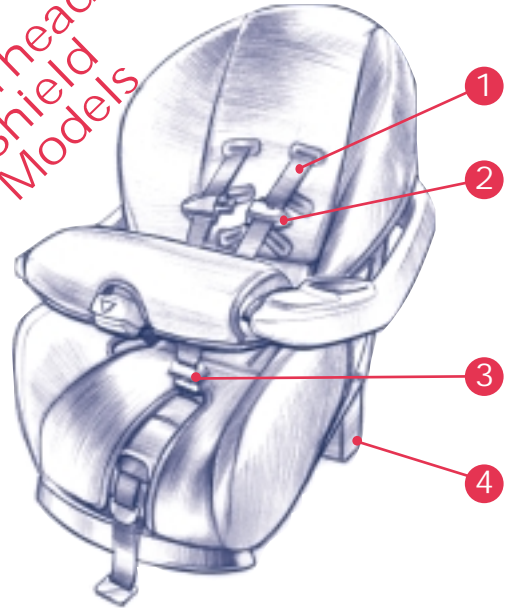

(fig. a)

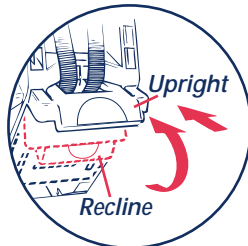

(fig. b)

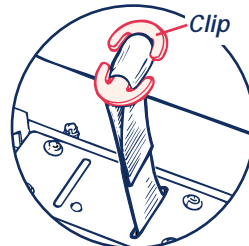

(fig. c)

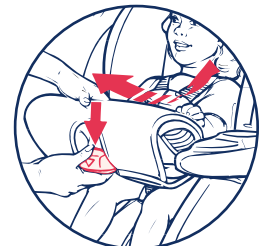

(fig. d)

OPERATIONS and ADJUSTMENTS (continued)

7 Changing Harness Strap Slots:

A Loosen harness straps:

Pull and hold upper belt tab.

Pull harness straps out.

B Remove both harness strap loops from Splitter Plate on back of car seat.

C Change harness strap slots.

Make sure harness straps are threaded through matching slot of seat pad and car seat.

It may be necessary to remove seat pad from top of car seat.

D Re-attach harness strap loops to Splitter Plate:

5-Point Models (fig. e):

- *For Infants or Small Toddlers:*

Put **Top** right strap loop on Splitter Plate first, then attach **Top** left strap loop.

NOTE: Make sure ends of straps are behind Splitter Plate.

- *For Toddlers:*

Put **Bottom** right strap loop on Splitter Plate first, then attach **Bottom** left strap loop.

Overhead Shield Models (fig. f):

Put right strap loop on Splitter Plate first, then attach left strap loop.

NOTE:

- Make sure both strap loops are securely attached within Splitter Plate hook.
- Make sure straps are **NOT** twisted and are routed behind stand (*fig. g*).

OPERATIONS and ADJUSTMENTS (continued)

5-Point Models

Overhead Shield Models

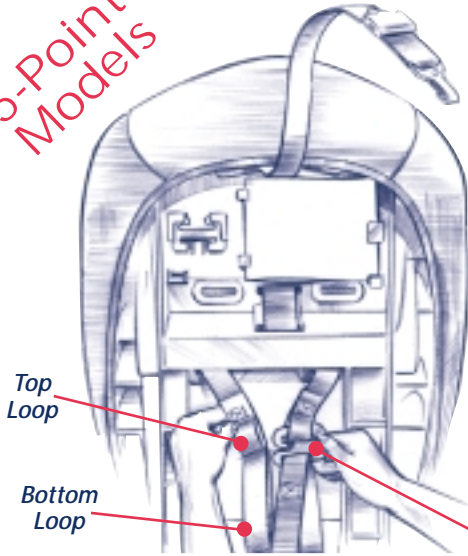

(fig. e)

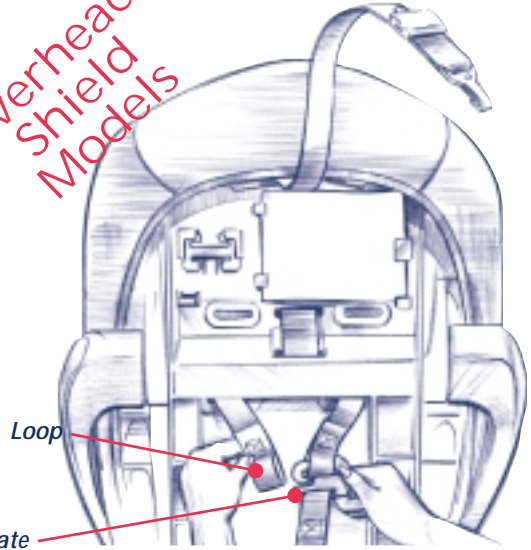

(fig. f)

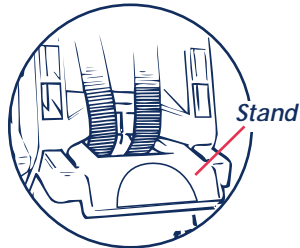

(fig. g)

VEHICLE SEAT BELTS

WARNING

Not all vehicle seat belts can be used with a car seat. The car seat must be held securely at all times by a lap belt (or lap belt portion of a lap/shoulder belt) that will not change length while driving.

To provide the most secure installation of the car seat:

- Read the vehicle owner's manual regarding car seat installation and seat belt use with car seat.
- Follow all instruction labels on vehicle seat belt and car seat.

If car seat is not held securely after following instructions in this manual, vehicle seat belt labels, and vehicle owner's manual:

- Move car seat to another seating location and try again, or
- Contact vehicle dealer for possible seat belt modification parts.

VEHICLE SEAT BELTS (continued)

Belts Forward of Seat Crease

Vehicle seat belts located forward of seat crease may not securely hold car seat. Check vehicle owner's manual or see vehicle dealer for car seat installation requirements.

- *If approved for use with car seat, install car seat and check for secure installation by pulling car seat front to back. If car seat slides forward, DO NOT use these seat belts.*

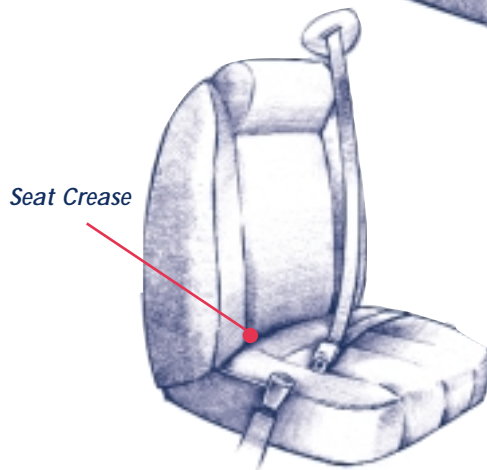
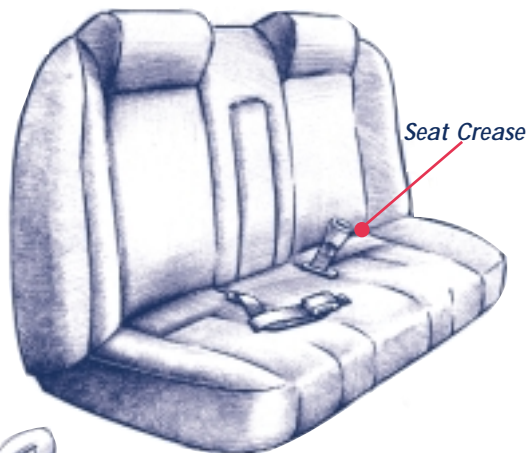

VEHICLE SEAT BELTS (continued)

✿ Lap Belts - Manually Adjustable

The locking latch plate on some seat belts may slip and loosen after being buckled on car seat if positioned at a certain angle. If this happens, flip latch plate over (*fig. a*) and re-buckle. Test installation again to see if this works. If not, move car seat to another seating position.

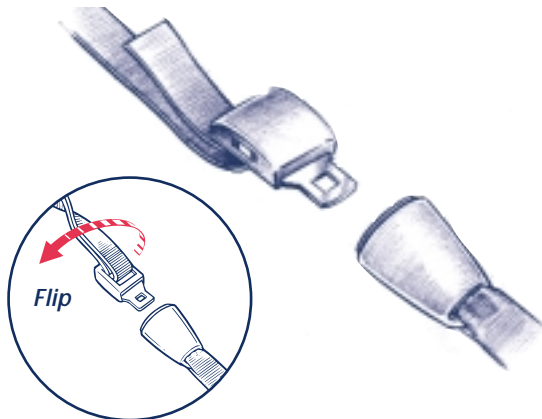

(fig. a)

✿ Lap Belts - With Retractor

Lap belts with retractors may or may not hold a car seat securely.

Follow these steps to determine if you have a retractor system that will hold car seat securely:

- Pull belt all the way out.
- Allow belt to retract about 6 inches (15 cm).
- Pull out on belt again.

If belt is locked and you **cannot** pull the belt out any further, you have an Automatic Locking Retractor which may be used with a car seat. Remember, when installing a car seat, pull belt all the way out, buckle belt, and then tighten.

If you **can** pull the belt out again (step c), you have an Emergency Locking Retractor which **must not** be used with a car seat.

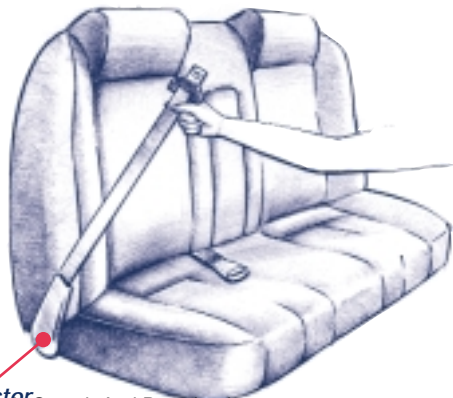

VEHICLE SEAT BELTS (continued)

✿ Passive Restraint - Lap Belt with Motorized Shoulder Belt

DO NOT use with any car seat.

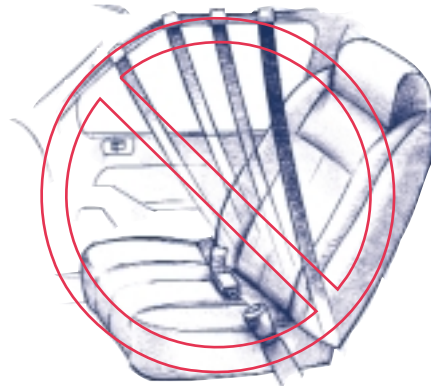

✿ Passive Restraint - Lap or Shoulder Belt Mounted on Door

DO NOT use with any car seat. Belts will not stay tight while driving.

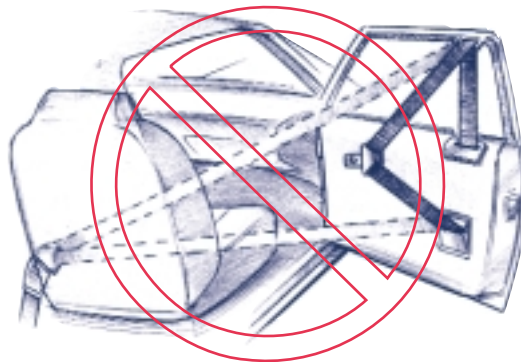

VEHICLE SEAT BELTS (continued)

✿ Combination Lap/Shoulder Belt with Sliding Latch Plate

Pull on latch plate (*fig. a*). If belt slides freely through latch plate, a locking clip **MUST** be used (see Locking Clip section).

Some combination lap/shoulder belts with sliding latch plates may be converted into an “*automatic locking mode*” that will allow use without a locking clip. See vehicle owner’s manual and label on vehicle belts for instructions.

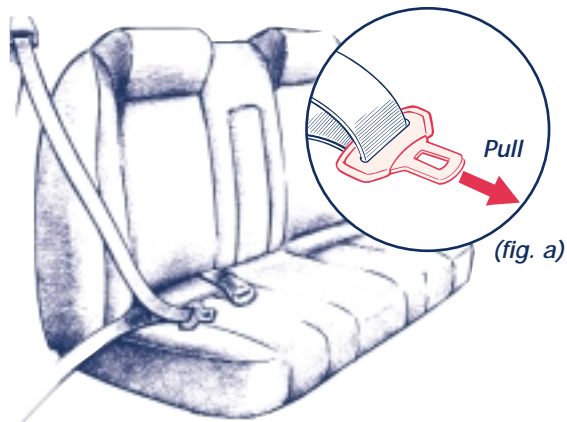

✿ Combination Lap/Shoulder Belt with Locking Latch Plate

The locking latch plate on some seat belts may slip and loosen after being buckled on car seat if positioned at a certain angle. If this happens, flip the latch plate over (*fig. b*) and re-buckle. Test installation again to see if this works. If not, move car seat to another seating position.

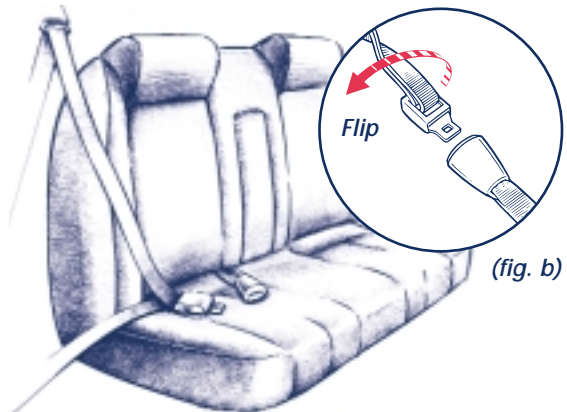

VEHICLE SEAT BELTS (continued)

Locking Clip

⚠ WARNING

Avoid serious injury or death:

- Failure to use locking clip where required will result in car seat not being securely held in place.
- Remove locking clip from seat belts when not being used with car seat.
- DO NOT use locking clip as a vehicle seat belt shortener.

You **MUST** use locking clip provided with car seat with a vehicle seat belt that slides freely through the latch plate or the lap belt cannot be tightly secured.

- 1 Install car seat and tighten vehicle seat belt.
- 2 Hold seat belts together at latch plate (*fig. a*) then unbuckle.
- 3 Slide locking clip on seat belts approximately 1/2 inch (1 cm) away from latch plate.
- 4 Re-buckle seat belt.

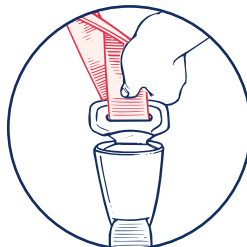

(*fig. a*)

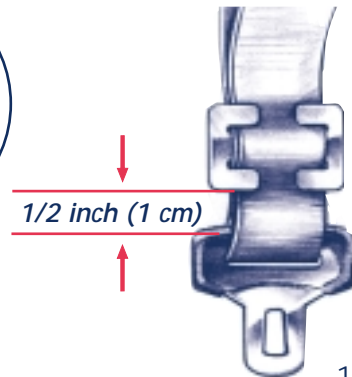

- 5 Test installation to see if car seat is secure.

If not secure, additional belt tightening may be required:

- Unbuckle vehicle seat belt.
- Hold belts together and remove locking clip.
- Shorten length of lap belt portion slightly by pulling belt through latch plate.
- Re-attach locking clip.
- Buckle vehicle seat belt.

HINT: Press car seat further down into vehicle seat cushion to help buckle vehicle seat belt.

Test installation to see if car seat is secure. If not secure, repeat above step until secure.

ADDITIONAL INFORMATION

Installation of Anchor Hardware

Vehicle may already be equipped with a tether anchor (top strap anchor). See vehicle owner's manual for location.

If vehicle does not have a tether anchor, one must be installed:

- Contact vehicle dealership for proper anchor location and installation.
- Before installing anchor, install car seat on a vehicle seat and check that the lap belt portion of the vehicle belt will hold car seat securely. If not, move car seat to another seating position.

If tether anchor hardware kit is not available at your vehicle dealership, one may be purchased at a local retailer or call Century at 1-800-837-4044.

WARNING

Avoid serious injury or death:

- Be sure anchor hole is properly sealed to prevent exhaust fumes and water from entering the vehicle.
- If you wish to remove anchor once child outgrows car seat, make sure hole is properly plugged or sealed to prevent exhaust fumes from entering the vehicle.

ADDITIONAL INFORMATION (continued)

Tether Storage

DO NOT anchor tether strap to the vehicle when using car seat **rear-facing**.

Tether hook must be attached to car seat for **rear-facing** use.

For storage of tether hook:

- Attach tether hook to back of car seat as shown.
- Pull loose end of strap to remove any slack.
- Roll loose end of strap up and secure with a rubber band.

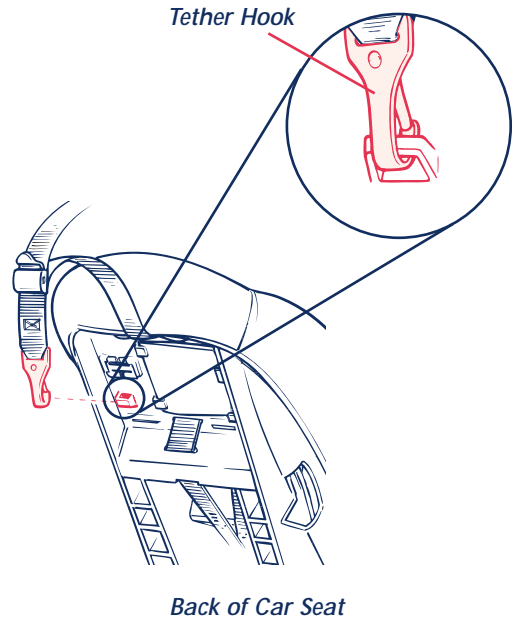

ADDITIONAL INFORMATION (continued)

Care & Cleaning

Removing Seat Pad:

Remove both harness strap loops from Splitter Plate on back of car seat and remove harness system from car seat.

- 1 Unhook "J" hooks from car seat shell.
- 2 Pull 2 button clips out of lower front edge of car seat and car seat shell.
- 3 Remove harness straps from splitter plate (see page 12 & 13).

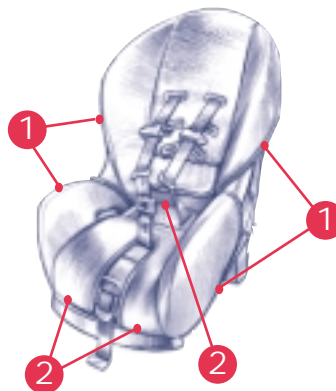

Removing Overhead Shield Pad:

- 4 Pull 2 button clips out of shield and unwrap pad from around shield.

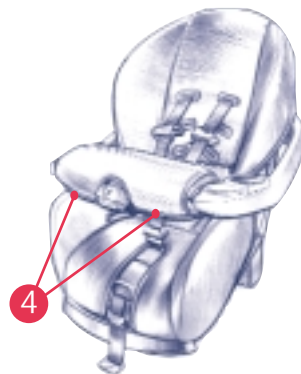

Reverse above steps for replacing seat pad, overhead shield pad and harness system.

Seat Pad and Overhead Shield Pad:

Machine-wash separately on gentle cycle and drip dry.

Harness Straps:

Surface wash only with mild soap and damp cloth.

If harness straps are frayed or heavily soiled, they **MUST** be replaced.

Shell and Overhead Shield Cup Holder:

Wipe with mild solution of soap and water. Avoid wetting labels.

Never use “household detergents”: they can weaken plastic.

Buckle:

Rinse buckle with warm water. **DO NOT** use household detergents. Never lubricate buckle.

WARNING

Prevent serious injury or death:

- Buckle must be properly latched.
- Periodically inspect and clean buckle to remove objects or debris that could prevent latching.

Aircraft Use

This car seat is certified for use on aircraft (see label on car seat). Contact airline about their policy.

Use this car seat only on forward-facing aircraft seats.

Install car seat on an aircraft the same way it is installed in a vehicle.

Second Hand Car Seat

Century advises against loaning or passing along car seat.

1 Fold instruction manual.



2 Store instruction manual behind these tabs.

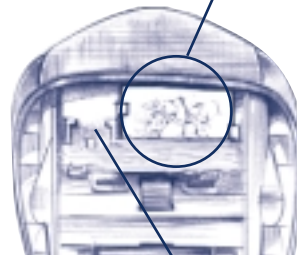

If a part is damaged, missing, or you need help or replacement parts, **DO NOT** return car seat to the store.

CALL US FIRST

Call toll-free 1-800-837-4044
from anywhere in the U.S. or Canada
or fax at 1-610-286-4555.

or write us at:

Century Products
P.O.Box 100
Elverson, PA 19520-9974

Attention: Customer Service
Department

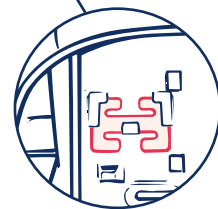

Store Locking Clip
here.



Free Manuals Download Website

<http://myh66.com>

<http://usermanuals.us>

<http://www.somanuals.com>

<http://www.4manuals.cc>

<http://www.manual-lib.com>

<http://www.404manual.com>

<http://www.luxmanual.com>

<http://aubethermostatmanual.com>

Golf course search by state

<http://golfingnear.com>

Email search by domain

<http://emailbydomain.com>

Auto manuals search

<http://auto.somanuals.com>

TV manuals search

<http://tv.somanuals.com>