

Portable DVD Player

7" Widescreen TFT LCD Portable DVD/CD/MP3 Player

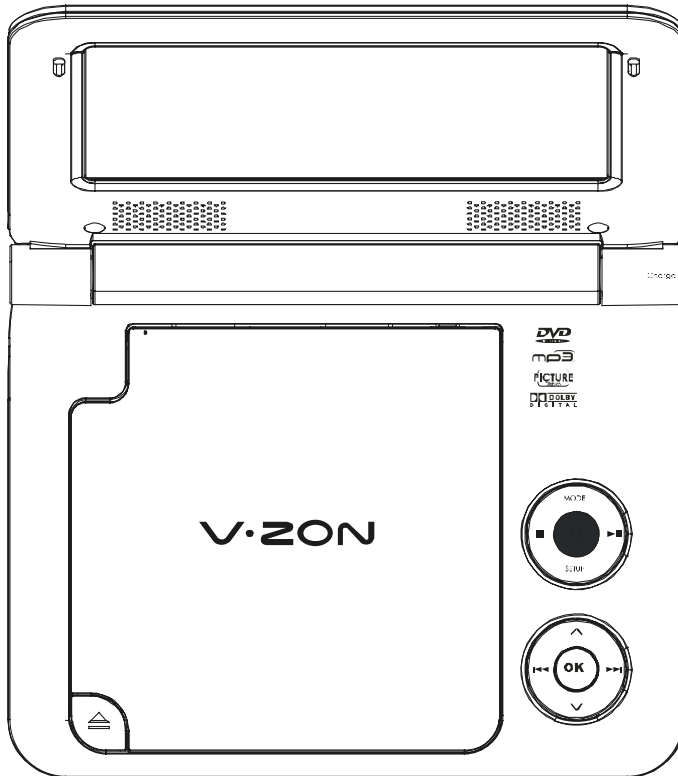

7009ZR



Instruction Manual

Please read this manual carefully before operation.

PRECAUTIONS

	CAUTION RISK OF ELECTRIC SHOCK DO NOT OPEN	
CAUTION: TO REDUCE THE RISK OF FIRE AND ELECTRIC SHOCK, DO NOT REMOVE THE COVER (OR BACK) OF THE UNIT. REFER SERVICING ONLY TO QUALIFIED SERVICE PERSONNEL.		

For Customer Use:

Enter below the serial number that is located on the bottom of the unit. Retain this information for future reference.

Model No. TF-DVD7009

Serial No. _____



The lightning flash with arrowhead symbol within an equilateral triangle is intended to alert the user to the presence of uninsulated "dangerous voltage" within the product's enclosure that may be of sufficient magnitude to constitute a risk of electric shock.



The exclamation point within an equilateral triangle is intended to alert the user to the presence of important operation and servicing instructions in the literature accompanying the appliance.

WARNING:

To prevent fire or shock hazard, do not expose this device to rain or moisture. Dangerous high voltage is present inside the enclosure. Do not open the cabinet.

Handling the cords on this product will expose you to lead, a chemical known to the State of California to cause cancer, and birth defects or other reproductive harm. Wash hands after handling.

CAUTION:

This Digital Video Disc player employs a laser system. To prevent direct exposure to the laser beam, do not try to open the enclosure or defeat the safety interlocks. When open and the interlocks are defeated, visible laser radiation is present. To prevent electric shock, match wide blade of plug to wide slot of outlet and fully insert.

Use of controls, adjustments, or performance of procedures other than those specified herein may result in hazardous radiation exposure. **DO NOT STARE INTO THE BEAM.**

NOTICE:

This product incorporates copyright protection technology that is protected by U.S. patents and other intellectual property rights. Use of this copyright protection technology must be authorized by Macrovision, and is intended for home and other limited viewing uses only unless otherwise authorized by Macrovision. Reverse engineering or disassembly is prohibited.

FCC Notice:

FCC Statement: this device complies with Part 15 of the FCC Rules. Operation is subject to the following two conditions:

(1) This device may not cause harmful interference, and (2) This device must accept any interference received, including interference that may cause undesired operation.

Note: This equipment has been tested and found to comply with the limits for Class B digital devices, pursuant to Part 15 of the FCC rules. These limits are designed to provide reasonable protection against harmful interference in a residential installation. This equipment generates, uses and can radiate radio frequency energy and, if not installed and used in accordance with the instructions, may cause harmful interference to radio communications. However, there is no guarantee that interference will not occur in a particular installation. If this equipment does cause harmful interference to radio or television reception, which can be determined by turning the equipment off and on, the user is encouraged to try to correct the interference by one or more of the following measures:

- Reorient or relocate the receiving antenna.
- Increase the separation between the equipment and receiver.
- Connect the equipment into an outlet on a circuit different from that to which the receiver is connected.
- Consult the dealer or an experienced radio/TV technician for help.

Use of shielded cable is required to comply with Class B limits in Subpart B of Part 15 of the FCC rules.

PRECAUTIONS

Do not make any changes or modifications to the equipment unless otherwise specified in the manual. If such changes or modifications should be made, you could be required to stop operation of the equipment.

CPRM

Content Protection for Removable Media (CPRM) is a hardware-based technology designed to enforce copy protection restrictions through built-in mechanisms in storage media that would prevent unauthorized file copying.



This player has built-in copyright protection technology that prevents copying from a DVD disc to any media.

If a video recorder is connected to the player, the video output image will be distorted during recording.

Manufactured under license from Dolby Laboratories. Dolby and the double-D symbol are trademarks of Dolby Laboratories. Confidential Unpublished Works.
© 1992-1997 Dolby Laboratories. All rights reserved.



For recycling or disposal information about this product, please contact your local authorities or the Electronics Industries Alliance: www.eiae.org.

IMPORTANT SAFETY INSTRUCTIONS

1. **Read Instructions:** All the safety and operating instructions should be read before the product is operated.
2. **Retain Instructions:** The safety and operating instructions should be retained for future reference.
3. **Heed Warnings:** All warnings on the product and in the operating instructions should be adhered to.
4. **Follow Instructions:** All operating and usage instructions should be followed.
5. **Cleaning:** Unplug this product from the wall outlet before cleaning. Do not use liquid cleaners or aerosol cleaners. Use a damp cloth for cleaning.
6. **Attachments:** Use only attachments recommended by the manufacturer. Use of other attachments may be hazardous.
7. **Water and Moisture:** Do not use this product near water (e.g., near a bath tub, washbowl, kitchen sink, laundry tub, in wet basements, or near a swimming pool and the like).
8. **Heat:** The product should be situated away from heat sources such as radiators, heat registers, stoves, or other products (including amplifiers) that produce heat.
9. **Accessories:** Do not place this product on an unstable cart, stand, tripod, bracket, or table. Use only with carts, stands, tripods, brackets, or tables recommended by the manufacturer or sold with the product. Any mounting of the product should follow the manufacturer's instructions and should use a mounting accessory recommended by the manufacturer.
10. A product and cart combination should be moved with care. Quick stops, excessive force, and uneven surfaces may cause the product and cart combination to overturn.
11. **Ventilation:** Slots and openings in the cabinet are provided for ventilation to ensure reliable operation of the product and to protect it from overheating. These openings should never be blocked by placing the product on a bed, sofa, rug, or other similar surface. This product should not be placed in a built-in installation such as a bookcase or rack unless proper ventilation is provided or the manufacturer instructions have been adhered to.
12. **Power Sources:** This product should be operated only from the type of power source indicated on the rating label. If you are not sure of the type of power supply to your home, consult your product dealer or local power company. For products intended to operate from battery power or other sources, refer to the operating instructions.
13. **Power Sources:** Do not connect the power plug to a power outlet other than that which is indicated here and on the label as this may result in the risk of fire or electric shock. Do not handle the power plug with wet hands. Doing so may cause electric shock.
14. **Power Lines:** An outside antenna system should not be located in the vicinity of overhead power lines or other electric light or power circuits, or where it can fall into such power lines or circuits. When installing an outside antenna system, extreme care should be taken to keep from touching such power lines or circuits, as contact with them might be fatal.
15. **Battery:** Danger of explosion if battery is incorrectly replaced. Replace only with the same or equivalent type. Battery pack or batteries installed shall not be exposed to excessive heat such as sunshine, fire or the like.
16. **12V Car Power Adaptor:** Disconnect this car power adaptor when not in use. Not for use in 24V vehicles.
17. **Using the unit in a Vehicle :** On no account should this unit be used by the driver of a moving



IMPORTANT SAFETY INSTRUCTIONS

motor vehicle, or left unsecured in the vehicle whilst driving. If this unit is being used by a passenger in your vehicle, be sure that it is secured or held safely, and does not obstruct any safety device (i.e. airbag, seat belt etc.) that is fitted. All passengers should wear seat belts when using this unit in a moving vehicle. If in doubt, please contact your vehicle manufacturer for further advice. Using other car power adaptors could damage the unit.

18. Using Headphones or Earphones: Hearing experts advise against the constant use of personal stereos played at high volume. Constant high volume use can lead to hearing loss. If you experience ringing in the ears or hearing loss, discontinue use and seek medical advice.
19. Grounding or Polarization: This product may be equipped with a polarized alternating-current line plug that has one blade wider than the other. This plug will only fit into the power outlet in one direction. This is a safety feature. If you are unable to insert the plug fully into the outlet, try reversing the direction of the plug. If the plug should still fail to fit, contact an electrician to replace the obsolete outlet. Do not defeat the safety purpose of the polarized plug.
20. Power-Cord Protection: Power supply cords should be routed so that they are not likely to be walked on or pinched by items placed upon or against them, paying particular attention to cords at plugs, convenience receptacles, and at the point which they exit from the product.
21. Protective Attachment Plug: The product may be equipped with an attachment plug with overload protection. This is a safety feature. See the operating instructions for replacement or directions to reset the protective device. If replacement of the plug is required, be sure the service technician has used a replacement plug that has the same overload protection as the original plug as specified by the manufacturer.
22. Outdoor Antenna Grounding: If an outside antenna is connected to the product, be sure the antenna system is grounded so as to provide some protection against voltage surges and built-up static charges. Article 810 of the National Electrical Code, ANS/NFPA 70 provides information with regard to proper grounding of the mast and supporting structure, grounding of the lead-in wire to an antenna-discharge unit, size of grounding conductors, location of antenna-discharge unit, connection to grounding electrodes, and requirements for the grounding electrode (see figure).

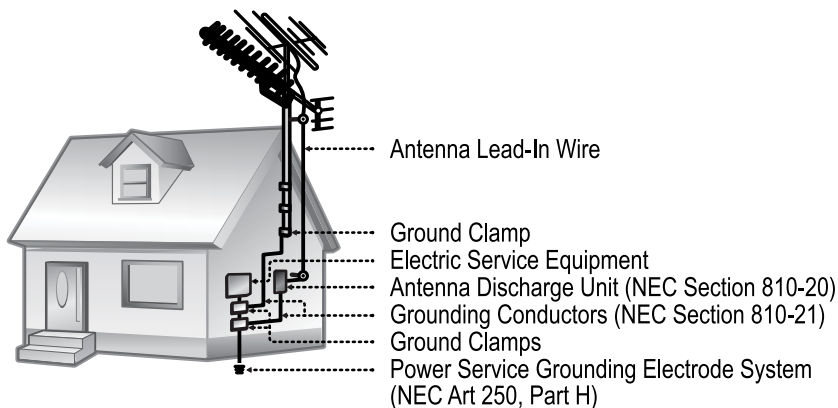

23. Lightning: For added protection for this product, unplug it from the wall outlet and disconnect the antenna or cable system during a lightning storm or when it is left unattended and unused

IMPORTANT SAFETY INSTRUCTIONS

for long periods of time. This will prevent damage to the product due to lightning or power-line surges.

24. If at any time in the future you should need to dispose of this product please note that Waste electrical products should not be disposed of with household waste. Please recycle where facilities exist. Check with your Local Authority or retailer for recycling advice. (Waste Electrical and Electronic Equipment Directive) 
25. Overloading: Do not overload wall outlets, extension cords, or integral convenience receptacles as this can result in a risk of fire or electric shock.
26. Object and Liquid Entry: Never push objects of any kind into this product through openings as they may touch dangerous voltage points or short-out parts that could result in a fire or electric shock. Never spill liquid of any kind on the product.
27. Servicing: Do not attempt to service this product yourself as opening or removing covers may expose you to dangerous voltage or other hazards. Refer all servicing to qualified service personnel.
28. Damage Requiring Service: Unplug this product from the wall outlet and refer servicing to qualified service personnel under the following conditions: a) when the power-supply or plug is damaged; b) if liquid has been spilled or if objects have fallen into the product; c) if the product has been exposed to rain or water; d) if the product does not operate normally by following the operating instructions. Adjust only those controls that are covered by the operating instructions as improper adjustment of other controls may result in damage and will often require extensive work by a qualified technician to restore the product to its normal operation; e) if the product has been dropped or damaged in any way; f) when the product exhibits a distinct change in performance—this indicates a need for service.
29. Replacement Parts: When replacement parts are required, be sure that your service technician has used replacement parts specified by the manufacturer or have the same characteristics as the original part. Unauthorized substitutions may result in fire, electric shock, or other hazards.
30. Safety Check: Upon completion of any service or repairs to this product, ask the service technician to perform safety checks to ensure that the product is in proper operating condition.
31. Wall or Ceiling Mounting: The product should be mounted to a wall or ceiling only as recommended by the manufacturer.

TABLE OF CONTENTS

PRECAUTIONS	2
IMPORTANT SAFETY INSTRUCTIONS	4
TABLE OF CONTENTS	7
PACKAGE CONTENTS	9
ABOUT OPTICAL DISCS	10
Disc Requirements	10
Disc Care and Maintenance	10
Handling a Disc	10
Cleaning a Disc	10
LOCATION OF CONTROLS	11
Front View	11
Right View	12
Left View	12
Bottom View	12
Remote Control	13
CONNECTIONS	14
Audio & Video Connections	14
USB Connection	14
Headphone Connection	14
Power Connection	15
Connecting to the wall outlet	15
Using the car plug	15
Using the Built- in battery	15
GETTING STARTED	16
Using the Remote Control	16
Power Supply	16
BASIC OPERATIONS	17
Basic Playback	17
Play/Pause/Stop	17
Next /Previous (Skip)	17
Forward/Reverse (Search)	17
Slow	17
Menu Navigation	17
Numeric Keypad	18
Adjusting the Volume	18
Disc Error Messages	18
Power Management	18
FUNCTION BUTTONS	19
Display / Setup	19
Zoom	19
Multi-Subtitle / Audio / Angle	19
Menu / Title	19

TABLE OF CONTENTS

Repeat A-B Mode	19
Repeat Playback of a chapter / Title / All of a Disc	19
LCD Menu	20
SETUP	21
Language	21
Video	21
Audio	22
Rating	22
Misc	22
SPECIFICATIONS	23
TROUBLESHOOTING	24

PACKAGE CONTENTS

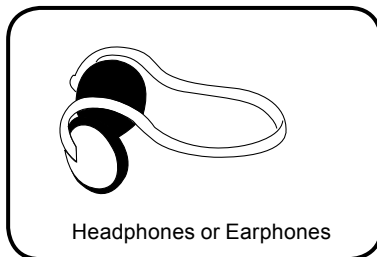
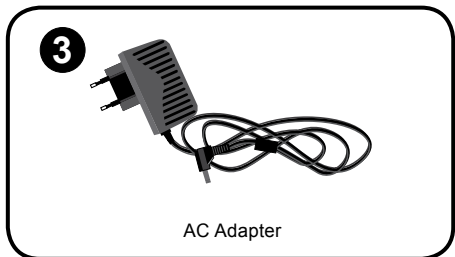
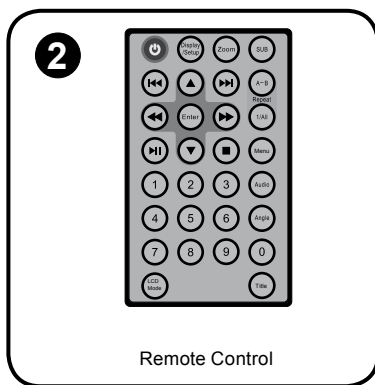
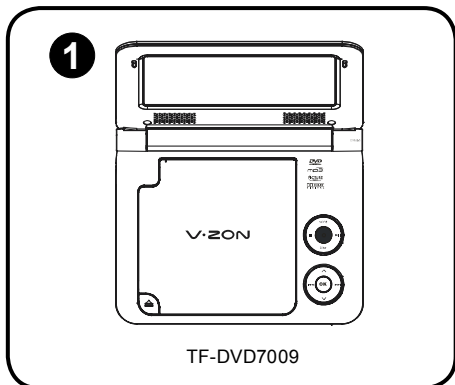

Please make sure the following items are included in the package. If any items are missing, please contact your local dealer.



ABOUT OPTICAL DISCS

Disc Requirements

This DVD player supports playback of the following discs.

Type	Disc Mark	Content Type	Disc Size	Max. Playback Time
DVD-Video Discs		Audio + Video (moving picture)	12 cm	133 min (SS-SL)
				242 min (SS-DL)
				266 min (DS-SL)
				484 min (DS-DL)
Audio Compact Discs (CDs)		Audio	12 cm	74 min
JPEG CDs	--	Still Picture	12 cm	--

This unit can play back CD-R and CD-RW discs that contain JPEG picture files. Discs not listed above are not supported by this unit (eg, PC CD-ROM, CD-Extra, CD-G, CD-I, etc.)

Disc Care and Maintenance

Optical discs (DVDs, CDs) contain high-density compressed data and need proper handling.

Handling a Disc

- Hold a DVD/CD by its edges. Avoid touching the recorded side of the disc. To remove a DVD/CD from its storage case, press down on the center retention mechanism of the case and lift the disc out.
- Do not subject discs to prolonged exposure to direct sunlight, high humidity, or high temperatures.
- Do not bend or press discs.
- To reduce the risk of scratches, always put discs back in their case after use. Store discs vertically in a cabinet.
- Do not place stickers or labels on either side of a disc.

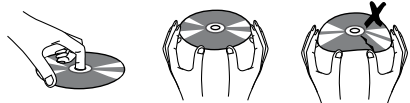

Cleaning a Disc

Use a dry, soft cloth to wipe off any fingerprints and dusts from the playing surface of the disc. Wipe in a straight line radially from the center to the outside edge of the disc. Small dust particles and light stains will not affect playback quality.

- Never use chemicals such as record sprays, anti-static sprays, benzene, or thinners to clean a disc. Doing so will damage the surface of the disc permanently.

LOCATION OF CONTROLS

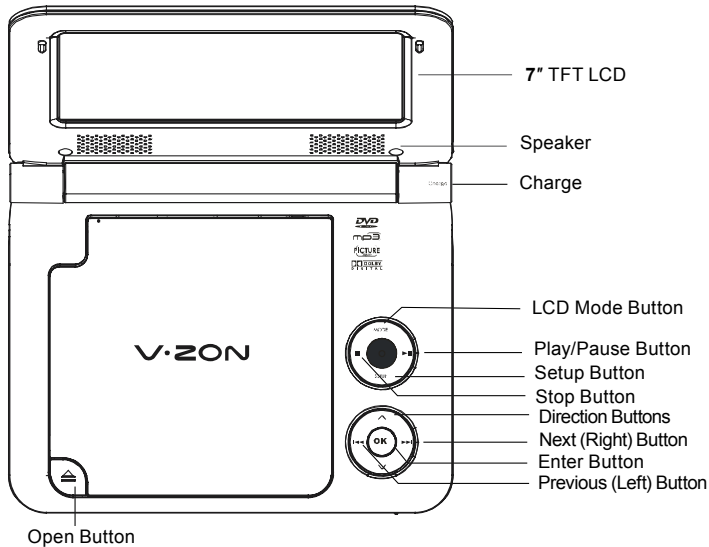

Front View

LCD Mode

- Briefly press this button to display the LCD menu.

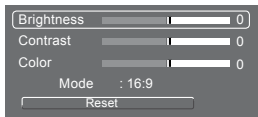

- Press up/down direction button to highlight item and then make adjustment by left/right direction button.
- Press up/down direction button to select Mode and then press the Enter button to toggle the screen dimension between 16:9 and 4:3.
- Select RESET and press ENTER to return the settings of brightness, contrast and color to their factory default settings.

Play/Pause button

To start/pause playback of a loaded disc.

Setup

To access the setup menu which various features of the player can be adjusted in.

Stop

Press once to prestop the playback, press twice to stop completely.

Direction / Enter buttons

Press the direction buttons to select an item and press the Enter button to confirm.

Fast Forward /Reverse

Press the Next button for a long time to skip forward one track.

Press the Previous button for a long time to skip back one track.

Press and hold the NEXT / PREVIOUS button to fast forward/reverse during video / audio playback.

LOCATION OF CONTROLS

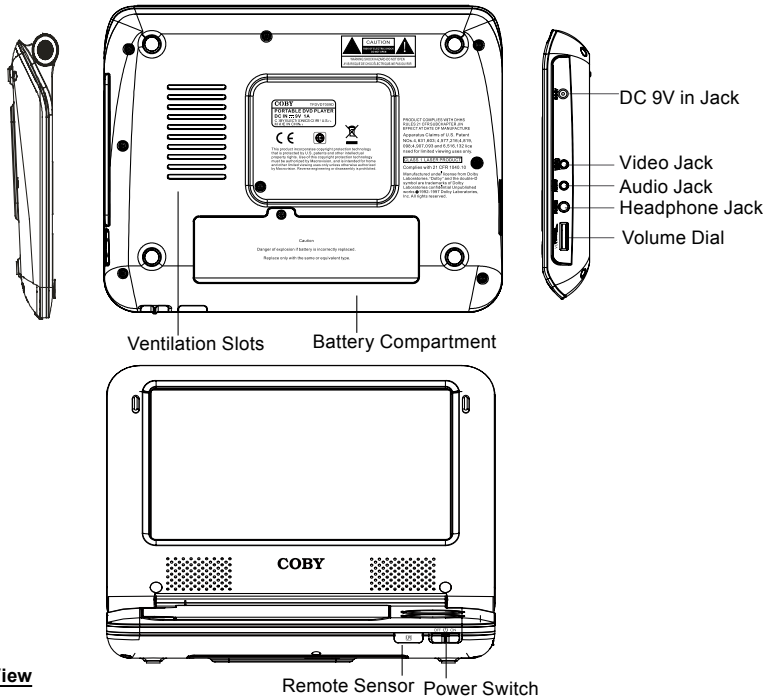

Right View

DC 9V IN Jack

To connect to the AC Adapter / DC 16V Car adapter for power supply.

Video Jack

To connect to an external TV screen by the AV cable.

Audio Jack

To connect to an external speaker system by the AV cable.

Headphone Jack

Volume Dial

To Adjust the Volume Level.

Bottom View

Ventilation Slots

Battery compartment

Front View

Power Switch

To turn on/off the unit.

Remote Sensor

LOCATION OF CONTROLS

Remote Control

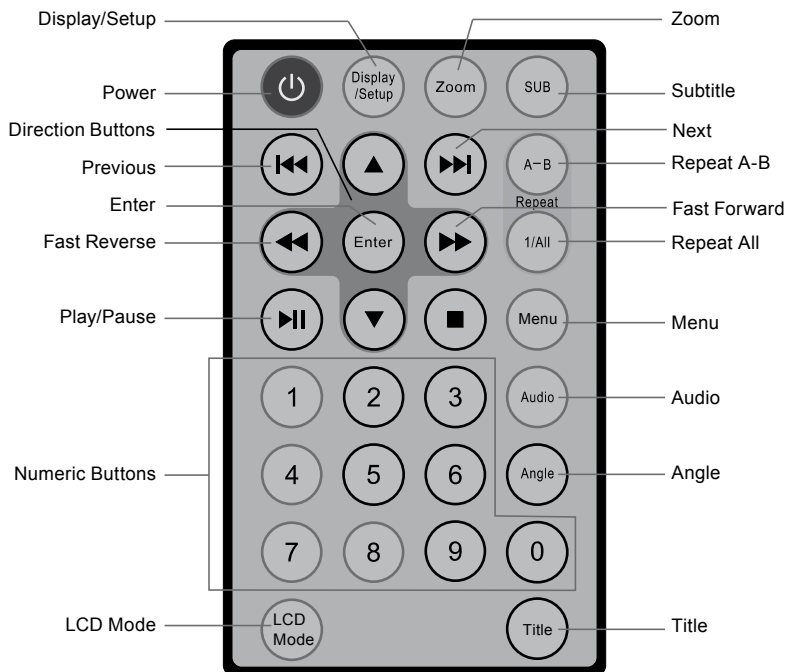

The remote control transmits a directional infrared beam. Be sure to aim the remote control directly at the infrared remote sensor during operation. The sensor may not be able to receive signals properly if the sensor is covered, if there is a large object between the remote control and the sensor, or if it is exposed to direct sunlight or a strong artificial light (e.g., fluorescent or strobe lights). In this case, change the direction of the light or reposition the unit to avoid direct lighting.

CONNECTIONS

Audio and Video Connections

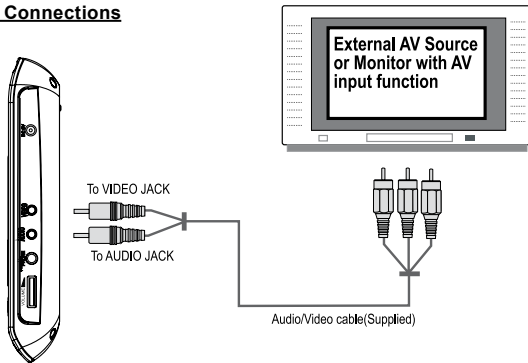

1. Refer to the owner's manual of the external device as well.
2. Before connecting the power source, ensure that all the connections are properly done.

Headphone Connection

Be sure that your unit is at low volume level before connecting the headphones. Increase the volume gradually for your comfortable listening.

CAUTION:

Hearing experts advise against the constant use of personal stereos played at high volume. Constant high volume use can lead to hearing loss. If you experience ringing in the ears or hearing loss, discontinue use and seek medical advise.

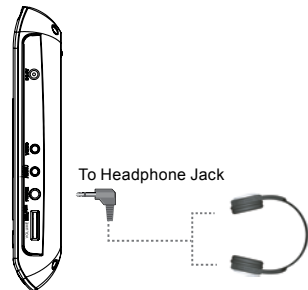

CONNECTIONS

Power Connections

- Connecting to the wall outlet

Caution:

- Do not connect the power plug to a power outlet other than that which is indicated here and on the label as this may result in the risk of fire or electric shock.
- Do not handle the power plug with wet hands. Doing so may cause electric shock.
- Only use AC adapters of the type specified here. Failure to do so may cause a fire or damage the player.

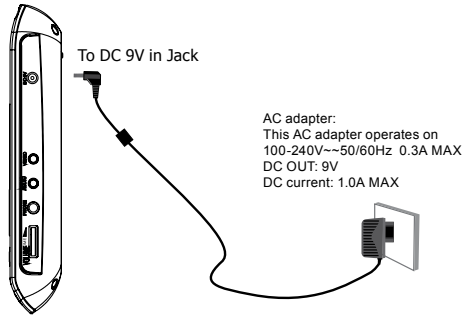

- Using the car plug

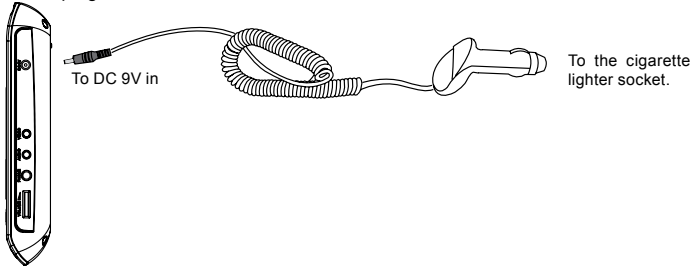

Disconnect this car power adaptor when not in use. Not for use in 24V vehicles.

Using the Built-in battery

The unit has a built-in rechargeable battery (lithium-polymer). Charge the built-in battery before using it for the first time. It takes about 4 hours to fully charge the battery.

- Make sure that the power switch is set to the Off position before charging.
- To charge the built-in battery, just connect the AC adapter to the player and a specified wall outlet. See above. (The Battery Charge indicator will light red while it is charging; it will go off when the battery is fully charged.)
- The built-in rechargeable battery can be used for approximately 300 charge-cycles without any noticeable change in performance.
- When the built-in battery power is low, the low battery icon will flash on the upper right corner of the screen for a while, and then the player will turn itself off automatically.

Note:

- Use the specified charger.
- Never dispose of in fire or heat up.
- Do not use in high temperature or near heat sources.
- Do not open the cover.
- Refer servicing only to qualified service personnel.
- To get the longest service life of the built-in battery, charge at indoor-temperature.

GETTING STARTED

Using the Remote Control

To load a battery in the remote:

1. Pull in the direction of the arrow.
2. Slide the compartment out.
3. Place the battery in the compartment with the positive side (+) facing up.
4. Push the compartment in to close.

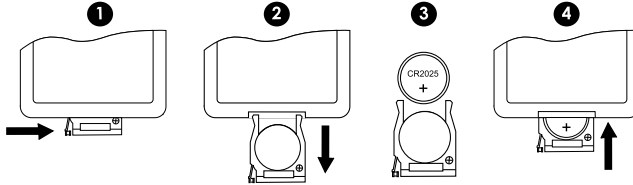

- Point the remote at the remote sensor of the photo frame at a distance of no more than 15' and at an angle no greater than 60 degrees.
- Batteries will last for about one year under typical usage.
- Replace the batteries if the remote is no longer working.
- Do not spill water on the remote control.
- Do not use the remote control for other equipment at the same time.
- Remove the batteries if the remote control will not be in use for an extended period of time.

Power Supply

This unit should be used with 100-240V 50/60Hz AC wall outlets, only. See Power Connections section.

BASIC OPERATIONS

Basic Playback

1. Prepare the connections and power supply.
2. Load a disc.
Press the Open button to open the disc compartment lid. Load a disc with the label-side facing up. Close the lid manually. If a single-sided disc is loaded upside-down, the player will display "BAD DISC".
3. Start playback.
Press Play/Pause button to start playback (some discs may start playing automatically).



Play/Pause/Stop

- Press to play the disc for the first time.
- Press during playback to pause. Press again to resume playback.
- Press during playback to stop the disc ("Pre-Stop"). Press to resume playback.
- Press when the disc is "Pre-Stopped" to stop playback completely. (When is pressed, the disc will start playing from the beginning.)



Next/Previous (Skip)

- Press to skip forward one track (DVD, CD, MP3, etc).
- Press to skip back one track (DVD, CD, MP3, etc).



Forward/Reverse (Search)

Press / to fast-forward / reverse through the disc.

- Each successive press of / will change the rate of fast-forward / reverse playback.

Play → x2 → x4 → x8 → x16



Slow

To slow-forward/reverse through the disc, press the DOWN/UP direction button.

- Each successive press of DOWN/UP direction button will change the rate of slow-motion playback.

Play → x 1/2 → x 1/4 → x 1/6 → x 1/8



- Press to resume normal playback.

Note:

Audio will be muted during fast-forward, fast-reverse, and slow-motion playback

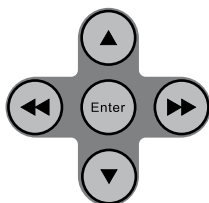

Menu Navigation

To navigate DVD disc menus or the player's setup menus:

- Press the DIRECTION keys (arrows) to select a desired feature or option in the menu
- Press ENTER to confirm a selection in the menu.
- For some menu options, you may be able to use the numeric keypad to input data.

BASIC OPERATIONS

Numeric Keypad

- Use the numeric keypad to skip directly to a DVD chapter or CD track. (Some discs may not allow direct access function.)
- Use the numeric keypad to input numeric data in menu option fields when possible.

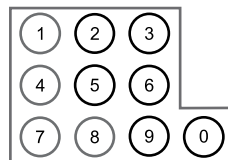

Adjusting the Volume

- Turn the Volume Control dial to adjust the volume level up or down.

Disc Error Messages

The following messages will be displayed on-screen if there is a problem with the format of the loaded disc.

- **WRONG REGIONAL DISC.** The region code of the disc does not match the player's region code (Region 1).
- **WRONG PASSWORD.** The parental rating level of the disc is higher than the parental rating level setting of the player. The player will not play the disc.
- **BAD DISC.** The player is equipped with automatic disc quality detection software. If the player detects a disc that is damaged or has a format problem, it may play the disc at a lower quality or stop play completely, depending on how damaged the disc is.

Note:

DVD disc production quality may vary; some discs may deviate from the industry standard.

Some incorrectly-formatted discs may still play, however, the playback and operational quality of the disc may be substandard.

Power Management

If the player will not be in use for a long period of time, set the Power Switch to the OFF position and unplug the player.

FUNCTION BUTTONS

Display / Setup

Display/Setup

- Press the DISPLAY button once to show playback information.
- Press it twice to enter the player's setup menu. Enter the Setup menu to adjust the player's internal settings, please see the SETUP section for more details.

Zoom

Zoom

Press ZOOM to change the magnification level of the picture.

- During DVD playback, each successive press of ZOOM will change the level of magnification to:
Zoom 1x, Zoom 2x, Zoom 3x, Zoom Off.
- In picture mode, each successive press of ZOOM will change the level of magnification to:
Zoom 1x, Zoom 2x, Zoom 3x, Zoom Off.

When the magnification level is greater than Normal/100%, use the direction keys to pan around the magnified picture.

Note: The picture quality will decrease as the zoom level increases.

SUB

Multi-Subtitle / Audio / Angle

- During playback of a DVD that has been mastered with subtitles, press SUBTITLE to view the available subtitle tracks. (A DVD may have up to 32 selectable subtitles.)
- During playback of a DVD that has been mastered with alternate language/audio tracks, press AUDIO to hear the alternate tracks. (A DVD may have up to 8 selectable audio tracks.)
- During playback of a DVD that has been mastered with multiple angles, press ANGLE to view the available alternate camera angles. (A DVD may have up to 9 selectable angles.)

Audio

Angle

Menu

Menu / Title

Press the MENU button during DVD playback to return to the DVD's Main menu.

Press the TITLE button during DVD playback to return to the DVD's Title menu.

Title

A-B

Repeat A-B Mode

To repeat playback of a specific section of a disc (loop):

1. Press A-B to set the desired start point ("A") of the section to be repeated.
2. Press A-B again to set the desired end point ("B") of the section to be repeated.
3. The section "A-B" will now play repeatedly as a loop. Press A-B again to resume normal playback.

1/All

Repeat Playback of Chapter/Title/ALL of a Disc

Press REPEAT to change the repeat mode of the player. Each successive press of REPEAT will change the mode as follows:

Repeat Chapter → Repeat Title → Repeat Disc → Repeat Off

FUNCTION BUTTONS

LCD
Mode

LCD Menu

Briefly press this button to display the LCD menu.

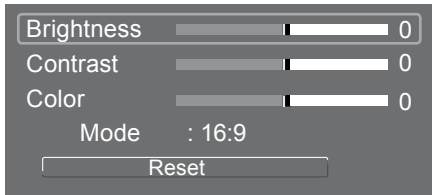

1. Press up/down direction button to highlight item and then make adjustment by left/right direction button.
2. Press up/down direction button to select Mode and then press the Enter button to toggle the screen dimension between 16:9 and 4:3.
3. Select RESET and press ENTER to return the settings of brightness, contrast and color to their factory default settings.

SETUP



Various features of the player can be adjusted in the SETUP menu.

1. Press  twice to enter the player's setup menu.
2. Press the direction buttons to select the desired item.
3. Press ENTER to confirm.

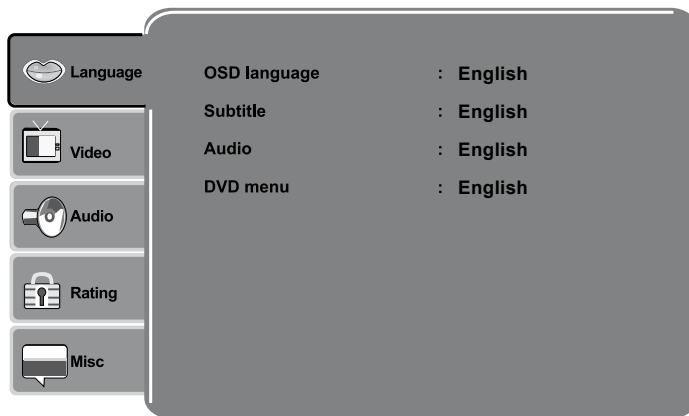

Language

Item	Description	Default Setting
OSD	Sets the language of the player's on-screen display.	English
Subtitle	Sets the default subtitle track of loaded DVDs.	English
Audio	Sets the default language audio track of loaded DVDs.	English
DVD Menu	Sets the default menu language of loaded DVDs.	English

Video

Item	Description	Default Setting
Aspect Ratio	Sets the aspect ratio of the display. 4:3 is used with standard television displays; 16:9 is used with widescreen television displays.	16:9
TV System	Sets the player's Video Out signal type. Set this to correspond with your TV's Video System type. NTSC is the standard used in North America.	NTSC

SETUP

Audio

Item	Description	Default Setting
Channel Output	Sets the audio channel mix mode (LT/RT, Stereo).	Stereo

Rating

Item	Description	Default Setting
Parental Control	Sets the maturity rating level of the player. The player will not play any discs rated higher than this setting. This setting is password protected (the default password is: 8888).	Levels 1 to 8. (8: ADULT is default)
Set Password	Change the Parental Ctrl password. Enter the old password, and then the new password. DO NOT FORGET THE PASSWORD; this password cannot be reset.	

Misc

Item	Description	Default Setting
Use Default Settings	Resets all settings to their factory default state. This will not reset the Parental Control password.	Read
Screen saver	The screen saver prevents burn-in damage to the player's screen.	On
Disc Resume	To set the Disc Resume on/off	On

SPECIFICATIONS

Power supply	DC 9.0V 1A (AC adapter Terminal)
Power consumption	≤ 6W
Signal system	NTSC /PAL
Video output	1±0.2V (p-p), 75ohm, Negative sync., 3.5 mm mini jack x1
Audio output	1.2 Vrms (1 KHz, 0dB), 3.5 mm mini jack x1
Earphone terminal	3.5mm stereo mini jack x1
Signal /Noise ratio(audio)	90dB typical
Dynamic range(audio)	90dB typical
Panel size	7 inch (16:9)
Resolution	480(H) x 234 (V) (QVGA) Pixels
Laser	Wavelength 650 nm
Operating conditions	Temperature: 0℃ to 35℃. Operation status : Horizontal
Dimensions	251x208x59mm (Main Unit & Batt.)
Weight	700g (Main Unit & Batt.)

Specifications and manual are subject to change without prior notice.

TROUBLESHOOTING

If you have a problem with this unit, please read the troubleshooting guide below and check our website at www.cobyusa.com for Frequently Asked Questions (FAQs) and firmware updates. If these resources do not resolve the problem, please contact Technical Support.

COBY Electronics Technical Support

56-65 Rust Street
Maspeth, NY 11378

Email: techsupport@cobyusa.com

Web: www.cobyusa.com

Phone: 800-727-3592: Monday to Friday, 8:30AM–9:00PM EST

Saturday, 9:00 AM-5:30PM EST

718-416-3197: Monday to Friday, 8:00AM–5:30PM EST

There is no power to the device.

- Ensure that the Power Switch on the main unit is physically set to the ON position.
- Ensure that the AC adapter cord is securely connected to the player and the proper wall outlet.

The device will not play the disc.

- Ensure that a supported disc is loaded in the player label-side up.
- Ensure that the disc's rating level does not exceed the player's parental rating level.
- Ensure that the disc is not damaged or too dirty.
- Clean the disc or try another disc. Moisture may have condensed inside the player. Remove the disc and leave the player on for 1-2 hours and then try again.

There is no picture.

- Ensure that the TV set has been powered on and is set to the correct AV mode.
- Ensure that the connections between the player and the TV are secure and correct.
- Check if the connection cables are damaged.

The picture is noisy or distorted.

- The disc may be damaged or dirty. Clean the disc or try another one.
- Reset your TV's color system.
- Ensure that the player is connected directly to the TV (and not through a VCR, cable box, satellite receiver, etc.)

The picture is not full-screen.

- Change the aspect ratio setting of your player from the Setup menu.
- Select a different aspect ratio option from the DVD disc menu.

There is no sound or distorted sound.

- Ensure that the TV and amplifier have been turned on and properly set up.
- Ensure that the TV and amplifier connections are secure and correct.
- Try a different Audio track of the DVD by pressing AUDIO.
- Ensure that the MUTE function of the TV, Amplifier, or Player is not engaged.

TROUBLESHOOTING

The remote control doesn't work.

- Ensure that the Power Switch has been physically set to the ON position.
- Ensure that there are no obstacles between the remote and the player.
- Point the remote at the remote sensor on the main unit.
- Ensure that the batteries in the remote retain a charge and have been installed correctly.
- Try replacing the remote's batteries.

Cannot turn the player on using battery power

- To activate the battery power: Turn off the player and then charge the battery by the AC adapter for about 10 seconds.
- See [Using the Built-in battery section](#) on Page 15.

NOTE

NOTE

COBY Electronics Corp.

56-65 Rust Street
Maspeth, NY 11378

www.cobyusa.com
www.ecoby.com

Free Manuals Download Website

<http://myh66.com>

<http://usermanuals.us>

<http://www.somanuals.com>

<http://www.4manuals.cc>

<http://www.manual-lib.com>

<http://www.404manual.com>

<http://www.luxmanual.com>

<http://aubethermostatmanual.com>

Golf course search by state

<http://golfingnear.com>

Email search by domain

<http://emailbydomain.com>

Auto manuals search

<http://auto.somanuals.com>

TV manuals search

<http://tv.somanuals.com>