

COBY



DVD 5.1 HOME THEATER SYSTEM

User Manual

DVD-958

Contents

Features & Package Contents.....	2
For your Attention.....	3-4
Panel.....	5
Connections.....	6-7
System Setup.....	8-14
Remote Control.....	15
Remote Control Function.....	16-18
Playback.....	19
Troubleshooting.....	20
Specifications.....	21







Features & Package Contents

Thank you for purchasing our product. Please read this manual carefully before connection and operation and keep it for future reference.

This DVD player is a next generation home player that can produce high quality video and audio for your continued enjoyment.

- Built in Dolby Digital, LPCM, MPEG etc. digital audio decoder
- HiFi, 96kHz/24bit audio digital processor
- COAXIAL digital audio output
- Compatible with DVD, CD, DVD+R/RW, DVD-R/RW, MP3, MPEG4, JPEG, etc.
- Full function remote control
- AM/FM stereo tuning system
- High quality amplifier

Playable Disc and Media Types:

Disc types	Symbol	Contents
DVD		Audio + Video
MP3		Audio
CD-DA		Audio
Picture CD		JPEG Photo CD
MPEG-4		Audio + Video
DivX		Audio + Video

Package Contents:

User Manual



Remote Control



A/V Cable



AM Antenna



FM Antenna



Speaker Cable



IMPORTANT SAFETY INSTRUCTIONS

1. Read these instructions.
2. Keep these instructions.
3. Heed all warnings.
4. Follow all instructions.
5. Do not use this apparatus near water.
6. Clean only with a dry cloth.
7. Do not block any ventilation openings. Install in accordance with the manufacturer's instructions.
8. Do not install near any heat sources such as radiators, heat registers, stoves, or other apparatus (including amplifiers) that produce heat.
9. Do not defeat the safety purpose of the polarized or grounding-type plug. A polarized plug has two blades with one wider than the other. A grounding type plug has two blades and a third grounding prong. The wider blade or the third prong is provided for your safety. If the provided plug does not fit into your outlet, consult an electrician for replacement of the obsolete outlet.
10. Protect the power cord from being walked on or pinched particularly at plugs, convenience receptacles, and the point where they exit from the apparatus.
11. Only use attachments/accessories specified by the manufacturer.
12. Use only with the cart, stand, tripod, bracket, or table specified by the manufacturer, or sold with the apparatus. When a cart is used, use caution when moving the cart/apparatus combination to avoid injury from tip-over.
13. Unplug this apparatus during lightning storms or when unused for long periods of time.
14. Refer all servicing to qualified service personnel. Servicing is required when the apparatus has been damaged in any way, such as power-supply cord or plug is damaged, liquid has been spilled or objects have fallen into the apparatus, the apparatus has been exposed to rain or moisture, does not operate normally, or has been dropped.
15. Where the mains plug or an appliance coupler is used as the disconnect device, the disconnect device shall remain readily operable.



IMPORTANT INFORMATION

To reduce risk of fire or electric shock, do not expose this WARNING apparatus to rain or moisture.

The apparatus must not be exposed to dripping or splashing. Objects filled with liquids, such as vases or drinking glasses, must never be placed on the apparatus.



This symbol indicates "dangerous voltage" inside the product that presents a risk of electric shock or personal injury.

For Your Attention



This symbol indicates important instructions accompanying the product.



Caution: To reduce the risk of electric shock, do not remove cover (or back). No user serviceable parts inside. Refer servicing to qualified service personnel.



This symbol indicates that this product incorporates double insulation between hazardous mains voltage and user accessible parts. When servicing use only identical replacement parts.

FCC Statement:

This device complies with Part 15 of the FCC Rules. Operation is subject to the following two conditions:

- (1) This device may not cause harmful interference, and
- (2) This device must accept any interference received, including interference that may cause undesired operation.

Note:

This equipment has been tested and found to comply with the limits for Class B digital devices, pursuant to Part 15 of the FCC rules. These limits are designed to provide reasonable protection against harmful interference in a residential installation. This equipment generates, uses and can radiate radio frequency energy and, if not installed and used in accordance with the instructions, may cause harmful interference to radio communications. However, there is no guarantee that interference will not occur in a particular installation. If this equipment does cause harmful interference to radio or television reception, which can be determined by turning the equipment off and on, the user is encouraged to try to correct the interference by one or more of the following measures:

- Reorient or relocate the receiving antenna.
- Increase the separation between the equipment and receiver.
- Connect the equipment into an outlet on a circuit different from that to which the receiver is connected.
- Consult the dealer or an experienced radio/TV technician for help

Use of shielded cable is required to comply with Class B limits in Subpart B of Part 15 of the FCC rules.

Do not make any changes or modifications to the equipment unless otherwise specified in the manual. If such changes or modifications should be made, you could be required to stop operation of the equipment.

FRONT PANEL:

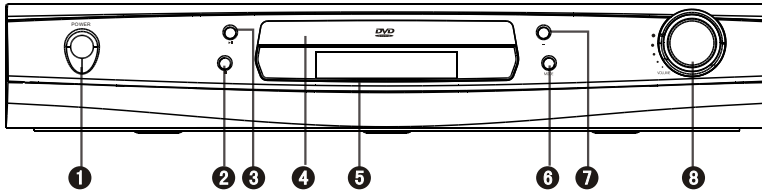

- | | |
|----------------------|----------------------|
| 1. POWER BUTTON | 5. DISPLAYSCREEN |
| 2. STOP BUTTON | 6. MODE BUTTON |
| 3. PLAY/PAUSE BUTTON | 7. OPEN/CLOSE BUTTON |
| 4. DISC DOOR | 8. VOLUME KNOB |

REAR PANEL:

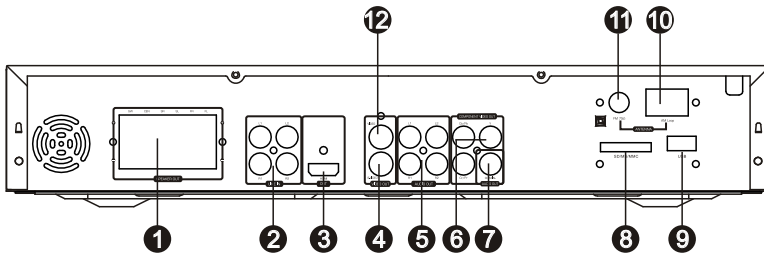

- | | |
|---------------------------|---------------------------------|
| 1. SPEAKER OUTPUT | 7. COAXIAL DIGITAL AUDIO OUTPUT |
| 2. LINE INPUT | 8. SD/MS/MMC CARD PORT |
| 3. HDMI OUTPUT | 9. USB PORT |
| 4. S-VIDEO OUTPUT | 10. AM ANTENNA JACK |
| 5. 2-CH AUDIO OUTPUT | 11. FM ANTENNA JACK |
| 6. COMPONENT VIDEO OUTPUT | 12. COMPOSITE VIDEO OUTPUT |

Connections

1 VIDEO SYSTEM CONNECTION

The following video outputs are available for this unit .

1.1 Composite Video

Use the cable with yellow plug of an AV cable to connect the composite video output of this unit to the video input of a TV/monitor.

1.2 S-Video

Use a S-Video cable to connect the S-Video output of this unit to the S-Video input of a TV/monitor.

1.3 Component Video

Use a 3-core AV cable to connect the component outputs of this unit to the corresponding inputs of a TV/monitor.

1.4 HDMI

HDMI output presents the highest possible resolutions and video quality. If an HDMI socket is present on your television, use it. Use an HDMI cable to connect the HDMI output of this unit to the HDMI input of a TV/monitor.

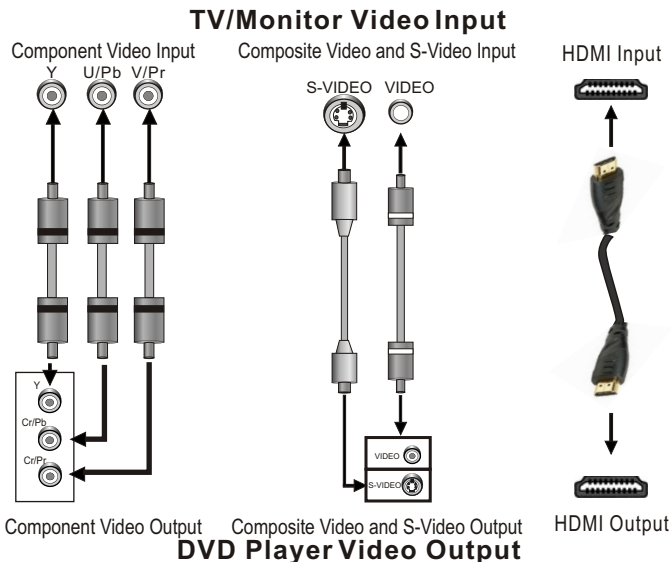

Notes:

- Of the above video outputs, the HDMI is the best, Component Video is the second best, S-VIDEO is good and the composite video is standard. Use the best available video connection.
- Don't make all the connections above at one time, otherwise the produced pictures will be affected.
- Only when the video settings conform to the actual video system connections does the player produce the corresponding video output. (Please refer to the **Video Setup in System Setup**).

2 AUDIO SYSTEM CONNECTION (OPTIONAL)

In addition to the 5.1-channel sound provided by this unit, the following optional audio outputs are available (2.1 - 2.3).

2.1 Stereo Audio

Use a pair of audio cables (red for right /white for left) to connect the stereo audio output of this unit to other stereo audio input.

2.2 Coaxial Digital Audio

Use a coaxial cable to connect the coaxial output of this unit to the coaxial input of a power amplifier.

2.3 Speaker Output

Use speaker cables to connect the speaker output terminals of this unit to the corresponding speakers.

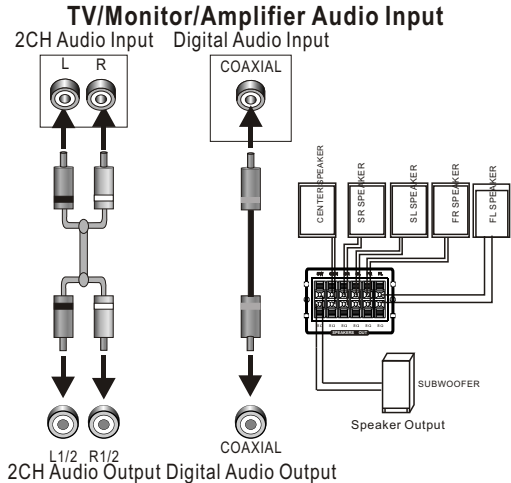

DVD Audio Output

2.4 Line Input

This unit has two groups of extra audio input terminals. You can input the analog stereo audio signals from extra devices such as VCD, CD, VCR player, etc. Use the audio cable (red for right, white for left) to connect the stereo audio output terminals of a VCD, CD, VCR player to the stereo input terminals of this unit. After the connections have been correctly made, press [MODE] to switch the corresponding signal source to enjoy the audio from the connected extra device.

Audio Output of Extra Devices

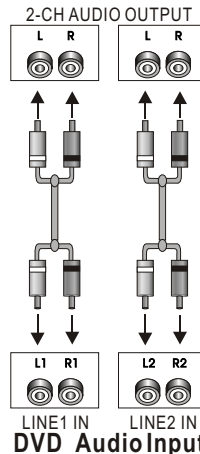

Notes:

The audio settings should conform to the practical audio system connections. Please refer to the **Audio Setup** in **System Setup**.

System Setup

MENU OPERATION:

1. In DVD mode, press [SETUP] on the remote control to display the setup menu.
2. Press [←]/[→] to select an item. The submenu of the selected item will be displayed below instantly.
3. Press [↑]/[↓] to select an item you desire to set in the submenu, then press [ENTER] / [→] to enter. Use [↑]/[↓] to select an option, then press [ENTER] to confirm it, or press [←] to cancel.
4. Then you can press [↑]/[↓] to continue to set other items in the submenu.
5. Press [←] to go back to the superior menu of the current one.
6. Press [SETUP] again to exit the setup menu. Alternately, move the highlight to 'X', then press [ENTER] to exit the setup menu.

1 GENERAL SETUP PAGE

1.1 TV DISPLAY

If the unit is connected to a conventional TV set, you are supposed to select **4:3 PAN SCAN** or **4:3 LETTER BOX**.

4:3 PAN SCAN: The wide-screen image will be displayed on the screen in its native aspect ratio with some part on the left and right cut off.

4:3 LETTERBOX: The wide-screen image will be displayed in its native aspect ratio with black borders on the top and the bottom side.

16: 9: If the unit is connected to a wide-screen TV set, you are supposed to select this option.

The wide-screen image will be displayed in full screen in its native aspect ratio while the 4:3 image will be stretched out horizontally to fit in the screen.

1.2 ANGLE MARK

Set this item to **ON**. When a disc with multiple camera angles is playing, an angle mark will display on the screen. Then you can view the video of different camera angles by pressing [ANGLE] on the remote control.

Set this item to **OFF** to hide the angle mark.

1.3 OSD (On-Screen Display) LANGUAGE

Set the on-screen display language in this item.

1.4 CLOSED CAPTIONS

Set this item to **ON** to show the closed captions. Set it to **OFF** to hide it.

NOTE: This function only work with those discs encoded with closed captions.

1.5 SCREEN SAVER

ON: If the image remains motionless on the screen, for example the disc is paused, stopped etc, for several minutes, a screen saver will appear on the screen. You can press any key or button except [STANDBY] to wake it up.

The unit will go into the standby mode after about 20 minutes being in the screen saver mode. You can press [STANDBY] to switch it on.

OFF: Disable the screen saver function.

1.6 LAST MEMORY

ON: Each time you turn off the unit or stop the disc, it will memorize the last play time. Next time you turn on the unit and play the same disc, the unit will play from that memorized point.

OFF: Disable the last memory function.

2 AUDIO SETUP PAGE

There are eight items in the AUDIO SETUP PAGE. They are ANALOG AUDIO, DIGITAL AUDIO, DOLBY DIGITAL, CHANNEL DELAY, EQUALIZER, 3D PROCESSING and HDCD.

2.1 ANALOG AUDIO SETUP

2.1.1 DOWNMIX

LT/RT: The 5.1-channel audio is mixed into left channel and right channel and is output via the FL and FR speaker respectively.

STEREO: The 5.1-channel audio is mixed into stereo signal and is output via the FL and FR speaker.

3D SURROUND: This mode creates a virtual surround effect from stereo or multi-channel audio contents.

5.1CH: Turn off the DOWNMIX mode. If a 5.1CH disc is playing or the unit is connected to 5.1-channel amplifier, this item should be selected.

NOTE: This function only applies to the Dolby AC-3 encoded 5.1-channel discs.

2.1.2 FRONT, CENTER, REAR SPEAKER and SUB-WOOFER

Only when the DOWNMIX mode is turned off (**DOWNMIX** is set to **5.1CH**), the **CENTER SPEAKER** and **REAR SPEAKER** are activated. The **FRONT SPEAKER** can be set to **LARGE** or **SMALL**. The **CENTER SPEAKER**, **REAR SPEAKER** can be set to **LARGE**, **SMALL** or **OFF** and the **SUBWOOFER** can be set to **ON** or **OFF**.

NOTE:

If the speaker is set to **LARGE**, the output level will be higher than that of **SMALL**.

If the speaker is set to **SMALL**, the output level will be lower than that of **LARGE**.

If a speaker is set to **OFF**, no audio is outputted from it.

If the sound from your speakers is distorted, try setting the speaker size to **SMALL**.

2.1.3 DIALOG

When **DOWNMIX** is set to **LT/RT** or **STEREO**, this item is available.

Adjust the value of this item to control the dialog volume.

NOTE: When playing 5.1CH disc, this item can be used to adjust the volume of the speakers.

2.1.4 D.R.C.(Dynamic Range Control)

You can set this item to **ON**, **OFF** or **AUTO**.

2.2. DIGITAL AUDIO SETUP

2.2.1 DIGITAL OUTPUT

SPDIF/ OFF: There will be no digital audio signal output. (Coaxial off)

ALL: The digital audio signal output will be in its raw format.

PCM only: The digital audio signal output will be in PCM format.

System Setup

2.2.2 LPCM OUTPUT

When **DIGITAL OUTPUT** is set to **PCM ONLY**, this item is available.

Select a sampling rate for the analog audio output. There are two options, 48KHz and 96KHz.

NOTE: Some amplifiers don't support 96KHz sampling which will affect the coaxial output.

2.3 DOLBY DIGITAL SETUP

2.3.1 DUAL MONO

STEREO: The player outputs the left-channel audio and right-channel audio via the FL and FR speaker respectively.

L-MONO: The player outputs the left-channel audio only via both the FL and FR speaker.

R-MONO: The player outputs the right-channel audio only via both the FL and FR speaker.

MIX-MONO: The player outputs the average signal of the left-channel and right-channel audio via the FL speaker and the FR speaker

NOTE: This function only applies to the Dolby AC-3 encoded 2-channel discs.

2.3.2 DYNAMIC

When you watch films with large dynamic scope in low volume, for example at night, you can adjust the dynamic value up to avoid losing sound details resulted from the low volume.

2.4 CHANNEL DELAY

This item is used to set the delay time for the center, rear speakers and the subwoofer. The delay is to compensate for the audio propagation time difference caused by the distance difference of the speakers to the listener.

Use the direction key [↑]/[↓] to select the center speaker, subwoofer, left surround speaker or right surround speaker.

Then use the direction key [←]/[→] to set the distance difference.

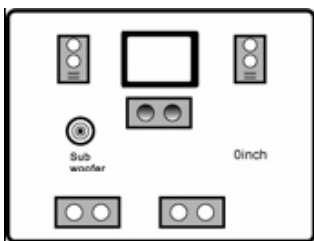

NOTE:

The unit does not support delays when the distance between the center or surround speakers and the listener are longer than that between the front speakers and the listener.

In case the channel delay settings cannot match your speaker configuration, please set all distance difference to 0cm. If possible, use your receiver/amplifier to set the channel delay.

2.5 EQUALIZER

2.5.1 SOUND MODE

There are 8 kinds DSP mode for you to choose. They are NORMAL, ROCK, POP, LIVE, DANCE, TECHNO, CLASSIC and SOFT.

2.5.2 BASS BOOST

Set it to **ON** to boost the bass sound.

2.5.3 SUPER BASS

Set it to **ON** to get the super bass sound effect.

2.5.4 TREBLE BOOST

Set it to **ON** to boost the treble sound.

2.6 3D PROCESSING

2.6.1 PRO LOGIC II

Pro Logic II: This unit allows you to configure Dolby Pro Logic II to expand 2-channel source audio into full 5.1-channel surround sound.

NOTE: Pro Logic II functionality is effective only when **DOWNMIX** is set to **5.1CH** and **DIGITAL OUTPUT** is set to **ALL**.

2.6.1.1 PRO LOGIC II

This item is used to turn on or off the Pro Logic II processing.

ON: Pro Logic II processing is always on.

OFF: Pro Logic II processing is disabled

AUTO: Pro Logic II processing is on only when Dolby Pro Logic II encoded content is detected.

2.6.1.2 MODE

This item is used to set the processing mode of Pro Logic II and is available only when the Pro Logic II processing is turned on.

MUSIC: Sound from all speakers arrive at the same time with no delay.

MOVIE: 10ms delay is added to the surround channels.

PRO LOGIC: Earlier version of Dolby Pro Logic processing.

AUTO: Automatically selects processing mode based on the input format.

2.6.1.3 PANORAMA

This item is used to turn on/off panorama mode and is available only when **MODE** is set to **MUSIC**.

When panorama mode is turned on, the front stereo audio is partially fed into the surround channels for an enveloping effect.

2.6.1.4 DIMENSION

This item is available only when **MODE** is set to **MUSIC**.

This item allows gradual adjustment of the soundfield either towards the front or towards the rear. This is useful in setting a more even balance from all speakers with some rooms.

2.6.1.5 CENTER WIDTH

This item is available only when **MODE** is set to **MUSIC**.

This item can be used to control the width of the center channel sound effect by blending the center speaker to the left and right speakers. As the level number increases, the center channel sound moves toward the left and right speakers.

2.6.2 REVERB MODE

You can select a reverb mode (**NORMAL**, **CONCERT**, **LIVING ROOM**, **HALL**, **BATHROOM**, **CAVE**, **ARENA** or **CHURCH**) in this item.

2.7 HDCD (High Definition Compatible digital)

HDCD (High Definition Compatible digital) is a patented encode/decode process for delivering the full richness and details of the sound from HDCD-encoded CDs.

2.7.1 FILTER

You can select the digital filter at **2x**, **1x** or **OFF**.

System Setup

3 VIDEO SETUP PAGE

There are five items in the VIDEO SETUP PAGE. They are VIDEO OUTPUT, TV MODE, HD MODE, COLOR SETTING, and HDMI SETUP.

3.1 VIDEO OUTPUT

OFF: Set video output to the CVBS (composite video).

YUV: Set video output in analog component video format when the component video outputs are used.

NOTE: If the video setting differs from the physical video connection, the TV set may have poor picture. Press [V-MODE] on the remote control repeatedly to switch to an appropriate video output mode.

3.2 TV MODE

When **HDMI** is set to **OFF** and when **VIDEO OUTPUT** is set to **YUV**, this item is available.

PROGRESSIVE: The video will be output in the form of progressive scanning.

INTERLACE: The video will be output in the form of interlaced scanning.

3.3 HD MODE (High Definition Mode)

When **HDMI** is set to **OFF** and when **VIDEO OUTPUT** is set to **YUV**, this item is available.

Select a HD mode: **OFF**, **720p** or **1080i**.

NOTE: This item requires that your TV support HD input and output.

3.4 COLOR SETTING

3.4.1 SHARPNESS

There are three options (**HIGH**, **MEDIUM** and **LOW**) for you to choose in this item.

3.4.2 BRIGHTNESS, CONTRAST, HUE and SATURATION

Enter these items respectively, use direction key [←]/[→] to adjust the value, then press [ENTER] to confirm it.

3.4.3 GAMMA

There are four options (**HIGH**, **MEDIUM**, **LOW** and **NONE**) for you to choose in this item.

3.4.4 LUMA DELAY

There are two options (**0T** and **1T**) for you to choose in this item.

3.5 HDMI SETUP

About HDMI

HDMI (High-Definition Multimedia Interface) is the newest interface for audiovisual equipment such as high-definition television and home theater systems. With 19 wires wrapped in a single cable that resembles a USB wire, HDMI is able to carry a bandwidth of 5 Gbps (gigabits per second). This is more than twice the bandwidth needed to transmit multi-channel audio and video, future-proofing HDMI for some time to come. This and several other factors make HDMI much more desirable than its predecessors, component video, S-Video and composite video.

HDMI is an uncompressed, all-digital signal, while the aforementioned interfaces are all analog. With an analog interface, a clean digital source is translated into less precise analog, sent to the television, then converted back to a digital signal to display on screen. At each translation, the digital signal loses integrity, resulting in some distortion of picture quality. HDMI preserves the source signal, eliminating analog conversion to deliver the sharpest, richest picture possible.

HDMI supports standard video formats, enhanced video and high-definition. It is also backwards compatible with DVI (Digital Video Interface). High-end graphics cards featuring a DVI port can connect to a HDMI interface via a DVI/HDMI cable. This is simply a cable with a DVI connector on one end and a HDMI connector on the other. As a rule, HDMI cables should not run longer than 15 feet (5 meters), or degradation of the signal could occur.

3.5.1 HDMI

You can set it to **ON** or **OFF**.

NOTE: When HDMI is set to **ON**, the items **VIDEO OUTPUT**, **TV MODE**, **HD MODE** and **TV TYPE** are unavailable.

3.5.2 RESOLUTION

This item is available when **HDMI** is set to **ON**.

Select a resolution: 720p(50Hz) or 1080i(50Hz).

3.6 DIVX VOD (DivX Video-on-Demand)

The registration code for DivX Video-on-Demand (VOD) service can be available in this item. Enter this item and press [ENTER] to get the registration code from the brought up information box. Press [ENTER] to quit.

With the registration code you can rent and purchase movies using the DivX Video-on-Demand (VOD) service offered by DIVX official website. Then burn the video onto a disc and playback it with this player.

4 PREFERENCE PAGE

If there's no disc in the disc tray, the disc tray is open or the disc in the disc tray is stopped, this item is available.

There are seven items in the PREFERENCE SETUP PAGE. They are TV TYPE, PBC, AUDIO, SUBTITLE, DISC MENU, PARENTAL and DEFAULT.

4.1 TV TYPE

This product supports both NTSC (National Television System Committee) and PAL (Phase Alternating Line) television broadcasting standards.

System Setup

NTSC: If the connected TV is NTSC system which is used in Taiwan, America and Canada, etc, select this mode. It will change the video signal of a PAL disc and output in NTSC format.

PAL: If the connected TV is PAL system which is used in China, Hongkong and Europe, etc, select this mode. It will change the video signal of a NTSC disc and output in PAL format.

MULTI: If the connected TV is multi system, select this mode. The output format video signal of the disc will be in accordance with the video signal of the disc.

Note: If a wrong selection is made, the viewing image will be very poor. In such a case, change the option in this item to fix the error.

4.2 PBC (Play Back Control)

ON: Activate the PBC function.

OFF: Disable the PBC function.

NOTE: This function only works with those discs encoded with PBC function DVD, CD-DA and MP3 disc have no PBC menu.

4.3 AUDIO, SUBTITLE and DISC MENU

Select a preferred audio language, subtitle language and disc menu language in these items.

You can also make selection of the audio language by using the [AUDIO] and the subtitle language by the [SUBTITLE] on the remote control.

NOTE: If the selected language is not available for the currently playing disc, the disc's default audio, subtitle, disc menu language setting works.

4.4 PARENTAL

This item allows the user to set a maximum rating of the movies that can be viewed without inputting the correct password. Movies rated higher than the level set for the parental lock can not be viewed. What's more, to key in the correct password is needed to reset the level. The default password is 136900.

NOTE: This function only works with those discs with parental function.

4.5 DEFAULT

Restore all the default settings except the settings in **PARENTAL** and **PASSWORD MODE** item.

5 PASSWORD SETUP PAGE

5.1 PASSWORD MODE

You can switch on/off the password function in this item.

NOTE: You must key in the correct password and press [ENTER] before you change the option in this item. The default password is 136900.

5.2 PASSWORD

You can reset the password in this item.

NOTE: The default password (136900) is always active even if the password has been reset. So if you forget your reset password, use it.

Remote Control

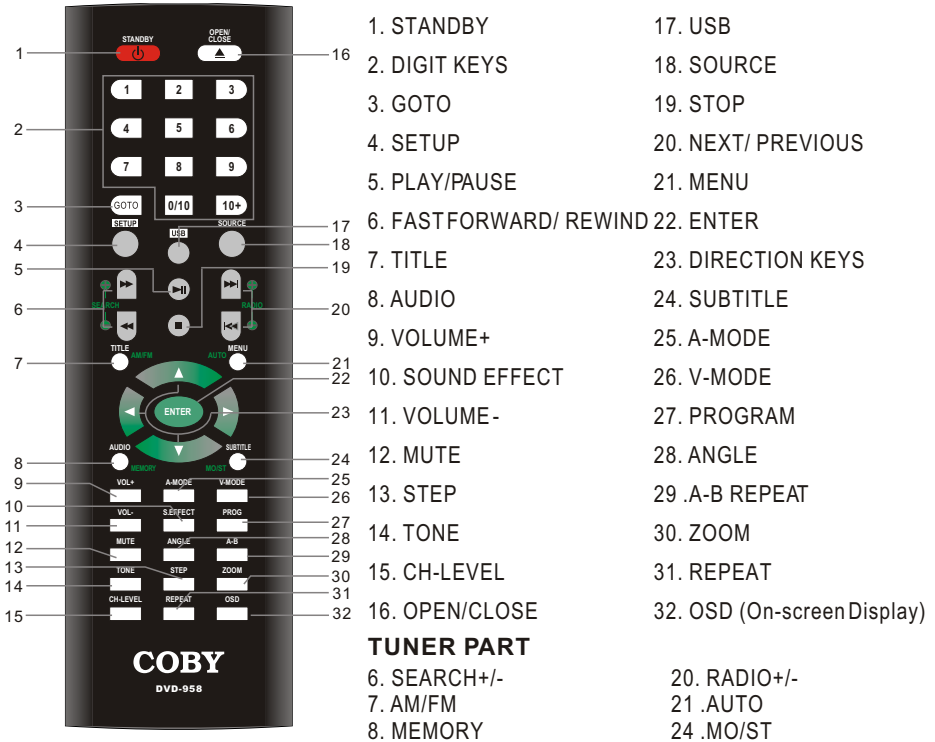

Remote Control Operation

Install two AAA/1.5V batteries into the remote control. Point the remote control at the remote sensor on the front panel. The remote control works within about 8 metres from the sensor and within an angle of about 30 degrees from the left and right side.

Battery Installation

1. Remove the battery compartment cover on the back of the remote control.
2. Load the batteries into the battery compartment making sure that the batteries have been inserted with the correct polarities matching the symbols +, - as indicated inside the battery compartment.
3. Replace the cover.

NOTE:

- Remove the batteries when you do not intend to use it for a long time.
- Do not mix the new and the used batteries, or the different types of batteries.
- Weak batteries can leak and severely damage the remote control.
- Be environmentally friendly and dispose of batteries according to your government regulations.

Remote Control Function

STANDBY



● Press to switch on the unit. Press it again to put the unit in standby mode.

SOURCE



● Press repeatedly to select a video/audio source among TUNER, LINE 1, LINE 2 and DVD.

SETUP



● Press to enter/exit the setup menu.

OPEN/CLOSE



● Press to open/close the disc tray.



● The digit keys can be used to input numbers or make selection of a track or a chapter, etc.



● Press to enter an item in the menu or to confirm and execute a selection.



● The direction keys can be used to move the highlight in the menu.

GOTO



● Press to enter the GOTO menu. Use the digit keys to select a title, chapter, track, track time or disc time to play. Press it again to exit.

PROGRAM



● You can play the contents of the disc in your desired order by programming in the program menu. Press this button to enter the program menu. Press it again to exit the menu.



● Press to temporarily pause a playback. Press it again to resume the playback.
Or, press to resume the normal playback from the fast forward, fast reverse, frame-by-frame playback, etc.



● Press once to pause a playback, then press [▶] to continue the playback; Press it twice to stop a playback and the disc will be reset to the starting point.



● Fast forward playback. The available speed are 2X, 4X, 8X, 16X and 32X.



● Fast reverse playback. The available speeds are 2X, 4X, 8X, 16X and 32X.



● Press to return to the previous chapter/track.



● Press to skip to the next chapter/track.

STEP



● Press repeatedly to advance the video frame by frame. Press [▶] to resume the normal playback. (Applies to DVD, VCD, MPEG4 discs etc)

Remote Control Function

REPEAT

- Press repeatedly to switch the repeat modes. (Note: This function is invalid when the PBC function is activated.)
DVD: CHAPTER(chapter repeat)→TITLE(title repeat)→ALL(repeat all)→(cancel repeat)
CD: TRACK(track repeat)→ALL(repeat all)→(cancel repeat)
MP3: SINGLE→REPEAT ONE→REPEAT FOLDER→FOLDER→(cancel repeat)
MPEG4: SINGLE→REPEAT ONE→REPEAT ALL→REPEAT OFF(cancel repeat)

A-B

- You can repeat a specific section of a disc with this button. Press this button to mark down the starting point (A) and press it again to mark down the ending point (B). Then, the unit will playback this section over and over again. Press it for the third time to cancel A-B repeat and resume to the normal playback.
Note: Points A and B must be in the same title/ track.

MUTE

- Press this button to switch off the sound temporarily. Press it again to switch it on.

VOLUME+/-

- Press [VOLUME+] to turn up the volume; press [VOLUME-] to turn down the volume.

S.EFFECT

- Press repeatedly to switch the sound effects or switch off the sound effect. Note: You are recommended to switch off the sound effect when playing a Dolby 5.1 channel disc so that to obtain the real 5.1 effect.

CH-LEVEL

- Press this key repeatedly to select a channel or the overall volume, then press [VOLUME+]/[VOLUME-] to adjust its level.

TONE

- Press to select BASS or TREBLE, then use [VOLUME+]/[VOLUME-] to control the level of bass or treble.

TITLE

- Press to access the title menu.

MENU

- Press to return to the root menu.
- When playing disc encoded with PBC function, press to display the PBC menu. Press it again to disable the PBC function.

SUBTITLE

- Press repeatedly to switch the subtitles or switch off the subtitle function. (Note: This function only works with those discs encoded with subtitles.)

OSD

- Press repeatedly to switch or hide the relative information of the playing disc.

AUDIO

- Press repeatedly to select the available audio languages provided by the disc (for DVD).
- Press repeatedly to switch the available audio channels (LEFT-MONO, RIGHT-MONO, MIX-MONO and STEREO) provided by the disc (for VCD).

Remote Control Function

ANGLE

● Press to switch the viewing angles.
(Note: This function only works with the discs encoded with multiple camera angles.)

V-MODE

● Press repeatedly to switch the video output modes between CVBS (OFF) and YUV.

A-MODE

● Press repeatedly to switch the audio output modes between 5.1 CHANNELS OUTPUT and STEREO OUTPUT.

ZOOM

● Press this button to zoom in/out the scene. The available zoom ratios are: 2X, 3X, 4X, 1/2 X, 1/3 X and 1/4 X. In zoomed-in mode, the direction keys can be used to pan around the magnified picture.

USB

● Press repeatedly to switch to the available extra signal source USB or SD/MS/MMC CARD, or return to the DVD mode.

USB DRIVE and SD/MS/MMC CARD PLAYBACK

● Insert a USB drive in the USB port, then press [USB] to play the readable files in it. Press [USB] again to switch to the DVD mode.

● Insert a SD, MS or a MMC card into the SD/MS/MMC card port, then press [USB] to play readable files in it. Press [USB] again to switch to the DVD mode.

NOTE: If a USB drive and a memory card are inserted at the same time, press [USB] once to select USB and press twice to select memory card. Press for the third time to return to the DVD mode.

This USB Port is designed to be used with most flash memory drives. Other USB drives may not be supported.

Tuner Part

The following buttons are used in Tuner Mode. Press [SOURCE SELECT] to select tuner mode if it is in other mode.

AM/FM

● Press to switch between the AM mode and the FM mode.

MO/ST

● Press to switch between Mono and Stereo reception of the broadcast signal in FM mode.

AUTO

● Press to scan the broadcasting stations automatically.

LEFT/RIGHT

● Press the direction key [LEFT]/[RIGHT] to do manual scanning for broadcasting station of lower/higher frequency.

SEARCH+/-

● Press to fine tune (increase/decrease) the frequency.

■

● During scanning broadcasting stations, press to stop the process.

MEMORY

● After tuning in a new frequency, press [MEMORY], then select a preferred station by inputting the corresponding numbers to save it as a preset station.

0 1 2 3 4 5 6 7 8 9

● The digit keys can be used to select a preset station.

0 1 2 3 4 5 6 7 8 9

For example, press [0] and [2] to go to channel 2; press [1] and [5] to go to the channel 15.

RADIO+/-

● Press to skip to the next/previous preset station.

NOTE: In Tuner mode, [VOLUME+/-], [CH-LEVEL], [MUTE], [TONE] and [S.EFFECT] buttons are available. For details, please refer to the remote control function of the DVD part in this chapter.

JPEG PICTURE PLAYBACK

● Place a JPEG picture CD in the disc tray, then the unit will load the disc automatically.

● Press [■] to enter the thumbnail mode to preview the pictures.

In the thumbnail mode, use the direction keys to select a picture, then press [ENTER] to start the playback from the selected picture.

In the thumbnail mode, use the direction keys and [ENTER] to make selections of the **Slide Show, Menu, PREV** or **NEXT** at the bottom of the screen.

Slide Show: Start slide show playback.

Menu: Enter the instruction menu for remote key function. In the menu, press [ENTER] to turn over to the next menu page and again to exit the instruction menu.

PREV/NEXT: Turn over to the previous/next page.

● Remote key function introduction

[■]: Enter the thumbnail mode to preview the pictures.

[ZOOM]: During playback, press [ZOOM], then press [▶]/[◀] to zoom in/out the picture. When the picture is zoomed in, the direction keys can be used to move the picture. Press [ZOOM] again to exit the zooming mode.

[▶]/[◀]: Skip to the next/previous picture during playback.

[⏸]: Press to pause a playback. Press it again to resume the playback.

[↻]/[→]: Rotate the picture counterclockwise/ clockwise during the playback.

MP3 PLAYBACK

Insert a MP3 disc into the player, then a content menu will display on the screen.

MENU OPERATION:

● Use the direction key [↑]/[↓] to select a folder or a file, then press [ENTER] to enter the selected folder or play the selected file. You can also use the digit keys to make selection of a folder to enter or a file to play.

● [▶]/[◀]: Press [▶]/[◀] to turn over the menu page.

● [←]: Press the direction key [←] to return to the previous menu.

● [PROG]: Press repeatedly to switch between FOLDER playback mode and FILELIST playback mode.

NOTE: During playback, [▶], [◀], [REPEAT], [A-B], [⏸], [■] (press to stop the playback), [VOLUME +/-], [MUTE], etc. are valid. Please refer to the remote control function introduction in this chapter for details. Please refer to the **REMOTE CONTROL FUNCTION** chapter for details.

Specifications

Power supply		AC ~110-120V/60Hz
Power consumption		210W
Working environment	Temperature	-10~+40°C
	Relative humidity	5%~90%
Disc output	TV System	PAL/NTSC
	Frequency Range	20Hz~20KHz
	S/N(A weight)	>80dB(1KHz)
	Dynamic Range	≥70dB(1KHz)
	THD+NOISE	≤ -60dB(1KHz)
Tuner	WOW FLUTTER	Below the limit of apparatus measure
	AM frequency Range	522KHz~1620KHz
	FM band Range	87.5MHz~108MHz
Power output (Max)		30WX5+60W
Frequency response		± 1.5dB(20Hz~20KHz)

Free Manuals Download Website

<http://myh66.com>

<http://usermanuals.us>

<http://www.somanuals.com>

<http://www.4manuals.cc>

<http://www.manual-lib.com>

<http://www.404manual.com>

<http://www.luxmanual.com>

<http://aubethermostatmanual.com>

Golf course search by state

<http://golfingnear.com>

Email search by domain

<http://emailbydomain.com>

Auto manuals search

<http://auto.somanuals.com>

TV manuals search

<http://tv.somanuals.com>