

COBY®

TFT LCD Widescreen Television

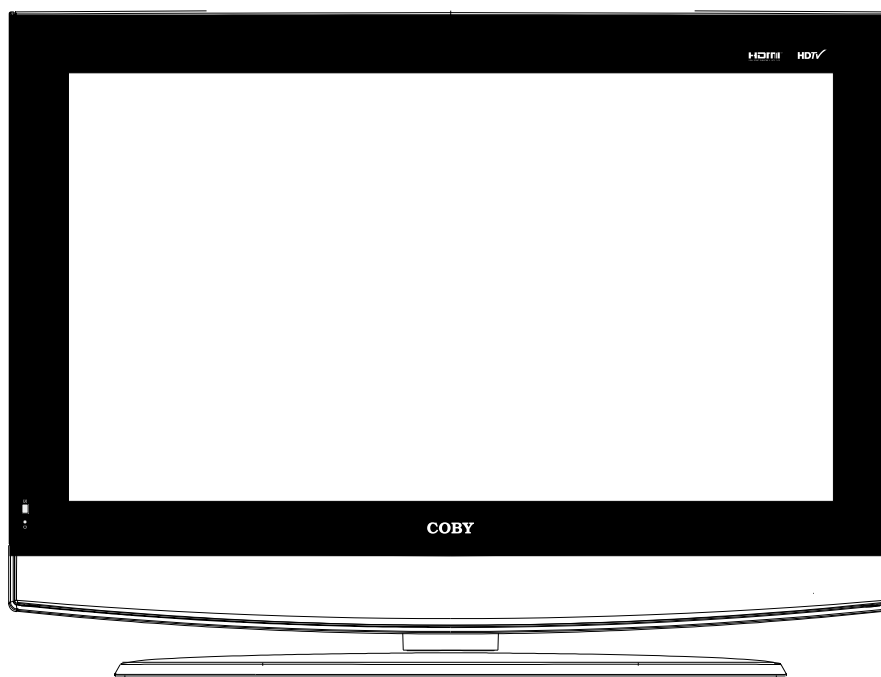

Instruction Manual

TFDVD2697/3297

Please read this manual carefully before connection and use

Precautions

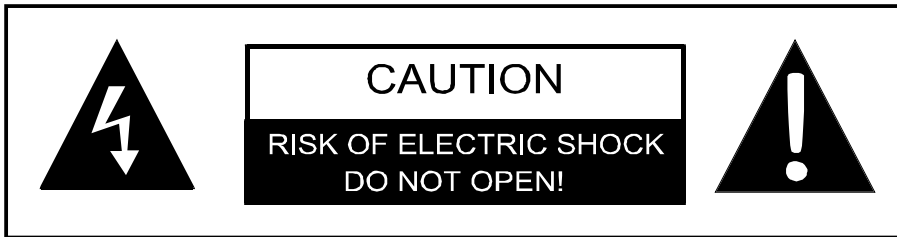

WARNING:
TO REDUCE THE RISK OF FIRE OR ELECTRIC SHOCK, DO NOT EXPOSE THIS APPLIANCE TO RAIN OR MOISTURE.

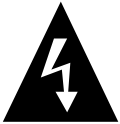

The lightning flash with arrowhead symbol, within an equilateral triangle, is intended to alert the user to the presence of uninsulated "dangerous voltage" within the product's enclosure that may be of sufficient magnitude to constitute a risk of electric to persons.



The exclamation point within an equilateral triangle is intended to alert the user to the presence of important operating and maintenance (servicing) instructions in the literature accompanying the appliance.

For Customer Use:

Enter below the serial number that is located on the rear of the unit. Retain this information for future reference.

Model No. TFDVD2697/3297

Serial No. _____

Caution:

These servicing instructions are for use by qualified service personnel only. To reduce the risk of electric shock, do not perform any servicing other than that contained in the operating instructions unless you are qualified to do so. Refer to manual for servicing instructions.

Power Supply:

Connect one end of the supplied power cord to the power jack on the unit rear panel and the other end to the AC100-240V wall outlet. If the unit will not be used for a long time, disconnect the plug from the outlet.

Power Management:

- Before plugging the power cord into the AC outlet, make sure that all the connections have been properly made.
- If the unit will not be used for a long period of time, disconnect the power and remove the batteries from the remote.

Precautions

FCC Statement:

This device complies with Part 15 of the FCC Rules. Operation is subject to the following two conditions:

- This device may not cause harmful interference, and
- This device must accept any interference received, including interference that may cause undesired operation.

Note:

This equipment has been tested and found to comply with the limits for Class B digital devices, pursuant to Part 15 of the FCC rules. These limits are designed to provide reasonable protection against harmful interference in a residential installation. This equipment generates, uses and can radiate radio frequency energy and, if not installed and used in accordance with the instructions, may cause harmful interference to radio communications. However, there is no guarantee that interference will not occur in a particular installation. If this equipment does cause harmful interference to radio or television reception, which can be determined by turning the equipment off and on, the user is encouraged to try to correct the interference by one or more of the following measures:

- Reorient or relocate the receiving antenna.
- Increase the separation between the equipment and receiver.
- Connect the equipment into an outlet on a circuit different from that to which the receiver is connected.
- Consult the dealer or an experienced radio/TV technician for help

Use of shielded cable is required to comply with Class B limits in Subpart B of Part 15 of the FCC rules. Do not make any changes or modifications to the equipment unless otherwise specified in the manual. If such changes or modifications should be made, you could be required to stop operation of the equipment.

LCD Information

The LCD panel used in this television contains millions of thin film transistors that have been manufactured using a high-technology process to deliver a crisp, clear, and detailed picture. Occasionally, a few of these transistors may become stuck or non-active; please note that this does not affect the performance of the television.

Copyright Protection

Unauthorized copying, broadcasting, public performance, and lending of disks are prohibited. This product incorporates copyright protection technology that is protected by method claims of certain U.S. patents and other intellectual property rights owned by Macrovision Corporation and other rights owners. Use of this copyright protection technology must be authorized by Macrovision Corporation, and is intended for home and other limited viewing uses only unless otherwise authorized by Macrovision Corporation. Reverse engineering or disassembly is prohibited.

Important Safety Instructions

1. **Read Instructions:** All the safety and operating instructions should be read before the product is operated.
2. **Retain Instructions:** The safety and operating instructions should be retained for future reference.
3. **Heed Warnings:** All warnings on the product and in the operating instructions should be adhered to.
4. **Follow Instructions:** All operating and usage instructions should be followed.
5. **Cleaning:** Unplug this product from the wall outlet before cleaning. Do not use liquid cleaners or aerosol cleaners. Use a damp cloth for cleaning.
6. **Attachments:** Use only attachments recommended by the manufacturer. Use of other attachments may be hazardous.
7. **Water and Moisture:** Do not use this product near water (e.g., near a bath tub, washbowl, kitchen sink, laundry tub, in wet basements, or near a swimming pool and the like).
8. **Accessories:** Do not place this product on an unstable cart, stand, tripod, bracket, or table. Use only with carts, stands, tripods, brackets, or tables recommended by the manufacturer or sold with the product. Any mounting of the product should follow the manufacturer's instructions and should use a mounting accessory recommended by the manufacturer.
9. A product and cart combination should be moved with care. Quick stops, excessive force, and uneven surfaces may cause the product and cart combination to overturn.
10. **Ventilation:** Slots and openings in the cabinet are provided for ventilation to ensure reliable operation of the product and to protect it from overheating. These openings should never be blocked by placing the product on a bed, sofa, rug, or other similar surface. This product should not be placed in a built-in installation such as a bookcase or rack unless proper ventilation is provided or the manufacturer instructions have been adhered to.
11. **Power Sources:** This product should be operated only from the type of power source indicated on the rating label. If you are not sure of the type of power supply to your home, consult your product dealer or local power company. For products intended to operate from battery power or other sources, refer to the operating instructions.
12. **Grounding or Polarization:** This product may be equipped with a polarized alternating-current line plug that has one blade wider than the other. This plug will only fit into the power outlet in one direction. This is a safety feature. If you are unable to insert the plug fully into the outlet, try reversing the direction of the plug. If the plug should still fail to fit, contact an electrician to replace the obsolete outlet. Do not defeat the safety purpose of the polarized plug.
13. **Power-Cord Protection:** Power supply cords should be routed so that they are not likely to be walked on or pinched by items placed upon or against them, paying particular attention to cords at plugs, convenience receptacles, and at the point which they exit from the product.
14. **Protective Attachment Plug:** The product may be equipped with an attachment plug with overload protection. This is a safety feature. See the operating instructions for replacement or directions to reset the protective device. If replacement of the plug is required, be sure the service technician has used a replacement plug that has the same overload protection as the original plug as specified by the manufacturer.
15. **Lightning:** For added protection for this product, unplug it from the wall outlet and disconnect the antenna or cable system during a lightning storm or when it is left unattended and unused for long periods of time. This will prevent damage to the product due to lightning or power-line surges.
16. **Power Lines:** An outside antenna system should not be located in the vicinity of overhead power lines or other electric light or power circuits, or where it can fall into such power lines or circuits. When installing an outside antenna system, extreme care should be taken to keep from touching such power lines or circuits, as contact with them might be fatal.
17. **Overloading:** Do not overload wall outlets, extension cords, or integral convenience receptacles as this can result in a risk of fire or electric shock.
18. **Object and Liquid Entry:** Never push objects of any kind into this product through openings as they may touch dangerous voltage points or short-out parts that could result in a fire or electric shock. Never spill liquid of any kind on the product.
19. **Servicing:** Do not attempt to service this product yourself as opening or removing covers may expose you to dangerous voltage or other hazards. Refer all servicing to qualified service personnel.



Important Safety Instructions

20. **Damage Requiring Service:** Unplug this product from the wall outlet and refer servicing to qualified service personnel under the following conditions: a) when the power-supply or plug is damaged; b) if liquid has been spilled or if objects have fallen into the product; c) if the product has been exposed to rain or water; d) if the product does not operate normally by following the operating instructions. Adjust only those controls that are covered by the operating instructions as improper adjustment of other controls may result in damage and will often require extensive work by a qualified technician to restore the product to its normal operation; e) if the product has been dropped or damaged in any way; f) when the product exhibits a distinct change in performance—this indicates a need for service.
21. **Replacement Parts:** When replacement parts are required, be sure that your service technician has used replacement parts specified by the manufacturer or have the same characteristics as the original part. Unauthorized substitutions may result in fire, electric shock, or other hazards.
22. **Safety Check:** Upon completion of any service or repairs to this product, ask the service technician to perform safety checks to ensure that the product is in proper operating condition.
23. **Wall or Ceiling Mounting:** The product should be mounted to a wall or ceiling only as recommended by the manufacturer.
24. **Heat:** The product should be situated away from heat sources such as radiators, heat registers, stoves, or other products (including amplifiers) that produce heat.
25. **Outdoor Antenna Grounding:** If an outside antenna is connected to the product, be sure the antenna system is grounded so as to provide some protection against voltage surges and built-up static charges. Article 810 of the National Electrical Code, ANS/NFPA 70 provides information with regard to proper grounding of the mast and supporting structure, grounding of the lead-in wire to an antenna-discharge unit, size of grounding conductors, location of antenna-discharge unit, connection to grounding electrodes, and requirements for the grounding electrode (see figure).

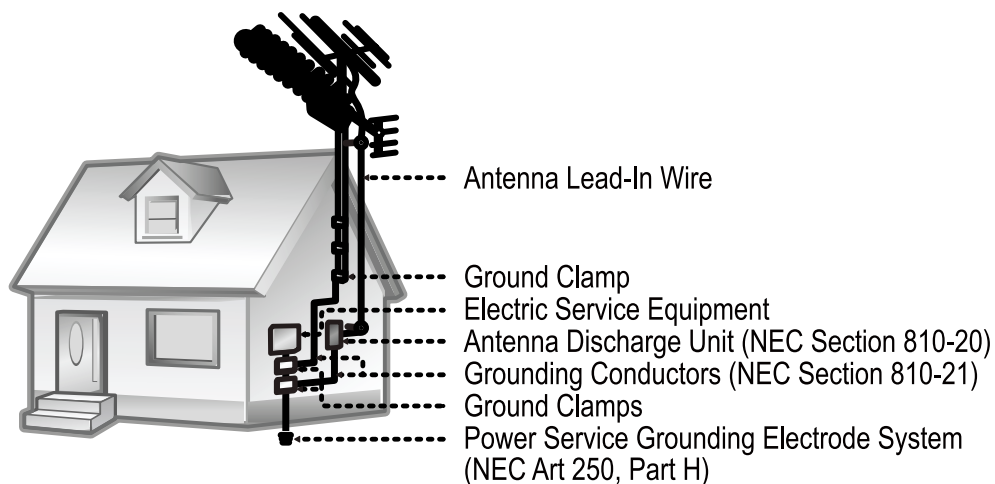

Table of Contents

Table Of Contents

Precautions

Important Safety Instructions

Main Feature-----	1
Package Contents-----	2
Unit View-----	3
Remote Control -----	5
Cable Connections-----	8
TV Function-----	10
AV Function-----	14
PC Function-----	15
DVD Operation-----	16
Playback Function-----	18
DVD Setup-----	20
Troubleshooting -----	22
Specifications -----	23

Main Features

Multiple Mode

TV
AV1
AV2
S-VIDEO
COMPONENT1
COMPONENT2
DVD
HDMI1
HDMI2
VGA

High Quality Property

High Resolution

Adopt an MPEG2 decoding format to achieve horizontal resolution more than 500 lines.

Superior sound

Built-in Dolby Digital decoder to output high quality sound effects.

Screen

Support the picture size of a normal screen (4:3) and a wide screen (16:9)

LCD (Liquid Crystal Display)

Designed with color TFT liquid crystal display clearly shows the data.

Advanced Playing Features

Compatibility

DVD, CD, MP3, CD-R, CD-RW, JPEG discs compatible.

All Playback Functions

Fast forward and reverse, repeat playback, program playback.

NOTE: It is normal for a TFT screen to experience some light or dark spots appearing on the LCD screen.

Package Contents

Please make sure the following items are included with your product. If any item is missing, contact your dealer.

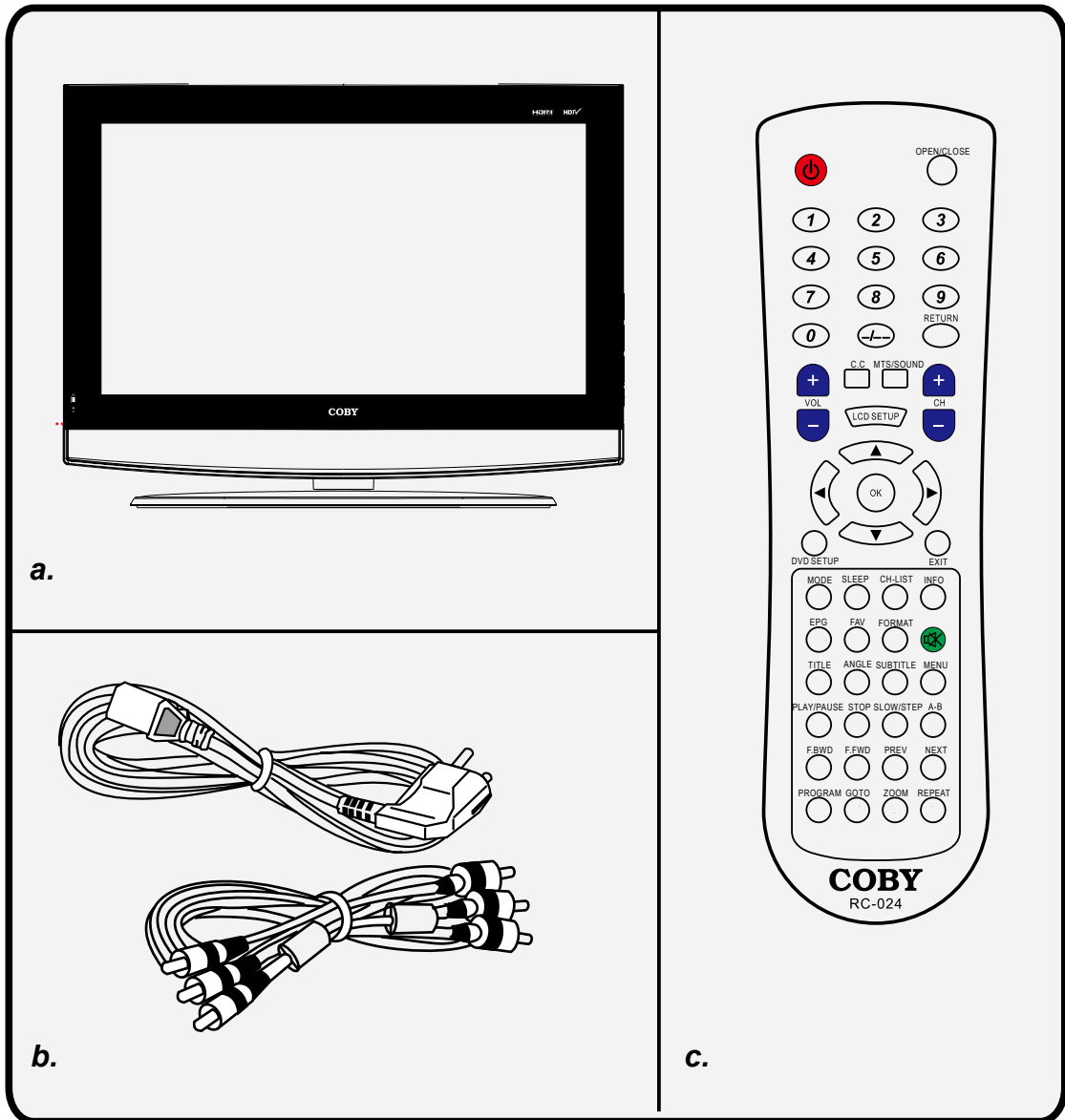

a, Main Unit

b, Power Cord & RCA Cable

c, Remote Control Unit

Unit View

Unit's Front and Side Panel

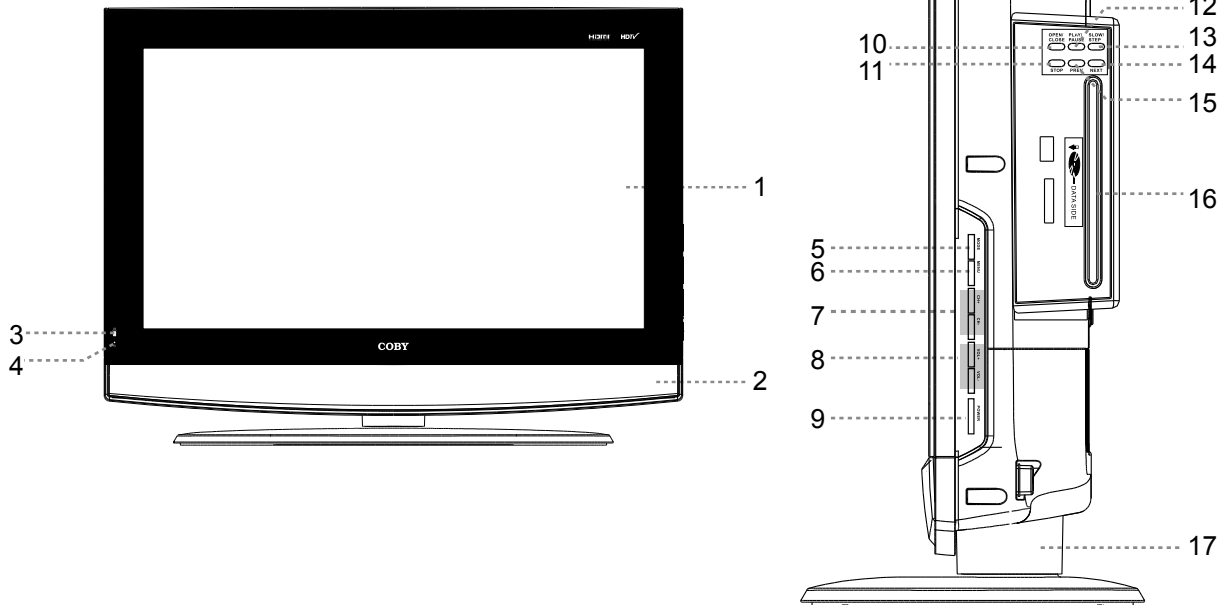

1. TFT Panel
Present the high resolution picture.
2. Speaker
Output sound.
3. Remote Sensor
Sense the remote signal.
4. Power Indicator
Lights green under the normal use.
Lights red in the standby mode.
5. MODE
Press to shift modes.
6. MENU
Press to display the system menu.
7. CH+
Press to skip channels forward.
It also works as the up direction button while working with the menu.
CH-
Press to skip channels backward.
It also works as the down direction button while working with the menu.
8. VOL+
Press to increase the volume.
It also works as the right direction button while working with the menu.
VOL-
Press to decrease the volume.
It also works as the left direction button while working with the menu.
9. POWER
Press to turn the power on/off.
10. OPEN/CLOSE
Press to open/close the disc room.
11. STOP
Press to stop the disc playback.
12. PLAY/PAUSE
Press to start/hold playback.
13. SLOW/STEP
Press to have the playback advanced in a slow motion, which would be further slowed down for each time you pressed this button, if you pause the playback with the Play/Pause button and then repeatedly press this button, it will move step-by-step forward.
14. NEXT
Skip to the next DVD chapters/titles or CD tracks.
15. PREV
Skip to the previous DVD chapters/titles or CD tracks.
16. Disc Slot
Give access to the disc compartment.
17. Stand

Unit View

Unit's rear panel

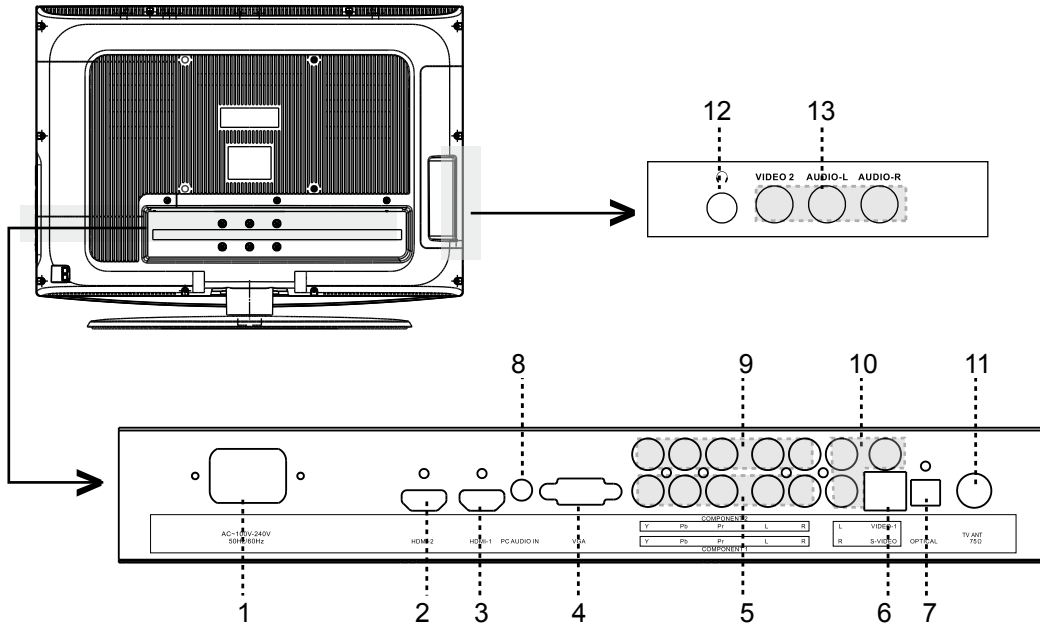

- | | |
|--|--|
| <ul style="list-style-type: none"> 1. Power Jack
Connect to the power supply. 2. HDMI2
HDMI2 connector 3. HDMI1
HDMI1 connector. 4. VGA
Connect with the VGA port on the computer. 5. Component Input1
YCb/Pb Cr/Pr - - Input the video signal.
L, R - - Input the audio signal. 6. S-VIDEO1
Input the S-Video signal. 7. OPTICAL Out
Connect with the digital audio decoder. | <ul style="list-style-type: none"> 8. PC Audio In
Input the PC audio signal. 9. Component Input 2
YCb/Pb Cr/Pr - - Input the video signal.
L, R - - Input the audio signal. 10. AV1 Input
VIDEO 1 - - Input the video signal.
L, R - - Input the audio signal. 11. Antenna Jack
Connect with the TV RF signal source. 12. Phone Jack
Connect with the stereo phone. 13. AV2 Input
VIDEO 2 - - Input the video signal.
L, R - - Input the audio signal. |
|--|--|

Wall Mounting

The TV case can be attached onto the wall, using the VESA standard mounting.

1. Release the screws and take off the unit stand.
2. Use VESA standard mountings to fix the unit onto the wall. Take care when mounting, it may cause damage or serious injury should it fall from the wall.

See the Specifications page for VESA information.

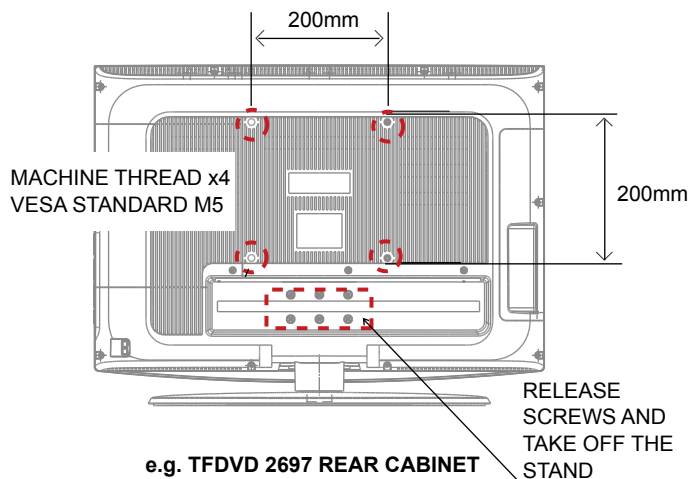

Remote Control

Remote Control Drawing

1. POWER
Press to enter/exit the standby mode.
2. CC
Set the Close Caption mode as CC on Mute/Off/On.
3. VOLUME +/-
Press to adjust the volume.
4. LCD SETUP
Press to show the TV setup menu.
5. DVD SETUP
Press to show the DVD setup menu.
6. OPEN/CLOSE
Press to take in/out the disc.
7. RETURN
Press to locate the previously viewed channel.
8. MTS/SOUND
Under the DVD mode, press to select the audio mode.
Under the ATV mode, press to set the audio as MONO, STEREO or SAP.
Under the TV mode, press to set the audio language.
9. CHANNEL +/-
Press to skip channels.
10. Direction & OK button
When working with the system menu, press the direction buttons to select the option, press OK to confirm settings.
11. EXIT
Press to exit the menu setup.
12. Numeric key pad
Press to input data.
13. MODE
Press to show the mode selective menu.
14. SLEEP
Press to set the sleep timer.
15. EPG
Press to show the Electronic Program Guide.
16. FAV
Press to show the Favorit Channel List. If no channel is set on the list, the button does not function.
17. INFO
Press to show the current working status.
18. CH-LIST
Press to show the channel list.
19. MUTE
Press to muffle/release the sound.
20. FORMAT
Press to change the display format as Normal, Zoom, Cinema or Full.

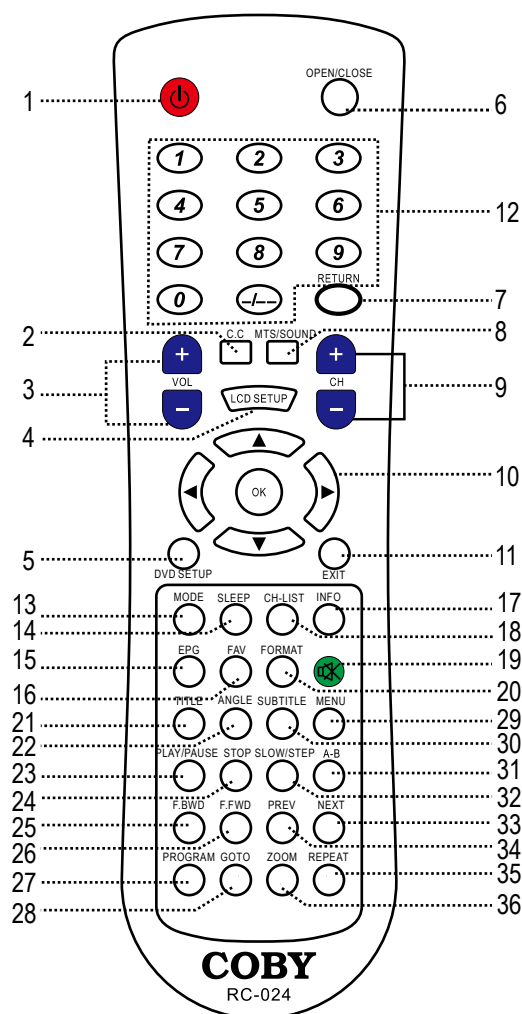

Remote Control

Remote Control Drawing

21. TITLE

Press to show the title menu under the DVD mode.

22. ANGEL

Press to select the available camer angles under the DVD mode.

23. Play/Pause

Press to start/hold playback under the DVD mode.

24. Stop

Press to stop playyback.

25. F.BWD

Press to search fast backward through a disc.

26. F.FWD

Press to search fast forward through a disc.

27. Program

Press to access the program menu.

28. Goto

Go to the desired section in a disc.

29. Menu

Press to show the root menu under the DVD mode.

30. Subtitle

Press to set the subtitle under the DVD mode.

31. A-B

Repeat a specified section A-B on a disc.

32. Slow/Step

Press to have the playback advanced in a slow motion, which would be futher slowed down for each time you pressed this button, if you pause the playback with the Play/Pause button and then repeatedly press this button, it will move step-by-step forward.

33. NEXT

Repeatedly press the button to skip forward through a disc.

34. PREV

Repeatedly press the button to skip backward through a disc.

35. Repeat

Press to repeat a special section on a disc.

36. Zoom

Press to zoom in/out the picture.

Remote Control

Preparation

- Remove the battery compartment cover located on the rear of the remote control. Insert 2 x “AAA” batteries, making sure to match their polarities (+/-) to the markings on the inside of the compartment. Replace the cover.
- Batteries in the remote will last for approximately 6 months under the normal use. Replace the batteries if the remote control does not work. Do not mix old with new batteries, or different types of batteries.
- Remove the batteries from the remote if it will not be used for a long period of time.

Warnings:

The battery used in this device may present a fire or chemical burn if mistreated. Do not recharge, disassemble, incinerate, or heat the battery (~212°F). Keep batteries away from children.

Using the Remote Control

To use the remote, point it at the remote sensor within 20 feet , by an angle of ± 30 degrees.

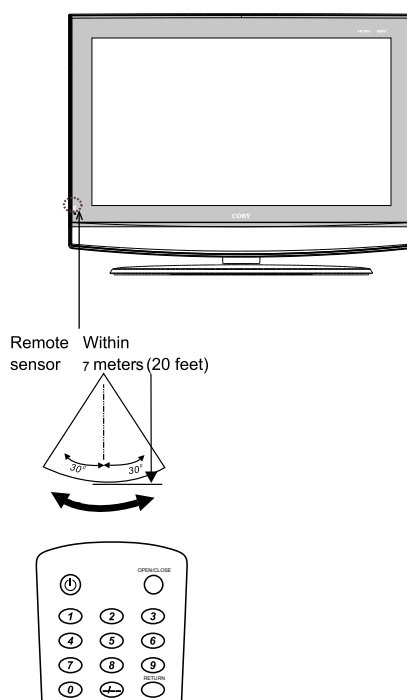

The operating distance may vary depending on the brightness around.

Notes:

1. Do not point bright lights directly at the remote control sensor.
2. Do not place objects between the remote control unit and the remote control sensor.
3. Do not use this remote control for other equipments at the same time.

Cable Connections

Figure. Cable connections

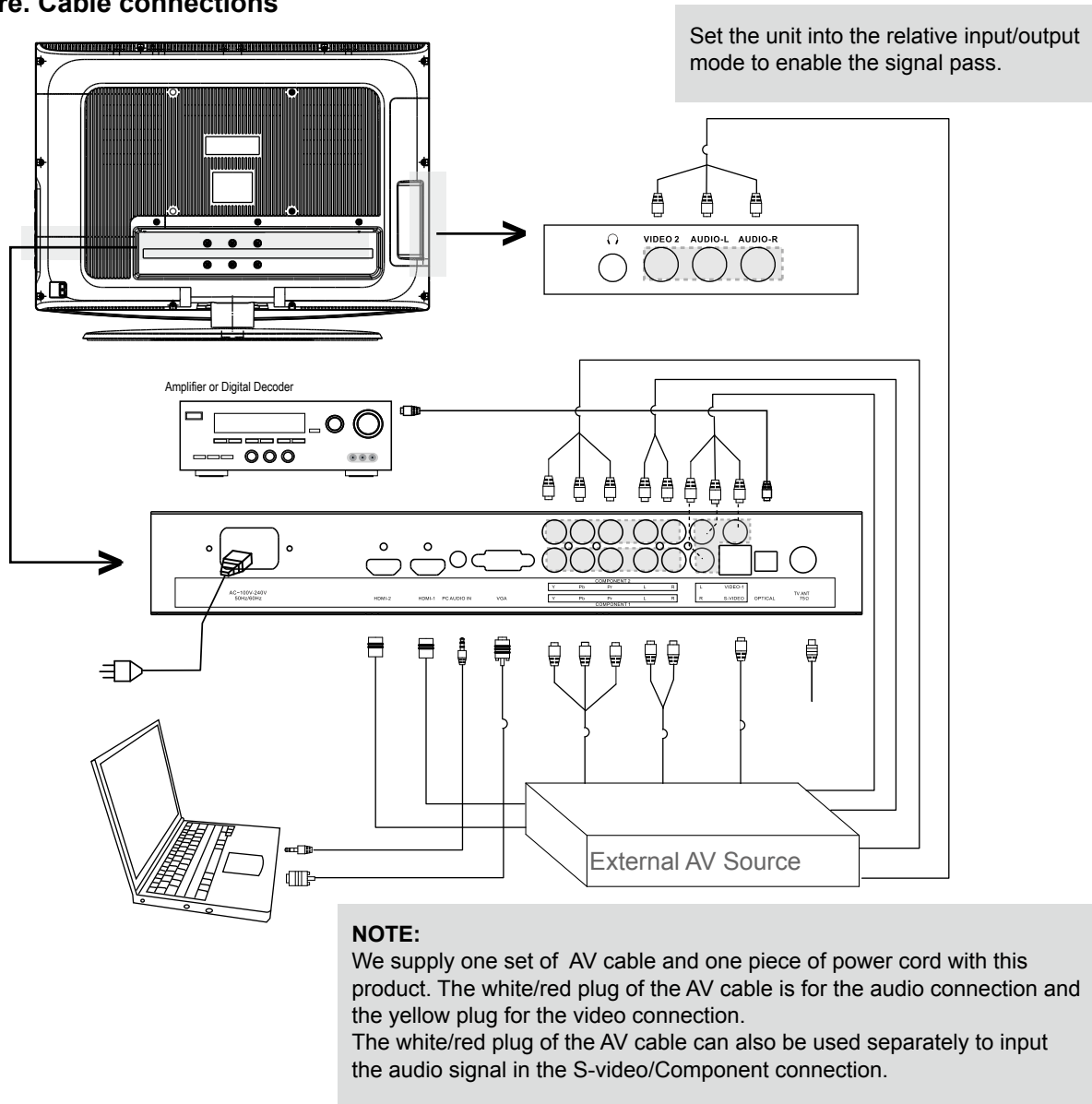

Antenna/Power Connection

1. Connect TV RF sources to the antenna port. TV RF signals include: receiving antenna/CATV net. You can use 75 Ohm coaxial cable to connect outdoor antenna.
2. Insert one end of the supplied power cord to the player's power jack and the other end to the 110-240V AC wall outlet.

Component Input1/2 (Y Cb/Pb Cr/Pr)

The component port is capable of accepting high-definition signals from standard video sources. (e.g., cable/satellite boxes, DVD players, VCRs, etc.)

1. Connect the Y/Pb/Pr port by the component cable to input the video signal.
2. Connect "R" "L" port by the supplied AV cable to input the audio signal. The red/white plug of the AV cable is for the audio connection and the yellow plug for the video connection.

S-Video Input

The S-Video port is capable of accepting signals from standard video sources. (e.g., cable/satellite boxes, DVD players, VCRs, etc.)

1. Connect the S-Video port by the S-Video cable to input the video signal.
2. Connect the AUDIO-L/R port by the supplied AV cable to input the audio signal.

Cable Connections

AV1/2 Input

The CVBS port is capable of accepting signals from standard video sources (e.g., cable/satellite boxes, DVD players, VCRs, etc.)

1. Connect the VIDEO port with the yellow plug of the supplied AV cable.
2. Connect the L/R port with the red & white plug of the supplied AV cable to input the audio signal.

VGA Input

The VGA port of the TV is capable of accepting high-definition signals from computers with a VGA output jack. When used as a computer monitor, connect the VGA jack and the PC Audio In jack with a 15-Pin D-Sub cable and a 3.5mm stereo audio cable.

HDMI/1/2 Input

HDMI (High Definition Multimedia Interface) is a new type of connection that transmits digital audio and video signals simultaneously over a single cable. A HDMI cable is required for the HDMI connection.

These HDMI input connectors are capable of receiving video at resolutions up to 1080p (1080-progressive).

Component Input

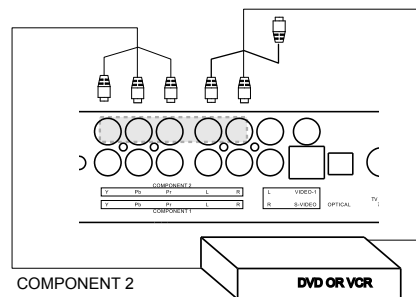
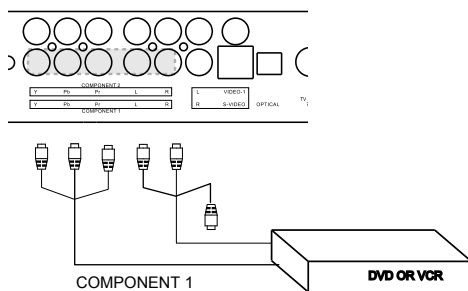

AV Input

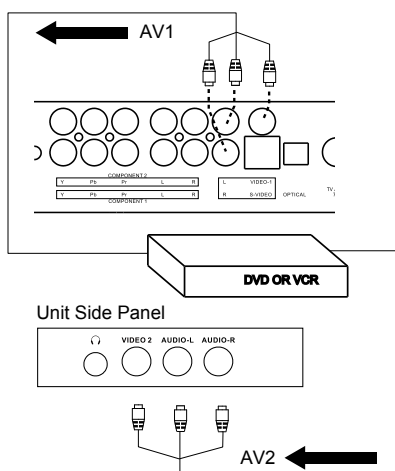

S-Video Input

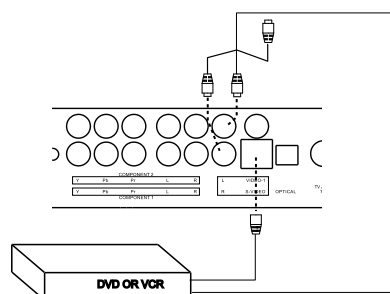

NOTE:

1. Be sure to have all necessary connections properly done before connect the power supply.
2. When input the AV signal, refer to the manual of the external sources as well.

TV Function

Preparations

1. Connect the cables.(Refer to the "Cable Connections" section for details).
2. Press the POWER button to turn on the player.
3. Press the MODE button to select the TV signal mode.
4. Press the CH+/- buttons to skip channels. Or you can press the number buttons to input channels directly. For the initial use, you need to scan channels under the Channel Menu. See the "Channel Menu" section for details.

TV Setup Menu

Various features can be preset through the TV setup menu, please read this section carefully.

- Press LCD SETUP to display the setup menu, TV setup menu consists of PICTURE, AUDIO, TIME, SETUP, LOCK as well as CHANNEL.
- Press the left/right direction button to select the desired submenu, press OK to enter.

While working with the menu,

1. Press the up/down direction button to select the option.
2. Press the left/right direction button to adjust.
3. Press LCD SETUP to exit/back up menu.



Picture Menu

ITEM	DESCRIPTION
Picture Mode	Setup the picture mode (Personal, Standard, Dynamic, Soft).
Contrast	Adjust the display contrast
Brightness	Adjust the display brightness
Color	Adjust the display color
Tint	Adjust the display tint
Sharpness	Adjust the image sharpness
Color Temp	Set the color mode (Normal, Warm, Cool).

TV Function

Audio Menu

ITEM	DESCRIPTION
Sound Mode	Set the sound mode. (Standard, Music, Movie, Sport, Personal).
Bass	Adjust the bass.
Treble	Adjust the treble.
Balance	Adjust the sound balance.
Surround	Set the audio surround effect on/off.
AVC	Set AVC on/off.
Audio Language	Set the DTV audio language.

Time Menu

ITEM	DESCRIPTION
Sleep Timer	The unit will shut down automatically on the Sleep Time. The available option is 5/10/15/30/45/60/90/120/180/240 min, and Off. The count down would start immediately after setting. You can access this function by repeatedly pressing the SLEEP button on the remote also. To check the timer left, press the SLEEP button on the remote once. To cancel the sleep timer, set the timer to Off.
Time Zone	Set the DTV time zone. (Pacific, Alaska, Hawaii, Eastern, Central, Mountain)
Daylight Saving Time	Set the DTV daylight saving function on/off.
Clock	Display the DTV clock information.

TV Function

Setup Menu

ITEM	DESCRIPTION
Menu Language	Set the menu language.
Transparency	Set the OSD(On-Screen-Display) transparency on/off.
Zoom	Set the display aspect ratio. (4:3, Cinema, Normal, 16:9)
Noise Reduction	Adjust the screen noise appearance. (Weak, Middle, Strong, Off)
Closed Caption	<p>Press the right direction button to access the Closed Caption menu.</p> <p>There are four options listed under the Closed Caption menu.</p> <p>CC Mode - Set the CC mode. (Off, On, CC On Mute)</p> <p>Basic Selection - Set the basic CC type. (CC1~4, Text 1~4)</p> <p>Advanced Selection - Set the advanced CC type for DTV. (Service 1~6)</p> <p>Option - Press the right direction button to enter Option.</p> <p>Under the option menu, set Mode as Custom to edit the DTV CC type to your own liking.</p>
DLC	Set DLC on/off
Restore Default	Set the player to the factory default.

Lock Menu

ITEM	DESCRIPTION
Enter Password	You are required to enter the 4-digit password to access the Lock menu. The initial password is 0000.
Change Password	<p>To change the password, input the old password - - > input the new password- - >verify again.</p> <p>Please remember the password since the players's reset function would not revert the password.</p>
System Lock	<p>Set the system lock function on/off.</p> <p>Set the lock function On to access the parental control setup.</p>
Unrated Lock	Set Unrated Lock on/off.
US	<p>Setup the US parental control.</p> <p>TV(TV Rating) - Y, Y7, G, PG, 14, MA.</p> <p>Press the direction buttons to move between options, press OK to set block. To release, press OK again.</p> <p>MPIAA(Movie Rating) - PG-13, R, NC-17, X, N/A, G, PG)</p> <p>Press the left/right direction button to set the movie rating.</p>
Canada	<p>Setup the Canada parental control</p> <p>Canada English - G, PG, 14+, 18+, E, C, C8+.</p> <p>Canada French - E, G, 8ans+, 13ans+, 16ans+, 18ans+.</p>
RRT Setting	Set the rating region table.
Reset RRT	Restore RRT to the default.

TV Function

Channel Menu

ITEM	DESCRIPTION
Air/Cable	Setup the antenna type as Air or Cable.
Auto Scan	Search channels automatically. Select this option, press the right button to start searching, press MENU to stop. When use Cable system, you need to select the cable system first from AUTO, STD, IRC and HRC before scanning.
Favorite	Make the favorite channels collection. Select this option, press the right direction button to access the Favorite List. In the Favorite List, press the up/down direction button to select the desired channel. Press OK to set it as the favorite channel. To release, press OK again. Press the left/right button to turn pages in the FAV list.
Show/Hide	Hide the unwanted channels. Select this option, press the right direction button to access the Show/Hide menu. In the Show/Hide menu, press the up/down direction button to select the channel, press OK to hide the channel, press OK again to release. Press the left/right button to turn pages in the Show/Hide list.
Channel No	Press the left/right direction button to locate a channel.
Channel Label	Edit the channel label. 1. Select the channel you want to put a label. You can use the Channel No option or directly locate the channel in advance by the number button/CH+/- button. 2. Select "Channel Label", press the right direction button to show the edit menu. In the menu, press the left/right direction button to move left/right, press the up/down direction button to change characters.
DTV Signal	Display the DTV signal intensity.

AV Function

The player's AV input function enables the user to view programs from external input sources.

1. Connect the external AV signal source. Refer to the "Cable Connection" section for details
2. Press the MODE button to select the relevant AV mode (AV, S-Video, Component, HDMI)

AV Setup Menu

Various features can be preset through the AV menu.

- Press the LCD SETUP button to display the AV menu. AV setup menu consists of PICTURE, AUDIO, TIME, SETUP as well as LOCK. The LOCK menu is only available for the AV & S-Video mode.
- Press the left/right direction button to select the desired sub-menu, press OK to enter.

While working with the menu

1. Press the up/down direction buttons to select the desired item.
2. Press the left/right direction button to adjust.
3. Press LCD SETUP to exit/back up the menu.



NOTE: Please see the TV section for menu descriptions.

PC Function

You can use the unit's TFT LCD as your computer's monitor.

1. Shut down the unit and the computer, connect the VGA jack and PC Audio In jack. See the "Cable Connection" section.
2. Turn on the units and press the MODE button to select VGA(PC).

PC Setup Menu

Various features can be preset through the PC menu.

- Press the LCD SETUP button to display the PC menu. PC setup menu consists of PICTURE, AUDIO, TIME as well as SETUP.
- Press the left/right direction button to select the desired sub-menu, press OK to enter.

While working with the menu

1. Press the up/down direction buttons to select the desired item.
2. Press the left/right direction button to adjust.
3. Press LCD SETUP to exit/back up the menu.

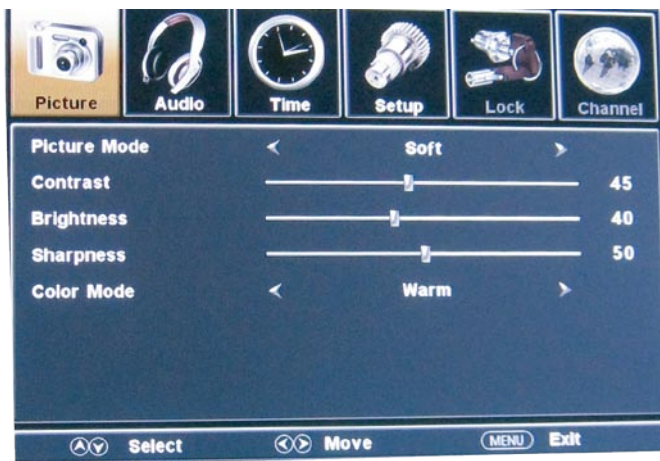

NOTE: Please see the TV section for menu descriptions.

Adjust the PC Screen

Upon switching to the PC mode, the monitor will be automatically regulated for a proper functioning. If the result is not up to your expectation, please perform the following steps to adjust the screen manually .

1. Enter the "Advanced" sub-menu from the SETUP menu, select "Auto" and press the left/right direction button to adjust the monitor automatically.
2. Or if you still have problem with the monitor after, adjust "H-Pos", "V-Pos", "Clock" as well as "Phase" accordingly under the SETUP menu.

DVD Operation

Preparation

After all necessary connections have been made, press POWER to turn on the player and then press the MODE button to select DVD. The following discs can be read by the player : DVD /CD / MP3 /JPEG.

Disc Loading

1. Put the disc slightly into the disc tray.
2. The disc will be taken automatically into the tray.

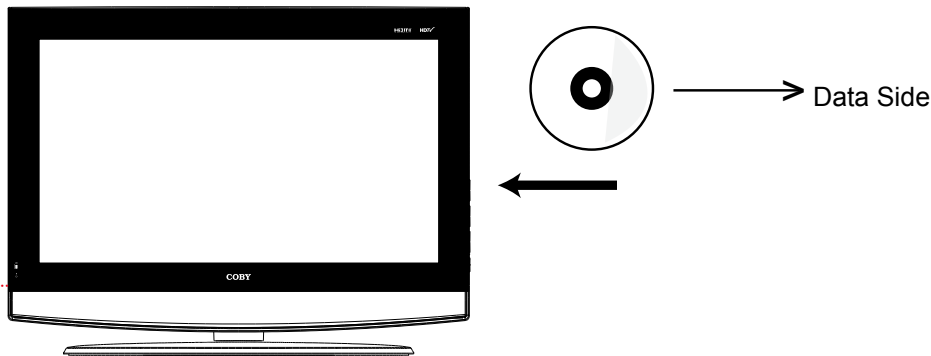

Warning: Do not play poor quality discs that may damage the player's lens.

DVD Playback

MENU

Normally a DVD disc consists of several titles and chapters. The root menu will be displayed automatically once the disc data is recognized by the player. Press the direction buttons to select the desired title/chapter from the menu and press OK to play. During playback, press MENU to display the root menu. Some discs start playback automatically.

SUBTITLE

Press SUBTITLE button to select subtitle language for multi-subtitle discs.

ANGLE

Press the ANGLE button to select the angle. A DVD can be recorded from various camera positions, which lets you enjoy the same scene from different perspectives. In this case, you'll usually find a marking on the DVD sleeve.

DVD Operation

CD Playback

The player will play all tracks on a CD disc by default.

MP3 Playback

1. Load a disc into the disc tray.
2. It will start playback automatically. Or press direction button to select the file from the menu and press OK or PLAY/PAUSE button to start playback. Press left/right button to enter /exit file folders.
3. Press the STOP button to stop playback.

JPEG Playback

JPEG is a common picture format that requires small amounts of storage per image and has low loss in resolution. Hundreds of pictures can be stored on a disc in this format. In order to view JPEG photo albums, you can ask your film development company to make a "PICTURE CD" when they develop your film.

Normal Playback

Load a JPEG disc in.

Press the direction buttons to select the target file and press OK to access.

Picture Rotation

There are four kinds of rotational modes: Inversion, Enantiomorphism, rotate left and rotate right.

Press direction buttons to select:

"UP" ----- Inversion/Normal

"DOWN" ----- Enantiomorphism/Normal

"LEFT" ----- Rotate left

"RIGHT" ----- Rotate right

Zoom

Press ZOOM button to zoom in/out picture.

Press direction buttons to move the zoomed picture.

During playback, press the STOP button to return to the previous menu.

NOTE: Depending on how the disc was made, a JPEG disc may allow playback , but not rotation or zooming of the images.

Playback Function

Start Playing

Press PLAY/PAUSE to start playback

Pause Playing

During playback, press PLAY/PAUSE once to hold playing, press it again to resume.

Stop Playing

Press STOP once to stop playback at a time point. (Pre-stop mode) It will resume from where it was stopped. Press it twice to stop playback completely.

Repeat Function

Use the REPEAT button to perform the repeat function.

1. Repeatedly press the REPEAT button to cycle through the repeat modes as below,
DVD Mode REP: CHAPTER --> REP:TITLE --> REP:ALL--> REP:OFF
CD Mode REP: 1 --> REP:ALL --> REP:OFF
2. Use the A-B button on the remote to repeat a section A-B. Press A-B once to set the starting point A, press it twice to set the ending point B, the player starts repeating section A-B. To cancel, press A-B.

NOTE: Some discs do not support the repeat function.

Search Function

Go to the desired section in a disc.

Press the GOTO button, below picture appears on the screen.

DVD

Search by title /chapter/time

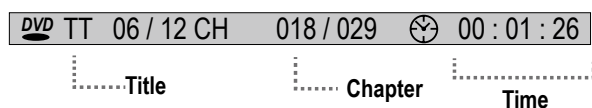

DVD TT 06 / 12 CH 018 / 029 ⌚ 00 : 01 : 26

.....Title Chapter

CD/MP3

Search by track / time

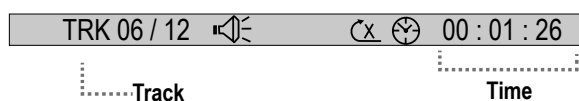

TRK 06 / 12 🔊 ⌚ 00 : 01 : 26

.....Track Time

1. Press the direction buttons to move between title/chapter/time entry, press the numeric buttons to input data. Press the OK button to start search.
2. Press GOTO once again to exit.

NOTE: Some DVD discs do not support the search function.

Fast Playback

Press F.FWD/F.BWD on the remote to go fast forward/backward through a disc. Repeatedly press the button to change the search speed as below.



PLAY — FORWARD/BACKWARD x2 — x4 — x8 — x20

Playback Function

Slow Playback

During playback, press the SLOW/STEP button to start slow motion playback, which would be further slowed down for each time you pressed this button, if you pause the playback with the Play/Pause button and then repeatedly press this button, it will move step-by-step forward.

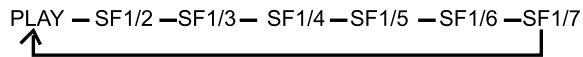

Zoom Function

Repeatedly press the ZOOM button to achieve the following zoom effect.

ZOOM 2 - ZOOM3 - ZOOM 4 - ZOOM1/2 - ZOOM1/3 - ZOOM1/4 - ZOOM:OFF

NOTE: There is no zoom function for MP3 or CD discs.

Programming Chapters/Tracks

You can store up to 16 programs.

1. Press the PROGRAM button to display the program menu.

e.g. DVD Mode

PROGRAM			
T	C	T	C
1	-- : --	5	-- : --
2	-- : --	6	-- : --
3	-- : --	7	-- : --
4	-- : --	8	-- : --
		9	-- : --
		10	-- : --
		11	-- : --
		12	-- : --
		13	-- : --
		14	-- : --
		15	-- : --
		16	-- : --

PLAY CLEAR

2. Press the direction buttons to move between the input fields and press the number buttons to input data.
3. Press direction buttons to select "Play " and press OK to start playback.
4. To clear, select "CLEAR" from the menu and press OK.
5. To quit, press the Program button.

DVD Setup

Various features can be preset through the DVD setup menu and the TV setup menu. Use the LCD SETUP button to access the TV setup menu, read the TV section for detailed menu descriptions.

Press the DVD SETUP button to display the DVD menu.

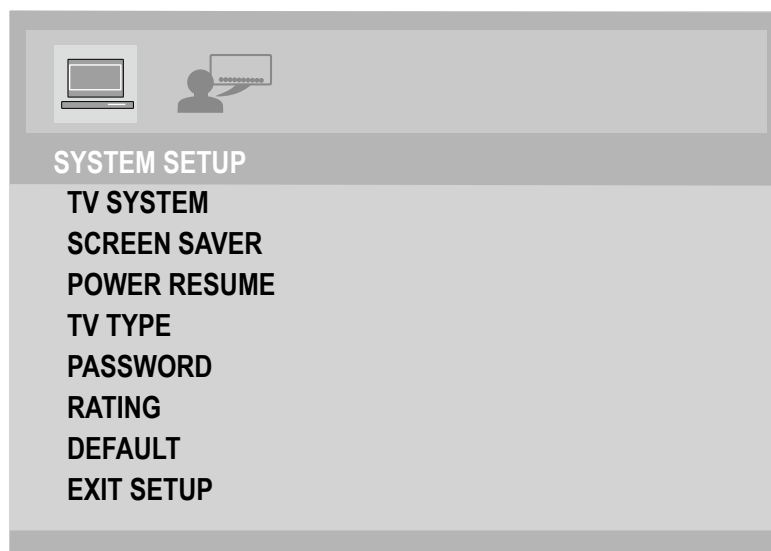

While working with the setup menu:

1. Press the direction buttons to select the desired item.
2. Press the right direction button or the OK button to confirm.
3. To exit, press DVD SETUP again.

System Setup

1. **TV System** - Select the TV System from NTSC/PAL/AUTO. The default setting is NTSC. (The TV System for north America is NTSC. AUTO should only be used if you have a Multi-System TV).
2. **Screen Saver** - Set the Screen Saver ON/OFF. The default setting is On. The screen saver is useful to prevent your display from becoming damaged. If the Screen Saver is set ON, the screen saver picture appears when you leave the player in the stop mode for about a few minutes. Press any button on the unit/remote to exit the screen saver.
3. **Power Resume** - Set the power resume function On/Off. The default setting is Off.
4. **TV Type** - Set the screen aspect ratio as 4:3 PS(Pan Scan), 4:3 LB(Letter Box) or 16:9(Wide Screen).
4:3 LB(Letter Box): This is selected when the unit is connected to a normal TV. 4:3 PS(Pan Scan): This is selected when the unit is connected to anormal TV. Wide-screen images are shown on the screen with some parts cut out automatically.
5. **Rating** - There are eight levels of Parental Control. Level one opens discs to people of all ages, level eight is suitable only for adults. To change the parental control setting, a 4-digit code is required to be input first. (The default code is 8888). When the input code is confirmed, the level setting menu will appear, select the appropriate level by the UP/DOWN button and press OK to confirm.

DVD Setup

6. **Password** - Move the cursor to the PASSWORD prompt and press OK. Input the password 8888, if it is the first use. After confirmation, you will be required to input a new 4-digit code, and verify again.
7. **Default** - This function allows you to set the unit back to the factory default.

Language Setup

Item	Instruction	Default
OSD Language	Setup the OSD language.	English
Audio Language	Setup the audio language.	English
Subtitle Language	Setup the subtitle language. When OFF is selected, the subtitle will not be displayed.	English
Menu Language	Setup the menu language.	English

Trouble Shooting

If you have a problem with this device, please read the troubleshooting guide section and check our website at www.cobyusa.com for Frequently Asked Questions (FAQs) and firmware updates. If these resources do not resolve the problem, please contact Technical Support.

Address

COBY Electronics Technical Support
56-65 Rust Street
Maspeth, NY 11378

Email

techsupport@cobyusa.com

Web

www.cobyusa.com

Phone

800-727-3592: Weekdays 8:30AM -9:00PM EST

Saturdays 9:00AM -5:30PM EST

718-416-3197: Weekdays 8:00AM -5:30PM EST

Symptom	Check and Action
No Power	<ul style="list-style-type: none">• Make sure the unit has been powered on manually.• Check if the power cord has been properly connected to the power outlet.• Check if the main power has been switched on.
No Picture	<ul style="list-style-type: none">• Try another TV channel• Check if the system connection is proper and secure.• Check if the connection cables are damaged.
No Sound	<ul style="list-style-type: none">• Increase the volume.• Check if the MUTE function of the unit has been activated.• Check if the sound system has been properly set.• Check if the AV audio signal input cable has been connected properly.
Color Distorted	<ul style="list-style-type: none">• Reset the color system of the unit.• Check if the system has been properly connected.• Check if the AV video signal input cable is connected properly.
Picture and Sound are interfered	<ul style="list-style-type: none">• Check if the system has been properly connected.• If using antenna, adjust the antenna.
Remote Control does not work	<ul style="list-style-type: none">• Remove the obstacles between the remote control and the player.• Point the remote control towards the remote sensor on the player.• Check if the batteries of the remote control have been loaded with correct polarities.• Replace the batteries of the remote control.
Malfunction	<ul style="list-style-type: none">• Should the player develop a malfunction, unplug the player for 30 minutes. After that, power on the player and the restore function should reset the player.

Specification

TFDVD 2697

TFT Panel Characteristic	Active Area	26"
	Resolution	1366x768
	Display Color	8-bit, 16.7M colors
	Pixel Pitch	140.5(H) x 421.5(V)mm xRGB
TV Characteristic	TV System	ATSC/NTSC
	Tuning System	FS with PLL
	Antenna Impedance	75Ω
Standard	Power Consumption	100-240V 50/60Hz
		On Working 110W(Max)
		Speaker 2x(8Ω,10W)
	Operating Temperature Range	0°C-40°C
	Dimension	26.1"x9.2"x19.7"
	Wall Mounting	VESA M5,200x200MM

TFDVD 3297

TFT Panel Characteristic	Active Area	32"
	Resolution	1366X768
	Display Color	8-bit, 16.7M colors
	Pixel Pitch	510.75mm
TV Characteristic	TV System	ATSC/NTSC
	Tuning System	FS with PLL
	Antenna Impedance	75Ω
Standard	Power Consumption	110-240V 50/60Hz
		On Working 130W(Max)
		Speaker 2x(8Ω,10W)
	Operating Temperature Range	0°C-40°C
	Dimension	31.3"x9.2"x22.9"
	Wall Mounting	VESA M6, 400x200mm

Free Manuals Download Website

<http://myh66.com>

<http://usermanuals.us>

<http://www.somanuals.com>

<http://www.4manuals.cc>

<http://www.manual-lib.com>

<http://www.404manual.com>

<http://www.luxmanual.com>

<http://aubethermostatmanual.com>

Golf course search by state

<http://golfingnear.com>

Email search by domain

<http://emailbydomain.com>

Auto manuals search

<http://auto.somanuals.com>

TV manuals search

<http://tv.somanuals.com>