

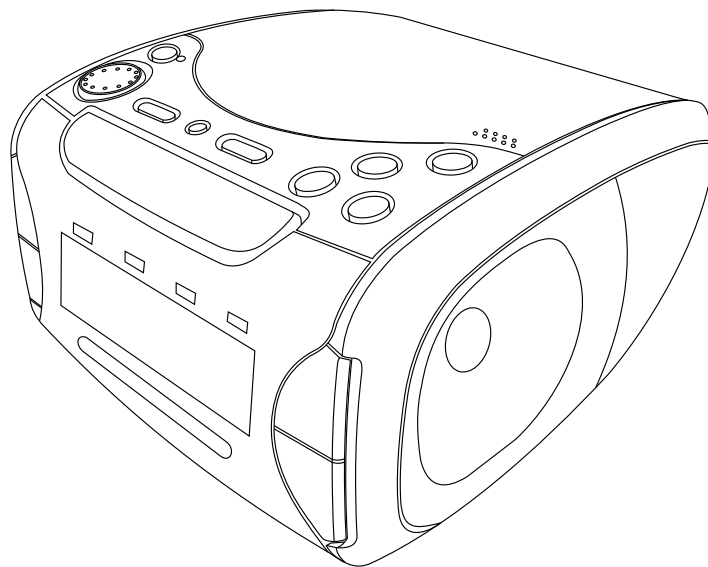

**STEREO RADIO, CD-R/RW
PLAYER WITH ALARM CLOCK**



OWNER'S MANUAL



MODEL NO. CR4975

PLEASE READ BEFORE OPERATING THIS EQUIPEMNT

SAFETY INSTRUCTIONS

	CAUTION RISK OF ELECTRIC SHOCK DO NOT OPEN	
CAUTION: TO REDUCE THE RISK OF ELECTRIC SHOCK, DO NOT REMOVE COVER (OR BACK). NO USER-SERVICEABLE PARTS INSIDE. REFER SERVICING TO QUALIFIED SERVICE PERSONNEL.		



DANGEROUS VOLTAGE

The lightning flash with arrowhead symbol, within an equilateral triangle is intended to alert the user to the presence of uninsulated dangerous voltage within the product's enclosure that may be of sufficient magnitude to constitute a risk of electric shock to persons.



ATTENTION

The exclamation point within an equilateral triangle is intended to alert the user to the presence of important operating and maintenance (servicing) instructions in the literature accompanying the appliance.

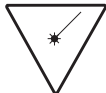

DANGER:

Invisible and hazardous laser radiation when open and interlock failed or defeated. Avoid direct exposure to beam.

FCC WARNING:

This equipment may generate or use radio frequency energy. Changes or modifications to this equipment may cause harmful interference unless the modifications are expressly approved in the instruction manual. The user could lose the authority to operate this equipment if an unauthorized change or modification is made.

SURGE PROTECTORS:

It is recommended to use a surge protector for AC connection. Lightning and power surges ARE NOT covered under warranty for this product.

LASER SAFETY: This unit employs a laser. Only qualified service personnel should attempt to service this device due to possible eye injury.

CAUTION: USE OF CONTROLS, ADJUSTMENTS OR PERFORMANCE PROCEDURE HEREIN MAY RESULT IN HAZARDOUS RADIATION EXPOSURE.

INFORMATION

This equipment has been tested and found to comply with the limits for a Class B digital device, pursuant to Part 15 of the FCC Rules. These limits are designed to provide reasonable protection against harmful interference in a residential installation. This equipment generates, uses, and can radiate radio frequency energy and, if not installed and used in accordance with the instructions, may cause harmful interference to radio communications. However, there is no guarantee that interference will not occur in a particular installation. If this equipment does cause harmful interference to radio or television reception, which can be determined by turning the equipment off and on, the user is encouraged to try to correct the interference by one or more of the following measures:

- Reorient or relocate the receiving antenna.
- Increase the separation between the equipment and receiver.
- Connect the equipment into an outlet on a circuit different from that to which the receiver is connected.
- Consult the dealer or an experienced radio/TV technician for help.

SAFETY INSTRUCTIONS (CONTINUED)

Before using the unit, be sure to read all operating instructions carefully. Please note that these are general precautions and may not pertain to your unit. For example, this unit may not have the capability to be connected to an outdoor antenna.

1. READ INSTRUCTIONS

All the safety and operating instructions should be read before the product is operated.

2. RETAIN INSTRUCTIONS

The safety and operating instructions should be retained for future reference.

3. HEED WARNINGS

All warnings on the product and in the operating instructions should be adhered to.

4. FOLLOW INSTRUCTIONS

All operating and use instructions should be followed.

5. CLEANING

Unplug this product from the wall outlet before cleaning. Do not use liquid cleaners or aerosol cleaners. Use a dry cloth for cleaning.

6. ATTACHMENTS

Do not use attachments not recommended by the product's manufacturer as they may cause hazards.

7. WATER AND MOISTURE

Do not use this product near water—for example: near a bathtub, washbowl, kitchen sink or laundry tub; in a wet basement; or near a swimming pool.

8. ACCESSORIES

Do not place this product on an unstable cart, stand, tripod, bracket or table. The product may fall, causing serious injury and serious damage to the product. Use only with a cart, stand, tripod, bracket or table recommended by the manufacturer or sold with the product. Any mounting of the product should follow the manufacturer's instructions, and should use a mounting accessory recommended by the manufacturer.

PORTABLE CART WARNING
(symbol provided by RETAC)



8A. An appliance and cart combination should be moved with care. Quick stops, excessive force and uneven surfaces may cause the appliance and cart combination to overturn.

9. VENTILATION

Slots and openings in the cabinet and in the back or bottom are provided for ventilation, to ensure reliable operation of the product and to protect it from overheating. These openings must not be blocked or covered. The openings should never be blocked by placing the product on a bed, sofa, rug or other similar surface. This product should never be placed near or over a radiator or heat source. This product should not be placed in a built-in installation such as a bookcase or rack unless proper ventilation is provided or the manufacturer's instructions have been adhered to.

10. POWER SOURCES

This product should be operated only from the type of power source indicated on the marking label. If you are not sure of the type of power supply to your home, consult your appliance dealer or local power company. For products intended to operate from battery power, or other sources, refer to the operating instructions.

11. GROUNDING OR POLARIZATION

This product is equipped with a polarized alternating-current line plug (a plug having one blade wider than the other). This plug will fit into the power outlet only one way. This is a safety feature. If you are unable to insert the plug fully into the outlet, try reversing the plug. If the plug should still fail to fit, contact your electrician to replace your obsolete outlet. Do not defeat the safety purpose of the polarized plug.

12. POWER-CORD PROTECTION

Power-supply cords should be routed so that they are not likely to be walked on or pinched by items placed upon or against them, paying particular attention to cords at plugs, convenience receptacles, and the point where they exit from the appliance.

13. LIGHTNING

To protect your product from a lightning storm, or when it is left unattended and unused for long periods of time, unplug it from the wall outlet and disconnect the antenna or cable system. This will prevent damage to the product due to lightning and power-line surges.

14. POWER LINES

An outside antenna system should not be located in the vicinity of overhead power lines or other electric light or power circuits, or where it can fall into such power lines or circuits. When installing an outside antenna system, extreme care should be taken to keep from touching such power lines or circuits as contact with them might be fatal.

SAFETY INSTRUCTIONS (CONTINUED)

15. OVERLOADING

Do not overload wall outlets and extension cords as this can result in a risk of fire or electric shock.

16. OBJECT AND LIQUID ENTRY

Never push objects of any kind into this product through openings as they may touch dangerous voltage points or short out parts that could result in fire or electric shock. Never spill or spray any type of liquid on the product.

17. OUTDOOR ANTENNA GROUNDING

If an outside antenna is connected to the product, be sure the antenna system is grounded so as to provide some protection against voltage surges and built-up static charges. Section 810 of the National Electric Code, ANSI/NFPA 70, provides information with respect to proper grounding of the mast and supporting structure, grounding of the lead-in wire to an antenna discharge product, size of grounding conductors, location of antenna discharge product, connection to grounding electrodes and requirements for grounding electrodes.

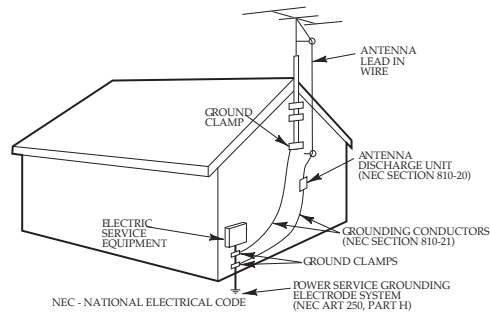

EXAMPLE OF ANTENNA GROUNDING AS PER NATIONAL ELECTRICAL CODE

18. SERVICING

Do not attempt to service this product yourself as opening or removing covers may expose you to dangerous voltage or other hazards. Refer all servicing to qualified service personnel.

19. REPLACEMENT PARTS

When replacement parts are required, be sure the service technician uses replacement parts specified by the manufacturer or those that have the same characteristics as the original part. Unauthorized substitutions may result in fire, electric shock or other hazards.

20. SAFETY CHECK

Upon completion of any service or repairs to this product, ask the service technician to perform safety checks to determine that the product is in proper operating condition.

21. WALL OR CEILING MOUNTING

The product should be mounted to a wall or ceiling only as recommended by the manufacturer.

22. DAMAGE REQUIRING SERVICE

Unplug the product from the wall outlet and refer servicing to qualified service personnel under the following conditions:

- When the power-supply cord or plug is damaged.
- If liquid has been spilled or objects have fallen into the product.
- If the product has been exposed to rain or water.
- If the product does not operate normally by following the operating instructions. Adjust only those controls that are covered by the operating instructions, as an adjustment of other controls may result in damage and will often require extensive work by a qualified technician to restore the product to its normal operation.
- If the product has been dropped or the cabinet has been damaged.
- When the product exhibits a distinct change in performance—this indicates a need for service.

23. HEAT

The product should be situated away from heat sources such as radiators, heat registers, stoves or other products (including amplifiers) that produce heat.

24. NOTE TO CATV SYSTEM INSTALLER

This reminder is provided to call the CATV system installer's attention to Article 820-40 of the NEC that provides guidelines for proper grounding and, in particular, specifies that the cable ground shall be connected to the grounding system of the building, as close to the point of cable entry as practical.

INSTALLATION

Unravel the AC cord and connect it to a conveniently located AC outlet having 120V and 60Hz only. The Clock Display will illuminate and "12:00" will appear in the window.

NOTE: If the AC plug does not fit into a nonpolarized outlet, do not file or cut the wide blade. It is the user's responsibility to have an electrician replace the obsolete outlet.

If the AC cord is disconnected or if there is a power failure, this electronic clock is designed to continue operating internally (without showing the time on the Clock Display) with a 9 volt battery (not included). To install the battery, press and lift open the compartment cover. Connect the battery to the terminals of the battery snap inside the compartment (use of an alkaline battery is recommended) and snap the battery compartment cover back into place.

Be sure to check the condition of the battery periodically by disconnecting the AC cord and connecting it again two or three minutes later. The preset times should continue operating. If the present time does not appear, it indicates the battery is dead or not connected properly. The 9 volt battery will keep the internal times accurately for approximately 30 minutes. If the power is restored after 30 minutes, the times may need to be reset.

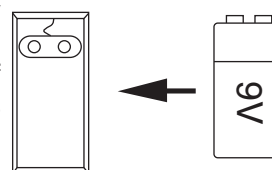
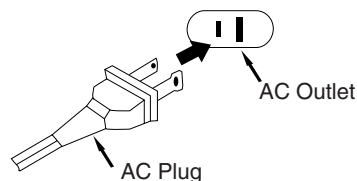

BATTERY PRECAUTIONS

Follow these precautions when using a battery in this device:

1. Use only the size and type of battery specified.
2. Be sure to follow the correct polarity when installing the battery as indicated in the battery compartment. A reversed battery may cause damage to the device.
3. If the device is not to be used for a long period of time, remove the battery to prevent damage or injury from possible battery leakage.
4. Do not try to recharge a battery not intended to be recharged; it can overheat and rupture. (Follow battery manufacturer's directions.)

LOCATION OF CONTROLS

FRONT/TOP

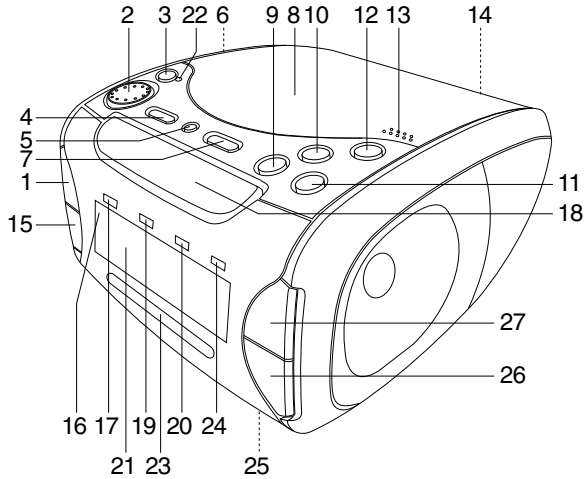

SIDE

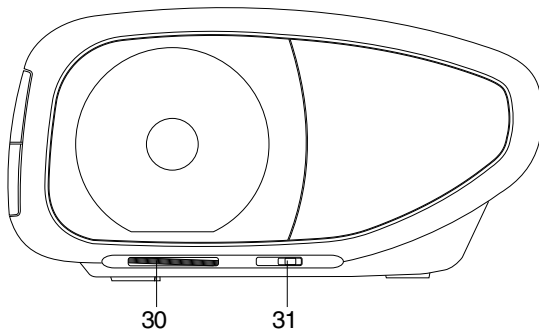
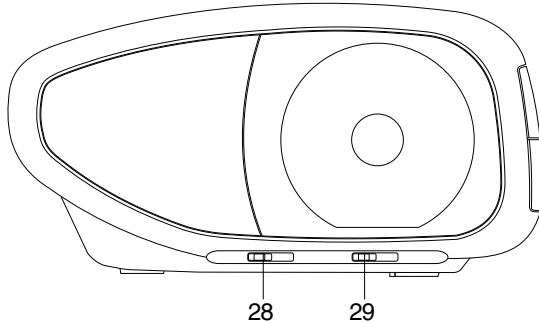

1. SKIP Up **⏮** Button
2. VOLUME Button
3. SLEEP Button
4. HOUR Button
5. Clock Set Button
6. AC Cord (rear of unit)
7. MIN Button
8. CD Compartment
9. ALM button
10. RAND Button
11. REP Button
12. DIMMER Button
13. CD OPEN/CLOSE Area
14. FM Antenna Wire (rear of unit)
15. SKIP Down **⏭** Button
16. PM Indicator
17. FM ST. Indicator
18. SNOOZE Button
19. REPEAT Indicator
20. PLAY/RANDOM Indicator
21. Display
22. Sleep LED
23. AM/FM Dial Scale and Pointer
24. POWER Indicator
25. Battery Compartment (Bottom of unit)
26. STOP (■) Button
27. PLAY/PAUSE (▶/||) Button
28. BUZZER/MUSIC Switch
29. AUTO/OFF/ON Switch
30. TUNING Control
31. FUNCTION (AM/FMST./CD) Switch

RADIO OPERATION

TO PLAY THE RADIO

1

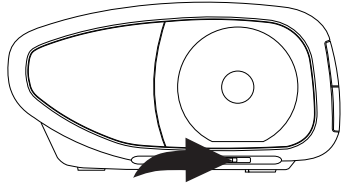

Slide the AUTO/OFF/ON switch to the ON position to turn the unit on; the POWER indicator will light.

2

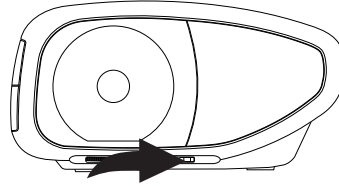

Slide the FUNCTION switch  to the desired band (AM or FM).

3

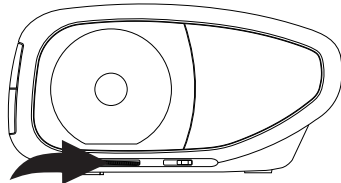

Tune a station by turning the TUNING control. If you tune a station broadcasting in stereo, the FM STEREO indication will light.

4

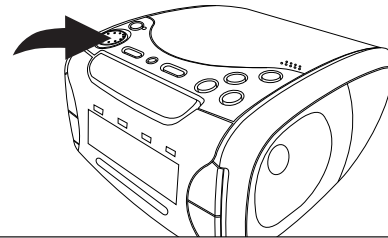

Adjust the VOLUME control as desired.

Antennas

FM: Extend the FM antenna wire for better FM reception.

AM: Turn the unit for better AM reception.

CD OPERATION

TO PLAY A CD

1

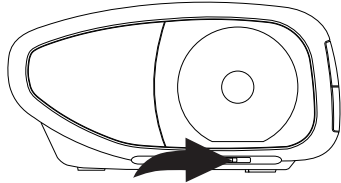

Slide the AUTO/OFF/ON switch to the ON position to turn the unit on; the POWER indicator will light.

2

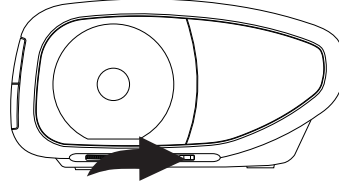

Slide the FUNCTION switch to the CD position.

3

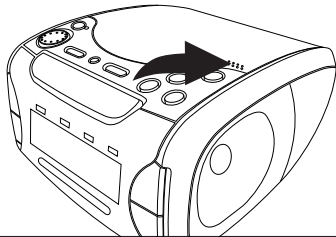

Open the CD compartment door by pressing the OPEN/CLOSE area. Insert a disc, label side up, onto the spindle and close the CD compartment door.

4

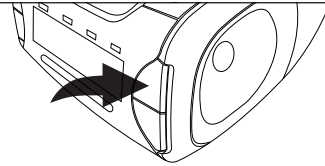

To play a disc from the beginning, press the PLAY/PAUSE (▶/||) button; the PLAY/RAND indicator will light. Press the PLAY/PAUSE (▶/||) button again to pause playback; the PLAY/RAND indicator will blink. Press the PLAY/PAUSE (▶/||) button once again to continue playback.

5

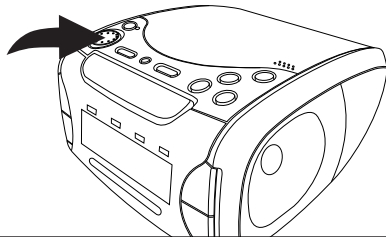

Adjust the VOLUME control as desired.

6

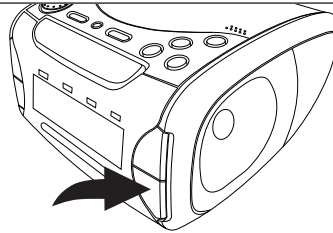

When the disc is through playing, it will stop rotating. Press the STOP (■) button to stop the disc before it is finished.

CD OPERATION (CONTINUED)

TO SKIP/SEARCH

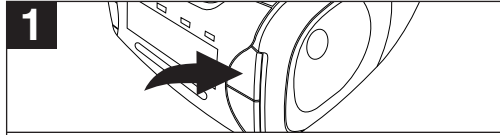

Turn on the unit, insert a CD and press the PLAY/PAUSE (▶/||) button to begin playback.

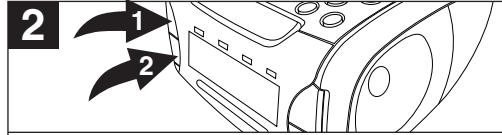

Press the Skip Up ▶▶ ① or Skip Down ◀◀ ② button to select a desired track. Press and hold the Skip Up ▶▶ ① or Skip Down ◀◀ ② button to quickly search for a musical passage.

NOTES:

- If a disc is inserted incorrectly, dirty or damaged, it will not play.
- To prevent damage to the disc, never open the CD door while the disc is rotating. Wait for the disc to stop before opening the CD door. Never touch the lens when the CD door is open.
- The CD player should only be used on a steady surface.

RANDOM PLAYBACK

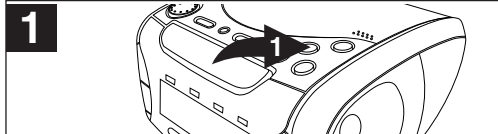

To randomly playback the tracks on a CD, press the RANDOM button ①; the CD will automatically start playing and the PLAY/RAND indicator will blink with different patterns. **TO CANCEL**, press the RANDOM button ① once again; the PLAY/RANDOM indicator will light.

TO REPEATEDLY PLAY BACK ONE TRACK/ALL TRACKS

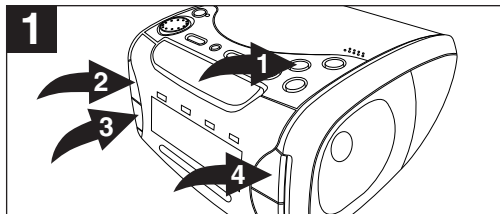

To repeat a single track, press the REPEAT button ① once; the REPEAT indicator will blink. Press the PLAY/PAUSE (▶/||) button ④ to begin playback. Press the Skip Up ▶▶ ② or Skip Down ◀◀ ③ button to select the specific track that you wish to repeat. The specific track you selected will be repeated continuously.

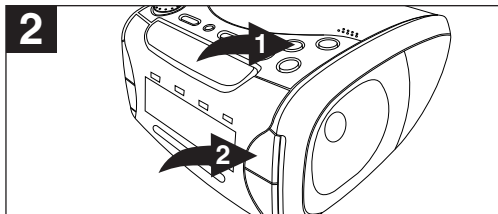

To repeat all of the tracks on a disc continuously, press the REPEAT button ① twice; the REPEAT indicator will light. Press the PLAY/PAUSE (▶/||) button ② to begin playback. All tracks will be repeated continuously. **TO CANCEL**, press the REPEAT button ① again; the REPEAT indicator will turn off.

CLOCK/ALARM SETTING

TO SET OR RESET THE ACTUAL TIME

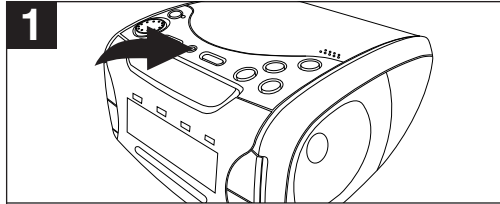

Press and hold the CLOCK SET button.

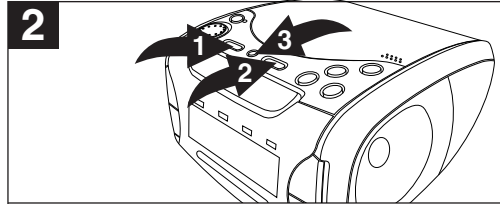

Press and hold the HR (Hour) ❶ button to set the hour and the MIN (Minute) ❷ button to set the minutes. When setting the hours, make sure the PM indicator is lit if it is PM and not lit if it is AM. Release the CLOCK SET button ❸.

TO SET OR RESET THE ALARM TIME

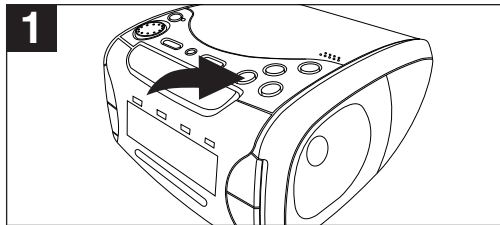

Press and hold the ALARM SET button.

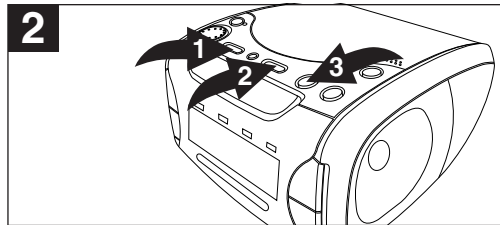

Press the HR (Hour) ❶ button to set the alarm hour and the MIN (Minute) ❷ button to set the alarm minutes. When setting the alarm hour, make sure the PM indicator is lit if it is PM and not lit if it is AM. Release the ALARM SET button ❸.

CLOCK/ALARM SETTING (CONTINUED)

TO SET THE ALARM TO WAKE TO RADIO

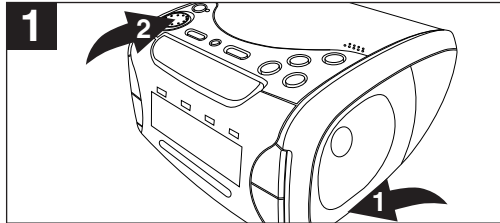

1 Set the alarm time as previously instructed. Slide the FUNCTION switch ❶ to the AM or FM ST. position, select a radio station and make sure the VOLUME control ❷ is set as desired.

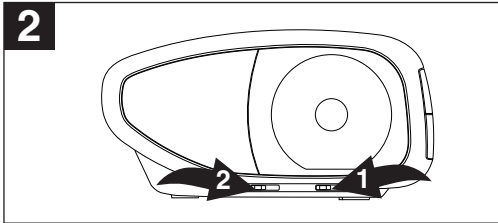

2 Slide the AUTO/OFF/ON ❶ switch to the AUTO position and the BUZZER/MUSIC switch ❷ to the MUSIC position. Slide the FUNCTION switch (other side of unit) to the AM or FM ST. position as desired. With the power off, when the actual time matches the selected preset alarm time(s), the radio automatically turns on for 120 minutes and then shuts off. To shut off the alarm, see TO SHUT ALARM OFF section on the next page.

TO SET THE ALARM TO WAKE TO CD

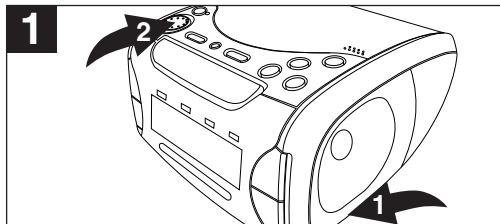

1 Set the alarm time as previously instructed. Slide the FUNCTION switch ❶ to the CD position, insert a CD and make sure the VOLUME control ❷ is set as desired.

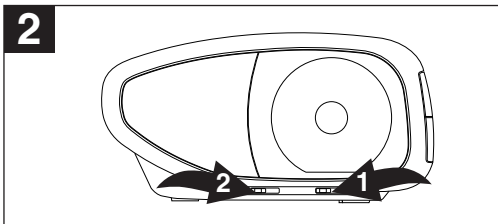

2 Slide the AUTO/OFF/ON ❶ switch to the AUTO position and the BUZZER/MUSIC switch ❷ to the MUSIC position. Slide the FUNCTION switch (other side of unit) to the CD position as desired. With the power off, when the actual time matches the selected preset alarm time(s), the CD automatically turns on for 120 minutes and then shuts off. To shut off the alarm, see TO SHUT ALARM OFF section on the next page.

NOTE: Play will begin on track 1 unless the programmed play is set.

CLOCK/ALARM SETTING (CONTINUED)

TO SET THE ALARM TO WAKE TO BUZZER

1

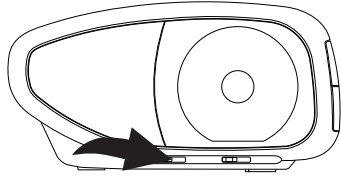

Set the alarm time as previously instructed. Slide the BUZZER/MUSIC switch to the BUZZER position.

2

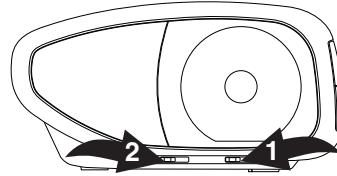

Slide the AUTO/OFF/ON ❶ switch to the AUTO position and the BUZZER/MUSIC switch ❷ to the BUZZER position. With the power off, when the actual time matches the selected preset alarm time(s), the buzzer automatically turns on for 60 minutes and then shuts off. To shut off the alarm, see TO SHUT ALARM OFF section below.

TO SHUT ALARM OFF

1

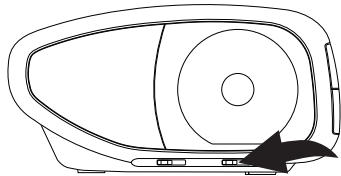

To shut the alarm off, slide the AUTO/OFF/ON switch to the OFF position.

SNOOZE

1

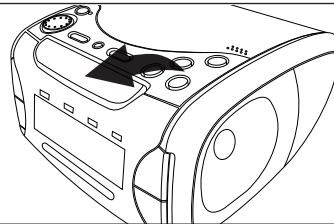

The alarm can be temporarily turned off manually by pressing the SNOOZE button; the alarm will turn back on automatically nine minutes later. It can be repeated endlessly.

CLOCK/ALARM SETTING (CONTINUED)

TO ACTIVATE THE SLEEP FUNCTION

1

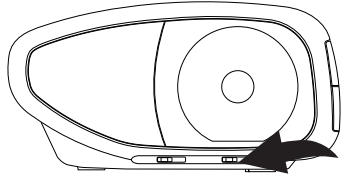

Slide the AUTO/OFF/ON switch to the AUTO position.

2

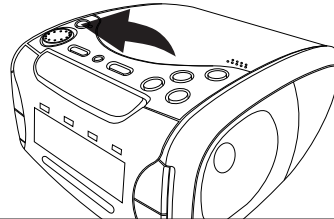

Press the SLEEP button to turn the unit on and select a 59 minutes sleep period; "59" will appear in the display and the SLEEP indicator will light.

3

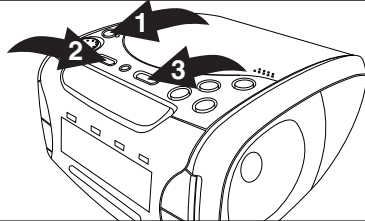

Hold the SLEEP button ❶, then press and hold the HR (Hour) button ❷ to set the hour and/or the MIN (Minute) button ❸ to set the minutes. Maximum sleep time is 1:59.

4

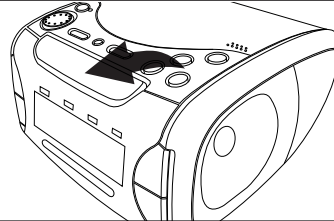

To cancel Sleep time, press the SNOOZE button.

DIMMER BUTTON

1

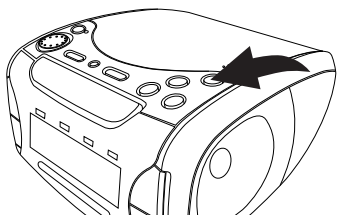

Press the DIMMER button to the HI (in) position to make the display brighter or to the LOW (out) position to make the display dimmer.

CARE AND MAINTENANCE

Caring for Compact Discs

- Treat the disc carefully. Handle the disc only by its edges. Never allow your fingers to come in contact with the shiny, unprinted side of the disc.
- Do not attach adhesive tape, stickers, etc. to the disc label.
- Clean the disc periodically with a soft, lint-free, dry cloth. Never use detergents or abrasive cleaners to clean the disc. If necessary, use a CD cleaning kit.
- If a disc skips or gets stuck on a section of the disc, it is probably dirty or damaged (scratched).
- When cleaning the disc, wipe in straight lines from the center of the disc to the outer edge of the disc. Never wipe in circular motions.

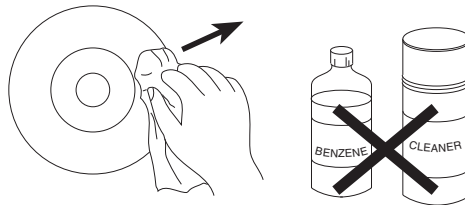
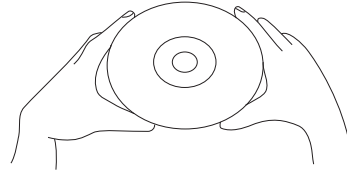

- This unit is designed to play only discs bearing the identification logo as shown here. Other discs may not conform to the CD standard and may not play properly.
- Discs should be stored in their cases after each use to avoid damage.
- Do not expose discs to direct sunlight, high humidity, high temperatures, or dust, etc. Prolonged exposure or extreme temperatures can warp the disc.
- Do not stick or write anything on either side of the disc. Sharp writing instruments or the ink may damage the surface.



Cleaning the Unit

- To prevent fire or shock hazard, disconnect your unit from the AC power source when cleaning.
- The finish on your unit may be cleaned with a dust cloth and cared for as other furniture. Use caution when cleaning and wiping the plastic parts.
- Mild soap and a damp cloth may be used on the front panel.

TROUBLESHOOTING GUIDE

If you experience a problem with this unit, check the chart below before calling for service.

SYMPTOM	CAUSE	SOLUTION
Unit will not turn on.	AC cord not connected.	Check AC cord connection.
Disc will not play.	CD compartment door not closed.	Close CD compartment door.
	Disc inserted incorrectly.	Reinsert disc correctly.
	Dirty or defective CD.	Try another disc.
	Moisture condensation on disc.	Wipe disc with soft cloth.
No sound.	VOLUME control set to minimum.	Increase volume.
	Defective disc.	Try another disc.
Erratic playback.	Dirty or defective disc.	Clean or replace disc.
Time reset to "12:00"	Battery connected improperly, not connected or dead.	Check the battery.
	Clock not set.	Set the clock.
Alarm does not turn on.	ALARM MODE switch not in correct position.	Press AL1 or AL2 SET button to activate alarm.
	Clock is not set.	Set the clock.
	Alarm time is not set.	Set the alarm time.
AM or FM, no sound.	Power is not on.	Press the POWER button.
	VOLUME control set to minimum.	Increase volume.

SPECIFICATIONS

General:

Power Source 120VAC, 60Hz
Battery 9V DC (for back up of the clock)
Audio Power Output 1 Watt/Ch.

Radio Section:

Frequency Range (FM) 88 - 108 MHz
Frequency Range (AM) 530 - 1710 KHz

CD Section:

Disc Diameter 4.72" (120mm)
..... 3.15" (80mm) Single CD
Optical Source Semiconductor Laser
Wavelength 780nm

Specifications are subject to change without notice.

Free Manuals Download Website

<http://myh66.com>

<http://usermanuals.us>

<http://www.somanuals.com>

<http://www.4manuals.cc>

<http://www.manual-lib.com>

<http://www.404manual.com>

<http://www.luxmanual.com>

<http://aubethermostatmanual.com>

Golf course search by state

<http://golfingnear.com>

Email search by domain

<http://emailbydomain.com>

Auto manuals search

<http://auto.somanuals.com>

TV manuals search

<http://tv.somanuals.com>