

Dell™ 2300MP Projector

[Safety Instructions \(Read before connecting the projector\)](#)

[About Your Projector](#)

[Installation](#)

[Using Your Projector](#)

[Troubleshooting](#)

[Specifications](#)

[Regulatory Notices](#)

[Contacting Dell](#)

Notes, Notices, and Cautions



NOTE: A NOTE indicates important information that helps you make better use of your projector.



NOTICE: A NOTICE indicates either potential damage to hardware or loss of data and tells you how to avoid the problem.



CAUTION: A CAUTION indicates a potential for property damage, personal injury, or death.

Information in this document is subject to change without notice.

©2004 Dell Inc. All rights reserved.

Reproduction in any manner whatsoever without the written permission of Dell Inc. is strictly forbidden.

Trademarks used in this text: *Dell* and the *DELL* logo are trademarks of Dell Inc.; *DLP* and *Texas Instruments* are trademarks of Texas Instruments Corporation; *Microsoft* and *Windows* are registered trademarks of Microsoft Corporation; *Macintosh* is a registered trademark of Apple Computer, Inc.

Other trademarks and trade names may be used in this document to refer to either the entities claiming the marks and names or their products. Dell Inc. disclaims any proprietary interest in trademarks and trade names other than its own.

Restrictions and Disclaimers

The information contained in this document, including all instructions, cautions, and regulatory approvals and certifications, is based upon statements provided to Dell by the manufacturer and has not been independently verified or tested by Dell. Dell disclaims all liability in connection with any deficiencies in such information.

All statements or claims regarding the properties, capabilities, speeds, or qualifications of the part referenced in this document are made by the manufacturer and not by Dell. Dell specifically disclaims any knowledge of the accuracy, completeness, or substantiation for any such statements.

July 2004 Rev. A00

[Back to Contents Page](#)

Safety Instructions: Dell™ 2300MP Projector

CAUTION

Use the following safety guidelines to help protect your projector from potential damage and to ensure your own personal safety:

- To reduce the risk of fire from the intense light emitted by the lens, do not put any object in front of or near the lens during operation.
-  Lamp(s) inside this product contain mercury and must be recycled or disposed of according to local, state or Federal Laws. Or contact the electronic industries alliance: www.eiae.org for more information.
- The surface beneath the projector might be hot with use. Be careful in handling the unit.
- The lamp becomes very hot with use. Do not attempt to replace the lamp after use until the projector has been allowed to cool down for at least 30 minutes, and follow all instructions in "[Changing the Lamp.](#)"
- Do not touch the bulb or the lamp glass at any time. The bulb may explode due to improper handling, including the touching of the bulb or the lamp glass.
- Remove lens cap before turning on projector. Failure to do so may cause the lens cap to reach high temperatures.
- To avoid damaging the projector and lamp, allow the cooling fan to run for 2 minutes before turning off the projector.
- Do not block the ventilation slots and openings on the projector.
- Disconnect the power cord from the electrical outlet if the projector is not used for a long period of time.
- Do not use the projector in an extremely hot, cold, or humid environment.
- Do not use the projector in areas susceptible to excessive dust and dirt.
- Do not use the projector near any appliance that generates a strong magnetic field.
- Do not place the projector in direct sunlight.
- Do not look into the lens while the projector is on; the bright light may hurt your eyes.
- To reduce the risk of fire or electric shock, do not expose the projector to rain or moisture.
- To prevent electric shock, do not open or disassemble the projector further than what is needed for lamp replacement.
- To avoid damaging the projector, ensure that the zoom lens and elevator foot are fully retracted before moving the projector or placing the projector in its carrying case.
- Turn off the projector and disconnect it from the electrical outlet before cleaning it. Use a soft cloth moistened with mild detergent to clean the display housing. Do not use abrasive cleaners, waxes, or solvents.

[Back to Contents Page](#)

[Back to Contents Page](#)

About Your Projector: Dell™ 2300MP Projector

- [Features](#)
- [Equipment](#)
- [Main Unit](#)
- [Control Panel](#)
- [Connection Ports](#)
- [Remote Control](#)

Features

- Single chip 0.7" Texas Instruments DLP™ technology
- High contrast, double data rate (DDR) digital micro mirror device
- True XGA, 1024 x 768 addressable pixels
- 4.7 lbs (2.14 kgs) lightweight compact design
- 2300 ANSI lumens brightness (Max)
- 2000:1 full on / full off contrast ratio
- 1.2x manual zoom lens
- Built in 2W speaker
- Auto image re-sizing (Auto-Sync) to 1024 x 768 full screen with scaling compression compatibility for UXGA, SXGA+, SXGA, XGA, SVGA, VGA, MAC
- Preset and user defined video modes for optimum video and graphic settings
- Self-diagnostic for video troubleshooting
- State-of-the-art motion adaptive hardware deinterlacing with 3:2 and 2:2 pull down
- 200-watt user-replaceable UHP 2000-hour lamp
 - Eco Mode allows end user to extend lamp life to 2500 hours by reducing the lamp wattage and brightness
- Full connectivity - Includes PC (VGA), S-Video, Composite Video, Component Video and RS-232 connectors
- Monitor loop through to connect to PC monitor
- Compatibility with Macintosh® computers
- Compatibility with NTSC, NTSC4.43, PAL, PAL-M, PAL-N, SECAM, and HDTV (1080i, 720p, 576i/p, 480i/p)
- User-friendly, multi-language on-screen display (OSD)
- Advanced electronic keystone correction
- User-friendly control panel with backlight
- Remote control and Dell drop-tested carrying case included

*Based on ANSI/NAPM IT7.228-1997 tests of 100 units, June 2004, with average ANSI Lumens 2100. Bulb brightness degrades with usage. Dell recommends replacing your bulb after 2000 hours usage.

Equipment

Your projector comes with all the items shown below. Ensure that you have all the items, and [contact Dell](#) if anything is missing.

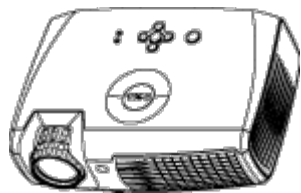

Main unit

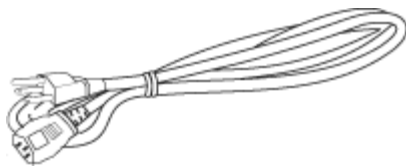

**1.8m Power cord
(3.0m in Americas)**

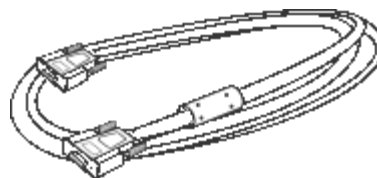

**1.8m VGA cable
(D-sub to D-sub)**



2.0m S-video cable



1.8m USB cable



1.8m Composite Video cable

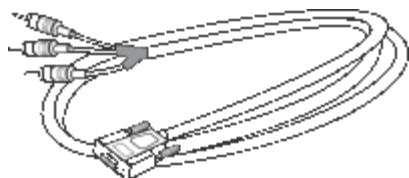

1.8m D-sub to YPbPr cable

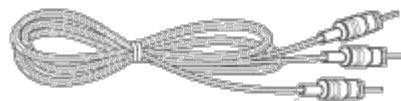

1.8m RCA to Audio cable

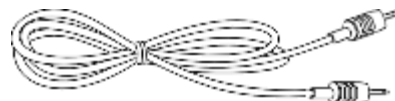

1.8m mini pin to mini pin cable



Remote control



**Dell 2300MP Projector
User's Guide**

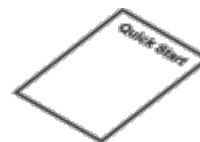

**Dell 2300MP Projector Quick Start
Card**

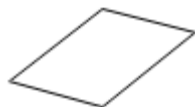

Warranty Guide



Owner's Manual



Carrying case

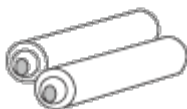

Batteries (2)

Main Unit

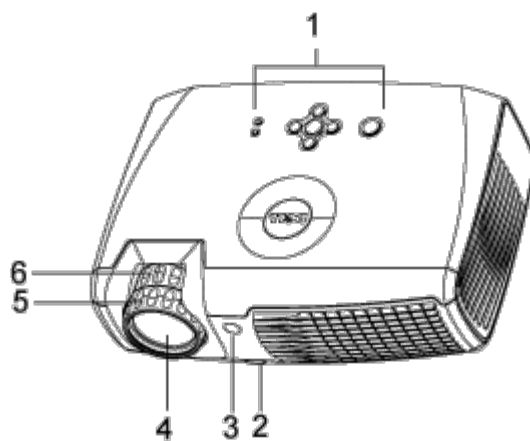

| | |
|---|-------------------------|
| 1 | Control panel |
| 2 | Elevator button |
| 3 | Remote control receiver |
| 4 | Lens |
| 5 | Focus ring |
| 6 | Zoom tab |

Control Panel

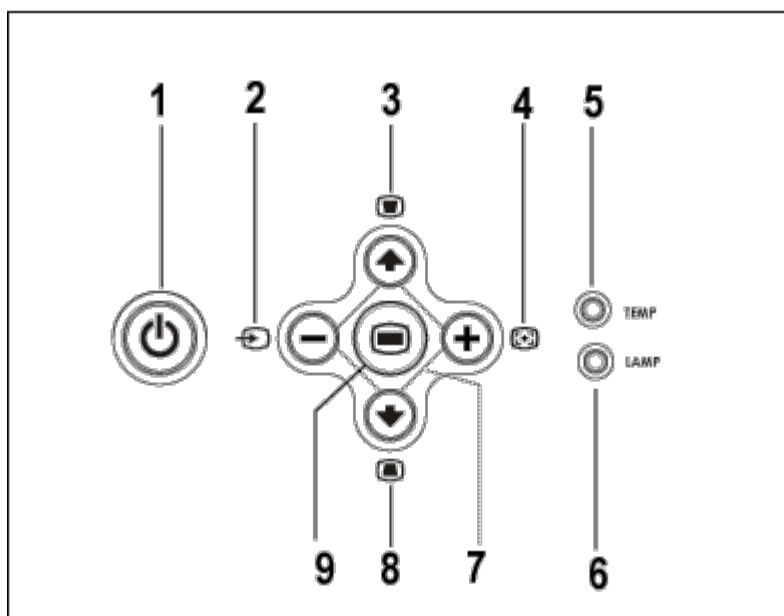

| | |
|---|--------------|
| 1 | Power button |
|---|--------------|

| | |
|---|---------------------------|
| 2 | Source |
| 3 | Keystone adjustment |
| 4 | Resync |
| 5 | Temperature warning light |
| 6 | Lamp warning light |
| 7 | Four directional keys |
| 8 | Keystone adjustment |
| 9 | Menu |

Connection Ports

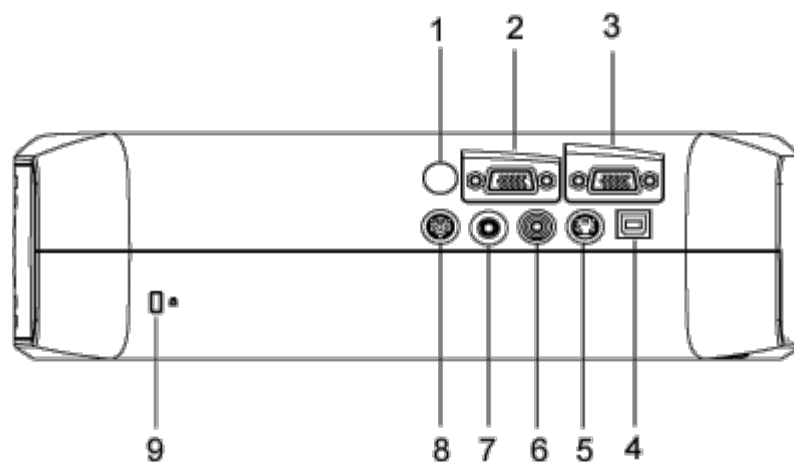

| | |
|---|--------------------------------|
| 1 | IR receiver |
| 2 | VGA out (monitor loop-through) |
| 3 | VGA in (D-sub) connector |
| 4 | USB connector |
| 5 | S-video connector |
| 6 | Composite video connector |
| 7 | Audio input connector |
| 8 | RS232 connector |
| 9 | Kensington lock hole |

Remote Control

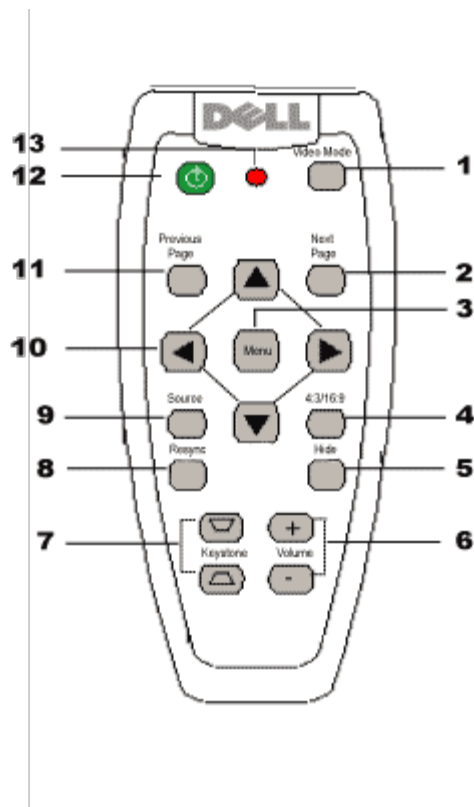

| | |
|----|---------------------------------------|
| 1 | Video Mode button |
| 2 | Next Page button (page down) |
| 3 | Menu button |
| 4 | 4:3/16:9 (aspect ratio) button |
| 5 | Hide button |
| 6 | Volume button |
| 7 | Keystone Correction button |
| 8 | Resync button |
| 9 | Source button |
| 10 | Four Direction buttons |
| 11 | Previous Page button (page up) |
| 12 | Power button |
| 13 | Light |

Battery Disposal: Your projector remote control uses zinc-manganese batteries. If you need to replace the batteries, see your *Dell 2300MP Projector Quick Start Card*.

Do not dispose of used batteries along with household waste. Contact your local waste



disposal agency for the address of the nearest battery deposit site.

[Back to Contents Page](#)

[Back to Contents Page](#)

Installation: Dell™ 2300MP Projector

- [Connecting the Projector](#)
- [Powering On/Off the Projector](#)
- [Adjusting the Projected Image](#)
- [Changing the Lamp](#)

Connecting the Projector

A. To Computer

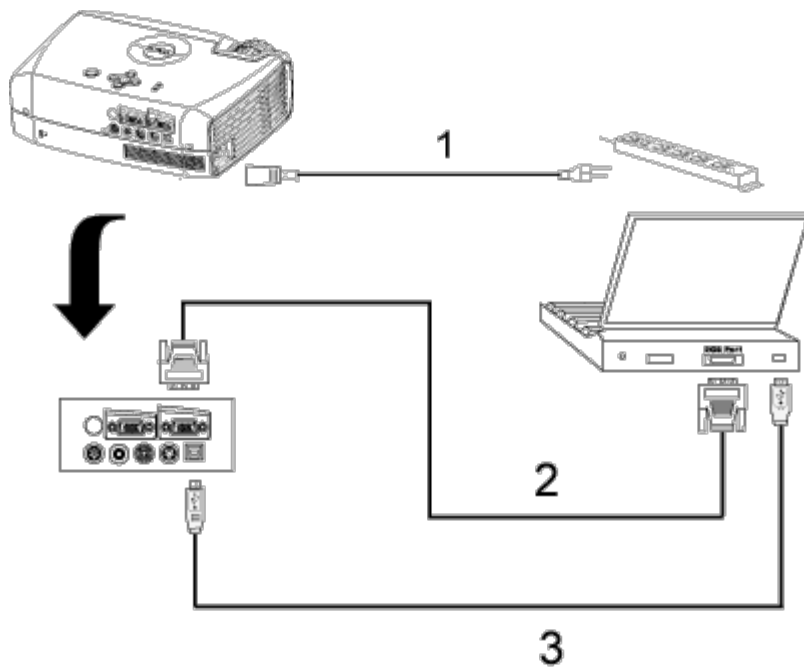

| | |
|---|----------------------|
| 1 | Power cord |
| 2 | D-sub to D-sub cable |
| 3 | USB to USB cable |

B. To DVD Player: There are three possible methods of connecting to a DVD player.

1. Connecting with component cable:

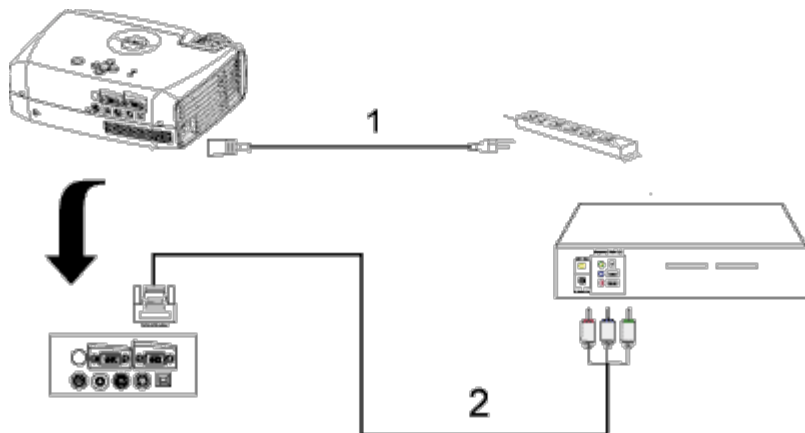

| | |
|---|-------------------------------|
| 1 | Power cord |
| 2 | D-sub to HDTV/Component cable |

2. Connecting with S-video cable:

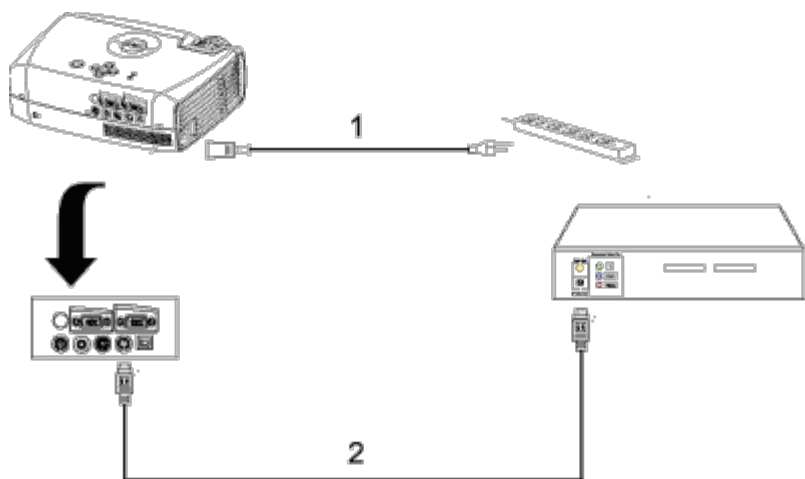

| | |
|---|---------------|
| 1 | Power cord |
| 2 | S-video cable |

3. Connecting with composite cable:

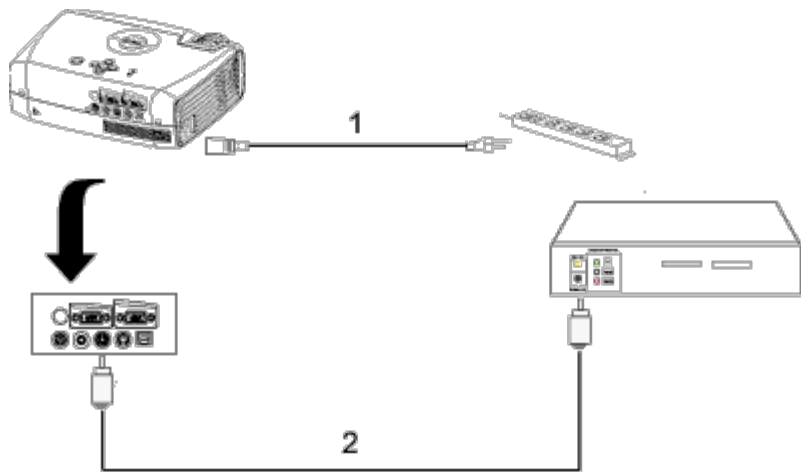

| | |
|---|-----------------------|
| 1 | Power cord |
| 2 | Composite video cable |

C. Professional Installation Options:

Installation for wired RS232 remote control: There are two possible ways to connect with RS232 cable.

1a) Connection with PC:

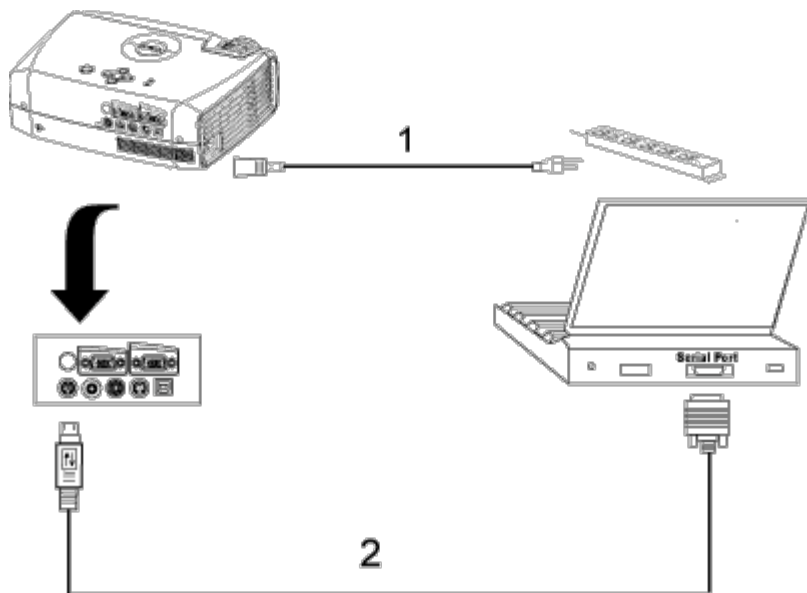

| | |
|---|-------------|
| 1 | Power cord |
| 2 | RS232 cable |

1b) Connection with Commercial RS232 control box:

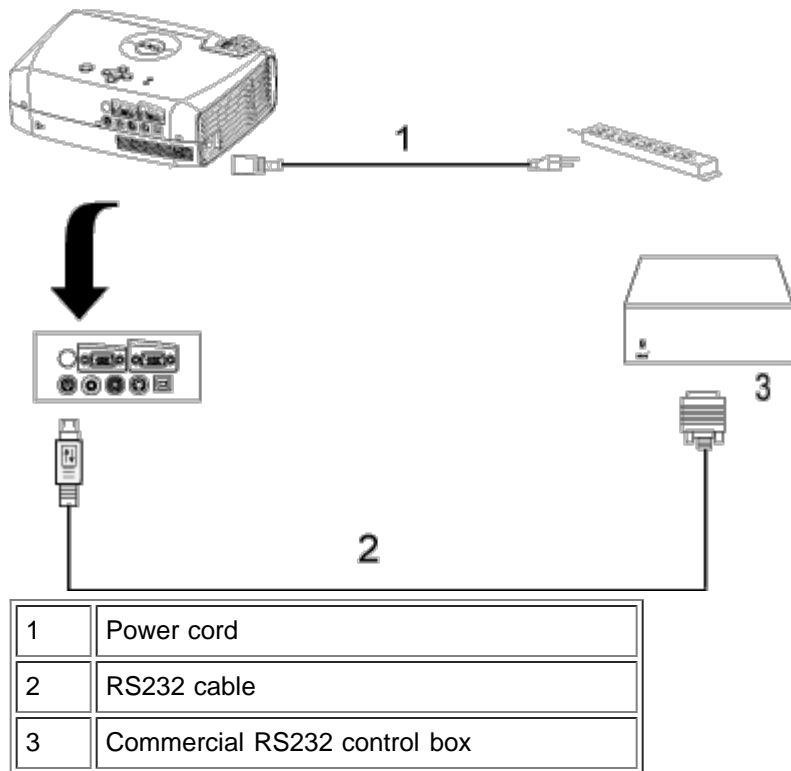

Note: RS232 cable not provided by Dell. Consult professional installer for cable and RS232 remote control software. Refer to [RS232 pin assignment and commands](#).

Powering On/Off the Projector

Powering On the Projector

 **NOTE:** Turn on the projector before you turn on the source.

1. Ensure that the lens cap has been removed.
 2. Ensure that the power cord and appropriate signal cable(s) are securely connected. The power button light will blink green.
 3. Press the power button to turn on the projector. The Dell logo will be displayed for 30 seconds.
 4. Turn on your source (computer, notebook, DVD, etc.). The projector automatically detects your source.
- If the "Searching for signal..." message appears on the screen, ensure that the appropriate signal cable(s) are securely connected.
 - If you are connecting multiple sources to the projector simultaneously, press the **Source** button on the [remote control](#) or [control panel](#) to select the desired source.

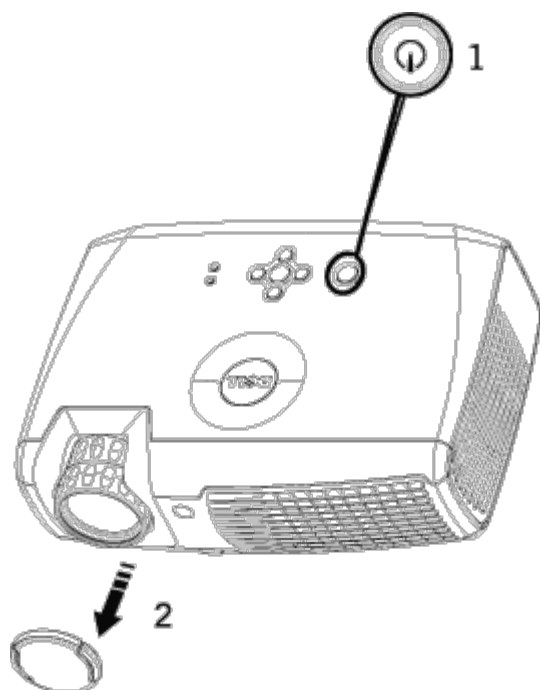

| | |
|---|--------------|
| 1 | Power button |
| 2 | Lens cap |

Powering Off the Projector

DO NOT UNPLUG THE PROJECTOR BEFORE PROPERLY SHUTTING DOWN USING THE FOLLOWING STEPS.

- Powering off procedures

1. Press the power button to turn off the projector.
2. Press the power button again. The cooling fans continue to operate for 90 seconds.
3. If the **LAMP** light is solid orange, replace the lamp.
4. If the **TEMP** light is solid orange, the projector has overheated. The display automatically shuts down. Turn the display on again after the projector cools down. If the problem persists, [contact Dell](#).
5. If the **TEMP** light is blinking orange, a projector fan has failed and the projector will automatically shut down. If this problem persists, [contact Dell](#).
6. Disconnect the power cord from the electrical outlet and the projector.
7. If you press the power button while the projector is running, the "Power Off the Lamp?" message appears on the screen. To clear the message, press any button on the control panel or ignore the message; the message will disappear after 5 seconds.

Adjusting the Projected Image

Adjusting the Projector Height

To raise the projector:

1. Press the elevator button.
2. Raise the projector to the desired display angle, and then release the button to lock the elevator foot into position.

3. Use the tilt adjustment wheel to fine-tune the display angle.

To lower the projector:

1. Press the elevator button.
2. Lower the projector, and then release the button to lock the elevator foot into position.

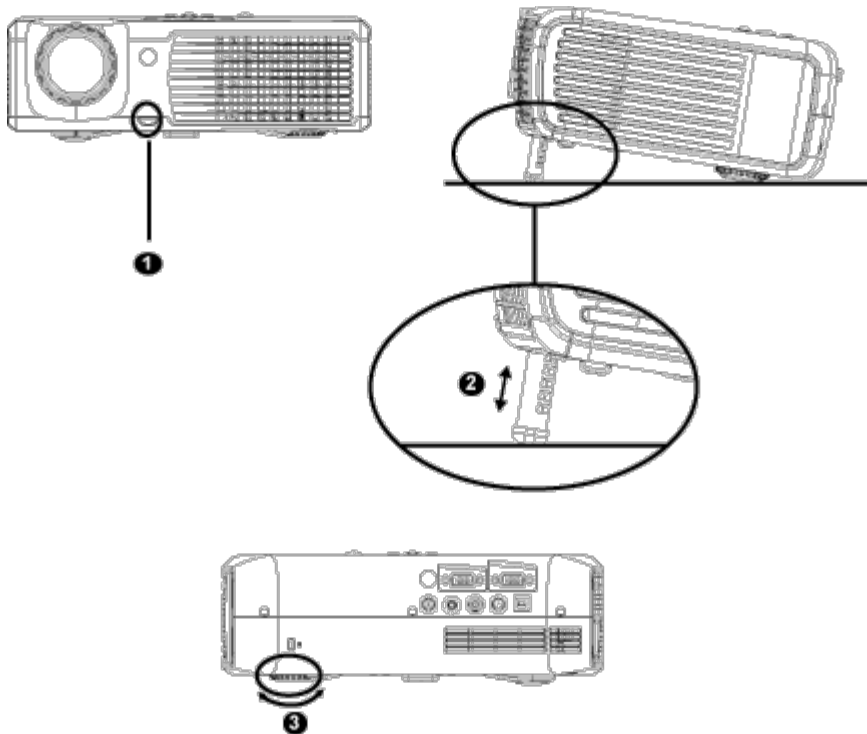

| | |
|---|-----------------------|
| 1 | Elevator button |
| 2 | Elevator foot |
| 3 | Tilt adjustment wheel |

! CAUTION: To avoid damaging the projector, ensure that the zoom lens and elevator foot are fully retracted before moving the projector or placing the projector in its carrying case.

Adjusting the Projector Zoom and Focus

1. Rotate the zoom tab to zoom in and out.
2. Rotate the focus ring until the image is clear. The projector focuses at distances from 3.9 ft to 39.4ft (1.2 m to 12 m).

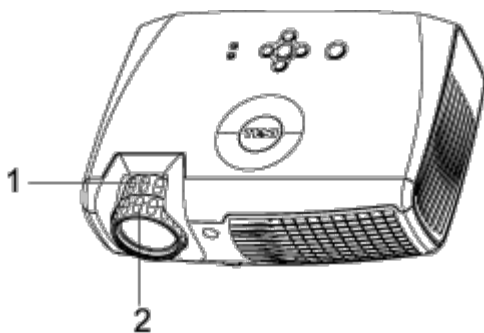

| | |
|---|------------|
| 1 | Zoom tab |
| 2 | Focus ring |

Adjusting Projection Image Size

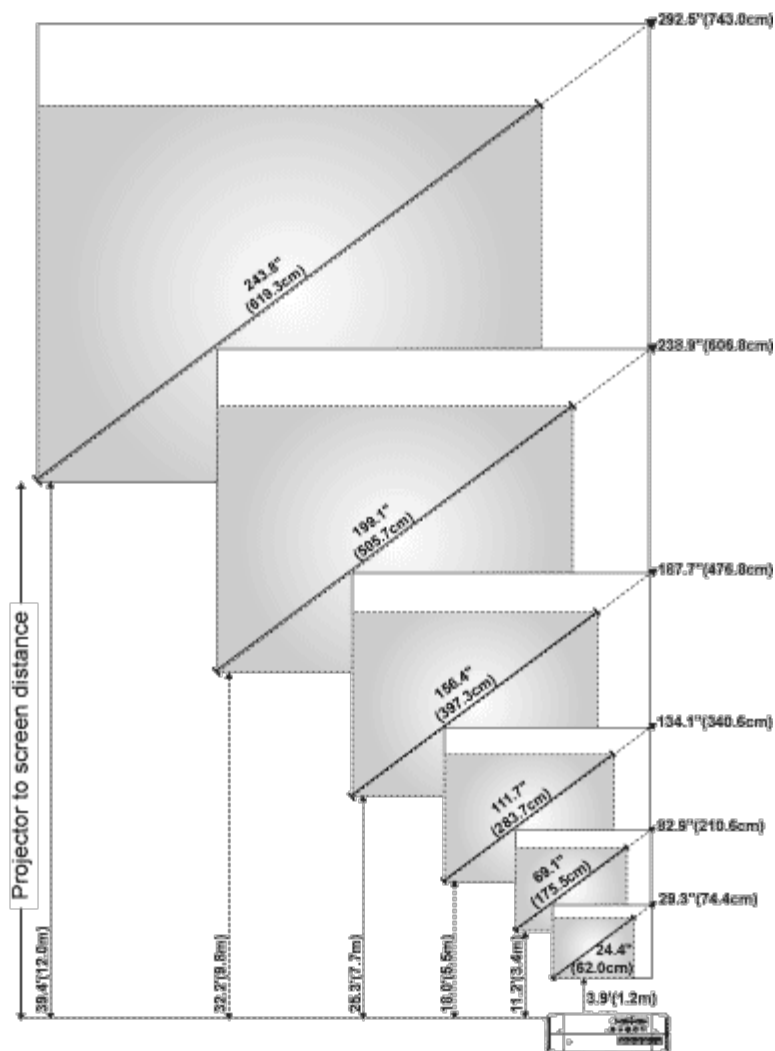

| Screen (Diagonal) | Max. | 29.3" (74.4cm) | 82.9" (210.6cm) | 134.1" (340.6cm) | 187.7" (476.8cm) | 238.9" (606.8cm) | 292.5" (743.0cm) |
|-------------------|------------|--------------------------------|----------------------------------|-----------------------------------|------------------------------------|------------------------------------|------------------------------------|
| | Min. | 24.4" (62.0cm) | 69.1" (175.5cm) | 111.7" (283.7cm) | 156.4" (397.3cm) | 199.1" (505.7cm) | 243.8" (619.3cm) |
| Screen Size | Max. (WxH) | 23.4"X17.6" (59.4cmX44.7cm) | 66.3"X49.7" (168.4cmX126.2cm) | 107.3"X80.4" (272.5cmX204.2cm) | 150.2"X112.6" (381.5cmX286.0cm) | 191.1"X143.3" (485.4cmX364.0cm) | 234.0"X175.5" (594.4cmX445.8cm) |
| | Min. (WxH) | 19.5"X14.6" (49.5cmX37.1cm) | 55.3"X41.4" (140.5cmX105.2cm) | 89.4"X67.0" (227.1cmX170.2cm) | 125.1"X93.9" (317.8cmX238.5cm) | 159.3"X119.5" (404.6cmX303.5cm) | 195.0"X146.3" (495.3cmX371.6cm) |
| Distance | | 3.9"(1.2m) | 11.2"(3.4m) | 18.0"(5.5m) | 25.3"(7.7m) | 32.2"(9.8m) | 39.4"(12.0m) |

* This graph is for user reference only.

Changing the Lamp

Replace the lamp when you see " **Lamp is approaching the end of its useful life in full power operation. Replacement suggested!**" message on the screen by carefully following these instructions. If this problem persists, [contact Dell](#).

CAUTION: The lamp becomes very hot with in use. Do not attempt to replace the lamp after use until the projector has been allowed to cool down for at least 30 minutes.

Lamp Changing Procedure:

1. Turn off the projector and disconnect the power cord.
2. Let the projector cool for at least 30 minutes.
3. Loosen the 2 screws that secure the lamp cover, and remove the cover.
4. Loosen the 2 screws that secure the lamp.
5. Pull up the lamp by its metal handle.
6. Reverse steps 1 through 5 to install the new lamp.
7. Reset the lamp by usage time selecting the left **Lamp Reset** icon in the OSD [Management](#) tab.

NOTE: Dell may require that lamps replaced under warranty be returned to Dell. Otherwise, contact your local waste disposal agency for the address of the nearest deposit site.

NOTE: The lamp contains mercury. Disposal of this material may be regulated due to environmental considerations. For disposal or recycling information, please contact your local authorities or the Electronic Industries Alliance: www.eiae.org.

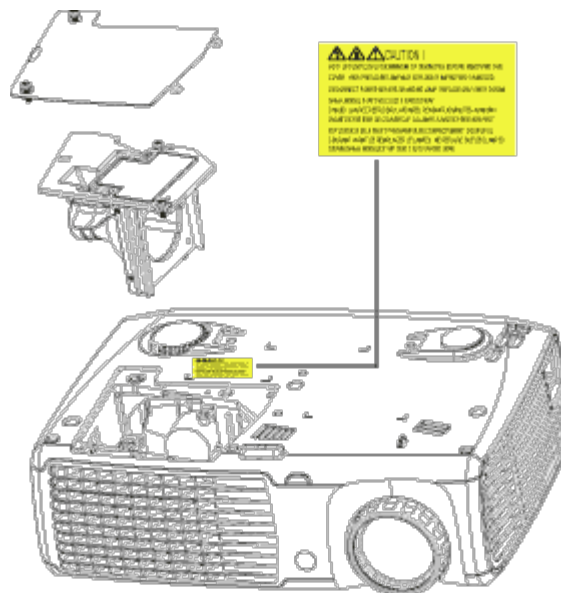

CAUTION: Do not touch the bulb or the lamp glass at any time. The bulb may explode due to improper handling, including the touching of the bulb or the lamp glass.

[Back to Contents Page](#)

[Back to Contents Page](#)

Using Your Projector: Dell™ 2300MP Projector

- [Control Panel](#)
 - [Remote Control](#)
 - [On-Screen Display](#)
-

Control Panel

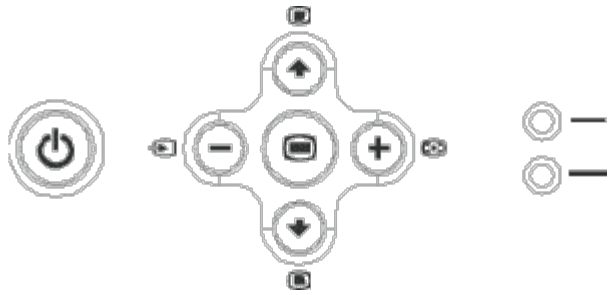

Power

See "[Powering On/Off the Projector.](#)"

Volume

Increase or decrease the speaker volume.

Video Mode

Switch the display mode within **PC Mode**, **Movie Mode**, **Game Mode**, **sRGB Mode**, **User Mode** per your preference.

Source

Press  to step through Analog RGB, Composite, Component-i, S-video, and Analog YPbPr sources when multiple sources are connected to the projector.

Resync

Press  to synchronize the projector to the input source.

Resync will not operate if the [OSD](#) (On-Screen Display) is displayed.

Menu

Press  to activate the [OSD](#). Use the directional keys and **Menu** button to navigate through the OSD.

Four Directional Keys

The four directional keys  can be used to toggle through the tabs in the [OSD](#).

Keystone Adjustment

Press  or  button to adjust image distortion caused by tilting the projector. (± 16 degrees)

Remote Control



Power

See "[Power On/Off the Projector.](#)"

Source



Press the **Source** button to switch between Analog RGB, Digital RGB, Composite, Component-i, S-video, and Analog YPbPr sources.

Resync

Press **Resync** to synchronize the projector to the input source.

Resync will not operate if the [OSD](#) (On-Screen Display) is displayed.

Directional Keys

Use  or  to select OSD items, use "left" and "right" button to make adjustments.

Hide

Press **Hide** button to hide the image, press again to resume display of the image.

Video Mode

The Dell 2300MP Micro-projector has preset configurations that are optimized for displaying data (PC Graphics) or video (movies, games, etc.). Press **Video Mode** button to toggle between **PC mode**, **Movie mode**, **Game Mode**, **sRGB**, or **User mode** (for user to setup and save preferred settings). Pressing the **Video Mode** button once will show the current display mode. Pressing the **Video Mode** button again will switch between modes.

Previous Page

Press the **Previous Page** button to step to previous page.

Next Page

Press the **Next Page** button to step to next page.

Menu

Press the **Menu** button to activate the [OSD](#). Use the directional keys and **Menu** button to navigate through the OSD.

4:3/16:9

Press **4:3/16:9** button to switch aspect ratio 1:1, 16:9, 4:3 as described [below](#).









Volume +/-

Press the **Vol+** button to increase the volume, press the **Vol-** button to reduce the volume.

Keystone

Adjusts image distortion caused by tilting the projector. (± 16 degrees)

On-Screen Display

- The projector has a multi-language On-Screen Display (OSD) that can be displayed with or without an input source present.
- The OSD allows you to make image adjustments and change a variety of settings. If the source is a computer, the OSD allows changes to the Computer Image tab. When using a video source, the OSD allows changes to the Video Image tab. The projector automatically detects the source.
- When the OSD is on the screen, press  or  to navigate through the OSD tabs.
Example: All Images--> Computer Image--> Audio--> Management--> Language--> Factory Reset. To make a selection in a tab, press  on keypad or "**Menu**" on remote controller.
- Press  or  to make a selection and adjust the settings by pressing  or  on keypad or Left and Right button on the remote controller. When an item is selected, the color of the item will change to dark gray.
- To exit the OSD, go to "Exit" tab and press  button on keypad or "**Menu**" on remote controller.

All Images Menu

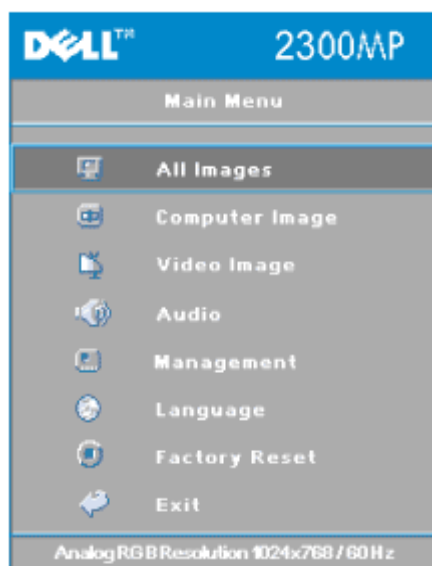

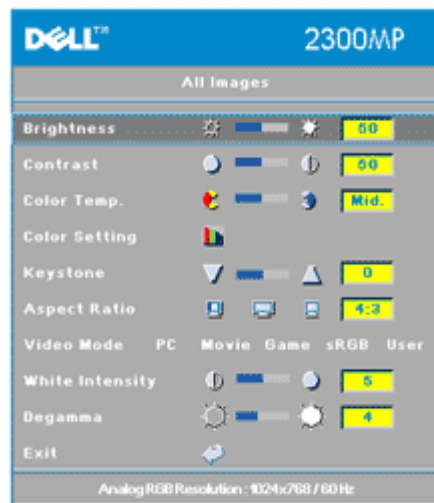

Brightness

Adjust the brightness of the image.



- Press **(-)** to darken the image.
- Press **(+)** to lighten the image.

Contrast

Control the degree of difference between the brightest and darkest parts of the picture. Adjusting the contrast changes the amount of black and white in the image.



- Press **(-)** to decrease the contrast.
- Press **(+)** to increase the contrast.

Color Temp.



Adjust the color temperature. With the higher temperature, the screen looks more blue; with the lower temperature, the screen looks more red. User mode activates the values in the "color setting" menu.

Color Setting



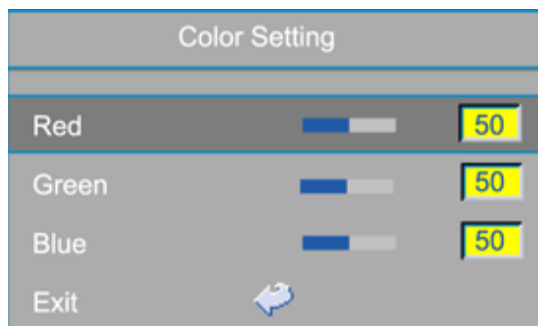

This mode allows for manual adjustment of red, green, and blue color settings. Modifying these values will automatically change the color temperature to "user".

Keystone



Adjusts image distortion caused by tilting the projector. (± 16 degrees)

Aspect Ratio



Select this function to fit 1:1, 16:9 or 4:3 aspect ratio. In order to use the 1:1 aspect ratio, the input must be a computer signal (through VGA cable) less than XGA (1024 x 768), component 576p/ 480i / 480p, S-Video, or Video (composite). If the input signal is a computer signal greater than XGA or component 1080i / 720p, only 16:9 or 4:3 aspect ratio will be available. When an icon is selected, the color of the icon will change to dark blue.

1:1: The input source will be displayed without scaling.

16:9: The input source will be displayed in wide screen mode (16:9). The source will be scaled to fit the width of the screen.

4:3: The input source will be scaled to fit the screen.

Video Mode



Select this function to optimize the display image for home use (**Movie Mode** or **Game Mode**), conference use (**PC Mode**) or as user preferable settings (**User Mode**), or use **sRGB** mode for more accurate color representation. When an icon is selected, the color of the icon will change to dark blue. Adjusting the settings of **White Intensity** or **Degamma** tab, will select **User Mode** automatically.

White Intensity

White Intensity can be adjusted between 0 and 10.



- Setting 10 will maximize the brightness.
- Setting 0 will maximize color reproduction quality.

Degamma



Degamma can be adjusted between 1 and 4. Default setting is 3 (Recommended). Adjustment of the setting will change the color performance of the display.

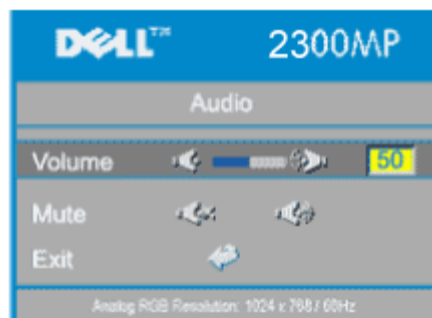

Audio Menu



Audio

Volume



- Press  to decrease the volume.
- Press  to increase the volume.

Mute



- Select the left icon to mute the volume.
- Select the right icon to un-mute the volume.

Management Menu

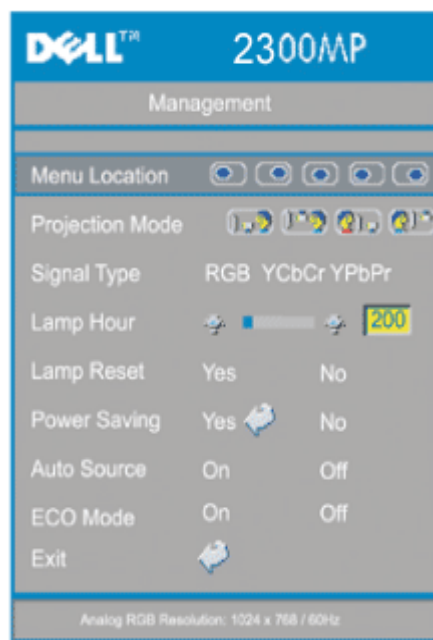

Management





Menu Location

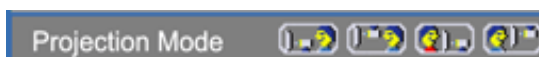

Select the location of the OSD on the screen.

Projection Mode



-  Front Projection-Desktop
The default setting.
-  Rear Projection-Desktop
The projector reverses the image so you can project from behind a translucent screen.
-  Front Projection-Ceiling Mount
The projector turns the image upside down for ceiling-mounted projection.
-  Rear Projection-Ceiling Mount
The projector simultaneously reverses and turns the image upside down. You can project from behind a translucent screen with a ceiling-mounted projection.

Signal Type



Manually select signal type RGB, YCbCr, YPbPr.

Lamp Hour



Display operating hours since lamp timer reset.

Lamp Reset

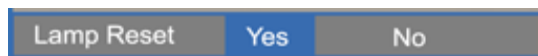

Use this function only after a new lamp is installed in the projector. Select the left **Lamp Reset** icon (light bulb and arrow under the icon), and press the **Enter** button to reset the lamp timer.

Power Saving Menu

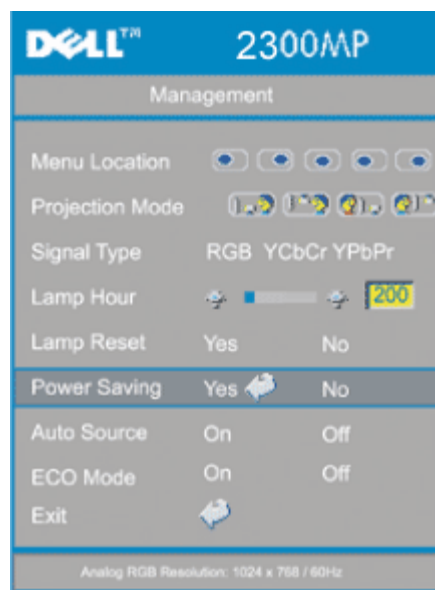

Power Saving

Use this function to select the power saving delay period. Press "Yes" to go into the "set time" sub menu.

Set Time (Min)



Set the power saving delay period as you prefer. When the projector is not receiving an input signal for the selected period of time, the projector will automatically enter power saving mode, and turn off the lamp. After a one-minute cooling period, the projector will turn back on with detection of an input signal or by pressing the "Power" button. After two hours the projector will turn off and must be turned on by pressing the power button on the control panel or remote.

Auto Source



The projector will always automatically search for available input signals when **Auto Source** is **On**, which is the default setting. Press the **Source** button with **Auto Source On** to automatically search for the next available input signal. Selecting **Off** will lock on the current input source. Set **Auto-Source** to **Off** to step through the different input signals manually.

Eco Mode



- Select **On** to operate the projector in lower power (150 Watts) for providing longer lamp life and quieter operation with dimmer luminance output on the screen.
- Select **Off** to resume the operation in normal power (200 Watts).



Language Menu





Language

Language

Press  or  to select the preferred language.

Factory Reset Menu



Factory Reset

Select **Yes** to reset the projector to its factory default settings. Reset items include both computer image and video image settings.

Computer Image Menu

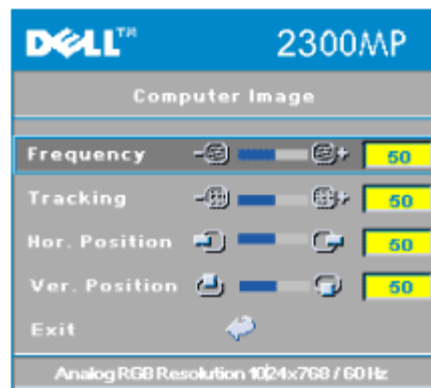

Computer Image-

NOTE: This menu is only available with a computer input signal connected.

Frequency



Change the display data clock frequency to match the frequency of your computer graphics card. If you see a vertical flickering bar, use the frequency control to minimize the bars. This is a coarse adjustment.

Tracking



Synchronize the phase of the signal of the display with that of the graphic card. If you experience an unstable or flickering image, use the **Tracking** function to correct it. This is a fine adjustment.

NOTE: Adjust the **Frequency** first and then the **Tracking**.



Hor. Position (Horizontal Position)



- Press **-** to move the image to the left.
- Press **+** to move the image to the right.

Ver. Position (Vertical Position)



- Press  to move the image down.
- Press  to move the image up.

Video Image Menu





Video Image-

 **NOTE:** This menu is only available with S-video, Video (composite) signal connected.

Saturation





Adjust a video image from black and white to fully saturated color.

- Press  to decrease the amount of color in the image.
- Press  to increase the amount of color in the image.

Sharpness





Adjust the sharpness of the image.

- Press  to decrease the sharpness.
- Press  to increase the sharpness.

Tint



Adjust the color balance of red and green.

- Press  to increase the amount of green in the image.
- Press  to increase the amount of red in the image.

[Back to Contents Page](#)



[Back to Contents Page](#)

Troubleshooting: Dell™ 2300MP Projector

- [No image appears on the screen](#)
- [Partial, scrolling, or incorrectly displayed image](#)
- [The screen does not display your presentation](#)
- [Image is unstable or flickering](#)
- [Image has vertical flickering bar](#)
- [Image color is not correct](#)
- [Image is out of focus](#)
- [The image is stretched when displaying 16:9 DVD](#)
- [Image is reversed](#)
- [Lamp is burned out or makes a popping sound](#)
- [Self-diagnostic for video](#)
- [The remote control is not operating smoothly or operating in very limited range](#)

If you experience problems with your projector, see the following troubleshooting tips. If the problem persists, [contact Dell](#).

No image appears on the screen

- Ensure that the lens cap is removed and the projector turned on.
- Ensure the external graphics port is enabled. If you are using a Dell portable computer, press  . For other computers, consult your owner's manual.
- Ensure that all the cables are securely connected as described in "[Connecting the Projector](#)."
- Ensure that the pins of the connectors are not bent or broken.
- Ensure that the lamp is securely installed (see "[Changing the Lamp](#)").
- Run "Self-diagnostic test" (see "[Self-diagnostic for video](#)") for preliminary diagnostic on projection problem for video. Ensure that the colors of the test pattern are correct.

Partial, scrolling, or incorrectly displayed image

- Press the **Resync** button on the [remote control](#) or the [control panel](#).
- If you are using a Dell portable computer (for other computers consult your owner's manual):
 1. Set the resolution of the computer to XGA (1024 x 768):
 - 1a) Right click on the unused portion of your Windows desktop-» Properties-» Settings tab.
 - 1b) Verify the "Screen area" slide bar is set to 1024x 768 pixels for the external

monitor port.

2. Press  .

- If you experience difficulty in changing resolutions or your monitor freezes, restart all the equipment and the projector.

The screen does not display your presentation

- If you are using a Dell portable computer, press  .

Image is unstable or flickering

- Adjust the tracking in the OSD **Computer Image** tab.

Image has vertical flickering bar

- Adjust the frequency in the OSD **Computer Image** tab.

Image color is not correct

- If your graphic card output signal is "sync on Green", and you would like to display VGA at 60Hz signal, please go into "OSD--> Management --> Signal Type" and select "RGB".
- Run "Self-diagnostic test" (see "[Self-diagnostic for video](#)") for preliminary diagnostic on image color problem. Ensure that the colors of the test pattern are correct.

Image is out of focus

- Adjust the focus ring on the projector lens.
- Ensure that the projection screen is within the required distance from the projector (3.9ft [1.2m] to 39.4ft [12m]).

The image is stretched when displaying 16:9 DVD

The projector automatically detects 16:9 DVD and adjusts the aspect ratio to full screen with a 4:3 (letter-box) default setting.

If the image is still stretched, adjust the aspect ratio as follows:

- If you are playing a 16:9 DVD, select 4:3 aspect ratio type on your DVD player if capable.
- If you cannot select 4:3 aspect ratio type on your DVD player, select 4:3 aspect ratio in the "All Images" menu within the OSD function.

Image is reversed

- Select [Management](#) from the OSD and adjust the projection mode.

Lamp is burned out or makes a popping sound

- When the lamp reaches its end of life, it may burn out and may make a loud popping sound. If this occurs, the projector will not turn back on, and will display "Lamp Defective" in the LCD display until the lamp is replaced. To replace the lamp, see "[Changing the Lamp](#)".

Self-diagnostic for video

- Dell 2300MP Projector provides self-diagnostic test of the projector video display (for Video,

S-video, Component-i). Use this advanced feature for preliminary self-diagnostic on your projector when encountering a display problem for video.

- After turning on the projector, press "+" and "-" buttons on the control panel simultaneously and release the buttons when screen goes blank.
- Press "+" and "-" buttons again to exit the diagnostic mode.
- While in Self-diagnostic mode, the screen will run a seven-color-cycle test as following: "Red--> Green--> Blue--> White--> Watchet Blue--> Dark Green--> Yellow." Ensure that the colors of the test pattern are correct. Contact Dell if the colors are not displayed correctly.

The remote control is not operating smoothly or operating in very limited range

The battery may be low. If so, replace with 2 new AA batteries.

[Back to Contents Page](#)

[Back to Contents Page](#)

Specifications: Dell™ 2300MP Projector

| | |
|------------------------|---|
| Light Valve | Single-chip DLP™ DDR (double data rate) technology |
| Brightness | 2300 ANSI Lumens (Max) |
| Contrast Ratio | 2000:1 Typical (Full On/Full Off) |
| Uniformity | 80% Typical (Japan Standard - JBMA) |
| Lamp | 200-watt user-replaceable UHP 2000-hour lamp(up to 2500 hours in eco mode) |
| Number of Pixels | 1024 x 768 (XGA) |
| Displayable Color | 16.7M colors |
| Color Wheel Speed | 100~127.5Hz(2X) |
| Projection Lens | F/2.4~2.65, f=28.04~33.59mm with 1.2x manual zoom lens |
| Projection Screen Size | 24.4-292.5 inches (diagonal) |
| Projection Distance | 3.9~39.4 ft (1.2m~12m) |
| Video Compatibility | NTSC, NTSC 4.43, PAL, PAL-M, PAL-N, SECAM, and HDTV (1080i, 720p, 576i/p, 480i/p) compatibility |
| H. Frequency | Composite video, Component video and S-video capability 15kHz-70kHz (Analog) |
| V. Frequency | 56Hz-85Hz (Analog) |
| Power Supply | Universal 100-240V AC 50-60Hz with PFC input |
| Power Consumption | 250 Watts full power (typical) , 190 Watts in eco mode |
| Audio | 1 speaker, 2 Watts RMS |
| Noise Level | 36dB(A) Full-on mode, 33dB(A) Eco-mode |
| Weight | 4.7 lbs (2.14 kgs) |
| Dimensions (W x H x D) | External 10.91 x 8.13 x 3.64 ± 0.04 inches (277 x 206.5 x 92.5 ± 1mm) |
| Environmental | Operating temperature: 5°C–35°C (41°F–95°F) Humidity: 80% maximum |
| Regulatory | Storage temperature: –20°C to 60°C (–4°F to 140°F) Humidity: 80% maximum FCC, CE, VCCI, UL, cUL, TÜV- GS, ICES-003, MIC, C-Tick, GOST, CCC, PSB, NOM, TÜV-S/Argentina |
| I/O Connectors | Power: AC power input socket Computer input: one D-sub for analog/component, HDTV input signals Computer output: one 15-pin D-sub Video input: one composite video RCA and one S-video |

USB input: one USB connector

Audio input: one phone jack (diameter 3.5mm)

One mini-DIN RS232 for wired remote projector control from PC

RS232 Pin Assignment

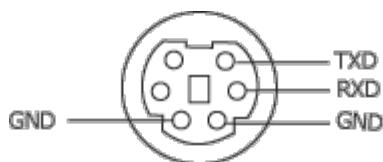

RS232 Protocol

- Communication Settings**

| Connection settings | Value |
|---------------------|-------|
| Baud Rate: | 19200 |
| Data Bits: | 8 |
| Parity | None |
| Stop Bits | 1 |

- Control command Syntax (From PC to Projector)**

[H][AC][SoP][CRC][ID][SoM][COMMAND]

- Example:** power on the projector

Enter the following code: 0xBE 0xEF 0x10 0x05 0x00 0xC7 0xBF 0x11 0x11 0x01 0x00 0x02

- Control Commands List**

| Control Commands List | Address Code (BYTE) | Size of the Payload (WORD) | CRC16 for the entire packet (WORD) | MsG ID (WORD) | MsG size (WORD) | Command code (BYTE) | Command Description |
|-----------------------|---------------------|----------------------------|------------------------------------|---------------|-----------------|---------------------|---------------------|
| | | | 0xffc6 | | | 0x01 | Power |
| | | | 0xbfc7 | | | 0x02 | Menu |
| | | | 0x7e07 | | | 0x03 | Up |
| | | | 0x3fc5 | | | 0x04 | Down |
| | | | 0xfe05 | | | 0x05 | Left |
| | | | 0xbe04 | | | 0x06 | Right |
| | | | 0x7fc4 | | | 0x07 | Resync |
| | | | 0x3fc0 | | | 0x08 | Source |
| | | | 0xfe00 | | | 0x09 | Volume+ |
| | | | 0xbe01 | | | 0x0A | Volume- |
| | | | 0xffc3 | | | 0x0D | Mute |
| | | | 0xbfc2 | | | 0x0E | Freeze |
| | | | 0x7e02 | | | 0x0F | Hide |
| | | | 0x3fca | | | 0x10 | Video Mode |
| | | | 0x7fcb | | | 0x13 | V. Keystone Up |
| | | | 0x3e09 | | | 0x14 | V. Keystone Down |
| 0xefbe | 0x10 | 0x0005 | | 0x1111 | 0x0001 | | |

| | | |
|--------|------|---|
| 0x7e08 | 0x17 | Aspect ratio (4:3/16:9) |
| 0x3e0c | 0x18 | Power OFF |
| 0xffcc | 0x19 | Source-VGA Analog |
| 0xbfcd | 0x1A | Source-VGA YPbPr (480p/576p/720p/1080i) |
| 0x7e0d | 0x1B | Source-VGA YCbCr (480i/576i) |
| 0xbe1f | 0x22 | Source-S-Video |
| 0x7fdf | 0x23 | Source-Composite |
| 0xbfd9 | 0x2A | ECO Mode ON |
| 0x7e19 | 0x2B | ECO Mode OFF |
| 0x3fdb | 0x2C | Auto Source ON |
| 0xfe1b | 0x2D | Auto Source OFF |
| 0xbe1a | 0x2E | Factory Reset |
| 0x7fda | 0x2F | Lamp Hour |
| 0x3e12 | 0x30 | Firmware Version |
| 0x7e46 | 0xFF | System status |

Compatibility Modes

| Mode | Resolution | (ANALOG) | |
|------------|------------|-------------------|--------------------|
| | | V. Frequency (Hz) | H. Frequency (KHz) |
| VGA | 640X350 | 70 | 31.5 |
| VGA | 640X350 | 85 | 37.9 |
| VGA | 640X400 | 85 | 37.9 |
| VGA | 640X480 | 60 | 31.5 |
| VGA | 640X480 | 72 | 37.9 |
| VGA | 640X480 | 75 | 37.5 |
| VGA | 640X480 | 85 | 43.3 |
| VGA | 720X400 | 70 | 31.5 |
| VGA | 720X400 | 85 | 37.9 |
| SVGA | 800X600 | 56 | 35.2 |
| SVGA | 800X600 | 60 | 37.9 |
| SVGA | 800X600 | 72 | 48.1 |
| SVGA | 800X600 | 75 | 46.9 |
| SVGA | 800X600 | 85 | 53.7 |
| XGA | 1024X768 | 60 | 48.4 |
| XGA | 1024X768 | 70 | 56.5 |
| XGA | 1024X768 | 75 | 60 |
| XGA | 1024X768 | 85 | 68.7 |
| *SXGA | 1280X1024 | 60 | 63.98 |
| *SXGA | 1280X1024 | 75 | 79.98 |
| *SXGA+ | 1400X1050 | 60 | 63.98 |
| *UXGA | 1600x1200 | 60 | 75 |
| MAC LC13* | 640X480 | 66.66 | 34.98 |
| MAC II 13* | 640X480 | 66.68 | 35 |
| MAC 16* | 832X624 | 74.55 | 49.725 |
| MAC 19* | 1024X768 | 75 | 60.24 |

| | | | |
|-------------------------------------|-----------------|--------------|--------------|
| *MAC | 1152X870 | 75.06 | 68.68 |
| MAC G4 | 640X480 | 60 | 31.35 |
| IMAC DV | 1024X768 | 75 | 60 |
| * Compressed computer image. | | | |

[Back to Contents Page](#)

[Back to Contents Page](#)

Regulatory Notices: Dell™ 2300MP Projector

- [Federal Communications Commission \(FCC\) Notice \(U.S. Only\)](#)
 - [FCC Declaration of Conformity](#)
 - [CE Declaration of Conformity for a Class B Digital Device](#)
 - [Canadian Regulatory Information \(Canada Only\)](#)
 - [EN 55022 Compliance \(Czech Republic Only\)](#)
 - [VCCI Class 2 Notice \(Japan Only\)](#)
 - [MIC Notice \(South Korea Only\)](#)
 - [Polish Center for Testing and Certification Notice](#)
 - [NOM Information \(Mexico Only\)](#)
 - [Regulatory Listing](#)
-

Federal Communications Commission (FCC) Notice (U.S. Only)

 **NOTICE:** This equipment has been tested and found to comply with the limits for a Class B digital device, pursuant to Part 15 of the FCC Rules. These limits are designed to provide reasonable protection against harmful interference in a residential installation. This equipment generates, uses, and can radiate radio frequency energy and, if not installed and used in accordance with the instructions, may cause harmful interference to radio communications. However, there is no guarantee that interference will not occur in a particular installation. If this equipment does cause harmful interference to radio or television reception, which can be determined by turning the equipment off and on, the user is encouraged to try to correct the interference by one or more of the following measures:

- Reorient or relocate receiving antenna.
- Increase the separation between the equipment and receiver.
- Connect the equipment into an outlet on a circuit different from that to which the receiver is connected.
- Consult the dealer or an experienced radio/TV technician for help.

This device complies with Part 15 of the FCC rules. Operation is subject to the following two conditions:

- This device may not cause harmful interference.
- This device must accept any interference received including interference that may cause undesired operation.

Instructions to Users: This equipment complies with the requirements of FCC (Federal Communication Commission) equipment provided that the following conditions are met.

1. Power cable: Shielded power cable must be used.
2. Video inputs: The input signal amplitude must not exceed the specified level.

 **NOTICE:** Changes or modifications not expressly approved by the party responsible for compliance could void the user's authority to operate the equipment.

FCC Declaration of Conformity

According to 47 CFR, Part 15 of the FCC Rules

* **For the following named product:**

DLP Projector
2300MP/DELL CHC7229

*** Manufactured at:**

Coretronic Corporation

We hereby declare that this device complies with Part 15 of the FCC Rules.
Operation is subject to the following two conditions:

1. This device may not cause harmful interference, and
2. This device must accept any interference received,
including interference that may cause undesired operation.

*** FCC Rules:**

Tested to comply with FCC part 15, class B

*** Test site at:**

Advance Data Technology Corporation
No.81-1, Lu Liao Keng, 9 Ling, Wu Lung Tsung, Chiung Lin Hsiang, Hsin Chu
Hsien, Taiwan

*** Responsible Party for Product
Compliance:**

Coretronic Corporation
No 11, Li Hsing Rd, Science-Based Industrial Park, Hsinchu, Taiwan
Tel: 886-3-5772000 Fax: 886-3-5790066

*** Manufacturer Information:**

Coretronic Corporation RD Center
No 11, Li Hsing Rd, Science-Based Technology Engineering
Industrial Park, Hsinchu, 300, Associate Vice President
Taiwan

July 01, 2004

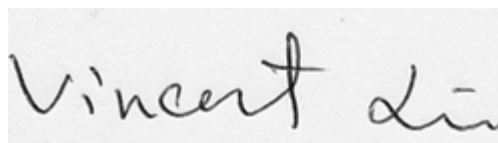

Hsinchu, July 01, 2004

Mr. Vincent Lin

CE Declaration of Conformity for a Class B Digital Device

Directives to which conformity is declared:

EMC Directives 89/336/EEC and Amending Directive 92/31/EEC

And

Low Voltage Directive 73/23/EEC

Standards to which conformity is declared

EN55022: 1998+A1:2000, Class B; EN55024: 1998+A1:2001; EN60950: 2000;

EN61000-3-2: 2000; EN61000-3-3: 1995+A1:2001

Manufacturer's Name: Coretronic Corporation

Manufacturer's Address: No 11, Li Hsing Rd, Science-Based Industrial Park, Hsinchu, Taiwan

Importer's Address:

Dell Products Europe BV

Raheen Industrial Estate, Limerick, Ireland

Type of Equipment: DLP Projector

Model Number(s): 2300MP

Reference Report Number:

Previously Declared Models:

I, the undersigned, hereby declare that the equipment specified above conforms to the above Directive(s) and standards.

Hsinchu, Taiwan

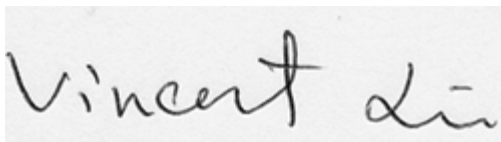

July 01, 2004

Mr. Vincent Lin

Head of RD Center

Canadian Regulatory Information (Canada Only)

This digital apparatus does not exceed the Class B limits for radio noise emissions from digital apparatus set out in the Radio Interference Regulations of the Canadian Department of Communications.

Note that Industry Canada regulations provided, that changes or modifications not expressly approved by Dell Inc. could void your authority to operate this equipment.

This Class B digital apparatus meets all requirements of the Canadian Interference-Causing Equipment Regulations.

Cet appareil numérique de la classe B respecte toutes les exigences du Règlement sur le matériel brouilleur du Canada.

- **Canada RSS-210/CNR210** (RF Remote Controller)

To prevent radio interference to the licensed service, this device is intended to be operated indoors and away from windows to provide maximum shielding. Equipment (or its transmit antenna) that is installed outdoors is subject to licensing.

To reduce potential radio interference to other users, the antenna type and its gain should be so chosen that the equivalent isotropically radiated power (EIRP) is not more than that required for successful communication.

This Class B digital apparatus complies with Canada RSS-210.
Cet appareil numérique de la classe B est conforme à la norme CNR-210 du Canada

The abbreviation, IC, before the registration number signifies that registration was performed based on a Declaration of Conformity indicating that Industry Canada technical specifications were met. It does not imply that Industry Canada approved the equipment.

EN 55022 Compliance (Czech Republic Only)

This device belongs to Class B devices as described in EN 55022, unless it is specifically stated that it is a Class A device on the specification label. The following applies to devices in Class A of EN 55022 (radius of protection up to 30 meters). The user of the device is obliged to take all steps necessary to remove sources of interference to telecommunication or other devices.

Pokud není na typovém štítku počítače uvedeno, že spadá do třídy A podle EN 55022, spadá automaticky do třídy B podle EN 55022. Pro zařízení zařazená do třídy A (ochranné pásmo 30m) podle EN 55022 platí následující. Dojde-li k rušení telekomunikačních nebo jiných zařízení, je uživatel povinen provést taková opatření, aby rušení odstranil.

VCCI Class 2 Notice (Japan Only)

This equipment complies with the limits for a Class 2 digital device (devices used in or adjacent to a residential environment) and conforms to the standards for information technology equipment that are set by the Voluntary Control Council for Interference for preventing radio frequency interference in residential areas.



Class B ITE

この装置は、情報処理装置等電波障害自主規制協議会 (VCCI) の基準に基づくクラス B 情報技術装置です。この装置は家庭環境で使用することを目的としていますが、ラジオやテレビジョン受信機に近接して使用されると、受信障害を引き起こすことがあります。取扱説明書に従って正しい取り扱いをしてください。

MIC Notice (South Korea Only)

B Class Device



명 칭 / 모델 명 : Projector / 2300MP
 인 증 번 호 :
 인증받은자의상호 : 델컴퓨터(주)
 제 조 년 월 일 : 2004
 제 조 자 / 제 조 국 : Coretronic Corporation / 대만

| 기종별 | 사용자 안내문 |
|-----------------------|--|
| B급 기기 (가정용 정보통신기기) | 이 기기는 가정용으로 전자파적합등록을 한 기기로서 주거지역에서는 물론 모든 지역에서 사용할 수 있습니다. |

Please note that this device has been approved for non-business purposes and may be used in any environment, including residential areas.

Polish Center for Testing and Certification Notice

The equipment should draw power from a socket with an attached protection circuit (a three-prong socket). All equipment that works together (computer, monitor, printer, and so on) should have the same power supply source.

The phasing conductor of the room's electrical installation should have a reserve short-circuit protection device in the form of a fuse with a nominal value no larger than 16 amperes (A).

To completely switch off the equipment, the power supply cable must be removed from the power supply socket, which should be located near the equipment and easily accessible.

A protection mark "B" confirms that the equipment is in compliance with the protection usage requirements of standards PN-93/T-42107 and PN-89/E-06251.

Wymagania Polskiego Centrum Badań i Certyfikacji

Urządzenie powinno być zasilane z gniazda z przyłączonym obwodem ochronnym (gniazdo z kołkiem). Współpracujące ze sobą urządzenia (komputer, monitor, drukarka) powinny być zasilane z tego samego źródła.

Instalacja elektryczna pomieszczenia powinna zawierać w przewodzie fazowym rezerwową ochronę przed zwarciami, w postaci bezpiecznika o wartości znamionowej nie większej niż 16A (amperów).

W celu całkowitego wyłączenia urządzenia z sieci zasilania, należy wyjąć wtyczkę kabla zasilającego z gniazdka, które powinno znajdować się w pobliżu urządzenia i być łatwo dostępne.

Znak bezpieczeństwa "B" potwierdza zgodność urządzenia z wymaganiami bezpieczeństwa użytkowania zawartymi w PN-93/T-42107 i PN-EN 55022:1996.

Jeżeli na tabliczce znamionowej umieszczono informację, że urządzenie jest klasy A, to oznacza to, że urządzenie w środowisku mieszkalnym może powodować zakłócenia radioelektryczne. W takich przypadkach można żądać od jego użytkownika zastosowania odpowiednich środków zaradczych.

Pozostałe instrukcje bezpieczeństwa

- Nie należy używać wtyczek adapterowych lub usuwać kołka obwodu ochronnego z wtyczki. Jeżeli konieczne jest użycie przedłużacza to należy użyć przedłużacza 3-żyłowego z prawidłowo połączonym przewodem ochronnym.
- System komputerowy należy zabezpieczyć przed nagłymi, chwilowymi wzrostami lub spadkami napięcia, używając eliminatora przepięć, urządzenia dopasowującego lub bezzaktócenowego źródła zasilania.
- Należy upewnić się, aby nic nie leżało na kablach systemu komputerowego, oraz aby kable nie były umieszczone w miejscu, gdzie można byłoby na nie nadeptywać lub potykać się o nie.
- Nie należy rozlewać napojów ani innych płynów na system komputerowy.
- Nie należy wpychać żadnych przedmiotów do otworów systemu komputerowego, gdyż może to spowodować pożar lub porażenie prądem, poprzez zwarcie elementów wewnętrznych.
- System komputerowy powinien znajdować się z dala od grzejników i źródeł ciepła. Ponadto, nie należy blokować otworów wentylacyjnych. Należy unikać kładzenia luźnych papierów pod komputer oraz umieszczania komputera w ciasnym miejscu bez możliwości cyrkulacji powietrza wokół niego.

NOM Information (Mexico Only)

The following information is provided on the device(s) described in this document in compliance with the requirements of the official Mexican standards (NOM)

Exporter: Dell Inc.
One Dell Way
Round Rock, TX 78682

Importer: Dell Computer de México,
Paseo de la Reforma 2620, 11th Floor
Col. Lomas Altas
México DF

CP 11950

Ship to: Dell Computer de Mexico,
S.A. de C.V. al Cuidado de Kuehne & Nagel
de México S. de R.I., Avenida Soles No. 55
Col. Peñon de los Baños, 15520 Mexico, D.F.

Supply voltage: > 100–240 VAC

Frequency: 50–60 Hz

Current consumption: 3 A

Regulatory Listing

Safety Certifications:

- UL 60950
- cUL
- NOM
- CE Mark--EN60950: 2000
- IEC 60950:1999
- TÜV GS
- GOST
- CCC
- PSB
- TÜV-S
- TÜV-S/Argentina

EMC Certifications:

- FCC Part 15 Class B
 - CE Mark--EN55022:1998+A1: 2000 Class B, EN55024: 1998+A1:2001, EN61000-3-2: 2000, EN61000-3-3:1995_A1: 2001
 - ICES-003
 - C-Tick
 - VCCI Class B ITE
 - MIC
-

[Back to Contents Page](#)

[Back to Contents Page](#)

Contacting Dell

To contact Dell electronically, you can access the following websites:

- www.dell.com
- support.dell.com (technical support)
- premiersupport.dell.com (technical support for educational, government, healthcare, and medium/large business customers, including Premier, Platinum, and Gold customers)

For specific web address for your country, find the appropriate country section in the table below.

NOTE: Toll-free numbers are for use within the country for which they are listed.

When you need to contact Dell, use the electronic addresses, telephone numbers, and codes provided in the following table. If you need assistance in determining which codes to use, contact a local or an international operator.

| Country (City) International Access Code Country Code City Code | Department Name or Service Area, Website and E-mail Address | Area Code | Local Numbers, and Toll-Free Numbers |
|--|--|-----------|--------------------------------------|
| Anguilla | General Support | | toll free:800-335-0031 |
| Antigua and Barbuda | General Support | | 1-800-805-5924 |
| Argentina (Buenos Aires) International Access Code:00 Country Code:54 City Code:11 | Technical Support and Customer Care | | toll free: 0800 444 0733 |
| | Sales | | toll free: 0810 444 3355 |
| | Tech Support Fax | 11 | 4515-7139 |
| | Customer Care Fax | 11 | 4515-7138 |
| | Website: www.dell.com.ar | | toll-free:800-1578 |
| Aruba | General Support | | |
| Australia (Sydney) International Access Code:0011 Country Code:61 City Code:2 | E-mail (Australia): au_tech_support@dell.com | | |
| | E-mail (New Zealand): nz_tech_support@dell.com | | |
| | Home and Small Business | | 1-300-65-55-33 |
| | Government and Business | | toll free: 1-800-633-559 |
| | Preferred Accounts Division (PAD) | | toll free: 1-800-060-889 |
| | Customer Care | | toll free: 1-800-819-339 |
| | Corporate Sales | | toll free: 1-800-808-385 |
| | Transaction Sales | | toll free: 1-800-808-312 |
| | Fax | | toll free: 1-800-818-341 |

| | | | |
|---|--|-----|---------------------------|
| Austria (Vienna) International Access Code:900 Country Code:43 City Code:1 | Switchboard | 01 | 491 040 |
| | Home/Small Business Sales | 01 | 795676-02 |
| | Home/Small Business Fax | 01 | 795676-05 |
| | Home/Small Business Customer Care | 01 | 795676-03 |
| | Preferred Accounts/Corporate Customer Care | | 0660-8056 |
| | Home/Small Business Technical Support | 01 | 795676-04 |
| | Preferred Accounts/Corporate Technical Support | | 0660-8779 |
| | Website: support.euro.dell.com | | |
| | E-mail: tech_support_central_europe@dell.com | | |
| Bahamas | General Support | | toll-free:1-866-278-6818 |
| Barbados | General Support | | 1-800-534-3142 |
| Belgium (Brussels) International Access Code:00 Country Code:32 City Code:2 | Technical Support | 02 | 481 92 88 |
| | Customer Care | 02 | 481 91 19 |
| | Home/Small Business Sales | | toll free: 0800 16884 |
| | Corporate Sales | 02 | 481 91 00 |
| | Fax | 02 | 481 92 99 |
| | Switchboard | 02 | 481 91 00 |
| | Website: support.euro.dell.com | | |
| | E-mail: tech_be@dell.com | | |
| | E-mail for French Speaking Customers: support.euro.dell.com/be/fr/emaildell/ | | |
| Bermuda | General Support | | 1-800-890-0748 |
| Bolivia | General Support | | toll free: 800-10-0238 |
| Brazil International Access Code:00 Country Code:55 City Code:51 | Customer Support, Technical Support | | toll free: 0800 90 3355 |
| | Technical Support Fax | 51 | 481-5470 |
| | Customer Care Fax | 51 | 481-5480 |
| | Sales | | toll free: 0800 90 3390 |
| | Website: www.dell.com/br | | |
| British Virgin Islands | General Support | | toll-free:1-866-278-6820 |
| Brunei Country Code:673 | General Support | 604 | 633 4966 |
| | Customer Service (Penang, Malaysia) | 604 | 633 4949 |
| | Transaction Sales (Penang, Malaysia) | 604 | 633 4955 |
| Canada (North York, Ontario) International Access Code:011 | Automated Order-Status System | | toll free: 1-800-433-9014 |
| | AutoTech (Automated technical support) | | toll free: 1-800-247-9362 |
| | Customer Care Home & Home Office & Small Business | | 1-800-847-4096 |
| | Customer Care Medium, Large, Commercial, | | 1-800-326-9463 |

| | | | |
|---|--|--|---------------------------|
| | Government (100+ Employees) | | |
| | Technical Support Home & Home Office & Small Business | | 1-800-847-4096 |
| | Technical Support Medium, Large, Commercial, Government (100+ Employees) | | 1-800-387-5757 |
| | Sales (direct-from outside Toronto) | | 1-800-387-5752 |
| | Sales (direct-from within Toronto) | | 416-758-2200 |
| | Sales (federal government, education, and medical) | | 1-800-567-7542 |
| | Tech Fax | | toll free: 1-800-950-1329 |
| Cayman Islands | General Support | | 1-800-805-7541 |
| Chile (Santiago) Country Code:56 City Code:2 | Sales, Customer Support, and Technical Support | | toll free: 1230-020-4823 |
| China (Xiamen) Country Code:86 City Code:592 | Tech Support website: support.ap.dell.com/china | | |
| | Tech Support E-mail: cn_support@dell.com | | |
| | Tech Support Fax | | 818-1350 |
| | Projector Technical Support Phone | | toll free: 800 858 2920 |
| | Customer Experience | | toll free: 800 858 2060 |
| | Home and Small Business | | toll free: 800 858 2222 |
| | Preferred Accounts Division | | toll free: 800 858 2062 |
| | Large Corporate Accounts North | | toll free: 800 858 2999 |
| | Large Corporate Accounts North Government and Education | | toll free: 800 858 2955 |
| | Large Corporate Accounts East | | toll free: 800 858 2020 |
| | Large Corporate Accounts East Government and Education | | toll free: 800 858 2669 |
| | Large Corporate Accounts Queue Team | | toll free: 800 858 2572 |
| | Large Corporate Accounts South | | toll free: 800 858 2355 |
| | Large Corporate Accounts West | | toll free: 800 858 2811 |
| | Large Corporate Accounts GCP | | toll free: 800 858 2055 |
| | Large Corporate Account Key Accounts | | toll-free:800-858-2628 |
| | Large Corporate Accounts Spare Parts | | toll free: 800-858--2621 |

| | | | |
|-------------------------------------|--|------|---------------------------|
| Colombia | General Support | | 980-9-15-3978 |
| Costa Rica | General Support | | 0800-012-0435 |
| Czech Republic (Prague) | Technical Support | 02 | 22 83 27 27 |
| International Access Code:00 | Customer Care | 02 | 22 83 27 11 |
| Country Code:420 | Fax | 02 | 22 83 27 14 |
| City Code:2 | TechFax | 02 | 22 83 27 28 |
| | Switchboard | 02 | 22 83 27 11 |
| | Website: support.euro.dell.com | | |
| | E-mail: czech_dell@dell.com | | |
| Denmark (Horsholm) | Technical Support | | 70230182 |
| International Access Code:00 | Customer Care(Relational) | | 70230184 |
| Country Code:45 | Home/Small Business Customer Care | | 32875505 |
| | Switchboard (Relational) | | 32871200 |
| | Fax Switchboard (Relational) | | 32871201 |
| | Switchboard (Home/Small Business) | | 32875000 |
| | Fax Switchboard (Home/Small Business) | | 32875001 |
| | Website: support.euro.dell.com | | |
| | E-mail Support (portable computers): den_nbk_support@dell.com | | |
| | E-mail Support (desktop computers): den_support@dell.com | | |
| | E-mail Support (servers): Nordic_server_support@dell.com | | |
| Dominica | General Support | | toll free: 1-866-278-6821 |
| Dominican Republic | General Support | | toll free: 1-800-156-1588 |
| Ecuador | General Support | | toll-free 999-119 |
| El Salvador | General Support | | 01-889-753-0777 |
| Finland (Helsinki) | Technical Support | 09 | 253 313 60 |
| International Access Code:990 | Technical Support Fax | 09 | 253 313 81 |
| Country Code:358 | Relational Customer Care | 09 | 253 313 38 |
| City Code:9 | Home/Small Business Customer Care | 09 | 693 791 94 |
| | Fax | 09 | 253 313 99 |
| | Switchboard | 09 | 253 313 00 |
| | Website: support.euro.dell.com | | |
| | E-mail: fin_support@dell.com | | |
| France (Paris) (Montpellier) | Home and Small Business | | |
| International Access Code:00 | Technical Support | 0825 | 387 270 |
| Country Code:33 | Customer Care | 0825 | 823 833 |
| City Code:(1)(4) | Switchboard | 0825 | 004700 |
| | Switchboard (calls from outside of France) | 04 | 99 75 40 00 |

| | | | |
|---|---|-------|--------------------------|
| | Sales | 0825 | 004 700 |
| | Fax (calls from outside of France) | 04 | 99 75 40 001 |
| | Website: support.euro.dell.com | | |
| | E-mail: support.euro.dell.com/fr/fr/emaildell/ | | |
| | Corporate | | |
| | Technical Support | 0825 | 004 719 |
| | Customer Care | 0825 | 338 339 |
| | Fax | 01 | 55 94 71 01 |
| | Switchboard | 01 | 55 94 71 00 |
| | Sales | 01 | 55 94 71 00 |
| Germany (Langen) International Access Code:00 Country Code:49 | Technical Support | 06103 | 766-7200 |
| | Home/Small Business Customer Care | | 0180-5-224 400 |
| | Global Segment Customer Care | 06103 | 766-9570 |
| | Preferred Accounts Customer Care | 06103 | 766-9420 |
| | Large Accounts Customer Care | 06103 | 766-9560 |
| | Public Accounts Customer Care | 06103 | 766-9555 |
| | Switchboard | 06103 | 766-7000 |
| | Website: support.euro.dell.com | | |
| | E-mail: tech_support_central_europe@dell.com | | |
| Grenada | General Support | | toll free:1-866-540-3355 |
| Guatemala | General Support | | 1-800-999-0136 |
| Guyana | General Support | | toll free:1-877-440-6511 |
| Hong Kong International Access Code:001 Country Code:852 | Technical Support (Dimension™ and Inspiron™) | | 296-93188 |
| | Technical Support (OptiPlex™, Latitude™, and Dell Precision™) | | 296-93191 |
| | Customer Service (non-technical, post-sales issues) | | 800-93-8291 |
| | Transaction Sales | | toll free: 800 96 4109 |
| | Large Corporate Accounts HK | | toll free: 800 96 4108 |
| | Large Corporate Accounts GCP HK | | toll free: 800 90 3708 |
| | | | |
| India | Technical Support | | 1600-33-8045 |
| | Sales | | 1600-33-8044 |
| Ireland (Cherrywood) International Access Code:16 Country Code:353 | Ireland Technical Support | 1850 | 543 543 |
| | UK Technical Support (dial within UK only) | 1870 | 908 0800 |
| | Home User Customer Care | 01 | 204 4095 |
| | Small Business Customer Care | 01 | 204 4444 |
| | Corporate Customer Care | 01 | 204 4003 |
| | UK Customer Care (dial number within UK only) | 0870 | 906 0010 |
| | Ireland Sales | 01 | 204 4444 |
| | UK Sales (dial within UK only) | 0870 | 907 4000 |

| | | | |
|---------------------------------|--|-----|-------------------------|
| | Sales Fax | 01 | 204 0144 |
| | Fax | 01 | 204 5960 |
| | Switchboard | 01 | 204 4444 |
| | Website: support.euro.dell.com | | |
| | E-mail: dell_direct_support@dell.com | | |
| Italy (Milan) | Home and Small Business | | |
| International Access Code:00 | Technical Support | 02 | 577 826 90 |
| Country Code:39 | Customer Care | 02 | 696 821 14 |
| City Code:2 | Fax | 02 | 696 821 13 |
| | Switchboard | 02 | 696 821 12 |
| | Website: support.euro.dell.com | | |
| | E-mail: support.euro.dell.com/it/it/emaildell/ | | |
| | Corporate | | |
| | Technical Support | 02 | 577 826 90 |
| | Customer Care | 02 | 577 825 55 |
| | Fax | 02 | 577 035 30 |
| | Switchboard | 02 | 577 821 |
| | Website: support.euro.dell.com | | |
| | E-mail: support.euro.dell.com/it/it/emaildell/ | | |
| Jamaica | General Support (dial from within Jamaica only) | | 1-800-404-9205 |
| Japan (Kawasaki) | Web site: support.jp.dell.com | | |
| International Access Code:001 | Technical Support | 44 | toll free: 0120-981-690 |
| Country Code:81 | Technical Support Outside of Japan | 44 | 556-3468 |
| | Customer Care | 44 | 556-4240 |
| Korea (Seoul) | Technical Support | | toll free: 080-200-3800 |
| International Access Code:001 | Sales | | toll free: 080-200-3600 |
| Country Code:82 | Customer Service (Penang, Malaysia) | | toll free: 604-633-4949 |
| City Code:2 | Customer Service (Seoul, Korea) | | 080-200-3800 |
| | Fax | | 2194-6202 |
| | Switchboard | | 2194-6000 |
| Latin America | Customer Technical Support (Austin, Texas, U.S.A.) | 512 | 728-4093 |
| | Customer Service (Austin, Texas, U.S.A.) | 512 | 728-3619 |
| | Fax (Technical Support and Customer Service) (Austin, Texas, U.S.A.) | 512 | 728-3883 |
| | Sales (Austin, Texas, U.S.A.) | 512 | 728-4397 |
| | Sales Fax (Austin, Texas, U.S.A.) | 512 | 728-4600 or 728-3772 |
| Luxembourg International | Technical Support (Brussels, Belgium) | 02 | 481 92 88 |

| | | | |
|---|---|----|--------------------------------------|
| Access Code:00 Country Code:352 | Home/Small Business Sales (Brussels, Belgium) | | toll free: 080016884 |
| | Corporate Sales (Brussels, Belgium) | 02 | 481 91 00 |
| | Customer Care (Brussels, Belgium) | 02 | 481 91 19 |
| | Switchboard (Brussels, Belgium) | 02 | 481 91 00 |
| | Fax (Brussels, Belgium) | 02 | 481 92 99 |
| | Website: support.euro.dell.com | | |
| | E-mail: tech_be@dell.com | | |
| Macao Country Code:853 | Technical Support | | toll free: 0800 582 |
| | Customer Service (Penang, Malaysia) | | 604 633 4949 |
| | Transaction Sales | | toll free: 0800 581 |
| Malaysia (Penang) International Access Code:00 Country Code:60 City Code: 4 | Technical Support | | toll free: 1 800 888 298 |
| | Customer Service | 4 | 633 4949 |
| | Transaction Sales | | toll free: 1 800 888 202 |
| | Corporate Sales | | toll free: 1 800 888 213 |
| Mexico International Access Code:00 Country Code:52 | Customer Technical Support | | 001-877-384-8979 or 001-877-269-3383 |
| | Sales | | 50-81-8800 or 01-800-888-3355 |
| | Customer Service | | 001-877-384-8979 or 001-877-269-3383 |
| | Main | | 50-81-8800 or 01-800-888-3355 |
| Montserrat | General Support | | toll free:1-866-278-6822 |
| Netherlands Antilles | General Support | | 001-800-882-1519 |
| Netherlands (Amsterdam) International Access Code:00 Country Code:31 City Code:20 | Technical Support | 20 | 674 4500 |
| | Home/Small and Medium Business | 20 | 674 5500 |
| | Home/Small and Medium Business Fax | 20 | 674 4775 |
| | Home/Small and Medium Business Customer Care | 20 | 674 4200 |
| | Corporate | 20 | 674 5000 |
| | Corporate Fax | 20 | 674 4779 |
| | Corporate Customer Care | 20 | 674 4325 |
| | Website: support.euro.dell.com | | |
| | E-mail: support.euro.dell.com/nl/nl/emaildell/ | | |
| | | | |
| New Zealand | E-mail (New Zealand): nz_tech_support@dell.com | | |
| | E-mail (Australia): au_tech_support@dell.com | | |
| | Home and Small Business | | 0800 446 255 |
| | Government and Business | | 0800 444 617 |
| | Sales | | 0800 441 567 |

| | | | |
|--|--|-----|--|
| | Fax | | 0800 441 566 |
| Nicaragua | General Support | | 001-800-220-1006 |
| Norway (Lysaker) International Access Code:00 Country Code:47 | Technical Support | | 671 16882 |
| | Relational Customer Care | | 671 17514 |
| | Home/Small Business Customer Care | | 231 62298 |
| | Switchboard | | 671 16800 |
| | Fax Switchboard | | 671 16865 |
| | Website: support.euro.dell.com | | |
| | E-mail Support (portable computers): nor_nbk_support@dell.com | | |
| | E-mail Support (desktop computers): nor_support@dell.com | | |
| E-mail Support (servers): nordic_server_support@dell.com | | | |
| Panama | General Support | | 001-800-507-0962 |
| Peru | General Support | | 0800-50-669 |
| Poland (Warsaw) International Access Code:011 Country Code:48 | Customer Service Phone | 22 | 57 95 700 |
| | Customer Care | 22 | 57 95 999 |
| | Sales | 22 | 57 95 750 |
| | Switchboard | 22 | 57 95 999 |
| | Customer Service Fax | 22 | 57 95 806 |
| | Reception Desk Fax | 22 | 57 95 998 |
| | Website: support.euro.dell.com | | |
| | E-mail: pl_support_tech@dell.com | | |
| Portugal International Access Code:00 Country Code:35 | Technical Support | 35 | 800 834 077 |
| | Customer Care | | 800 300 415 or 800 834 075 |
| | Sales | | 800 300 410 or 800 300 411 or 800 300 412 or 121 422 07 10 |
| | Fax | 35 | 121 424 01 12 |
| | E-mail: support.euro.dell.com/es/es/emaildell/ | | |
| Puerto Rico | General Support | | 1-800-805-7545 |
| St. Kitts and Nevis | General Support | | toll free:1-877-441-4731 |
| St. Lucia | General Support | | 1-800-882-1521 |
| St. Vincent and the Grenadines | General Support | | toll free:1-877-441-4740 |
| Singapore (Singapore) International Access Code:005 Country Code:65 | Technical Support | | toll free: 800 6011 051 |
| | Customer Service (Penang, Malaysia) | 604 | 633 4949 |
| | Transaction Sales | | toll free: 800 6011 054 |

| | | | |
|---|--|-----|-------------------------|
| | Corporate Sales | | toll free: 800 6011 053 |
| South Africa (Johannesburg) International Access Code:09/091 Country Code:27 City Code:11 | Technical Support | 011 | 709 7710 |
| | Customer Care | 011 | 709 7707 |
| | Sales | 011 | 709 7700 |
| | Fax | 011 | 706 0495 |
| | Switchboard | 011 | 709 7700 |
| | Website: support.euro.dell.com | | |
| | E-mail: dell_za_support@dell.com | | |
| Southeast Asian/Pacific Countries | Customer Technical Support, Customer Service, and Sales (Penang, Malaysia) | 604 | 633-4810 |
| Spain (Madrid) International Access Code:00 Country Code:34 City Code:91 | Home and Small Business | | |
| | Technical Support | 91 | 902 100 130 |
| | Customer Care | 91 | 902 118 540 |
| | Sales | 91 | 902 118 541 |
| | Switchboard | 91 | 902 118 541 |
| | Fax | 91 | 902 118 539 |
| | Website: support.euro.dell.com | | |
| | E-mail: support.euro.dell.com/es/es/emaildell/ | | |
| | Corporate | | |
| | Technical Support | 91 | 902 100 130 |
| | Customer Care | 91 | 902 118 546 |
| | Switchboard | 91 | 722 92 00 |
| | Fax | 91 | 722 95 83 |
| | Website: support.euro.dell.com | | |
| | E-mail: support.euro.dell.com/es/es/emaildell/ | | |
| Sweden (Upplands Vasby) International Access Code:00 Country Code:46 City Code:8 | Technical Support | 08 | 590 05 199 |
| | Relational Customer Care | 08 | 590 05 642 |
| | Home/Small Business Customer Care | 08 | 587 70 527 |
| | Employee Purchase Program (EPP) Support | | 20 140 14 44 |
| | Fax Technical Support | 08 | 590 05 594 |
| | Sales | 08 | 590 05 185 |
| | Website: support.euro.dell.com | | |
| | E-mail: swe_support@dell.com | | |
| | E-mail Support for Latitude™ and Inspiron™: Swe-nbk_kats@dell.com | | |
| | E-mail Support for OptiPlex: Swe_kats@dell.com | | |
| | E-mail Support for Servers: nordic_server_support@dell.com | | |
| Switzerland (Geneva) | Technical Support (Home and Small Business) | 22 | 0844 811 411 |

| | | | |
|--|--|-------|---------------------------------------|
| International Access Code:00 Country Code:41 City Code:22 | Technical Support (Corporate) | 22 | 0844 822 844 |
| | Customer Care (Home and Small Business) | 22 | 0848 802 202 |
| | Customer Care(Corporate) | | 0848 821 721 |
| | Switchboard | 22 | 799 01 01 |
| | Fax | 22 | 799 01 90 |
| | Website: support.euro.dell.com | | |
| | E-mail:swisstech@dell.com | | |
| | E-mail for French-speaking HSB and Corporate Customers: support.euro.dell.com/ch/fr/emaildell/ | | |
| Taiwan International Access Code:002 Country Code:886 | Technical Support (portable and desktop computers) | | toll free: 00801 86 1011 |
| | Technical Support (Servers) | | toll free: 0080 60 1256 |
| | Transaction Sales | | toll free:0800 651 228 or 0800 33 556 |
| | Corporate Sales | | toll free: 0080 651 227/ 0800 33 555 |
| Thailand International Access Code:001 Country Code:66 | Technical Support | | toll free: 088 006 007 |
| | Customer Service (Penang, Malaysia) | 604 | 633 4949 |
| | Sales | | toll free: 088 006 009 |
| Trinidad and Tobago | General Support | | 1-800-805-8035 |
| Turks and Caicos Islands | General Support | | toll free:1-866-540-3355 |
| U.K. (Bracknell) International Access Code:44 Country Code:44 | Technical Support (Corporate/Preferred Accounts/PAD [1000+ employees]) | 0870 | 908 0500 |
| | Technical Support (Direct/PAD and general) | 0870 | 908 0800 |
| | Global Accounts Customer Care | 01344 | 373 185 or 373 186 |
| | Corporate Customer Care | 0870 | 908 0500 |
| | Preferred Accounts (500-5000 employees) Customer Care | 01344 | 373 196 |
| | Central Government Customer Care | 01344 | 373 193 |
| | Local Government & Education Customer Care | 01344 | 373 199 |
| | Health Customer Care | 01344 | 373 194 |
| | Home/Small Business Sales | 0870 | 907 4000 |
| | Home/Small Business Customer Care | 0870 | 906 0010 |
| | Corporate/Public Sector Sales | 01344 | 860 456 |
| | Website: support.euro.dell.com | | |
| | Customer Care website: dell.co.uk/lca/customerservices | | |
| E-mail: dell_direct_support@dell.com | | | |
| Uruguay | General Support | | toll free:000-413-598-2521 |

| | | |
|---|--|--|
| U.S.A. (Austin, Texas) International Access Code:011 Country Code:1 | Automated Order-Status System | toll free: 1-800-433-9014 |
| | AutoTech (portable and desktop computers) | toll free: 1-800-247-9362 |
| | Projectors Technical Support | toll free: 1-877-459-7298 |
| | Customer Service | toll free: 1-800-624-9897 |
| | Dell Sales | toll free: 1-800-289-3355 or toll free: 1-800-879-3355 |
| | Dell Outlet Store (Dell refurbished computers) | toll free: 1-888-798-7561 |
| | Software and Peripherals Sales | toll free: 1-800-671-3355 |
| | Spare Parts Sales | toll free: 1-800-357-3355 |
| | Extended Service and Warranty Sales | toll free: 1-800-247-4618 |
| | Fax | toll free: 1-800-727-8320 |
| Dell Services for the Deaf, Hard-of-Hearing, or Speech-Impaired | toll free: 1-877-DELLTTY (1-877-335-5889) | |
| U.S. Virgin Islands | General Support | 1-877-673-3355 |
| Venezuela | General Support | 8001-3605 |

[Back to Contents Page](#)

Free Manuals Download Website

<http://myh66.com>

<http://usermanuals.us>

<http://www.somanuals.com>

<http://www.4manuals.cc>

<http://www.manual-lib.com>

<http://www.404manual.com>

<http://www.luxmanual.com>

<http://aubethermostatmanual.com>

Golf course search by state

<http://golfingnear.com>

Email search by domain

<http://emailbydomain.com>

Auto manuals search

<http://auto.somanuals.com>

TV manuals search

<http://tv.somanuals.com>