



Dell™ Mobile Projector (M900HD) User's Guide



Notes, Cautions, and Warnings

 **NOTE:** A NOTE indicates important information that helps you make better use of your projector.

 **CAUTION:** A CAUTION indicates potential damage to hardware or loss of data if instructions are not followed.

 **WARNING:** A WARNING indicates a potential for property damage, personal injury, or death.

Information in this document is subject to change without notice.
© 2013 Dell Inc. All rights reserved.

Reproduction of these materials in any manner whatsoever without the written permission of Dell Inc. is strictly forbidden.

Trademarks used in this text: Dell and the DELL logo are trademarks of Dell Inc.; DLP and DLP logo and DLP BrilliantColor are trademarks of TEXAS INSTRUMENTS INCORPORATED; Microsoft and Windows are either trademarks or registered trademarks of Microsoft Corporation in the United States and/or other countries.

Wi-Fi® is a registered trademark of Wireless Ethernet Compatibility Alliance, Inc.

Other trademarks and trade names may be used in this document to refer to either the entities claiming the marks and names or their products. Dell Inc. disclaims any proprietary interest in trademarks and trade names other than its own.

Model : Dell Mobile Projector (M900HD)

July 2013 Rev. A00

Contents

| | | |
|----------|--|-----------|
| 1 | Your Dell Projector | 4 |
| | About Your Projector | 5 |
| 2 | Connecting Your Projector | 7 |
| | Connecting to a Computer | 8 |
| | Connecting to Smartphone or Tablet Using Wi-Fi | 10 |
| | Connecting a DVD Player | 11 |
| | Connecting to Multimedia. | 12 |
| 3 | Using Your Projector | 14 |
| | Turning Your Projector On. | 14 |
| | Turning Your Projector Off | 14 |
| | Adjusting the Projected Image. | 15 |
| | Adjusting the Projector Focus | 16 |
| | Adjusting Projection Image Size | 17 |
| | Using the Control Panel | 19 |
| | Using the Remote Control. | 21 |
| | Installing the Remote Control Battery | 23 |
| | Operating Range with Remote Control | 24 |
| | Using the On-Screen Display. | 25 |
| | Multimedia Introduction | 35 |
| | Intel® Wireless Display (WiDi) Installation. | 44 |
| | Wi-Fi Display Installation. | 48 |
| | Managing the Projector From Web Management | 59 |
| | Make Application Token | 70 |
| 4 | Troubleshooting Your Projector | 71 |
| | Guiding Signals | 74 |
| 5 | Specifications | 75 |
| 6 | Contacting Dell | 79 |
| 7 | Appendix: Glossary | 80 |

1

Your Dell Projector

Your projector comes with all the items shown below. Ensure that you have all the items, and contact Dell™ if anything is missing.

Package Contents

Power cable

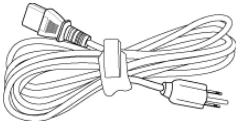

1.2 m USB cable (USB-A to USB-A)

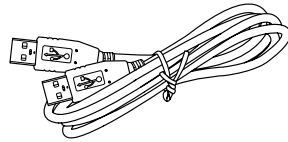

Remote control



Carrying case

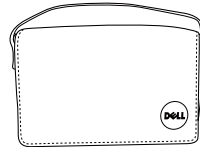

CD User's Guide and Documentation Sleeve cover

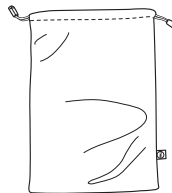
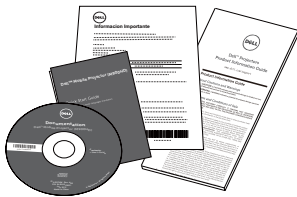

About Your Projector

Top View

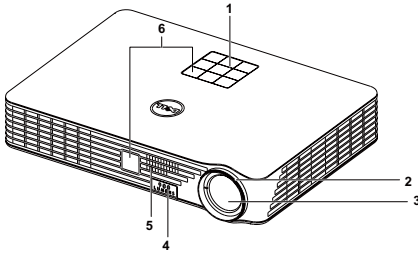

Bottom View

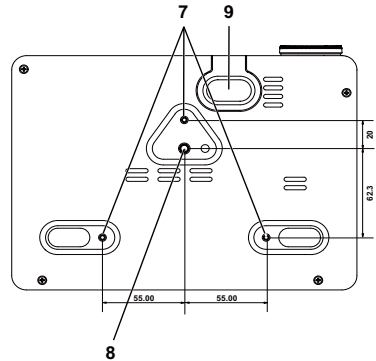

- | | |
|---|--|
| 1 | Control panel |
| 2 | Focus ring |
| 3 | Lens |
| 4 | Elevator button for height adjustments |
| 5 | 3 W speaker |
| 6 | IR receivers |
| 7 | Mounting holes for ceiling mount: Screw hole M3 x 6.5 mm depth. Recommended torque <15 kgf-cm |
| 8 | Mounting hole for tripod: Insert nut 1/4"*20 UNC |
| 9 | Elevator foot |

CAUTION: Safety Instructions

- 1 Do not use the projector near appliances that generate a lot of heat.
- 2 Do not use the projector in areas where there is an excessive amount of dust. The dust may cause the system to fail and the projector will automatically shut down.
- 3 Ensure that the projector is mounted in a well-ventilated area.
- 4 Do not block the ventilation slots and openings on the projector.
- 5 Ensure the projector operates between ambient temperatures (5 °C to 35 °C).

- 6** Do not try to touch the ventilation outlet as it can become very hot after the projector has been turned on or immediately after it is turned off.
- 7** Do not look into the lens while the projector is on as it may cause injury to your eyes.
- 8** Do not place any objects near or in front of the projector or cover its lens while the projector is on as the heat may cause the object to melt or burn.
- 9** Do not use alcohol to wipe the lens.
- 10** Do not use the wireless projector near cardiac pacemakers.
- 11** Do not use the wireless projector near medical equipment.
- 12** Do not use the wireless projector near microwave ovens.

**NOTE:**

- Do not attempt to ceiling mount the projector by yourself. It should be installed by a qualified technician.
- Recommended Projector ceiling mount Kit (P/N: C3505). For more information, see the Dell Support website at dell.com/support.
- For more information, see the Safety Information that shipped with your projector.
- The M900HD projector can only be used indoors.

2

Connecting Your Projector

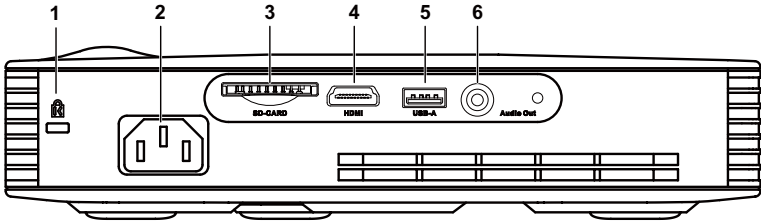

| | | | |
|---|---|---|---|
| 1 | Security cable slot | 4 | HDMI connector |
| 2 | Power cord connector | 5 | USB type A connector for USB display, multimedia playback (Video/Music/Photo/Office Viewer), USB memory storage access (USB flash drive/internal memory) and projector firmware upgrade |
| 3 | SD card slot for multimedia playback (Video/ Music/ Photo/ Office Viewer) | 6 | Audio-out connector |

⚠ CAUTION: Before you begin any of the procedures in this section, follow the Safety Instructions as described on page 5.

Connecting to a Computer

Connecting a Computer Using a USB Cable

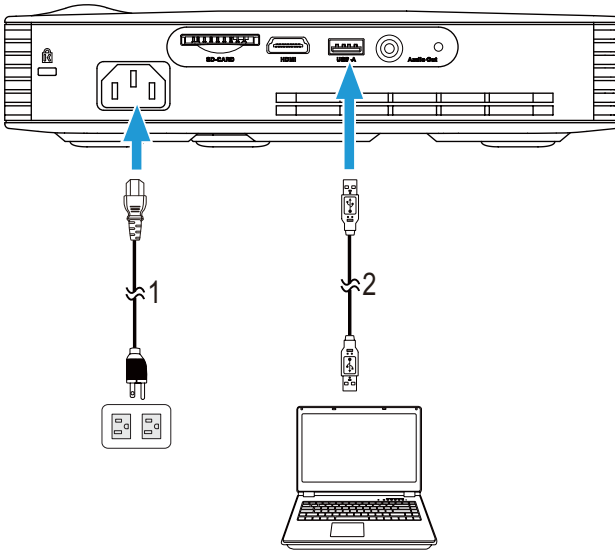



-
- 1 Power cord
 - 2 USB-A to USB-A cable
-

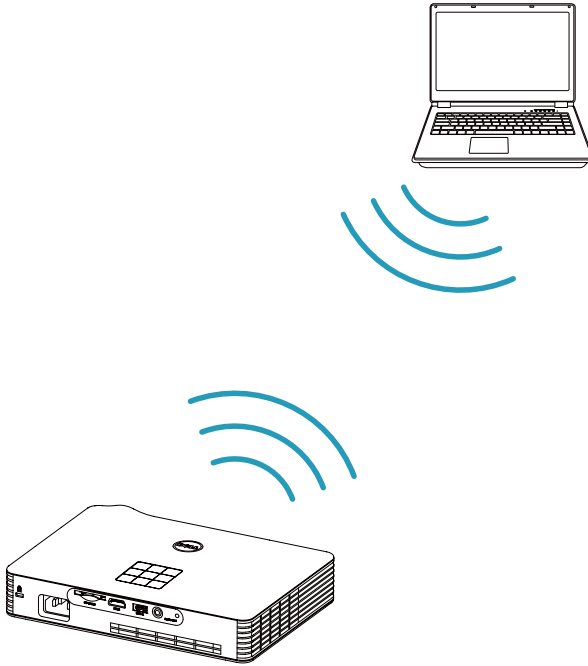

NOTE: Plug and Play. Only one USB (type A to A) cable is shipped with your projector. An additional USB (type A to A) cable can be purchased on the Dell website at www.dell.com.

Connecting a Computer Using Intel® WiDi or Wi-Fi



 **NOTE:** Your computer should be equipped with a wireless connector and properly configured to detect another wireless connection. Refer to your computer's documentation on how to configure a wireless connection.

 **NOTE:** To connect a computer via Intel® WiDi, your computer must be Intel® WiDi compatible.

Connecting to Smartphone or Tablet Using Wi-Fi

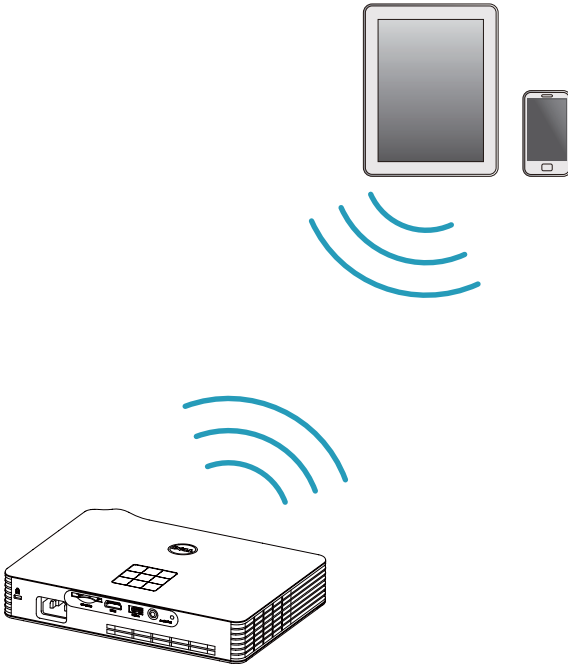

NOTE: Dell M900HD supports MobiShow and WiFi-Doc functions. They are applications which transmit supported content from your Android or iOS devices wirelessly. After installing and launching the application on your mobile device, enable Wi-Fi on your mobile device and connect to the projector network, Dell M900HD. For more Information, please visit go to Dell Support site at dell.com/support.

Files supported are:

| | | |
|----------|-----------------------------------|----------------|
| MobiShow | Photo Format | PtG Format |
| | JPEG/JPG | PtG2 |
| WiFi-Doc | Document Format | Picture Format |
| | MS Word/Excel/PowerPoint/PDF/Text | JPEG/JPG |

Connecting a DVD Player

Connecting a DVD Player Using a HDMI Cable

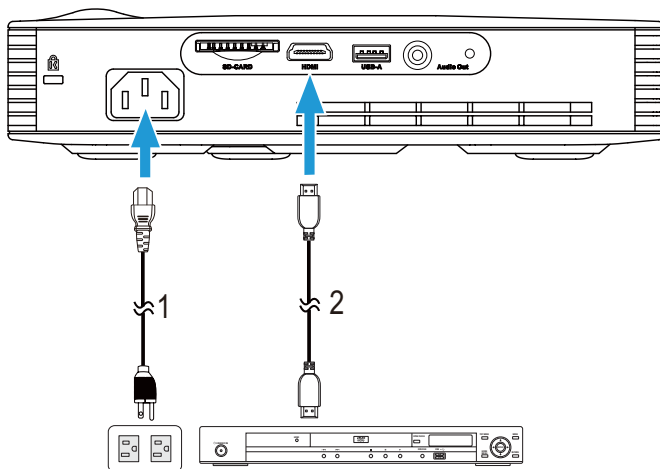

1 Power cord

2 HDMI cable



NOTE: The HDMI cable is not shipped with your projector. You can purchase the HDMI cable on the Dell website at www.dell.com.

Connecting to Multimedia

Connecting Multimedia Using a USB Flash Disk

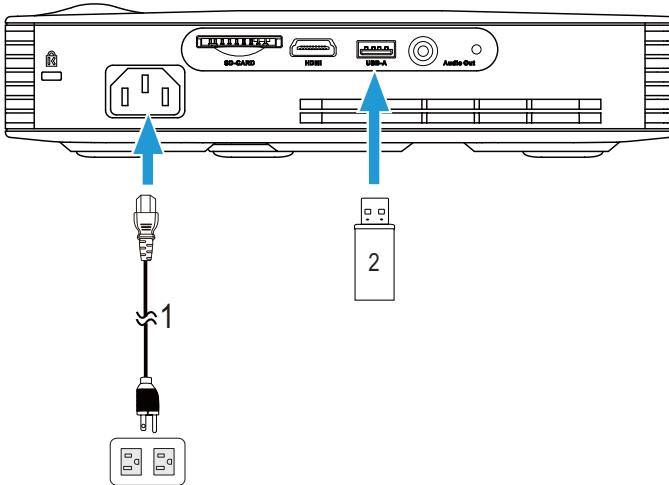

-
- 1 Power cord
 - 2 USB flash disk
-

 **NOTE:** The USB flash disk is not shipped with your projector.

Connecting Multimedia Using a SD Card

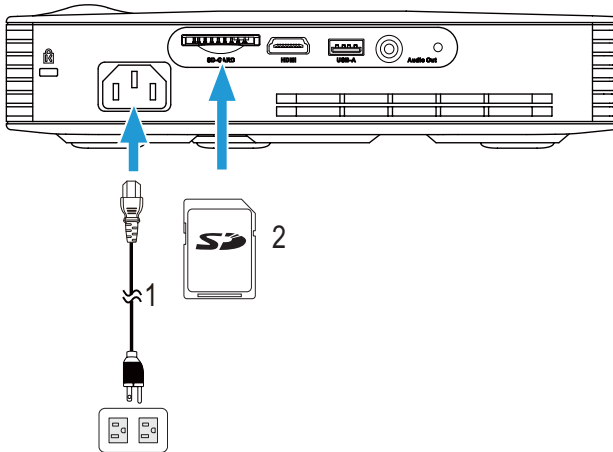

1 Power cord

2 SD card



NOTE: The SD card is not shipped with your projector.

3

Using Your Projector

Turning Your Projector On



NOTE: Turn on the projector before you turn on the source (computer, DVD player, etc.). The Power button light blinks white until pressed.

- 1 Connect the power cord and appropriate signal cables to the projector. For information about connecting the projector, see "Connecting Your Projector" on page 7.
- 2 Press the **Power** button (see "Using the Control Panel" on page 19 to locate the **Power** button).
- 3 Turn on your source (computer, DVD player, etc.).
- 4 Connect your source to the projector using the appropriate cable. See "Connecting Your Projector" on page 7 for instructions to connect your source to the projector.
- 5 By default, the input source of the projector is set to Intel® WiDi. Change the input source of the projector if necessary.
- 6 If you have multiple sources connected to the projector, press the Source button on the remote control or control panel to select the desired source. See "Using the Control Panel" on page 19 and "Using the Remote Control" on page 21 to locate the Source button.

Turning Your Projector Off



CAUTION: Unplug the projector after properly shutting down as explained in the following procedure.

- 1 Press the **Power** button. Follow the instruction displayed on screen to properly turn off the projector.
-  **NOTE:** The "**Press Power Button to Turn off Projector**" message will appear on the screen. The message disappears after 5 seconds or you can press the Menu button to clear it.
- 2 Press the **Power** button again. The cooling fans continue to operate for 120 seconds.
 - 3 To power off the projector quickly, press the Power button and hold for 1 second while the projector's cooling fans are still running.

 **NOTE:** Before you turn on the projector again, wait for 60 seconds to allow the internal temperature to stabilize.

4 Disconnect the power cord from the electrical outlet and the projector.

Adjusting the Projected Image

Raising the Projector Height

- 1 Press the **Elevator** button.
- 2 Raise the projector to the desired display angle, and then release the button to lock the elevator foot into position.

Lowering the Projector Height

- 1 Press the **Elevator** button.
- 2 Lower the projector, and then release the button to lock the elevator foot into position.

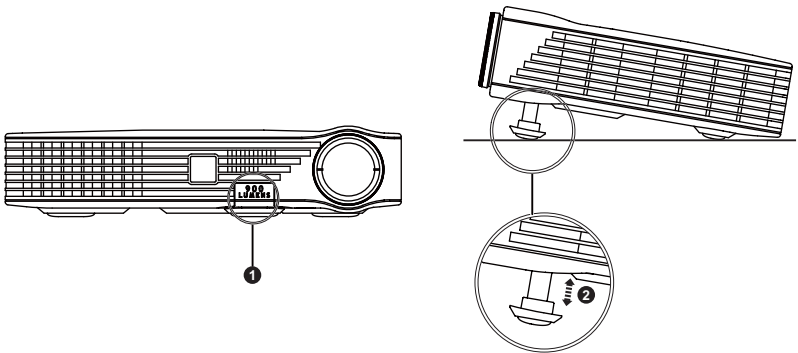

-
- | | |
|-------|---|
| 1 | Elevator button |
| <hr/> | |
| 2 | Elevator foot (Angle of tilt: 0 to 9.6 degrees) |
-

Adjusting the Projector Focus

CAUTION: To avoid damaging the projector, ensure that the elevator foot is fully retracted before moving the projector or placing the projector in its carrying case.

- 1 Rotate the focus ring until the image is clear. The projector focuses at distances ranging between 2.98 ft to 7.87 ft (91 cm to 240 cm).

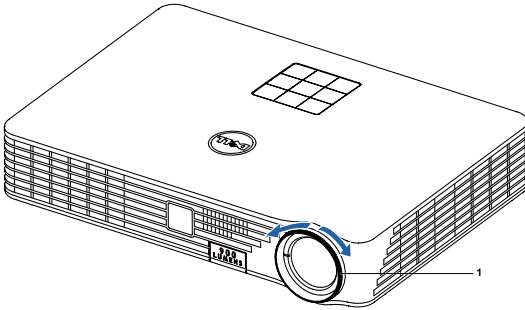

1 Focus ring

Adjusting Projection Image Size

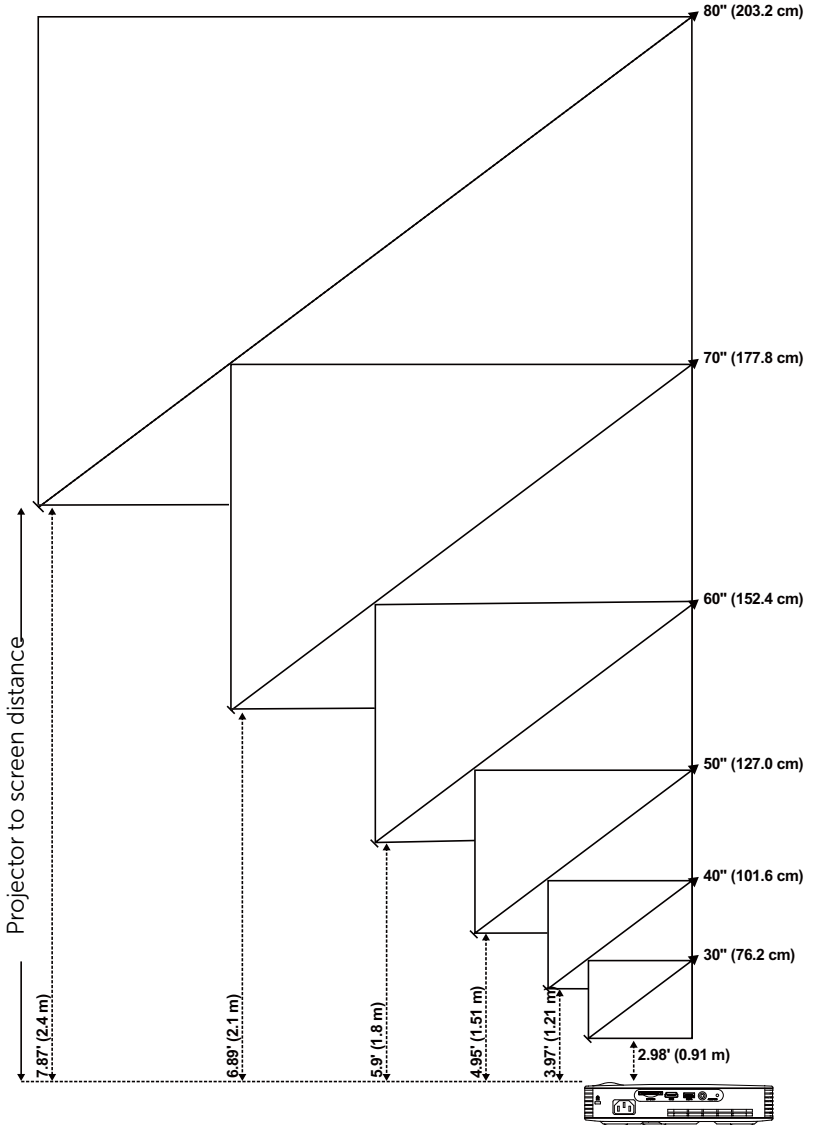

| Desired Distance (m) <A> | Screen size | | Top |
|-----------------------------|------------------------|-----------------|--|
| | Diagonal (inch) | W (cm) x H (cm) | From base to top of image (cm) <C> |
| 0.91 | 30 | 65 x 41 | 43 |
| 1.21 | 40 | 86 x 54 | 57 |
| 1.51 | 50 | 108 x 67 | 71 |
| 1.8 | 60 | 129 x 80 | 84 |
| 2.1 | 70 | 150 x 94 | 98 |
| 2.4 | 80 | 171 x 107 | 113 |



* This graph is for user reference only.

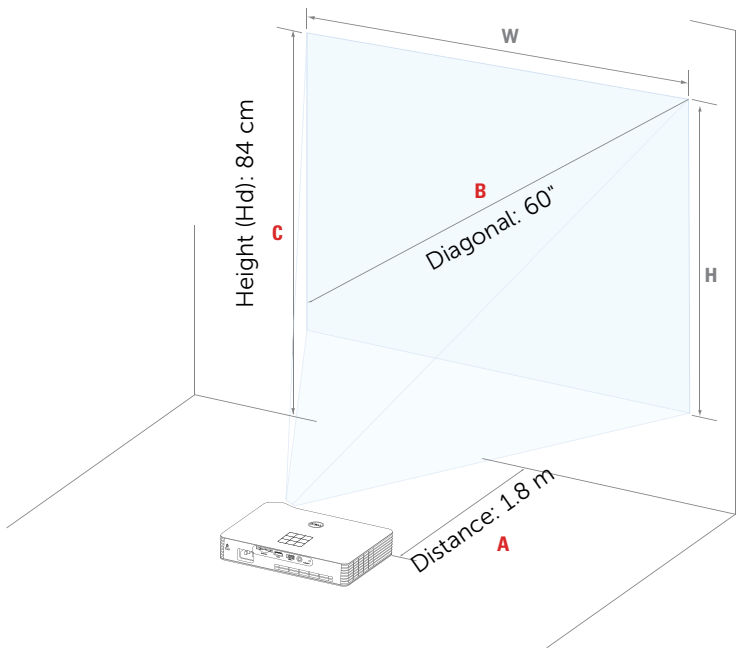

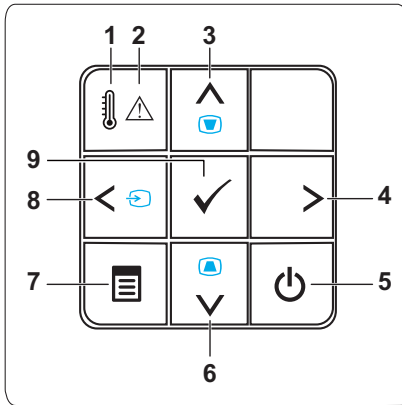

* Offset Ratio: 105±5%



Using the Control Panel







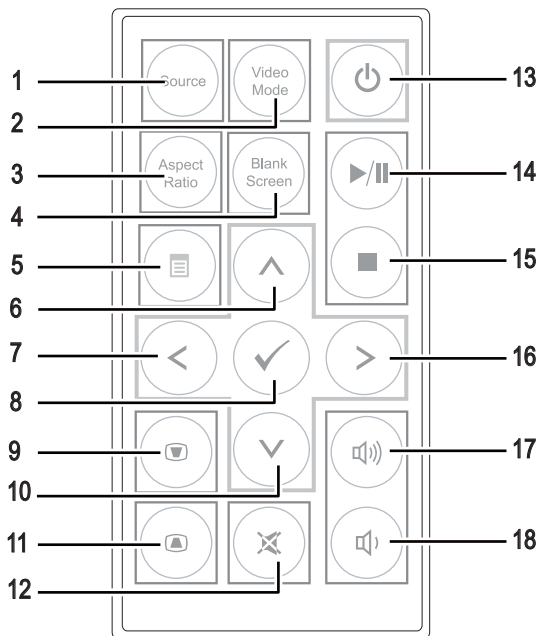

| | |
|--|--|
| 1 TEMP LED | <p>If the TEMP amber indicator is on or blinking, one of the following problems could be occurring:</p> <ul style="list-style-type: none"> • Internal temperature of the projector is too high <p>For more information, see "Troubleshooting Your Projector" on page 71 and "Guiding Signals" on page 74.</p> |
| 2 Error LED | <p>Error LED is blinking amber, one of the RGB LED has failed. The projector will automatically shut down.</p> |
| 3 Up  / Keystone adjustment | <p>Press to navigate through the On-Screen Display (OSD) Menu items.</p> <p>Press to adjust image distortion caused by tilting the projector (+/-40 degrees).</p> |
| 4 Right  | <p>Press to navigate through the On-Screen Display (OSD) Menu items.</p> |
| 5 Power | <p>Turns the projector on or off. For more information, see "Turning Your Projector On" on page 14 and "Turning Your Projector Off" on page 14.</p> |

| | | |
|---|--|--|
| 6 | Down  / Keystone adjustment | Press to navigate through the On-Screen Display (OSD) Menu items. Press to adjust image distortion caused by tilting the projector (+/-40 degrees). |
| 7 | Menu  | Press to activate the OSD. Use the directional keys and the Menu button to navigate through the OSD. |
| 8 | Left  / Source | Press to navigate through the On-Screen Display (OSD) Menu items. Press to toggle through Intel® WiDi, Wi-Fi, DoUSB, HDMI, USB, SD, and Internal Memory sources when multiple sources are connected to the projector. |
| 9 | Enter  | Press to confirm the selected item. |

Using the Remote Control



| | | |
|---|--------------|--|
| 1 | Source | Press to switch between Analog RGB, Composite, and HDMI source. |
| 2 | Video mode | <p>The projector has preset configurations that are optimized for displaying data (presentation slides) or video (movies, games, etc.).</p> <p>Press the Video Mode button to toggle between Presentation mode, Bright mode, Movie mode, sRGB, or Custom mode.</p> <p>Pressing the Video Mode button once will show the current display mode. Pressing the Video Mode button again will switch between modes.</p> |
| 3 | Aspect ratio | Press to change aspect ratio of a displayed image. |
| 4 | Blank screen | Press to hide/unhide the image. |

| | | |
|----|--|---|
| 5 | Menu | Press to activate the OSD. |
| 6 | Up  | Press to navigate through the On-Screen Display (OSD) Menu items. |
| 7 | Left  | Press to navigate through the On-Screen Display (OSD) Menu items. |
| 8 | Enter | Press to confirm the selection. |
| 9 | Keystone adjustment | Press to adjust image distortion caused by tilting the projector (+/-40 degrees). |
| 10 | Down  | Press to navigate through the On-Screen Display (OSD) Menu items. |
| 11 | Keystone adjustment | Press to adjust image distortion caused by tilting the projector (+/-40 degrees). |
| 12 | Mute | Press to mute or un-mute the projector speaker. |
| 13 | Power | Turns the projector on and off. For more information, see "Turning Your Projector On" on page 14 and "Turning Your Projector Off" on page 14. |
| 14 | Play/Pause  | Press to play/pause media file. |
| 15 | Stop  | Press to stop playing media file. |
| 16 | Right  | Press to navigate through the On-Screen Display (OSD) Menu items. |
| 17 | Volume up | Press to increase the volume. |
| 18 | Volume down | Press to decrease the volume. |

Installing the Remote Control Battery

- 1 Remove the battery holder by holding down the side release firmly and pulling out the battery holder.

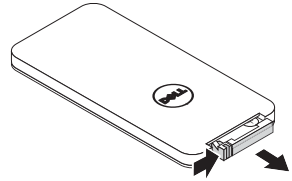

- 2 Insert a CR2025 coin cell battery and align the polarity correctly according to the marking in the battery holder.

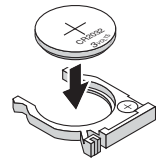

-  **NOTE:** When you use the remote control for the first time, there is a plastic sheet between the battery and its contact. Remove the sheet before use.

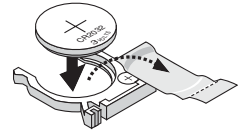

- 3 Replace the battery holder.

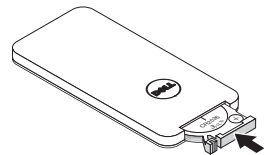



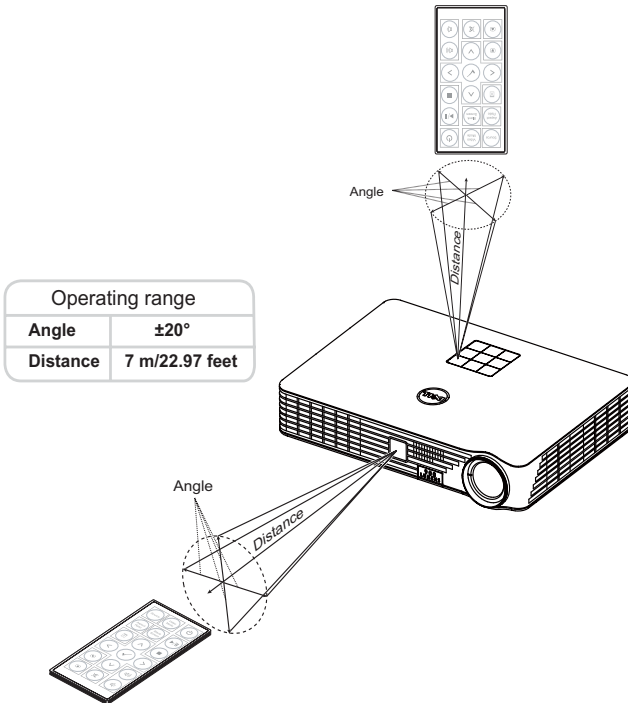

Operating Range with Remote Control



NOTE: Actual operating range may slightly differ from the diagram. Weak battery will also prevent the remote control from properly operating the projector.

Using the On-Screen Display

- The projector has a multi-language On-Screen Display (OSD) Menu that can be displayed with or without an input source.
- Press the Menu button on the control panel or the remote control to enter the Main Menu.
- To select an option, press the  or  buttons on your projector's control panel or remote control.
- Use the  or  buttons on the control panel or remote control to adjust the settings.
- To exit the OSD, press the **Menu** button directly on the control panel or the remote control.

INPUT SOURCE

The Input Source menu allows you to select your projector's input source.

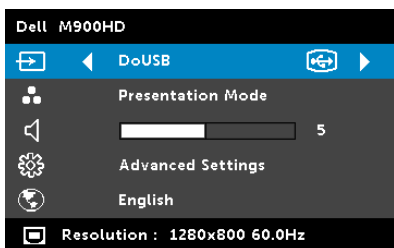

INTEL® WIDI—Press  to access the projector's Intel® Widi Guide screen (the default).

Wi-Fi—Press  to access the projector's Wireless Guide screen.

DoUSB—Allows you to display the computer/laptop screen to your projector via the USB cable.



NOTE: If the DoUSB can not display, please see "Troubleshooting" on page 71.

HDMI—Press  to detect a HDMI signal.

USB—Allows you to playback the photo, music, or video files from your USB flash disk. See "Multimedia Introduction" on page 35.

SD—Allows you to playback the photo, music, or video files from your SD card. See "Multimedia Introduction" on page 35.

INTERNAL MEMORY—Allows you to playback the photo, music, or video files from internal memory of the projector. See "Multimedia Introduction" on page 35.



NOTE:

STORAGE MODE—You may also connect USB cable in Internal Memory source to execute copy, delete, move and more instructions from your computer to projector internal memory and SD card.

When you connect the projector and computer via USB cable, a USB Connected message will pop up and allow you to select **DoUSB** or **Storage Mode**.

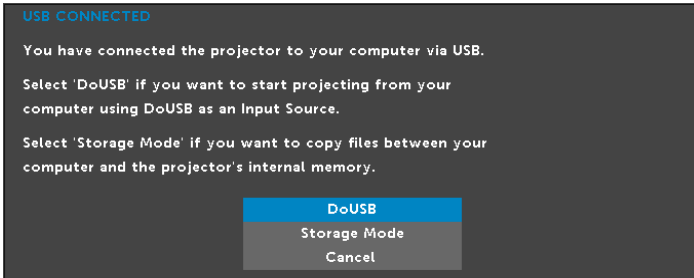

VIDEO MODE

The Video Mode menu allows you to optimize the display image. The options are: **Presentation**, **Bright**, **Movie**, **sRGB** (provides more accurate color representation), and **Custom** (set your preferred settings) mode.

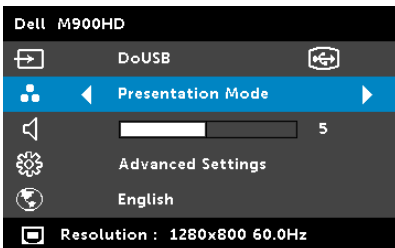

VOLUME

The Volume menu allows you adjust the volume setting of your projector.

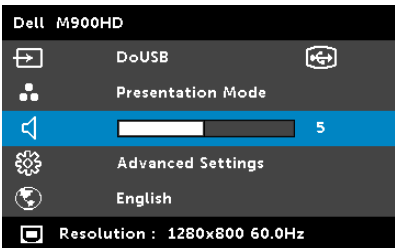

VOLUME—Press ◀ to decrease the volume and ▶ to increase the volume.

ADVANCED SETTINGS

The Advanced Settings menu allows you to change settings for **Image**, **Display**, **Projector**, **Menu**, **Power**, and **Information**.

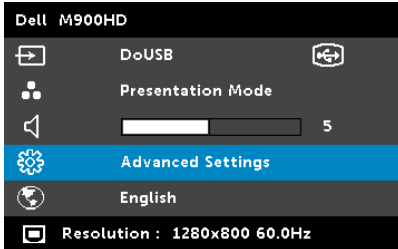







IMAGE SETTINGS—Select and press  to activate image settings. The image settings menu provides the following options:



BRIGHTNESS—Press  and  to adjust the brightness of the image.

CONTRAST—Press  and  to adjust the display contrast.

COLOR TEMPERATURE—Allows you to adjust the color temperature. The screen appears cooler at higher color temperatures and warmer at lower color temperatures.

WHITE INTENSITY—Press  and use  and  to display white intensity.



NOTE: If you adjust the settings for **Brightness**, **Contrast**, **Color Temperature**, and **White Intensity** the projector automatically switches to Custom mode.

DISPLAY SETTINGS—Select and press  to activate display settings. The display settings menu provides the following options:

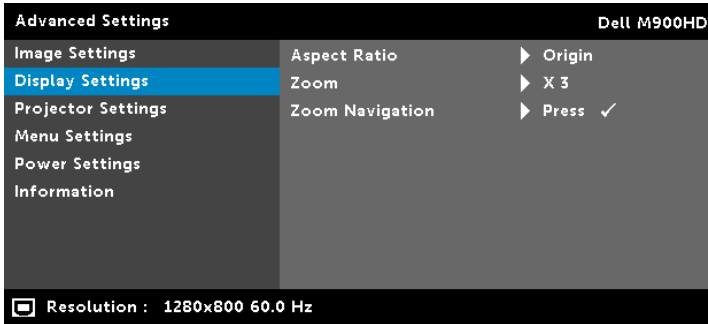





ASPECT RATIO—Allows you to select the aspect ratio to adjust how the image appears. Options are: Origin, 16:10, and 4:3.

- Origin — Select Origin to maintain the aspect ratio of the image projector according to the input source.
- 16:10 — The input source scales to fit the width of the screen to project a 16:10 screen image.
- 4:3 — The input source scales to fit the screen and projects a 4:3 image.

ZOOM—Press  and  to zoom and view the image.



ZOOM NAVIGATION—Press  to activate the **Zoom Navigation** menu.

Use     to navigate the projection screen.

PROJECTOR SETTINGS—Select and press  to activate projector settings. The projector settings menu provides the following options:

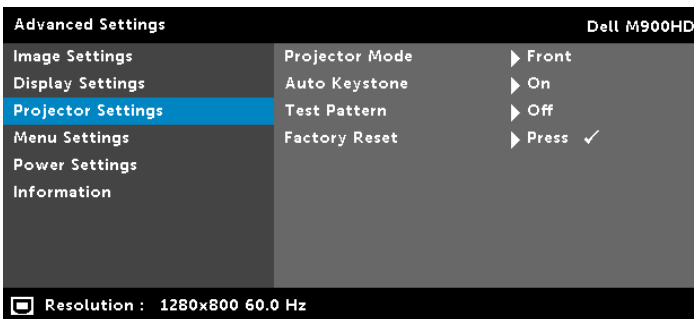





PROJECTOR MODE—Allows you to select the projector mode, depending upon how the projector is mounted.

- Rear Projection-Desktop — The projector reverses the image so that you can project from behind a translucent screen.
- Rear Projection-Ceiling Mount — The projector reverses and turns the image upside down. You can project from behind a translucent screen with a ceiling-mounted projection.
- Front Projection-Desktop — This is the default option.
- Front Projection-Ceiling Mount — The projector turns the image upside down for ceiling-mounted projection.

AUTO KEYSTONE—Select **On** to automatically adjust image distortion caused by tilting the projector.

TEST PATTERN—Test Pattern is used to test focus and resolution.

You can enable or disable the **Test Pattern** by selecting **Off**, **1**, or **2**. You can also invoke the **Test Pattern 1** by pressing and holding down  and  buttons on the control panel simultaneously for 2 seconds. You can also invoke the test pattern 2 by pressing and holding down  and  buttons on the control panel simultaneously for 2 seconds.

Test Pattern 1:

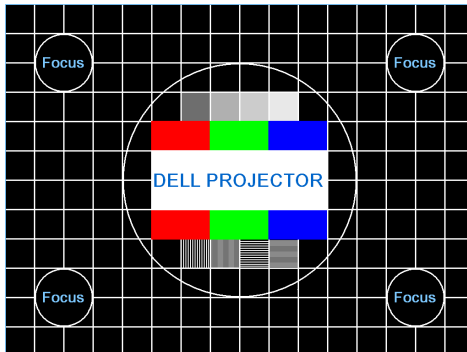

Test Pattern 2:

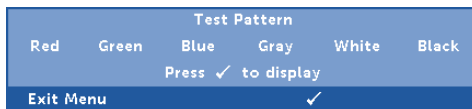

FACTORY RESET—Select Confirm and press  to reset all settings to its factory default. The below warning message appears:



Reset items include both computer sources and Video source settings.

MENU SETTINGS—Select and press  to activate the menu settings. The menu settings consists of the following options:

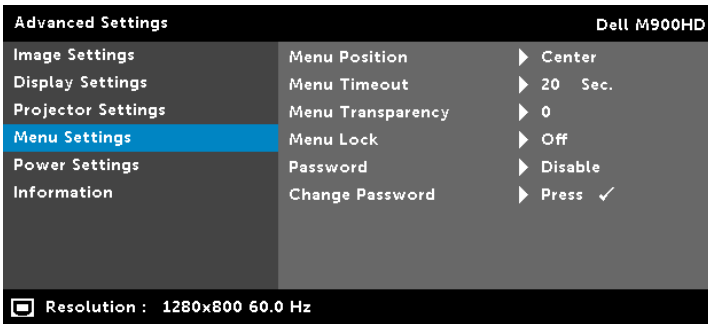

MENU POSITION—Allows you to change the position of the OSD menu on the screen.

MENU TIMEOUT—Allows you to adjust the time for an OSD timeout. By default, the OSD disappears after 20 seconds of non-activity.

MENU TRANSPARENCY—Select to change the transparency level of the OSD background.

MENU LOCK—Select **On** to enable Menu Lock and hide the OSD menu. Select **Off** to disable the Menu Lock. If you want to disable the Menu Lock function and have the OSD disappear, press the Menu button on the control panel or remote control for 15 seconds, then disable the function.

PASSWORD—When Password Protect is enabled, a Password Protect screen requesting you to enter a password will be displayed when the power plug is inserted into the electrical outlet and the power for the projector is first turned on. By default, this function is disabled. You can enable this feature by selecting Enable. If the password has been set before, key in the password first and select the function. This password

security feature will be activated the next time you turn on the projector. If you enable this feature, you will be asked to enter the projector's password after you turn on the projector:

1 First time password input request:

- a** Go to **Menu Settings**, press and then select **Password** to **Enable** the password settings.

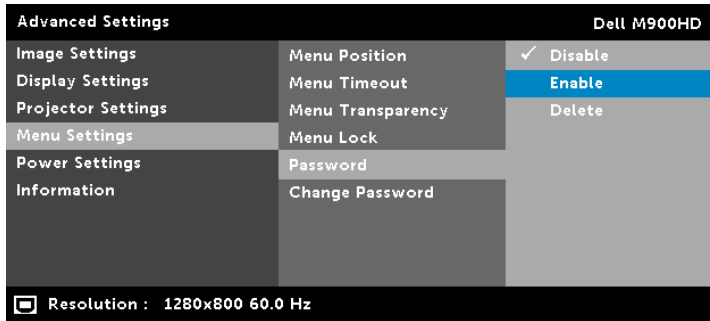

- b** Enabling the Password function will pop up a change screen. Key in a 4-digit number from the screen and press .

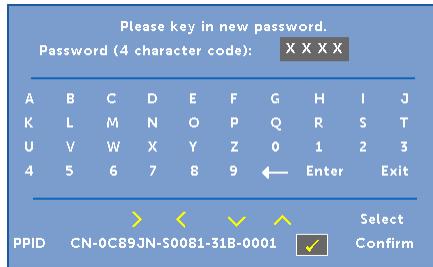

- c** To confirm, enter the password again.

- d** If the password verification is successful, you may resume with accessing the projector's functions and its utilities.

- 2** If you have entered an incorrect password, you will be given two more chances. After three invalid attempts, the projector will automatically turn off.

NOTE: If you forget your password, contact DELL or a qualified service person.

- 3** To disable the password function, select the **Disable** option to close the function.

4 To delete the password, select the **Delete** option.

CHANGE PASSWORD—Key in the original password. Then, enter the new password and confirm the new password again.

Please key in the original password.

Password (4 character code):

| | | | | | | | | | |
|---|---|---|---|---|---|---|-------|------|---|
| A | B | C | D | E | F | G | H | I | J |
| K | L | M | N | O | P | Q | R | S | T |
| U | V | W | X | Y | Z | 0 | 1 | 2 | 3 |
| 4 | 5 | 6 | 7 | 8 | 9 | ← | Enter | Exit | |

PPID CN-0C89JN-50081-31B-0001 Select Confirm

Please key in new password.

Password (4 character code):

| | | | | | | | | | |
|---|---|---|---|---|---|---|-------|------|---|
| A | B | C | D | E | F | G | H | I | J |
| K | L | M | N | O | P | Q | R | S | T |
| U | V | W | X | Y | Z | 0 | 1 | 2 | 3 |
| 4 | 5 | 6 | 7 | 8 | 9 | ← | Enter | Exit | |

PPID CN-0C89JN-50081-31B-0001 Select Confirm

Please key in new password again.

Password (4 character code):

| | | | | | | | | | |
|---|---|---|---|---|---|---|-------|------|---|
| A | B | C | D | E | F | G | H | I | J |
| K | L | M | N | O | P | Q | R | S | T |
| U | V | W | X | Y | Z | 0 | 1 | 2 | 3 |
| 4 | 5 | 6 | 7 | 8 | 9 | ← | Enter | Exit | |

PPID CN-0C89JN-50081-31B-0001 Select Confirm

POWER SETTINGS—Select and press  to activate power settings. The power settings menu provides the following options:

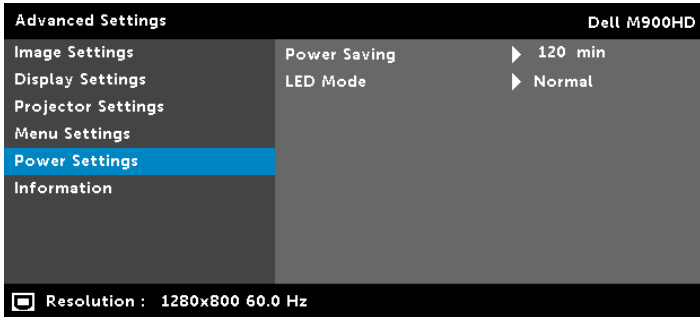

POWER SAVING—By default, the projector is set to enter power saving mode after 120 minutes of no activity. A warning message appears on screen showing a 60 seconds countdown before switching to power saving mode. Press any button during the countdown period to stop the power-saving mode. You can also set a different delay period to enter power saving mode. The delay period is the time you want the projector to wait without an input signal.

If an input signal is not detected during the delay period, the projector turns off. To turn on the projector, press the Power button.

LED MODE—Allows you to select between **Normal** or **ECO** mode. Normal mode operates at full power level. ECO mode operates at a lower power level which may provide longer LED life, quieter operation, and dimmer luminance output on the screen.

INFORMATION—The information menu displays the current M900HD projector settings.

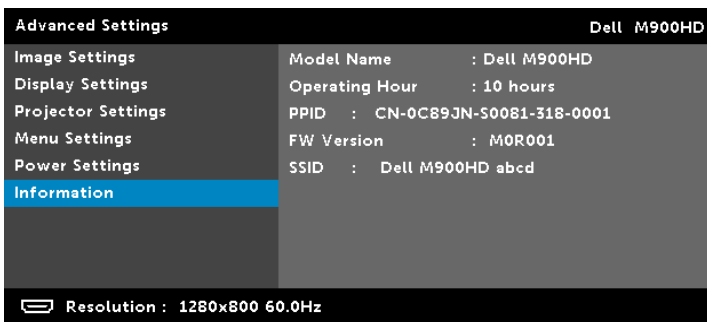

LANGUAGE

Allows you to set the language for the OSD. Press ◀ and ▶ to select different languages and press ✓ to change the language.

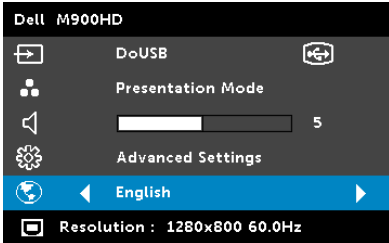

Multimedia Introduction

Multimedia format supported:

Photo Format

| Image Type (Ext Name) | Sub Type | Encode Type | Max Pixels |
|--------------------------|-------------|-------------|-------------|
| GIF | | | 8000 x 8000 |
| PNG | | | 8000 x 8000 |
| BMP | | | 8000 x 8000 |
| JPEG/JPG | Baseline | YUV420 | 8000 x 8000 |
| | | YUV422 | |
| | | YUV440 | |
| | | YUV444 | |
| | progressive | YUV420 | 8000 x 8000 |
| | | YUV422 | |
| | | YUV440 | |
| | | YUV444 | |

Video Format

| File Format | Max. Resolution | MAX Bit Rate (bps) | Max. Display | Audio Format |
|-------------|--------------------|--------------------|--------------|-------------------|
| Motion JPEG | 1920 x 1080, 30fps | 20Mbps | 1080p, 60 Hz | LPCM |
| AVI | 1920 x 1080, 30fps | 20Mbps | 1080p, 60 Hz | MPEG-1 Layer 3 |
| MPEG-4 | 1920 x 1080, 30fps | 20Mbps | 1080p, 60 Hz | |
| MOV | 1920 x 1080, 30fps | 20Mbps | 1080p, 60 Hz | |
| ASF | 1920 x 1080, 30fps | 20Mbps | 1080p, 60 Hz | |
| MKV | 1920 x 1080, 30fps | 20Mbps | 1080p, 60 Hz | |
| WMV | 1920 x 1080, 30fps | 20Mbps | 1080p, 60 Hz | WMA |

Music Format

| Music Type (Ext Name) | Max. Sample Rate (KHz) | Max. Bit Rate (Kbps) |
|-----------------------|------------------------|----------------------|
| LPCM | 48 KHz | 320 Kbps |
| MPEG-1 Layer 3 | 48 KHz | 320 Kbps |
| WMA | 48 KHz | 320 Kbps |
| WAV | 48 KHz | 320 Kbps |
| OGG | 48 KHz | 320 Kbps |

How to set-up File Type for Multimedia with USB

 **NOTE:** A USB flash disk must be plugged into the projector if you want to use the multimedia USB function.

Follow these steps to playback the Photo, Video, or Music files on your projector:

- 1 Connect the power cable and turn on the projector by pressing the power button.

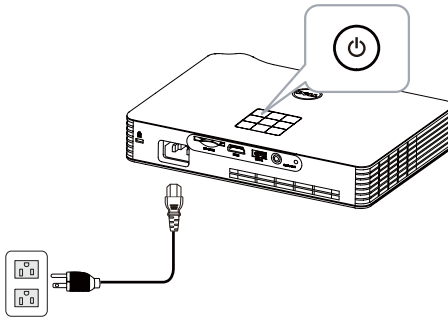

- 2 Plug in a **USB flash disk** to your projector.

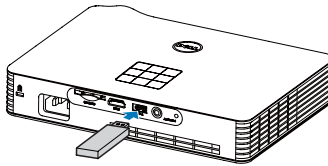

- 3 Access the **Input Source** menu, select the **USB** option, and press the  button.

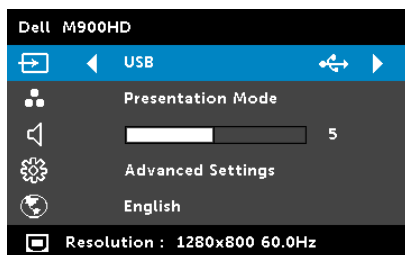

The **USB Screen** shown below appears:

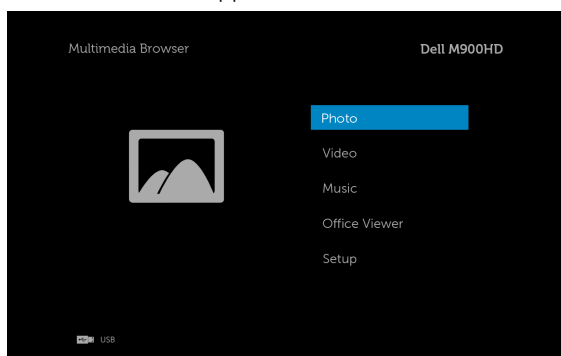

- 4 Select the multimedia files: **Photo**, **Video**, **Music**, or **Office Viewer**, and then press the  to start playing. Or select the **Setup** option to change multimedia settings. See "Multimedia Setup" on page 43.

How to set-up File Type for Multimedia with SD Card

 **NOTE:** A SD card must be plugged into the projector if you want to use the multimedia SD function.

Follow these steps to playback the Photo, Video, or Music files on your projector:

- 1 Connect the power cable and turn on the projector by pressing the power button.

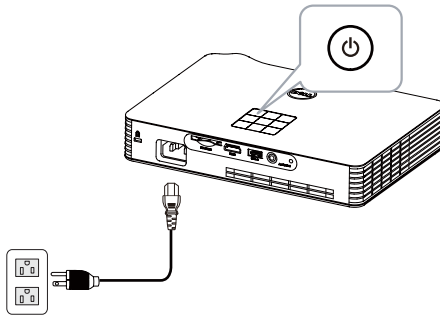

- 2 Plug in a **SD card** to your projector. The image input source will be automatically switched to SD screen when you plug in a SD card.

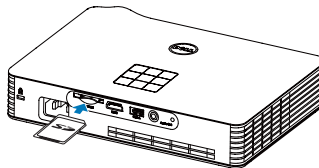

- 3 Access the **Input Source** menu, select the **SD** option and press the  button.

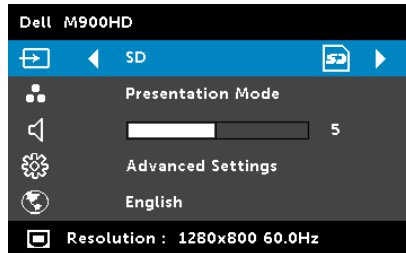

The **SD Screen** shown below appears:

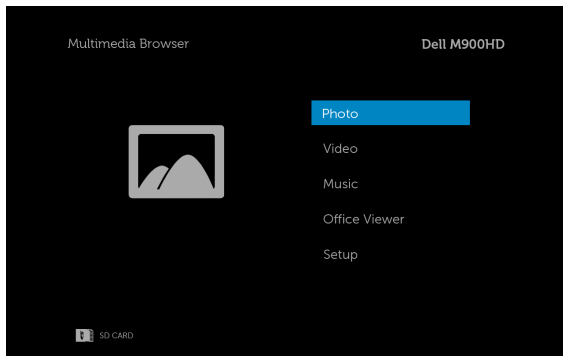

- 4 Select the multimedia files: **Photo**, **Video**, **Music**, or **Office Viewer**, and then press the  to start playing. Or select the **Setup** option to change multimedia settings. See "Multimedia Setup" on page 43.

How to set-up File Type for Multimedia with Internal Memory

Follow these steps to playback the Photo, Video, or Music files on your projector:

- 1 Connect the power cable and turn on the projector by pressing the power button.

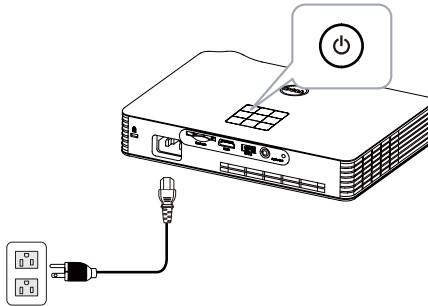

- 2 Access the **Input Source** menu, select the **Internal Memory** option and press the button.

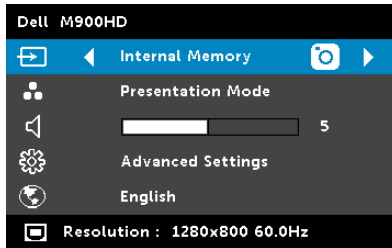

The **Internal Memory Screen** shown below appears:

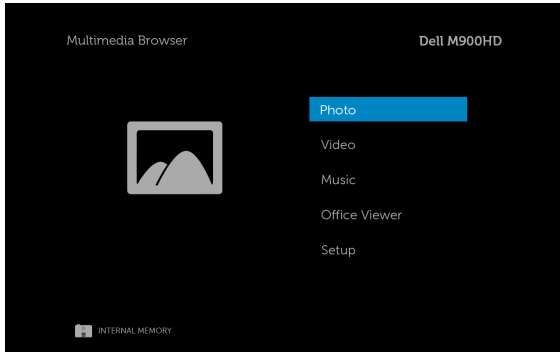

- 3 Select the multimedia files: **Photo**, **Video**, **Music**, or **Office Viewer**, and then press the  to start playing. Or select the **Setup** option to change multimedia settings. See "Multimedia Setup" on page 43.





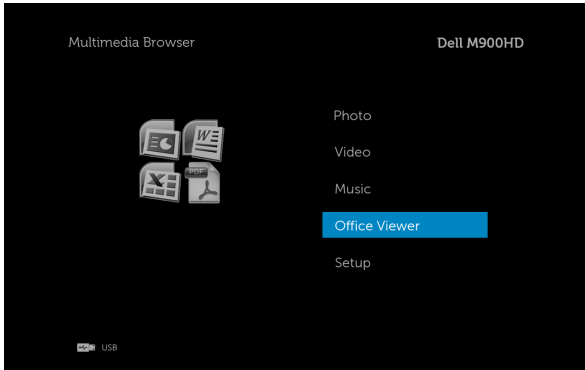

Office Viewer for the USB, SD, and Internal Memory

The Office Viewer feature allows you to use MS Excel, MS Word, MS PowerPoint, and PDF files.



Buttons Introduction

Use the up, down, left, and right buttons for navigation and  button on your projector's control panel or remote control to select.

| Button | Up  | Down  | Left  | Right  | Enter  | Menu  |
|--------|--|--|--|---|---|--|
| | No function | No function | Previous page | Next page | No function | Back to previous menu |

Multimedia SETUP for USB, SD Card, and Internal Memory

The multimedia setup menu allows you to change settings for Photo, Video, and Music.



NOTE: Multimedia setup menu and set are the same for the USB, SD card, and Internal Memory.

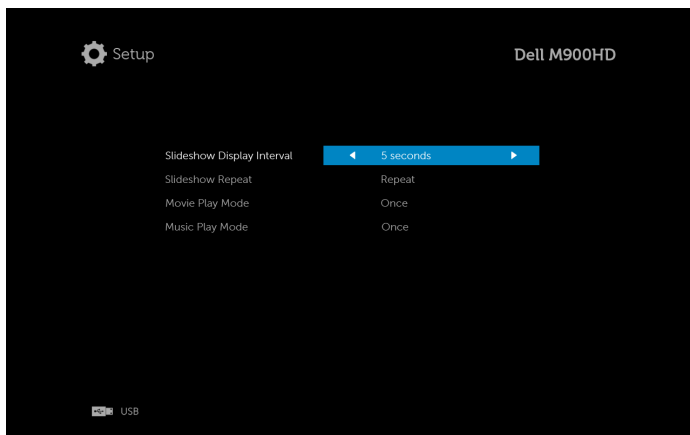

SLIDESHOW DISPLAY INTERVAL—Press ⏪ or ⏩ to select slideshow display interval. The image will automatically switch to the next photo after the time out. Options are: **5 seconds**, **10 seconds**, **30 seconds**, and **1 minute**.

SLIDESHOW REPEAT—Press ⏪ or ⏩ to select slideshow repeat as **Repeat** or **No Repeat**.

MOVIE PLAY MODE—Press ⏪ or ⏩ to select movie play mode. Options are: **Once**, **Loop one**, **Loop all**, and **Shuffle**.

MUSIC PLAY MODE—Press ⏪ or ⏩ to select movie play mode. Options are: **Once**, **Loop one**, **Loop all**, and **Shuffle**.

Intel® Wireless Display (WiDi) Installation



NOTE: Your computer must have the following Intel® Wireless Display system requirements:

| System Component | Requirement |
|------------------|---|
| Processor | <p>ONE of the following mobile processors:</p> <p>3rd generation Intel® Core™ Processor: all mobile processors</p> <p>3rd Generation Intel® Core™ i7 Processor: 640M; 660LM; 640LM; 620LM; 620M; 610E; 690UM; 680UM; 660UM; 640UM; 620UM; 660UE; 3610QM; 3770T; 3820QM; 3840QM; 2710QE; 2820QM; 2720QM; 2635QM; 2630QM; 2657M; 2649M; 2629M; 2620M; 2617M; 2540M; 2520M; 2510E; 2640LM; 2620LM; 2630UM; 2610UM; 2530UM; 2920XM</p> <p>3rd Generation Intel® Core™ i5 Processors: 580M; 560M; 540M; 520M; 480M; 460M; 450M; 430M; 580UM; 560UM; 540UM; 520UM; 470UM; 430UM; 2540M; 2520M; 2410M; 2537M; 2430M; 2435M, 2450M; 2467M</p> <p>3rd Generation Intel® Core™ i3 Processors: 390M; 380M; 370M; 350M; 330M; 330E; 3110M; 3120M; 3240; 3240T; 3217U; 3225; 3229Y; 3220; 3220T; 2310E; 2310M; 2312M; 2328M; 2330E; 2330M; 2340UE; 2348M; 2350M; 2357M; 2365M; 2367M; 2370M; 2377M</p> |
| Graphics | Intel® HD Graphics |
| Wireless | <p>ONE of the following:</p> <p>Intel® Centrino® Wireless-N 1000, 1030, 2200, or 2230</p> <p>Intel® Centrino® Wireless-N 2200 for Desktop</p> <p>Intel® Centrino® Advanced-N 6200, 6205, 6230, or 6235</p> <p>Intel® Centrino® Advanced-N 6205 for Desktop</p> <p>Intel® Centrino® Wireless-N + WiMAX 6150</p> <p>Intel® Centrino® Advanced-N + WiMAX 6250</p> <p>Intel® Centrino® Ultimate-N 6300</p> |

| System Component | Requirement |
|------------------|---|
| Software | Intel® My Wi-Fi Technology (Intel® MWT) and Intel® Wireless Display must be pre-installed and enabled. |
| Operating System | Windows 7 (64-bit), Home Premium, Ultimate or Professional Windows 7 (32-bit), Home Premium, Ultimate, Professional or Basic Windows 8 32-bit and 64-bit editions |

For more information, see the Intel® WiDi website at www.intel.com/go/widi.

Enable Intel® WiDi on the Projector

- 1 Connect the power cable and press the power button.

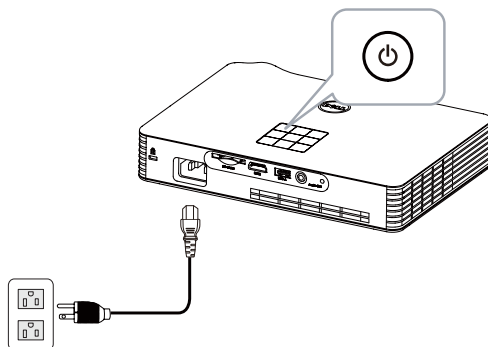

- 2 Press the **Menu** button on your projector control panel or remote control.

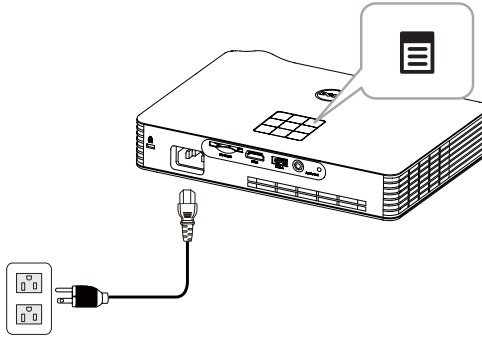

NOTE: Use , ,  and  buttons to navigate and  to select.

- 3 Select the input source as **Intel® WiDi**.

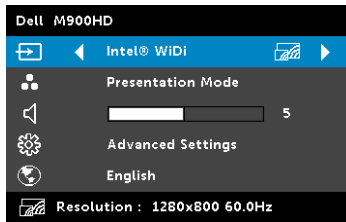

The **Intel® WiDi Guide Screen** shown below appears:

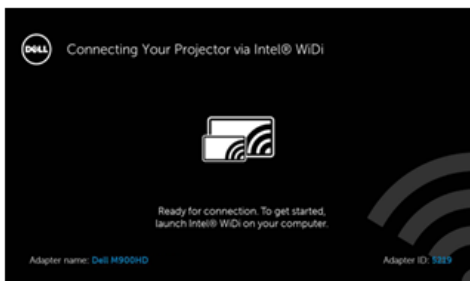

- 4 Take note of the **ADAPTER NAME** and **PIN CODE**. You will need this information to log in later.

Launch the Intel® WiDi on Your Computer

- 5 Type WiDi in your Windows search bar. If your computer has built-in Intel® WiDi, you will see the “Intel® WiDi” application in your search results.
- 6 Connect your computer to Dell M900HD.

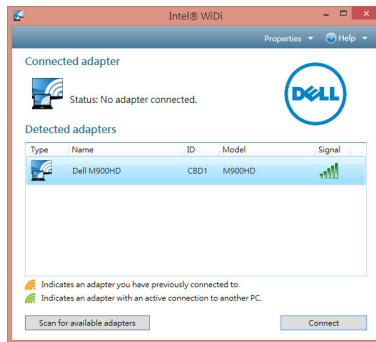

Login

Login with the PIN Code provided in Step 4 of Intel® Wireless Display (WiDi) Installation, then click OK.

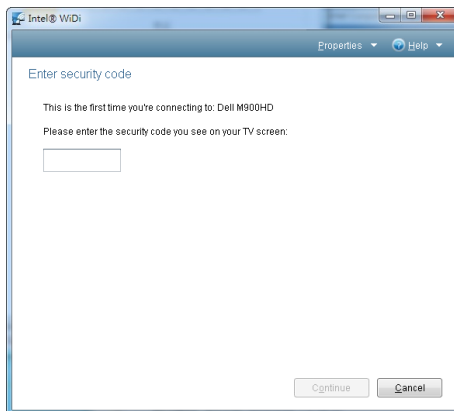

Wi-Fi Display Installation



NOTE: Your computer must have the following minimum system requirements:

Operating System:

- Windows
Microsoft Windows XP Home or Professional Service pack 2 (32-bit recommended), Windows Vista 32-bit, and Windows 7 Home or Professional 32-bit or 64-bit, Windows 8 32-bit or 64-bit
- MAC
MacBook and above, MacOS 10.5~10.8

Minimum Hardware:

- a** Intel Dual Core 1.8 MHz or higher
- b** 256 MB of RAM required, 512 MB or more recommended
- c** 10 MB of available hard-disk space
- d** nVIDIA or ATI graphic card with 64 MB VRAM or above
- e** Ethernet adapter (10 / 100 bps) for an Ethernet connection
- f** A supported WLAN adapter for a WLAN connection (any NDIS-compliant 802.11b or 802.11g or 802.11n Wi-Fi device)

Web browser

Microsoft Internet Explorer 6.0 or 7.0 (recommended) or 8.0, Firefox 2.0, Safari 3.0, and above

Enable Wi-Fi on the Projector

- 1 Connect the power cable and press the power button.

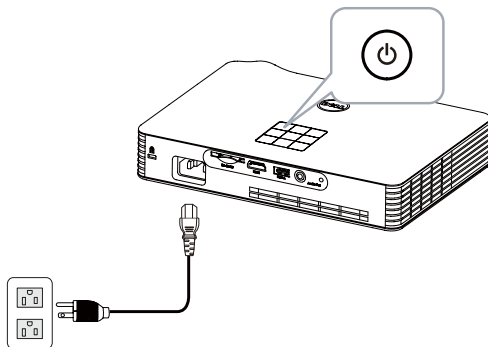

- 2 Press the **Menu** button on your projector control panel or remote control.

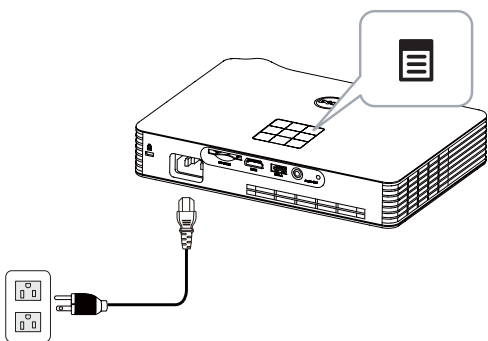

 **NOTE:** Use , ,  and  buttons to navigate and  to select.

- 3 Select the input source as **Wi-Fi**.

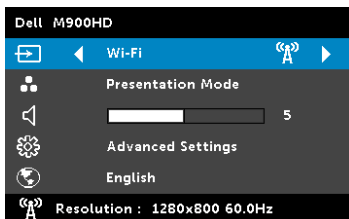

The **Wireless Guide Screen** shown below appears:

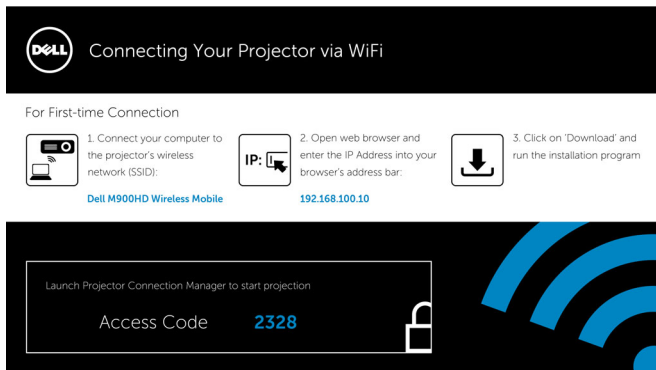

- 4 Take note of the **Wireless Network (SSID)**, **IP Address**, and **Access Code**. You will need this information to log in later.

Install the Dell Projector Connection Manager on Your Computer

- 5 Connect your computer to the M900HD wireless network.

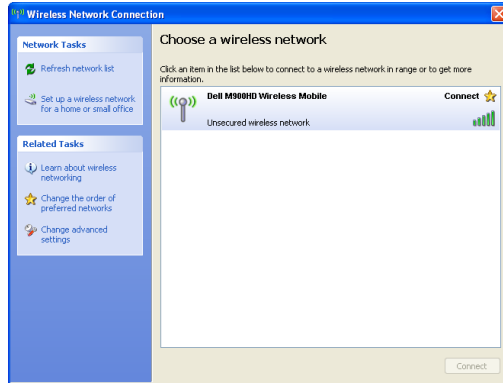

NOTE:

- Your computer must have wireless network function to detect the connection.
- When you connect to the M900HD wireless network, you will lose wireless connectivity with other wireless networks.



NOTE: Remember to turn off all proxies. (In Microsoft® Windows Vista: Click **Control Panel** → **Internet Options** → **Connections** → **LAN Settings**)

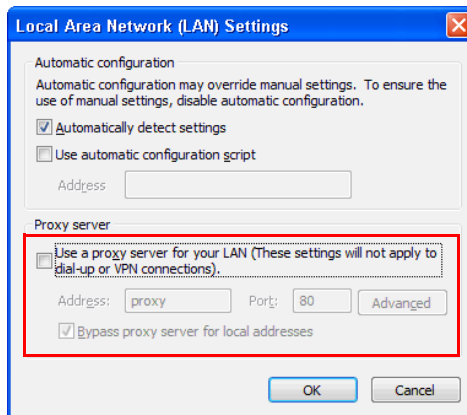

- 6 Open your Internet browser. You will be automatically directed to the **M900HD Web Management** web page.



NOTE: If the web page does not load automatically, enter the IP address (default IP address is 192.168.100.10) noted from the projector's screen in the browser's address bar.

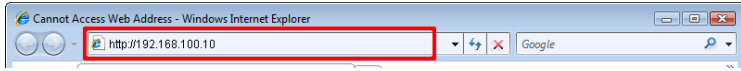

- 7 The M900HD Web Management page opens. For first time use, click **Download**.

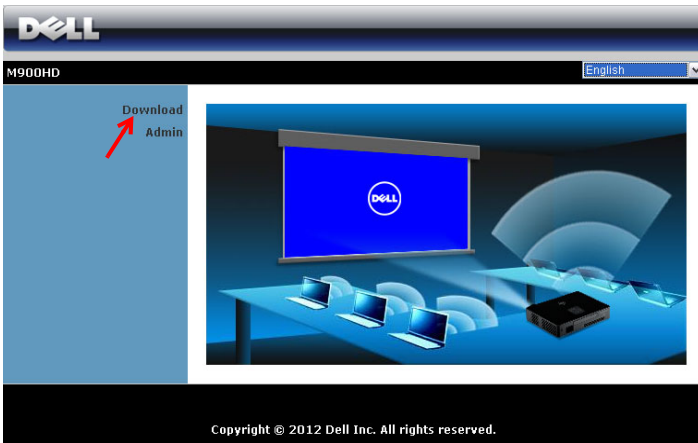

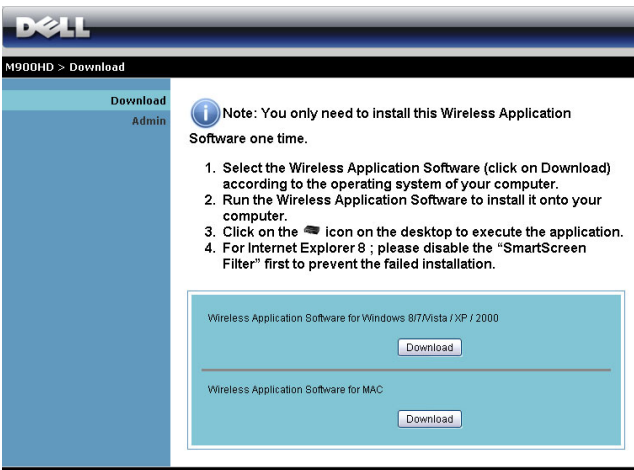

- 8 Select the appropriate operating system, then click **Download**.

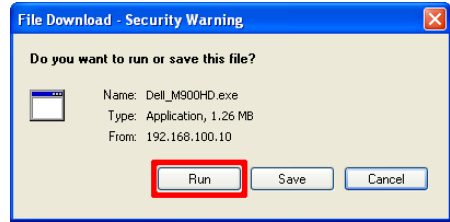

- 9 Click **Run** to proceed with the one-time installation of the software.

 **NOTE:** You may choose to save the file and install it at a later time. To do this, click Save.



 **NOTE:** If you are unable to install the application because of inadequate rights on the computer, please contact your network administrator.

- 10 The installation software will launch. Follow the on-screen instructions to complete setup.



Launch the Dell Projector Connection Manager

Once the installation is complete, the program will launch and search automatically. If the program does not launch automatically, you can double-click the  icon on the desktop to start the application. Select the **Dell M900HD Wireless Mobile**, and then click **OK**.



Login



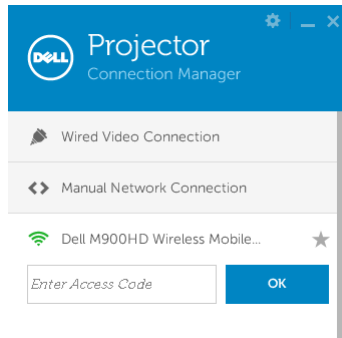



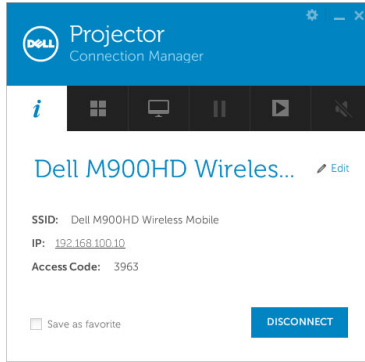

Login with the **Access Code** provided in Step 4 of Wi-Fi Display Installation, then click **OK**.



Understanding the Buttons

After a successful log in, the following screen appears:



| Item | Description | |
|---|-------------------------|---|
| 1 | Status Bar | |
|  | Settings | Click to activate the application settings. |
|  | Minimize button | Click to minimize the application. |
|  | Close button | Click to exit the application. |
| 2 | Controls Toolbar | |
|  | Information | Click to display SSID, IP, and Access Code information. |
|  | Share mode | Click to activate the share mode. |
|  | Display mode | Click to change the display mode. |
|  | Pause | Click to pause projection. |
|  | Play | Click to project the image in full screen. |
|  | Sound | Click to enable the sound. |

Using the Settings

Click  to display the settings menu.

RESOLUTION—Allows you to setup the resolution.

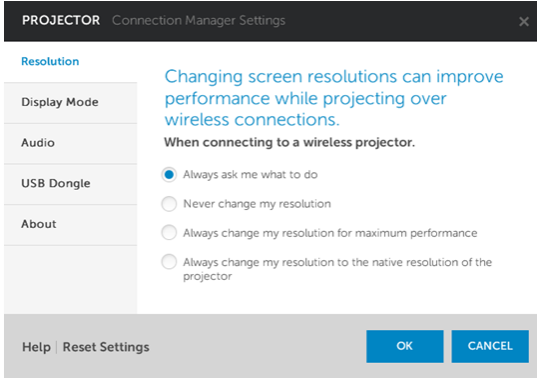

DISPLAY MODE—Allows you to setup the default projection mode.

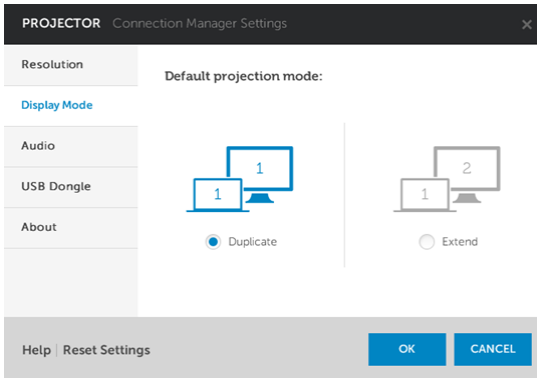

AUDIO—Allows you to change the audio settings.

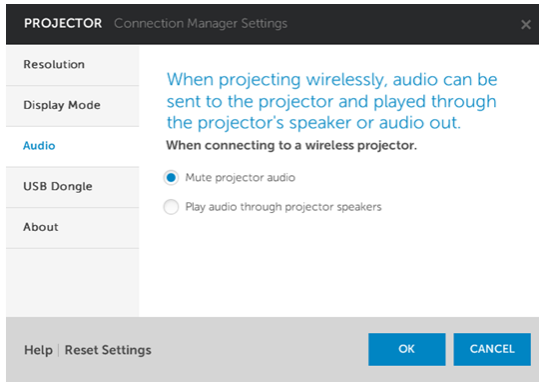

USB DONGLE—Allows you to create USB dongle. See "Make Application Token" on page 70.

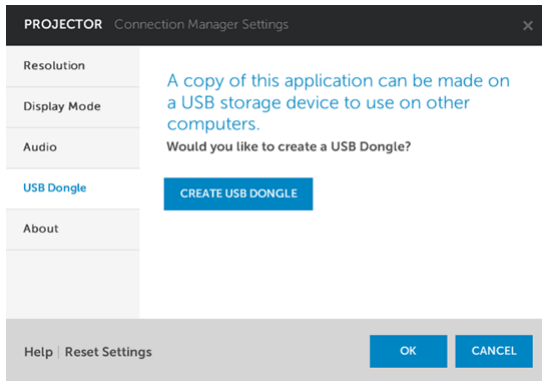

ABOUT—Displays the application version.

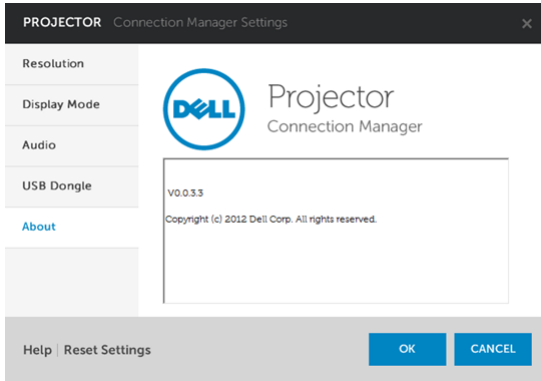

Managing the Projector From Web Management

Configuring the Network Setting

If the projector is connected to a network, you can access the projector using a web browser.

Accessing Web Management

Use Internet Explorer 6.0 and above or Firefox 2.0 and above and enter the IP address. You can now access Web Management and manage the projector from a remote location.

Home Page



- Access the Web Management Home page by entering the projector's IP address at the web browser (default IP address is 192.168.100.10).
- Select the language for web management from the list.
- Click any menu item on the left tab to access the page.

Download the Dell Projector Connection Manager

See also "Wi-Fi Display Installation" on page 48.

DELL

M900HD > Download

Download
Admin

Note: You only need to install this Wireless Application Software one time.

1. Select the Wireless Application Software (click on Download) according to the operating system of your computer.
2. Run the Wireless Application Software to install it onto your computer.
3. Click on the  icon on the desktop to execute the application.
4. For Internet Explorer 8; please disable the "SmartScreen Filter" first to prevent the failed installation.

Wireless Application Software for Windows 8/7/Vista /XP /2000

Download

Wireless Application Software for MAC

Download

Click the **Download** button of the corresponding operating system of your computer.

Managing Properties

Admin

M900HD > Admin

Download
Admin

| | | |
|----------------|--------------------------|-------|
| Admin Password | <input type="text"/> | Login |
| PPID | CN-0C89JN-S0081-31B-0001 | |

Copyright © 2012 Dell Inc. All rights reserved.

An administrator password is required to access the Admin page.

- **Admin Password:** Enter the administrator password and then click **Login**. The default password is "admin". To change the password, see "Change Passwords" on page 66.

System Status

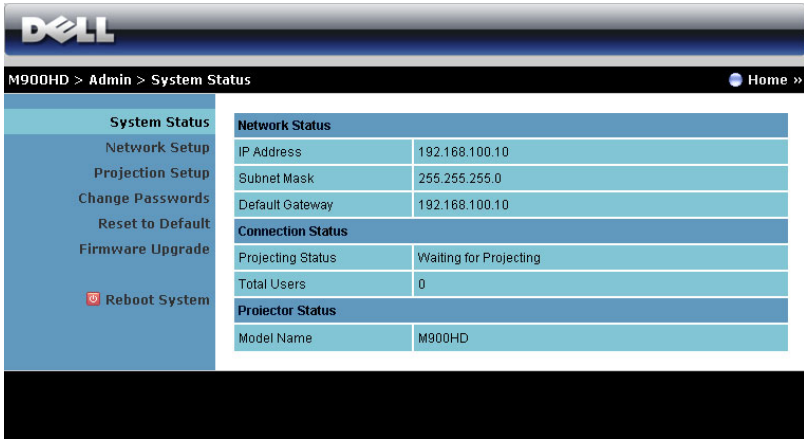

System Status

M900HD > Admin > System Status Home »

| | | |
|---|--------------------------|------------------------|
| System Status | Network Status | |
| Network Setup | IP Address | 192.168.100.10 |
| Projection Setup | Subnet Mask | 255.255.255.0 |
| Change Passwords | Default Gateway | 192.168.100.10 |
| Reset to Default | Connection Status | |
| Firmware Upgrade | Projecting Status | Waiting for Projecting |
|  Reboot System | Total Users | 0 |
| | Projector Status | |
| | Model Name | M900HD |

Displays the **Network Status**, **Connection Status**, and **Projector Status** information.

Network Status

| System Status | |
|----------------------|--|
| Network Setup | |
| Projection Setup | |
| Change Passwords | |
| Reset to Default | |
| Firmware Upgrade | |
| Reboot System | |

| IP Setup | <input checked="" type="radio"/> Obtain an IP address automatically <input type="radio"/> Use the following IP address |
|-----------------|--|
| IP Address | 192 . 168 . 100 . 10 |
| Subnet Mask | 255 . 255 . 255 . 0 |
| Default Gateway | 192 . 168 . 100 . 10 |
| DNS Server | 192 . 168 . 100 . 10 |

| DHCP Server Setup | <input checked="" type="radio"/> Auto <input type="radio"/> Disable |
|-------------------|---|
| Start IP | 192 . 168 . 100 . 11 |
| End IP | 192 . 168 . 100 . 254 |
| Subnet Mask | 255 . 255 . 255 . 0 |
| Default Gateway | 192 . 168 . 100 . 10 |
| DNS Server | 192 . 168 . 100 . 10 |

| Wireless Setup | <input checked="" type="radio"/> Enable <input type="radio"/> Disable |
|----------------|---|
| Region | --- WORLDWIDE --- |
| SSID | DELL M900HD WIRELESS |
| SSID Broadcast | <input checked="" type="radio"/> Enable <input type="radio"/> Disable |
| Frequency Band | <input checked="" type="radio"/> 2.4 GHz <input type="radio"/> 5 GHz |
| Channel | Auto |
| Encryption | Disable |
| Key | |

Apply Cancel

IP Setup

- Choose **Obtain an IP address automatically** to assign an IP address to the projector automatically, or **Use the following IP address** to assign an IP address manually.

DHCP Server Setup

- Choose Auto to automatically set up the **Start IP, End IP, Subnet Mask, Default Gateway, and DNS Server** address from a DHCP server, or **Disable** to disable this function.

Wireless Setup

- Choose **Enable** to set up the **Region, SSID, SSID Broadcast, Frequency Band, Channel, Encryption, and Key**. Choose **Disable** to disable the wireless set up.

SSID: Up to maximum length of 32 characters.

Encryption: You can **Disable** WPA key or select one of 64-bit or 128-bit in ASCII or HEX string.

Key: If Encryption is enabled, you have to set key value according to the Encryption mode you selected.

Click the **Apply** button to save and apply changes. The projector must be restarted for the changes to take effect.

Projection Setup

M900HD > Admin > Projection Setup Home >>

Projection Setup

System Status
Network Setup
Projection Setup
Change Passwords
Reset to Default
Firmware Upgrade
Reboot System

Projection Setup

Login Code

Disable
 Random
 Use the following code

Apply Cancel

Projection Setup

Login Code: Select how you want the login code to be generated by the projector. There are three options:

- **Disable:** Login code will not be required when logging in to the system.
- **Random:** Default is **Random**. Login code will be randomly generated.
- **Use the following code:** Enter a 4-digit code. This code will be used to log in to the system.

Click the **Apply** button to save and apply changes. The projector must be restarted for the changes to take effect.

Change Passwords

The screenshot shows the Dell M900HD Admin interface. At the top, the Dell logo is on the left, and the breadcrumb path 'M900HD > Admin > Change Passwords' is in the center. On the right, there is a 'Home' link with a double arrow. A left-hand navigation menu is visible, with 'Change Passwords' highlighted in light blue. Other menu items include System Status, Network Setup, Projection Setup, Reset to Default, Firmware Upgrade, and Reboot System. The main content area is titled 'Admin' and contains a form with two input fields: 'Enter New Password' and 'Confirm New Password'. An 'Apply' button is located to the right of the second field.

This page allows you to change the administrator password.

- **Enter New Password:** Enter the new password.
- **Confirm New Password:** Enter the password again and click **Apply**.



NOTE: Contact Dell if you forget your administrator password.

Reset to Default

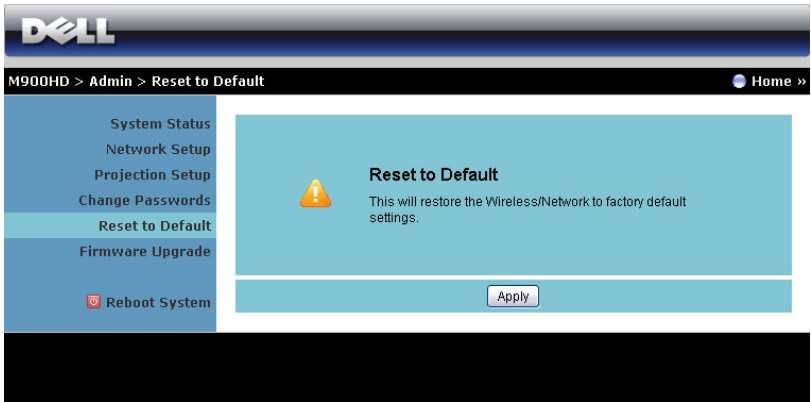

The screenshot shows the Dell M900HD Admin interface. At the top, there is a Dell logo and a navigation bar with the text "M900HD > Admin > Reset to Default" and a "Home" link. On the left side, there is a vertical menu with the following items: "System Status", "Network Setup", "Projection Setup", "Change Passwords", "Reset to Default" (which is highlighted), "Firmware Upgrade", and "Reboot System". The main content area is light blue and contains a yellow warning icon with an exclamation mark. To the right of the icon, the text reads "Reset to Default" followed by "This will restore the Wireless/Network to factory default settings." At the bottom of this content area, there is a button labeled "Apply".

Click the **Apply** button to restore the wireless/network setup to its factory default settings.

Firmware Upgrade

Use the Firmware Upgrade page to update your projector's Wi-Fi and Intel® WiDi firmware.

M900HD > Admin > Firmware Upgrade Home »

| | | |
|---|--|---|
| System Status Network Setup Projection Setup Change Passwords Reset to Default Firmware Upgrade Reboot System | Wireless Firmware Version | W12 |
| | Release Date | 20130122 |
| | Firmware update will take few minutes. Do not interrupt the process once it has begun. The wireless system will auto reboot after update is complete. Select a file (*.awd) to update: | |
| | File Name | <input type="text"/> <input type="button" value="Browse..."/> |
| | | <input type="button" value="Update"/> |

To start firmware update, follow these steps:

- 1 You can download the firmware files from dell.com/support.
- 2 Press **Browse** to select the file to update.
- 3 Click the **Update** button to start. Wait while the system updates the firmware in your device.

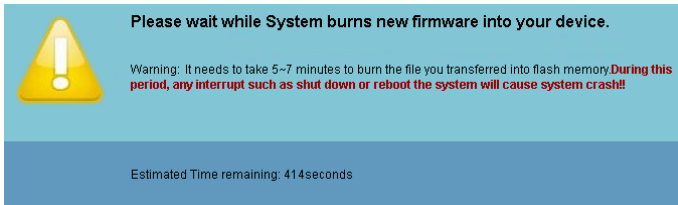

CAUTION: Do not interrupt the update process as this may cause the system to crash!

- 4 Click **OK** when the update is complete.

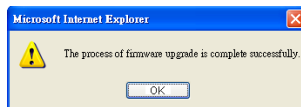

Reboot System

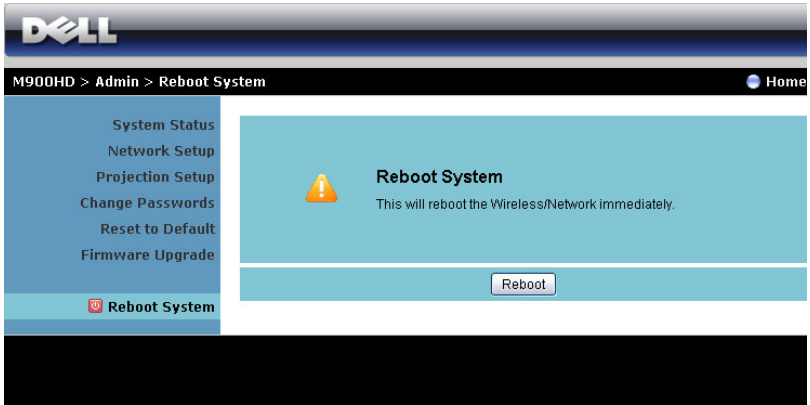

The screenshot shows the Dell M900HD Admin interface. At the top, the Dell logo is displayed. Below it, the breadcrumb navigation reads "M900HD > Admin > Reboot System" and a "Home" link is visible. A left-hand navigation menu lists several options: "System Status", "Network Setup", "Projection Setup", "Change Passwords", "Reset to Default", and "Firmware Upgrade". The "Reboot System" option is highlighted in red. The main content area features a light blue background with a yellow warning icon (a triangle with an exclamation mark) and the heading "Reboot System". Below the heading, a message states: "This will reboot the Wireless/Network immediately." At the bottom of this section, there is a button labeled "Reboot".

Click **Reboot** to reboot the system.

Make Application Token

The Application Token lets you perform Plug and Show using a USB token.

- 1 From the application software, click  > **USB Dongle**.
- 2 The following screen appears. Click **Next**.



- 3 Plug a flash drive into any of the USB ports on your computer. Select the drive from the list, then click **Next**.

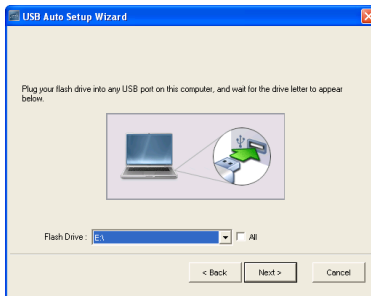

- 4 Click **Finish** to close the wizard.



4 Troubleshooting Your Projector



If you experience problems with your projector, see the following troubleshooting tips. If the problem persists, contact Dell (see Contacting Dell™ on page 79).



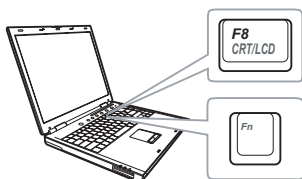

Problem

No image appears on the screen



Possible Solution

- Ensure that the projector is turned on.
- Ensure that you have chosen the correct input source on the INPUT SOURCE menu.
- Ensure the external graphics port is enabled. If you are using a Dell laptop computer, press   (Fn+F8). For other computers, see your respective documentation. If images are not displayed properly, please upgrade the video driver of your computer. For Dell computers, see support.dell.com.
- Ensure that all the cables are securely connected. See "Connecting Your Projector" on page 7.
- Ensure that the pins of the connectors are not bent or broken.
- Use **Test Pattern** in the **Projector Settings of the Advanced Settings** menu. Ensure that the colors of the test pattern are correct.

| Problem (continued) | Possible Solution (continued) |
|--|--|
| Partial, scrolling, or incorrectly displayed image | <p>If you are using a Dell™ portable computer, set the resolution of the computer to WXGA (1280 x 800):</p> <ul style="list-style-type: none"> a Right-click the unused portion of your Microsoft® Windows® desktop, click Properties, and then select Settings tab. b Verify that the setting is 1280 x 800 pixels for the external monitor port. c Press   (Fn+F8). <p>If you experience difficulty in changing resolutions, or if your monitor freezes, restart all the equipment and the projector.</p> <p>If you are not using a Dell™ portable computer, see your documentation. If images are not displayed properly, please upgrade the video driver of your computer. For a Dell computer, see dell.com/support.</p> |
| The screen does not display your presentation | <p>If you are using a portable computer, press   (Fn+F8).</p> |
| Image is unstable or flickering | <p>Adjust the tracking in the OSD Display Settings of the Advanced Settings menu (in PC Mode only).</p> |
| Image has vertical flickering bar | <p>Adjust the frequency in the OSD Display Settings of the Advanced Settings menu (in PC Mode only).</p> |
| Image color is incorrect | <p>Use Test Pattern in the Projector Settings of the Advanced Settings menu. Ensure that the colors of the test pattern are correct.</p> |
| Image is out of focus | <ol style="list-style-type: none"> 1 Adjust the focus ring on the projector lens. 2 Ensure that the projection screen is within the required distance from the projector (2.98 ft [91 cm] to 7.87 ft [240 cm]). |

| Problem (continued) | Possible Solution (continued) |
|---|--|
| Image is reversed | Select Projector Settings of the Advanced Settings from the OSD and adjust the projector mode. |
| Error LED is blinking amber | A projector fan has failed and the projector will automatically shut down. |
| TEMP LED is solid amber | The projector has overheated. The display automatically shuts down. Turn the display on again after the projector cools down. If the problem persists, contact Dell. |
| TEMP LED is blinking amber | If the projector fan fails, the projector will automatically shut down. Clear the projector mode by pressing and holding the POWER button for 10 seconds. Please wait for about 5 minutes and try to power up again. If the problem persists, contact Dell. |
| The OSD does not appear on the screen | Press the Menu button on the panel for 15 seconds to unlock the OSD. Check the Menu Lock on page 30. |
| The remote control is not operating smoothly or works only within a limited range | The battery may be low. Check if the LED indication from the remote is too dim. If so, replace with a new CR2025 battery. |
| DoUSB not displaying | Display over USB Should run automatically. To manually run USB display, go to My Computer and run "USB_Display.exe".  NOTE: You may require administrator level access to install the driver. Contact your network administrator for support. |

Guiding Signals

| Projector Status | Description | Control Buttons | | Indicator |
|--------------------------|--|---------------------|----------------|---|
| | | Power (White/Amber) | TEMP (Amber) |  (Amber) |
| Standby mode | Projector in Standby mode. Ready to power on. | White Flashing | OFF | OFF |
| LED on | Projector in Normal mode, ready to display an image. | White | OFF | OFF |
| Cooling mode | Projector is cooling to shutdown. | White | OFF | OFF |
| Projector overheated | Air vents might be blocked or ambient temperature may be above 35 °C. The projector automatically shuts down. Ensure that the air vents are not blocked and that the ambient temperature is within operational range. If the problem persists, contact Dell. | OFF | AMBER | OFF |
| Fan breakdown | One of the fans has failed. The projector automatically shuts down. If the problem persists, contact Dell. | OFF | AMBER Flashing | OFF |
| LED failure | LED defective. | OFF | OFF | AMBER |
| R-LED driver over-heated | Air vents might be blocked or the R-LED driver has overheated. The projector will automatically shut down. Turn the display on again after the projector cools down. If the problem persists, contact Dell. | AMBER | AMBER | OFF |

5

Specifications

| | |
|------------------------|---|
| Light Valve | 0.45" WXGA S450 DMD, DarkChip3™ |
| Brightness | 900 ANSI Lumens (Max.) |
| Contrast Ratio | Max: 10000:1 APM Native: 700:1 Typical (Full On/Full Off) |
| Uniformity | 85% Typical (Japan Standard - JBMA) |
| Number of Pixels | 1280 x 800 (WXGA) |
| Aspect Ratio | 16:10 |
| Internal Flash | 2 GB Memory (Max.) |
| Displayable Color | 1.07 billion colors |
| Projection Lens | Fixed Focal Lens, F/1.5 Throw ratio =1.4 wide and tele Offset ratio: 105% ± 5% |
| Projection Screen Size | 30~80 inches (diagonal) |
| Projection Distance | 2.98~7.87 ft (91 cm ~ 240 cm) |
| Video Compatibility | HDMI input: 1080p, 720p, 576i/p, 480i/p |
| Power Supply | Universal AC 100-240 V 50/60 Hz with PFC input |
| Power Consumption | Normal mode: 142 W ± 10% @ 110 Vac Eco mode: 106 W ± 10% @ 110 Vac Power saving mode: < 0.5 W (Fan speed at minimum) Standby mode: < 0.5 W |
| Audio | 1 speaker x 3 watt RMS |
| Noise Level | Full-on mode: Typical: 36 dB(A), Maximum: 38 dB(A) Eco mode: Typical: 34 dB(A), Maximum: 36 dB(A) |
| Weight | 3.5 lbs (1.59 Kg) |

Dimensions (W x H x D) 9.13 x 1.69 x 6.46 inches (232 x 43 x 164 mm)

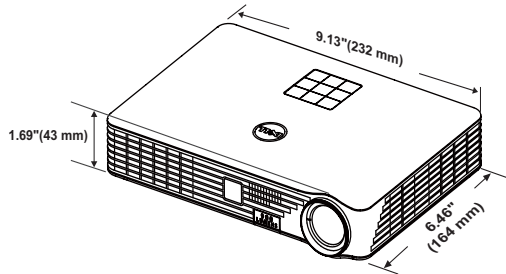

Environmental

Operating temperature: 5 °C - 35 °C
(41 °F- 95 °F)
Humidity: 80% maximum
Storage temperature: 0 °C to 60 °C
(32 °F to 140 °F)
Humidity: 90% maximum
Shipping temperature: -20 °C to 60 °C
(-4 °F to 140 °F)
Humidity: 90% maximum

I/O Connectors

Power: One AC power socket (3-pin - C14 inlet)

HDMI input: One HDMI connector for supporting HDMI 1.3. HDCP compliant.

Audio output: One 3.5 mm stereo mini phone jack.

USB (type A) port: One USB connector for supporting USB display, multimedia playback (Video/Music/Photo/Office Viewer), USB memory storage access (USB flash drive/internal memory), and projector firmware upgrade.

The USB thumb drive can support up to 32 GB.

SD card slot: One SD connector for supporting multimedia playback (Video/Music/Photo/Office Viewer).

The SD card can support up to 32 GB.

| | |
|--------------|---|
| Wireless | Wireless Standard: IEEE 802.11a/b/g/n (2T2R) OS environment: Windows 8/7/Vista/XP/2000, MAC OS X Supports MobiShow and WiFi-Doc projection. |
| Light Source | Mercury-free LED (up to 20000 hours in Normal mode) |



NOTE: The LED life rating for any projector is a measure of brightness degradation only, and is not a specification for the time it takes a LED to fail and cease light output. LED life is defined as the time it takes for more than 50 percent of a LED sample population to have brightness decrease by approximately 50 percent of the rated lumens for the specified LED. The LED life rating is not guaranteed in any way. The actual operating life span of a projector LED will vary according to operating conditions and usage patterns. Usage of a projector in stressful conditions which may include dusty environments, under high temperatures, many hours per day, and abrupt powering-off will most likely result in a LED's shortened operating life span or possible LED failure.

Compatibility Modes (Digital)

| Resolution | Refresh Rate (Hz) | Hsync Frequency (KHz) | Pixel Clock (MHz) |
|-----------------|-------------------|-----------------------|-------------------|
| 640 x 350 | 70.087 | 31.469 | 25.175 |
| 640 x 480 | 59.940 | 31.469 | 25.175 |
| 720 x 480 p60 | 59.940 | 31.469 | 27.000 |
| 720 x 576 p50 | 50.000 | 31.250 | 27.000 |
| 720 x 400 | 70.087 | 31.469 | 28.322 |
| 640 x 480 | 75.000 | 37.500 | 31.500 |
| 640 x 480 | 85.008 | 43.269 | 36.000 |
| 800 x 600 | 60.317 | 37.879 | 40.000 |
| 800 x 600 | 75.000 | 46.875 | 49.500 |
| 800 x 600 | 85.061 | 53.674 | 56.250 |
| 1024 x 768 | 60.004 | 48.363 | 65.000 |
| 1280 x 720 p50 | 50.000 | 37.500 | 74.250 |
| 1280 x 720 p60 | 60.000 | 45.000 | 74.250 |
| 1920 x 1080 i50 | 50.000 | 28.125 | 74.250 |
| 1920 x 1080 i60 | 60.000 | 33.750 | 74.250 |
| 1280 x 720 | 59.855 | 44.772 | 74.500 |
| 1024 x 768 | 75.029 | 60.023 | 78.750 |
| 1280 x 800 | 59.810 | 49.702 | 83.500 |
| 1366 x 768 | 59.790 | 47.712 | 85.500 |
| 1360 x 768 | 60.015 | 47.712 | 85.500 |
| 1024 x 768 | 84.997 | 68.677 | 94.500 |
| 1440 x 900 | 59.887 | 55.935 | 106.500 |
| 1280 x 1024 | 60.020 | 63.981 | 108.000 |
| 1400 x 1050 | 59.978 | 65.317 | 121.750 |
| 1280 x 800 | 84.880 | 71.554 | 122.500 |
| 1280 x 1024 | 75.025 | 79.976 | 135.000 |
| 1440 x 900 | 74.984 | 70.635 | 136.750 |
| 1680 x 1050 | 59.954 | 65.290 | 146.250 |
| 1280 x 960 | 85.002 | 85.938 | 148.500 |
| 1920 x 1080 | 60.000 | 67.500 | 148.500 |
| 1024 x 768 | 119.989 | 97.551 | 115.500 |



NOTE: Support HDMI 1024x768@120 Hz DLP Link 3D, Frame sequential

6

Contacting Dell

For customers in the United States, call 800-WWW-DELL (800-999-3355).



NOTE: If you do not have an active Internet connection, you can find contact information on your purchase invoice, packing slip, bill, or Dell product catalog.

Dell™ provides several online and telephone-based support and service options. Availability varies by country and product, and some services may not be available in your area. To contact Dell for sales, technical support, or customer service issues:

- 1 Visit go to www.dell.com/contactDell.
- 2 Select your region on the interactive map.
- 3 Select a Segment for Contact.
- 4 Select the appropriate service or support link based on your need.

Appendix: Glossary

ANSI Lumens — A standard for measuring the brightness. It is calculated by dividing a square meter image into nine equal rectangles, measuring the lux (or brightness) reading at the center of each rectangle, and averaging these nine points.

Aspect Ratio — The most popular aspect ratio is 4:3 (4 by 3). Early television and computer video formats are in a 4:3 aspect ratio, which means that the width of the image is $\frac{4}{3}$ times the height.

Brightness — The amount of light emitted from a display or projection display or projection device. The brightness of projector is measured by ANSI lumens.

Color Temperature — The color appearance of white light. Low color temperature implies warmer (more yellow/red) light while high color temperature implies a colder (more blue) light. The standard unit for color temperature is Kelvin (K).

Compressed Resolution — If the input images are of higher resolution than the native resolution of the projector, the resulting image will be scaled to fit the native resolution of the projector. The nature of compression in a digital device means that some image content is lost.

Contrast Ratio — Range of light and dark values in a picture, or the ratio between their maximum and minimum values. There are two methods used by the projection industry to measure the ratio:

- 1 Full On/Off — measures the ratio of the light output of an all white image (full on) and the light output of an all black (full off) image.
- 2 ANSI — measures a pattern of 16 alternating black and white rectangles. The average light output from the white rectangles is divided by the average light output of the black rectangles to determine the ANSI contrast ratio.

Full On/Off contrast is always a larger number than ANSI contrast for the same projector.

dB — decibel — A unit used to express relative difference in power or intensity, usually between two acoustic or electric signals, equal to ten times the common logarithm of the ratio of the two levels.

Diagonal Screen — A method of measuring the size of a screen or a projected image. It measures from one corner to the opposite corner. A 9

FT high, 12 FT wide, screen has a diagonal of 15 FT. This document assumes that the diagonal dimensions are for the traditional 4:3 ratio of a computer image as per the example above.

DLP® — Digital Light Processing™ — Reflective display technology developed by Texas Instruments, using small manipulated mirrors. Light passing through a color filter is sent to the DLP mirrors which arrange the RGB colors into a picture projected onto screen, also known as DMD.

DMD — Digital Micro-Mirror Device — Each DMD consists of thousands of tilting, microscopic aluminum alloy mirrors mounted on a hidden yoke.

Focal Length — The distance from the surface of a lens to its focal point.

Frequency — It is the rate of repetition in cycles per seconds of electrical signals. Measured in Hz (Hertz).

HDCP — High-Bandwidth Digital-Content Protection — A specification developed by Intel™ Corporation to protect digital entertainment across digital interface, such as DVI, HDMI.

HDMI — High-Definition Multimedia Interface — HDMI carries both uncompressed high definition video along with digital audio and device control data in a single connector.

Hz (Hertz) — Unit of frequency.

Keystone Correction — Device that will correct an image of the distortion (usually a wide-top narrow-bottom effect) of a projected image caused by improper projector to screen angle.

Maximum Distance — The distance from a screen the projector can be to cast an image that is usable (bright enough) in a fully darkened room.

Maximum Image Size — The largest image a projector can throw in a darkened room. This is usually limited by focal range of the optics.

Minimum Distance — The closest position that a projector can focus an image onto a screen.

NTSC — National Television Standards Committee. North American standard for video and broadcasting, with a video format of 525 lines at 30 frames per second.

PAL — Phase Alternating Line. A European broadcast standard for video and broadcasting, with a video format of 625 lines at 25 frames per second.

Reverse Image — Feature that allows you to flip the image horizontally. When used in a normal forward projection environment text, graphics, etc. are backwards. Reverse image is used for rear projection.

SVGA — Super Video Graphics Array — 800 x 600 pixels count.

SXGA — Super Extended Graphics Array, — 1280 x 1024 pixels count.

UXGA — Ultra Extended Graphics Array — 1600 x 1200 pixels count.

VGA — Video Graphics Array — 640 x 480 pixels count.

XGA — Extended Video Graphics Array — 1024 x 768 pixels count.

WXGA — Wide Extended Graphics Array — 1280 x 800 pixels count.

Zoom Lens — Lens with a variable focal length that allows the operator to move the view in or out making the image smaller or larger.

Zoom Lens Ratio — Is the ratio between the smallest and largest image a lens can project from a fixed distance. For example, a 1.4:1 zoom lens ratio means that a 10 foot image without zoom would be a 14 foot image with full zoom.

Index

A

Adjusting the Projected Image
15

Adjusting the Projector
Height 15

Adjusting the Projector Zoom
and Focus 16

Focus ring 16

C

Connecting the Projector
Connecting with an HDMI
Cable 11

HDMI cable 11

Power cord 8, 11, 12, 13

SD card 13

To Computer 8

USB flash disk 12

USB-A to USB-A cable 8

Connection Ports

Audio-out connector 7

HDMI connector 7

Power cord connector 7

Security cable slot 7

Contact Dell 4, 73

Control Panel 19

D

Dell

contacting 79, 80

M

Main Unit 5

3 W speaker 5

Control panel 5

Elevator button for height
adjustments 5

Elevator foot 5

Focus ring 5

IR receivers 5

Lens 5

Menu Position 30

Menu Settings 30

Menu Timeout 30

Menu Transparency 30

O

On-Screen Display 25

Input Source 25

P

Password 30

phone numbers 79

Power Saving 33

Power Settings 33

Powering On/Off the Projector
Powering Off the Projector 14
Powering On the Projector 14

R

Remote Control 21
Reset, Factory 30

S

Specifications
Aspect Ratio 75
Audio 75
Brightness 75
Contrast Ratio 75
Dimensions 76
Displayable Color 75
Environmental 76
I/O Connectors 76
Internal Flash 75
Light Valve 75
Noise Level 75
Number of Pixels 75
Power Consumption 75
Power Supply 75
Projection Distance 75
Projection Lens 75
Projection Screen Size 75
Uniformity 75
Video Compatibility 75
Weight 76

support
contacting Dell 79, 80

T

telephone numbers 79
Test Pattern 29
Troubleshooting 71
Contact Dell 71

Free Manuals Download Website

<http://myh66.com>

<http://usermanuals.us>

<http://www.somanuals.com>

<http://www.4manuals.cc>

<http://www.manual-lib.com>

<http://www.404manual.com>

<http://www.luxmanual.com>

<http://aubethermostatmanual.com>

Golf course search by state

<http://golfingnear.com>

Email search by domain

<http://emailbydomain.com>

Auto manuals search

<http://auto.somanuals.com>

TV manuals search

<http://tv.somanuals.com>