

27051
**16" Variable Speed Scroll Saw
with Quickset II® Blade
Changing Feature**
(Models SS350, SS350LS)

INSTRUCTION MANUAL



PART NO. 912425 - 08-25-03
Copyright © 2003 Delta Machinery

 **DELTA**® *ShopMaster*™

To learn more about DELTA MACHINERY
visit our website at: www.deltamachinery.com.

For Parts, Service, Warranty or other Assistance,

please call **1-800-223-7278** (In Canada call **1-800-463-3582**).

RTD10000121AA

SAFETY GUIDELINES - DEFINITIONS

This manual contains information that is important for you to know and understand. This information relates to protecting YOUR SAFETY and PREVENTING EQUIPMENT PROBLEMS. To help you recognize this information, we use the symbols to the right. Please read the manual and pay attention to these sections.

▲ DANGER Indicates an imminently hazardous situation which, if not avoided, will result in death or serious injury.

▲ WARNING Indicates a potentially hazardous situation which, if not avoided, could result in death or serious injury.

▲ CAUTION Indicates a potentially hazardous situation which, if not avoided, may result in minor or moderate injury.

CAUTION Used without the safety alert symbol indicates potentially hazardous situation which, if not avoided, may result in property damage.

▲ WARNING **SOME DUST CREATED BY POWER SANDING, SAWING, GRINDING, DRILLING, AND OTHER CONSTRUCTION ACTIVITIES** contains chemicals known to cause cancer, birth defects or other reproductive harm. Some examples of these chemicals are:

- lead from lead-based paints,
- crystalline silica from bricks and cement and other masonry products, and
- arsenic and chromium from chemically-treated lumber.

Your risk from these exposures varies, depending on how often you do this type of work. To reduce your exposure to these chemicals: work in a well ventilated area, and work with approved safety equipment, always wear **MSHA/NIOSH** approved, properly fitting face mask or respirator when using such tools.

GENERAL SAFETY RULES



▲ WARNING **READ AND UNDERSTAND ALL WARNINGS AND OPERATING INSTRUCTIONS BEFORE USING THIS EQUIPMENT.** Failure to follow all instructions listed below, may result in electric shock, fire, and/or serious personal injury or property damage.

IMPORTANT SAFETY INSTRUCTIONS

Woodworking can be dangerous if safe and proper operating procedures are not followed. As with all machinery, there are certain hazards involved with the operation of the product. Using the machine with respect and caution will considerably lessen the possibility of personal injury. However, if normal safety precautions are overlooked or ignored, personal injury to the operator may result. Safety equipment such as guards, push sticks, hold-downs, featherboards, goggles, dust masks and hearing protection can reduce your potential for injury. But even the best guard won't make up for poor judgment, carelessness or inattention. Always use common sense and exercise caution in the workshop. If a procedure feels dangerous, don't try it. Figure out an alternative procedure that feels safer. **REMEMBER:** Your personal safety is your responsibility. For additional information please visit our website www.deltamachinery.com.

▲ WARNING This machine was designed for certain applications only. Delta Machinery strongly recommends that this machine not be modified and/or used for any application other than that for which it was designed. If you have any questions relative to a particular application, **DO NOT** use the machine until you have first contacted Delta to determine if it can or should be performed on the product.

Technical Service Manager
Delta Machinery
4825 Highway 45 North
Jackson, TN 38305
(IN CANADA: 505 SOUTHGATE DRIVE, GUELPH, ONTARIO N1H 6M7)

1. **FOR YOUR OWN SAFETY, READ THE INSTRUCTION MANUAL BEFORE OPERATING THE MACHINE.** Learning the machine's application, limitations, and specific hazards will greatly minimize the possibility of accidents and injury.
2. **USE CERTIFIED SAFETY EQUIPMENT.** Eye protection equipment should comply with ANSI Z87.1 standards, hearing equipment should comply with ANSI S3.19 standards, and dust mask protection should comply with MSHA/NIOSH certified respirator standards. Splinters, air-borne debris, and dust can cause irritation, injury, and/or illness.
3. **DRESS PROPERLY.** Do not wear tie, gloves, or loose clothing. Remove watch, rings, and other jewelry. Roll up your sleeves. Clothing or jewelry caught in moving parts can cause injury.
4. **DO NOT USE THE MACHINE IN A DANGEROUS ENVIRONMENT.** The use of power tools in damp or wet locations or in rain can cause shock or electrocution. Keep your work area well-lit to prevent tripping or placing arms, hands, and fingers in danger.
5. **MAINTAIN ALL TOOLS AND MACHINES IN PEAK CONDITION.** Keep tools sharp and clean for best and safest performance. Follow instructions for lubricating and changing accessories. Poorly maintained tools and machines can further damage the tool or machine and/or cause injury.
6. **CHECK FOR DAMAGED PARTS.** Before using the machine, check for any damaged parts. Check for alignment of moving parts, binding of moving parts, breakage of parts, and any other conditions that may affect its operation. A guard or any other part that is damaged **should be properly repaired or replaced.** Damaged parts can cause further damage to the machine and/or injury.
7. **KEEP THE WORK AREA CLEAN.** Cluttered areas and benches invite accidents.
8. **KEEP CHILDREN AND VISITORS AWAY.** Your shop is a potentially dangerous environment. Children and visitors can be injured.
9. **REDUCE THE RISK OF UNINTENTIONAL STARTING.** Make sure that the switch is in the "OFF" position before plugging in the power cord. In the event of a power failure, move the switch to the "OFF" position. An accidental start-up can cause injury.
10. **USE THE GUARDS.** Check to see that all guards are in place, secured, and working correctly to prevent injury.
11. **REMOVE ADJUSTING KEYS AND WRENCHES BEFORE STARTING THE MACHINE.** Tools, scrap pieces, and other debris can be thrown at high speed, causing injury.
12. **USE THE RIGHT MACHINE.** Don't force a machine or an attachment to do a job for which it was not designed. Damage to the machine and/or injury may result.
13. **USE RECOMMENDED ACCESSORIES.** The use of accessories and attachments not recommended by Delta may cause damage to the machine or injury to the user.
14. **USE THE PROPER EXTENSION CORD.** Make sure your extension cord is in good condition. When using an extension cord, be sure to use one heavy enough to carry the current your product will draw. An undersized cord will cause a drop in line voltage, resulting in loss of power and overheating. See the Extension Cord Chart for the correct size depending on the cord length and nameplate ampere rating. If in doubt, use the next heavier gauge. The smaller the gauge number, the heavier the cord.
15. **SECURE THE WORKPIECE.** Use clamps or a vise to hold the workpiece when practical. Loss of control of a workpiece can cause injury.
16. **FEED THE WORKPIECE AGAINST THE DIRECTION OF THE ROTATION OF THE BLADE, CUTTER, OR ABRASIVE SURFACE.** Feeding it from the other direction will cause the workpiece to be thrown out at high speed.
17. **DON'T FORCE THE WORKPIECE ON THE MACHINE.** Damage to the machine and/or injury may result.
18. **DON'T OVERREACH.** Loss of balance can make you fall into a working machine, causing injury.
19. **NEVER STAND ON THE MACHINE.** Injury could occur if the tool tips, or if you accidentally contact the cutting tool.
20. **NEVER LEAVE THE MACHINE RUNNING UNATTENDED. TURN THE POWER OFF.** Don't leave the machine until it comes to a complete stop. A child or visitor could be injured.
21. **TURN THE MACHINE "OFF", AND DISCONNECT THE MACHINE FROM THE POWER SOURCE** before installing or removing accessories, before adjusting or changing set-ups, or when making repairs. An accidental start-up can cause injury.
22. **MAKE YOUR WORKSHOP CHILDPROOF WITH PADLOCKS, MASTER SWITCHES, OR BY REMOVING STARTER KEYS.** The accidental start-up of a machine by a child or visitor could cause injury.
23. **STAY ALERT, WATCH WHAT YOU ARE DOING, AND USE COMMON SENSE. DO NOT USE THE MACHINE WHEN YOU ARE TIRED OR UNDER THE INFLUENCE OF DRUGS, ALCOHOL, OR MEDICATION.** A moment of inattention while operating power tools may result in injury.
24. **THE DUST GENERATED** by certain woods and wood products can be injurious to your health. Always operate machinery in well-ventilated areas, and provide for proper dust removal. Use wood dust collection systems whenever possible.

ADDITIONAL SAFETY RULES FOR SCROLL SAWS

▲WARNING FAILURE TO FOLLOW THESE RULES MAY RESULT IN SERIOUS PERSONAL INJURY.

1. **DO NOT OPERATE THIS MACHINE** until it is **assembled** and **installed** according to the instructions.
2. **OBTAIN ADVICE FROM YOUR SUPERVISOR, instructor, or another qualified person** if you are not familiar with the operation of this machine.
3. **FOLLOW ALL WIRING CODES** and recommended electrical connections.
4. **YOUR SCROLL SAW MUST** be securely fastened to a stand or workbench. If there is any tendency for the stand or workbench to move during operation, the stand or workbench **MUST** be fastened to the floor.
5. **THIS SCROLL SAW** is intended for indoor use only.
6. **MAKE SURE** blade is properly tensioned before operating saw.
7. **TO AVOID** blade breakage **ALWAYS** adjust blade tension correctly.
8. **MAKE SURE** the blade teeth point downward toward the table.
9. **NEVER** turn the saw "ON" before clearing the table of all objects (tools, scraps of wood, etc.).
10. **DO NOT** cut material that is too small to be safely supported.
11. **AVOID** awkward hand positions where a sudden slip could cause a hand to move into the blade.
12. **ALWAYS** keep hands and fingers away from blade.
13. **ALWAYS** adjust holddown foot for each new operation.
14. **DO NOT USE** dull or bent blades.
15. **DO NOT** attempt to saw material that does not have a flat surface, unless a suitable support is used.
16. **MAKE** "relief" cuts before cutting long curves.
17. **NEVER** attempt to cut a curve that is too tight for the blade being used.
18. **WHEN** backing a blade out of a workpiece, the blade may bind in the saw kerf. This is usually caused by sawdust in the kerf. If this happens, turn "**OFF**" the switch and remove plug from power source outlet. Wedge open the kerf and back blade out of the workpiece.
19. **THE USE** of attachments and accessories not recommended by Delta may result in the risk of injuries.
20. **ALWAYS** hold the work firmly against the table.
21. **DO NOT** feed the material too fast while cutting. Only feed the material fast enough so that the blade will cut.
22. **NEVER** start the Scroll Saw with the stock pressed against the blade.
23. **WHEN** cutting a large workpiece **MAKE SURE** the material is supported at table height.
24. **USE CAUTION** when cutting material which is irregular in cross section which could pinch the blade before the cut is completed. A piece of moulding for example must lay flat on the table and not be permitted to rock while being cut.
25. **USE CAUTION** when cutting round material such as dowel rods or tubing. They have a tendency to roll while being cut causing the blade to "bite." Use a V-block to control the piece.
26. **ALWAYS** release blade tension before removing the blade from the upper or lower blade holders.
27. **MAKE CERTAIN** table tilting lock is tightened before starting the machine.
28. **NEVER** reach under the table while the machine is running.
29. **NEVER** perform layout, assembly or set-up work on the table while the saw is operating.
30. **ALWAYS STOP** the saw before removing scrap pieces from the table.
31. **TURN THE MACHINE "OFF" AND DISCONNECT THE MACHINE** from the power source before installing or removing accessories, before adjusting or changing set-ups, or when making repairs.
32. **TURN THE MACHINE "OFF"**, disconnect the machine from the power source, and clean the table/work area before leaving the machine. **LOCK THE SWITCH IN THE "OFF" POSITION** to prevent unauthorized use.
33. **ADDITIONAL INFORMATION** regarding the safe and proper operation of this tool is available from the Power Tool Institute, 1300 Summer Avenue, Cleveland, OH 44115-2851. Information is also available from the National Safety Council, 1121 Spring Lake Drive, Itasca, IL 60143-3201. Please refer to the American National Standards Institute ANSI 01.1 Safety Requirements for Woodworking Machines and the U.S. Department of Labor OSHA 1910.213 Regulations.

SAVE THESE INSTRUCTIONS.
Refer to them often and use them to instruct others.

POWER CONNECTIONS

A separate electrical circuit should be used for your machines. This circuit should not be less than #12 wire and should be protected with a 20 Amp time lag fuse. If an extension cord is used, use only 3-wire extension cords which have 3-prong grounding type plugs and matching receptacle which will accept the machine's plug. Before connecting the machine to the power line, make sure the switch is in the "OFF" position and be sure that the electric current is of the same characteristics as indicated on the machine. All line connections should make good contact. Running on low voltage will damage the machine.

⚠ DANGER DO NOT EXPOSE THE MACHINE TO RAIN OR OPERATE THE MACHINE IN DAMP LOCATIONS.

MOTOR SPECIFICATIONS

Your machine is wired for 120 volt, 60 HZ alternating current. Before connecting the machine to the power source, make sure the switch is in the "OFF" position.

GROUNDING INSTRUCTIONS

⚠ DANGER THIS MACHINE MUST BE GROUNDED WHILE IN USE TO PROTECT THE OPERATOR FROM ELECTRIC SHOCK.

1. All grounded, cord-connected machines:

In the event of a malfunction or breakdown, grounding provides a path of least resistance for electric current to reduce the risk of electric shock. This machine is equipped with an electric cord having an equipment-grounding conductor and a grounding plug. The plug must be plugged into a matching outlet that is properly installed and grounded in accordance with all local codes and ordinances.

Do not modify the plug provided - if it will not fit the outlet, have the proper outlet installed by a qualified electrician.

Improper connection of the equipment-grounding conductor can result in risk of electric shock. The conductor with insulation having an outer surface that is green with or without yellow stripes is the equipment-grounding conductor. If repair or replacement of the electric cord or plug is necessary, do not connect the equipment-grounding conductor to a live terminal.

Check with a qualified electrician or service personnel if the grounding instructions are not completely understood, or if in doubt as to whether the machine is properly grounded.

Use only 3-wire extension cords that have 3-prong grounding type plugs and matching 3-conductor receptacles that accept the machine's plug, as shown in Fig. A.

Repair or replace damaged or worn cord immediately.

2. Grounded, cord-connected machines intended for use on a supply circuit having a nominal rating less than 150 volts:

If the machine is intended for use on a circuit that has an outlet that looks like the one illustrated in Fig. A, the machine will have a grounding plug that looks like the plug illustrated in Fig. A. A temporary adapter, which looks like the adapter illustrated in Fig. B, may be used to connect this plug to a matching 2-conductor receptacle as shown in Fig. B if a properly grounded outlet is not available. The temporary adapter should be used only until a properly grounded outlet can be installed by a qualified electrician. The green-colored rigid ear, lug, and the like, extending from the adapter must be connected to a permanent ground such as a properly grounded outlet box. Whenever the adapter is used, it must be held in place with a metal screw.

NOTE: In Canada, the use of a temporary adapter is not permitted by the Canadian Electric Code.

⚠ DANGER IN ALL CASES, MAKE CERTAIN THE RECEPTACLE IN QUESTION IS PROPERLY GROUNDED. IF YOU ARE NOT SURE HAVE A QUALIFIED ELECTRICIAN CHECK THE RECEPTACLE.

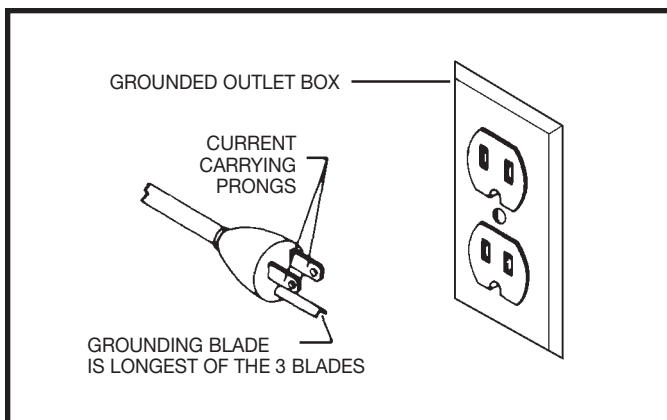

Fig. A

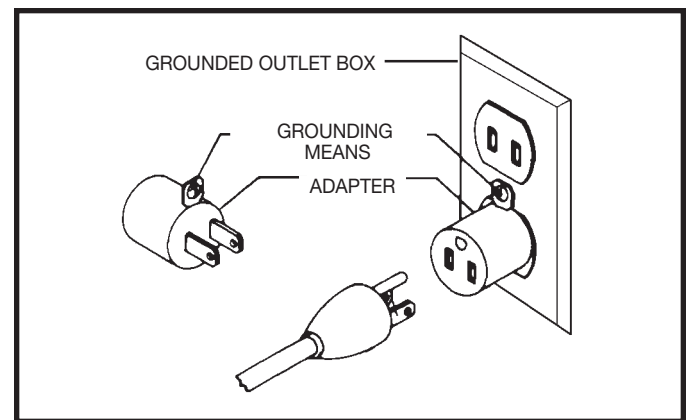

Fig. B

EXTENSION CORDS

CAUTION Use proper extension cords. Make sure your extension cord is in good condition and is a 3-wire extension cord which has a 3-prong grounding type plug and matching receptacle which will accept the machine's plug. When using an extension cord, be sure to use one heavy enough to carry the current of the machine. An undersized cord will cause a drop in line voltage, resulting in loss of power and overheating. Fig. D, shows the correct gauge to use depending on the cord length. If in doubt, use the next heavier gauge. The smaller the gauge number, the heavier the cord.

MINIMUM GAUGE EXTENSION CORD			
RECOMMENDED SIZES FOR USE WITH STATIONARY ELECTRIC MACHINES			
Ampere Rating	Volts	Total Length of Cord in Feet	Gauge of Extension Cord
0-6	120	up to 25	18 AWG
0-6	120	25-50	16 AWG
0-6	120	50-100	16 AWG
0-6	120	100-150	14 AWG
6-10	120	up to 25	18 AWG
6-10	120	25-50	16 AWG
6-10	120	50-100	14 AWG
6-10	120	100-150	12 AWG
10-12	120	up to 25	16 AWG
10-12	120	25-50	16 AWG
10-12	120	50-100	14 AWG
10-12	120	100-150	12 AWG
12-16	120	up to 25	14 AWG
12-16	120	25-50	12 AWG
12-16	120	GREATER THAN 50 FEET NOT RECOMMENDED	

Fig. D

FUNCTIONAL DESCRIPTION

FOREWORD

Delta ShopMaster Models SS350 and SS350LS 16" Scroll Saws are designed to give high quality, smooth cutting performance with capacity to cut up to 16" wide by 2" thick woodworking materials and have a 3/4" stroke. Delta ShopMaster Models SS350 and SS350LS come equipped with; integral dust port, variable speed 600-1650 spm, lock-out switch, cast iron table for minimal vibration, Quickset II® Blade Chuck System for ergonomic "wrench-free" blade changing; accepts wide variety of 5" flat end blades; 45° left tilting for bevel cuts; adjustable dust blower to keep cutting line free of dust. The Delta Model SS350LS also comes with a stand.

UNPACKING AND CLEANING

Carefully unpack the machine and all loose items from the shipping container(s). Remove the protective coating from all unpainted surfaces. This coating may be removed with a soft cloth moistened with kerosene (do not use acetone, gasoline or lacquer thinner for this purpose). After cleaning, cover the unpainted surfaces with a good quality household floor paste wax.

NOTICE: THE MANUAL COVER PHOTO ILLUSTRATES THE CURRENT PRODUCTION MODEL. ALL OTHER ILLUSTRATIONS ARE REPRESENTATIVE ONLY AND MAY NOT DEPICT THE ACTUAL COLOR, LABELING OR ACCESSORIES AND MAY BE INTENDED TO ILLUSTRATE TECHNIQUE ONLY.

CARTON CONTENTS

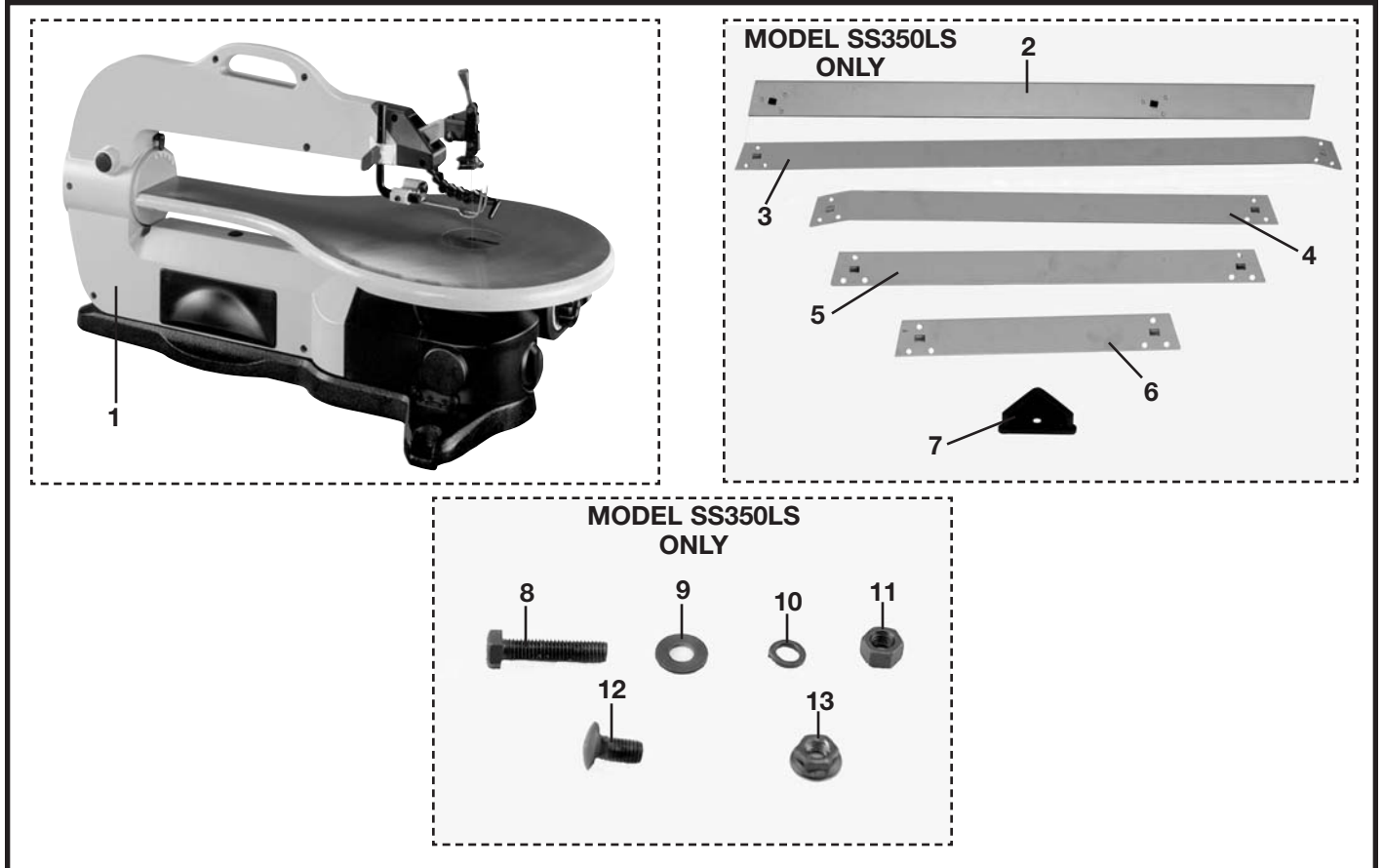

Fig. 1

1. Scroll Saw

FOR MODEL SS350LS ONLY

- 2. Stand Leg (3)
- 3. Lower Side Brace 30" Long (2)
- 4. Upper Side Brace 22½" Long (2)
- 5. Lower Back Brace 18½" Long (1)

- 6. Upper Back Brace 12" Long (1)
- 7. Stand Leg Foot (3)
- 8. 5/16-18x1½" Hex Head Screw (3)
- 9. 5/16" Flat Washer (6)
- 10. 5/16" Lockwasher (3)
- 11. 5/16-18 Hex Nut (3)
- 12. M8x16mm Carriage Head Screw (12)
- 13. M8x1.25 Flange Hex Nut (12)

ASSEMBLY

⚠ WARNING FOR YOUR OWN SAFETY, DO NOT CONNECT THE MACHINE TO THE POWER SOURCE UNTIL THE MACHINE IS COMPLETELY ASSEMBLED AND YOU READ AND UNDERSTAND THE ENTIRE INSTRUCTION MANUAL.

STAND

(FOR MODEL SS350LS ONLY)

NOTE: THE ASSEMBLY OF THIS STAND WILL USE M8X16MM CARRIAGE HEAD SCREWS AND M8 FLANGED HEX NUTS. KEEP THE HEAD OF THE CARRIAGE HEAD SCREWS TO THE OUTSIDE OF THE STAND WITH THE FLANGED HEX NUTS TO THE INSIDE OF THE STAND.

NOTE: MAKE SURE THAT THE SHELF ON THE BRACES ARE ON TOP WHEN ATTACHING THE BRACES TO THE LEGS.

Assemble stand as shown in Fig. 2 using parts shown in Fig. 1. The braces, legs and feet are labeled the same in both illustrations. Insert the M8x1.25x16mm carriage head screws through legs and braces then secure with the M8x1.25 flange hex nuts. Loosely tighten hardware at this time.

NOTE: MAKE SURE THAT THE DIMPLES ON THE LEGS (A) FIG. 2 ARE ENGAGED WITH THE HOLES ON THE BRACES (B).

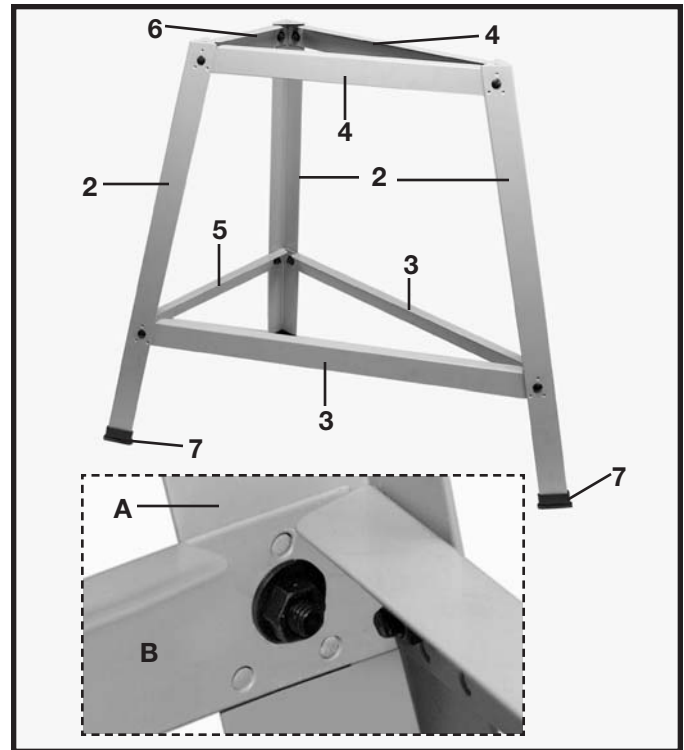

Fig. 2

SCROLL SAW TO STAND

(FOR MODEL SS350LS ONLY)

1. Place the scroll saw on the top braces of the stand Fig. 3.

2. Align the three holes (A) Fig. 3, (two of which are shown), with the three holes in the top of the stand.

3. Place a 5/16" flat washer on a 5/16-18x1½" hex head screw, insert the screw through the hole in the base of the scroll saw and the hole in the stand. Place a 5/16" flat washer, 5/16" lockwasher and thread a 5/16-18 hex nut onto the screw. Repeat this process for the two remaining holes in the scroll saw base and stand.

4. Tighten all stand hardware securely.



Fig. 3

FASTENING SCROLL SAW TO SUPPORTING SURFACE

This scroll saw **MUST** be securely fastened to a stand or workbench using the three holes, two of which are shown at (A) Fig. 4. The third hole is at the rear of the machine.

An alternate method of securing the scroll saw to a supporting surface is to fasten the scroll saw to a mounting board. Then securely clamp the mounting board to a stand or workbench using two or more C-clamps. **NOTE:** For proper stability, the holes in the mounting board must be countersunk at the bottom so that the fastener heads are flush with the bottom surface of the mounting board.

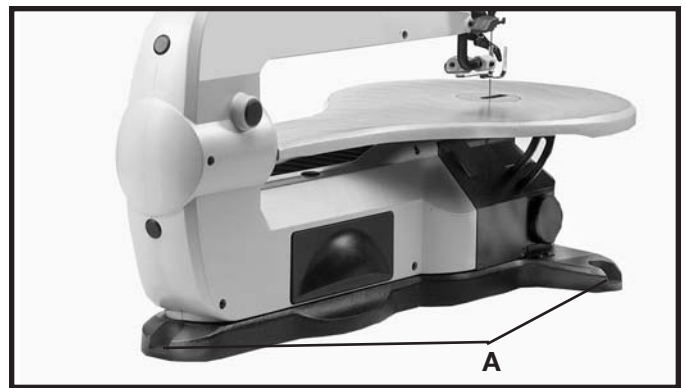

Fig. 4

OPERATING CONTROLS AND ADJUSTMENTS

ON-OFF AND VARIABLE SPEED SWITCH

The on-off switch (A) Fig. 5, and variable speed control (B) is located on the right side of the scroll saw base. To turn the saw **"ON,"** move the switch (A) up to the "ON" position. To turn the saw **"OFF,"** move the switch (A) down to the "OFF" position.

The scroll saw is equipped with a variable speed control (B) Fig. 5. The variable speed range is 600 to 1650 strokes per minute. When the variable speed knob (B) Fig. 5, is rotated all the way to the left (counterclockwise) the speed will be 600 strokes per minute. To increase the speed, rotate knob (B) to the right (clockwise) until the desired speed is obtained. When the knob (B) is rotated all the way to the right (clockwise) the speed will be 1650 strokes per minute.



Fig. 5

LOCKING ON-OFF SWITCH IN THE "OFF" POSITION

IMPORTANT: When the machine is not in use, the switch should be locked in the OFF position to prevent unauthorized use. This can be done by grasping the switch toggle (B) and pulling it out of the switch, as shown in Fig. 6. With the switch toggle (B) removed, the switch will not operate. However, should the switch toggle be removed while the saw is running, the switch can be turned **"OFF"** once, but cannot be restarted without inserting the switch toggle (B).



Fig. 6

ADJUSTING BLADE TENSION

Tension is applied to the blade when the blade tension lever (A) Fig. 7, has been adjusted and is in the vertical position as shown. When the blade tension lever (A) is moved to the horizontal position, as shown in Fig. 8, blade tension is released.

To adjust blade tension, position lever (A) in the vertical position, as shown in Fig. 7. To increase tension, turn lever (A) clockwise and to decrease tension turn lever (A) counterclockwise. When adjusting tension, turn lever one-quarter of a turn at a time. **NOTE:** It is necessary to adjust the blade tension only when the blade is removed from both the upper and lower blade holders and a new or different type of blade is used. It is not necessary to adjust blade tension when the blade is removed and replaced in only the upper blade holder as in performing inside cutting operations. After desired tension is obtained, position tension lever (A) in the horizontal position, as shown in Fig. 7.

Adjusting the blade for proper tension is usually accomplished by trial and error. One method is to pull back on the blade tension lever (A) Fig. 8, the blade should start to have tension (resistance) when the blade tension lever is half way between open Fig. 8, and closed Fig. 7 positions. Finer blades require more tensioning while thicker blades require less tension.

ADJUSTING CLAMPING ACTION OF UPPER AND LOWER BLADE HOLDER CHUCK

Different widths of scroll saw blades will make it necessary to adjust the clamping action of the upper and lower blade holders. It should be noted, however, that very little adjustment is necessary and very little clamping force is required to hold the blade satisfactorily. As a rule of thumb, looking down at the table with the table insert slot in the 6 o'clock position, resistance on the blade locking lever should be felt when the upper blade locking lever reaches the 7 o'clock position, or when the lower blade locking lever reaches the 5 o'clock position.

1. Move the blade locking lever (A) Fig. 9, to the rear (open) position, as shown.

2. Turn chuck clamping knob (B) Fig. 9, clockwise to tighten and counterclockwise to loosen the clamping action of the blade holder chuck. Very little movement of knob (B) will be necessary. **NOTE:** Only the upper chuck is shown. Clamping action of the lower chuck is adjusted in the same manner and can be accessed by removing dust cup shown in Fig. 24.

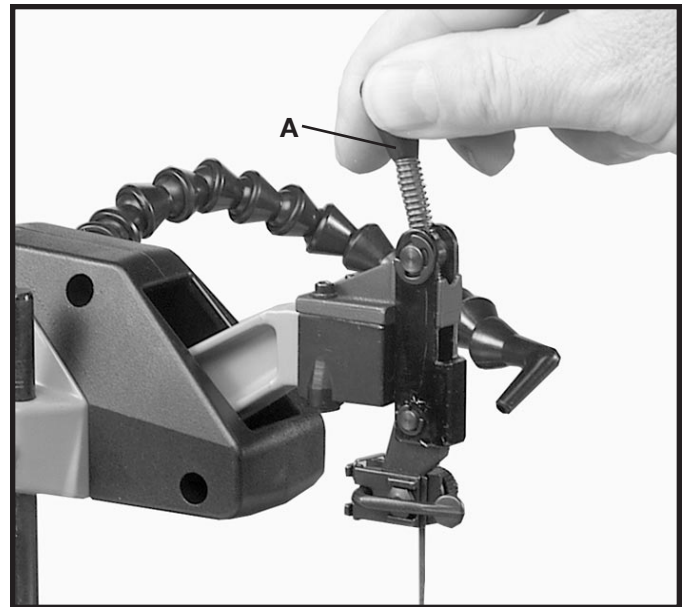

Fig. 7

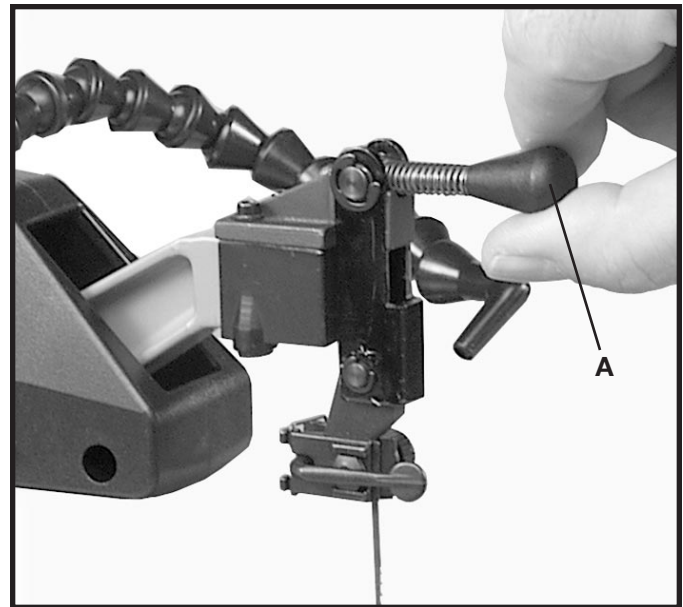

Fig. 8

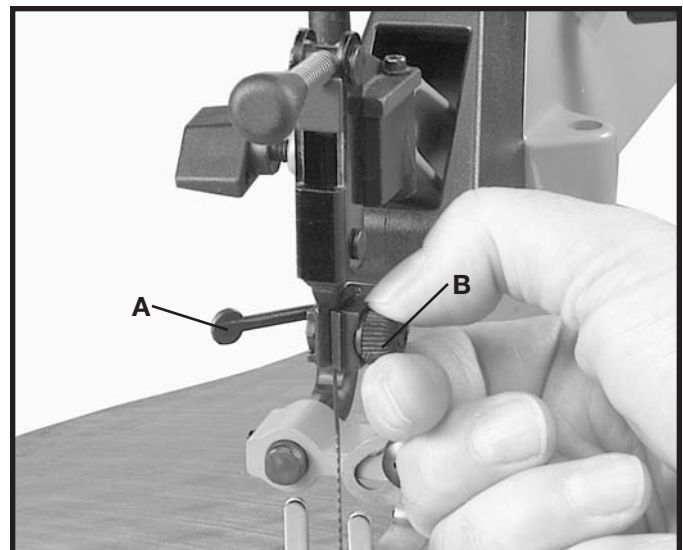

Fig. 9

TILTING THE TABLE

The table on your scroll saw can be tilted 45° to the left for bevel cutting operations by removing the dust cup as shown in Fig. 24 and loosening table lock knob (A) Fig. 10, tilt the table to the desired angle indicated on degree scale (B) Fig. 11 and tighten lock handle (A) Fig. 10.

When bevel cutting, the holddown (B) Fig. 12, can be adjusted to lay flat on the stock by loosening screw (C) and tilting the holddown (B). Then tighten screw (C).

ADJUSTING THE TABLE

1. Loosen table lock knob as shown in Fig. 10 and move the table all the way to the right until angle indicator shown in Fig. 11 is on "0".
2. Using a square that includes a level, check to see if the table is level (A) Fig. 13, and is 90° to the saw blade (B), as shown.

3. If the table is not at 90° to the blade, adjust the table making certain screw (B) Fig. 14, contacts bottom of table surface when table is 90° to the blade. To make this adjustment loosen nut (C), turn screw (B) in or out the desired distance and tighten nut (C).

Note: After adjusting table, reposition the pointer (B) Fig. 11 to "0" degrees. Loosen the screw (A) Fig. 11 and adjust pointer (B) to "0" degree mark and retighten screw (A).

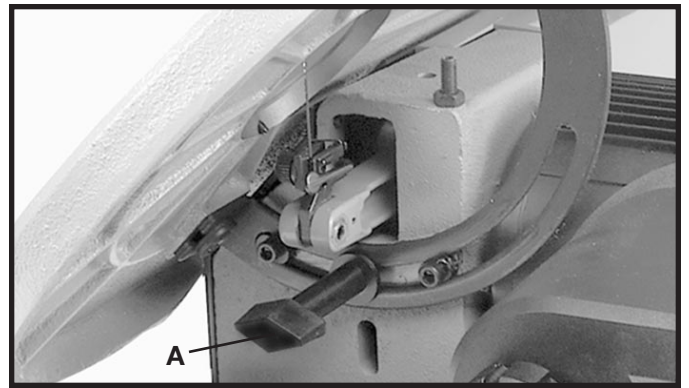

Fig. 10

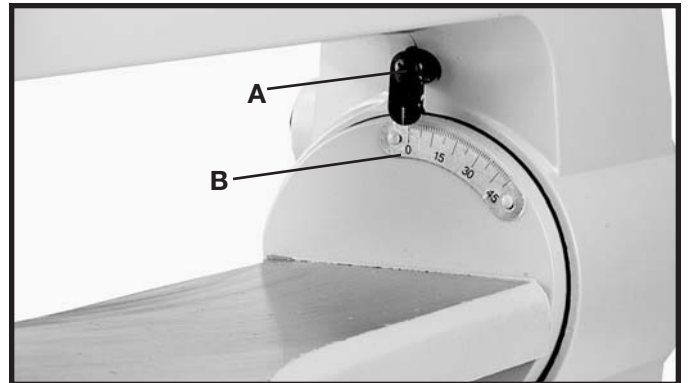

Fig. 11

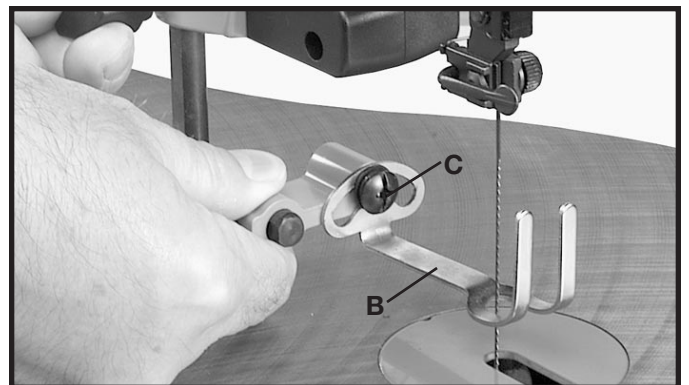

Fig. 12

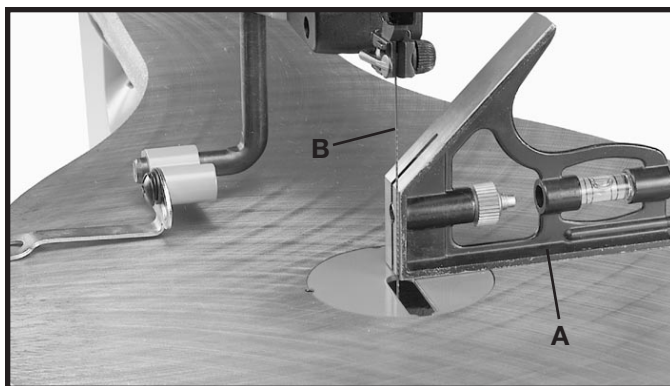

Fig. 13

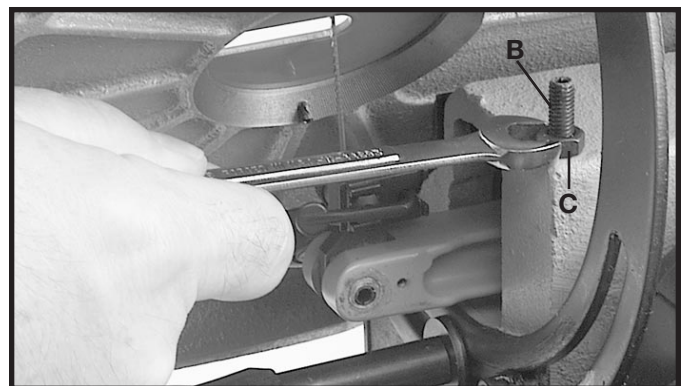

Fig. 14

ADJUSTING HOLDDOWN

The holddown (A) Fig. 15, should be adjusted so it contacts the top surface of the work (D) being cut. Loosen lock knob (B) and move holddown rod (C) up or down, then tighten lock knob (B). The holddown (A) Fig. 15, may be adjusted front to rear, by loosening set screw (B) Fig. 16, and positioning the holddown in the desired location. Once the holddown is in the desired location, tighten set screw (B), Fig. 16.

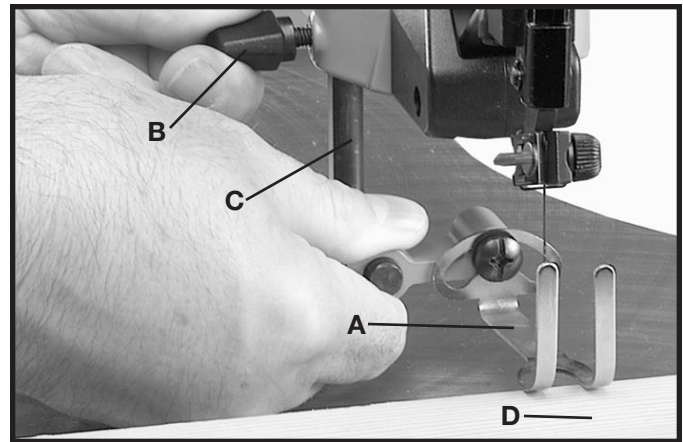

Fig. 15

ADJUSTING DUST BLOWER

The dust blower (A) Fig. 16, may be positioned to direct air to the most effective point on the workpiece.

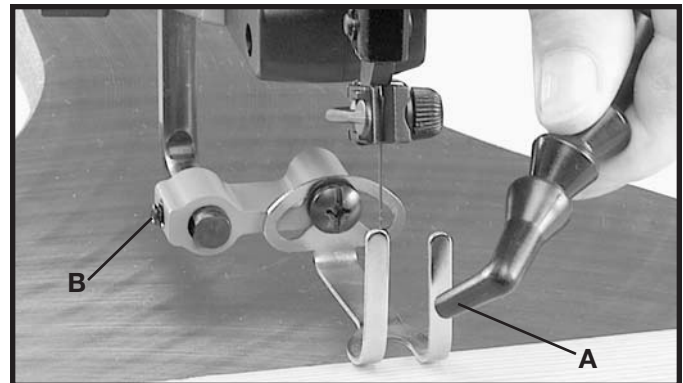

Fig. 16

DUST COLLECTION CUP

A dust collection cup (A) Fig. 17 is provided and can be attached to a vacuum system by utilizing the port covered by cap (B).

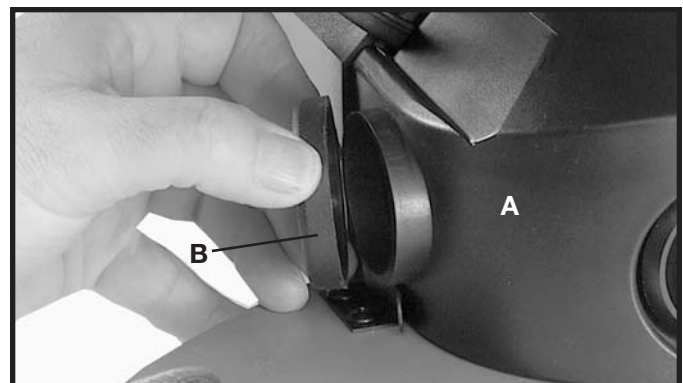

Fig. 17

TABLE INSERT

⚠ WARNING DISCONNECT MACHINE FROM POWER SOURCE.

The table insert (A) can be positioned in the saw table with the opening in the insert pointing to the front of the table, as shown in Fig. 18, or to the right as shown in Fig. 19.

With the table in the level position, 90° to the blade, the insert (A) should be positioned, as shown in Fig. 18. This allows for the blade to be pivoted forward after it is unclamped from the top blade holder, enabling you to quickly insert the blade into the next hole in a pattern when doing inside-cutting, as you will see later in this manual.

When tilting the table for bevel cutting operations the insert (A) should be positioned as shown in Fig. 19. This allows for clearance of the blade when tilting the table.

A blank table insert (B) Fig. 20, is supplied as standard equipment with your scroll saw and can be used when cutting very small workpieces to give added support to the bottom of the workpiece. Cut a slot into the blank and replace the standard insert (A) with the blank (B). The slot cut into the blank (B) will only be as wide as the blade giving maximum support to the bottom of the workpiece. Adhesive backed spacer pads (C) are also supplied for adjusting the table insert height relative to the table surface. Place three pads an equal distance apart on a cleaned surface to be applied to the blank insert. Pads can be stacked in order to achieve desired insert height.

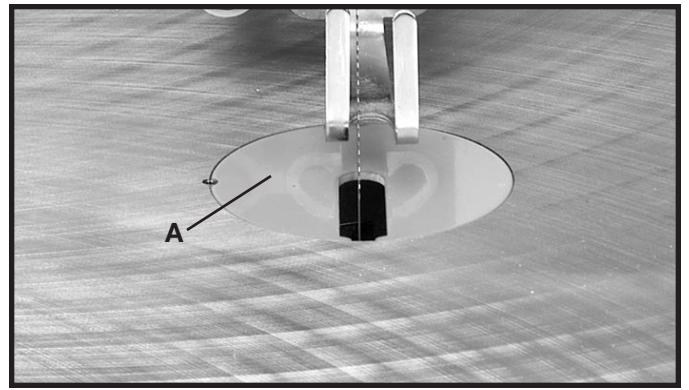

Fig. 18

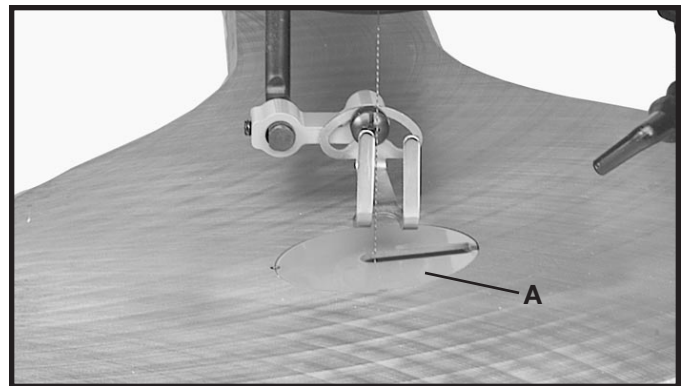

Fig. 19

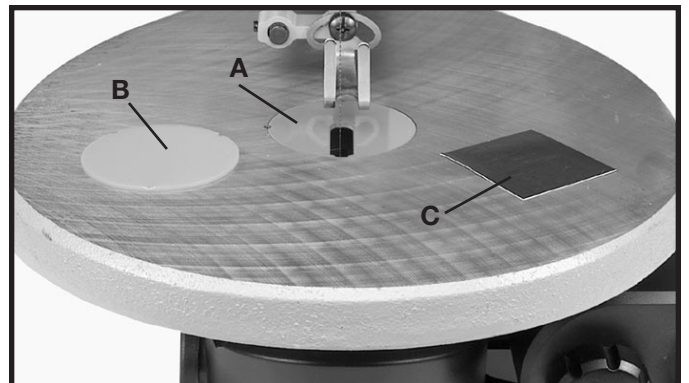

Fig. 20

OPERATIONS

FOLLOWING A LINE

With your scroll saw you should be able to perform straight or curved cuts with ease. Most beginners will experience blade wandering; however, they eventually learn to control it as they become more familiar with the machine. Use scrap material to practice cuts before starting a project. This enables you to develop your own style of cutting and you will discover what you can do with your saw.

Always hold the work firmly against the table and do not feed the workpiece too fast while cutting. Feed the workpiece only fast enough so that the blade will cut. Scroll saws cut faster across the grain than they do with the grain. Allow for this tendency when cutting patterns that shift rather quickly from with-the-grain cuts to cross-grain cuts.

Make "relief" cuts before cutting long curves and never attempt to cut a curve that is too tight for the blade being used.

INSIDE CUTTING

Inside cutting takes place when the blade is threaded through a hole in the workpiece. With your Delta 16" Scroll Saw, you can perform this operation quickly and easily as follows:

Loosen lock handle (A) Fig. 21, and raise the holddown (B). Release blade tension by moving the blade tension lever (C) to the horizontal position as previously explained. Release upper blade holder lever (D) as previously explained. This will release the blade (E) and allow you to thread the blade through the next hole in the pattern. Replace blade in upper blade holder and move blade tension lever to the vertical position to re-apply blade tension. Lower holddown and you are ready to make the next cut.

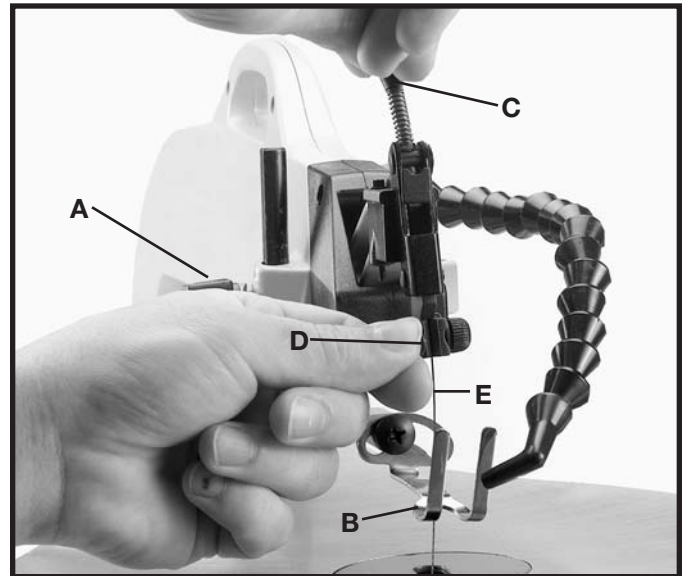

Fig. 21

TROUBLE SHOOTING

CHOICE OF BLADE AND SPEED

Your scroll saw will accept a wide variety of 5" flat end blades and can be operated at any speed from 600 to 1650 cutting strokes per minute. Consider the following as a general guideline for selecting a blade and operating speed.

1. Use a finer blade for cutting thin workpieces, for hard materials, or when a smooth cut is required.
2. Use a coarser blade for cutting thick workpieces, when making straight cuts or for medium to soft materials.
3. Use a blade that will have 2 teeth in the workpiece at all times.
4. Most blade packaging is marked with the size of the wood the blade is intended to cut and the minimum radius which can be cut with that blade.
5. Slower speeds are generally more effective than faster speeds when using thin blades and making intricate cuts.
6. Always start at a slow speed and gradually increase the speed until the best cutting speed is obtained.

BLADE BREAKAGE

Blade breakage is usually caused by one or more of the following:

1. Bending the blade during installation.
2. Improper blade tension.
3. Improper blade selection for the work being cut.
4. Forcing the work into the blade too rapidly.
5. Cutting too sharp a turn for the blade being used.
6. Improper blade speed.

MAINTENANCE

CHANGING BLADES

⚠ WARNING DISCONNECT MACHINE FROM POWER SOURCE.

1. Remove table insert (A) Fig. 22, and release blade tension by pulling tension lever (B) forward, as shown.

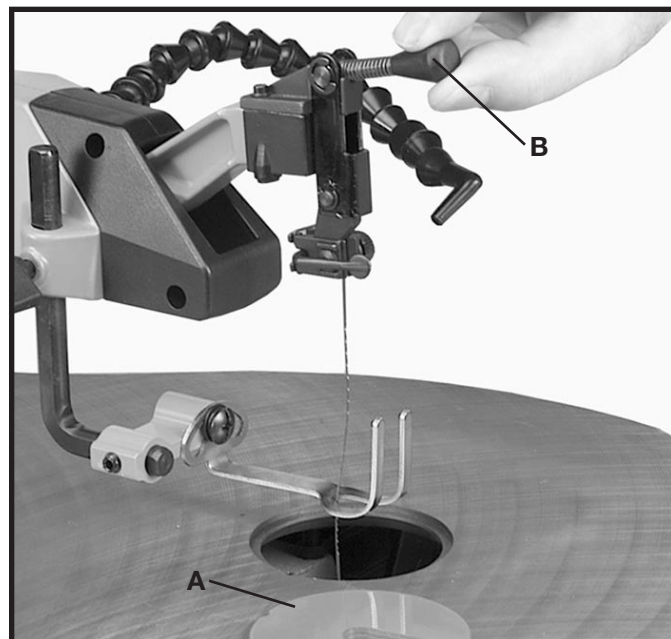

Fig. 22

2. Push upper blade chuck locking lever (C) Fig. 23, to the rear as shown. This will release the blade (D) from the upper chuck (E).

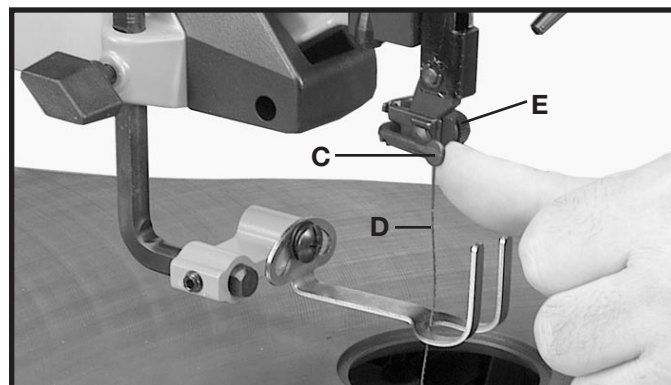

Fig. 23

3. Remove the dust collection cup (A) by rotating knob (B) 90° as shown in Fig. 24. Slide dust cup out of the guides (C) by pulling it toward the front. **NOTE: DO NOT OPERATE THE UNIT WITH THE DUST CUP REMOVED.**

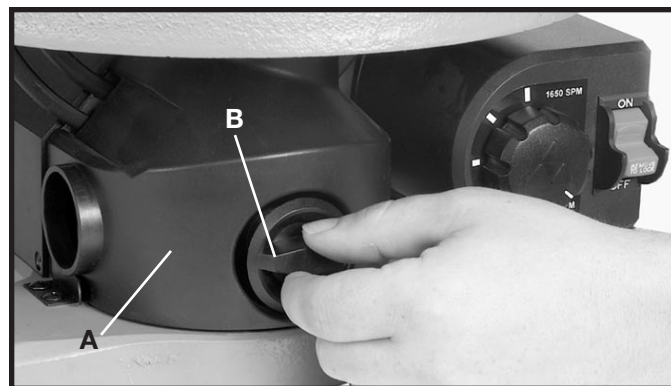

Fig. 24

4. Push lower blade chuck locking lever (F) Fig. 25, to the rear as shown. This will release the blade (G) from the lower chuck (H).

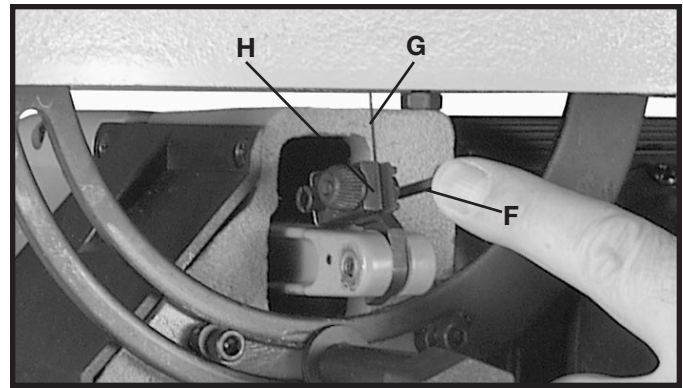

Fig. 25

5. Insert new blade (I) Fig. 26, into the upper blade holder (J) making certain the blade teeth are pointing down toward the table. Push upper blade chuck locking lever (L) to the front. Insert new blade into the lower blade holder Fig. 25 in the same manner.

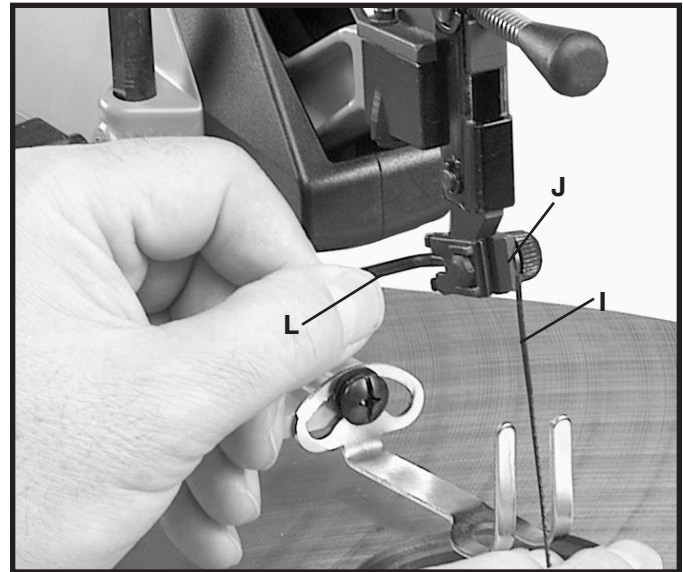

Fig. 26

6. Apply blade tension by referring to the following section “**ADJUSTING BLADE TENSION.**”

FUSE REPLACEMENT

A fuse holder (A) Fig. 27, and fuse (B) are located at the rear of the machine and should be removed and checked if the machine does not operate. If the fuse (B) is bad, replace it with a 3 amp fast blow fuse.

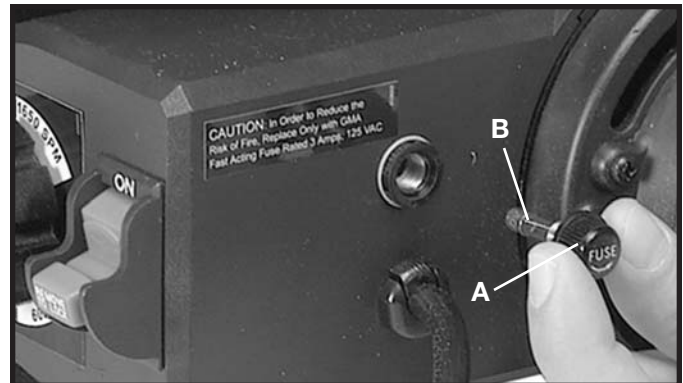

Fig. 27

LUBRICATION

Perform maintenance below after each 20 hours of use.

⚠ WARNING DISCONNECT MACHINE FROM POWER SOURCE.

1. Tilt the table 45° to the left as shown in Fig. 28.
2. Remove four rubber grommets (A) Fig. 29 that cover the lubrication access holes.
3. Lubricate the pivot points in each of the four access holes with a few drops of light machine oil.
4. Reassemble the four grommets as shown in Fig. 29.
5. Apply lightweight grease or anti-seize to lubricate the tensioning lever (C) Fig. 21 where it pivots on the upper chuck.

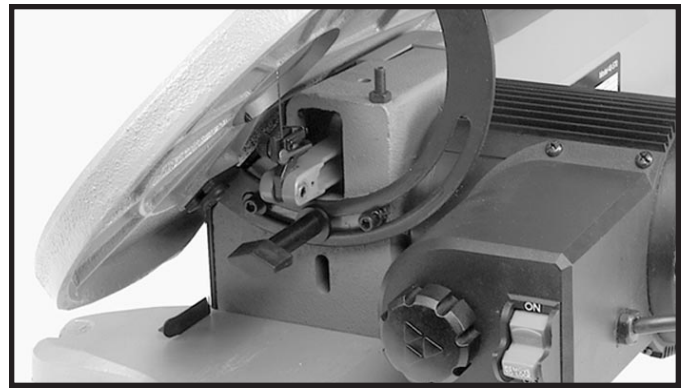

Fig. 28

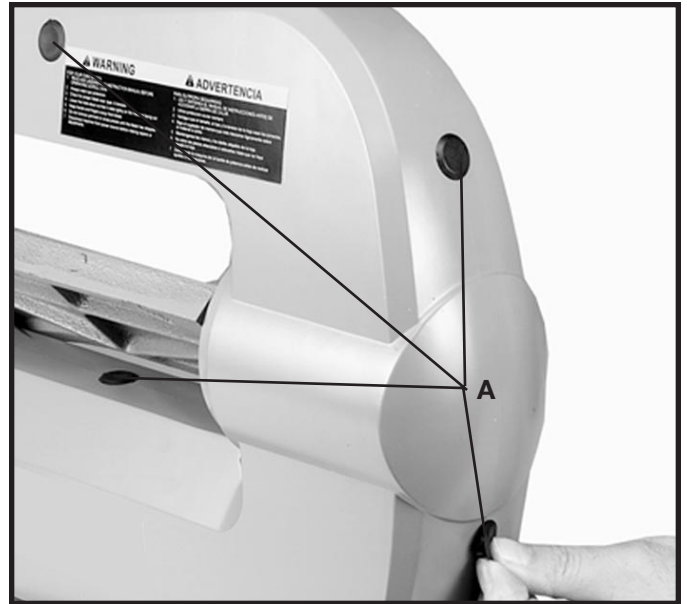

Fig. 29

ACCESSORIES

A complete line of accessories is available from your Delta Supplier, Porter-Cable • Delta Factory Service Centers, and Delta Authorized Service Stations. Please visit our Web Site www.deltamachinery.com for a catalog or for the name of your nearest supplier.

⚠ WARNING Since accessories other than those offered by Delta have not been tested with this product, use of such accessories could be hazardous. For safest operation, only Delta recommended accessories should be used with this product.



PARTS, SERVICE OR WARRANTY ASSISTANCE

All Delta Machines and accessories are manufactured to high quality standards and are serviced by a network of Porter-Cable • Delta Factory Service Centers and Delta Authorized Service Stations. To obtain additional information regarding your Delta quality product or to obtain parts, service, warranty assistance, or the location of the nearest service outlet, please call 1-800-223-7278 (In Canada call 1-800-463-3582).



Two Year Limited New Product Warranty

Delta will repair or replace, at its expense and at its option, any new Delta machine, machine part, or machine accessory which in normal use has proven to be defective in workmanship or material, provided that the customer returns the product prepaid to a Delta factory service center or authorized service station with proof of purchase of the product within two years and provides Delta with reasonable opportunity to verify the alleged defect by inspection. For all refurbished Delta product, the warranty period is 180 days. Delta may require that electric motors be returned prepaid to a motor manufacturer's authorized station for inspection and repair or replacement. Delta will not be responsible for any asserted defect which has resulted from normal wear, misuse, abuse or repair or alteration made or specifically authorized by anyone other than an authorized Delta service facility or representative. Under no circumstances will Delta be liable for incidental or consequential damages resulting from defective products. This warranty is Delta's sole warranty and sets forth the customer's exclusive remedy, with respect to defective products; all other warranties, express or implied, whether of merchantability, fitness for purpose, or otherwise, are expressly disclaimed by Delta.

PORTER-CABLE • DELTA SERVICE CENTERS (CENTROS DE SERVICIO DE PORTER-CABLE • DELTA)

Parts and Repair Service for Porter-Cable • Delta Machinery are Available at These Locations
(Obtenga Refaccion de Partes o Servicio para su Herramienta en los Siguietes Centros de Porter-Cable • Delta)

ARIZONA

Tempe 85282 (Phoenix)
2400 West Southern Avenue
Suite 105
Phone: (602) 437-1200
Fax: (602) 437-2200

CALIFORNIA

Ontario 91761 (Los Angeles)
3949A East Guasti Road
Phone: (909) 390-5555
Fax: (909) 390-5554

San Leandro 94577 (Oakland)
3039 Teagarden Street
Phone: (510) 357-9762
Fax: (510) 357-7939

COLORADO

Arvada 80003 (Denver)
8175 Sheridan Blvd., Unit S
Phone: (303) 487-1809
Fax: (303) 487-1868

FLORIDA

Davie 33314 (Miami)
4343 South State Rd. 7 (441)
Unit #107
Phone: (954) 321-6635
Fax: (954) 321-6638

Tampa 33609
4538 W. Kennedy Boulevard
Phone: (813) 877-9585
Fax: (813) 289-7948

GEORGIA

Forest Park 30297 (Atlanta)
5442 Frontage Road,
Suite 112
Phone: (404) 608-0006
Fax: (404) 608-1123

ILLINOIS

Addison 60101 (Chicago)
400 South Rohlwing Rd.
Phone: (630) 424-8805
Fax: (630) 424-8895

Woodridge 60517 (Chicago)
2033 West 75th Street
Phone: (630) 910-9200
Fax: (630) 910-0360

MARYLAND

Elkridge 21075 (Baltimore)
7397-102 Washington Blvd.
Phone: (410) 799-9394
Fax: (410) 799-9398

MASSACHUSETTS

Braintree 02185 (Boston)
719 Granite Street
Phone: (781) 848-9810
Fax: (781) 848-6759

Franklin 02038 (Boston)
Franklin Industrial Park
101E Constitution Blvd.
Phone: (508) 520-8802
Fax: (508) 528-8089

MICHIGAN

Madison Heights 48071 (Detroit)
30475 Stephenson Highway
Phone: (248) 597-5000
Fax: (248) 597-5004

MINNESOTA

Minneapolis 55429
5522 Lakeland Avenue North
Phone: (763) 561-9080
Fax: (763) 561-0653

MISSOURI

North Kansas City 64116
1141 Swift Avenue
Phone: (816) 221-2070
Fax: (816) 221-2897

St. Louis 63119
7574 Watson Road
Phone: (314) 968-8950
Fax: (314) 968-2790

NEW YORK

Flushing 11365-1595 (N.Y.C.)
175-25 Horace Harding Expwy.
Phone: (718) 225-2040
Fax: (718) 423-9619

NORTH CAROLINA

Charlotte 28270
9129 Monroe Road, Suite 115
Phone: (704) 841-1176
Fax: (704) 708-4625

OHIO

Columbus 43214
4560 Indianola Avenue
Phone: (614) 263-0929
Fax: (614) 263-1238

Cleveland 44125
8001 Sweet Valley Drive
Unit #19
Phone: (216) 447-9030
Fax: (216) 447-3097

OREGON

Portland 97230
4916 NE 122 nd Ave.
Phone: (503) 252-0107
Fax: (503) 252-2123

PENNSYLVANIA

Willow Grove 19090
520 North York Road
Phone: (215) 658-1430
Fax: (215) 658-1433

TEXAS

Carrollton 75006 (Dallas)
1300 Interstate 35 N, Suite 112
Phone: (972) 446-2996
Fax: (972) 446-8157

Houston 77038
4321 Sam Houston Parkway,
West
Suite 180
Phone: (281) 260-8887
Fax: (281) 260-9989

WASHINGTON

Auburn 98001 (Seattle)
3320 West Valley HWY, North
Building D, Suite 111
Phone: (253) 333-8353
Fax: (253) 333-9613

Authorized Service Stations are located in many large cities. Telephone **800-438-2486** or **731-541-6042** for assistance locating one. Parts and accessories for Porter-Cable-Delta products should be obtained by contacting any Porter-Cable-Delta Distributor, Authorized Service Center, or Porter-Cable-Delta Factory Service Center. If you do not have access to any of these, call **800-223-7278** and you will be directed to the nearest Porter-Cable-Delta Factory Service Center. Las Estaciones de Servicio Autorizadas están ubicadas en muchas grandes ciudades. Llame al **800-438-2486** ó al **731-541-6042** para obtener asistencia a fin de localizar una. Las piezas y los accesorios para los productos Porter-Cable-Delta deben obtenerse poniéndose en contacto con cualquier distribuidor Porter-Cable-Delta, Centro de Servicio Autorizado o Centro de Servicio de Fábrica Porter-Cable-Delta. Si no tiene acceso a ninguna de estas opciones, llame al **800-223-7278** y le dirigirán al Centro de Servicio de Fábrica Porter-Cable-Delta más cercano.

CANADIAN PORTER-CABLE • DELTA SERVICE CENTERS

ALBERTA

Bay 6, 2520-23rd St. N.E.
Calgary, Alberta
T2E 8L2
Phone: (403) 735-6166
Fax: (403) 735-6144

BRITISH COLUMBIA

8520 Baxter Place
Burnaby, B.C.
V5A 4T8
Phone: (604) 420-0102
Fax: (604) 420-3522

MANITOBA

1699 Dublin Avenue
Winnipeg, Manitoba
R3H 0H2
Phone: (204) 633-9259
Fax: (204) 632-1976

ONTARIO

505 Southgate Drive
Guelph, Ontario
N1H 6M7
Phone: (519) 767-4132
Fax: (519) 767-4131

QUÉBEC

1515 ave.
St-Jean Baptiste, Suite 160
Québec, Québec
G2E 5E2
Phone: (418) 877-7112
Fax: (418) 877-7123

1447, Begin
St-Laurent, (Montréal),
Québec
H4R 1V8
Phone: (514) 336-8772
Fax: (514) 336-3505

The following are trademarks of PORTER-CABLE-DELTA (Las siguientes son marcas registradas de PORTER-CABLE S.A.): Auto-Set®, BAMMER®, B.O.S.S.®, Builder's Saw®, Contractor's Saw®, Contractor's Saw II™, Delta®, DELTACRAFT®, DELTAGRAM™, Delta Series 2000™, DURATRAC™, Emc²™, FLEX®, Flying Chips™, FRAME SAW®, Homecraft®, INNOVATION THAT WORKS®, Jet-Lock®, JETSTREAM®, 'kickstand', LASERLOC®, MICRO-SET®, Micro-Set®, MIDI LATHE®, MORTEN™, NETWORK™, OMNIJIG®, POCKET CUTTER®, PORTA-BAND®, PORTA-PLANE®, PORTER-CABLE®&(design), PORTER-CABLE®PROFESSIONAL POWER TOOLS, Posi-Matic®, Q-3®&(design), QUICKSAND®&(design), QUICKSET™, QUICKSET II®, QUICKSET PLUS™, RIPTIDE™&(design), SAFE GUARD II®, SAFE-LOC®, Sanding Center®, SANDTRAP®&(design), SAW BOSS®, Sawbuck™, Sidekick®, SPEEDMATIC®, SPEEDTRONIC®, STAIR EASE®, The American Woodshop®&(design), The Lumber Company®&(design), THE PROFESSIONAL EDGE®, THE PROFESSIONAL SELECT®, THIN-LINE™, TIGER®, TIGER CUB®, TIGER SAW®, TORQBUSTER®, TORQ-BUSTER®, TRU-MATCH™, TWIN-LITE®, UNIGUARD®, Unifence®, UNIFEEDER™, Unihead®, Uniplane™, Unirip®, Unisaw®, Univise®, Versa-Feeder®, VERSA-PLANE®, WHISPER SERIES®, WOODWORKER'S CHOICE™.

Trademarks noted with ™ and ® are registered in the United States Patent and Trademark Office and may also be registered in other countries. Las Marcas Registradas con el signo de ™ y ® son registradas por la Oficina de Registros y Patentes de los Estados Unidos y también pueden estar registradas en otros países.

Free Manuals Download Website

<http://myh66.com>

<http://usermanuals.us>

<http://www.somanuals.com>

<http://www.4manuals.cc>

<http://www.manual-lib.com>

<http://www.404manual.com>

<http://www.luxmanual.com>

<http://aubethermostatmanual.com>

Golf course search by state

<http://golfingnear.com>

Email search by domain

<http://emailbydomain.com>

Auto manuals search

<http://auto.somanuals.com>

TV manuals search

<http://tv.somanuals.com>