



DVPCOPM-SL

CANopen Communication Module

Application Manual



<http://www.delta.com.tw/industrialautomation>

Warning

- ✓ Please read this instruction carefully before use and follow this instruction to operate the device in order to prevent damages on the device or injuries to staff.
- ✓ Switch off the power before wiring.
- ✓ DVPCOPM-SL is an OPEN TYPE device and therefore should be installed in an enclosure free of airborne dust, humidity, electric shock and vibration. The enclosure should prevent non-maintenance staff from operating the device (e.g. key or specific tools are required for operating the enclosure) in case danger and damage on the device may occur.
- ✓ DVPCOPM-SL is to be used for controlling the operating machine and equipment. In order not to damage it, only qualified professional staff familiar with the structure and operation of DVPCOPM-SL can install, operate, wire and maintain it.
- ✓ DO NOT connect input AC power supply to any of the I/O terminals; otherwise serious damage may occur. Check all the wirings again before switching on the power and DO NOT touch any terminal when the power is switched on. Make sure the ground terminal ⊕ is correctly grounded in order to prevent electromagnetic interference.

Table of Contents

1	INTRODUCTION.....	3
1.1	Features	3
1.2	Functions.....	4
2	PRODUCT PROFILE & OUTLINE	5
2.1	Dimension	5
2.2	Product Profiles.....	5
2.3	CANopen Connection Port.....	6
2.4	Address Switch.....	6
2.5	Function Switch.....	6
2.6	Digital Indicator.....	7
3	BASIC OPERATION.....	7
3.1	Connecting DVPCOPM-SL to DVP-SV MPU	7
3.2	Installing DVPCOPM-SL and DVP-SV MPU on DIN Rail.....	7
3.3	Connecting to CANopen Connection Port.....	8
4	CONSTRUCTING CANOPEN NETWORK.....	8
4.1	How to Construct a CANopen Network.....	8
4.2	Data Mapping in CANopen Network	10
4.3	How to Configure Network by Delta CANopenBuilder Software	11
4.4	Saving the Configuration Data	19
4.5	CANopen Network Control.....	19

5	SENDING SDO, NMT AND READING EMERGENCY BY LADDER DIAGRAM	20
5.1	The Principle.....	20
5.2	Structure of SDO Request Message.....	20
5.3	Structure of NMT Service Message	21
5.4	Structure of Emergency Request Message	22
5.5	Application Examples	23
6	LED INDICATOR & TROUBLE-SHOOTING	27
6.1	POWER LED	28
6.2	RUN LED	28
6.3	ERR LED	28
6.4	Codes in Digital Display	28

1 Introduction

1. To ensure correct installation and operation of DVPCOPM-SL, please read this chapter carefully before using your DVPCOPM-SL.
2. This chapter only provides introductory information on DVPCOPM-SL. For more detailed information on CANopen protocol, please refer to relevant references or literatures.
3. DVPCOPM-SL is a CANopen module operating on the left side of DVP-SV series PLC MPU. When DVP-SV is connected to CANopen network through DVPCOPM-SL, DVPCOPM-SL will serve as the data exchange interface between DVP-SV and other slaves on the bus. DVPCOPM-SL is in charge of sending the data in DVP-SV to the slaves on the bus, and at the same time collecting the data returned from each slave and sending them back to DVP-SV.

1.1 Features

DVPCOPM-SL can be used as the master in CANopen network, as well as the slave for other masters.

As a master, DVPCOPM-SL features:

- Complying with CANopen standard protocol DS301v4.02.
- Supporting NMT Master Service.
- Error control: Supporting Heartbeat/Node Guarding Protocol.
- Supporting PDO Service.
Max. 200 RxPDOs and 390 bytes of data
Max. 200 TxPDOs and 390 bytes of data
Each slave can be allocated maximum 8 TxPDOs and 8 RxPDOs.
- PDO transmission type: Supporting event trigger, time trigger, synchronous cycle, and synchronous non-cycle.
- PDO mapping: Every PDO is able to map maximum 32 parameters.

Type of mapping data supported:

Storage space	Data type
1 bit	BOOL
8 bits	SINT USINT BYTE
16 bits	INT UINT WORD
32 bits	DINT UDINT REAL DWORD
64 bits	LINT ULINT LREAL LWORD

- Supporting SDO Service.
Number of server: 0
Number of user: 3
- Supporting standard expedited SDO transmission mode.
- Supporting Auto SDO function. Able to execute maximum 20 Auto SDOs to each slave.
- Supporting reading/writing of data in slave by using SDO Service in the ladder diagram in PLC.
- Supporting Emergency Protocol:
Able to store 5 latest Emergency messages for each slave.
Able to indicate Emergency messages in slave from digital display.
Able to read Emergency message through the ladder diagram in PLC.
- SYNC producer; Range: 0 ~ 65,535ms.

- As the interface between Delta CANopenBuilder software and CANopen network. The software can configure the network directly through DVPCOPM-SL.
- In the auto data exchange with DVP-SV, the user only has to program the D register mapped in DVP-SV without applying FROM/TO instructions. When connected to DVP-SV/DVP-EH2-L MPU, registers after D6000 will be adopted temporarily.

As a slave, DVPCOPM-SL features:

- Complying with CANopen standard protocol DS301v4.02
- Supporting NMT Slave Service
- Error control: Supporting Heartbeat Protocol
- Supporting PDO Service: Each slave can be allocated maximum 8 TxPDOs and 8 RxPDOs.
- PDO transmission type: Supporting event trigger, time trigger, synchronous cycle, synchronous non-cycle.
- Supporting SDO Service.
Number of server: 1
Number of user: 0
- Supporting standard expedited SDO transmission mode.
- Supporting Emergency Protocol.
Able to indicate Emergency event in slave through digital display.
- In the auto data exchange with DVP-SV, the user only has to program the D register mapped in DVP-SV without applying FROM/TO instructions.

1.2 Functions

■ CANopen connection

Transmission method	CAN
Electrical isolation	500VDC
Interface	Removable connector (5.08mm)
Transmission cable	2-wire twisted shielded cable with 2-wire bus power and drain

■ Communication

Message type	PDO, SDO, SYNC (synchronous object), Emergency (Emergency object), NMT
Baud rates	10k, 20k, 50k, 125k, 250k, 500k, 800k, 1M bps (bit/sec)

■ Electrical specification

Power voltage	24VDC, supplied by internal bus from PLC MPU (-15% ~ 20%)
Power consumption	1.7W
Isolation voltage	500V

■ Environment

Noise immunity	ESD (IEC 61131-2, IEC 61000-4-2): 8KV Air Discharge, 4KV Contact Discharge EFT (IEC 61131-2, IEC 61000-4-4): Power Line: 2KV, Digital I/O: 1KV Analog & Communication I/O: 1KV Damped-Oscillatory Wave: Power Line: 1KV, Digital I/O: 1KV RS (IEC 61131-2, IEC 61000-4-3): 80MHz ~ 1,000MHz, 1.4GHz ~ 2.0GHz, 10V/m
----------------	---

Operation	0°C ~ 55°C (temperature); 50 ~ 95% (humidity); pollution degree 2
Storage	-25°C ~ 70°C (temperature); 5 ~ 95% (humidity)
Shock/vibration immunity	International standard: IEC 61131-2, IEC 68-2-6 (TEST Fc)/IEC 61131-2 & IEC 68-2-27 (TEST Ea)
Certificates	IEC 61131-2, UL508

2 Product Profile & Outline

DVPCOPM-SL is composed of CANopen connection port, address switch, function switch, and digital display.

2.1 Dimension

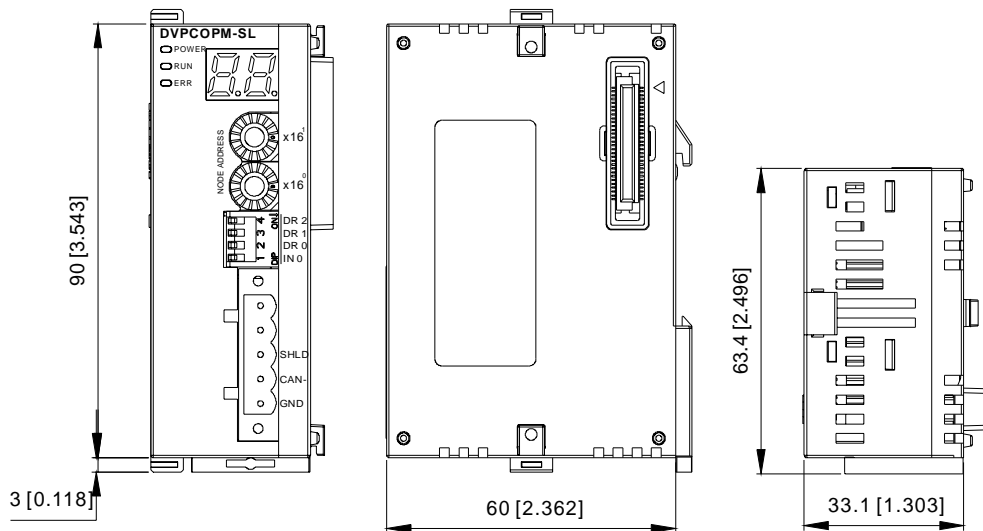

2.2 Product Profiles

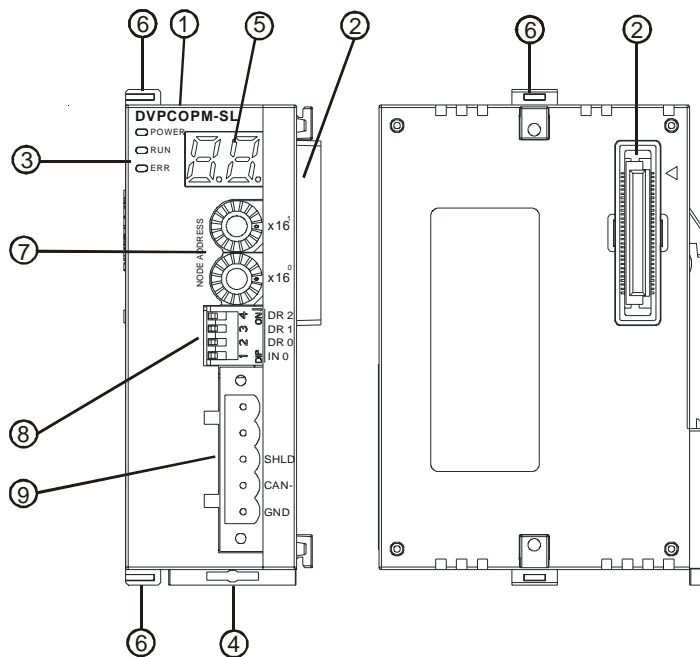

1. Model name	6. Fixing clip for extension module
2. Extension port	7. Address switch

3. POWER, RUN, ERR indicators	8. Function switch
4. DIN rail clip	9. CANopen connection port
5. Digital display	

2.3 CANopen Connection Port

The connector is used on the connection to CANopen network. Wire by using the connector enclosed with DVPCOPM-SL.

PIN	Signal	Content
1	GND	0 VDC
2	CAN_L	Signal-
3	SHLD	Shielded
4	CAN_H	Signal+
5	-	Reserved

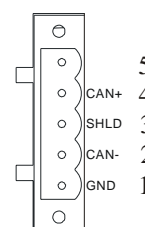

2.4 Address Switch

The switch is used on setting up the node address of DVPCOPM-SL on CANopen network. Range: 1 ~ 7F (0, 88 ~ FF are forbidden).

Switch setting	Content
1 ~ 7F	Valid CANopen node address
0, 80 ~ FF	Invalid CANopen node address

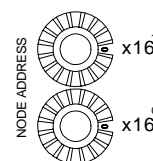

Example: If you need to set the node address of DVPCOPM-SL to 26 (1AH), simply switch the corresponding switch of $x16^1$ to 1 and the corresponding switch of $x16^0$ to A.

Note:

- Use slotted screwdriver to rotate the switch carefully in case you scratch the switch.
- Please set up the node address when the power is switched off. After the setup is completed, re-poser DVPCOPM-SL.

2.5 Function Switch

The switch is used on setting up the baud rate between DVPCOPM-SL and CANopen network (DR0 ~ DR2). See the table below for the baud rate and its maximum communication distance.

DR2	DR1	DR0	Baud rate (bps)	Max. communication distance (m)
OFF	OFF	OFF	10k	5,000
OFF	OFF	ON	20k	2,500
OFF	ON	OFF	50k	1,000
OFF	ON	ON	125k	500
ON	OFF	OFF	250k	250
ON	OFF	ON	500k	100
ON	ON	OFF	800k	50
ON	ON	ON	1M	25
IN0				Reserved

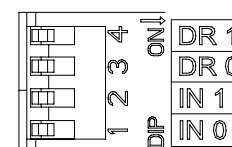

Note:

- Use slotted screwdriver to adjust the DIP switch carefully in case you scratch the switch.
- Please set up the function switch when the power is switched off. After the setup is completed, re-power DVPCOPM-SL.

2.6 Digital Indicator

The digital indicator provides the following two functions:

- Displaying the node address of DVPCOPM-SL.
- Displaying the error message of slave.

3 Basic Operation

3.1 Connecting DVPCOPM-SL to DVP-SV MPU

- Open the fixing clip on top and bottom of DVP-SV. Meet the extension port of DVPCOPM-SL with DVP-SV, as ①.
- Press the fixing clips on top and bottom of DVP-SV and check is the connection is fine, as ②.

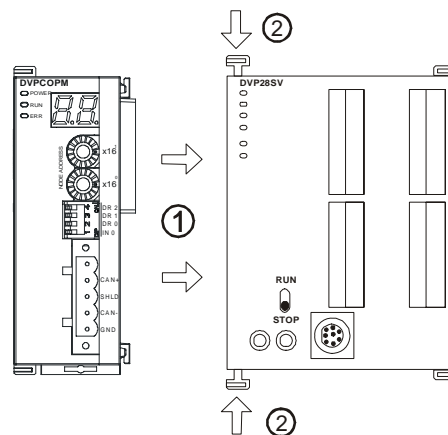

3.2 Installing DVPCOPM-SL and DVP-SV MPU on DIN Rail

- Use 35mm DIN rail
- Open the DIN rail clip on DVP-SV and DVPCOPM-SL. Insert DVP-SV and DVPCOPM-SL onto the DIN rail.
- Clip up the DIN rail clips on DVP-SV and DVPCOPM-SL to fix DVP-SV and DVPCOPM-SL on the DIN rail, as shown below.

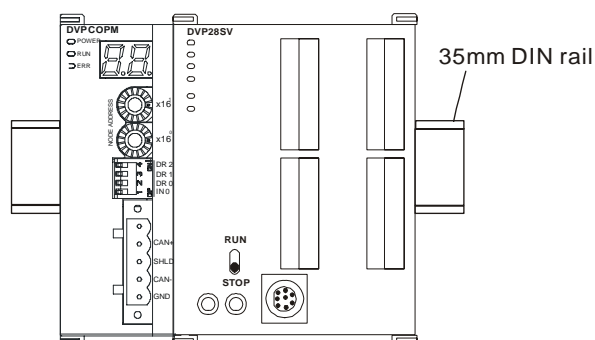

3.3 Connecting to CANopen Connection Port

- Please wire following the PIN definition of the connection port.
- There are two communication interfaces on DVP-SV to communicate with the PC. COM1 is the standard RS-232 interface, and COM2 RS-485. Both interfaces comply with Modbus protocol. The PC communicates directly to PLC through COM1.
- We recommend you also apply Delta's power module in the connection.

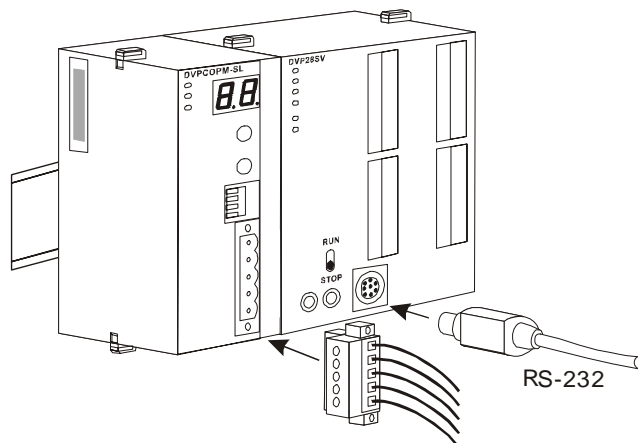

4 Constructing CANopen Network

In this section, we will introduce how to construct a complete CANopen network by using DVPCOPM-SL and other slaves.

Before constructing a network, you have to first know clearly what the network is for and start a preliminary planning for the data to be exchanged. The plan shall include the slaves to be used, type of transmission and the data to be exchanged, total length of data to be exchanged, requirement on the response time for data exchange, and so on. These information will decide whether the network you construct is a reasonable one, or if it satisfies your needs, and even affect the later-on network sustainability and flexibility of network capacity upgrade.

In the example below, we will illustrate how to control RUN/STOP and speed of a Delta ASD-B servo drive by a Delta digital I/O module DVP-08ST.

4.1 How to Construct a CANopen Network

Equipment and software required:

Equipemt & software	Function
DVP-PS02	24V power supply module, supplying CANopen network.
DVP-PS01	24V power supply module, supplying DVP-12SA and remote I/O
DVP-28SV	DVP-SV PLC MPU
DVPCOPM-SL	CANopen master
DVP-12SA	DVP-SA PLC MPU
DVP-08ST	Digital I/O module
IFD9503	CANopen bus adapter
ASD-B	Delta B series servo drive
WPLSoft	DVP series PLC programming software

Equipemt & software	Function
Delta CANopenBuilder	CANopen configuration software for DVPCOM-SL master

- Set up DVPCOPM-SL and IFD9503 according to the table below. For how to operate IFD9503, please refer to Chapter 13.

Module	Node address	Baud rate (bps)
DVPCOPM-SL	01	1M
IFD9503	02 (connected to ASD-B)	1M
IFD9503	03 (connected to DVP-12SA)	1M

Set up ASD-B as follows:

Parameter	Set value	Explanation
P1-01	02	Control mode: speed mode
P1-09	100 (rpm)	Internal speed command 1 (SP1)
P1-10	300 (rpm)	Internal speed command 2 (SP2)
P1-11	500 (rpm)	Internal speed command 3 (SP3)
P2-10	101	Function of DI1: Servo on
P2-11	114	Functin of DI2: SPD0
P2-12	115	Functino of DI3: SPD1
P2-18	102	Function of DO1: Output when servo on
P3-00	1	Modbus communication address
P3-01	5 (115,200 bps)	Modbus baud rate
P3-02	1 (7,E,1)	Modbus data format
P3-06	3F	DI1 ~ DI6 controlled by communication

- Constructing the CANopen network following the figure below.

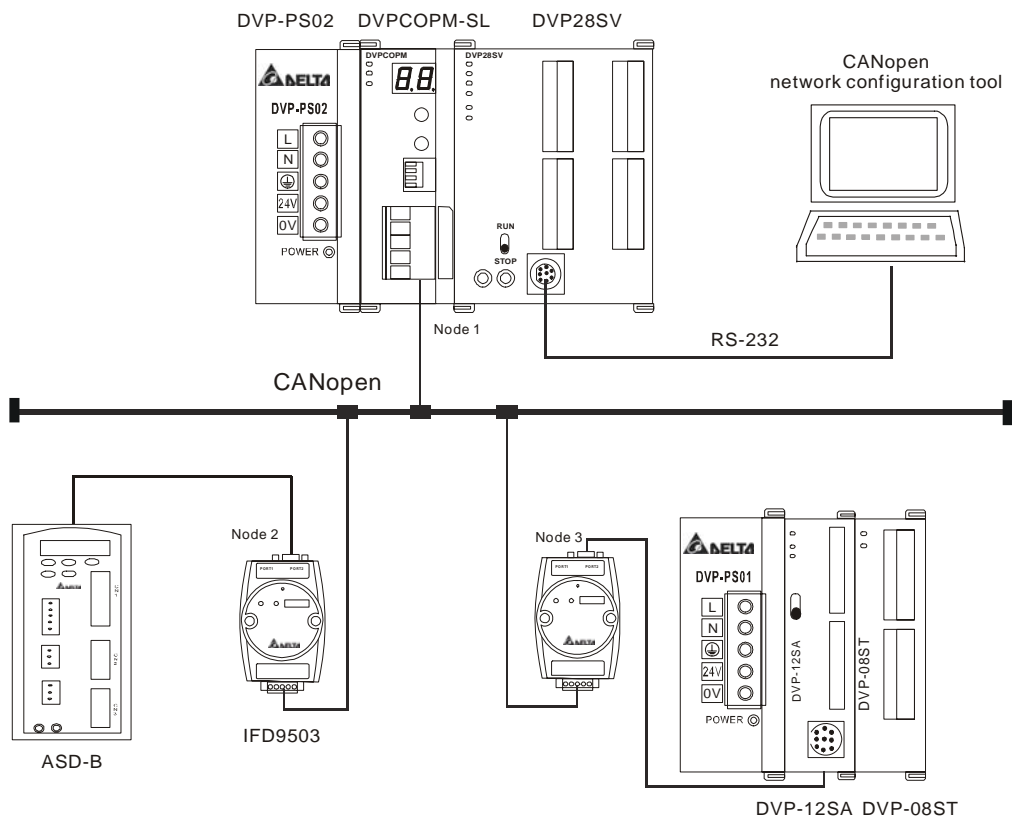

About the connection between IFD9503 and PLC, IFD9503 and ASD-B, or IFD9503 and other equipment, please refer to Chapter 13. For the electrical specifications of ASD-B, please refer to ASD-B user manual.

4.2 Data Mapping in CANopen Network

- Data mapping in DVP-12SA

DVP-08ST, connected on the right hand side of DVP-12SA, offers 8 channels of digital input and 1 byte of input data. In this example, we will use X0 and X1 on DVP-08ST to RUN/STOP ASD-B and select speed. Y0 is for the output signal of ASD-B operational status. See the table below for more information.

Channel	Function
X0	Controlling RUN/STOP of ASD-B
X1, X2	Selecting the speed of ASD-B: X2 = 0, X1 = 1, selecting SP1 X1 = 1, X2 = 0, selecting SP2 X1 = 1, X2 = 1, selecting SP3
Y0	Operational status of ASD-B: On: RUN Off: STOP

Supposed IFD9503 is connected to DVP-12SA and exchanging data with DVPCOPM-SL master, the default length of input data is 8 bytes and output data is 8 bytes. D256 in DVP-12SA is the start device for input data, and D0 is the start device for output data. To realize the control function of X0, X1 and X2, we place the statuses of X0 ~ X2 to bit 0 ~ 2 of D256. That is, when X0 = On, bit 0 of D256 will become 1. When X1 = On, bit 1 of D256 will become 1. In this way, we can realize the control of RUN, STOP and speed of ASD-B by the changes in D256 through WPLSoft. The status word in ASD-B will then be sent to D0. That is, when bit 0 of D0 becomes 1, there will be signals at Y0.

I/O data area for DVPCOPM-SL master:

	D register	15	14	13	12	11	10	9	8	7	6	5	4	3u,3	2	1	0	
Input data	D6032	D256														X2	X1	X0
	D6033	D257																
	D6034	D258																
	D6035	D259																
	...																	

Output data	D6282	D0															Y0	
	D6283	D1																
	D6284	D2																
	D6285	D3																
	...																	

- Data mapping in ASD-B

In this example, IFD9503 is the interface between ASD-B and CANopen network. In default setting, IFD9503 offers 1 word of input data and 1 word of output data to exchange data with DVPCOPM-SL master. See the table below for the relation between the parameters in ASD-B and the input and output data in DVPCOPM-SL master.

	D register	15	14	13	12	11	10	9	8	7	6	5	4	3	2	1	0
Input data	D6036	Multi-function digital output															

Output data	D6286	Multi-function digital input															
-------------	-------	------------------------------	--	--	--	--	--	--	--	--	--	--	--	--	--	--	--

4.3 How to Configure Network by Delta CANopenBuilder Software

- Using CANopenBuilder to scan the network
 - (1) Open CANopenBuilder software, as below:

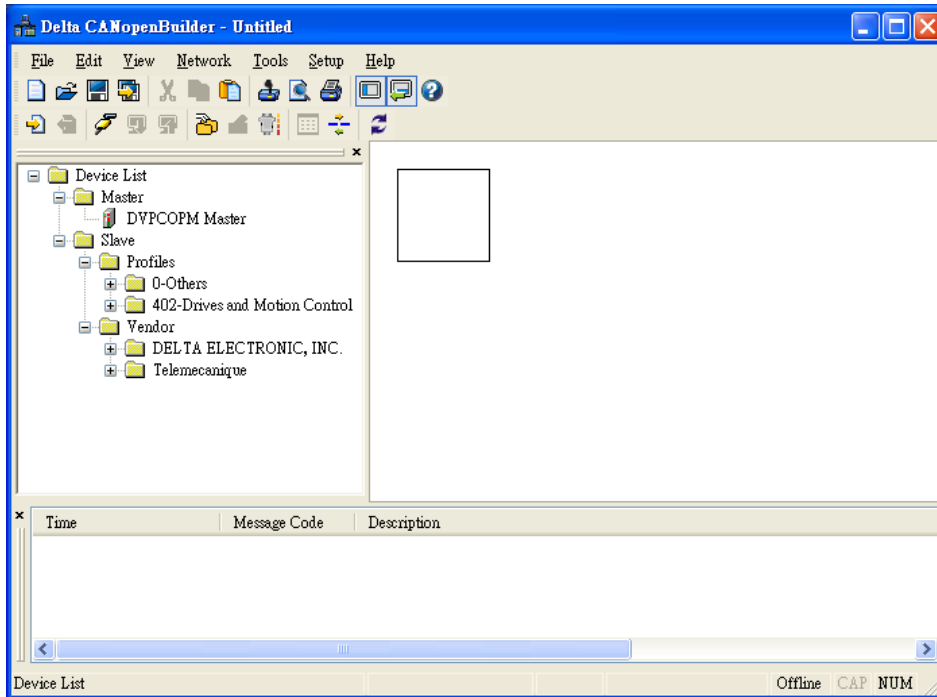

- (2) Select "Setup" => "Communication Setting" => "System Channel", and the "Serial Port Setting" dialog box will appear.

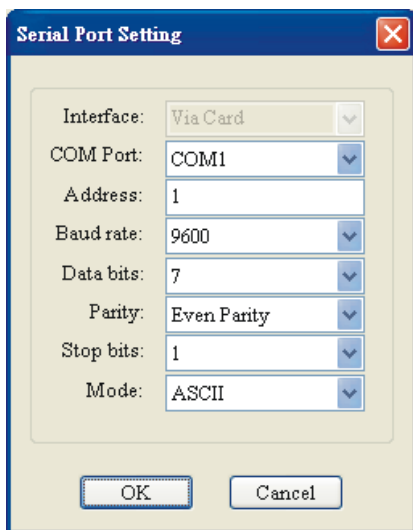

- (3) Set up the communication parameters in the PC and DVP-SV, e.g. the communication port, address, baud rate and communication format.

Item	Function	Default
COM Port	COM port on the PC to be used to communicate	COM1

Item	Function	Default
	with DVP-SV	
Address	Communication address of DVP-SV	1
Baud rate	Communication speed between the PC and DVP-SV	9,600 (bps)
Data Bits	Communication protocol between the PC and DVP-SV	7
Parity		Even Parity
Stop Bit		1
Mode	Communication mode between the PC and DVP-SV	ASCII

Click on "OK" and return to the main page.

- (4) Select "Network" => "Online", and the "Select Communication Channel" dialog box will appear. In this example, if the connection with DVP-SV is in normal status, you will see the screen as below.

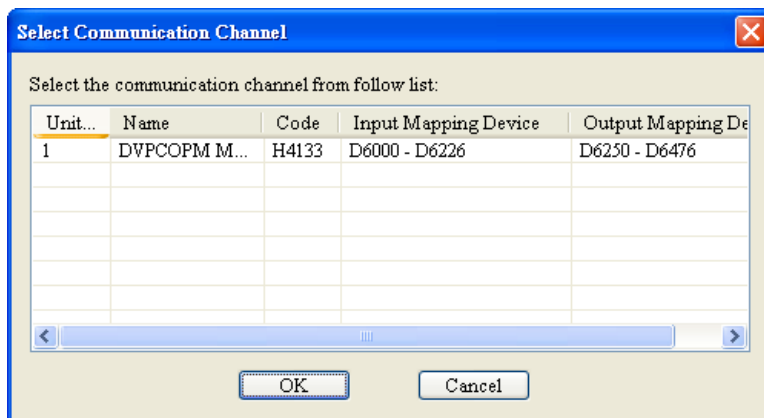

If there are more than one DVPCOPM-SL modules (less than 8) connected to the left side of DVP-SV and supposed there are two connected in this example, after clicking on "Online", you will see the screen as below. The DVPCOPM-SL which is closest to DVP-SV is regarded the first module, and so on.

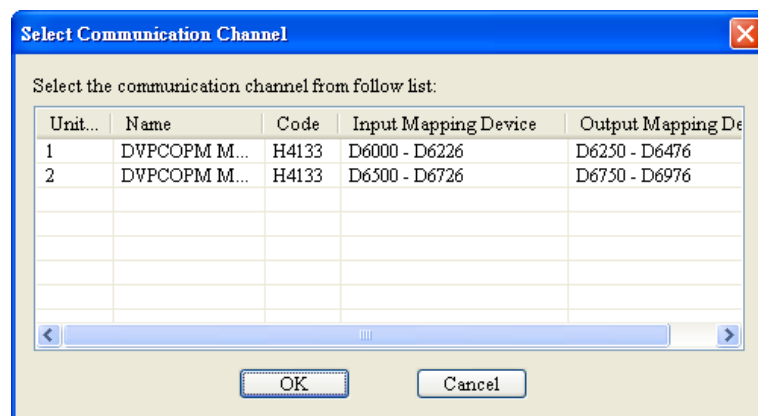

- (5) Select the DVPCOPM-SL which needs to establish the communication. Click on "OK" and start to scan all the slaves on the network. If the network installation and power supply are normal, you will see the screen as below.

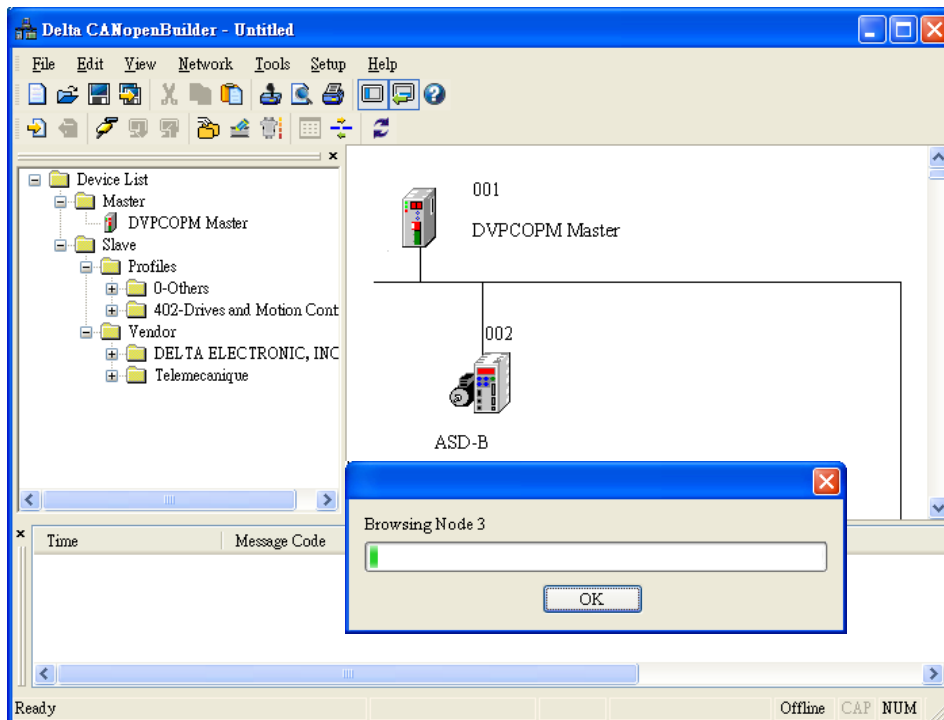

(6) In normal condition, after the scan is over, you will find the master and all the slaves displayed in CANopen network, as below.

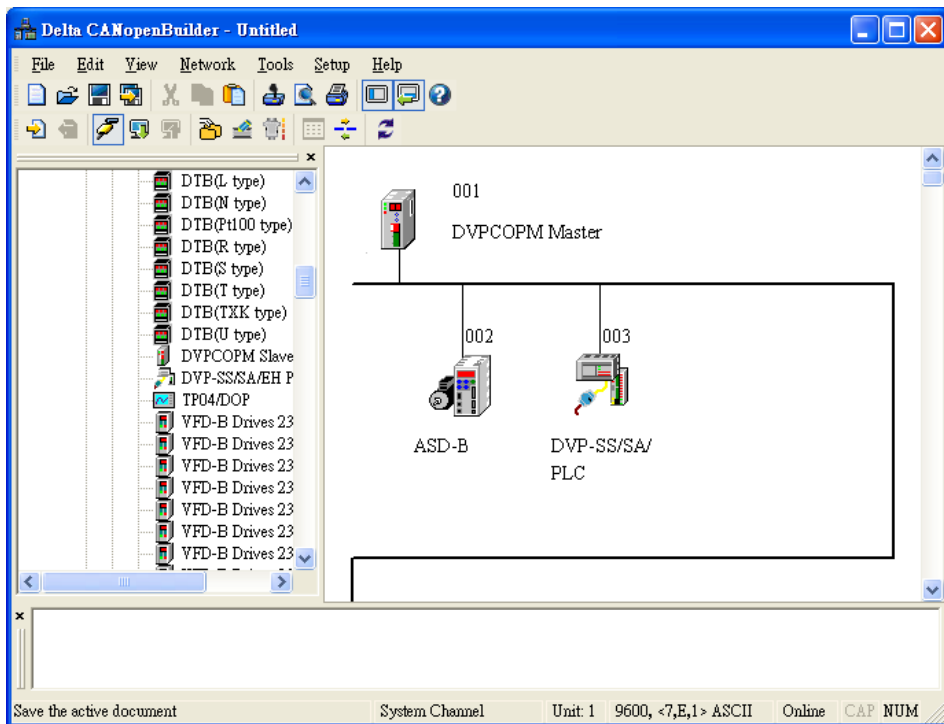

- Setting up parameters in CANopen master
Select "Network" => "Master Parameter", and you will see the dialog box as below.

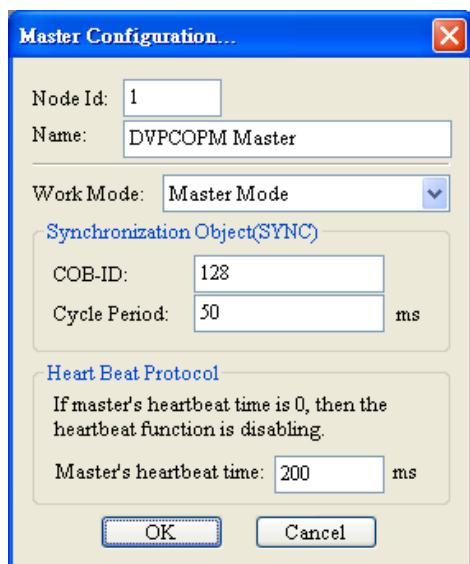

Work Mode: The work mode of DVPCOPM-SL. You can select either “Master Mode” or “Slave Mode”.

Cycle Period: The period of sending synchronous information.

Master’s heartbeat time: Time for DVPCOPM-SL to send out heartbeat.

After all the parameters are set up, click on “OK”.

- Setting up parameters in CANopen slave

Take the parameter settings in ASD-B for example:

(1) Double click on ASD-B, and you will see the dialog box as below.

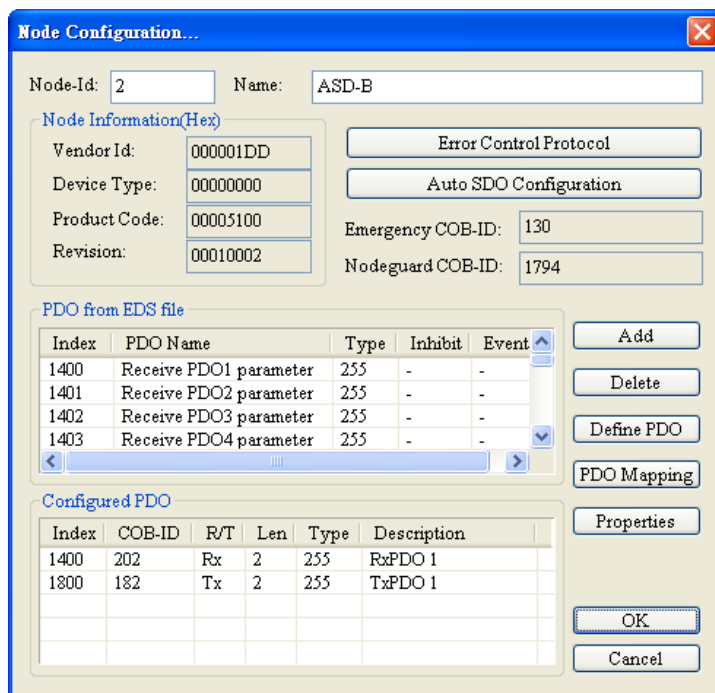

(2) Relevant parameter settings

Error Control Protocol: In the “Node Configuration...” page, click on “Error Control Protocol”, and you will see the dialog box appearing as below.

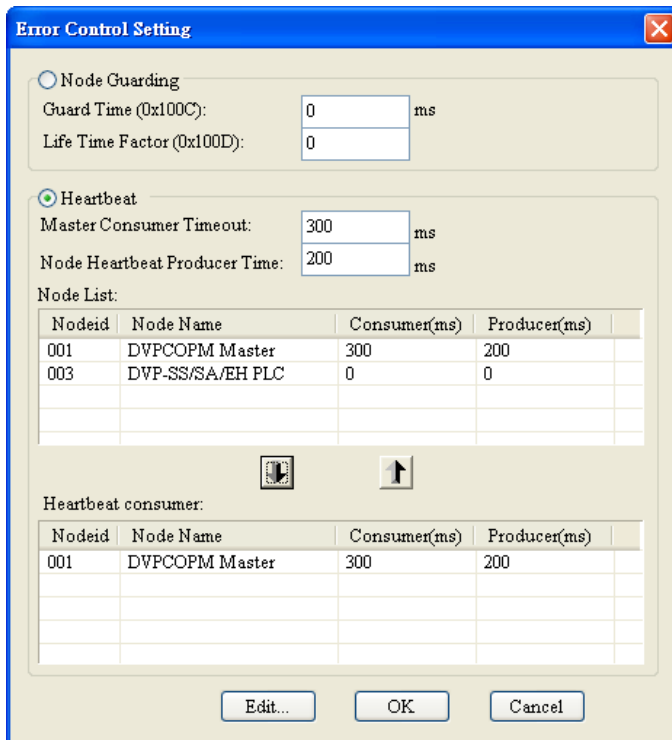

In this page, you can set up parameters for error control, e.g. “Master Consumer Timeout” and “Node Heartbeat Producer Time”. Please note that the value of “Master Consumer Timeout” shall be bigger than the value of “Node Heartbeat Producer Time”. After you have set up the heartbeat function, and the slave turns off-line and does not turn on-line within “Master Consumer Timeout”, the master will consider the slave off-line. If “Heartbeat” is selected, you cannot select “Node Guarding”. In “Heartbeat consumer”, you can add devices into the node list. Add a device A, and the slave will be able to monitor whether device A is on-line. Select a device and click on “Edit...” to modify the “Consumer” and “Producer” value.

Auto SDO Configuration: In the “Node Configuration” page, click on “Auto SDO Configuration”, and you will see the page as below.

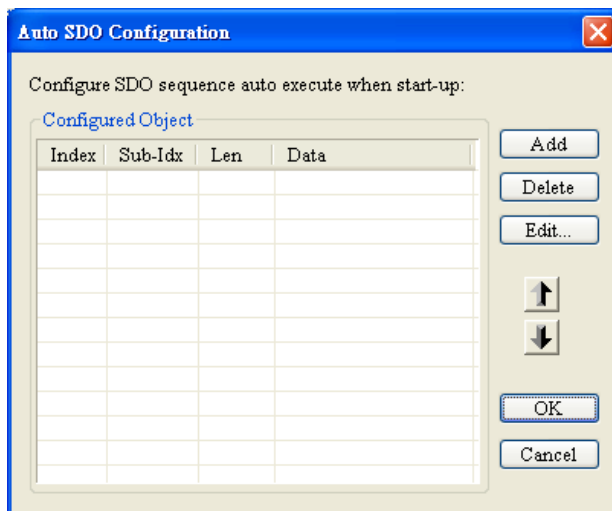

Click on “Add” to edit Auto SDO. Click on “Edit” to modify the Auto SDO selected. Please note that the Auto SDO cannot be longer than 8 bytes, and every slave is able to possess maximum 20 auto SDOs.

PDO mapping: In the “Node Configuration...” page, select a TxPDO or RxPDO in “Configured

PDO” and click on “PDO Mapping”, and you will enter the “PDO Mapping...” page as below. You can add the parameters in “Available Objects from EDS file” into “Mapped Objects”. The total length of the parameters added in each PDO cannot exceed 8 bytes. After the configuration is completed, click on “OK”.

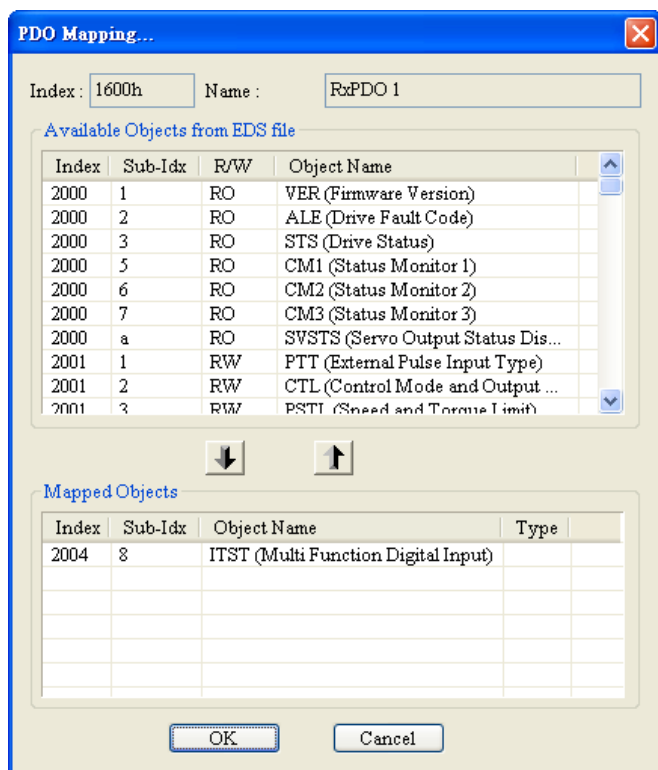

In the “Node Configuration...” page, click on “Properties” to enter the “PDO Properties” page and modify COB-ID and Transmit type. After the configuration is completed, click on “OK”. In the “Node Configuration...” page, click on “Define PDO” to self define RxPDO or TxPDO.

In this example, we adopt the default configuration. Finally, click “OK” in the “Node Configuration...” page.

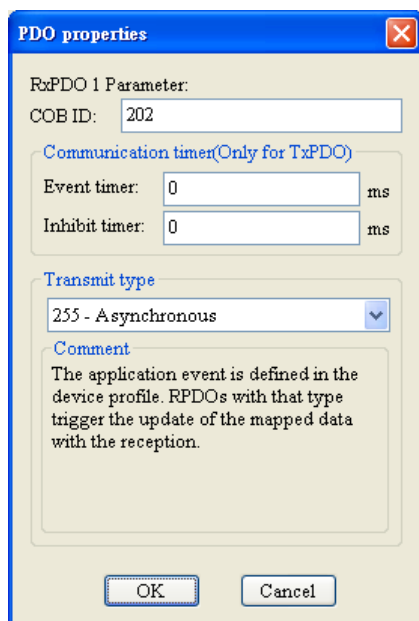

- Node List Setting

registers in DVP-SV from the Output Table and Input Table below. Click on “OK” to complete setting up the node list.

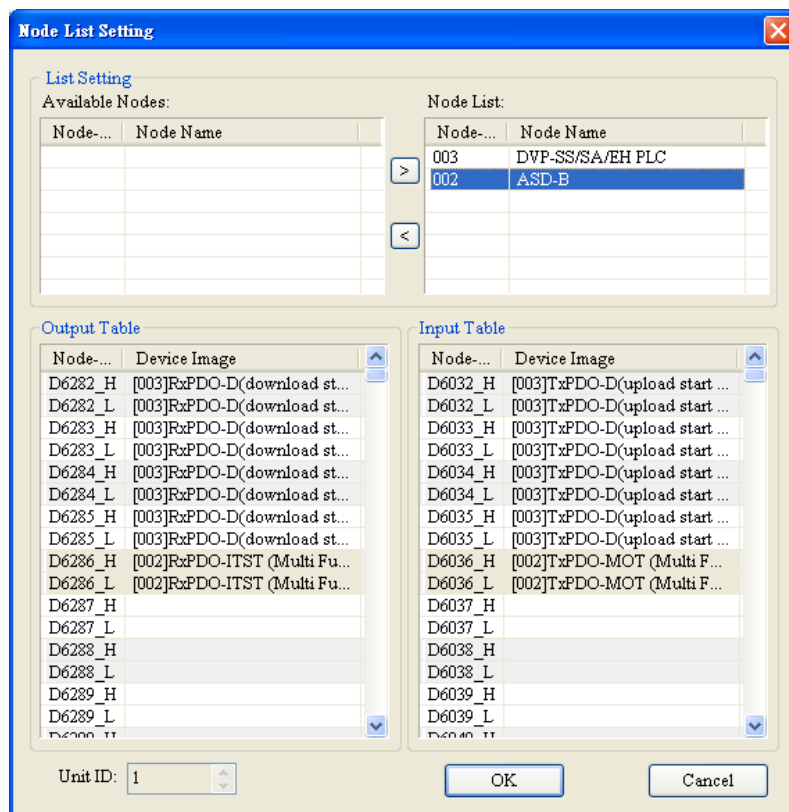

- Downloading the data to the master

Select “Network” => “Download” to download the configuration data to DVPCOPM-SL master. If the PLC is in RUN status at this moment, you will be given a warning saying that you have to stop the operation before the download.

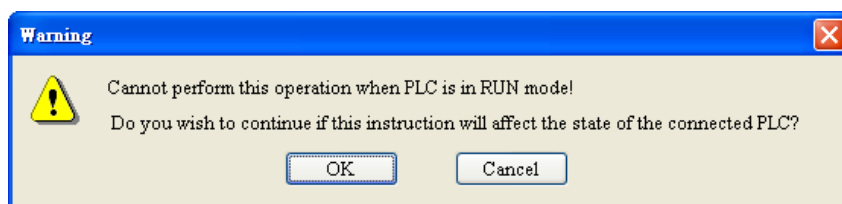

Click on “OK” to stop the PLC and start to download the data to the master.

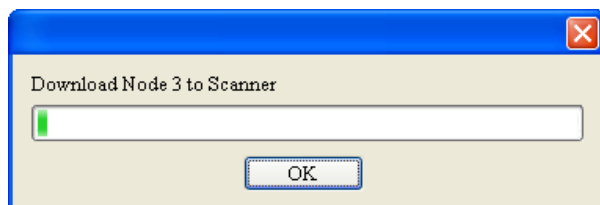

After the download is completed, you will be given another warning, asking you if you would like to run the PLC again. Click on “OK” to restart the PLC program, or click on “Cancel” to stop the PLC.

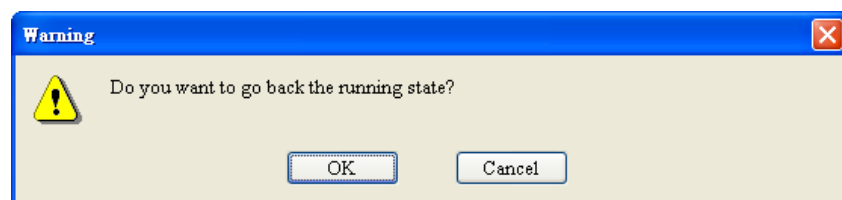

4.4 Saving the Configuration Data

Select "File" => "Save" to save the current configuration data.

4.5 CANopen Network Control

In this section, we will introduce how to compile WPL program and control CANopen network.

- Target:
 1. When SW0 on Slave 3 is closed, the servo drive on Slave 2 will start to run.
 2. When SW0 on Slave 3 is open, the servo drive on Slave 2 will stop.
 3. When the status of SW1 and SW2 on Slave 3 is switched, the running speed of servo drive on Slave 2 can be modified.
 4. When the servo drive is running, the signal LED on Slave 2 will be On.
 5. When the servo drive stops, the signal LED on Slave 2 will be Off.
- The program in DVP-SV MPU (master):

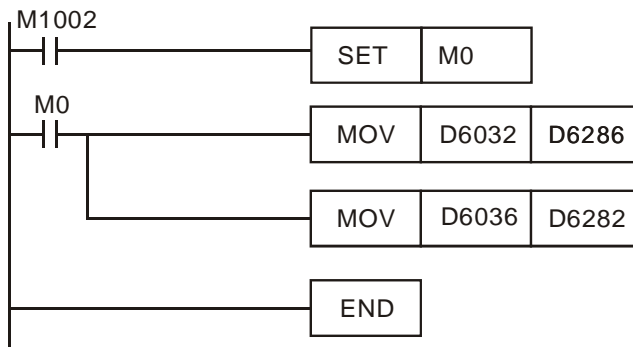

- Program explanations:
 1. The 2nd row of the program indicates sending the content of D256 in DVP-SA (mapped on D6032 of DVP-SV) to the control word (Multi-Function Digital Input, mapped on D6286 of DVP-SV) of the servo drive.
 2. The 3rd row of the program indicates sending the output status of the servo drive (Multi-Function Digital Output, mapped on D6036 of DVP-SV) to D0 in DVP-SA (mapped on D6282 of DVP-SV).
- The program in DVP-SA MPU (slave):

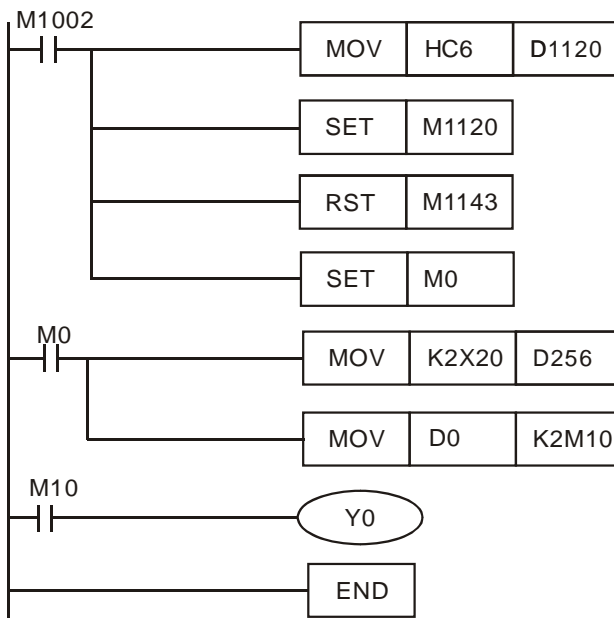

- Program explanations:
 1. The first 3 rows of the program set up the communication format between DVP-SA and IFD9503, which is 115,200bps, 7E1-ASCII; communication port is COM2.
 2. When M0 = On, send the input status of X20 ~ X28 on DVP-08ST to D256, and send the data in b0 ~ b15 of D0 to M10 ~ M25.
 3. When D0 = 1, M10 will be On, and Y0 on DVP-SA MPU will output.

5 Sending SDO, NMT and Reading Emergency by Ladder Diagram

5.1 The Principle

See the chart below for sending SDO by WPL program:

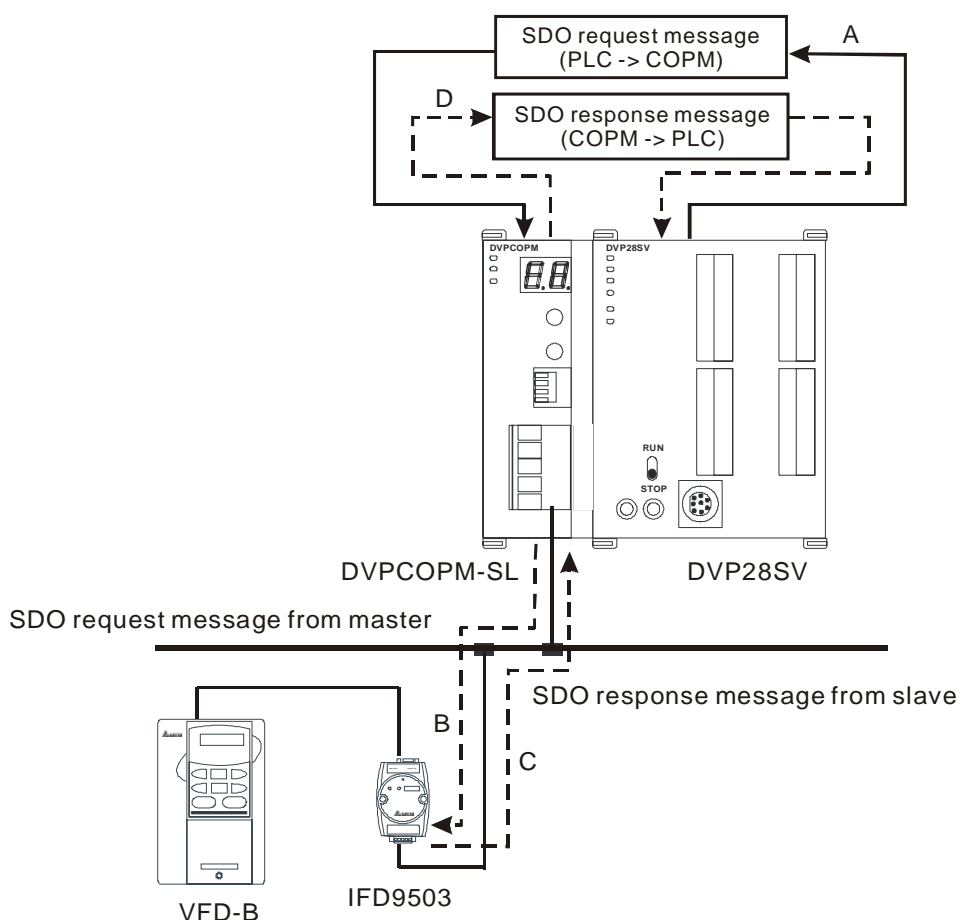

- A: DVP-SV sends out request message to DVPCOPM-SL (master).
- B: DVPCOPM-SL (master) sends out request message to the target equipment.
- C: The target equipment processes the request message and sends the response message to DVPCOPM-SL.
- D: DVP-SV receives SDO, NMT and Emergency data.

5.2 Structure of SDO Request Message

You can edit SDO, NMT and Emergency in “request message editing area”. Take the first DVPCOPM-SL master placed on the left hand side of DVP-SV for example. See the table below for the corresponding relation between “request message editing area” and “response message editing area” and the devices in PLC.

PLC device	Editing area	Editing length
D6000 ~ D6031	SDO response message and Emergency response message	64 bytes
D6250 ~ D6281	SDO request message, NMT service message and Emergency request message	64 bytes

See the table below for the format of SDO request message:

PLC device	Request Message																
		15	14	13	12	11	10	9	8	7	6	5	4	3	2	1	0
D6250	Message Header	ReqID								Command							
D6251		Reserved								Size							
D6252		Type								MAC ID							
D6253	Message Data	High byte of main index								Low byte of main index							
D6254		Reserved								Sub index							
D6255		Datum 1								Datum 0							
D6256		Datum 3								Datum 2							
D6257 ~ D6281		Reserved															

- Command: Fixed to "01Hex".
- ReqID: The request ID. Whenever an SDO request message is sent out, the message will be given a ReqID for CANopen master to identify. For the next request message to be sent out, you have to change the ID number. Range of ReqID: 00Hex ~ FFHex.
- Size: The length of the message. Max. 8 bytes. Unit: byte.
- MAC ID: The node address of the target equipment on CANopen network.
- Type: In SDO request message, 01Hex refers to SDO read message service; 02Hex refers to SDO write message service; 4FHex refers to read 1 byte of data; 60Hex refer to write 1/2/4 byte(s) of data; 80Hex refers to end SDO command. For example, if the type is 02Hex in SDO request message, it will become 60Hex for SDO response message when the writing of data is successful.
- Status code:

Status code	Explanation
0	No data transmission request
1	SDO data transmission is successful.
2	SDO data is being transmitted.
3	Error: SDO transmission time-out
4	Error: Illegal command
5	Error: Size of request message is illegal.
6	Error: Size of response message is illegal.
7	Error: Equipment to be sent messages is busy.
8	Error: Illegal type
9	Error: Incorrect node address
0A	Error message (See the error code for SDO response message)
0B ~ FF	Reserved

5.3 Structure of NMT Service Message

You can send the NMT request message to D6250 ~ D6281, and the slave will not respond with a message.

PLC device	Request Message																
		15	14	13	12	11	10	9	8	7	6	5	4	3	2	1	0
D6250	Message Header	ReqID								Command							
D6251		Reserved								Size (fixed to 04Hex)							
D6252		Type (fixed to 03Hex)								MAC ID							
D6253	Message Data	Reserved								NMT service code							
D6254		Reserved								MAC ID							

- Command: Fixed to "01Hex".
- ReqID: The request ID. Whenever an NMT request message is sent out, the message will be given a ReqID for the CANopen master to identify. For the next NMT request message to be sent out, you have to change the ID number. Range of ReqID: 00Hex ~ FFHex.
- MAC ID: The node address of the target equipment on CANopen network.
- NMT service code
- 01Hex: Enable remote node; 02Hex: Disable remote node; 80Hex: Enter pre-operational status; 81Hex: Reset application; 82Hex: Reset communication

Example: If you would like to stop node 03 equipment on CANopen network, you have to set NMT service code to "02Hex" and MAC ID to "03".

5.4 Structure of Emergency Request Message

See the table below for the format of Emergency request message:

PLC device	Request Message																
		15	14	13	12	11	10	9	8	7	6	5	4	3	2	1	0
D6250	Message Header	ReqID								Command							
D6251		Reserved								Size (fixed to 0)							
D6252		Type (fixed to 04Hex)								MAC ID							
D6253 ~ D6281	Message Data	Reserved															

See the table below for the format of Emergency response message:

PLC device	Response Message																
		15	14	13	12	11	10	9	8	7	6	5	4	3	2	1	0
D6000	Message Header	ReqID								Status							
D6001		Reserved								Size (2A Hex)							
D6002		Type (04Hex)								MAC ID							
D6003	Message Data	Total number of data								Number of data stored							
D6004		Datum 1								Datum 0							
D6005		Datum 3								Datum 2							
D6006		Datum 5								Datum 4							
D6007		Datum 7								Datum 6							
D6008 ~ D6011		Emergency2															
D6012 ~ D6015		Emergency3															
D6016 ~ D6019	Emergency4																

PLC device	Response Message														
	15	14	13	12	11	10	9	8	7	6	5	4	3	2	1
D6020~ D6023	Emergency5														
D6024~ D6031	Reserved														

- Command: Fixed to "01Hex".
- ReqID: The request ID. Whenever an Emergency message is sent out, the message will be given a ReqID for the CANopen master to identify. For the next Emergency message to be sent out, you have to change the ID number. Range of ReqID: 00Hex ~ FFHex.
- MAC ID: The node address of the target equipment on CANopen network.
- Total number of data: The total number of Emergency messages CANopen master receives.
- Number of data stored: The latest number of Emergency messages CANopen master receives. (Every slave gives less than 5 messages.)

Note:

- CANopen master can only send out 1 SDO, NMT or Emergency request message to one equipment at a time.
- When you use WPL program to send out SDO, NMT or Emergency request messages, we recommend you clear the "request message editing area" and "response message editing area" to 0.

5.5 Application Examples

In this section, we will illustrate how to compile a WPL program to send out SDO and NMT messages or readEmergency request messages.

■ Example I

- Target:

When M0 = On, read the content of index 2021, sub index 4 (i.e. actual output value of AC motor drive) in IFD9503.

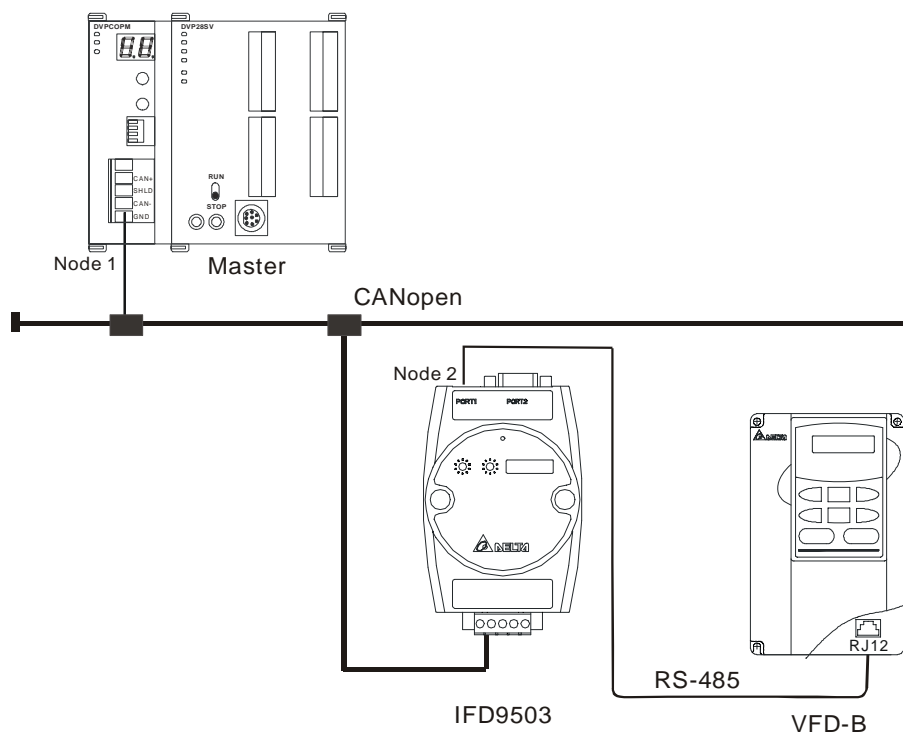

Required settings in DVPCOPM-SL:

Parameter	Setting	Explanation
Node address	01	Set the node address of DVPCOPM-SL to "01".
Baud rate	1 Mbps	Set the communication speed between DVPCOPM-SL and bus to "1 Mbps".

Required settings in IFD9503:

Parameter	Setting	Explanation
Node address	02	Set the node address of IFD9503 to "02".
Baud rate	1 Mbps	Set the communication speed between IFD9503 and bus to "1 Mbps".

Required settings in VFD-B AC motor drive:

Parameter	Setting	Explanation
02-00	04	The main frequency is operated by RS-485 interface.
02-01	03	The running command is operated by communication interface. Operation by keys is valid.
09-00	01	Communication address of VFD-B: 01
09-01	03	Baud rate: 38,400 bps
09-04	03	Modbus RTU mode, format <8, N, 2>

Devices in PLC:

PLC device	Content	Explanation															
		15	14	13	12	11	10	9	8	7	6	5	4	3	2	1	0
SDO request message editing area	D6250	ReqID = 01Hex								Command = 01Hex							
	D6251	Reserved								Size = 04Hex							
	D6252	Type = 01Hex								MAC ID = 02Hex							
	D6253	High byte of index = 20Hex								Low byte of index = 21Hex							
	D6254	Reserved								Sub index = 04Hex							
SDO response message editing area	D6000	ReqID = 01Hex								Status = 01Hex							
	D6001	Reserved								Size = 06Hex							
	D6002	Type = 4BHex								MAC ID = 02Hex							
	D6003	High byte of index = 20Hex								Low byte of index = 21Hex							
	D6004	Reserved								Sub index = 04Hex							
	D6005	Datum 1= 01Hex								Datum 0 = 00Hex							

🔗 0100Hex in D6005 refers to the actual output frequency of the AC motor drive is 2.56Hz.

- PLC program

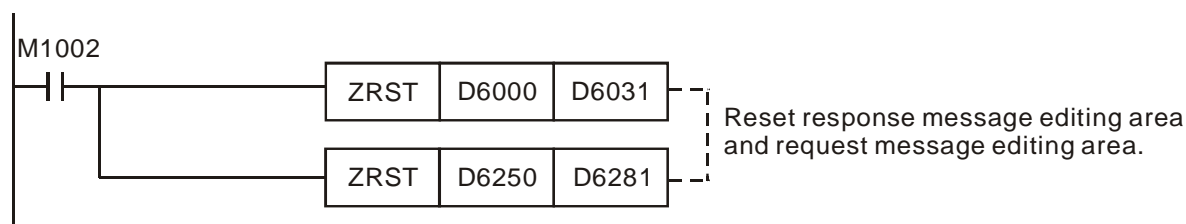

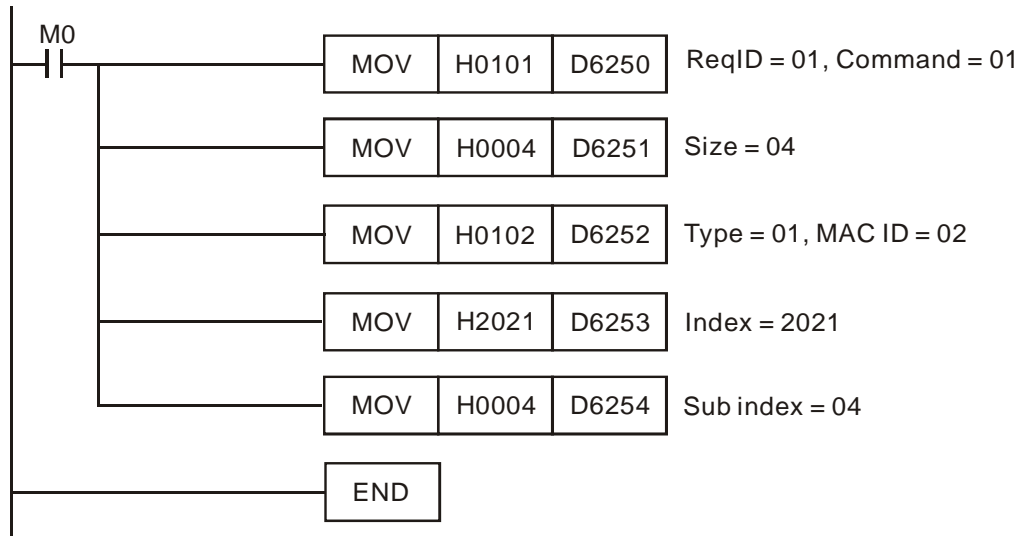

● Program explanation

1. The program first reset the SDO request message editing area and SDO response message editing area to 0.
2. When M0 = On, CANopen master will send out SDO request message and read the contents in index 2021, sub index 4 of the target equipment (at node address 02). If the communication is successful, the slave will return with the response message.
3. When M0 = On, CANopen master will send out request message only once. If you would like it to send out messages again, you will have to change the ReqID.
4. The messages returned from the target equipment are stored in D6000 ~ D6005.

■ Example II

● Target:

When M0 = On, set the content in index 2047, sub index 2 (i.e. the control word of the target temperature) in IFD9503 to 0104Hex (i.e. 26.0°C). Please note that you have to write 0401Hex into D6255 of the PLC.

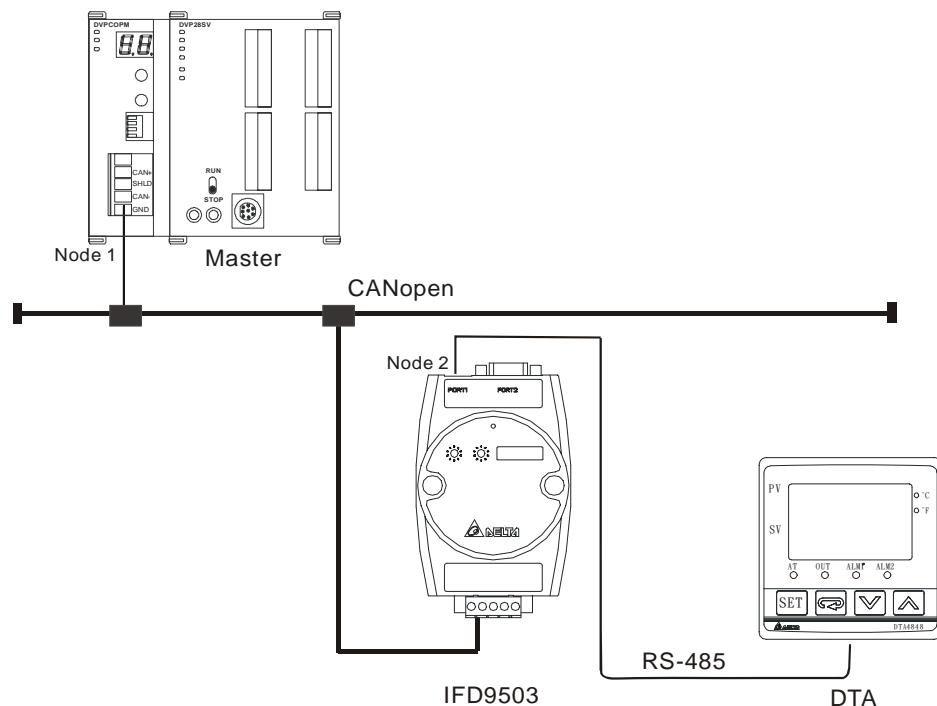

Required settings in DVPCOPM-SL:

Parameter	Setting	Explanation
Node address	01	Set the node address of DVPCOPM-SL to "01".
Baud rate	1 Mbps	Set the communication speed between DVPCOPM-SL and the bus to "1 Mbps".

Required settings in IFD9503:

Parameter	Setting	Explanation
Node address	02	Set the node address of IFD9503 to "02".
Baud rate	1 Mbps	Set the communication speed between IFD9503 and the bus to "1 Mbps".

Required settings in DTA temperature controller:

Parameter	Setting	Explanation
COSH	On	C WE: Enable/disable communication write-in
C-SL	ASCII	C-SL: Select ASCII or RTU format
C-no	1	C NO: Set up communication address
bPS	38400	BPS: Set up communication speed
LEn	7	LENGTH: Set up data length
Prty	E	PARITY: Set up parity bit
StoP	1	STOP BIT: Set up stop bit
EPUn	°C	UNIT: Select temperature unit, °C or °F

Devices in PLC

PLC device	Content	Explanation															
		15	14	13	12	11	10	9	8	7	6	5	4	3	2	1	0
SDO request message editing area	D6250	ReqID = 01Hex								Command = 01Hex							
	D6251	Reserved								Size = 06Hex							
	D6252	Type = 02Hex								MAC ID = 02Hex							
	D6253	High byte of index = 20Hex								Low byte of index = 47Hex							
	D6254	Reserved								Sub index = 02Hex							
	D6255	Datum 1= 04Hex								Datum 0= 01Hex							
SDO response message editing area	D6000	ReqID = 01Hex								Status = 01Hex							
	D6001	Reserved								Size = 04Hex							
	D6002	Type = 60Hex								MAC ID = 02Hex							
	D6003	High byte of index = 20Hex								Low byte of index = 47Hex							
	D6004	Reserved								Sub index = 02Hex							

- PLC program

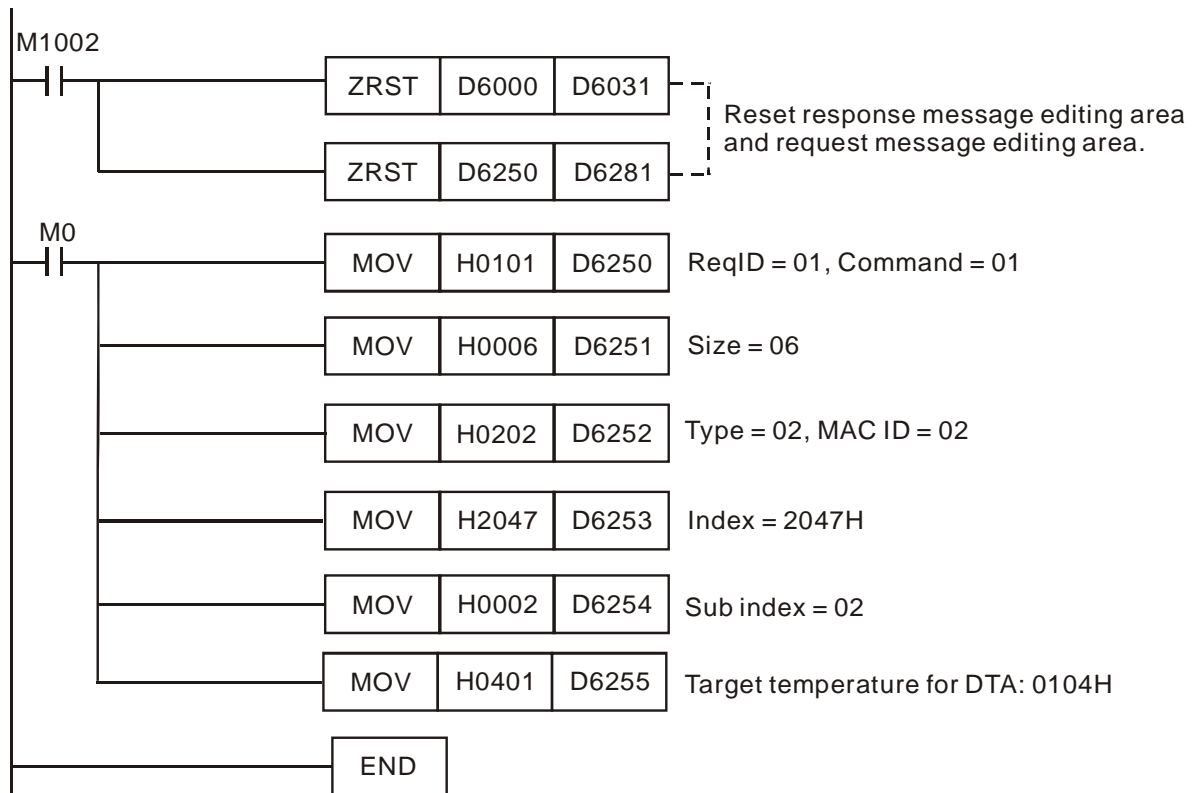

- Program explanation

1. The program first reset the SDO request message editing area and SDO response message editing area to 0.
2. When M0= On, CANopen master will send out SDO request message and write 0104Hex into index 2047, sub index 2 of the target equipment (at node address 02). If the communication is successful, the slave will return with the response message.
3. When M0 = On, CANopen master will send out request message only once. If you would like it to send out messages again, you will have to change the ReqID.
4. The messages returned from the target equipment are stored in D6000 ~ D6004.

6 LED Indicator & Trouble-shooting

DVPCOPM-SL has three LED indicators and a digital display on it. POWER LED displays whether the power supply of DVPCOPM-SL is normal. RUN LED and ERR LED display the current operational status. The digital display shows the node address of DVPCOPM-SL and error messages from the slave.

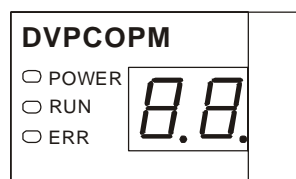

6.1 POWER LED

LED status	Indication	How to correct
On	Power is abnormal.	Check the power supply of DVPCOPM-SL.
Green light On	Power is normal.	--

6.2 RUN LED

LED status	Indication	How to correct
Off	No power	Check the power of DVPCOPM-SL and make sure the connection is normal.
Green light single flash	DVPCOPM-SL in STOP status	--
Green light blinking	DVPCOPM-SL in pre-operational status	--
Green light steady on	DVPCOPM-SL is operational status	--

6.3 ERR LED

LED status	Indication	How to correct
Off	Normal	--
Red light double flash	Error control event	See the indication from the digital display.
Red light single flash	Bus error exceeds the warning limit.	Check if the network connection and operation are normal.
Red light steady on	Bus-off	Check if the bus connection is normal and re-power DVPCOPM-SL.

6.4 Codes in Digital Display

- DVPCOPM-SL as master:

Code	Indication	How to correct
0 ~ 7F	The node address of DVPCOPM-SL when in normal operation.	--
F1	No slave configured in node list	Re-configure the node list and download it to DVPCOPM-SL.
F2	The data are being downloaded to DVPCOPM-SL.	--
F3	DVPCOPM-SL in error status	Check if the wiring of DVPCOPM-SL is correct.
F4	Bus-off is detected.	Make sure the communication cable is in normal operation, and all the nodes on the network work in the same baud rate. Re-power DVPCOPM-SL.
F5	Incorrect DVPCOPM-SL settings	Check the settings of node address and baud rate and make sure the settings are correct.
F6	Internal error: manufacturing process	Re-power DVPCOPM-SL. If the error still exists, change to a new DVPCOPM-SL.
F7	Internal error: GPIO check	
F8	Internal error: memory check	

Code	Indication	How to correct
F9	Low voltage is detected.	Check and make sure the power of DVPCOPM-SL works normally.
FA	The firmware of DVPCOPM-SL is in error status.	Re-power DVPCOPM-SL.
FB	The sending buffer in DVPCOPM-SL is full.	Make sure the bus works normally and re-power DVPCOPM-SL.
FC	The receiving buffer in DVPCOPM-SL is full.	Make sure the bus works normally and re-power DVPCOPM-SL.
E0	DVPCOPM-SL receives Emergency message sent by the slave.	Read relevant information through PLC MPU or Delta CANopenBuilder software.
E1	PDO data length returned from the slave is not consistent with the length set in the node list.	Reset the PDO data length in the slave and download the new setting to DVPCOPM-SL.
E2	PDO message from the slave has not been received.	Check and make sure the setting is correct.
E3	Auto SDO download failed.	Check and make sure auto SDO is correct.
E4	PDO parameter setting has failed.	Make sure the PDO parameter setting is legal.
E5	Error in key parameter setting.	Make sure all the slaves connected are consistent with the slaves set.
E6	The slave does not exist in the network.	Make sure the power of the slave and the network connection work normally.
E7	The slave's error control is timed-out.	
E8	Master/slave node address is repeated.	Reset the node address and make sure the new address is not a repeated one.

- DVPCOPM-SL as slave:

Code	Indication	How to correct
0 ~ 7F	The node address of DVPCOPM-SL when in normal operation.	--
A0	The parameters in DVPCOPM-SL is being initialized.	--
A1	DVPCOPM-SL is in pre-operational status.	--
A3	The data are being downloaded to DVPCOPM-SL.	--
B0	Heartbeat timed-out	Re-connect DVPCOPM-SL to the network.
B1	PDO data length returned from the slave is not consistent with the length set in the node list.	Reset the PDO data length in the slave and download the new setting to DVPCOPM-SL.
F4	Bus-off is detected	Make sure the communication cable is in normal operation, and all the nodes on the network work in the same baud rate. Re-power DVPCOPM-SL.
FB	The sending buffer in DVPCOPM-SL is full.	Make sure the bus works normally and re-power DVPCOPM-SL.
FC	The receiving buffer in DVPCOPM-SL is full.	Make sure the bus works normally and re-power DVPCOPM-SL.

MEMO

Free Manuals Download Website

<http://myh66.com>

<http://usermanuals.us>

<http://www.somanuals.com>

<http://www.4manuals.cc>

<http://www.manual-lib.com>

<http://www.404manual.com>

<http://www.luxmanual.com>

<http://aubethermostatmanual.com>

Golf course search by state

<http://golfingnear.com>

Email search by domain

<http://emailbydomain.com>

Auto manuals search

<http://auto.somanuals.com>

TV manuals search

<http://tv.somanuals.com>