

Bench Random Orbital Sander (Model 31-750)



REVISED 3-29-99

PART NO. 1348132
Delta International Machinery Corp. 1999



TABLE OF CONTENTS

SAFETY RULES FOR ALL TOOLS	3
ADDITIONAL SAFETY RULES FOR ALL TOOLS	4
UNPACKING AND CLEANING	4
ASSEMBLY INSTRUCTIONS	
Assembling Abrasive Discs To Disc Plate	6
Adjusting Table	6
Assembling Fence To Table	7
Assembling Dust Bag	8
Assembling Accessory 50-780 Stand	8
Assembling Sander To Accessory Stand	8
ACCESSORY 31-752 DISC HOLDER	9
FASTENING SANDER TO SUPPORTING SURFACE	9
CONNECTING SANDER TO POWER SOURCE	
Power Connections	9
Motor Specifications	9
Grounding Instructions	10
Extension Cords	10
OPERATING CONTROLS AND ADJUSTMENTS	
Starting And Stopping Sander	11
Locking Switch In The OFF Position	11
Changing Abrasive Discs	11
OPERATIONS	12



Delta Building Trades and Home Shop Machinery Two Year Limited Warranty

Delta will repair or replace, at its expense and at its option, any Delta machine, machine part, or machine accessory which in normal use has proven to be defective in workmanship or material, provided that the customer returns the product prepaid to a Delta factory service center or authorized service station with proof of purchase of the product within two years and provides Delta with reasonable opportunity to verify the alleged defect by inspection. Delta may require that electric motors be returned prepaid to a motor manufacturer's authorized station for inspection and repair or replacement. Delta will not be responsible for any asserted defect which has resulted from normal wear, misuse, abuse or repair or alteration made or specifically authorized by anyone other than an authorized Delta Service facility or representative. Under no circumstances will Delta be liable for incidental or consequential damages resulting from defective products. This warranty is Delta's sole warranty and sets forth the customer's exclusive remedy, with respect to defective products; all other warranties, express or implied, whether of merchantability, fitness for purpose, or otherwise, are expressly disclaimed by Delta.

SAFETY RULES

Woodworking can be dangerous if safe and proper operating procedures are not followed. As with all machinery, there are certain hazards involved with the operation of the product. Using the machine with respect and caution will considerably lessen the possibility of personal injury. However, if normal safety precautions are overlooked or ignored, personal injury to the operator may result. Safety equipment such as guards, push sticks, hold-downs, featherboards, goggles, dust masks and hearing protection can reduce your potential for injury. But even the best guard won't make up for poor judgment, carelessness or inattention. Always use common sense and exercise caution in the workshop. If a procedure feels dangerous, don't try it. Figure out an alternative procedure that feels safer. REMEMBER: Your personal safety is your responsibility.

This machine was designed for certain applications only. Delta Machinery strongly recommends that this machine not be modified and/or used for any application other than that for which it was designed. If you have any questions relative to a particular application, DO NOT use the machine until you have first contacted Delta to determine if it can or should be performed on the product.

DELTA INTERNATIONAL MACHINERY CORP.
MANAGER OF TECHNICAL SERVICES
246 ALPHA DRIVE
PITTSBURGH, PENNSYLVANIA 15238
(IN CANADA: 644 IMPERIAL ROAD, GUELPH, ONTARIO N1H 6M7)

WARNING: FAILURE TO FOLLOW THESE RULES MAY RESULT IN SERIOUS PERSONAL INJURY

1. FOR YOUR OWN SAFETY, READ INSTRUCTION MANUAL BEFORE OPERATING THE TOOL. Learn the tool's application and limitations as well as the specific hazards peculiar to it.

2. KEEP GUARDS IN PLACE and in working order.

3. ALWAYS WEAR EYE PROTECTION.

4. GROUND ALL TOOLS. If tool is equipped with three-prong plug, it should be plugged into a three-hole electrical receptacle. If an adapter is used to accommodate a two-prong receptacle, the adapter lug must be attached to a known ground. Never remove the third prong.

5. REMOVE ADJUSTING KEYS AND WRENCHES. Form habit of checking to see that keys and adjusting wrenches are removed from tool before turning it on.

6. KEEP WORK AREA CLEAN. Cluttered areas and benches invite accidents.

7. DON'T USE IN DANGEROUS ENVIRONMENT. Don't use power tools in damp or wet locations, or expose them to rain. Keep work area well-lighted.

8. KEEP CHILDREN AND VISITORS AWAY. All children and visitors should be kept a safe distance from work area.

9. MAKE WORKSHOP CHILDPROOF with padlocks, master switches, or by removing starter keys.

10. DON'T FORCE TOOL. It will do the job better and be safer at the rate for which it was designed.

11. USE RIGHT TOOL. Don't force tool or attachment to do a job for which it was not designed.

12. WEAR PROPER APPAREL. No loose clothing, gloves, neckties, rings, bracelets, or other jewelry to get caught in moving parts. Non-slip footwear is recommended. Wear protective hair covering to contain long hair.

13. ALWAYS USE SAFETY GLASSES. Wear safety glasses. Everyday eyeglasses only have impact resistant lenses; they are not safety glasses. Also use face or dust mask if cutting operation is dusty.

14. SECURE WORK. Use clamps or a vise to hold work when practical. It's safer than using your hand and frees both hands to operate tool.

15. DON'T OVERREACH. Keep proper footing and balance at all times.

16. MAINTAIN TOOLS IN TOP CONDITION. Keep tools sharp and clean for best and safest performance. Follow instructions for lubricating and changing accessories.

17. DISCONNECT TOOLS before servicing and when changing accessories such as blades, bits, cutters, etc.

18. USE RECOMMENDED ACCESSORIES. The use of accessories and attachments not recommended by Delta may cause hazards or risk of injury to persons.

19. REDUCE THE RISK OF UNINTENTIONAL STARTING. Make sure switch is in OFF position before plugging in power cord.

20. NEVER STAND ON TOOL. Serious injury could occur if the tool is tipped or if the cutting tool is accidentally contacted.

21. CHECK DAMAGED PARTS. Before further use of the tool, a guard or other part that is damaged should be carefully checked to ensure that it will operate properly and perform its intended function. Check for alignment of moving parts, binding of moving parts, breakage of parts, mounting, and any other conditions that may affect its operation. A guard or other part that is damaged should be properly repaired or replaced.

22. DIRECTION OF FEED. Feed work into a blade or cutter against the direction of rotation of the blade or cutter only.

23. NEVER LEAVE TOOL RUNNING UNATTENDED. TURN POWER OFF. Don't leave tool until it comes to a complete stop.

24. DRUGS, ALCOHOL, MEDICATION. Do not operate tool while under the influence of drugs, alcohol or any medication.

25. MAKE SURE TOOL IS DISCONNECTED FROM POWER SUPPLY while motor is being mounted, connected or reconnected.

26. WARNING: The dust generated by certain woods and wood products can be injurious to your health. Always operate machinery in well-ventilated areas and provide for proper dust removal. Use wood dust collection systems whenever possible.

ADDITIONAL SAFETY RULES FOR RANDOM ORBITAL SANDERS

1. **WARNING: DO NOT** operate your random orbital sander until it is completely assembled and installed according to the instructions.

2. **IF YOU ARE NOT** thoroughly familiar with the operation of the random orbital sander, obtain advice from your supervisor, instructor or other qualified person.

3. **USE FACE OR DUST MASK.** **WARNING:** The dust generated by certain woods and wood products can be injurious to your health. **ALWAYS** operate machinery in well-ventilated areas and provide for proper dust removal. **USE** wood dust collection systems whenever possible. Sanding of Lead-based paint is **NOT RECOMMENDED**.

4. **KEEP** fingers away from rotating abrasive disc.

5. **MAKE SURE** abrasive disc is not damaged and is properly secured on the disc plate before operating.

6. **NEVER** perform layout, assembly or set-up work on the table while the sander is operating.

7. **MAKE SURE** workpiece is clear of abrasive disc before turning unit on.

8. **KEEP WORK AREA CLEAN.** Cluttered areas can create slipping or tripping hazards.

9. **DO NOT FORCE TOOL.** It will do the job better and be safer at the rate for which it was designed.

10. **NEVER** use machine for wet sanding which can create hazard of electrical shock.

11. **USE** correctly sized abrasive disc. Maintain minimum table opening to keep fingers from being pinched or workpiece being pulled down.

12. **DO NOT** sand near flammable liquids, vapors, or gases.

13. **ALWAYS** support workpiece on work table. **USE** sander on a solid supporting surface where there is plenty of room for handling and supporting workpiece.

14. **CLEAR** all debris from table before sanding the workpiece.

15. **DO NOT** use this sander to sand pieces too small to be held safely and securely by hand.

16. **ALWAYS WEAR PROPER EYE PROTECTION.**

17. **THE USE** of attachments and accessories not recommended by Delta may result in the risk of injuries.

18. **PROTECT YOUR EARS.** Wear proper hearing protection.

19. **AFTER** turning off power switch, disconnect tool from power source and wait for sander to stop before servicing.

20. **DO NOT** wear gloves, neckties, jewelry or loose clothing.

21. **MAINTAIN** minimum clearance between abrasive disc and fence.

22. **AVOID KICKBACKS** by sanding left of disc center, holding workpiece firmly, and using support fence when possible.

23. **KEEP** hands and fingers out of dust chute.

24. **DO NOT** expose to rain or use in damp locations.

25. **DISCONNECT MACHINE FROM POWER SOURCE BEFORE MAKING REPAIRS OR ADJUSTMENTS.**

26. **ADDITIONAL INFORMATION** regarding the safe and proper operation of this product is available from the National Safety Council, 1121 Spring Lake Drive, Itasca, IL 60143-3201, in the Accident Prevention Manual for Industrial Operations and also in the Safety Data Sheets provided by the NSC. Please also refer to the American National Standards Institute ANSI O1.1 Safety Requirements for Woodworking Machinery and the U.S. Department of Labor OSHA 1910.213 Regulations.

27. **SAVE THESE INSTRUCTIONS.** Refer to them often and use them to instruct others.

UNPACKING AND CLEANING

Your new random orbital sander is shipped complete in one container. Carefully unpack the sander and all loose items from the shipping container. Clean all loose parts. Fig. 2, illustrates the sander and all loose parts supplied with the machine. If you purchased the accessory Model 50-780 Stand, Fig. 3 illustrates the components of the stand.

ASSEMBLY INSTRUCTIONS

WARNING: FOR YOUR OWN SAFETY, DO NOT CONNECT THE SANDER TO A POWER SOURCE UNTIL THE MACHINE IS COMPLETELY ASSEMBLED AND YOU HAVE READ AND UNDERSTOOD THE ENTIRE OWNERS MANUAL. **NOTE:** Place the machine on a firm supporting surface and proceed with the assembly instructions. If you purchased the accessory 50-780 Steel Stand, this manual also contains instructions for its assembly.

- 1 Bench Random Orbital Sander
 - 2 Dust Bag
 - 3 Fence
 - 4 5/16 Flat Washer (2)
 - 5 Fence Lock Knob (2)
 - 6 Abrasive Disc (Hook and Loop)
 - 7 Abrasive Disc (PSA-Pressure Sensitive Adhesive)
 - 8 Transition Pad - For use with PSA abrasive discs only!
- * 1/8 Allen Wrench (not shown)
- * 13MM and 14MM Wrench (not shown)

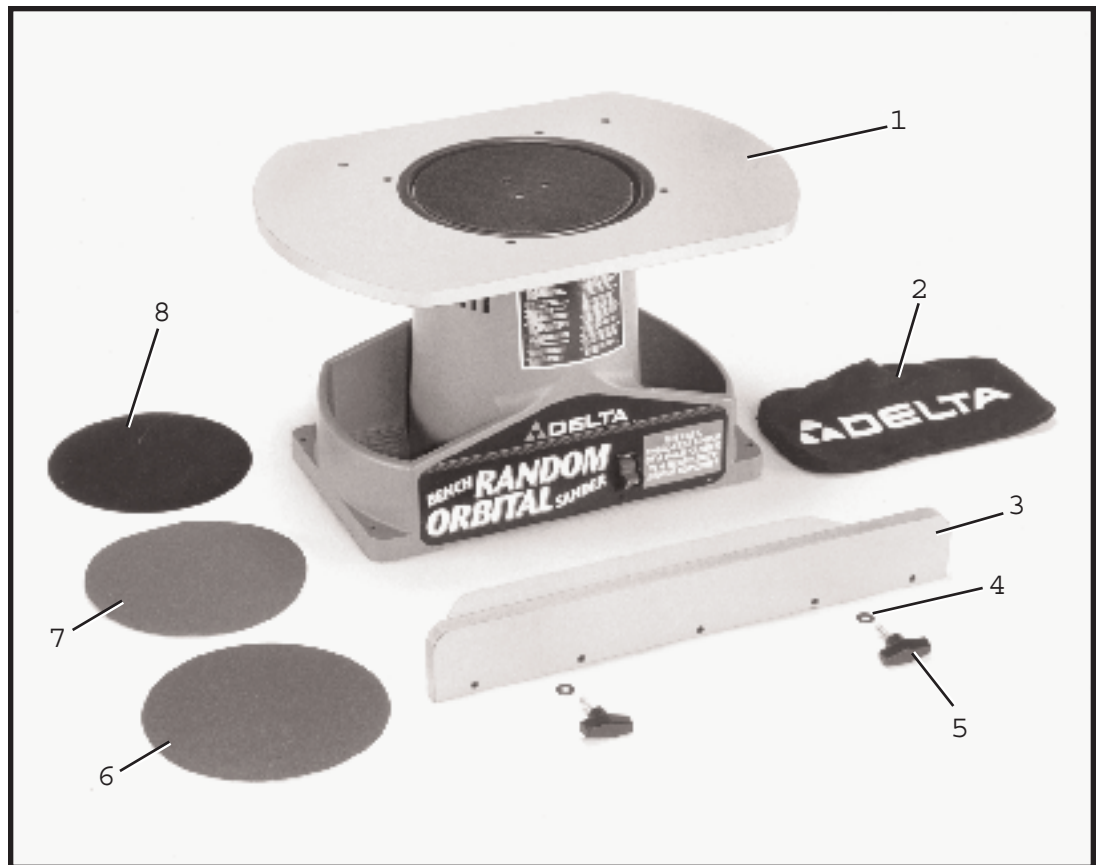

Fig. 2

- A Four Legs - 27-1/2 long
- B Two Upper Front and Rear Braces - 11-1/2 long
- C Two Upper Side Braces - 21-5/16 long
- D Two Lower Front and Rear Braces - 17-1/8 long
- E Two Lower Side Braces - 26-5/8 long
- F M 8 Hex Nuts - (36)
- G 3/8 Flat Washers - (40)
- H M 8 x 16mm Carriage Bolts - (32)
- J M 8 x 45mm Hex Head Screws (4)
- K Plastic Feet (4)

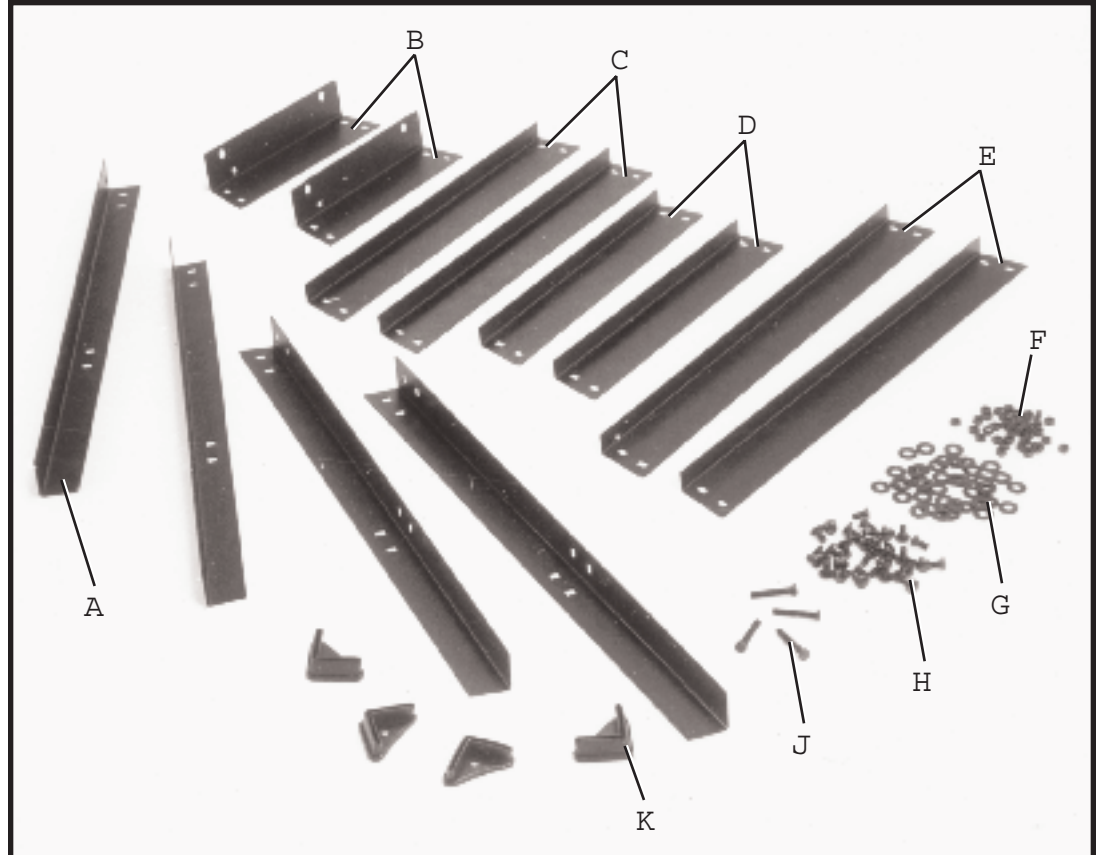

Fig. 3

ASSEMBLING ABRASIVE DISCS TO DISC PLATE

IMPORTANT: MAKE CERTAIN THE MACHINE IS DISCONNECTED FROM THE POWER SOURCE.

There are two types of 9 abrasive discs available for the sander: hook and loop, and adhesive-backed abrasive discs.

HOOK AND LOOP

If you are using the hook and loop backed abrasive disc, simply position hook and loop abrasive disc (A) Fig. 4, directly onto disc plate pad (B).

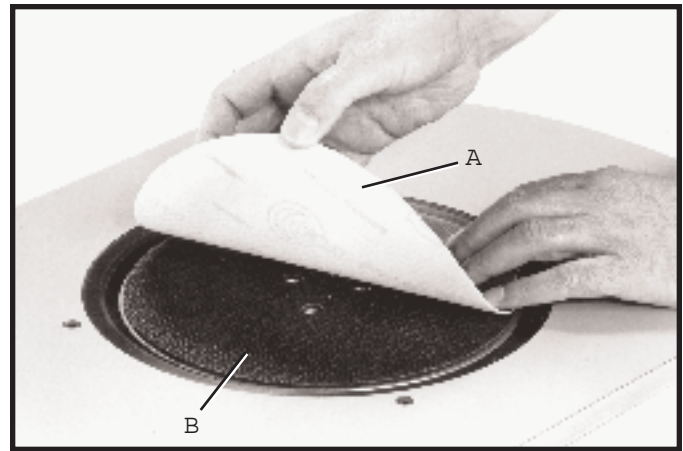

Fig. 4

PRESSURE SENSITIVE ADHESIVE (PSA)

1. **IMPORTANT:** If you are using the pressure sensitive adhesive-backed abrasive disc, you must first apply transition pad (C) Fig. 5, to disc plate pad (B).

2. Remove backing (D) Fig. 6, from abrasive disc (E) and press the disc onto transition pad (C).

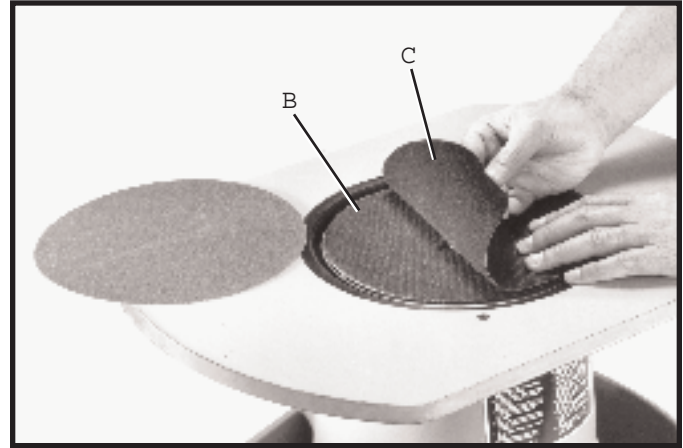

Fig. 5

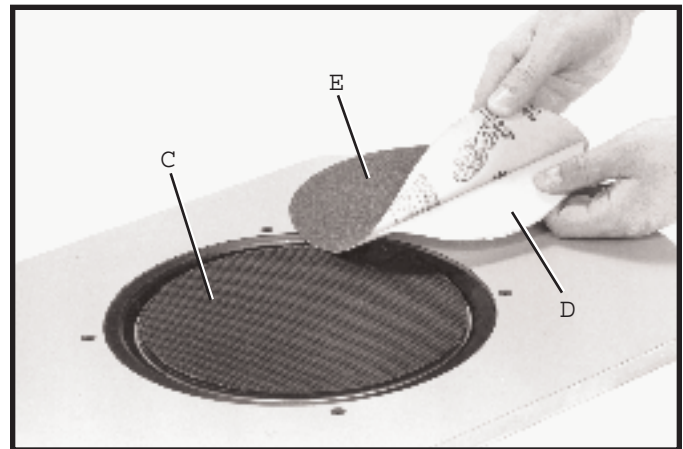

Fig. 6

ADJUSTING TABLE

IMPORTANT: Before operating the sander, the table surface must be positioned so it is slightly lower than the sanding disc.

1. Place a straight edge (A) Fig. 7, on abrasive disc (B) and check to see if the disc is slightly higher than the table surface (C). **NOTE:** Check the table height directly over two adjustment screws (D) Fig. 7, and again over screws (E).

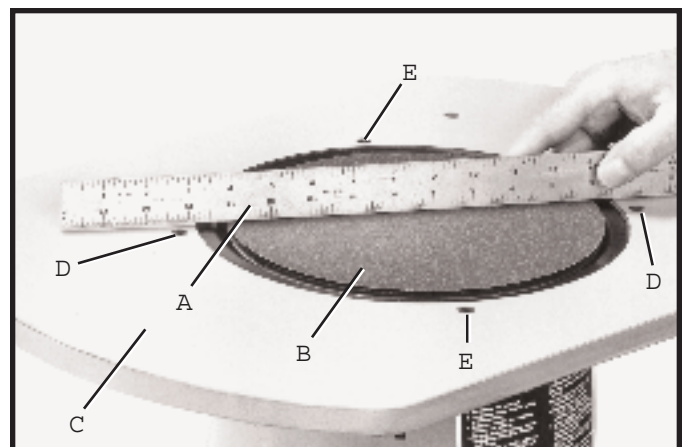

Fig. 7

2. If an adjustment is necessary, loosen four lock nuts located underneath the table, three of which are shown at (F) Fig. 8.

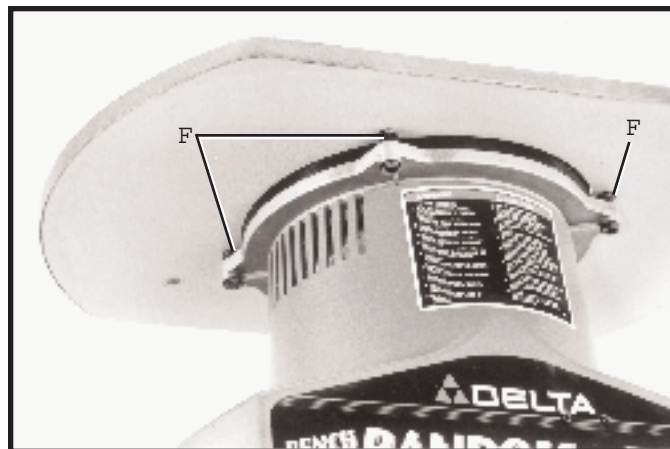

Fig. 8

3. With allen wrench supplied, tighten or loosen adjustment screws (D) and (E) Fig. 9, as necessary. Recheck the table height and repeat the adjustment if needed, until the table surface is slightly lower than the abrasive disc.

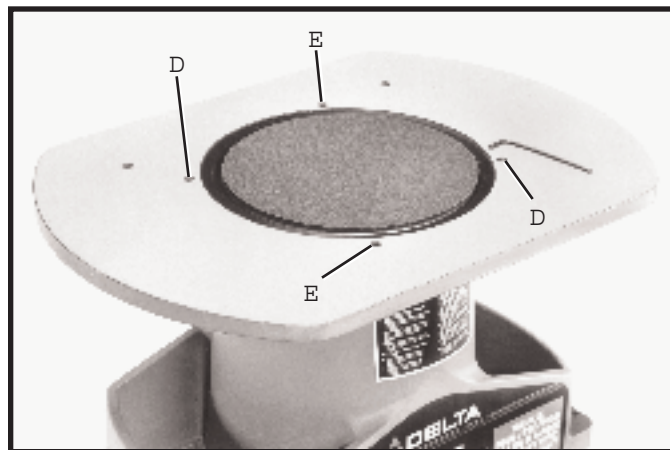

Fig. 9

4. Tighten four lock nuts (F) Fig. 8, after table height adjustment.

ASSEMBLING FENCE TO TABLE

Align two holes (A) Fig. 10, in the underside of fence (B) with two holes (C) in the table and fasten fence (B) to the table from the top, with two lock knobs and flat washers (D). Fig. 11, illustrates the fence (B) assembled to the sander.

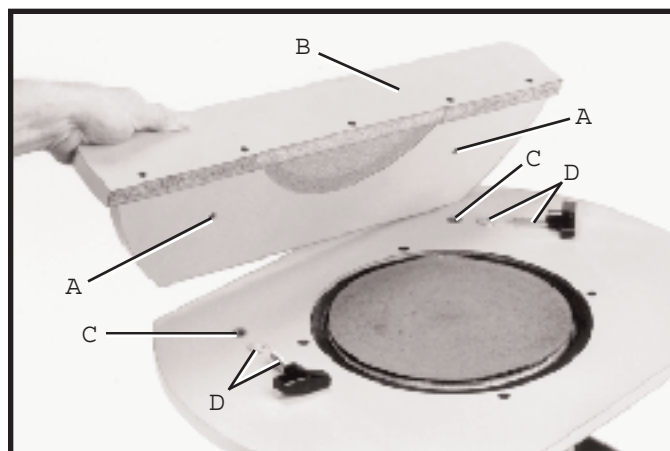

Fig. 10

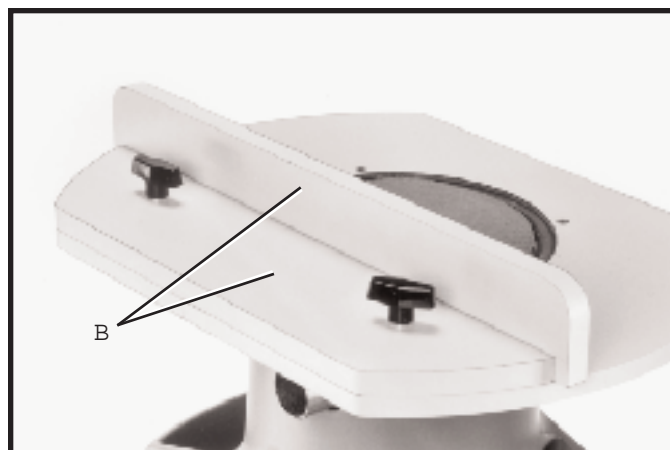

Fig. 11

ASSEMBLING DUST BAG

1 A 1-1/2 I.D. dust chute (A) Fig. 12, is supplied with the spindle sander to accept the dust bag.



Fig. 12

2 To assemble the dust bag (B) Fig. 13, over the dust chute (A), simply squeeze the spring clamp on the dust bag and assemble it over the dust chute as shown.

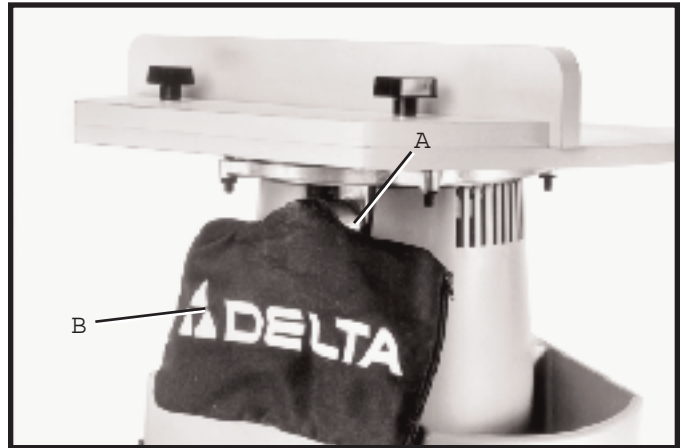

Fig. 13

ASSEMBLING ACCESSORY 50-780 STAND

1 Assemble the stand, as shown in Fig. 14, using the 32 carriage bolts, flat washers and nuts supplied. The two 11-1/2 long upper braces (A); 21-5/16 long upper braces (B); 17-1/8 long lower braces (C); and 26-5/8 long lower braces (D) should be fastened to the four 27-1/2 long legs (E). **IMPORTANT:** The top lips of the upper braces (A) should be on top of the top lips of upper braces (B).

2 Assemble a plastic foot (F) Fig. 14, to bottom of each leg (E) as shown.

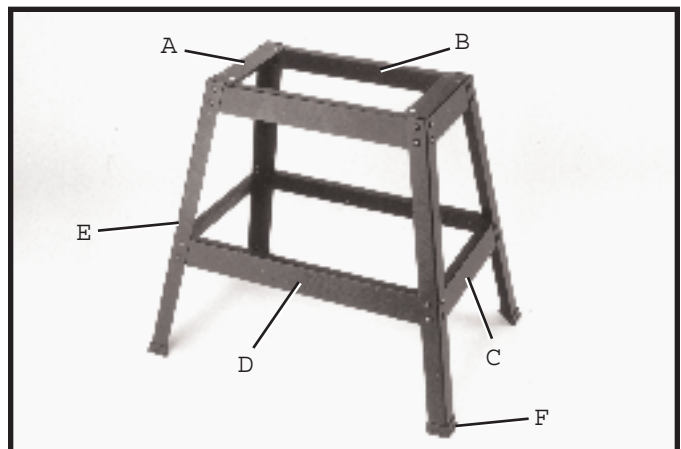

Fig. 14

ASSEMBLING SANDER TO ACCESSORY 50-780 STAND

If you purchased the accessory 50-780 stand for use with your sander, carefully place the sander on the stand. Align the four holes on the top of stand (A) Fig. 15, with four mounting holes at the base of sander (B) and fasten sander to the stand with four M8 x 45mm hex head screws (C), three of which are shown, eight flat washers and four hex nuts supplied.

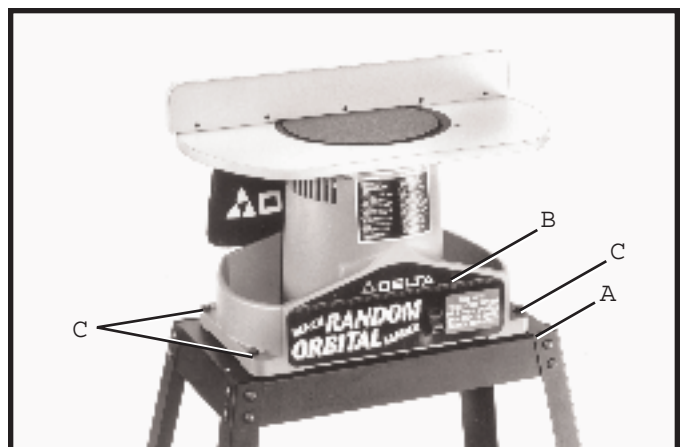

Fig. 15

ACCESSORY 31-752 DISC HOLDER

An accessory abrasive disc holder (A) Fig. 16, is available to conveniently store extra abrasive discs. The disc holder (A) slides neatly into the pocket of the sander as shown in Fig. 17.

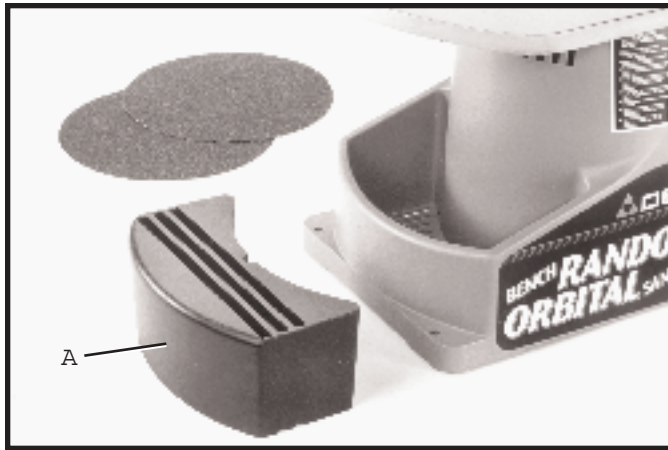

Fig. 16

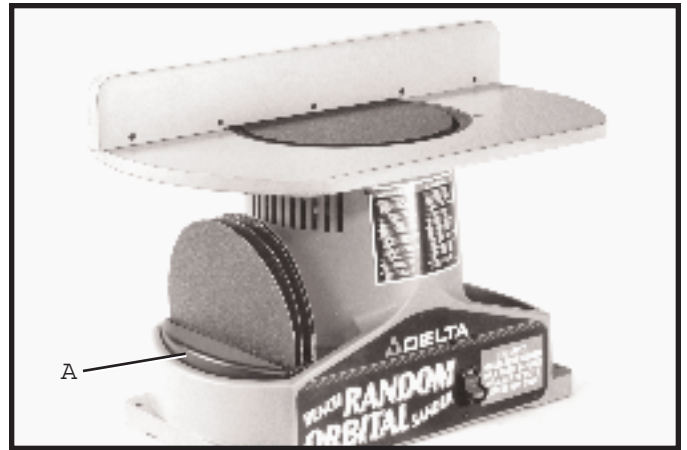

Fig. 17

FASTENING SANDER TO A SUPPORTING SURFACE

If during operation there is any tendency for the sander to tip over, slide or walk, the sander must be secured to the supporting surface using the four holes in the base of the machine. If you purchased the accessory stand, the four plastic feet supplied with the stand feature holes which allow easy mounting of the stand to a supporting surface.

CONNECTING SANDER TO POWER SOURCE

POWER CONNECTIONS

A separate electrical circuit should be used for your tools. This circuit should not be less than #12 wire and should be protected with a 20 Amp fuse. Have a certified electrician replace or repair a worn cord immediately. Before connecting the motor to a power line, make sure the switch is in the OFF position and be sure that the electric current is of the same characteristics as stamped on the motor nameplate. Running on low voltage will damage the motor.

WARNING: DO NOT EXPOSE THE TOOL TO RAIN OR OPERATE THE TOOL IN DAMP LOCATIONS.

MOTOR SPECIFICATIONS

Your sander is wired for 110-120 volt, 60 Hz alternating current. Before connecting the sander to the power source, make sure the switch is in the OFF position. The 3600 RPM motor provides 3600 oscillations per minute.

GROUNDING INSTRUCTIONS

CAUTION: THIS TOOL MUST BE GROUNDED WHILE IN USE
TO PROTECT THE OPERATOR FROM ELECTRIC SHOCK.

In the event of a malfunction or breakdown, grounding provides a path of least resistance for electric current to reduce the risk of electric shock. This tool is equipped with an electric cord having an equipment-grounding conductor and a grounding plug. The plug must be plugged into a matching outlet that is properly installed and grounded in accordance with all local codes and ordinances.

Do not modify the plug provided - if it will not fit the outlet, have the proper outlet installed by a qualified electrician.

Improper connection of the equipment-grounding conductor can result in risk of electric shock. The conductor with insulation having an outer surface that is green with or without yellow stripes is the equipment-grounding conductor. If repair or replacement of the electric cord or plug is necessary, do not connect the equipment grounding conductor to a live terminal.

Check with a qualified electrician or service personnel if the grounding instructions are not completely understood, or if in doubt as to whether the tool is properly grounded.

Use only 3-wire extension cords that have 3-prong grounding type plugs and 3-hole receptacles that accept the tool's plug, as shown in Fig. 18.

Repair or replace damaged or worn cord immediately.

This tool is intended for use on a circuit that has an outlet and a plug that looks like the one shown in Fig. 18. A temporary adapter, which looks like the adapter illustrated in Fig. 19, may be used to connect this plug to a 2-pole receptacle, as shown in Fig. 19, if a properly grounded outlet is not available. The temporary adapter should be used only until a properly grounded outlet can be installed by a qualified electrician. THIS ADAPTER IS NOT APPLICABLE IN CANADA. The green-colored rigid ear, lug, and the like, extending from the adapter must be connected to a permanent ground, such as a properly grounded outlet box, as shown in Fig. 19.

CAUTION: IN ALL CASES, MAKE CERTAIN THE RECEPTACLE IN QUESTION IS PROPERLY GROUNDED. IF YOU ARE NOT SURE HAVE A CERTIFIED ELECTRICIAN CHECK THE RECEPTACLE.

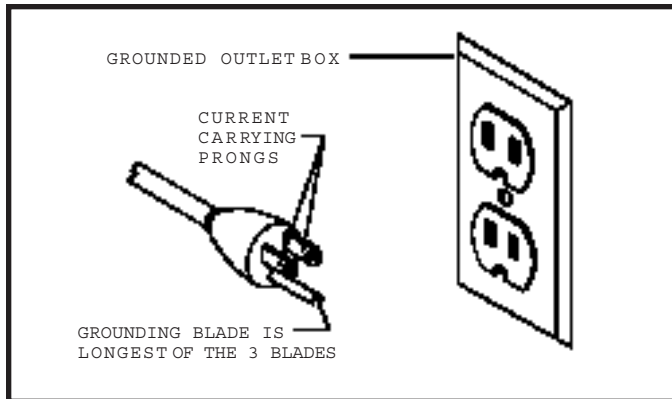

Fig. 18

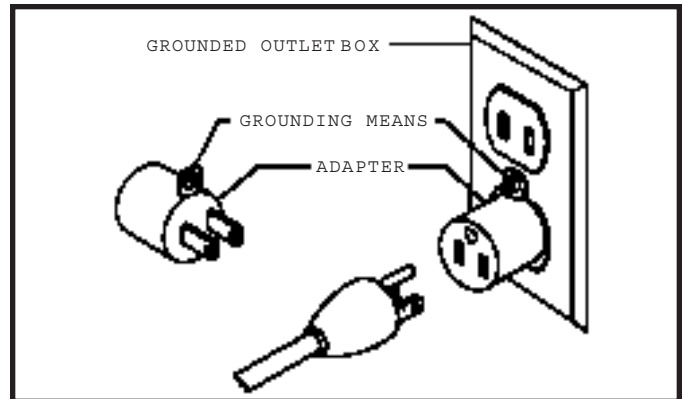

Fig. 19

EXTENSION CORDS

Use proper extension cords. Make sure your extension cord is in good condition and is a 3-wire extension cord which has a 3-prong grounding type plug and a 3-pole receptacle which will accept the tool's plug. When using an extension cord, be sure to use one heavy enough to carry the current of the sander. An undersized cord will cause a drop in line voltage resulting in loss of power and overheating. Fig. 20, shows the correct gage to use depending on cord length. If in doubt, use the next heavier gage. The smaller the gage number, the heavier the cord.

TOTAL LENGTH OF CORD IN FEET	GAGE OF EXTENSION CORD TO USE
0 - 25	18 AW G
26 - 50	16 AW G
51 - 100	14 AW G
101 - 150	12 AW G

Fig. 20

OPERATING CONTROLS AND ADJUSTMENTS

STARTING AND STOPPING SANDER

The on/off switch (A) Fig. 21, is located on the sander base. To turn the sander ON move the switch to the up position. To turn the sander OFF move the switch to the down position.

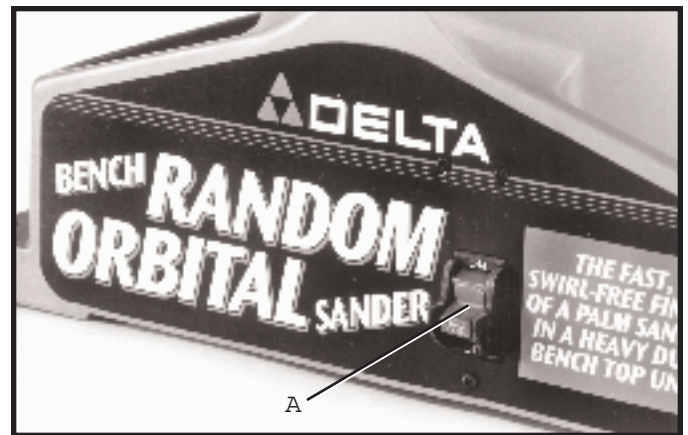

Fig. 21

LOCKING SWITCH IN THE OFF POSITION

We suggest that when the sander is not in use, the switch be locked in the OFF position. This can be done by grasping the switch toggle (B) and pulling it out of the switch, as shown in Fig. 22. With the switch toggle (B) removed, the switch will not operate. However, should the switch toggle be removed while the sander is running, it can be turned OFF once, but cannot be restarted without inserting the switch toggle (B).



Fig. 22

CHANGING ABRASIVE DISCS

IMPORTANT: MAKE CERTAIN THE MACHINE IS DISCONNECTED FROM THE POWER SOURCE.

Remove abrasive disc by pulling it from the disc plate pad or the transition pad.

HOOK AND LOOP ABRASIVE DISC

If you are using the hook and loop backed abrasive disc, simply position hook and loop abrasive disc (A) Fig. 23, directly onto disc plate pad (B). **NOTE:** If you are changing over from using a hook and loop abrasive disc to a pressure sensitive abrasive disc, refer to section **ASSEMBLING ABRASIVE DISCS TO DISC PLATE** .

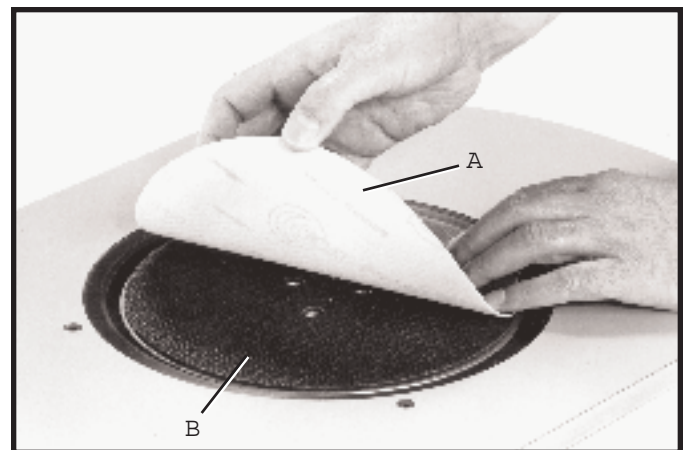

Fig.23

PRESSURE SENSITIVE ABRASIVE DISC

If you are using an adhesive-backed abrasive disc, remove backing (D) Fig. 24, from abrasive disc (E) and press the disc onto transition pad (C). **NOTE:** If you are changing over from using an adhesive-backed abrasive disc to a hook and loop abrasive disc, refer to section **ASSEMBLING ABRASIVE DISCS TO DISC PLATE** .

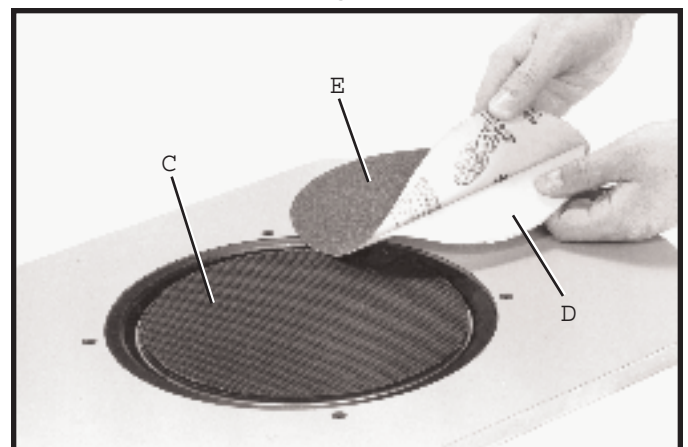

Fig. 24

OPERATIONS

PLEASE READ THE SAFETY RULES BEFORE OPERATING THE SANDER.

The random orbital sander can be used with or without the fence depending on the application; however, we recommend that the fence be used whenever possible.

Fig. 25, illustrates a typical edge sanding operation using the fence as a backstop.



Fig. 25

Fig. 26, illustrates a typical flat sanding operation using the fence as a guide.

Fig. 27, illustrates a typical flat sanding operation without the fence.



Fig. 26



Fig. 27

The random orbital action of the sander minimizes score marks on the workpiece and allows maximum wear from the abrasive sanding discs. **IMPORTANT:** Since the sander operates in a clockwise direction, it is best to sand with the workpiece on the left side of the disc, if possible, to prevent work kickback. Always use the fence when sanding operations permit.

Free Manuals Download Website

<http://myh66.com>

<http://usermanuals.us>

<http://www.somanuals.com>

<http://www.4manuals.cc>

<http://www.manual-lib.com>

<http://www.404manual.com>

<http://www.luxmanual.com>

<http://aubethermostatmanual.com>

Golf course search by state

<http://golfingnear.com>

Email search by domain

<http://emailbydomain.com>

Auto manuals search

<http://auto.somanuals.com>

TV manuals search

<http://tv.somanuals.com>