

DENON

PERSONAL AUDIO SYSTEM

S-81

OPERATING INSTRUCTIONS

SAFETY PRECAUTIONS



CAUTION
RISK OF ELECTRIC SHOCK
DO NOT OPEN



CAUTION:
TO REDUCE THE RISK OF ELECTRIC SHOCK, DO NOT REMOVE COVER (OR BACK). NO USER-SERVICEABLE PARTS INSIDE. REFER SERVICING TO QUALIFIED SERVICE PERSONNEL.



The lightning flash with arrowhead symbol, within an equilateral triangle, is intended to alert the user to the presence of uninsulated "dangerous voltage" within the product's enclosure that may be of sufficient magnitude to constitute a risk of electric shock to persons.



The exclamation point within an equilateral triangle is intended to alert the user to the presence of important operating and maintenance (servicing) instructions in the literature accompanying the appliance.

WARNING:
TO REDUCE THE RISK OF FIRE OR ELECTRIC SHOCK, DO NOT EXPOSE THIS APPLIANCE TO RAIN OR MOISTURE.

CAUTION:
USE OF CONTROLS OR ADJUSTMENTS OR PERFORMANCE OF PROCEDURES OTHER THAN THOSE SPECIFIED HEREIN MAY RESULT IN HAZARDOUS RADIATION EXPOSURE. THIS PRODUCT SHOULD NOT BE ADJUSTED OR REPAIRED BY ANYONE EXCEPT PROPERLY QUALIFIED SERVICE PERSONNEL.

SAFETY INSTRUCTIONS

1. Read Instructions – All the safety and operating instructions should be read before the product is operated.
2. Retain Instructions – The safety and operating instructions should be retained for future reference.
3. Heed Warnings – All warnings on the product and in the operating instructions should be adhered to.
4. Follow Instructions – All operating and use instructions should be followed.
5. Cleaning – Unplug this product from the wall outlet before cleaning. Do not use liquid cleaners or aerosol cleaners.
6. Attachments – Do not use attachments not recommended by the product manufacturer as they may cause hazards.
7. Water and Moisture – Do not use this product near water – for example, near a bath tub, wash bowl, kitchen sink, or laundry tub; in a wet basement; or near a swimming pool; and the like.
8. Accessories – Do not place this product on an unstable cart, stand, tripod, bracket, or table. The product may fall, causing serious injury to a child or adult, and serious damage to the product. Use only with a cart, stand, tripod, bracket, or table recommended by the manufacturer, or sold with the product. Any mounting of the product should follow the manufacturer's instructions, and should use a mounting accessory recommended by the manufacturer.
9. A product and cart combination should be moved with care. Quick stops, excessive force, and uneven surfaces may cause the product and cart combination to overturn.
10. Ventilation – Slots and openings in the cabinet are provided for ventilation and to ensure reliable operation of the product and to protect it from overheating, and these openings must not be blocked or covered. The openings should never be blocked by placing the product on a bed, sofa, rug, or other similar surface. This product should not be placed in a built-in installation such as a bookcase or rack unless proper ventilation is provided or the manufacturer's instructions have been adhered to.
11. Power Sources – This product should be operated only from the type of power source indicated on the marking label. If you are not sure of the type of power supply to your home, consult your product dealer or local power company. For products intended to operate from battery power, or other sources, refer to the operating instructions.
12. Grounding or Polarization – This product may be equipped with a polarized alternating-current line plug (a plug having one blade wider than the other). This plug will fit into the power outlet only one way. This is a safety feature. If you are unable to insert the plug fully into the outlet, try reversing the plug. If the plug should still fail to fit, contact your electrician to replace your obsolete outlet. Do not defeat the safety purpose of the polarized plug.
13. Power-Cord Protection – Power-supply cords should be routed so that they are not likely to be walked on or pinched by items placed upon or against them, paying particular attention to cords at plugs, convenience receptacles, and the point where they exit from the product.
15. Outdoor Antenna Grounding – If an outside antenna or cable system is connected to the product, be sure the antenna or cable system is grounded so as to provide some protection against voltage surges and built-up static charges. Article 810 of the National Electrical Code, ANSI/NFPA 70, provides information with regard to proper grounding of the mast and supporting structure, grounding of the lead-in wire to an antenna discharge unit, size of grounding conductors, location of antenna-discharge unit, connection to grounding electrodes, and requirements for the grounding electrode. See Figure A.
16. Lightning – For added protection for this product during a lightning storm, or when it is left unattended and unused for long periods of time, unplug it from the wall outlet and disconnect the antenna or cable system. This will prevent damage to the product due to lightning and power-line surges.
17. Power Lines – An outside antenna system should not be located in the vicinity of overhead power lines or other electric light or power circuits, or where it can fall into such power lines or circuits. When installing an outside antenna system, extreme care should be taken to keep from touching such power lines or circuits as contact with them might be fatal.
18. Overloading – Do not overload wall outlets, extension cords, or integral convenience receptacles as this can result in a risk of fire or electric shock.
19. Object and Liquid Entry – Never push objects of any kind into this product through openings as they may touch dangerous voltage points or short-out parts that could result in a fire or electric shock. Never spill liquid of any kind on the product.
20. Servicing – Do not attempt to service this product yourself as opening or removing covers may expose you to dangerous voltage or other hazards. Refer all servicing to qualified service personnel.
21. Damage Requiring Service – Unplug this product from the wall outlet and refer servicing to qualified service personnel under the following conditions:
 - a) When the power-supply cord or plug is damaged,
 - b) If liquid has been spilled, or objects have fallen into the product,
 - c) If the product has been exposed to rain or water,
 - d) If the product does not operate normally by following the operating instructions. Adjust only those controls that are covered by the operating instructions as an improper adjustment of other controls may result in damage and will often require extensive work by a qualified technician to restore the product to its normal operation,
 - e) If the product has been dropped or damaged in any way, and
 - f) When the product exhibits a distinct change in performance – this indicates a need for service.
22. Replacement Parts – When replacement parts are required, be sure the service technician has used replacement parts specified by the manufacturer or have the same characteristics as the original part. Unauthorized substitutions may result in fire, electric shock, or other hazards.
23. Safety Check – Upon completion of any service or repairs to this product, ask the service technician to perform safety checks to determine that the product is in proper operating condition.
24. Wall or Ceiling Mounting – The product should be mounted to a wall or ceiling only as recommended by the manufacturer.
25. Heat – The product should be situated away from heat sources such as radiators, heat registers, stoves, or other products (including amplifiers) that produce heat.

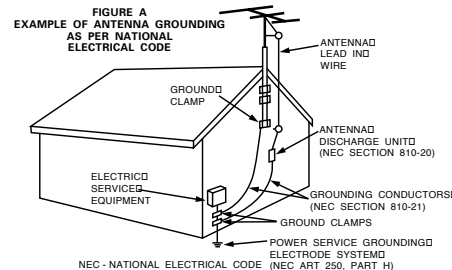

FCC INFORMATION (For US customers)**1. PRODUCT**

This product complies with Part 15 of the FCC Rules. Operation is subject to the following two conditions: (1) this product may not cause harmful interference, and (2) this product must accept any interference received, including interference that may cause undesired operation.

2. IMPORTANT NOTICE: DO NOT MODIFY THIS PRODUCT

This product, when installed as indicated in the instructions contained in this manual, meets FCC requirements. Modification not expressly approved by DENON may void your authority, granted by the FCC, to use the product.

3. NOTE







This product has been tested and found to comply with the limits for a Class B digital device, pursuant to Part 15 of the FCC Rules. These limits are designed to provide reasonable protection against harmful interference in a residential installation.

This product generates, uses and can radiate radio frequency energy and, if not installed and used in accordance with the instructions, may cause harmful interference to radio communications. However, there is no guarantee that interference will not occur in a particular installation. If this product does cause harmful interference to radio or television reception, which can be determined by turning the product OFF and ON, the user is encouraged to try to correct the interference by one or more of the following measures:

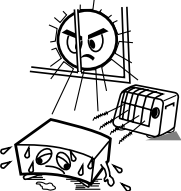
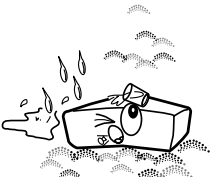
- Reorient or relocate the receiving antenna.
- Increase the separation between the equipment and receiver.
- Connect the product into an outlet on a circuit different from that to which the receiver is connected.
- Consult the local retailer authorized to distribute this type of product or an experienced radio/TV technician for help.

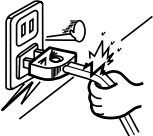
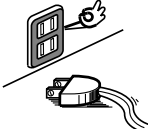
This class B digital apparatus complies with Canadian ICES-003.
Cet appareil numérique de la classe B est conforme à la norme NMB-003 du Canada.

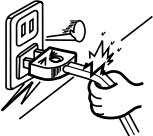
■ NOTE ON USE

 <ul style="list-style-type: none"> • Avoid high temperatures. Allow for sufficient heat dispersion when installed in a rack. 	 <ul style="list-style-type: none"> • Keep the apparatus free from moisture, water, and dust. 	 <ul style="list-style-type: none"> • Do not let foreign objects into the apparatus.
 <ul style="list-style-type: none"> • Handle the power cord carefully. Hold the plug when unplugging the cord. 	 <ul style="list-style-type: none"> • Unplug the power cord when not using the apparatus for long periods of time. 	 <ul style="list-style-type: none"> • Do not let insecticides, benzene, and thinner come in contact with the apparatus.
 <ul style="list-style-type: none"> • Handle the power cord carefully. Hold the plug when unplugging the cord. 	 <p>* (For apparatuses with ventilation holes)</p> <ul style="list-style-type: none"> • Do not obstruct the ventilation holes. 	 <ul style="list-style-type: none"> • Never disassemble or modify the apparatus in any way.

Thank you for purchasing this DENON Personal Audio System.

Please read the operation instructions thoroughly in order to acquaint yourself with the Personal Audio System and achieve maximum satisfaction from it.

Contents

Getting Started		Basic Operation		Playing discs	
Accessories	2	Turning the power on	13	Starting playback	22
Before using	2	Loading discs	13	To stop playback.....	22
Cautions on installation	2	Adjusting the volume	13	To pause playback (Pause).....	22
Speaker system (SC-S81).....	3	Adjusting the tone	13	Fast-forwarding (Search).....	22
About discs				Fast-reversing (Search).....	22
Discs usable on this set.....	3	Listening to radio broadcasts		Moving to the beginning of tracks (Skip).....	22
Holding discs.....	3	Selecting a radio station	14	Playing the desired track (Direct play)	23
Loading discs.....	3	Giving a name to the currently tuned in broadcast station and presetting it	14	Listening to specific tracks in a specific order (Programmed play)	23
Cautions on loading discs.....	3	Presetting broadcast stations automatically (Auto preset)	15	Listening in random order (Random playback)	23
Cautions on handling.....	4	Listening to preset broadcast stations	15	Listening to tracks repeatedly (Repeat play)	
Cautions on storing discs.....	4	RDS (Radio Data System)	15	Listening to a specific track repeatedly (1-track repeat play).....	23
Cleaning discs.....	4	RDS search.....	16	Listening to all the tracks repeatedly (All-track repeat play).....	23
About the remote control unit		PTY search.....	16		
Inserting the batteries.....	4	TP search.....	16	Playing MP3 or WMA (Windows Media® Audio) files	
Operating range of the remote control unit.....	4	RT (Radio Text).....	16	Before playing MP3 or WMA files	24
Part names and functions		XM Satellite Radio	16	Playing MP3 or WMA files	25
Front panel.....	5	Checking the XM signal strength and Radio ID.....	17	Listening to MP3 or WMA files in random order (Random folder/disc play)	25
Display.....	5	Channel selection.....	17	Listening to MP3 or WMA files repeatedly (Repeat folder/disc play)	26
Rear panel.....	6	Category search.....	17		
Remote control unit.....	6, 7	Direct access of channels.....	17	Other types of playback	
Connections		Using the timer function		Playing an iPod®	
Cable indications	7	Setting the current time	18	Using the included iPod cable.....	27
Speaker connections	8	Before setting the timer	18	Using an exclusive control Dock for iPod.....	27
Changing the speaker cable.....	8	Setting the everyday or once timer	19	Using an Apple iPod Dock.....	27
Antenna connections		Operation of the everyday and once timers	20	Playing a portable player	27
Connecting the included antennas.....	9	Setting the sleep timer	20		
Connecting an outdoor antenna.....	9	Using other functions		System Operations	
Connecting the XM terminal	10	Setting the low-power standby mode		Auto power on function	27
Connecting a portable player	10	Setting the time display time in the standby mode.....	21	Auto function selection	27
Connecting to an iPod®		Setting the low-power standby mode (Eco mode).....	21		
When using the included iPod cable.....	10	Making the speaker settings		Others	
When using an exclusive control Dock for iPod.....	11	Setting the speakers low bass sound.....	21	Troubleshooting	28, 29
When using an Apple iPod Dock.....	11	Setting the speaker locations.....	21	Specifications	30
Connecting a CD recorder	12	Making the room damping setting.....	21		
Connecting the power supply cord	12				

Getting Started

Accessories

Check that the following parts are attached in addition to the main unit:

① Operating instructions	1
② Warranty (for North America model only)	1
③ Service station list.....	1
④ Screw.....	4
⑤ Remote control unit (RC-1035)	1
⑥ R6P/AA batteries	2
⑦ Speaker cable (Approx. 16 ft / 5 m)	2
⑧ iPod cable (Approx. 3 ft / 1 m)	1
⑨ AM loop antenna	1
⑩ FM indoor antenna.....	1
⑪ Hexagonal wrench.....	1
⑫ Wall bracket	2

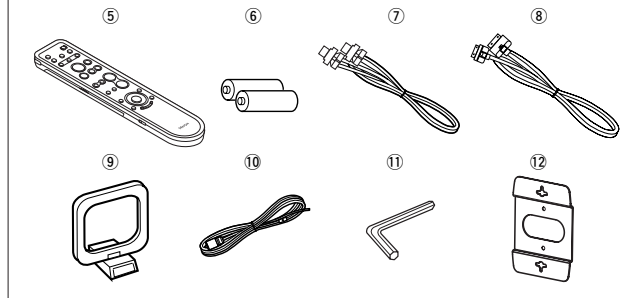

Before using

Pay attention to the following before using this unit:

- **Moving the unit.**

To prevent short-circuits or damaged wires in the connection cables, always unplug the power supply cord and disconnect the connection cables between all other audio components when moving the unit.

- **Cautions on using mobile phones.**

Using a mobile phone near this unit may result in noise. If so, move the mobile phone away from this unit when it is in use.

- **Condensation (dew).**

Water droplets may condense on internal operation parts if the set is brought into a heated room from the cold outdoors or when the room is heated rapidly. If this happens, the set may not operate properly.

- **Should condensation occur.**

The condensation will evaporate in one hour or less, at which time the system will function normally.

- **Before turning the power operation switch on.**

Check once again that all connections are correct and that there are not problems with the connection cables. Always set the power operation switch to the standby position before connecting and disconnecting connection cables.

- **Store these instructions in a safe place.**

After reading, store this instructions along with the warranty card in a safe place.

- **Power is supplied to some of the circuitry even when the power is set to the standby mode using the power operation switch.**

When traveling or leaving home for long periods of time, be sure to unplug the power supply cord from the power outlet.

- **Note that the illustrations in these instructions may differ from the actual unit for explanation purposes.**

NOTE:

- This personal audio system uses a semiconductor laser. To ensure stable operation, it is recommended to use the set indoors at a temperature of 5°C (41°F) ~ 35°C (95°F).

Cautions on installation

Note:

For heat dispersal, do not install this unit in a confined space such as a bookcase or similar enclosure.

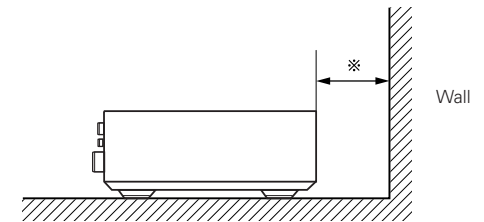
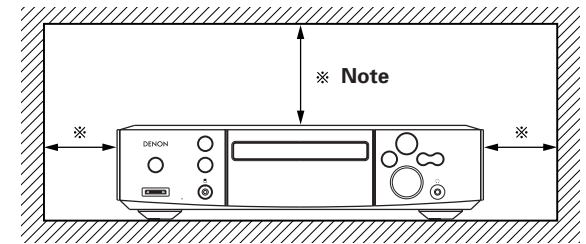

Getting Started

Speaker system (SC-S81)

When installing the speakers, pay attention to the points described below.

- Note that placing the speaker system on the same stand or shelf as a record player may result in howling.
- If a magnet or a piece of furniture or equipment using magnets is placed near the speakers, note that interaction with the S-81 could cause color blotching on the TV.
- The speakers can also be placed sideways.

Set the speaker sideways and fasten the stand securely to the speaker using the two screws that previously fastened the stand. Grasp the two edges of the saran net with your fingers and pull towards you to remove the net, then press on the back of the badge and turn the badge to set it sideways.

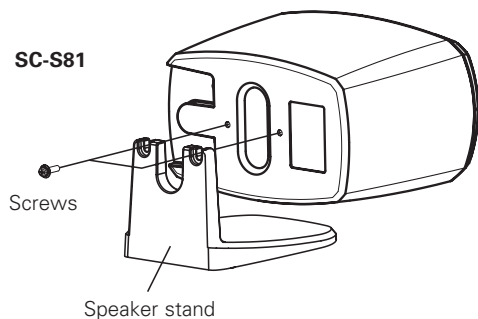

- **The speakers can also be installed using the included wall mount brackets.**

Use the four included short screws to securely fasten the wall mount bracket to the mount screw holes on the back of the speaker.

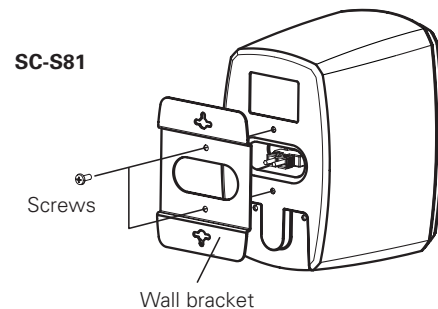

CAUTION:

- Mount on a wall sufficiently sturdy to bear the weight of the speaker. Note that DENON will except no responsibility whatsoever for damages or accidents caused by the speaker falling.
- To ensure safety, have a specialist install the speakers on the wall.
- Be sure to fasten the speaker connection cables to the wall, etc., so that you do not get your feet or hands caught in them, causing the set to fall.

About discs

Discs usable on this set

1 Music CDs

Discs with the mark at the right can be used on this set.

Note however that discs with special shapes (heart-shaped discs, octagonal discs, etc.) cannot be played. Do not attempt to play them, as doing so could damage the set.



2 CD-R/CD-RW

- Some discs and some recording formats may not be playable.
- Non-finalized discs cannot be played.

※ Finalization:

Finalization is the process that makes recorded CD-R/CD-RW discs playable on compatible players.

Getting Started

Holding discs



Do not touch the signal surface.

Loading discs

- Set the disc with the labeled side facing up.
- Make sure the disc tray is fully open when inserting the disc.
- Place the discs flatly, 12 cm discs in the outer tray guide (Figure 1), 8 cm discs in the inner tray guide (Figure 2).

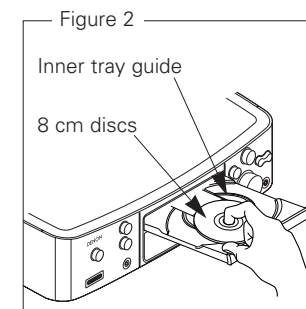
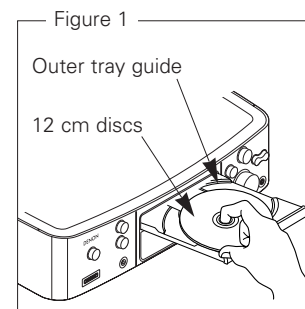

- Place 8 cm discs in the inner tray guide without using an adapter.



- In the following cases, "00 Tr 00 : 00" is shown on the display:
 - When no disc is loaded
 - When the disc is loaded upside-down
 - When the disc's information could not be read properly

Cautions on loading discs

- Only load one disc at a time. Loading two or more discs can damage the set or scratch the discs.
- Do not use cracked or warped discs or discs that have been repaired with adhesive, etc.
- Do not use discs on which the sticky part of cellophane tape or labels is exposed or on which there are traces of where labels have been removed. Such discs could get caught inside the player and damage it.

Getting Started

Cautions on handling

- Do not get fingerprints, oil or dirt on discs.
- Take special care not to scratch discs when removing them from their cases.
- Do not bend or heat discs.
- Do not enlarge the hole at the center.
- Do not write on the labeled (printed) surface with ball-point pens, pencils, etc., or stick new labels on discs.
- Water droplets may form on discs if they are moved suddenly from a cold place (outdoors for example) to a warm place, but do not try to dry them off using a hairdryer, etc.

Cautions on storing discs

- Be sure to remove discs after using them.
- Be sure to store discs in their cases to protect them from dust, scratches, warping, etc.
- Do not store discs in the following places:
 1. Places exposed to direct sunlight for long periods of time
 2. Dusty or humid places
 3. Places exposed to heat from heating appliances, etc.

Cleaning discs

- If there are fingerprints or dirt on discs, wipe them off before using the disc. If not the sound quality could be reduced and the sound may be broken.
- Use a commercially available disc cleaning set or a soft cloth to clean discs.

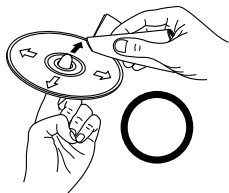

Gently wipe the disc from the inside towards the outside.

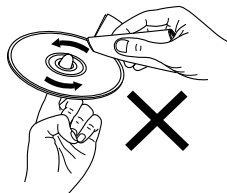

Do not wipe with a circular motion.

NOTE:

- Do not use record spray, antistatic agents, or benzene, thinner or other solvents.

About the remote control unit

Inserting the batteries

- ① Remove the remote control unit's rear cover.
- ② Set two R6P/AA batteries in the battery compartment in the indicated direction.

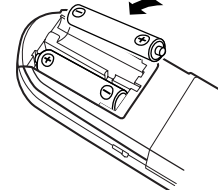
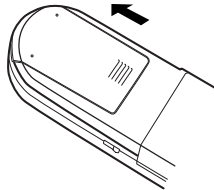

- ③ Put the rear cover back on.

Notes on batteries:

- Replace the batteries with new ones if the set does not operate even when the remote control unit is operated nearby the unit. (The attached batteries are only for verifying operation.)
- When inserting the batteries, be sure to do so in the proper direction, following the "⊕" and "⊖" marks in the battery compartment.
- To prevent damage or leakage of battery fluid:
 - Do not use a new battery together with an old one.
 - Do not use two different types of batteries.
 - Do not short-circuit, disassemble, heat or dispose of batteries in flames.
- Remove the batteries from the remote control unit when you do not plan to use it for an extended period of time.
- If the battery fluid should leak, carefully wipe the fluid off the inside of the battery compartment and insert new batteries.
- Remove the batteries from the remote if it will not be in use for long periods.

Getting Started

Operating range of the remote control unit

- Point the remote control unit at the remote sensor when operating it.
- The remote control unit can be used from a distance of up to about 23 feet/7 meters, at a horizontal angle of up to 30° with respect to the sensor.

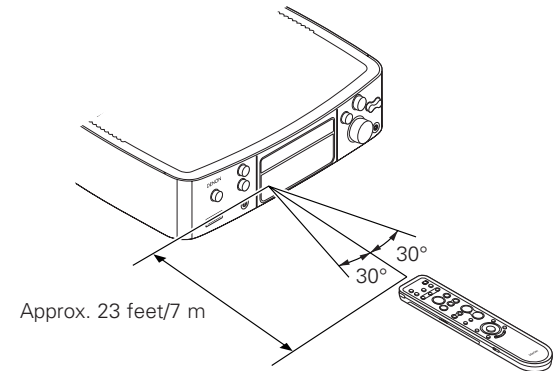

NOTE:

- It may be difficult to operate the remote control unit if the remote sensor is exposed to direct sunlight or strong artificial light.

Part names and functions

For buttons not explained here, see the page indicated in parentheses ().

Front panel

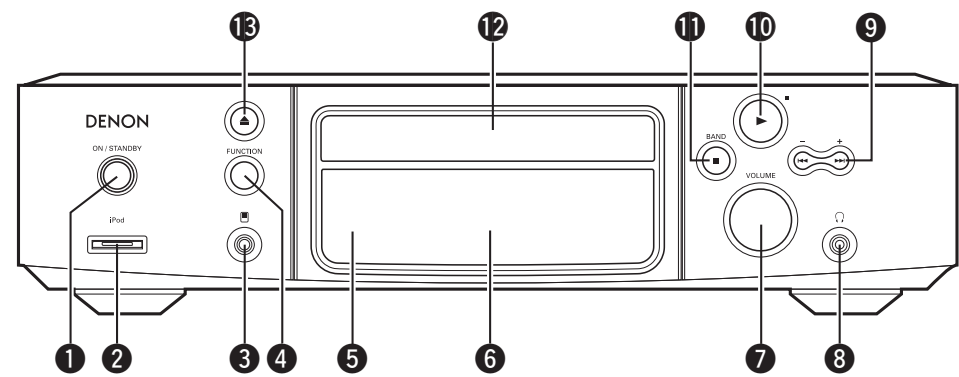

- 1 Power operation switch (ON/STANDBY)**(13)
- 2 iPod connector (iPod)**(10, 11)
- 3 Portable jack**(10)
- 4 FUNCTION button**(14, 15)
- 5 Remote control sensor**(4)
- 6 Display**(5)
- 7 VOLUME control knob**(13)
- 8 Headphones jack**
Use this jack to connect headphones (commercially available).
When headphones are plugged in, the sound can only be heard from the headphones.
- 9 Skip buttons (◀◀, ▶▶)**(13, 15, 18 ~ 23, 25, 26)
Tuning buttons (+, -)(14)
- 10 Play/Pause button (▶/⏸)**(22)
11 Stop button (■)(22)
BAND button(14 ~ 17)
- 12 Disc tray**(3)
- 13 Disc tray open/close button (⏏)**(13)

Display

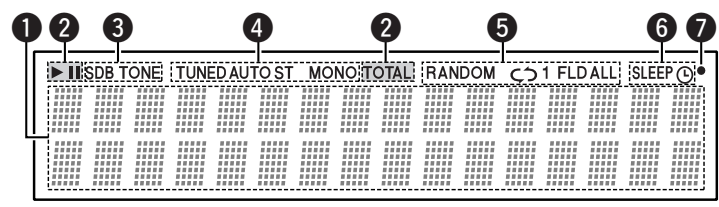

- 1 Information display**
Various types of information are displayed here.
 - General operational indications:
 - Time
 - Volume level
 - Tone adjustment level, etc.
 - When the function is set to "TUNER":
 - Name of radio station
 - Preset station name
 - When the function is set to "CD": [For a music CD/MP3/WMA]
 - Total number of folders
 - Number of tracks
 - Folder number
 - Elapsed time
 - Track name
 - Artist name
 - Album name, etc.
- 2 CD play mode indicators**
 - ▶: Lights when a disc is playing.
 - ⏸: Lights when the pause mode is set.
 - TOTAL:** Lights when the total number of tracks and total time are displayed at 1.
- 3 Tone indicators**
 - SDB:** Lights when the super dynamic bass function is set to "ON".
 - TONE:** Lights when the tone (bass/treble) is being adjusted.
- 4 Tuner reception mode indicators**
 - TUNED:** Lights when AM or FM broadcasts are properly tuned in.
 - AUTO:** Lights when in the auto stereo mode.
 - ST:** Lights when a stereo broadcast is received while in the auto stereo mode.
 - MONO:** Lights when a monaural broadcast is received while in the auto stereo mode.
- 5 CD/MP3/WMA play mode indicators**
 - RANDOM:** Lights when in the random play mode.
 - ↻: Lights when in the repeat play mode.

The display switches as follows each time the REPEAT button is pressed.

 - In modes other than the folder mode:

↻ 1 → ↻ ALL

(1-track repeat) (All-track repeat)

Not displayed ←
 - In the folder mode:

↻ 1 FLD → ↻ FLD

(1-track repeat) (All-track repeat between folders)

FLD ←
- 6 Timer operation indicator**
 - ⏸: Lights when the timer is in the standby mode.
 - SLEEP:** Lights when the sleep timer is operating.
- 7 Remote control signal reception indicator**
Lights when remote control signals are received.

Rear panel

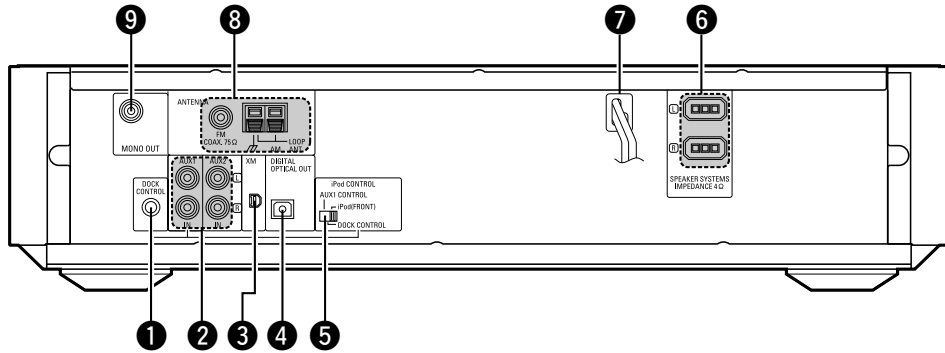

- 1 DOCK CONTROL jack(11)
- 2 Analog input terminals(11, 12)
- 3 XM terminal(10)
- 4 DIGITAL OPTICAL OUT terminal(12)
- 5 iPod CONTROL switch(10, 11)
- 6 SPEAKER SYSTEM terminals(8)
- 7 Power supply cord(12)
- 8 ANTENNA terminals(9)
- 9 MONO OUT terminal(8)

Remote control unit

NOTE:
 • If buttons on the front or rear are pressed strongly, the button on the opposite side will be activated too.

Tuner operating buttons

- BAND button(14)
- TUNING button(14)
- SEARCH buttons (<<, >>)(14)
- ENTER/MEMO button(14)
- Cursor buttons (Δ, ∇, ▷, ◁)(14)
- TIME/DISPLAY button(16)

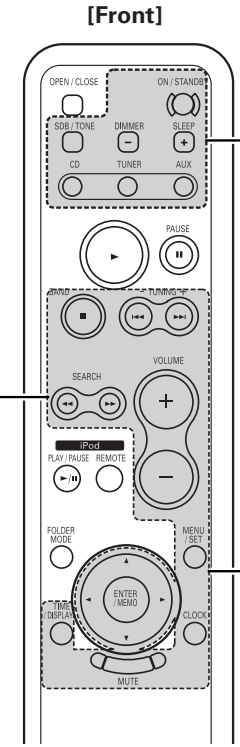

Amplifier operating buttons

- ON/STANDBY button(13)
- SLEEP button(20)
- Function buttons (CD, TUNER, AUX)(14, 22, 27)
- DIMMER button
Adjusts the brightness of the display.
- SDB/TONE button(13)
- Skip buttons (|<<<, >>>|)(13)
- VOLUME button(13)
- MENU/SET button(18, 21)
- CLOCK button(18)
- MUTE button
Mutes the sound.

Tuner operating buttons

- CLEAR button(14)
- ENTER/MEMO button(14)
- DAB/XM/RDS, PTY TIME/DISPLAY buttons(16)

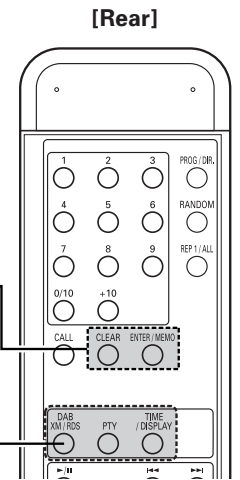

Getting Started

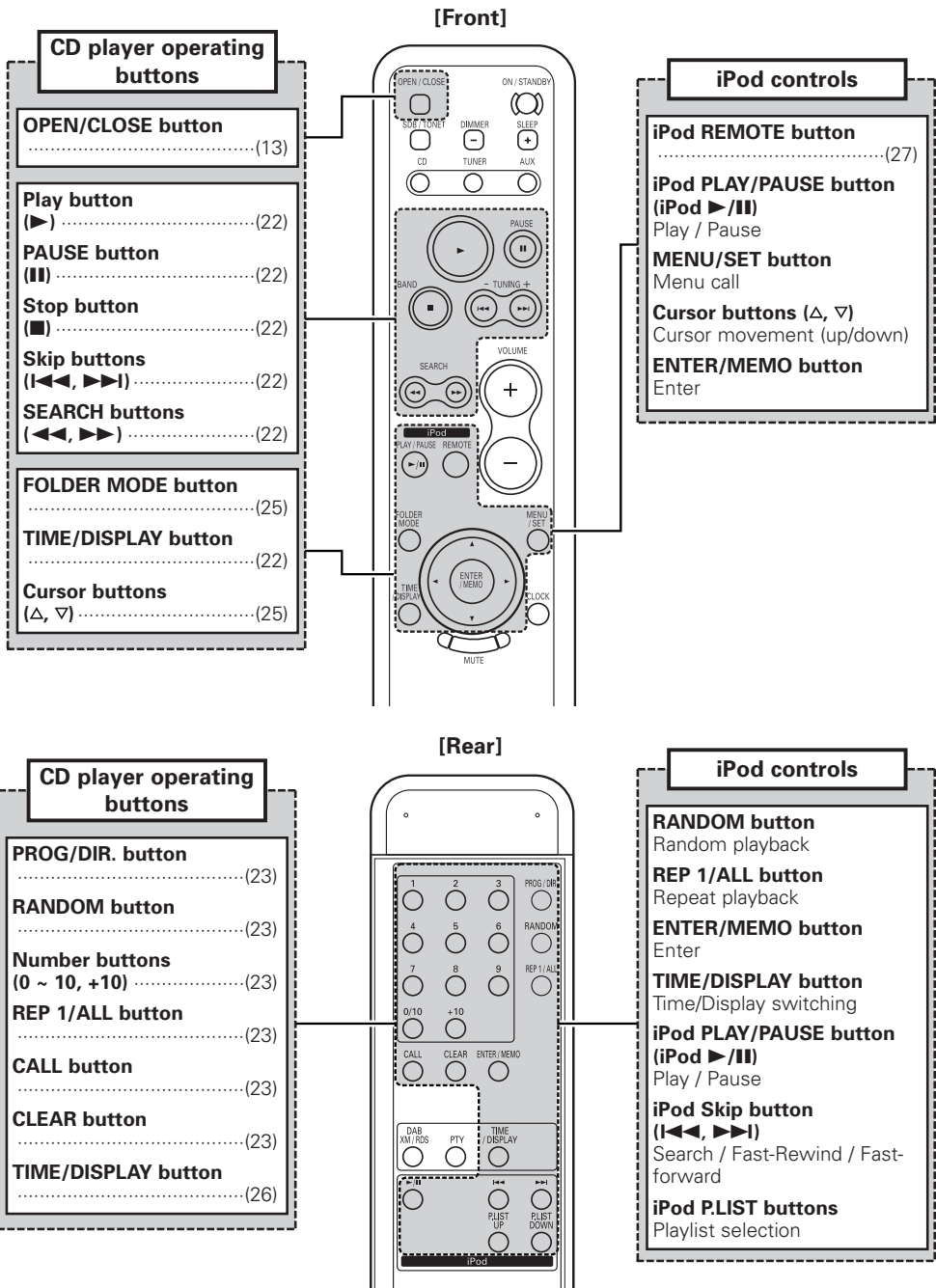

Connections

NOTE:

- Do not plug in the power supply cord until all connections have been completed.
- When making connections, also refer to the operating instructions of the other components.
- Be sure to connect the left and right channels properly (left with left, right with right).
- Do not bundle power supply cords together with speaker cables. Doing so could result in humming or noise.
- Making connections with the power turned on could result in noise or damage the speakers.
- Bunching the power supply cords and connection cables together could result in humming or noise.
- Connect all the connection cables between the different components firmly. The system may not operate properly if the connections are incomplete.
- Be sure to disconnect the power supply cords when changing the connections. Changing the connections while the system is operating could result in malfunction.

Cable indications

Connect using the connection cables shown below.

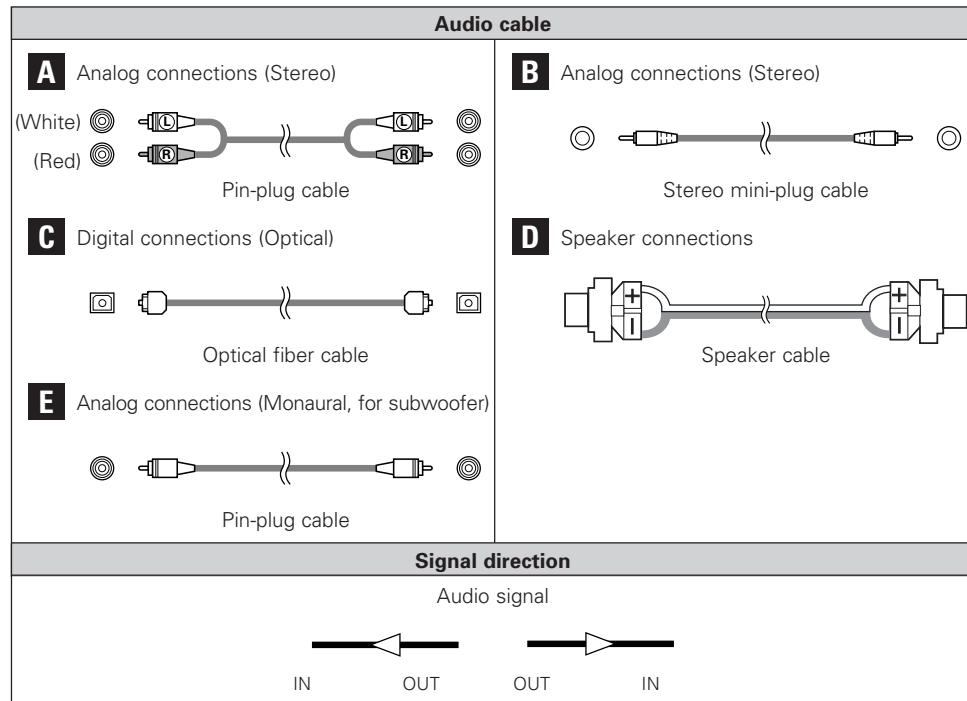

Connections

Speaker connections

A CD receiver (RCD-S81) and speaker systems (SC-S81) can be easily connected to the S-81 using the speaker cables included with the S-81.

Note on speaker impedance

If speakers with an impedance below the specified impedance (4 Ω/ohms) are used (for example, speakers with an impedance of 3 Ω/ohms) with the volume turned up high for long periods of time, the temperature may rise, activating the protective circuit.

When the protection circuit is activated, the output to the speakers is cut off and the power indicator blinks. If this happens, unplug the power supply cord, wait for the set to cool off and improve ventilation around the unit. Also check the wiring of the input cables and the speaker cables. After doing this, plug the power supply cord back in and turn the unit's power back on.

If the protection circuit is activated again even though there are no problems with the wiring or the ventilation around the unit, switch off the power and contact a DENON service center.

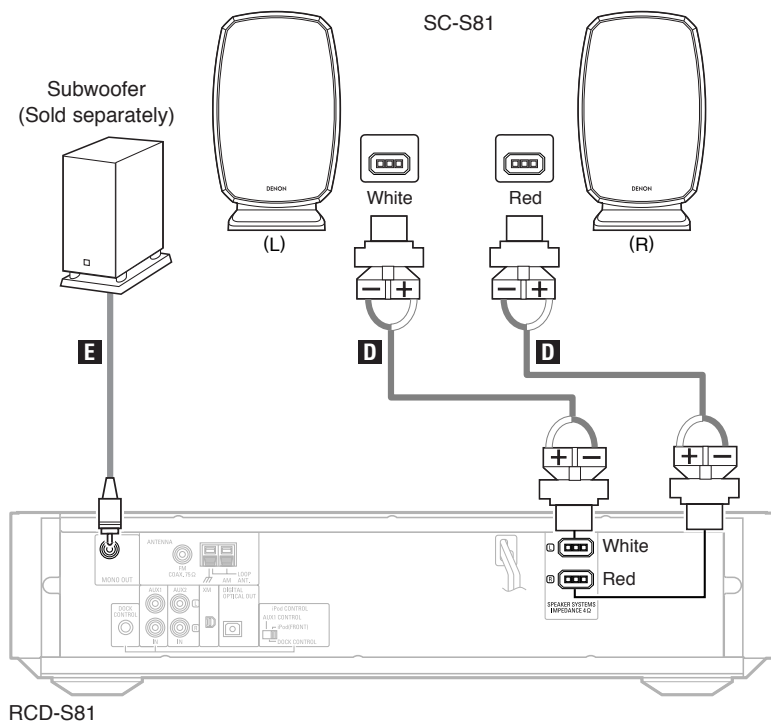

Connections

Changing the speaker cable

The speaker cable can be replaced with another one of your choice.

※ Here we describe how to connect the “+” side cable to the connector. Connect the “-” side cable in the same way.

1 Insert the hexagonal wrench (included) into the hole in the side of the “+” side connector (arrow A).

2 Turn the hexagonal wrench in the direction of arrow B to loosen the cable.

3 Completely remove the cable (arrow C).

※ Check that there are no broken pieces of core wire remaining inside the connector.

4 Peel some sheathing off the tip of the cable (core wire, copper colored), then either twist the core wire or terminate it and insert it in the direction of arrow D.

5 Turn the hexagonal wrench in the direction of arrow E and tighten securely so that the cable cannot come out.

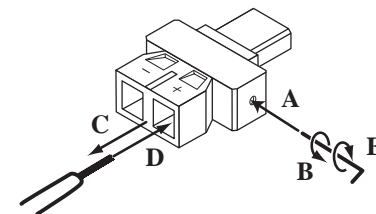

• Note that inverting the polarities will change the phase and result in unnatural sound with no bass range.

Antenna connections

Connecting the included antennas

Assembling the AM loop antenna

1. Remove.
2. Bend.
3. Insert in holes.

Connecting the AM loop antenna

1. Insert the antenna wire while pressing the lever.
2. Release the lever to fasten the antenna wire in place.

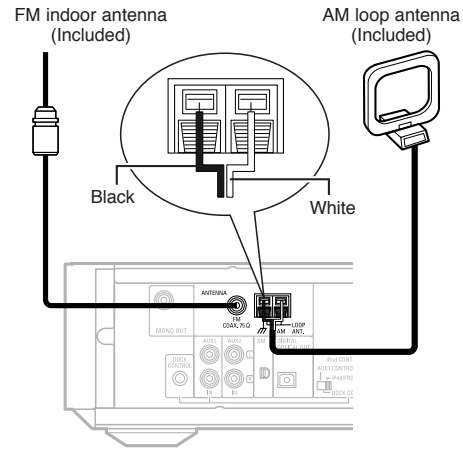

Installing the antenna

- ① Tuning in a broadcast (see page 14).
- ② Listening to the sound, move the antenna to find the position in which there is less noise.
- ③ Install the antenna.
 - Fasten the tip of the antenna using tape, etc.

NOTE:

- The S-81's ground terminal () is the ground for the AM loop antenna. It is not a safety ground.
- It is not possible to achieve good reception for AM broadcasts if the AM loop antenna is placed near a metallic object.

Connecting an outdoor antenna

In some cases better reception can be achieved by using an outdoor antenna.

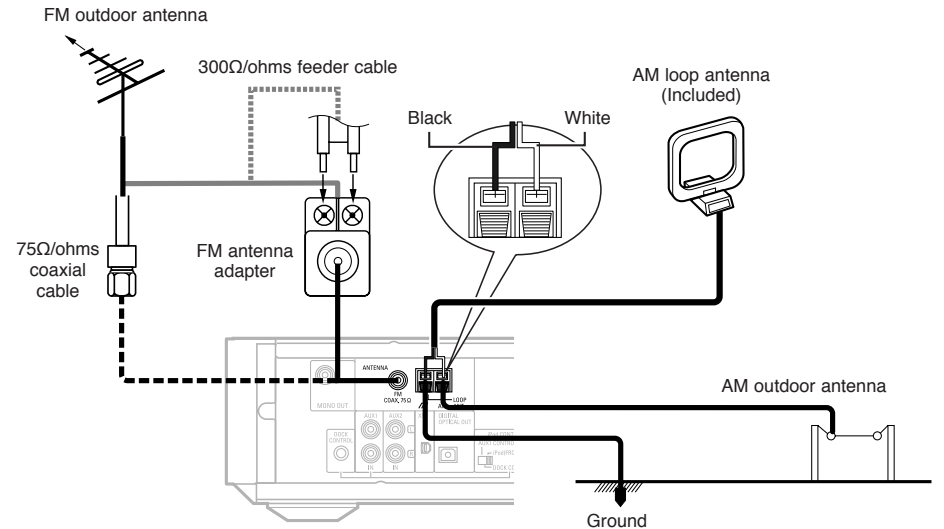

Where to install the outdoor antenna

- Place the antenna in the position in which reception is the best.
- Place away from streets or railroad tracks to avoid the influence of cars or trains.

NOTE:

- Do not place under power transmission lines. Doing so is extremely dangerous.
- To avoid attracting lightning, do not place in too high a position.
- Connecting the ground wire to a gas pipe is extremely dangerous. Never do so under any circumstances.

Connecting the FM outdoor antenna

- We recommend using a 75 Ω/ohms coaxial cable to avoid interference from other equipment.
- Be sure to disconnect the included FM antenna.

Use an FM antenna adapter (commercially available) suited for the S-81's antenna terminal.

- Refer to the FM antenna adapter's operating instructions for instructions on connecting the antenna cable to the FM antenna adapter.

Connecting an AM outdoor antenna

- Be sure to connect the ground wire to the ground terminal ().
- Be sure to also connect the included AM loop antenna.

Connections

Connecting the XM terminal

- S-81 Personal Audio System is an XM Ready® receiver. You can receive XM® Satellite Radio by connecting to the XM Passport System (sold separately) and subscribing to the XM service.
 - Plug the XM Passport System into XM terminal on the rear panel.
 - Position the XM Passport System near a south-facing window to receive the best signal. For details, see "XM Satellite Radio" (page 16, 17).
- When making connections, also refer to the operating instructions of the XM Passport System.

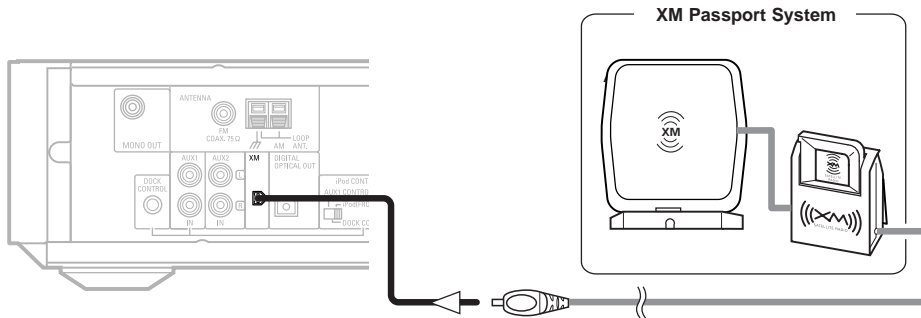

NOTE:

- Keep the power supply cord unplugged until the XM Connect-and-Play antenna connection have been completed.
- The XM name and related logo are registered trademarks of XM Satellite Radio Inc. All rights reserved.
- XM Ready is a registered trademark of XM Satellite Radio Inc. All rights reserved.

Connecting a portable player

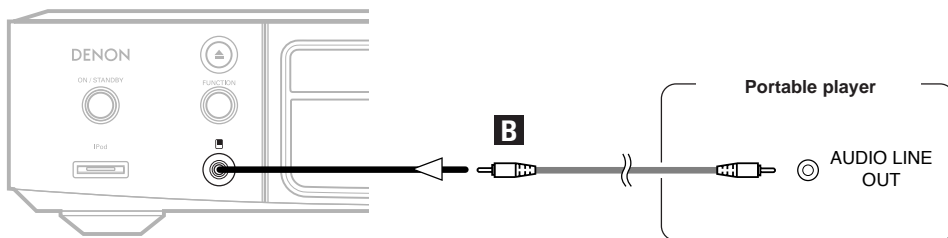

Connections

Connecting to an iPod®

When using the included iPod cable

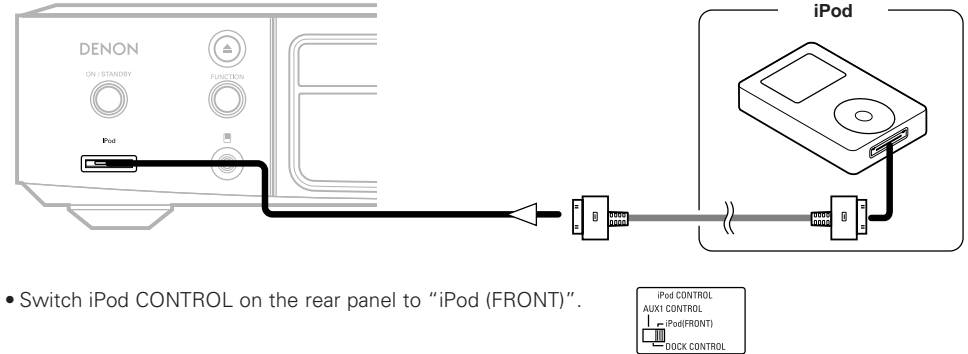

- Switch iPod CONTROL on the rear panel to "iPod (FRONT)".

When using an exclusive Control Dock for iPod

When using an Apple iPod Dock

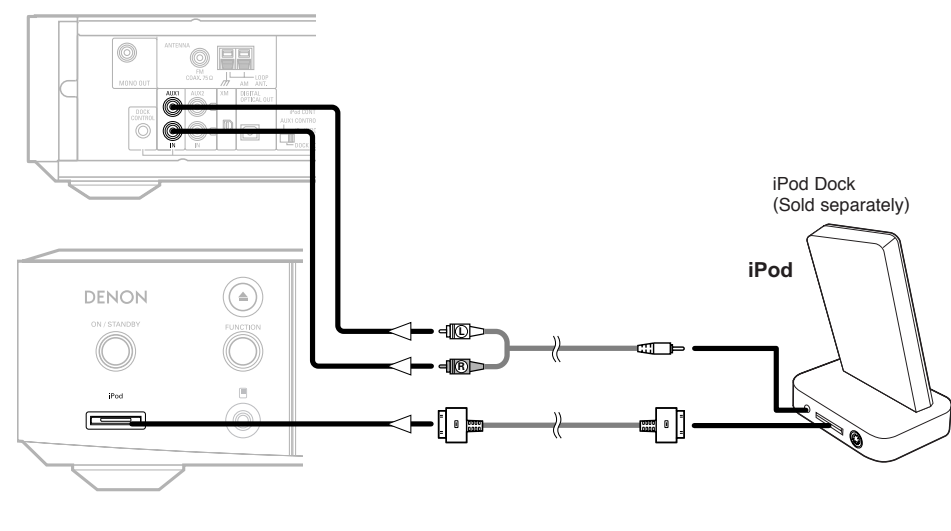
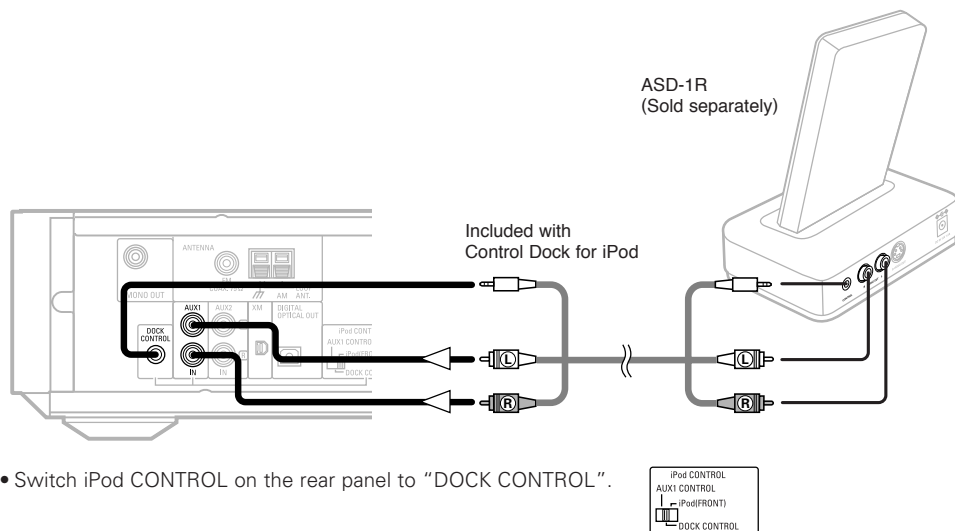

- Switch iPod CONTROL on the rear panel to "DOCK CONTROL".

- Switch iPod CONTROL on the rear panel to "AUX1 CONTROL".



- When using an Control Dock for iPod, we recommend using the exclusive Control Dock for iPod (ASD-1R (sold separately)).
- To connect the exclusive Control Dock for iPod (ASD-1R (sold separately)), use the system cable included with the exclusive Control Dock for iPod (ASD-1R (sold separately)).
- When the exclusive control Dock for iPod (sold separately) or an Apple iPod dock (sold separately) is connected, the function indication switches from "AUX1" to "AUX1/iPod".
- Turn off the power before switching the iPod CONTROL switch on the rear panel. (Refer to "Turning the power off (to the standby mode)" (page 13).)

The following iPod docks can be used with this method:

- iPod Dock M9868G/A (For iPod with color displays)
- iPod Dock MA072G/A (For iPod nanos)



iPod is a trademark of Apple Computer, Inc., registered in the U.S. and other countries.

Connections

Connecting a CD recorder

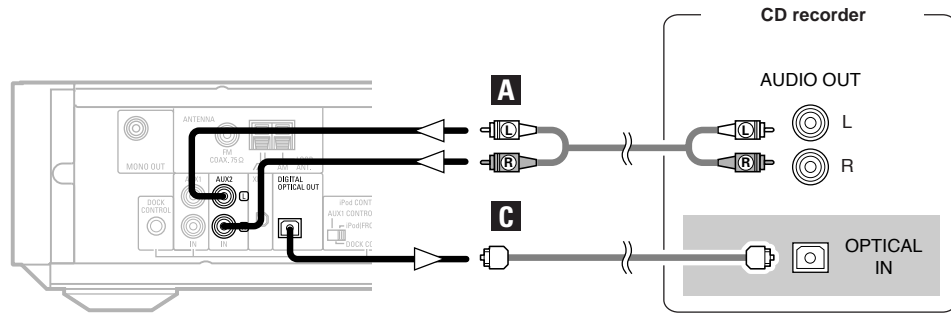

Connections

Connecting the power supply cord

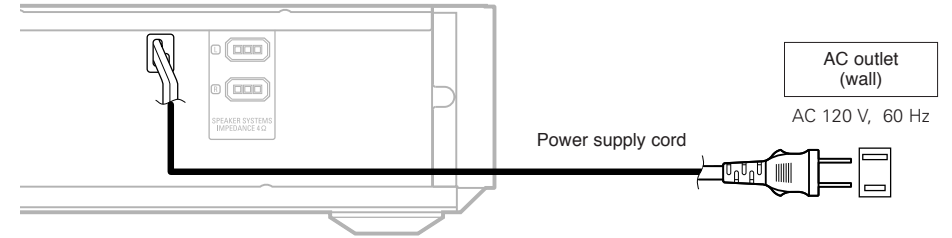

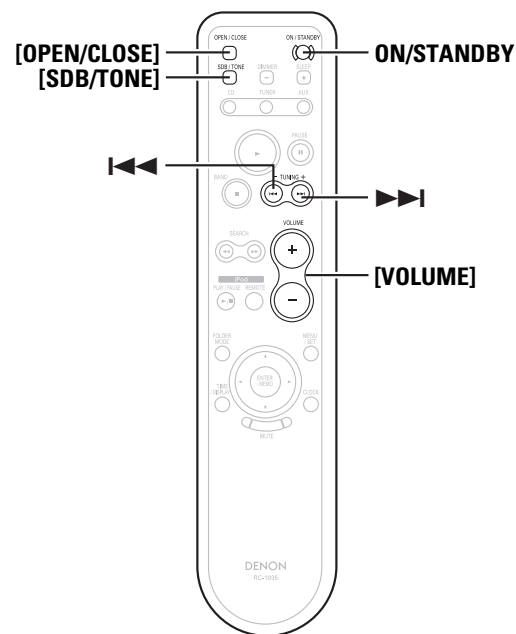
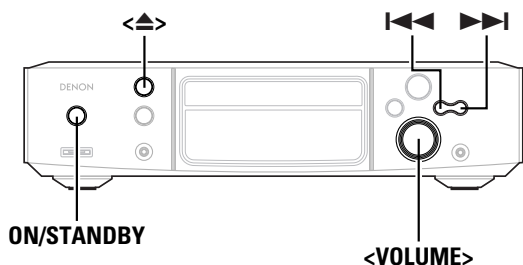

About the button names in this explanation
 < > : Buttons on the main unit
 [] : Buttons on the remote control unit
Button name only :
 Buttons on the main unit and remote control unit

Basic Operation

Turning the power on

Press **ON/STANDBY**.

※ When the power is turned on, the function that was being used when the power was last turned off is selected (selector function).

Turning the power off (to the standby mode):
 Press **ON/STANDBY** again.



- Information on the power indicator
 - Power onBlue
 - Standby mode.....Red
 - Low-power standby mode.....Off (※) (page 21)
 - Timer standby modeOrange
- ※ When in the low-power standby mode, a very small amount of power is consumed, even if all the indicators are turned off.

Loading discs

(page 3)

Press <▲> or [OPEN/CLOSE] to open the disc tray.

To close the disc tray:
 Press <▲> or [OPEN/CLOSE] again.

NOTE:

- Be sure to turn on the power when opening and closing the disc tray.
- Do not push the disc tray in by hand when the power is off. Doing so could damage it.
- Do not insert foreign objects into the disc tray. Doing so will damage it.

Adjusting the volume

Turn <VOLUME> or press [VOLUME].

Adjusting the tone

1 Use [SDB/TONE] to select the tone parameter to be adjusted.

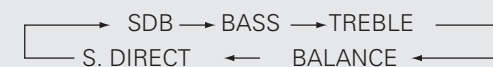

- SDB:** Adjusts the low bass sound.
- BASS:** Adjusts the bass sound.
- TREBLE:** Adjusts the treble sound.
- BALANCE:** Adjusts the left/right volume balance.
- S. DIRECT:** The sound is played with the tone flat.

2 To emphasize the low bass sound:
 When “SDB ON/OFF” is displayed, use <◀◀ or ▶▶> to select “ON” or “OFF”.

2 To adjust the bass or treble sound:
 When “BASS” or “TREBLE” level is displayed, use <◀◀ or ▶▶> to adjust.

2 To adjust the left/right volume balance:
 When “BALANCE” is displayed, use <◀◀ or ▶▶> to adjust.



- The tone is only flat when “S.DIRECT” is selected. To adjust the tone controls set a mode other than “S.DIRECT”.

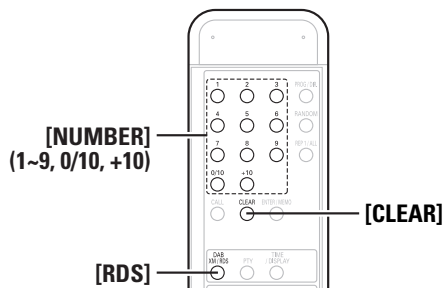
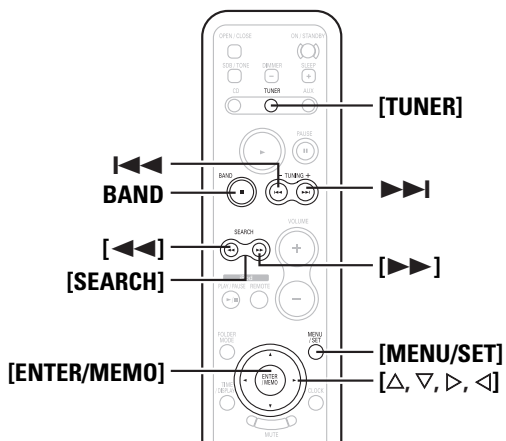
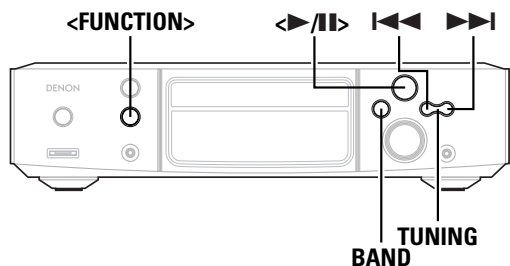

About the button names in this explanation
 < > : Buttons on the main unit
 [] : Buttons on the remote control unit
Button name only :
 Buttons on the main unit and remote control unit

Listening to radio broadcasts

Selecting a radio station

1 Use <FUNCTION> or [TUNER] (FUNCTION) to select "TUNER".

- The reception frequency is displayed.

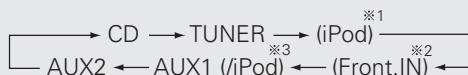

- *1 Can be selected when **iPod CONTROL** on the rear panel is switched to "iPod (FRONT)" and the included iPod cable is used.
- *2 **Front IN** can only be selected when a portable player is connected.
- *3 Can be selected when **iPod CONTROL** on the rear panel is switched to "AUX1 CONTROL" or "DOCK CONTROL" and an Apple iPod Dock (sold separately) or and exclusive control Dock for iPod (ASD-1R (sold separately)) is connected.

2 Use BAND to select the reception band.

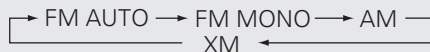

3 Use [SEARCH] to tune in the station.

- The "TUNED" indicator lights when a station is tuned in.

FM station reception conditions

- When the reception mode is set to "FM AUTO", the "ST" indicator lights when a stereo broadcast is tuned in.
- If the signal is weak and the stereo broadcast reception is not stable, set the reception band mode is set to "FM MONO". The "MONO" indicator lights.

Auto tuning

If one of [◀◀], [▶▶] is pressed and held in, the next station is searched for automatically. Stations cannot be tuned in if their signal is weak.

• To stop auto tuning

Press one of [◀◀], [▶▶].

Manual tuning

The reception frequency changes one step each time one of [◀◀], [▶▶] is pressed.



- Noise may be produced in the sound when receiving AM broadcasts if there is a monitor or other such device nearby. If so, move the S-81 and monitor as far apart as possible.

Giving a name to the currently tuned in broadcast station and presetting it

- A total of 60 FM and AM broadcast stations combined can be preset.
- Preset stations can be given names of up to 8 characters.

1 Tune in the broadcast station.

- The reception frequency is displayed.

2 Press [ENTER/MEMO] twice.

- The name input mode is set.

3 Use [Δ] or [▽] to select the desired character.

- Up to 8 characters can be input. The characters that can be input are as shown below.

A	B	C	D	E	F	G	H	I	J	K	L	M	N	O	P	Q	R	S	T	U	V	W	X	Y	Z
0	1	2	3	4	5	6	7	8	9																
										^ ' () * + , - . / = (space)															

- * Use [◀] or [▶] to move the cursor.

- * Press [CLEAR] to delete characters.

4 Press [MENU/SET].

5 Use [Δ] or [▽] to select the preset number, then press [MENU/SET].

- The reception frequency and reception mode are preset.

Listening to radio broadcasts

To change the name of a preset station:

- ① Call out the station whose name you want to change, then press **[ENTER/MEMO]** twice.
- ② Perform step **3** under "Giving a name to the currently tuned in broadcast station and presetting it".

To only preset the station:

- ① Press **[ENTER/MEMO]** while the station is tuned in. The "preset number" display flashes.
- ② Perform step **5** under "Giving a name to the currently tuned in broadcast station and presetting it".

NOTE:

- If a station is preset at a number where a station has already been preset, the old setting is deleted and replaced with the new setting.

Presetting broadcast stations automatically (Auto preset)

- 1** Use **<FUNCTION>** or **[TUNER] (FUNCTION)** to select "TUNER".
 - The reception frequency is displayed.
- 2** Press and hold **<>/II>**.
 - "AUTO PRESET" is displayed.
- 3** Press **<>/II>**.
 - Broadcast stations are preset automatically.

To stop the auto preset operation before it is completed:

Press **BAND**.



- Broadcast stations whose signals are weak cannot be preset automatically. To preset them, tune them in manually, then follow the operation described at "Giving a name to the currently tuned in broadcast station and presetting it".

Listening to preset broadcast stations

Example: To listen to the FM station preset at preset number 3.

Press [3] (NUMBER).

- Preset number "3" is displayed.
- ※ For preset numbers 1 to 10, press the corresponding **[1]** to **[0/10]**.
- For preset numbers 10 and on, first press **[+ 10]** then press **[0]** to **[0/10]**.
- Example:** Preset 12 : **[+ 10] [2]**.
- Example:** Preset 20 : **[+ 10] [0/10]**.
- ※ The preset number can also be chosen using **[I<<<]** or **[>>>I]**.

About the tuning and preset modes

<I<<<> and **<>>>I** can be used both to select the reception frequency (tuning mode) and to select the preset station (preset mode).

• **Switching between the tuning and preset modes**

- ① To switch to the tuning mode: Press **<I<<<>** while pressing **BAND**. The "TUNING" indicator flashes. **<I<<<>** and **<>>>I** operate in the same way as **[<<<]** and **[>>>]**.
- ② To switch to the preset mode: Press **<>>>I** while pressing **BAND**. The "PRESET" indicator flashes. **<I<<<>** and **<>>>I** operate in the same way as **[I<<<]** and **[>>>I]**.

Listening to radio broadcasts

RDS (Radio Data System)

RDS (works only on the FM band) is a broadcasting service which allows station to send additional information along with the regular radio program signal.

Program Type (PTY)

PTY identifies the type of RDS program.

NEWS	News
INFORM	Information
SPORTS	Sports
TALK	Talk
ROCK	Rock
CLS ROCK	Classical Rock
ADLT HIT	Adult Hits
SOFT RCK	Soft Rock
TOP 40	Top 40
COUNTRY	Country
OLDIES	Oldies Music
SOFT	Soft

NOSTALGA	Nostalgia
JAZZ	Jazz Music
CLASSICL	Classical Music
R & B	R & B
SOFT R&B	Soft R & B
LANGUAGE	Language
REL MUSC	Religious Music
REL TALK	Religious Talk
PERSNLTY	Personality
PUBLIC	Public
COLLEGE	College
WEATHER	Weather

Traffic Program (TP)

TP identifies programs that carry traffic announcements.

Radio Text (RT)

RT allows the RDS station to send text messages that appear on the display.

NOTE:

- The operations described below pressing **[RDS]** will not function in areas in which there are no RDS broadcasts.

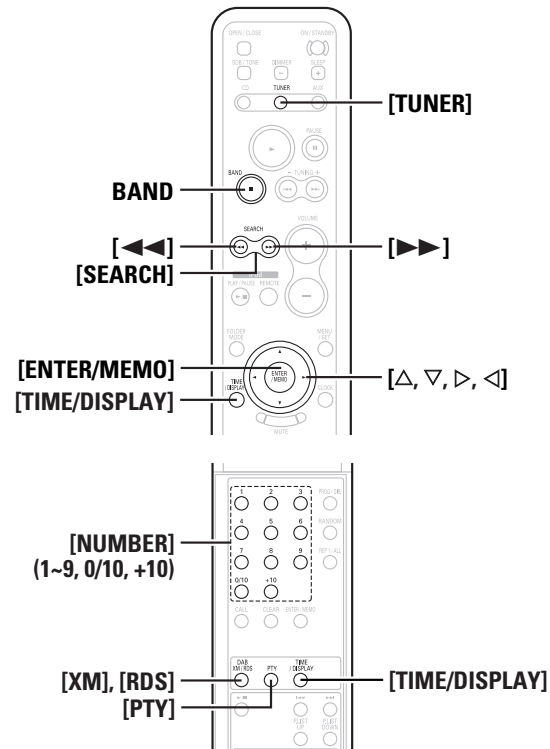
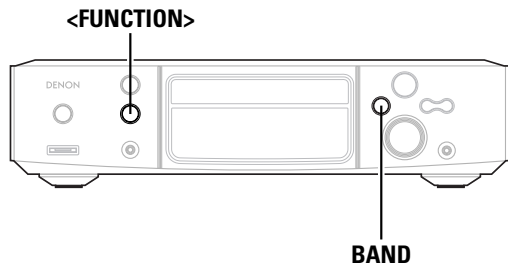

About the button names in this explanation
 < > : Buttons on the main unit
 [] : Buttons on the remote control unit
Button name only :
 Buttons on the main unit and remote control unit

RDS search

- 1 Use **BAND** to select "FM AUTO".
 - 2 Press **[RDS]**.
 - 3 Press **[SEARCH]**.
 - Automatically begin the RDS search operation.
- ※ If no RDS station is found, "NO PROGRAM" is displayed.

PTY search

- 1 Use **BAND** to select "FM AUTO".
 - 2 Press **[RDS]** twice.
 - 3 Use **[PTY]** to select the type of program.
 - 4 Press **[SEARCH]**.
 - Automatically begin the PTY search operation.
- ※ If no program of the specified type is found, "NO PROGRAM" is displayed.

TP search

- 1 Use **BAND** to select "FM AUTO".
 - 2 Press **[RDS]** three times.
 - 3 Press **[SEARCH]**.
 - Automatically begin the TP search operation.
- ※ "NO PROGRAM" is displayed when there is no traffic information broadcast station.

RT (Radio Text)

Press **[TIME/DISPLAY]** until "Radio Text" scrolls on the display.

※ When the station currently tuned in is offering a radio text message service, the message scrolls on the display.

- When the RT mode is turned on while an RDS radio station not offering an RT service is tuned in, "NO TEXT" is displayed on the display, then the mode automatically switches to the PS mode.
- In the same way, the mode automatically switches to the PS mode when the RT service is finished. In this case, the mode automatically switches from the PS mode back to the RT mode when an RT broadcast is resumed.
- The RT mode cannot be set in the AM band or for FM stations not offering RDS broadcasts.
- To turn the RT mode off, use **[TIME/DISPLAY]** and switch to the desired display mode.

XM Satellite Radio

S-81 Personal Audio System is an XM Ready® receiver. You can receive XM® Satellite Radio by connecting to the XM Passport System (sold separately) and subscribing to the XM service.

Introducing XM Satellite Radio

There's a world of audio listening pleasure beyond AM and FM. XM Satellite Radio. Select from over 150 channels of music, news, sports, comedy, talk, and entertainment. Coast-to-coast coverage. Digital quality sound. With all music channels 100% commercial free.

Questions?: Visit www.xmradio.com.

How to Subscribe

Listeners can subscribe by visiting XM on the Web at www.xmradio.com or by calling XM's Listener Care at (800) 967-2346.

Customers should have their Radio ID and credit card ready. The Radio ID can be found by selecting channel 0 on the radio.

Listening to radio broadcasts

A Warning Against Reverse Engineering

It is prohibited to copy, decompile, disassemble, reverse engineer, or manipulate any technology incorporated in receivers compatible with the XM Satellite Radio system. Furthermore, the AMBE® voice compression software included in this product is protected by intellectual property rights including patent rights, copyrights, and trade secrets of Digital Voice Systems, Inc. The user of this or any other software contained in an XM Radio is explicitly prohibited from attempting to copy, decompile, reverse engineer, or disassemble the object code, or in any other way convert the object code into human-readable form. The software is licensed solely for use within this product.

Hardware and required \$12.95 monthly service subscription sold separately. Other fees and taxes, including a one-time activation fee may apply. Subscription fee is consumer only. All fees and programming subject to change. Channels with frequent explicit language are indicated with an XL. Channel blocking is available for XM radio receivers by calling 1-800-XMRADIO. Subscriptions subject to Customer Agreement available at xmradio.com. XM service only available in the 48 contiguous United States. ©2006 XM Satellite Radio Inc. All rights reserved.

Checking the XM signal strength and Radio ID

- Use <FUNCTION> or [TUNER] (FUNCTION) to select "TUNER".
- Press BAND to select "XM".
 - The reception channel number is displayed.
- Press [TIME/DISPLAY] until "SIGNAL" is displayed.
 - The display changes as shown below according to the receiving condition.

Display	Condition
GOOD	Signal strength is good
MARGINAL	Signal strength is marginal
WEAK	Signal strength is poor
NO	Loss of the signal

- Adjust the antenna location until "SIGNAL:GOOD" is displayed.

- Press [TIME/DISPLAY] until the XM channel (ex.CH001) is displayed.

- Press [◀◀] to select channel 0 (XM000).



Channel selection

- Use <FUNCTION> or [TUNER] (FUNCTION) to select "TUNER".
- Press BAND to select "XM".
 - The reception channel number is displayed.



- Press [◀◀] or [▶▶] to reach the desired channel.
 - The channel changes continuously when you press and hold [SEARCH].

Category search

- Press [◀▶] in the XM mode.
 - The current category name is displayed.

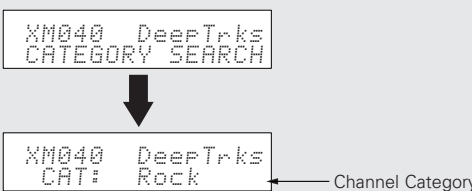

- Use [◀▶] to select the category, and press [△ ▽] to select the channel within the selected category.

Listening to radio broadcasts

Direct access of channels

- Press [XM].
- Press [NUMBER].
 - For example, if you want to access channel 123 (ex.CH123) press [NUMBER] as shown below.

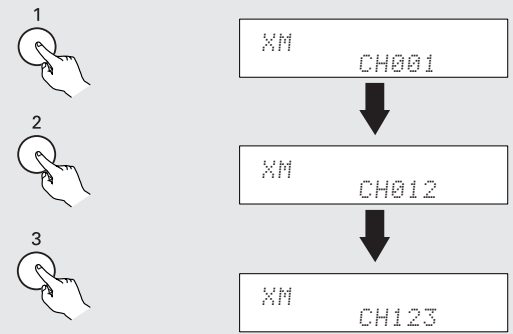

- Once all number have been input, press [ENTER/MEMO] to change the channel.
 - If the next [NUMBER] is not pressed within several seconds, the channel automatically switches to the channel number that was input.

- "LOADING" is displayed while receiving the channel or information.
- "UPDATING" is displayed while updating encryption code.
- When the selected channel is not available, "CH--" is displayed.
- Information on the artist name, song title, category and signal level can be checked using [TIME/DISPLAY].
- The XM Satellite Radio channels can be preset in the same way as AM/FM band (page 15).

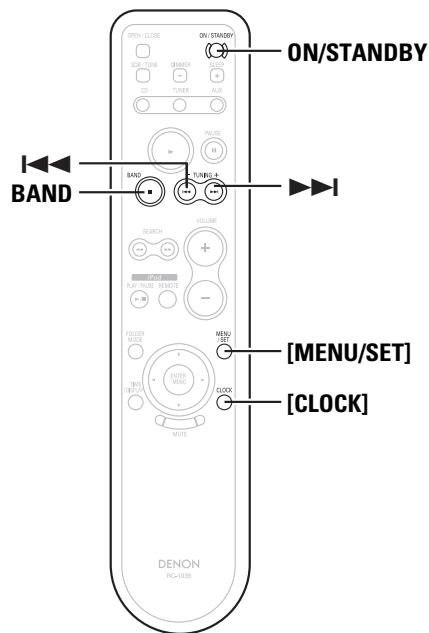
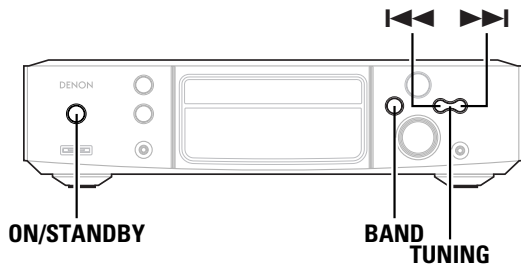

About the button names in this explanation
 < > : Buttons on the main unit
 [] : Buttons on the remote control unit
Button name only :
 Buttons on the main unit and remote control unit

Using the timer function

Setting the current time

The S-81's clock displays the time in the 12-hour mode.

Example: To set the current time to "PM 7:30"

- 1 Press [CLOCK].**
- 2 Press and hold [MENU/SET].**
 - "TIME Adj" is displayed.
 - The hour's display flashes.
- 3 Use << or >> to set the hours to "PM 7".**
 - "7" flashes.
- 4 Press [MENU/SET].**
 - The minute's display flashes.
- 5 Use << or >> to set the minutes to "30".**
 - "30" flashes.
- 6 Press [MENU/SET] simultaneously with the tone of a time casting, etc.**
 - "TIME Adj" turns off.
 - The current time is displayed.



- If [MENU/SET] is pressed before the time is set, the time setting mode is set.
- If the current time has been set, it can be displayed by pressing [CLOCK].
- In the standby mode, the current time can also be displayed by pressing [MENU/SET].

NOTE:

- The time cannot be set when in the standby mode. Turn on the power first.

Before setting the timer

Types of timers

The S-81 has three timer functions.

- ① Everyday timer:
Use this to play at the set time every day.
- ② Once timer:
Use this to play once only at the set time.
- ③ Sleep timer:
Use this to turn off the power after up to 90 minutes, set in intervals of 10 minutes.

Order of priority for the timers

- If the times set for the three timers overlap, the sleep timer has priority.
- If the times set for the everyday and once timers overlap, the once timer has priority.

If there is a power cut

- The current time setting is canceled. Turn the power on and reset the current time.
- The timer settings are cleared. Set the timer again.
- The tuner's presettings may be cleared. If so, perform the presetting procedure again.

NOTE:

- If the current time is not set, the timer standby indicator "⊖" will not light.
- When the timer is set, the timer standby indicator "⊖" lights.

Using the timer function

Setting the everyday or once timer

Be sure to set the current time first (☞ page 18).

Example 1: Listening to preset number “3” with the everyday timer

- To use the timer function to listen to AM or FM broadcasts, be sure to preset the desired station first (☞ page 14).

1 Press [MENU/SET] once.

- “TIMER” flashes.

2 Use |◀◀ or ▶▶| to select “EVERYDAY”, then press [MENU/SET].**3 Use |◀◀ or ▶▶| to select “TUNER”, then press [MENU/SET].****4 Use |◀◀ or ▶▶| to select preset number “3”, then press [MENU/SET].**

- The presettings are stored in the memory.

5 Perform steps 3 to 5 under “Setting the current time” (☞ page 18) to set the timer start time.**6 Perform steps 3 to 5 under “Setting the current time” (☞ page 18) to set the timer stop time.****7 Use |◀◀ or ▶▶| to select “1_off / E_on”, then press [MENU/SET].**

- The timer standby indicator “⏻” lights. The time is now set.

- ※ For details, see “Operation of the everyday and once timers” (☞ page 20).

8 Press ON/STANDBY.

- The power is set to the standby mode and the power indicator lights orange.

- ※ When the timer start time is reached, the timer operates.

❑ If you make a mistake while setting the timer:

- ① Press **BAND** at any step from **3 ~ 6**.
- ② Use **[MENU/SET]** to select the item you want to correct, then make the correct setting.
- ③ Use **[MENU/SET]** to proceed to step **7**.

❑ To check the timer settings:

- ① Perform steps **1** and **2** on page 19.
- ② Press **[MENU/SET]** repeatedly.

❑ To change the timer settings:

- Perform steps **1 ~ 8** at the left to change the settings as desired. The timer settings change to the new settings.

- ※ To change a setting while still in the timer setting mode, press **BAND** then perform steps **3 ~ 8** at on page 19 and above.

❑ To delete the timer settings:

- ① Perform steps **1** and **2** on page 19.
- ② Press and hold **BAND** while “EVERYDAY” or “ONCE” is displayed.

❑ To stop the timer setting:

- Select “1_off/E_off” at step **2** under “Operation of the everyday and once timers” (☞ page 20).

Using the timer function

Example 2: Listening to a CD using the once timer

- Load the CD you want to play beforehand.

1 Press [MENU/SET] once.

- “TIMER” flashes.

2 Use |◀◀ or ▶▶| to select “ONCE”, then press [MENU/SET].**3 Use |◀◀ or ▶▶| to select “CD”, then press [MENU/SET].****4 Perform steps 3 to 5 under “Setting the current time” (☞ page 18) to set the timer start time.****5 Perform steps 3 to 5 under “Setting the current time” (☞ page 18) to set the timer stop time.****6 Use |◀◀ or ▶▶| to select “1_off / E_on”, then press [MENU/SET].**

- The timer standby indicator “⏻” lights. The time is now set.

- ※ For details, see “Operation of the everyday and once timers” (☞ page 20).

7 Press ON/STANDBY.

- The power is set to the standby mode and the power indicator lights orange.

- ※ When the timer start time is reached, playback starts from the first track on the CD.

Using the timer function

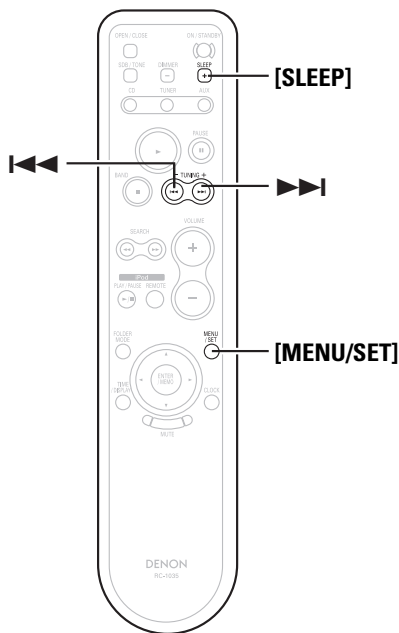
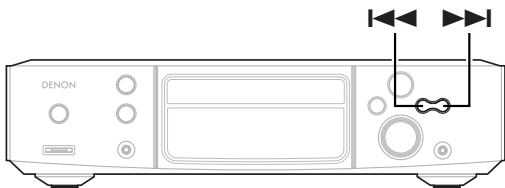

About the button names in this explanation
 < > : Buttons on the main unit
 [] : Buttons on the remote control unit
Button name only :
 Buttons on the main unit and remote control unit

Operation of the everyday and once timers

After setting the timer at "Setting the everyday or once timer" (page 19), select the timer(s) you want to operate.

1 Press [MENU/SET] twice.
 • The current settings are displayed.

2 Use << or >> to select the timer(s) you want to operate.

- 1_off / E_off : Neither the once nor the everyday timer operates.
- 1_on / E_on : Both the once and the everyday timers operate.
- 1_off / E_on : Only the everyday timer operates.
- 1_on / E_off : Only the once timer operates.

※ If only the everyday timer is set, the display switches as follows when << or >> is pressed.

1_off / E_on ↔ 1_off / E_off

※ If only the once timer is set, the display switches as follows when << or >> is pressed.

1_off / E_off ↔ 1_on / E_off

If you do not want the timer to operate:
 Use << or >> to turn off the timer standby indicator "⏸".

Using the timer function

Setting the sleep timer

Example: Setting so that the power turns off in 80 minutes.

1 Press [SLEEP] during playback.
 • The "SLEEP" indicator flashes.



2 Press [SLEEP] repeatedly while the "SLEEP" indicator is flashing to select "80".

• The "SLEEP" indicator stops flashing, remaining lit, after about 5 seconds.

※ The power is set to the standby mode after 80 minutes.

Canceling the sleep timer:
 Press [SLEEP] repeatedly to select "OFF".

- The remaining time is displayed when [SLEEP] is pressed while the sleep timer is operating.
- If [SLEEP] is pressed while the remaining time is displayed, "OFF" is selected. Reset the timer as desired.

Using other functions

Setting the low-power standby mode

Setting the time display time in the standby mode

1 Use [MENU/SET] to select “TIME DISPLAY”.

2 Use ◀◀ or ▶▶ to select “10SEC” or “CONTINUE”, then press [MENU/SET].

10 SEC (Set upon purchase):

The display automatically turns off after approximately 10 seconds.

CONTINUE:

Displayed continuously.

Setting the low-power standby mode (Eco mode)

1 Use [MENU/SET] to select “ECO MODE”.

2 Use ◀◀ or ▶▶ to select “ON” or “OFF”, then press [MENU/SET].

ON (Set upon purchase):

Low-power standby mode.

OFF:

Normal mode.

※ See page 13 for information on the power indicator.

Making the speaker settings

This procedure can be used to set the optimum sound quality for your speakers and the installation conditions in your room.

Setting the speakers low bass sound

Set this according to the speakers being used.

1 Use [MENU/SET] to select “SPK OPTIMISE”.

2 Use ◀◀ or ▶▶ to select “ON” or “OFF”, then press [MENU/SET].

ON (Set upon purchase):

This is the optimum setting for the SC-S81 (the speaker included with the S-81). (We recommend using this setting normally.)

OFF:

Set this when using speakers other than the ones included. (For directions and cautions on connecting the speakers, see “Speaker connections” (▶ page 8).)

Setting the speaker locations

Set the locations in which the speakers are installed.

※ This cannot be set when “SPK OPTIMISE” is set to “OFF”.

1 Use [MENU/SET] to select “SPK LOCATION”.

2 Use ◀◀ or ▶▶ to select “ON WALL” or “ON SHELF”, then press [MENU/SET].

ON WALL:

Set this when the speakers are installed on a wall or when there is a wall directly behind them.

ON SHELF (Set upon purchase):

Set this when using the included speaker stand.

Making the room damping setting

Set this according to the level of the reverberations in the room.

※ This cannot be set when “SPK OPTIMISE” is set to “OFF”.

1 Use [MENU/SET] to select “ROOM DAMPING”.

2 Use ◀◀ or ▶▶ to select “LOW”, “MID” or “HIGH”, then press [MENU/SET].

LOW:

Set this when the reverberations in the room are too weak (when there is not enough treble sound).

MID (Set upon purchase):

Set this when the reverberations in the room are moderate.

HIGH:

Set this when the reverberations in the room are too strong (when there is too much treble sound).

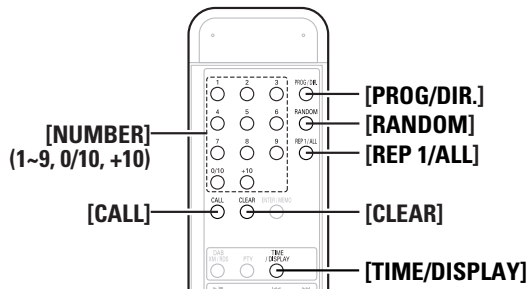
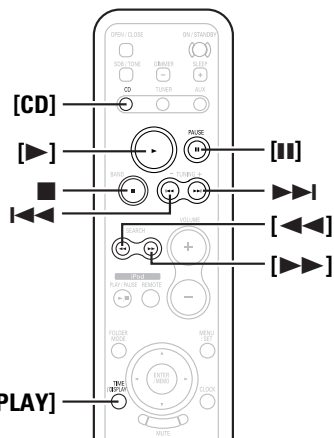
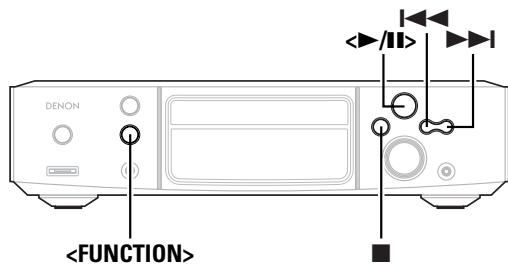

About the button names in this explanation
 < > : Buttons on the main unit
 [] : Buttons on the remote control unit
Button name only :
 Buttons on the main unit and remote control unit

Playing discs

Starting playback

1 Use <FUNCTION> or [CD] (FUNCTION) to select "CD".

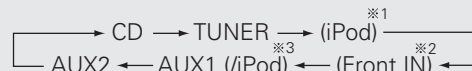

- ※ 1 Can be selected when **iPod CONTROL** on the rear panel is switched to "iPod (FRONT)" and the included iPod cable is used.
- ※ 2 **Front IN** can only be selected when a portable player is connected.
- ※ 3 Can be selected when **iPod CONTROL** on the rear panel is switched to "AUX1 CONTROL" or "DOCK CONTROL" and an Apple iPod Dock (sold separately) or and exclusive control Dock for iPod (ASD-1R (sold separately)) is connected.

2 Press <>/II> or [>].

- The "▶" indicator lights and playback starts.
- ※ Once all the tracks recorded on the disc have been played, the stop mode is set automatically.
- ※ [TIME/DISPLAY] can be used to switch the information displayed.

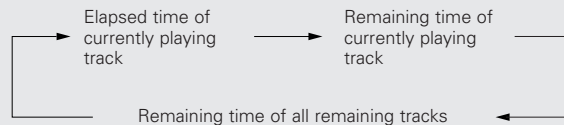

To stop playback

Press ■ during playback.

To pause playback (Pause)

Press <>/II> or [II] during playback.
 • The "II" indicator lights and the pause mode is set.

To resume playback:
 Press <>/II> or [▶].

Fast-forwarding (Search)

Press and hold [▶▶] during playback.

- ※ Normal playback resumes when you release your finger from the button.

To search forward at high speed:

In the pause mode, press and hold [▶▶].



- The sound may be interrupted shortly when resuming normal playback after searching.

Fast-reversing (Search)

Press and hold [◀◀] during playback.

- ※ Normal playback resumes when you release your finger from the button.

To search backward at high speed:

In the pause mode, press and hold [◀◀].



- The sound may be interrupted shortly when resuming normal playback after searching.

Moving to the beginning of tracks (Skip)

Press [◀◀] or [▶▶] during playback.

- ※ The operation is as follows if the button is held in:
 ▶▶: Skip to the beginning of tracks several tracks on
 ◀◀: Skip to the beginning of tracks several tracks before

Playing discs

Playing the desired track (Direct play)

Use **[NUMBER]** (1 ~ 9, 0/10, +10) to select the track.

- ※ For track numbers 1 to 10, press the corresponding ([1] to [0/10]).
For track numbers 11 and on, first press [+10] then press [1] to [0/10].
- Example:** Track 4 : [4]
- Example:** Track 12 : [+10] [2]
- Example:** Track 20 : [+10] [0/10]

Listening to specific tracks in a specific order (Programmed play)

Up to 25 tracks can be programmed.

- 1 In the stop mode, press [PROG/DIR].**
 - "PGM" is displayed.
- 2 Use [NUMBER] (1 ~ 9, 0/10, +10) to select the track.**

Example: To program tracks 3, 12, 7 to play in that order:
[3] [+10] [2] [7]
- 3 Press <>/II> or [▶].**
 - The tracks are played in the programmed order.

Checking the programmed tracks:
In the stop mode, press [CALL].

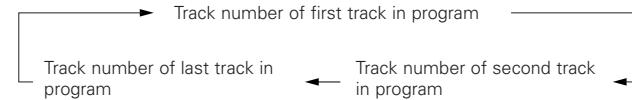

※ The total program time reappears if [CALL] is not operated for 5 seconds or more.

- To change a programmed track:**
In the stop mode, use [PROG/DIR.] to turn off the programmed track number display, then perform steps **1** and **2** over.
- Clearing tracks from the program:**
In the stop mode, press [CLEAR].
The last track in the program is deleted each time the button is pressed.
- Stopping programmed playback:**
In the stop mode, use [PROG/DIR.] to turn off the programmed track number display.



• During programmed playback, press [REP 1/ALL] to play the programmed tracks repeatedly.

NOTE:
• If the disc tray is opened after performing the program search operation, the program is cleared.

Listening in random order (Random playback)

- 1 In the stop mode, press [RANDOM].**
 - The "RANDOM" indicator lights.
- 2 Press <>/II> or [▶].**

Stopping random playback:
Stop playback, then press [RANDOM].
The "RANDOM" indicator turns off.



• If [REP 1/ALL] is pressed during random playback, the tracks are played once in one random pattern, then played again in a different order. Enjoy listening to them in a different order each time.

Playing discs

Listening to tracks repeatedly (Repeat play)

Listening to a specific track repeatedly (1-track repeat play)

- 1 Press [REP 1/ALL] once in the stop or play mode.**
 - The "↻ 1" indicator lights.

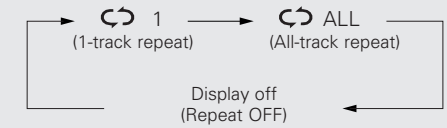

- 2 Use I◀◀ or ▶▶I to select the track you want to hear.**

- 3 Press <>/II> or [▶].**
 - The selected track is played repeatedly.

Stopping 1-track repeat playback:
Press [REP 1/ALL] until the "↻ 1" indicator turns off.

Listening to all the tracks repeatedly (All-track repeat play)

- 1 Press [REP 1/ALL] twice in a row in the stop or play mode.**
 - The "↻ ALL" indicator lights.
- 2 Press <>/II> or [▶].**
 - The currently playing disc is played repeatedly.

Stopping all-track repeat playback:
Press [REP 1/ALL] until the "↻ ALL" indicator turns off.

Playing MP3 or WMA (Windows Media® Audio) files

Before playing MP3 or WMA files

There are many music distribution sites on the Internet allowing you to download music files in MP3 or WMA (Windows Media® Audio) format. The music (files) downloaded from such sites can be stored on CD-R or CD-RW discs and played on the S-81.



“Windows Media” and “Windows” are registered trademarks or trademarks in the United States and other countries of the Microsoft Corporation of the United States.

※ According to copyright laws, recordings you have made should only be used for your personal enjoyment and must not be used in other ways without the consent of the copyright holder.

Order in which the folders are played

If there are multiple folders containing MP3 or WMA files, the S-81 automatically assigns the folders numbers when reading the disc. The folders switch according to the numbers they have been assigned. If there are no playable files in a folder, that folder is ignored.

Order in which files are played

The order in which the files are played depends on the folder structure attributed when the disc was created and other data recorded on the disc when the files were recorded. With the folder structure shown in the following example, the files are played in numerical order (1, 2, 3 ...).

※ The data stored on the disc depends on the writing software. Because of this, the files may not play in the desired order.

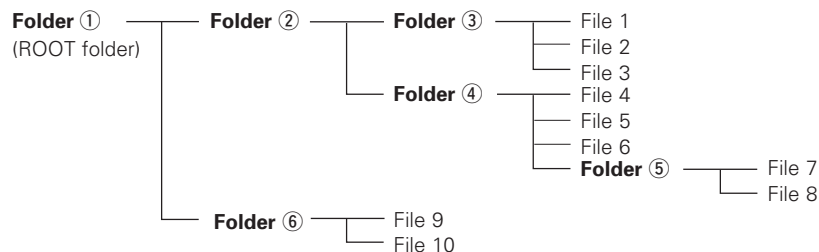

Setting the folders and files to be played (folder mode/file mode)

Use [FOLDER MODE] to switch between the modes.

• Folder mode

The “FLD” indicator lights.

Only the selected folder is played.

Example: When folder ④ is selected

Files 4, 5 and 6 are played.

Folder ⑤ is treated as a separate folder, so files 7 and 8 are not played.

• Disc mode (folder mode: OFF)

The “FLD” indicator turns off.

All the files in all the folders from the selected folder or file on are played.

Example: When file 3 in folder ③ is selected

All the files from file 3 on are played.

Playing MP3 or WMA files

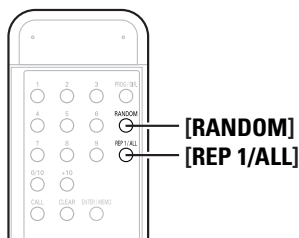
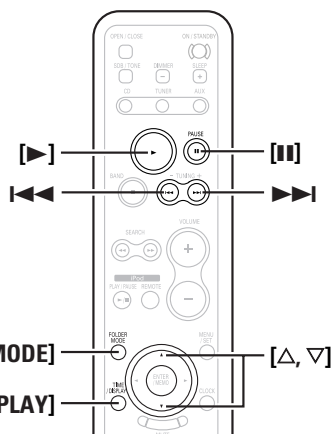
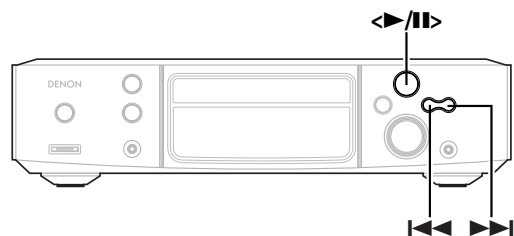

About the button names in this explanation
 < > : Buttons on the main unit
 [] : Buttons on the remote control unit
Button name only :
 Buttons on the main unit and remote control unit

Playing MP3 or WMA files

Playing MP3 or WMA files

1 Load a CD-R or CD-RW disc containing music files in MP3 or WMA (Windows Media Audio) format into the disc tray (☞ page 3).

2 When in the folder mode:
 Use [FOLDER MODE] to turn on the “FLD” indicator, then use [Δ ▽] to select the folder to be played.
 • The selected folder is displayed.

2 About the disc mode:
 Use [FOLDER MODE] to turn off the “FLD” indicator, then use [◀◀] or [▶▶] to select the file to be played.
 • The selected file is displayed.

3 Press [◀▶/||] or [▶].
 • The file name, title/artist name and title/album name scroll on the display and playback starts.

- ※ The title name, artist name and album name are only displayed if that information is recorded on the disc.
- ※ [TIME/DISPLAY] can be used to switch the information displayed.

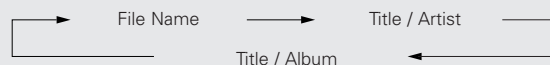

To change the folder to be played:
 Use [Δ ▽] to select a different folder.

To change the file to be played:
 In the stop mode, use [◀◀] or [▶▶] to select a different file.

- If the folder is selected in the play or pause mode, playback starts from or the pause mode is set at the first track in the selected folder.
- If a copyright-protected WMA file or a file that cannot be played normally is selected, “Not Support” is displayed. Use [◀◀] or [▶▶] to select a different file.

Listening to MP3 or WMA files in random order (Random folder/disc play)

1 Perform steps 2-1 or 2-2 under “Playing MP3 or WMA files”.

2 Press [RANDOM].
 • The “RANDOM” indicator lights.

3 Press [◀▶/||] or [▶].
 • Either the files in the selected folder or all the files on the disc are played in random order.

To cancel the folder/disc random play mode:
 Stop playback, then press [RANDOM].
 The “RANDOM” indicator turns off.

- If [REP 1/ALL] is pressed during random playback, the tracks are played once in one random pattern, then played again in a different order. Enjoy listening to them in a different order each time.

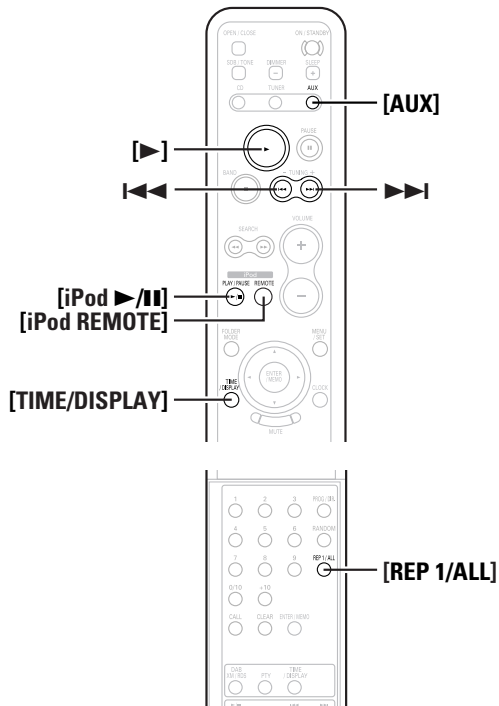
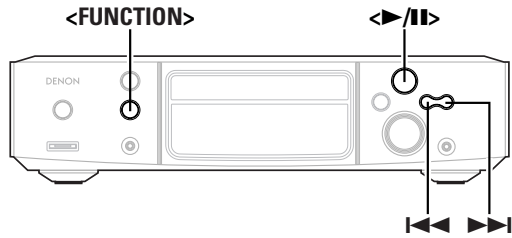

About the button names in this explanation
 < > : Buttons on the main unit
 [] : Buttons on the remote control unit
Button name only :
 Buttons on the main unit and remote control unit

Listening to MP3 or WMA files repeatedly (Repeat folder/disc play)

1 Perform steps 2-1 or 2-2 under “Playing MP3 or WMA files” (page 25).

2 Use [REP 1/ALL] to select the repeat mode.

※ When in the folder mode:

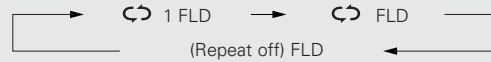

※ About the disc mode:



3 Press <||/> or [▶].

• Either the files in the selected folder or all the files on the disc are played repeatedly.

To stop repeat folder/disc playback:

Press [REP 1/ALL] until the “↻” indicator turns off.

NOTE:

- The S-81 is compatible with “MPEG-1 Audio Layer-3” standards (sampling frequency of 44.1 and 48 kHz). It is not compatible with “MPEG-2 Audio Layer-3”, “MPEG-2.5 Audio Layer-3”, MP1 or MP2 standards.
- Programmed playback is not possible with discs containing files recorded in MP3 or WMA format.
- The signals are output with a sampling frequency of 44.1 kHz.
- When writing MP3 files on a CD-R or CD-RW disc, set the writing software’s format to “ISO9660 Level 1”. The files may not play properly if they are recorded in other formats. Also note that with some writing software it is not possible to record in ISO9660 format. If so, use a different program allowing you to record in ISO9660 format.
- With MP3 files, the higher the bit rate, the better the sound quality. The compatible bit rate range is 32 to 320 kbps for MP3 files, 64 to 160 kbps for WMA files. We recommend using MP3 files with bit rates of 128 kbps or greater on the S-81.
- Be sure to add the extensions “.MP3” or “.WMA” to MP3 or WMA files, respectively. Files with extensions other than “.MP3” or “.WMA” or files without extensions cannot be played. (On Macintosh computers, MP3 files can be played by giving the extension “.MP3” after the file name consisting up a maximum of 8 alphanumeric characters and storing the files on a CD-R or CD-RW disc.)
- The S-81 is not compatible with packet write software or playlists.
- Up to 32 characters of folder and file names can be displayed.
- The S-81 is compatible with MP3 ID3-Tag versions 1.x and 2.x.
- The time may not be displayed properly when searching or pausing during variable bit rate playback.
- The time display cannot be switched using [TIME/DISPLAY].
- For files in which the title name and artist name data are stored, the title name or artist name can be displayed in the play or pause mode by pressing [TIME/DISPLAY].
- Multisession and CD-R/CD-RW discs that have not been completely written can be played, but we recommend using discs closed after a maximum of 10 sessions or discs that have been completed.
- The S-81 is compatible with the titles, artists and albums of WMA file meta tags.
- The maximum number of files and folders playable is 512 (total of the number of folders and files). The maximum number of folders is 256.
- Copyright-protected WMA files cannot be played. (“Not Support” is displayed. Use ◀◀ or ▶▶ to select a different file.)

Other types of playback

Playing an iPod®

NOTE:

- The iPod may be used to copy or play contents that are not copyrighted or contents for which copying or playback is legally permitted for your private use as an individual. It is illegal to violate copyrights.
- DENON will accept no responsibility whatsoever for loss or damage of data on an iPod occurring when the iPod is used connected to the S-81.
- Some of the functions may not operate, depending on the type of iPod and the software version.
- Depending on your iPod's software version, it may not be possible to control your iPod from the S-81. We recommend installing the latest software version.
For information and instructions on upgrading to the latest software version, see the Apple Computer, Inc. website.

Using the included iPod cable

Use this procedure to connect the iPod to the S-81's iPod connector and listen to the iPod's music.

1 Connect the S-81 and iPod using the included iPod cable. (☞ page 10).

2 Use <FUNCTION> or [AUX] (FUNCTION) to select "iPod".

3 Use [iPod REMOTE] to select the play mode.

Browse iPod ←→ Remote iPod

Browse iPod:

The menu and information on the tracks is indicated on the S-81's display.

Remote iPod:

The menu and information on the tracks is indicated on the iPod's display.

4 Press [iPod ▶/||].

Using an exclusive control Dock for iPod

The music on an iPod can be listened to using an Control Dock for iPod (ASD-1R (sold separately)). For details on the Control Dock for iPod, inquire at your store of purchase or a DENON customer service center.

1 Connect the Control Dock for iPod and S-81 (☞ page 11).

2 Use <FUNCTION> or [AUX] (FUNCTION) to select "AUX1/iPod".

3 Perform steps **3** and **4** under "Using the included iPod cable".

Using an Apple iPod Dock

This operation allows you to listen to music on an iPod using an Apple iPod Dock (sold separately).

1 Connect the iPod Dock and S-81 (☞ page 11).

2 Use <FUNCTION> or [AUX] (FUNCTION) to select "AUX1/iPod".

3 Perform steps **3** and **4** under "Using the included iPod cable".



- For the remote control unit buttons that can be operated when the function is set to "iPod" or "AUX1/iPod", see page 7.
- When operating the iPod, also refer to the iPod's operating instructions.

Playing a portable player

For instructions on connections, see page 10.

1 Use <FUNCTION> or [AUX] (FUNCTION) to select "Front IN".

2 Playing a portable player.

- ※ For instructions on operations, see the portable player's operating instructions.

System Operations

Auto power on function

When the S-81's power is in the standby mode, press <▶/||>, [▶], or [iPod ▶/||].

- The power turns on and the function switches automatically.
- If a disc is loaded in the set, use <▶/||> or [▶] to start playing the disc.

Auto function selection

Press <▶/||>, [▶] or [iPod ▶/||].

- The S-81's function switches automatically and playback starts.

Others

Troubleshooting

If a problem should arise, first check the following.

1. Are all connections proper?
2. Is the set being operated as described in the operating instructions?
3. Are the speakers and other components operating properly?

If this unit is not operating properly, check the items listed in the table below. Should the problem persist, there may be a malfunction. Disconnect the power immediately and contact your store of purchase.

Common section

Symptom	Cause	Measures	Page
Display does not light and no sound is produced when power is turned on.	<ul style="list-style-type: none"> The power supply cord is not plugged into a power outlet. 	<ul style="list-style-type: none"> Plug the power supply cord into a power outlet. 	12
Remote control unit does not operate.	<ul style="list-style-type: none"> The batteries are flat. 	<ul style="list-style-type: none"> Replace with new batteries. 	4
	<ul style="list-style-type: none"> The remote control unit is too far away. 	<ul style="list-style-type: none"> Operate from closer to the main unit. 	4
	<ul style="list-style-type: none"> There is an obstacle between the main unit and the remote control unit. 	<ul style="list-style-type: none"> Remove the obstacle. 	4
	<ul style="list-style-type: none"> The remote control unit is being operated at an angle of over 30° with respect to the front panel. 	<ul style="list-style-type: none"> Operate the remote control unit from directly in front of the main unit. 	4
	<ul style="list-style-type: none"> The batteries are inserted in the wrong direction. 	<ul style="list-style-type: none"> Insert the batteries in the proper direction. 	4

Receiver section

Symptom	Cause	Measures	Page
Display lights but no sound is produced.	<ul style="list-style-type: none"> The speaker cables are not properly connected. The input is not properly selected. The volume is set too low. 	<ul style="list-style-type: none"> Connect securely. Connect in the proper position. Adjust the volume to an appropriate level. 	8 10, 11, 12 13
No sound is produced from once side.	<ul style="list-style-type: none"> The speaker cables are not properly connected. The input cables are not properly connected. The left/right balance is off. 	<ul style="list-style-type: none"> Connect securely. Connect securely. Adjust the left/right balance. 	8 10, 11 12 13
For stereo sources, the positions of the instruments are inverted.	<ul style="list-style-type: none"> The connections of the speaker cables or input cables are inverted. 	<ul style="list-style-type: none"> Check the connections. 	8, 10, 11, 12
Buzzing noise in FM broadcasts.	<ul style="list-style-type: none"> The antenna cable is not properly connected. Noise is entering from an electronic device equipped with a microprocessor, or the signal from the broadcast system is weak. 	<ul style="list-style-type: none"> Connect the antenna properly. 	9
		<ul style="list-style-type: none"> Change the layout of the equipment or the positions or directions of the connection cables, antenna, etc. 	9
		<ul style="list-style-type: none"> Connect an outdoor antenna. 	9
Hissing or buzzing noise is heard in AM broadcasts.	<ul style="list-style-type: none"> Noise is entering from a monitor, etc., or there is interference. 	<ul style="list-style-type: none"> Turn off the monitor. 	—
		<ul style="list-style-type: none"> Change the position or direction of the AM loop antenna. Connect an outdoor antenna. 	9 9
Humming noise is heard in AM broadcasts.	<ul style="list-style-type: none"> There is interference from signals conveyed through the power supply cord. 	<ul style="list-style-type: none"> Connect an outdoor antenna. 	9
"CHECK ANTENNA" is displayed in the XM mode.	<ul style="list-style-type: none"> S-81's XM terminal and the XM Connect-and-Play antenna is not properly connected. 	<ul style="list-style-type: none"> Check that the connection are correct. 	10
"NO SIGNAL" is displayed in the XM mode.	<ul style="list-style-type: none"> The signal cannot be received. 	<ul style="list-style-type: none"> Reposition your XM Connect-and-Play antenna. 	17
"OFF AIR" is displayed in the XM mode.	<ul style="list-style-type: none"> The selected channel is not currently broadcasting. 	<ul style="list-style-type: none"> Select the another channel. 	17
Receiving only XM channels 0 and 1.	<ul style="list-style-type: none"> The XM Tuner is not activated. 	<ul style="list-style-type: none"> Contact XM Radio. 	16
No sound is produced when an iPod is connected and played.	<ul style="list-style-type: none"> Connections are wrong. The "iPod CONTROL" switch on the rear panel is not set to the right position. 	<ul style="list-style-type: none"> Connect properly. 	10, 11
		<ul style="list-style-type: none"> Set the "iPod CONTROL" switch on the rear panel to the proper position. 	10, 11

Others

 CD player section

Symptom	Cause	Measures	Page
"00 Tr 00 : 00" is shown on the display even though a CD is loaded.	<ul style="list-style-type: none"> The disc is not properly loaded. 	<ul style="list-style-type: none"> Reload the disc. 	3
Disc is not played when play button is pressed.	<ul style="list-style-type: none"> The disc is dirty or scratched. 	<ul style="list-style-type: none"> Wipe the dirt off the disc or replace the disc. 	4
No sound is produced or sound is distorted.	<ul style="list-style-type: none"> Incomplete connections with the various devices. The receiver's function setting or adjustments are not right. 	<ul style="list-style-type: none"> Check the connections. Check the receiver's function and controls and adjust as necessary. 	10, 11, 12 —
Specific section of the disc cannot be played properly.	<ul style="list-style-type: none"> The disc is dirty or scratched. 	<ul style="list-style-type: none"> Wipe the dirt off the disc or replace the disc. 	3, 4
Programmed playback is not possible.	<ul style="list-style-type: none"> The tracks have not been programmed properly. You are playing a disc containing files in MP3 or WMA format. 	<ul style="list-style-type: none"> Program properly. Programmed playback is not possible with containing files in MP3 or WMA format. 	23 —
A CD-R or CD-RW disc cannot be played.	<ul style="list-style-type: none"> The disc has not been finalized. The recording conditions are bad or the quality of the disc itself is poor. 	<ul style="list-style-type: none"> Finalize the disc then play it. Use a properly recorded disc. 	3 —
"Not Support" is displayed when playing files recorded in MP3 or WMA format.	<ul style="list-style-type: none"> You have selected a copyright-protected WMA file or a file that cannot be played normally. 	<ul style="list-style-type: none"> Use the I◀◀ or ▶▶I button to select a different file. 	26

Others

Specifications

 Receiver section

Rated output:	50 W + 50 W (4 Ω/ohms, 1 kHz, T.H.D. 10 %)
Output terminals:	Speaker: 4 Ω/ohms
Audio input/output terminals:	AUX 1 input terminal, AUX 2 input terminal, DIGITAL OPTICAL OUT terminal, iPod terminal, MONO output terminal Portable input jack, Headphone jack
Reception frequency range:	FM: 87.5 MHz ~ 107.9 MHz AM: 520 kHz ~ 1710 kHz
Reception sensitivity:	FM: 1.5 μV AM: 20 μV
FM stereo isolation:	35 dB (1 kHz)

 CD player section

Wow & flutter:	Below measurable limits (± 0.001 % W. peak)
Sampling frequency:	44.1 kHz
Light source:	Semiconductor laser

 Clock/Timer section

Clock type:	Power line frequency synchronized method (± 30 seconds)
Timer:	Everyday timer (1 set) Once timer (1 set) Sleep timer (Max. 90 minutes)

 Speakers

Speaker system:	SC-S81
Type:	2-way, 2-speakers, Bass reflex type, antimagnetic design, bookshelf type 12 cm cone bass-mid x 1/2.5 cm high range x 1
Input impedance:	4 Ω/ohms
Max. allowable input:	60 W (IEC), 120 W (PEAK)
Dimensions:	150 (W) x 269 (H) x 190 (D) mm (5-29/32" x 10-19/32" x 7-31/64") (Including protruding parts)
Mass:	3.1 kg (6 lbs 13.4 oz)

 General

Power Supply:	AC 120 V, 60 Hz
Power Consumption:	45 W 0.2 W Max (Standby) (In the low-power standby mode)
Dimensions:	380 (W) x 97 (H) x 265 (D) mm (14-61/64" x 3-13/16" x 10-7/16") (Including protruding parts)
Mass:	4.1 kg (9 lbs 0.6 oz)

 Remote control unit (RC-1035)

Remote control method:	IR pulse method
Power supply:	Two R6P/AA batteries
Maximum external dimensions:	52 (W) x 233 (H) x 21 (D) mm (2-3/64" x 9-11/64" x 53/64")
Mass:	160 g (Approx. 5.6 oz) (Including batteries)

* For purposes of improvement, specifications and design are subject to change without notice.



DENON

TOKYO, JAPAN
www.denon.com

Denon Brand Company, D&M Holdings Inc.
Printed in China 00D 511 4472 008

Free Manuals Download Website

<http://myh66.com>

<http://usermanuals.us>

<http://www.somanuals.com>

<http://www.4manuals.cc>

<http://www.manual-lib.com>

<http://www.404manual.com>

<http://www.luxmanual.com>

<http://aubethermostatmanual.com>

Golf course search by state

<http://golfingnear.com>

Email search by domain

<http://emailbydomain.com>

Auto manuals search

<http://auto.somanuals.com>

TV manuals search

<http://tv.somanuals.com>