

DENON

AV SURROUND RECEIVER

AVR-4800

OPERATING INSTRUCTIONS

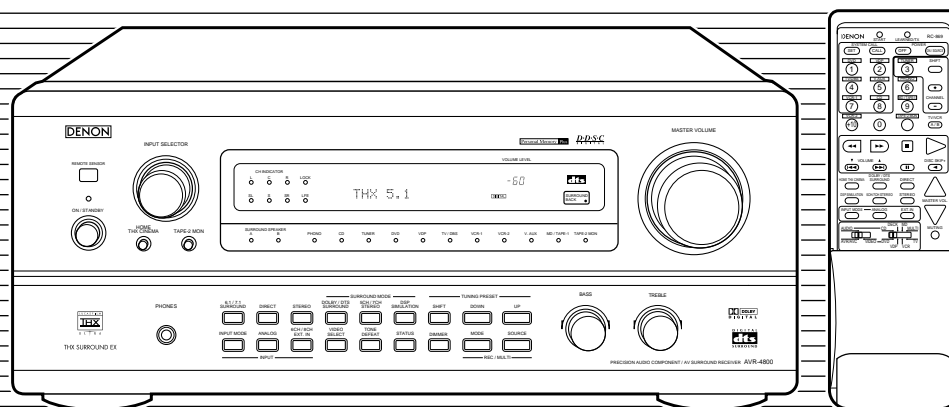

- We greatly appreciate your purchase of the AVR-4800.
- To be sure you take maximum advantage of all the features the AVR-4800 has to offer, read these instructions carefully and use the set properly. Be sure to keep this manual for future reference should any questions or problems arise.

"SERIAL NO. _____
PLEASE RECORD UNIT SERIAL NUMBER ATTACHED TO THE REAR OF THE
CABINET FOR FUTURE REFERENCE"

SAFETY PRECAUTIONS



CAUTION
RISK OF ELECTRIC SHOCK
DO NOT OPEN



CAUTION: TO REDUCE THE RISK OF ELECTRIC SHOCK, DO NOT REMOVE COVER (OR BACK). NO USER-SERVICEABLE PARTS INSIDE. REFER SERVICING TO QUALIFIED SERVICE PERSONNEL.

The lightning flash with arrowhead symbol, within an equilateral triangle, is intended to alert the user to the presence of uninsulated "dangerous voltage" within the product's enclosure that may be of sufficient magnitude to constitute a risk of electric shock to persons.

The exclamation point within an equilateral triangle is intended to alert the user to the presence of important operating and maintenance (servicing) instructions in the literature accompanying the appliance.

WARNING: TO REDUCE THE RISK OF FIRE OR ELECTRIC SHOCK, DO NOT EXPOSE THIS APPLIANCE TO RAIN OR MOISTURE.

CAUTION

TO PREVENT ELECTRIC SHOCK, MATCH WIDE BLADE OF PLUG TO WIDE SLOT, FULLY INSERT.

ATTENTION





POUR ÉVITER LES CHOCS ÉLECTRIQUES, INTERODUIRE LA LAME LA PLUS LARGE DE LA FICHE DANS LA BORNE CORRESPONDANTE DE LA PRISE ET POUSSER JUSQU' AU FOND.

This device complies with Part 15 of the FCC Rules. Operation is subject to the following two conditions: (1) This device may not cause harmful interference, and (2) this device must accept any interference received, including interference that may cause undesired operation.

This Class B digital apparatus meets all requirements of the Canadian Interference-Causing Equipment Regulations.

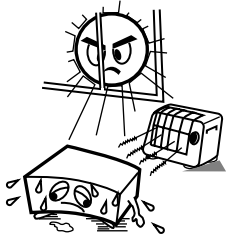
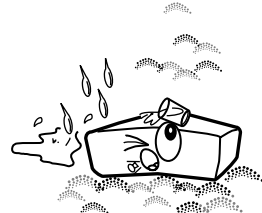
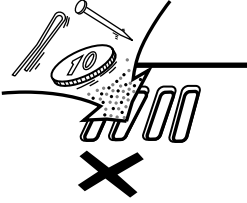
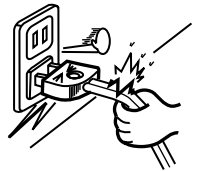
Cet appareil numérique de la classe B respecte toutes les exigences du Règlement sur le matériel brouilleur du Canada.

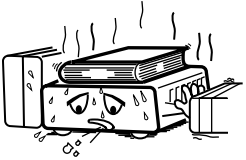
NOTE ON USE / OBSERVATIONS RELATIVES A L'UTILISATION

 <ul style="list-style-type: none"> Avoid high temperatures. Allow for sufficient heat dispersion when installed on a rack. Éviter des températures élevées. Tenir compte d'une dispersion de chaleur suffisante lors de l'installation sur une étagère. 	 <ul style="list-style-type: none"> Keep the set free from moisture, water, and dust. Protéger l'appareil contre l'humidité, l'eau et la poussière. 	 <ul style="list-style-type: none"> Do not let foreign objects in the set. Ne pas laisser des objets étrangers dans l'appareil.
 <ul style="list-style-type: none"> Handle the power cord carefully. Hold the plug when unplugging the cord. Manipuler le cordon d'alimentation avec précaution. Tenir la prise lors du débranchement du cordon. 	 <ul style="list-style-type: none"> Unplug the power cord when not using the set for long periods of time. Débrancher le cordon d'alimentation lorsque l'appareil n'est pas utilisé pendant de longues périodes. 	 <ul style="list-style-type: none"> Do not let insecticides, benzene, and thinner come in contact with the set. Ne pas mettre en contact des insecticides, du benzène et un diluant avec l'appareil.
	 <p style="text-align: center;">* (For sets with ventilation holes)</p> <ul style="list-style-type: none"> Do not obstruct the ventilation holes. Ne pas obstruer les trous d'aération. 	 <ul style="list-style-type: none"> Never disassemble or modify the set in any way. Ne jamais démonter ou modifier l'appareil d'une manière ou d'une autre.

SAFETY INSTRUCTIONS

1. Read Instructions – All the safety and operating instructions should be read before the appliance is operated.
2. Retain Instructions – The safety and operating instructions should be retained for future reference.
3. Heed Warnings – All warnings on the appliance and in the operating instructions should be adhered to.
4. Follow Instructions – All operating and use instructions should be followed.
5. Water and Moisture – The appliance should not be used near water – for example, near a bathtub, washbowl, kitchen sink, laundry tub, in a wet basement, or near a swimming pool, and the like.
6. Carts and Stands – The appliance should be used only with a cart or stand that is recommended by the manufacturer.
- 6A. An appliance and cart combination should be moved with care. Quick stops, excessive force, and uneven surfaces may cause the appliance and cart combination to overturn.
7. Wall or Ceiling Mounting – The appliance should be mounted to a wall or ceiling only as recommended by the manufacturer.
8. Ventilation – The appliance should be situated so that its location or position does not interfere with its proper ventilation. For example, the appliance should not be situated on a bed, sofa, rug, or similar surface that may block the ventilation openings; or, placed in a built-in installation, such as a bookcase or cabinet that may impede the flow of air through the ventilation openings.
9. Heat – The appliance should be situated away from heat sources such as radiators, heat registers, stoves, or other appliances (including amplifiers) that produce heat.
10. Power Sources – The appliance should be connected to a power supply only of the type described in the operating instructions or as marked on the appliance.
11. Grounding or Polarization – Precautions should be taken so that the grounding or polarization means of an appliance is not defeated.
12. Power-Cord Protection – Power-supply cords should be routed so that they are not likely to be walked on or pinched by items placed upon or against them, paying particular attention to cords at plugs, convenience receptacles, and the point where they exit from the appliance.
14. Cleaning – The appliance should be cleaned only as recommended by the manufacturer.
15. Power Lines – An outdoor antenna should be located away from power lines.
16. Outdoor Antenna Grounding – If an outside antenna is connected to the receiver, be sure the antenna system is grounded so as to provide some protection against voltage surges and built-up static charges. Article 810 of the National Electrical Code, ANSI/NFPA 70, provides information with regard to proper grounding of the mast and supporting structure, grounding of the lead-in wire to an antenna-discharge unit, size of grounding conductors, location of antenna-discharge unit, connection to grounding electrodes, and requirements for the grounding electrode. See Figure A.
17. Non-use Periods – The power cord of the appliance should be unplugged from the outlet when left unused for a long period of time.
18. Object and Liquid Entry – Care should be taken so that objects do not fall and liquids are not spilled into the enclosure through openings.
19. Damage Requiring Service – The appliance should be serviced by qualified service personnel when:
 - A. The power-supply cord or the plug has been damaged; or
 - B. Objects have fallen, or liquid has been spilled into the appliance; or
 - C. The appliance has been exposed to rain; or
 - D. The appliance does not appear to operate normally or exhibits a marked change in performance; or
 - E. The appliance has been dropped, or the enclosure damaged.
20. Servicing – The user should not attempt to service the appliance beyond that described in the operating instructions. All other servicing should be referred to qualified service personnel.

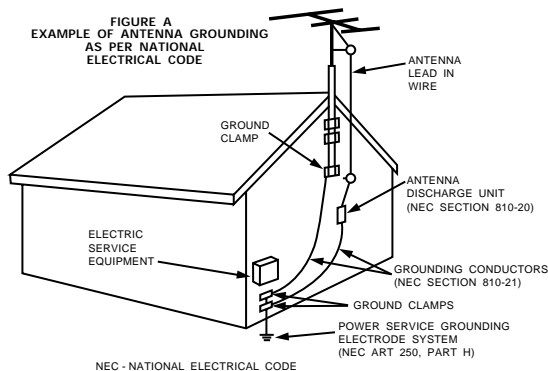

■ INTRODUCTION

Thank you for choosing the DENON AVR-4800 Digital Surround A / V receiver. This remarkable component has been engineered to provide superb surround sound listening with home theater sources such as DVD, as well as providing outstanding high fidelity reproduction of your favorite music sources.

As this product is provided with an immense array of features, we recommend that before you begin hookup and operation that you review the contents of this manual before proceeding.

TABLE OF CONTENTS

1 Before Using4	10 Surround.....46-52
2 Cautions on Installation4	11 DENON Original Surround Modes53-56
3 Cautions on Handling5	12 Listening to the Radio57-59
4 Features.....5	13 Last Function Memory59
5 Connections6-15	14 Initialization of the Microprocessor.....59
6 Part Names and Functions16, 17	15 Troubleshooting.....60
7 Setting up the system18-30	16 Additional Information61-68
8 Remote Control Unit31-39	17 Specifications69
9 Operation39-45	

■ ACCESSORIES

Check that the following parts are included in addition to the main unit:

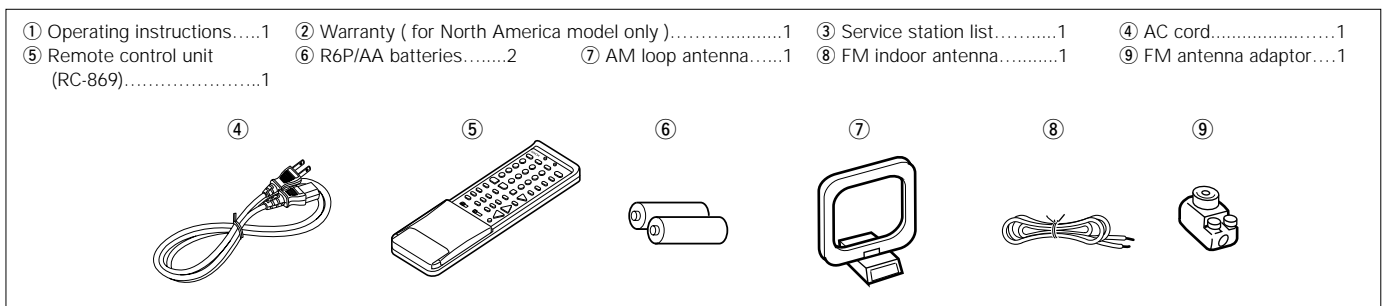

1 BEFORE USING

Pay attention to the following before using this unit:

- **Moving the set**
To prevent short circuits or damaged wires in the connection cords, always unplug the power cord and disconnect the connection cords between all other audio components when moving the set.
- **Before turning the power switch on**
Check once again that all connections are proper and that there are not problems with the connection cords. Always set the power switch to the standby position before connecting and disconnecting connection cords.

- **Store this instructions in a safe place.**
After reading, store this instructions along with the warranty in a safe place.
- **Note that the illustrations in this instructions may differ from the actual set for explanation purposes.**

2 CAUTIONS ON INSTALLATION

Noise or disturbance of the picture may be generated if this unit or any other electronic equipment using microprocessors is used near a tuner or TV.

If this happens, take the following steps:

- Install this unit as far as possible from the tuner or TV.
- Set the antenna wires from the tuner or TV away from this unit's power cord and input/output connection cords.
- Noise or disturbance tends to occur particularly when using indoor antennas or 300 Ω/ohms feeder wires. **We recommend using outdoor antennas and 75 Ω/ohms coaxial cables.**

For heat dispersal, leave at least 10 cm of space between the top, back and sides of this unit and the wall or other components.

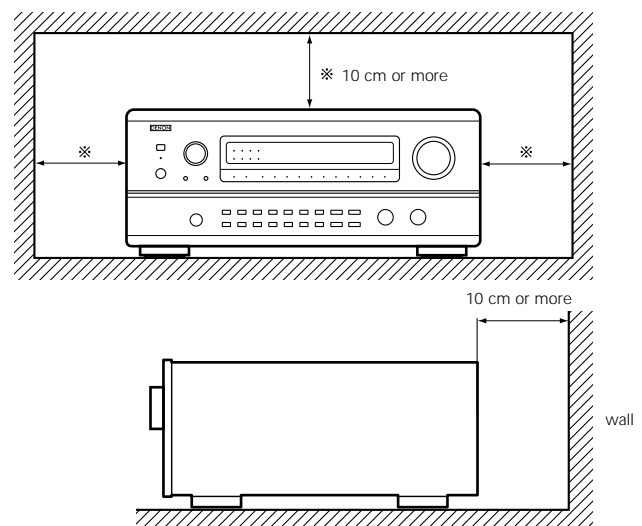

3 CAUTIONS ON HANDLING

- **Switching the input function when input jacks are not connected**

A clicking noise may be produced if the input function is switched when nothing is connected to the input jacks. If this happens, either turn down the MASTER VOLUME control or connect components to the input jacks.

- **Muting of PRE OUT jacks and SPEAKER terminals**

The PRE OUT jacks and SPEAKER terminals include a muting circuit. Because of this, the output signals are greatly reduced for several seconds after the power switch is turned on or input function, surround mode or any other set-up is changed. If the volume is turned up during this time, the output will be very high after the muting circuit stops functioning. Always wait until the muting circuit turns off before adjusting the volume.

- **Whenever the power switch is in the STANDBY state, the apparatus is still connected on AC line voltage. Please be sure to unplug the cord when you leave home for, say, a vacation.**

4 FEATURES

1. Digital Surround Sound Decoding

Featuring dual 32 bit high speed DSP processors, operating entirely in digital domain, surround sound from digital sources such as DVD, DTV and satellite are faithfully re-created.

2. Dolby Digital

Using advanced digital processing algorithms, Dolby Digital provides up to 5.1 channels of wide-range, high fidelity surround sound. Dolby Digital is the default digital audio delivery system for North American DVD and DTV, and is available on laser discs as well as some digital satellite direct-to-home services.

3. DTS (Digital Theater Systems)

DTS provides up to 5.1 channels of wide-range, high fidelity surround sound, from sources such as laser disc, DVD and specially-encoded music discs.

4. Lucasfilm Home THX Ultra Certified

Home THX is the unique collaboration between Lucasfilm Ltd. and audio equipment manufacturers. THX Ultra certification is the highest performance level, and provides a rigorous set of performance standards, along with proprietary surround sound post-processing technologies, designed to enhance the surround soundtrack playback experience in the home theater.

5. THX Surround EX

By adding a 2-channel power amplifier and two surround back speakers, the system becomes fully compatible with THX Surround EX, the latest surround format.

6. Wide screen mode for a 7.1-channel sound even with 5.1-channel sources

DENON has developed a wide screen mode with a new design which recreates the effects of the multi surround speakers in movie theaters. The result is 7.1-channel sound taking full advantage of surround back speakers, even with Dolby Pro Logic or Dolby Digital/DTS 5.1-channel signals.

7. 24 bit D/A Conversion

All eight channels, including the seven main channels and the low frequency effects (LFE) channel benefit from reference ANALOG DEVICES DACs, for optimum high fidelity reproduction of music and movie soundtracks.

8. Dual Surround Speaker Mode

Provides for the first time the ability to optimize surround sound reproduction using two different types of surround sound speakers as well as two different surround speaker positions:

(1) Movie Surround

Motion picture soundtracks use the surround channel(s) to provide the ambient elements of the acoustic environment they want the audience to realize. This is best accomplished by the use of specially-designed surround speakers that offer a wide diffusion pattern (bipolar dispersion) or by using surround speakers that provide broad dispersion with a minimum of on-

axis localization (dipolar dispersion). Side wall mounting (closer to the ceiling) of the surround speakers provides the greatest envelopment, minimizing localization of direct sound from the speakers.

(2) Music Surround

With full range discrete surround channels, as well as three discrete full range front channels, digital formats such as Dolby and DTS offer thrilling surround sound music listening. Producers of multi-channel discrete digital music recordings almost always favor the use of direct radiating (monopolar) surround speakers, placed in the rear corners of the room, since that is how they configure their studios during the mixing/creation process.

The DENON AVR-4800 provides the ability to connect two different sets of surround speakers, and place them in the appropriate locations in your home theater room, so that you can enjoy both movie soundtracks and music listening, with optimum results and no compromise.

9. Component Video Switching

In addition to composite video and "S" video switching, the AVR-4800 provides 2 sets of component video (Y, R-Y, B-Y) inputs for the DVD and TV/DBS inputs, and one set of component video outputs to the television, for superior picture quality.

10. Video Select Function

Allow you to watch one source (visual) while listening to another source (audio).

11. Five Identical Power Amplifiers

Featuring discrete high current power transistors, the power amp section is THX Ultra certified for top performance with the widest range of speaker systems. Rated at 125 watts into 8 Ω /ohms, the amp channels feature additional low impedance drive capability.

12. Future Sound Format Upgrade Capability via Eight Channel Inputs & Outputs

For future multi-channel audio format(s), the AVR-4800 is provided with 7.1 channel (seven main channels, plus one low frequency effects channel) inputs, along with a full set of 7.1 channel pre-amp outputs, controlled by the 8 channel master volume control. This assures future upgrade possibilities for any future multi-channel sound format.

13. Amplifier assign function for greater liberty in upgrading the system with an external power amplifier

When using an external power amplifier (option) to upgrade to a THX Surround EX system, you can choose whether to use the internal amplifier for the front channels or the surround back channel. Even when the system is upgraded with an external power amplifier for the front channels the internal amplifier can be used for the surround back channel.

5 CONNECTIONS

- Do not plug in the AC cord until all connections have been completed.
- Be sure to connect the left and right channels properly (left with left, right with right).
- Insert the plugs securely. Incomplete connections will result in the generation of noise.
- Use the **AC OUTLETS** for audio equipment only. Do not use them for hair dryers, etc.

- Note that binding pin plug cords together with AC cords or placing them near a power transformer will result in generating hum or other noise.
- Noise or humming may be generated if a connected audio equipment is used independently without turning the power of this unit on. If this happens, turn on the power of the this unit.

Connecting the audio components

- When making connections, also refer to the operating instructions of the other components.

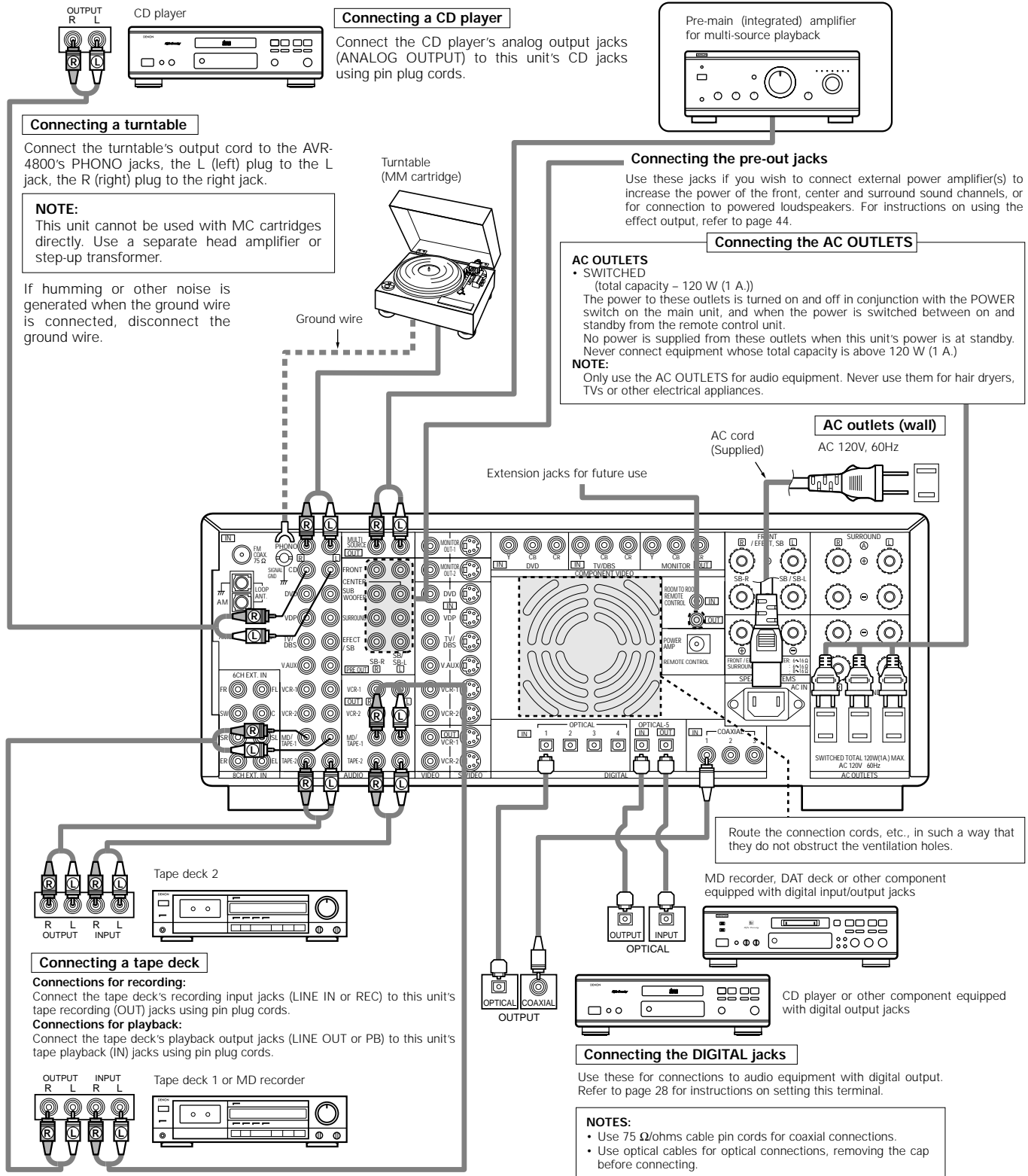

Connecting video components

- To connect the video signal, connect using a 75 Ω /ohms video signal cable cord. Using an improper cable can result in a drop in picture quality.
- When making connections, also refer to the operating instructions of the other components.

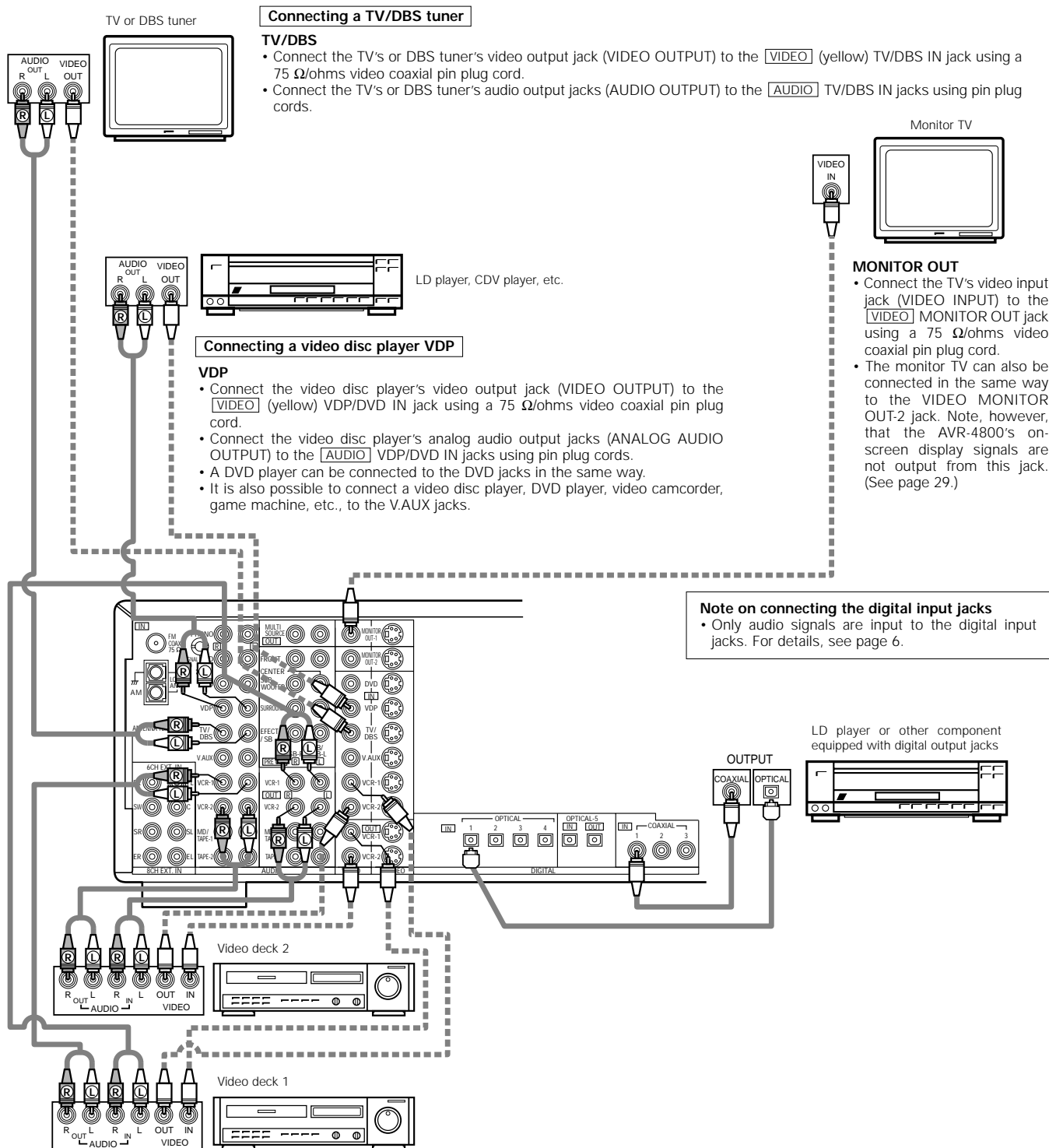

Connecting a TV/DBS tuner

TV/DBS

- Connect the TV's or DBS tuner's video output jack (VIDEO OUTPUT) to the VIDEO (yellow) TV/DBS IN jack using a 75 Ω /ohms video coaxial pin plug cord.
- Connect the TV's or DBS tuner's audio output jacks (AUDIO OUTPUT) to the AUDIO TV/DBS IN jacks using pin plug cords.

Connecting a video disc player VDP

VDP

- Connect the video disc player's video output jack (VIDEO OUTPUT) to the VIDEO (yellow) VDP/DVD IN jack using a 75 Ω /ohms video coaxial pin plug cord.
- Connect the video disc player's analog audio output jacks (ANALOG AUDIO OUTPUT) to the AUDIO VDP/DVD IN jacks using pin plug cords.
- A DVD player can be connected to the DVD jacks in the same way.
- It is also possible to connect a video disc player, DVD player, video camcorder, game machine, etc., to the V.AUX jacks.

MONITOR OUT

- Connect the TV's video input jack (VIDEO INPUT) to the VIDEO (yellow) MONITOR OUT jack using a 75 Ω /ohms video coaxial pin plug cord.
- The monitor TV can also be connected in the same way to the VIDEO MONITOR OUT-2 jack. Note, however, that the AVR-4800's on-screen display signals are not output from this jack. (See page 29.)

Note on connecting the digital input jacks

- Only audio signals are input to the digital input jacks. For details, see page 6.

Connecting a video decks

- There are two sets of video deck (VCR) jacks, so two video decks can be connected for simultaneous recording or video copying.

Video input/output connections:

- Connect the video deck's video output jack (VIDEO OUT) to the VIDEO (yellow) VCR-1 IN jack, and the video deck's video input jack (VIDEO IN) to the VIDEO (yellow) VCR-1 OUT jack using 75 Ω /ohms video coaxial pin plug cords.

Connecting the audio output jacks

- Connect the video deck's audio output jacks (AUDIO OUT) to the AUDIO VCR-1 IN jacks, and the video deck's audio input jacks (AUDIO IN) to the AUDIO VCR-1 OUT jacks using pin plug cords.

※ Connect the second video deck to the VCR-2 jacks in the same way.

Connecting a video component equipped with S-Video jacks

• When making connections, also refer to the operating instructions of the other components.

• A note on the S input jacks

The input selectors for the S inputs and pin jack inputs work in conjunction with each other.

• Precaution when using S-jacks

This unit's S-jacks (input and output) and video pin jacks (input and output) have independent circuit structures, so that video signals input from the S-jacks are only output from the S-jack outputs and video signals input from the pin jacks are only output from the pin jack outputs.

When connecting this unit with equipment that is equipped with S-jacks, keep the above point in mind and make connections according to the equipment's instruction manuals.

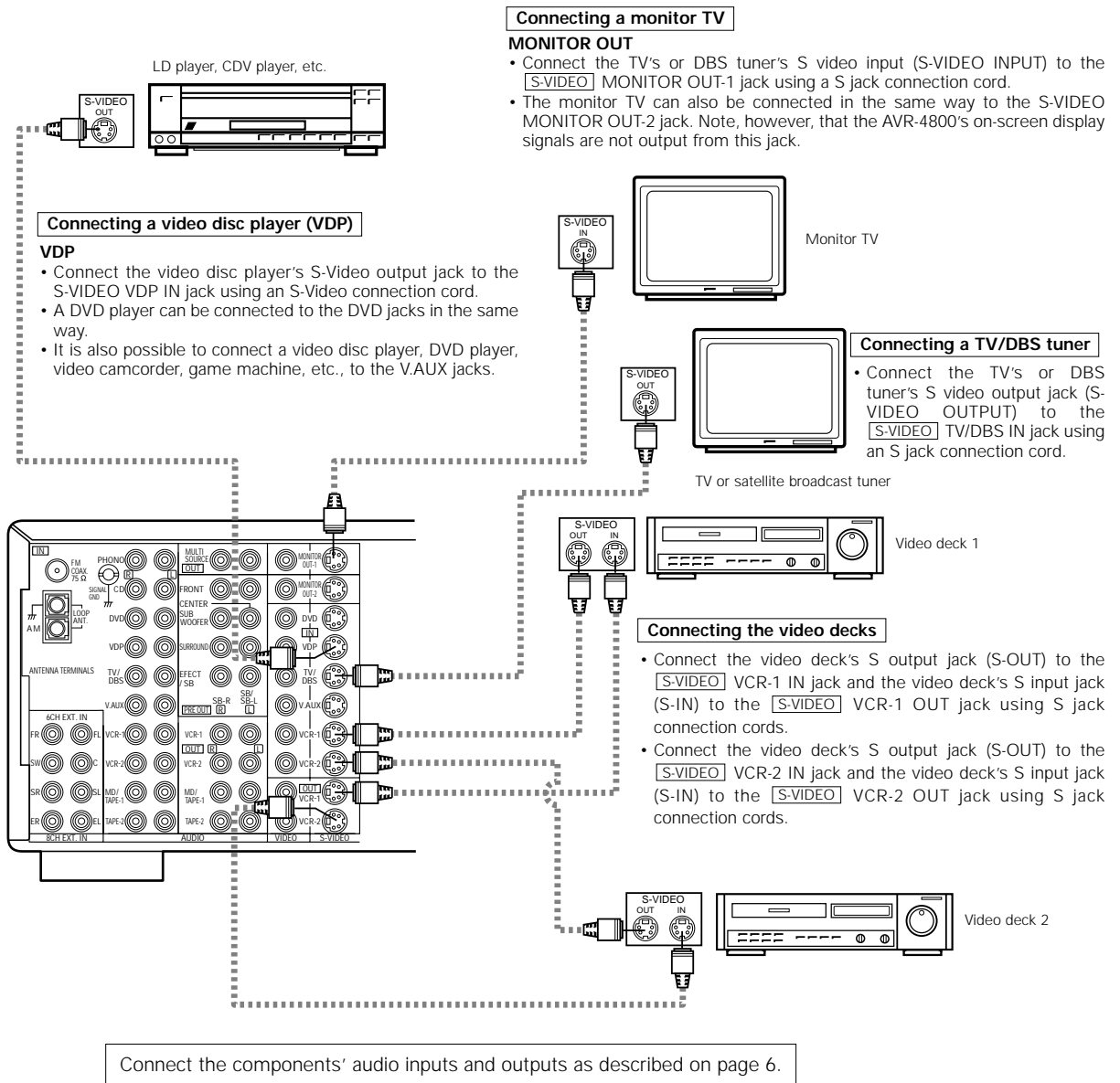

NOTE:

- The on-screen display signals are not output from the video signal MONITOR OUT-2 (yellow) or S-Video signal MONITOR OUT-2 jack.

Connecting a Video Component Equipped with Color Difference (Component - Y, R-Y, B-Y) Video Jacks (DVD Player)

- When making connections, also refer to the operating instructions of the other components.
- The signals input to the color difference (component) video jacks are not output from the VIDEO output jack (yellow) or the S-Video output jack. In addition, the video signals input to the VIDEO input (yellow) and S-Video input jacks are not output to the color difference (component) video jacks.
- The AVR-4800's on-screen display signals are not output from the color difference (component) video output jacks (MONITOR OUT).
- Some video sources with component video outputs are labeled Y, Pb, Pr, or Y, Cb, Cr, or Y, R-Y, B-Y. These terms all refer to component video color difference output.

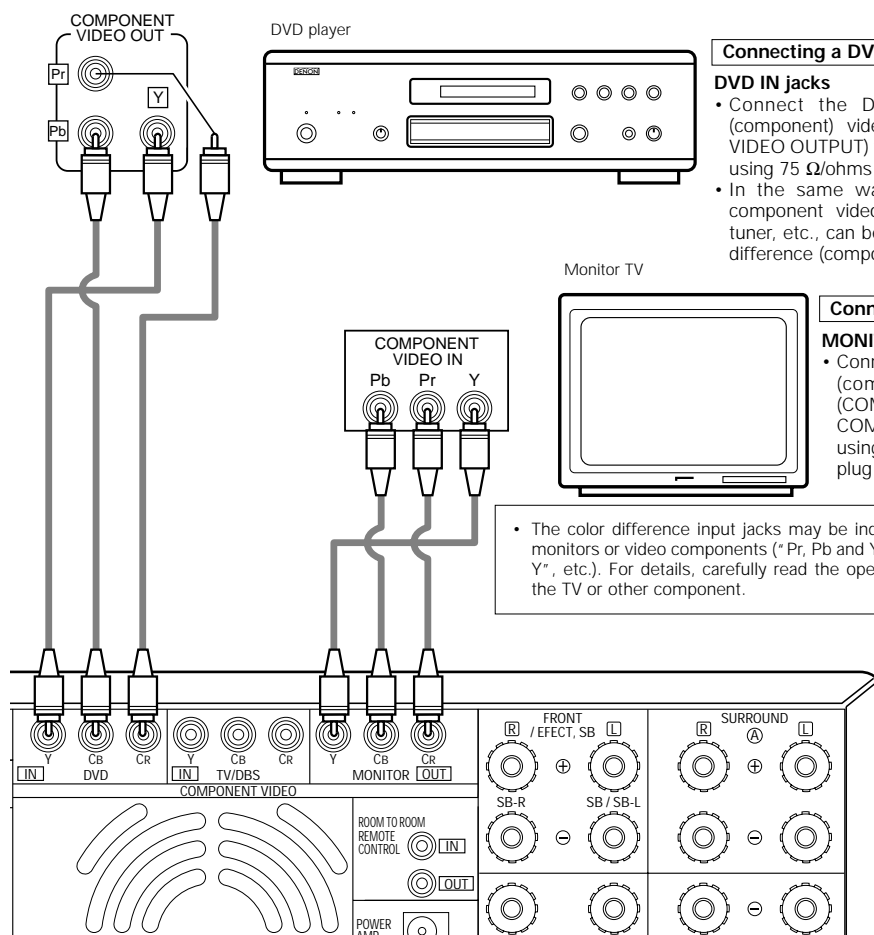

Connecting the antenna terminals

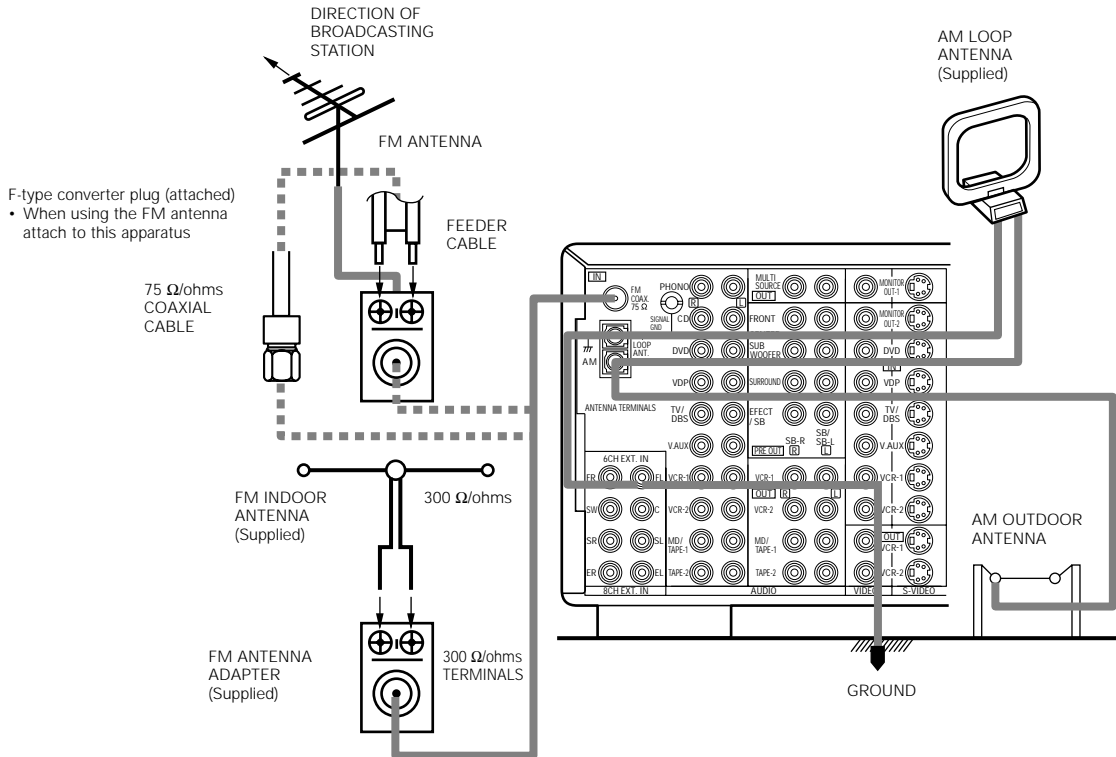

- An F-type FM antenna cable plug can be connected directly.
- If the FM antenna cable's plug is not of the F-type, connect using the included antenna adapter.

AM loop antenna assembly

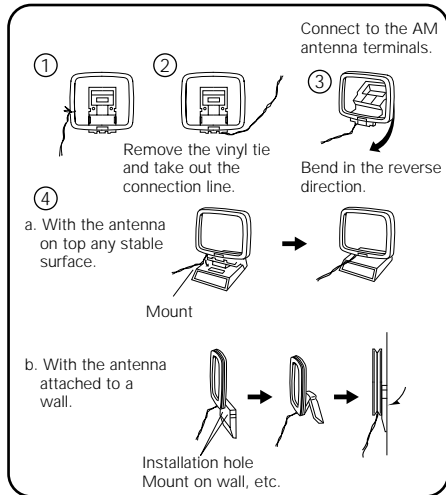

FM antenna adapter assembly

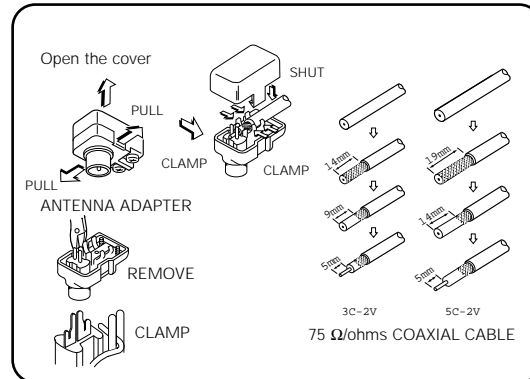

Connection of AM antennas

1. Loosen by turning counterclockwise.
2. Insert the cord.
3. Tighten by turning clockwise.

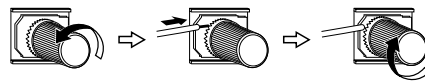

Note to CATV system installer:

This reminder is provided to call the CATV system installer's attention to Article 820-40 of the NEC which provides guidelines for proper grounding and, in particular, specifies that the cable ground shall be connected to the grounding system of the building, as close to the point of cable entry as practical.

Notes:

- Do not connect two FM antennas simultaneously.
- Even if an external AM antenna is used, do not disconnect the AM loop antenna.
- Make sure AM loop antenna lead terminals do not touch metal parts of the panel.

Connecting the external input (EXT. IN) jacks

- These jacks are for inputting multi-channel audio signals from an outboard decoder, or a component with a different type of multi-channel decoder, such as a Super Audio DVD player, or a multi-channel SACD player, or other future multi-channel sound format decoder.
- When making connections, also refer to the operating instructions of the other components.

When connecting a high definition (MUSE 3-1 format) component, use a separately sold mono/stereo cable if the surround channel output is monaural (Japan users).

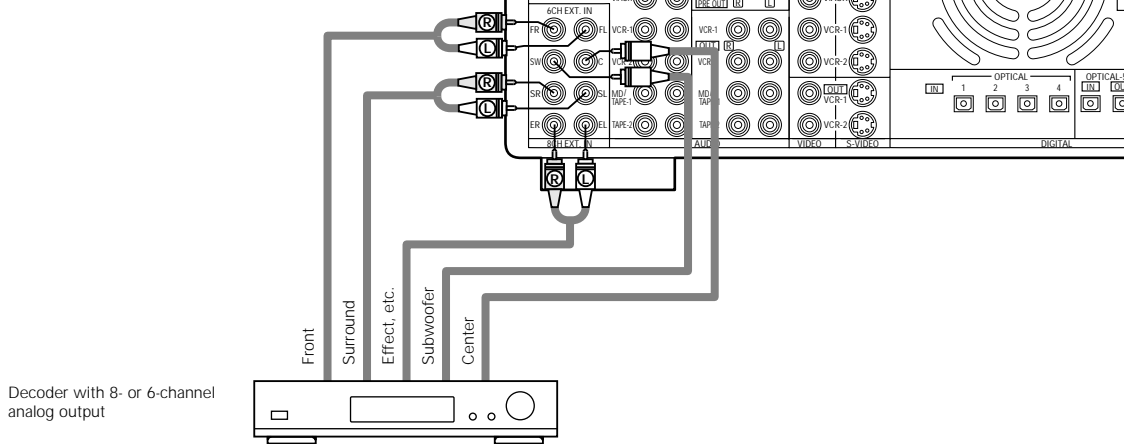

Decoder with 8- or 6-channel analog output

※ For instructions on playback using the external input (EXT. IN) jacks, see page 44.

Connecting the MULTI SOURCE jacks

- If another pre-main (integrated) amplifier is connected, the multi-source jacks can be used to play a different program source in another room at the same time. (See page 43.)

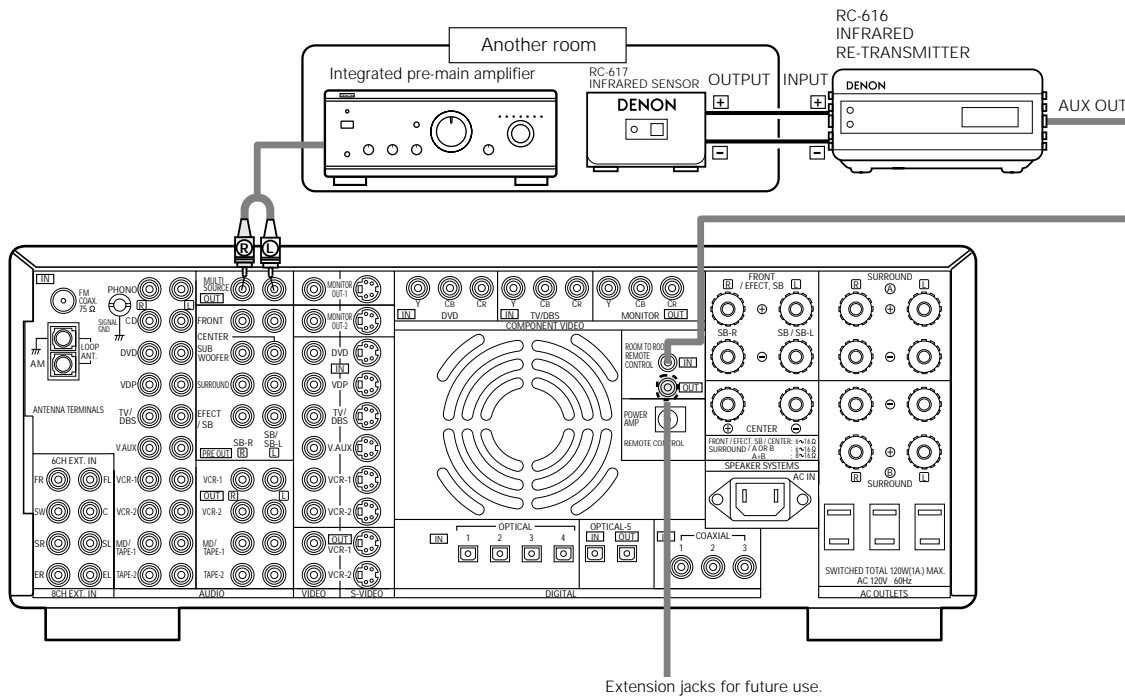

Extension jacks for future use.

※ For instructions on operations using the MULTI SOURCE jacks, see page 43 or page 45.

Speaker system connections

- Connect the speaker terminals with the speakers making sure that like polarities are matched (⊕ with ⊕, ⊖ with ⊖). Mismatching of polarities will result in weak central sound, unclear orientation of the various instruments, and the sense of direction of the stereo being impaired.
- When making connections, take care that none of the individual conductors of the speaker cord come in contact with adjacent terminals, with other speaker cord conductors, or with the rear panel.

NOTE:

NEVER touch the speaker terminals when the power is on. Doing so could result in electric shocks.

Speaker Impedance

- Speakers with an impedance of from 6 to 16 Ω/ohms can be connected for use as front and center speakers.
- Speakers with an impedance of 6 to 16 Ω/ohms can be connected for use as surround speakers.
- The protector circuit may be activated if the set is played for long periods of time at high volumes when speakers with an impedance lower than the specified impedance are connected.

Connecting the speaker cords

1. Loosen by turning counterclockwise.

2. Insert the cord.

3. Tighten by turning clockwise.

Either tightly twist or terminate the core wires.

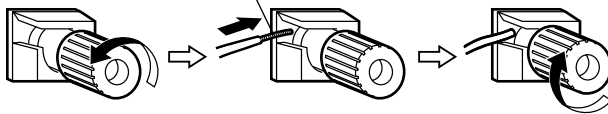

Connecting banana plugs

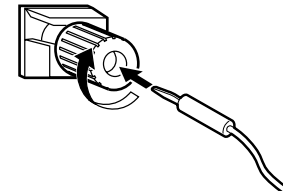

Turn clockwise to tighten, then insert the banana plug.

Connections

- When making connections, also refer to the operating instructions of the other components.

Connection jack for subwoofer with built-in amplifier (super woofer), etc.

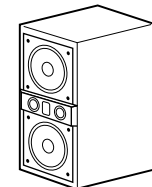

IN

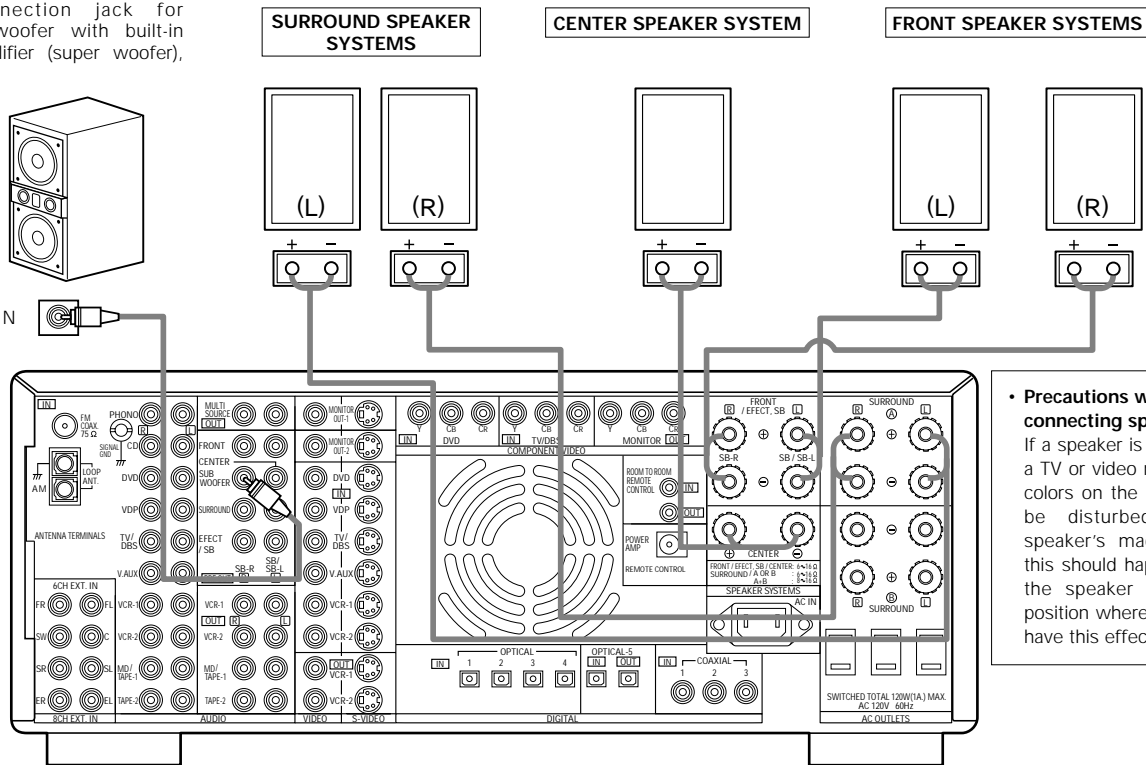

• Precautions when connecting speakers
If a speaker is placed near a TV or video monitor, the colors on the screen may be disturbed by the speaker's magnetism. If this should happen, move the speaker away to a position where it does not have this effect.

Connections when using surround back speakers

(1) When using a power amplifier for the surround back channel

Connect the PRE OUT SBL and SBR jacks to the power amplifier's input jacks.

Connection jack for subwoofer with built-in amplifier (super woofer), etc.

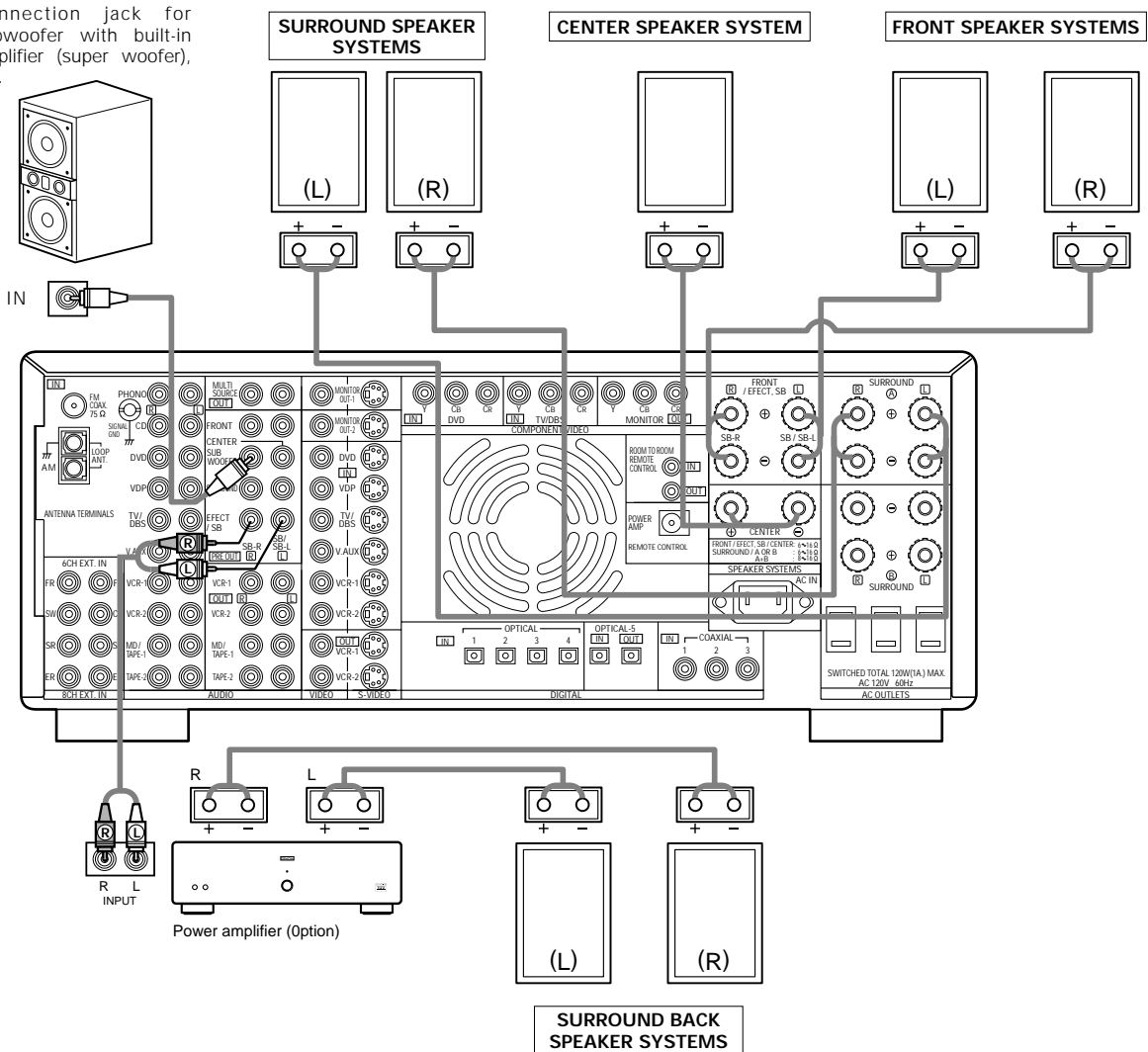

※ The power amplifier's SP outputs are used for the surround back channels (EFFECT channels for 8ch EXT IN).

NOTE:

When using only one surround back speaker, connect it to the surround back left channel.

(2) When using an external stereo power amplifier for the front channels

Connect the PRE OUT FL and FR jacks to the power amplifier's input jacks.

When these connections are used, select "Center/Surround/SurroundBack" for "Power Amp Assignment" in the System Setup Menu. (see page 24)

Connection jack for subwoofer with built-in amplifier (super woofer), etc.

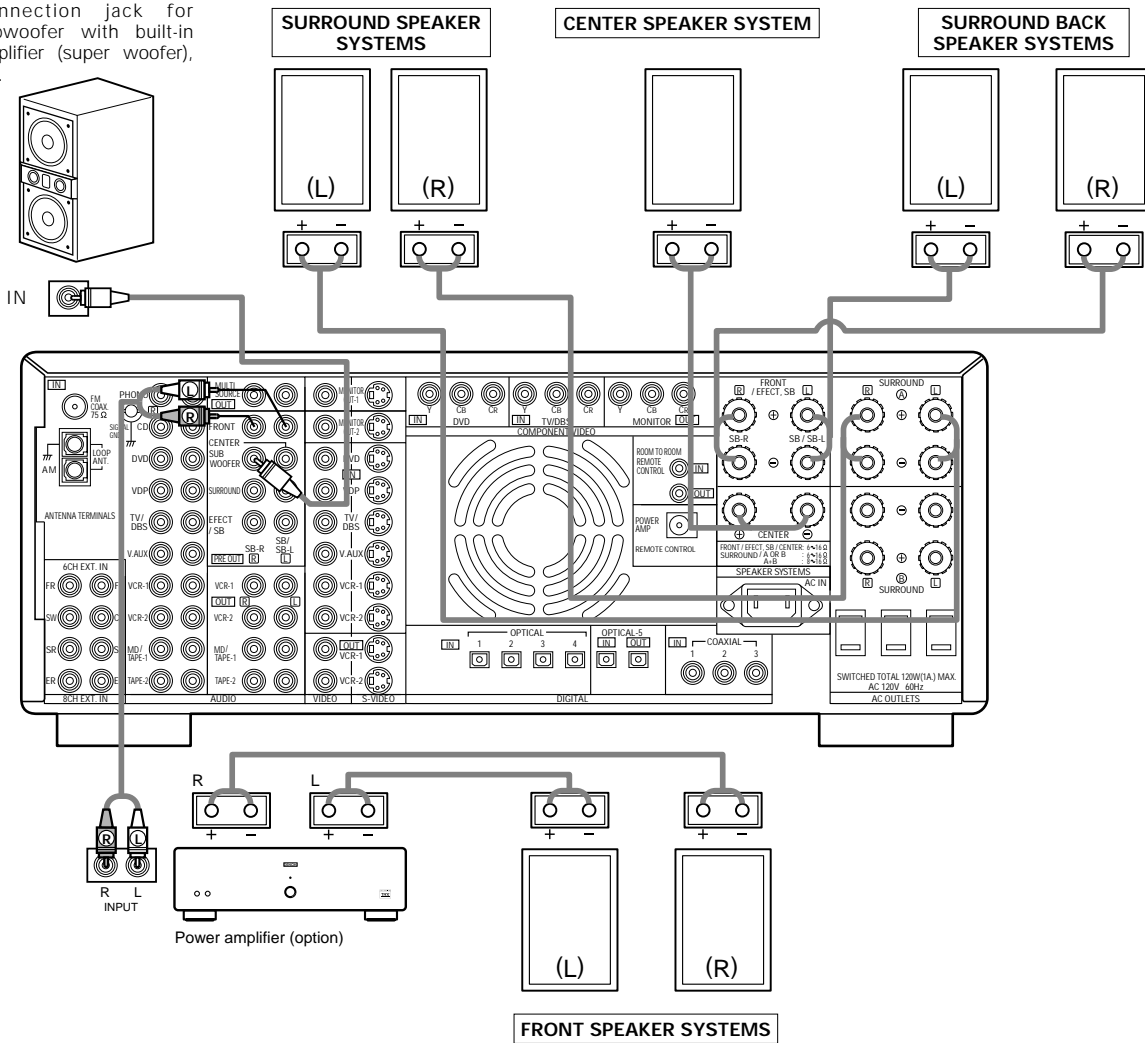

※ The FRONT/EFFECT SB [L] and [R] jacks are used for the surround back channels (EFFECT channels for 8ch EXT IN), the power amplifier's SP outputs for the front left and right channels.

NOTE:

When using only one surround back speaker, connect it to the surround back left channel.

When using the remote cable (may be included with a Denon power amplifier) to connect a Denon power amplifier to the POWER AMP REMOTE CONTROL jack, the power amplifier's power turns on and off together with the power of the AVR-4800.

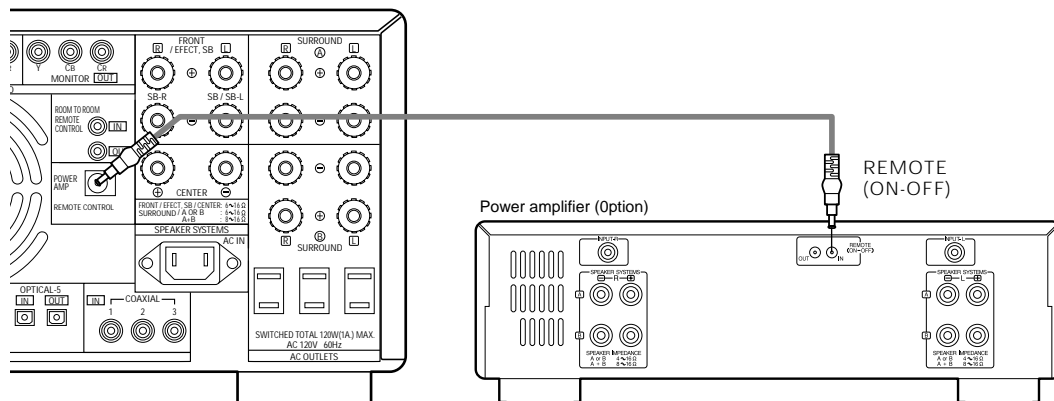

Protector circuit

- This unit is equipped with a high-speed protection circuit. The purpose of this circuit is to protect the speakers under circumstances such as when the output of the power amplifier is inadvertently short-circuited and a large current flows, when the temperature surrounding the unit becomes unusually high, or when the unit is used at high output over a long period which results in an extreme temperature rise.

When the protection circuit is activated, the speaker output is cut off and the power supply indicator LED flashes. Should this occur, please follow these steps: be sure to switch off the power of this unit, check whether there are any faults with the wiring of the speaker cables or input cables, and wait for the unit to cool down if it is very hot. Improve the ventilation condition around the unit and switch the power back on.

If the protection circuit is activated again even though there are no problems with the wiring or the ventilation around the unit, switch off the power and contact a DENON service center.

Note on speaker impedance

- The protector circuit may be activated if the set is played for long periods of time at high volumes when speakers with an impedance lower than the specified impedance (for example speakers with an impedance of lower than 4 Ω /ohms) are connected. If the protector circuit is activated, the speaker output is cut off. Turn off the set's power, wait for the set to cool down, improve the ventilation around the set, then turn the power back on.

Cooling fan

- The AVR-4800 is equipped with a cooling fan to prevent the temperature inside the set from rising. The fan is activated under certain usage conditions. It is temperature and volume level sensitive, to minimize or prevent audible fan noise.

6 PART NAMES AND FUNCTIONS

Front Panel

- For details on the functions of these parts, refer to the pages given in parentheses ().

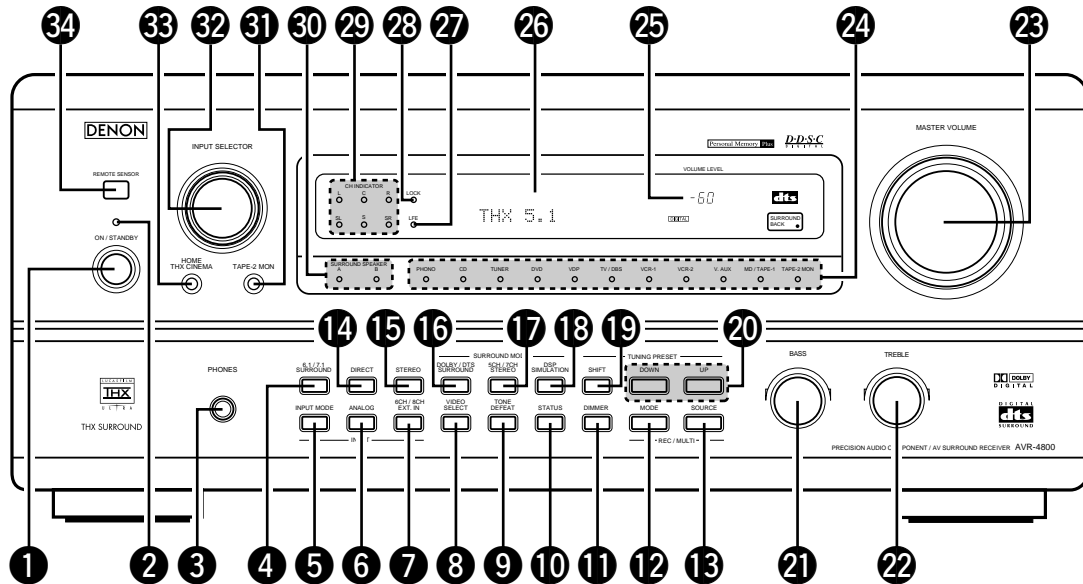



- | | |
|---|--|
| 1 Power switch.....(39) | 19 SHIFT button(58, 59) |
| 2 Power indicator.....(39) | 20 PRESET UP/DOWN button.....(58, 59) |
| 3 Headphones jack (PHONES).....(41) | 21 BASS adjustment control(41) |
| 4 6.1/7.1 SURROUND button.....(51) | 22 TREBLE adjustment control(41) |
| 5 INPUT MODE selector button.....(40) | 23 MASTER VOLUME control.....(41) |
| 6 ANALOG button.....(40) | 24 Input source indicators |
| 7 6CH/8CH external input button
(6CH/8CH EXT. IN).....(44) | 25 Master volume indicator (VOLUME LEVEL).....(41) |
| 8 VIDEO SELECT button(42) | 26 Display |
| 9 TONE DEFEAT button(41) | 27 Low frequency effect indicator (LFE)(49) |
| 10 STATUS button(42) | 28 Digital lock indicator (LOCK)(41) |
| 11 DIMMER button(42) | 29 Dolby digital/DTS surround input channel indicators
[CH INDICATOR](49) |
| 12 REC/MULTI MODE selector button.....(43) | 30 Surround speaker system indicators
(SURROUND SPEAKER A/B) |
| 13 REC/MULTI SOURCE selector button.....(43) | 31 Tape 2 monitor button (TAPE-2 MON).....(40) |
| 14 DIRECT button.....(54) | 32 Input source selector dial (INPUT SELECT).....(40) |
| 15 STEREO button.....(54) | 33 HOME THX CINEMA button(49) |
| 16 DOLBY/DTS SURROUND button(54) | 34 Remote control sensor (REMOTE SENSOR)(31) |
| 17 5CH/7CH STEREO button(54) | |
| 18 DSP SIMULATION button(54) | |

Remote control unit

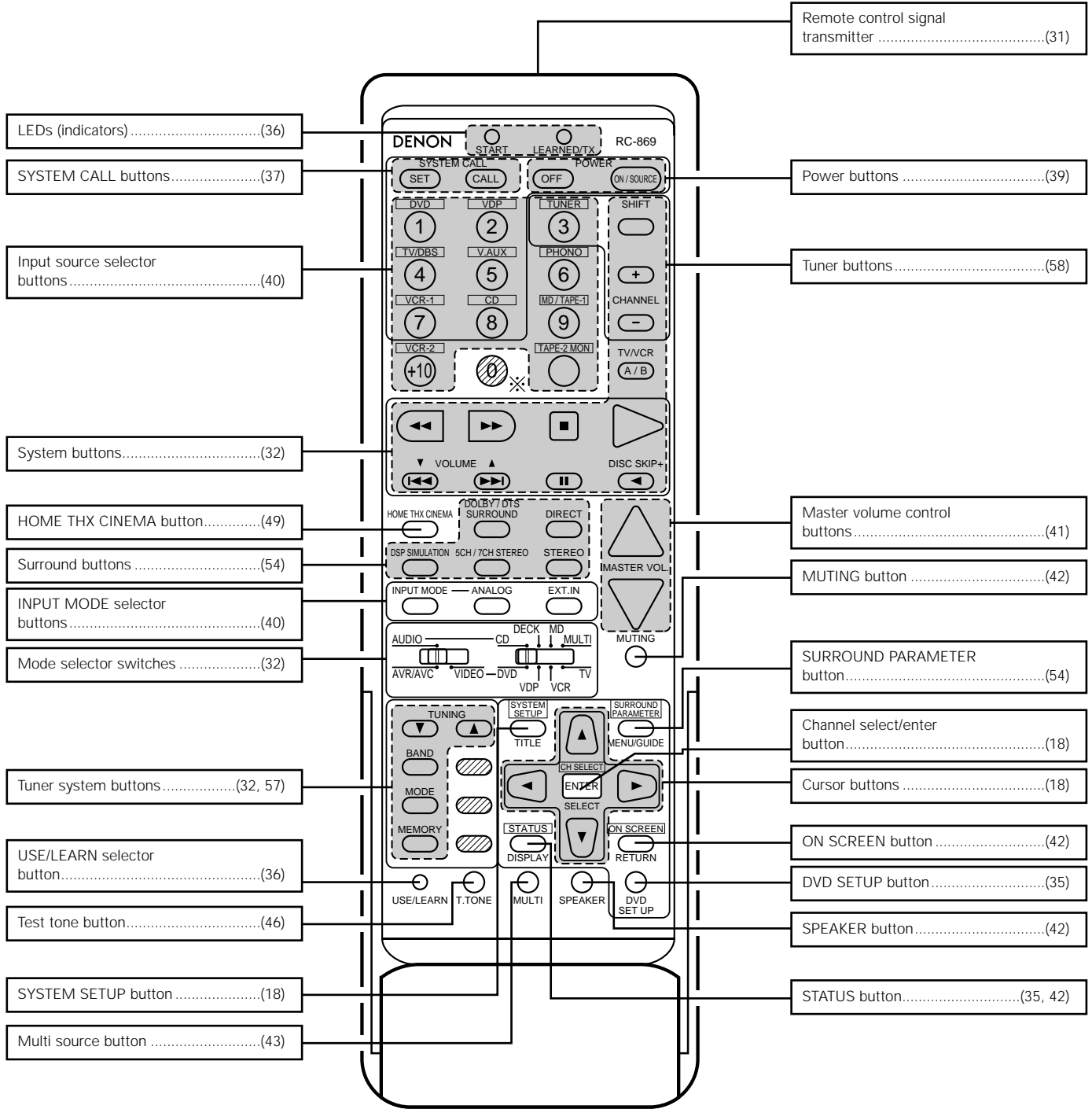
• For details on the functions of these parts, refer to the pages given in parentheses ().



NOTE

- The shaded buttons  do not function with the AVR-4800. (Nothing happens when they are pressed.) The button indicated , however, can be used with the learning function.

7 SETTING UP THE SYSTEM

- Once all connections with other AV components have been completed as described in "CONNECTIONS" (see pages 6 to 15), make the various settings described below on the monitor screen using the AVR-4800's on-screen display function. These settings are required to set up the listening room's AV system centered around the AVR-4800.
- Use the following buttons to set up the system:

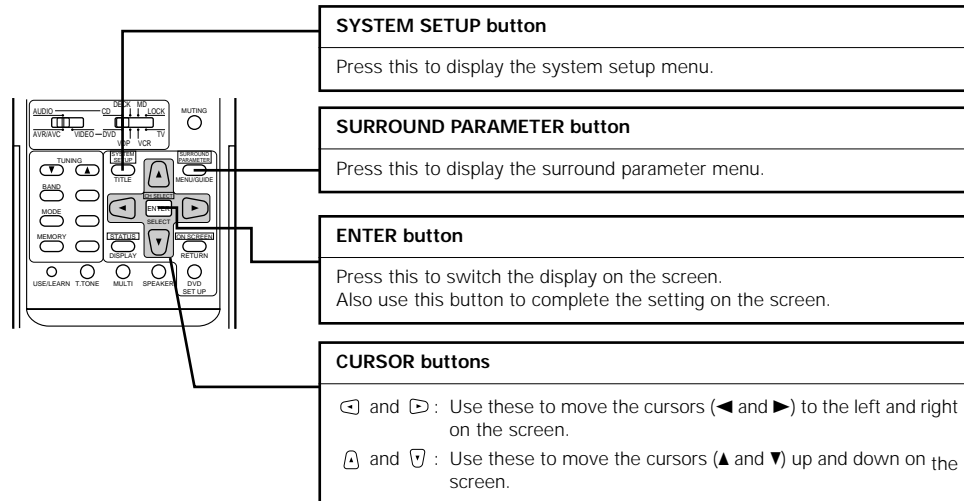

- System setup items and default values (set upon shipment from the factory)

System setup			Default settings								
①	Speaker Configuration	Input the combination of speakers in your system and their corresponding sizes (SMALL for regular speakers, LARGE for full-size, full-range) to automatically set the composition of the signals output from the speakers and the frequency response.	Front Sp.		Center Sp.	Surround Sp.		Surround Back Sp.	Sub Woofer		
	(Surround Speaker Setting)	Use this function when using multiple surround speaker combinations for more ideal surround sound. Once the combinations of surround speakers to be used for the different surround modes are preset, the surround speakers are selected automatically according to the surround mode.	Small		Small	Small		Small / 2spkrs	Yes		
	Surround mode	Surround mode	DOLBY/DTS SURROUND	THX SURROUND	WIDE SCREEN	5CH/7CH STEREO	DSP SIMULATION	EXT. IN	—	—	
	Surround speaker	Surround speaker	A	A	A	A	A	A	—	—	
	Subwoofer mode	This selects the subwoofer speaker for playing deep bass signals.	LFE —THX—								
②	THX Surround EX	Select the operation when the "THX Surround EX" surround parameter is set to "ON".	THX Surround EX = ON								
③	Delay Time	This parameter is for optimizing the timing with which the audio signals are produced from the speakers and subwoofer according to the listening position.	Front L & R		Center	Surround L & R		SBL & SBR	Sub Woofer		
			12 ft (3.6 m)		12 ft (3.6 m)	10 ft (3.0 m)		10 ft (3.0 m)	12 ft (3.6 m)		
④	Power Amp Assignment	Set this when the power amplifier for the front channels is switched for use with the surround back channel.	Front / Center / Surround								
⑤	Channel Level	This adjusts the volume of the signals output from the speakers and subwoofer for the different channels in order to obtain optimum effects.	Front L	Front R	Center	Surround L	Surround R	Surround Back L	Surround Back R	Subwoofer	
			0 dB	0 dB	0 dB	0 dB	0 dB	0 dB	0 dB	0 dB	0 dB
⑥	Subwoofer Peak Limit Lev	This parameter is for detecting the maximum level of the low bass signals output from the subwoofer channel in order to protect the subwoofer from damage and prevent unpleasant distorted sounds from being produced.	Peak Limiter = OFF								
⑦	Digital In Assignment	This assigns the digital input jacks for the different input sources.	Input source	CD	DVD	VDP	TV/DBS	VCR-1	VCR-2	V. AUX	TAPE-1
			Digital Inputs	COAXIAL 1	COAXIAL 2	COAXIAL 3	OPTICAL 1	OPTICAL 2	OPTICAL 3	OPTICAL 4	OPTICAL 5
⑧	On Screen Display	This sets whether or not to display the on-screen display that appears on the monitor screen when the controls on the remote control unit or main unit are operated (from MONITOR 1 outputs only).	On Screen Display = ON								
⑨	Auto Tuner Presets	FM stations are received automatically and stored in the memory.	A1 ~ A8	87.5/89.1/98.1/107.9/90.1/90.1/90.1/90.1 MHz							
			B1 ~ B8	520/600/1000/1400/1500/1710 kHz/90.1/90.1 MHz							
			C1 ~ C8	90.1 MHz							
			D1 ~ D8	90.1 MHz							
			E1 ~ E8	90.1 MHz							

NOTES:

- The on-screen display signals are not output from the MONITOR OUT-2 output jack or the color difference (component) video signal (MONITOR OUT) jacks.
- The on-screen display signals are output with priority to the S-VIDEO MONITOR OUT jack during playback of a video component. For example, if the TV monitor is connected to both the AVR-4800's S-Video and video monitor output jacks and signals are input to the AVR-4800 from a video source (VDP, etc.) connected to both the S-Video and video input jacks, the on-screen display signals are output with priority to the S-Video monitor output. If you wish to output the signals to the video monitor output jack, do not connect a cord to the S-VIDEO MONITOR OUT jack. (For details, see page 30.)
- The AVR-4800's on-screen display function is designed for use with high resolution monitor TVs, so it may be difficult to read small characters on TVs with small screens or low resolutions.
- The setup menu is not displayed when headphones are being used.

• Speaker system layout

Basic system layout (For a THX Surround EX system)

- The following is an example of the basic layout for a system consisting of eight speaker systems and a television monitor:

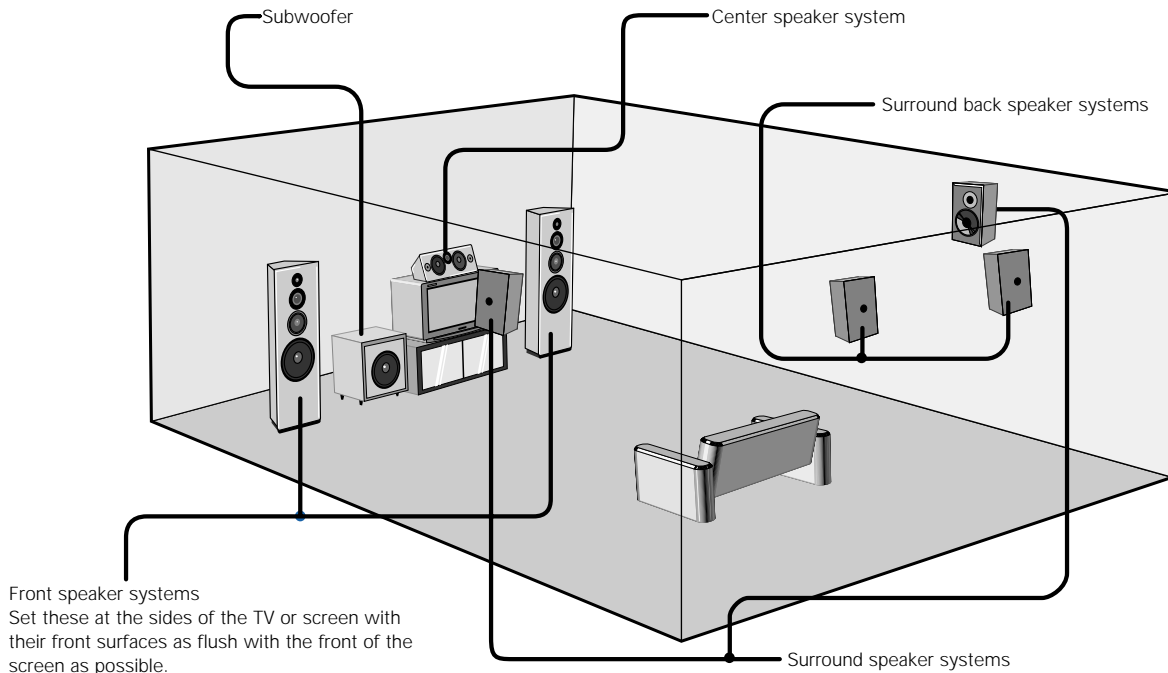

With the AVR-4800 it is also possible to use the surround speaker selector function to choose the best layout for a variety of sources and surround modes.

• Surround speaker selector function

This function makes it possible to achieve the optimum sound fields for different sources by switching between two systems of surround speakers (A and B). The settings of the different speakers (A only, B only or A+B) are stored in the memory for the different surround modes, so they are set automatically when the surround mode is selected. In addition, since the setting of the surround back speakers (ON or OFF) is stored separately for surround speakers A and B, it is possible to set either a multi surround speaker system (A) using the surround back speakers or a single surround speaker system (B) for the different surround modes.

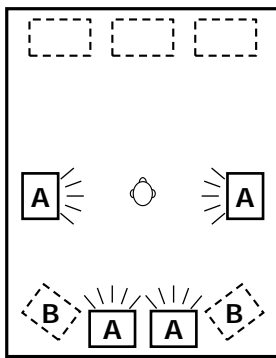

Using A only
(Multi surround speaker system)

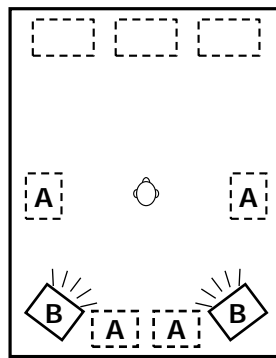

Using B only
(Single surround speaker system)

- It is also possible to select surround speakers A+B, but we recommend using the more effective multi surround speaker system with the surround back speakers.

Before setting up the system

1 Check that all the connections are correct, then turn on the main unit's power.

2 Display the System Setup Menu.

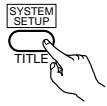

System Setup Menu
 Speaker Configuration
 THX Surround EX
 Delay Time
 Power Amp Assignment
 Channel Level
 Subwoofer Peak Limit Lev.
 Digital In Assignment
 On Screen Display
 Auto Tuner Presets

Setting the type of speakers

• The composition of the signals output from the different channels and the frequency response are adjusted automatically according to the combination of speakers actually being used.

1 At the System Setup Menu select "Speaker Configuration".

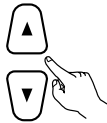

2 Switch to the speaker configuration screen.



3 Set whether or not speakers are connected and, if so, their size parameters.



- To select the speaker

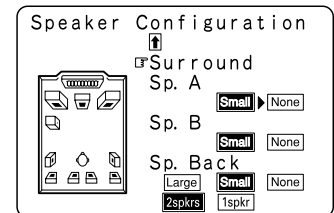
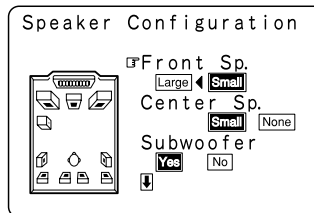

- To select the parameter

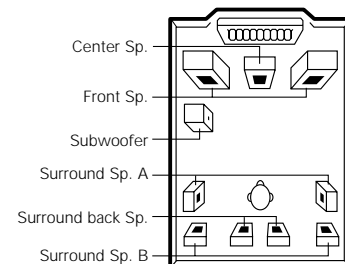
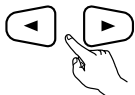

4



Enter the setting.

- a) If no surround speakers are used (if "None" is set for both A and B):
The System Setup Menu reappears.
- b) If both surround speakers A and B are used (if either "Large" or "Small" is set for both A and B):
The surround speaker setting screen appears.
- c) When "Front" is set to "Large" and "Subwoofer" is set to "Yes", the set switches to the subwoofer mode.
- d) If "None" is set for surround speakers A:
"None" is automatically set for surround speakers B and surround back speaker.

NOTE:

- Select "Large" or "Small" not according to the actual size of the speaker but according to the speaker's capacity for playing low frequency (approximately 80 Hz and below) signals. If you do not know, try comparing the sound at both settings (setting the volume to a level low enough so as not to damage the speakers) to determine the proper setting.

Parameters

- LargeSelect this when using speakers that can fully reproduce low sounds of below 80 Hz.
- SmallSelect this when using speakers that cannot reproduce low sounds of below 80 Hz with sufficient volume.
When this setting is selected, low frequencies of below 80 Hz are assigned to the subwoofer.
- None.....Select this when no speakers are installed.
- Yes/No.....Select "Yes" when a subwoofer is installed, "No" when a subwoofer is not installed.
- 2spkr/1spkr.....Select the number of speakers to be used for the surround back channel.
- ※ If the subwoofer has sufficient low frequency playback capacity, good sound can be achieved even when "Small" is set for the front, center and surround speakers.
- ※ To take full advantage of the performance of the Home THX certified speaker systems, set the front, center and surround speaker size parameters to "Small" and the subwoofer to "Yes".
- ※ For the majority of speaker system configurations, using the SMALL setting for all five main speakers and Subwoofer On with a connected subwoofer will yield the best results.
- ※ When "Front" is set to "Small", "Subwoofer" is automatically set to "Yes", and when "Subwoofer" is set to "No", "Front" is automatically set to "Large".

Selecting the surround speakers for the different surround modes

- At this screen preset the surround speakers to be used in the different surround modes.

1

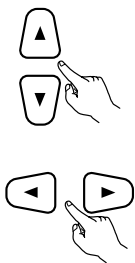

When either "Large" or "Small" has been set for both speakers A and B on the System Setup Menu (when using both A and B surround speakers), the surround speaker setting screen appears.

Select the surround speakers to be used in the different surround modes.

- To select the surround mode
- To select the surround speaker
- A: When using surround speakers A
- B: When using surround speakers B
- A+B: When using both surround speakers A and B

Surround Sp.	Setting
DOLBY/DTS SURROUND	A B A+B
THX/THX5.1	A B A+B
WIDE SCREEN	A B A+B
5/7CH STEREO	A B A+B
DSP SIMULATION	A B A+B
EXT. IN	A B A+B

2



Enter the setting.

When "Front" is set to "Large" and "Subwoofer" is set to "Yes", the set switches to the subwoofer mode.

- ※ Speaker type setting when using both surround speakers A and B
If "Small" is set for either surround speakers A or B, the output is the same as when "Small" is set for both A and B.
- ※ For the "WIDE SCREEN" and "5/7CH STEREO" DSP simulation modes, the surround speakers can be set separately.

Setting the Subwoofer mode

1

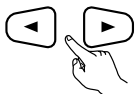

Select the bass signal playback mode.

Subwoofer Mode	
LFE -THX-	LFE +Main

2



Enter the setting.
The System Setup Menu reappears.

NOTES:

- In the Subwoofer Mode screen, you have the flexibility to choose how bass information is distributed to your speakers if you have large front left and right speakers and a subwoofer as part of your home theater speaker system.
- By selecting the "LFE + Main" option, you will be sending the same bass frequencies to both the front left, front right, AND the subwoofer speakers simultaneously. Depending upon your room size and shape, this can create a more evenly distributed bass around the room or sometimes actually decrease the amount of bass in the room due to low frequency cancellations.
- If the "LFE -THX-" option is selected, bass from the large front left and front right speakers goes ONLY to the front left and front right speakers. Bass going to the subwoofer comes from the LFE signal and any speakers which you have designated as "Small." This selection is preferred by THX as it reduces the chances of bass cancellations in the room.
- Once you have positioned all of your speakers in the room, choose the option which gives you the most solid sounding bass.

Setting the THX Surround EX

Set the operation for the digital signals when playing in the Dolby 6.1, DTS (ES) and THX 5.1 EX surround modes.

1

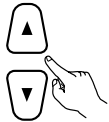

At the System Setup Menu select "THX Surround EX".

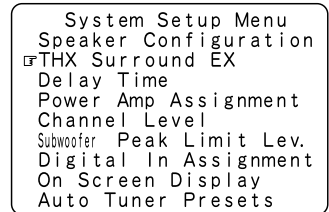

2

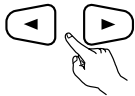

Select the desired setting.

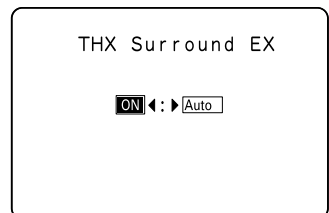

3



Enter the setting.
The System Setup Menu reappears.

Setting

- ONThe surround back speakers are always used during playback.
Set the "ON" mode to perform 6.1-channel playback with conventional 5.1-channel sources or sources on which the identification signal described below is not recorded.
- AUTOThis function only works with software on which a special identification signal is recorded. This software is scheduled to go on sale in the future.
This is a function for automatically playing in the 6.1-channel mode using the surround back speakers if the software is recorded in THX Surround EX or DTS (ES) or in the normal 5.1-channel mode without using the surround back speakers when the software is not recorded in THX Surround EX or DTS (ES).

NOTES:

- The "THX Surround EX" setting screen is displayed when the surround back speaker is set to "Small" at "Speaker Configuration".
- The surround back speakers can also be turned on and off using the "THX Surround EX" or "6.1/7.1 Surround" surround parameter. (See pages 49, 51 and 56)
Select the setting according to the program source to be played.

Setting the delay time

- Input the distance between the listening position and the different speakers to set the delay time for the surround mode.
- The delay time can be set separately for surround speakers A and B.

Preparations:

Measure the distances between the listening position and the speakers (L1 to L5 on the diagram at the right).

- L1: Distance between center speaker and listening position
- L2: Distance between front speakers and listening position
- L3: Distance between surround speakers and listening position
- L4: Distance between surround back speakers and listening position
- L5: Distance between subwoofer and listening position

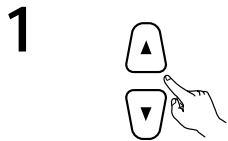
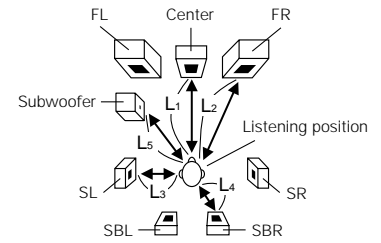

1 At the System Setup Menu select "Delay Time".

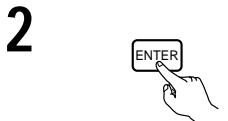
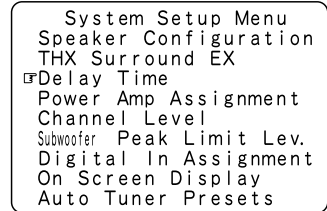

2 Switch to the Delay Time screen.

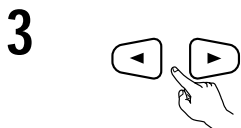
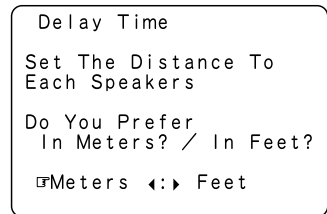

3 Select the desired unit, meters or feet.
Select (darken) the desired units, "Meters" or "Feet".

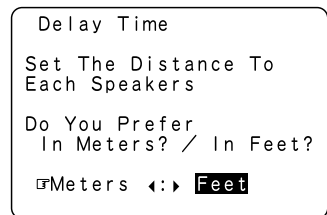

Example: When "Feet" is selected

4 Once "Meters" or "Feet" is selected in Step 3, the Delay Time screen appears automatically.

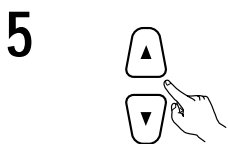
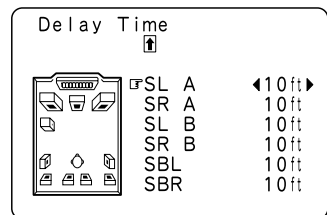
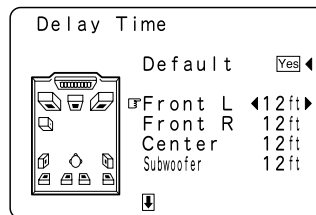

5 Select the speaker to be set.

6

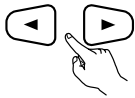

Set the distance between the center speaker and the listening position.
The distance changes in units of 1 foot (0.1 meters) each time the button is pressed. Select the value closest to the measured distance.

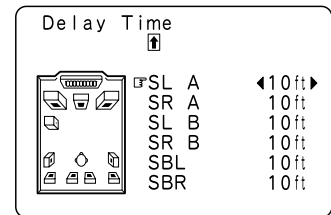
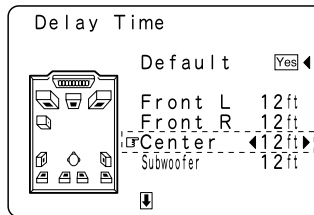

Example: When the distance is set to 12 feet for the center speaker

* If "Yes" is selected for "Default", the settings are automatically reset to the default values.

Please note that the difference of distance for every speaker should be 15 ft (4.5 m) or less. If you set an invalid distance, a CAUTION notice, such as screen right will appear. In this case, please relocate the blinking speaker(s) so that its distance is no larger than the value shown in highlighted line.

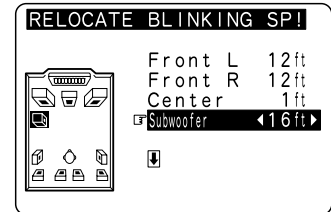

7



Enter the setting.
The System Setup Menu reappears.
The AVR-4800 automatically sets the optimum surround delay time for the listening room.

NOTE:

- If the distance unit is changed after the delay time is set, the settings are reset to the factory default values (see page 18).

Setting the Power Amp Assignment

- Set this when the power amplifier for the front channels is switched for use with the surround back channel.

1

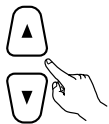

At the System Setup Menu select "Power Amp Assignment".

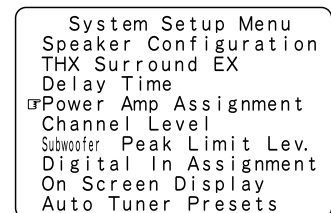

2



Switch to the Power Amp Assignment screen.

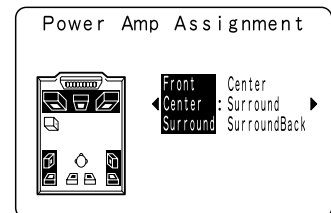

3

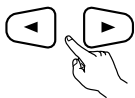

Select the setting.
The selected speaker(s) flash.

Front/Center/Surround:
This is the normal setting.

Center/Surround/SurroundBack:
The power amplifier for the front channels is used for the surround back channel.
When this is set, the surround back left and right signals are amplified and output from the front left and right speaker terminals.

The front channel signals are only output from the pre-out terminals, so connect a separate power amplifier to these terminals. (see page 14)

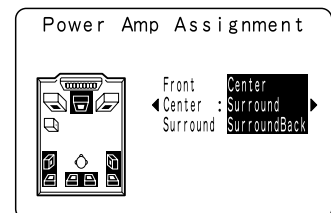



NOTE:

- The "Power Amp Assignment" setting screen is displayed when the surround back speaker is set to "Large" or "Small" at "Speaker Configuration".

Setting the channel level

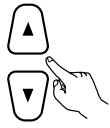
- Use this setting to adjust so that the playback level between the different channels is equal.
- From the listening position, listen to the test tones produced from the speakers to adjust the level.
- The level can also be adjusted directly from the remote control unit. (For details, see page 46.)
- When using both surround speakers A and B, their playback levels can be adjusted separately.

- 1**  At the System Setup Menu select "Channel Level".
- System Setup Menu
 Speaker Configuration
 THX Surround EX
 Delay Time
 Power Amp Assignment
 Channel Level
 Subwoofer Peak Limit Lev.
 Digital In Assignment
 On Screen Display
 Auto Tuner Presets
-
- 2**  Switch to the Channel Level screen.
- Channel Level

Test Tone Auto Manual

Surr. Sp. A B A+B

Back ON OFF

Test Tone Start Yes No

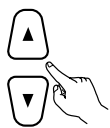
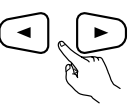
Level Clear Yes No
-
- 3**  Select "Test Tone Mode".
-
- 4**  Select the mode.
 Select "Auto" or "Manual".
- Auto:
Adjust the level while listening to the test tones produced automatically from the different speakers.
 - Manual:
Select the speaker from which you want to produce the test tone to adjust the level.
- Channel Level

Test Tone Auto Manual

Surr. Sp. A B A+B

Back ON OFF

Test Tone Start Yes No

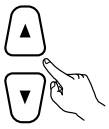
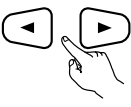
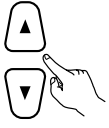
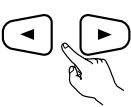
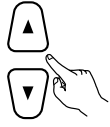
Level Clear Yes No
- Example: When the "Auto" mode is selected
-
- 5**  →  Select "Surr. Sp.", then select the surround speaker(s) from which you want to produce the test tone (A, B or A+B).
- Surr. Sp.: A
Adjusts the balance of the playback level between the channels when using surround speaker A.
 - Surr. Sp.: B
Adjusts the balance of the playback level between the channels when using surround speaker B.
 - Surr. Sp.: A+B
Adjusts the balance of the playback level between the channels when using surround speakers A and B at the same time.
- ※ The "Surr. Sp." can only be selected when both surround speakers A and B have been selected at the "Speaker Configuration" (when both A and B have been set to "Large" or "Small").
-
- 6**  →  Select "Back" and make the surround back speaker settings.
 Set to "ON" to play using the surround back speaker(s), to "OFF" if you do not want to use the surround back speaker(s).
- ※ This is not displayed if "None" is set for "Surround Sp. Back" at the "Speaker Configuration" screen.
-
- 7**  Select "Test Tone Start".

8



Select "Yes".

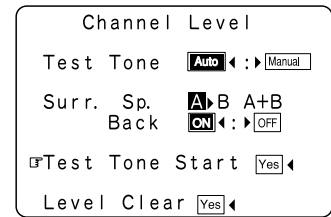

9

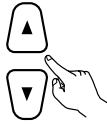

a. If the "Auto" mode is selected:
Test tones are automatically emitted from the different speakers. The test tones are emitted from the different speakers in the following order, at 4-second intervals the first time and second time around, 2-second intervals the third time around and on:

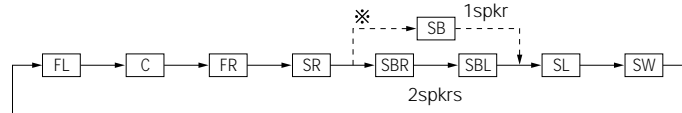

※ When the surround back speaker setting is set to "1spkr" for "Speaker Configuration", this is set to "SB".

Use the CURSOR buttons to adjust all the speakers to the same volume. The volume can be adjusted between -12 dB and +12 dB in units of 1 dB.

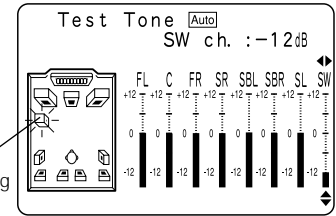

Example: When the volume is set to -12 dB while the test tone is being produced from the subwoofer

b. When the "Manual" mode is selected
Use the left and right cursor buttons to select the speaker from which you want to produce the test tone, then use the up and down cursor buttons to adjust so that the volume from the different speakers sounds the same.

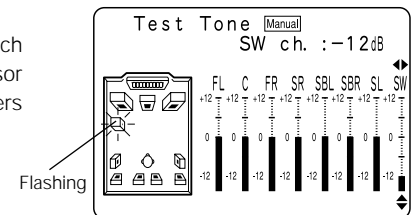
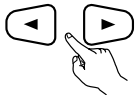

Example: When the volume is set to -12 dB while the subwoofer is selected

10



After the above settings are completed, press the ENTER button again. The "Channel Level" screen reappears.

※ To cancel the settings, select "Level Clear" and "Yes" on the "Channel Level" screen, then make the settings again.

The level of each channel should be adjusted to 75 dB (C-weighted, slow meter mode) on a sound level meter at the listening position. If a sound level meter is not available adjust the channels by ear so the sound levels are the same. Because adjusting the subwoofer level test tone by ear is difficult, use a well known music selection and adjust for natural balance.

NOTE: When adjusting the level of an active subwoofer system, you may also need to adjust the subwoofer's own volume control.

- ※ When you adjust the channel levels while in the SYSTEM SETUP CHANNEL LEVEL mode, the channel level adjustments made will affect ALL surround modes. Consider this mode a Master Channel Level adjustment mode.
- ※ After you have completed the SYSTEM SETUP CHANNEL LEVEL adjustments, you can then activate the individual surround modes and adjust channel levels that will be remembered for each of those modes. Then, whenever you activate a particular surround sound mode, your preferred channel level adjustments for just that mode will be recalled. Check the instructions for adjusting channel levels within each surround mode on Page 46.
- ※ You can adjust the channel levels for each of the following surround modes: DIRECT, STEREO, 5CH/7CH STEREO, DOLBY/DTS SURROUND, HOME THX CINEMA, WIDE SCREEN, SUPER STADIUM, ROCK ARENA, JAZZ CLUB, CLASSIC CONCERT, MONO MOVIE, and MATRIX.
- ※ When using either surround speakers A or B, or when using surround speakers A and B at the same time, be sure to adjust the balance of playback levels between each channel for the various selections of "A or B" and "A and B".

Subwoofer peak limit level setting

- This unit features a subwoofer peak limit control which prevents distortion and damage in the loudspeaker system by controlling the maximum bass volume level. With this feature you may set the maximum bass level for the system.
- This feature operates with or without a subwoofer in the system.

1

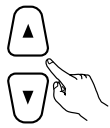

Use the CURSOR buttons to specify "Subwoofer Peak Limit Lev." from the "System Setup Menu" screen.

System Setup Menu
 Speaker Configuration
 THX Surround EX
 Delay Time
 Power Amp Assignment
 Channel Level
 Subwoofer Peak Limit Lev.
 Digital In Assignment
 On Screen Display
 Auto Tuner Presets

2



Switch to the Subwoofer Peak Limit Level Setting screen.

Subwoofer Peak
 Limit Level Setting

Find The Level When
 Distortion Begins.

Peak Limiter ON OFF

3



Select "ON" for Peak Limiter.

4

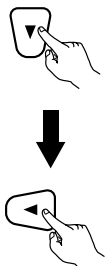

The screen switches. Select "Setting Start", then select "Yes".
 The screen switches and a test noise is produced from the speaker system.

Subwoofer Peak
 Limit Level Setting

Find The Level When
 Distortion Begins.

Peak Limiter ON OFF
 Setting Start Yes No

[Peak Limiter -18dB]

5



Increase the master volume level until the test noise is distorted.
 The test noise (bass sound) is distorted when it sounds as if the input is excessively high (when the sound crackles).

Subwoofer Peak
 Limit Level Setting

Turn Up The Volume
 With
 Master Vol. Button

When Distortion Begins
 Push Enter Button.

6



Press the ENTER button at the point where the test noise starts sounding distorted.
 The AVR-4800 automatically sets the subwoofer peak limit level.
 This prevents future inadvertent subwoofer overload due to excessively strong bass content when the master volume control is at a high level.

※ Clear the subwoofer's peak limit level setting by specifying "Peak Limiter" and "OFF".

CAUTION!

- The master volume is set to “-30 dB” when test tones are output.
- The test tones are for confirming the low frequency playback limits and are played at an extremely high level. When using a low output subwoofer, be very careful about irregular operations exceeding clipping by for example turning down the subwoofer’s attenuator before starting then slowly turning the attenuator up to the listening level.
- Also, when the subwoofer is set to “NO” in the speaker configuration, the test tones are output from the front speakers. When using front speakers with low input resistance, check that the sound is not clipped at sections where the signal is strong on the CD music source before starting the peak limit setting. The peak limit setting should not be performed if the music source cannot be played with the master volume set at “-15”. Set the front speakers to “small” and the subwoofer to “YES” in the speaker configuration. When this is done, the low frequencies are cut, so the effect is insufficient. We strongly recommend adding a subwoofer.
- If the test tone is clipped when it is set to “-18 dB”, set the peak limit to “-18 dB”. In this case, the input resistance of the subwoofer or front speakers is insufficient so clipping may occur when playing music. We recommend switching to a subwoofer with a higher input resistance.

Setting the Digital In Assignment

- This setting assigns the digital input jacks of the AVR-4800 for the different input sources.

1

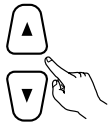

At the System Setup Menu select “Digital In Assignment”.

```
System Setup Menu
Speaker Configuration
THX Surround EX
Delay Time
Power Amp Assignment
Channel Level
Subwoofer Peak Limit Lev.
Digital In Assignment
On Screen Display
Auto Tuner Presets
```

2



Switch to the Digital In Assignment screen.

```
Digital In Assignment
CD : COAXIAL1
DVD : COAXIAL2
VDP : COAXIAL3
TV/DBS : OPTICAL1
VCR-1 : OPTICAL2
VCR-2 : OPTICAL3
V. AUX : OPTICAL4
TAPE-1 : OPTICAL5
Default Yes
```

3

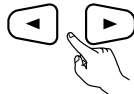
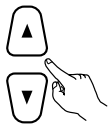

Select the digital input jack to be assigned to the input source.

- To select the input source
- To select the digital input jack

Select “OFF” for input sources for which no digital input jacks are used.

※ If “Yes” is selected for “Default”, the settings are automatically reset to the default values.

4



Enter the setting.
The System Setup Menu reappears.

NOTES:

- The OPTICAL 5 jacks on the AVR-4800’s rear panel are equipped with an optical digital output jack for recording digital signals on a DAT deck, MD player or other digital recorder. Use this for digital recording between a digital audio source (stereo - 2 channel) and a digital audio recorder.
- Do not connect the output of the component connected to the OPTICAL 5 OUT jack on the AVR-4800’s rear panel to any jack other than the OPTICAL 5 IN jack.
- “PHONO”, “TAPE-2” and “TUNER” cannot be selected on the Digital In Assignment screen.

Setting the on-screen display (OSD)

- Use this to turn the on-screen display (messages other than the menu screens) on or off.

- 

At the System Setup Menu select "On Screen Display".

System Setup Menu
Speaker Configuration
THX Surround EX
Delay Time
Power Amp Assignment
Channel Level
Subwoofer Peak Limit Lev.
Digital In Assignment
☐ On Screen Display
☑ Auto Tuner Presets
- 

Switch to the On Screen Display screen.

On Screen Display

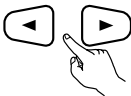
☑ ON ◀ : ▶ OFF
- 

Select "ON" or "OFF".
- 

Enter the setting.
The System Setup Menu reappears.

Auto tuner presets

Use this to automatically search for FM broadcasts and store up to 40 stations at preset channels A1 to 8, B1 to 8, C1 to 8, D1 to 8 and E1 to 8.

NOTES:

- If an FM station cannot be preset automatically due to poor reception, use the "Manual tuning" operation to tune in the station, then preset it using the manual "Preset memory" operation.

- 

Use the CURSOR buttons to specify "Auto Tuner Presets" from the "System Setup Menu" screen.

System Setup Menu
Speaker Configuration
THX Surround EX
Delay Time
Power Amp Assignment
Channel Level
Subwoofer Peak Limit Lev.
Digital In Assignment
On Screen Display
☑ Auto Tuner Presets

2



Press the ENTER button.
The "Auto Preset Memory" screen appears.

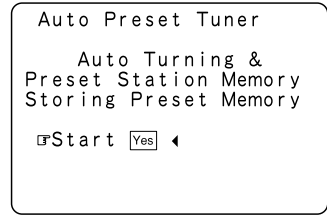

3

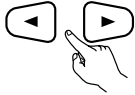

Use the CURSOR button to select "Yes".
"Search" flashes on the screen and searching begins.
"Completed" appears once searching is completed.
The display automatically switches to screen.

※ This completes system setup. Once these settings are made, there is no need to change them unless different AV components are connected or the speakers are repositioned.

After completing system setup

This button can be pressed at any time during the system setup process to complete the process.

1

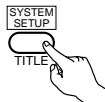

At the System Setup Menu, press the SYSTEM SETUP button.
※ The changed settings are entered and the on-screen display turns off.

• On-screen display signals

	Signals input to the AVR-4800		On-screen display signal output	
	VIDEO signal input jack (yellow)	S-video signal input jack	VIDEO MONITOR OUT-1 video signal output jack (yellow)	S-video MONITOR OUT-1 video signal output jack
1	×	×	○	○
2	○	×	○	×
3	×	○	×	○
4	○	○	×	○

(○: Signal ×: No signal)
(○: On-screen signals output ×: On-screen signals not output)

NOTES:

- The on-screen display signals are not output from the video signal MONITOR OUT-2 (yellow) or S-Video signal MONITOR OUT-2 jacks.
- The on-screen display signals are not output from the color difference (component) video signal MONITOR OUT jacks.
- For 4 above, the on-screen display signals are output to the VIDEO MONITOR OUT-1 video signal output jack (yellow) if the monitor TV is not connected to the S-video MONITOR OUT-1 video signal output jack.

8 REMOTE CONTROL UNIT

- The included remote control unit (RC-869) can be used to operate not only the AVR-4800 but other remote control compatible DENON components as well. Furthermore, it is equipped with a function for learning the control signals of remote control units of other manufacturers, so it can also be used to operate non-DENON remote control compatible video components.

Inserting the batteries

- ① Remove the remote control unit's rear cover.

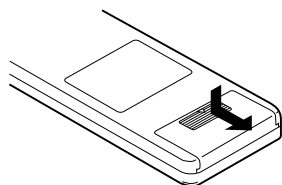

- ② Set two R6P (AA size) batteries in the battery compartment in the indicated direction.

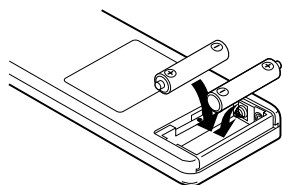

- ③ Put the rear cover back on.

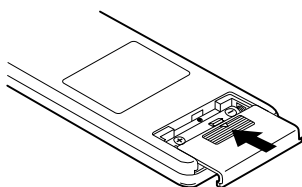

Notes on Batteries

- Use R6P (AA size) batteries in the remote control unit.
- The batteries should be replaced with new ones approximately once a year, though this depends on the frequency of usage.
- Even if less than a year has passed, replace the batteries with new ones if the set does not operate even when the remote control unit is operated nearby the set. (The included battery is only for verifying operation. Replace it with a new battery as soon as possible.)
- When inserting the batteries, be sure to do so in the proper direction, following the "⊕" and "⊖" marks in the battery compartment.
- To prevent damage or leakage of battery fluid:
 - Do not use a new battery together with an old one.
 - Do not use two different types of batteries.
 - Do not short-circuit, disassemble, heat or dispose of batteries in flames.
- Remove the batteries from the remote control unit when you do not plan to use it for an extended period of time.
- If the battery fluid should leak, carefully wipe the fluid off the inside of the battery compartment and insert new batteries.
- When replacing the batteries, have the new batteries ready and insert them as quickly as possible.
- The learned remote control signals may be cleared if no batteries are in the remote control unit for about 5 seconds. The factory-installed codes are in permanent memory, however.

Using the remote control unit

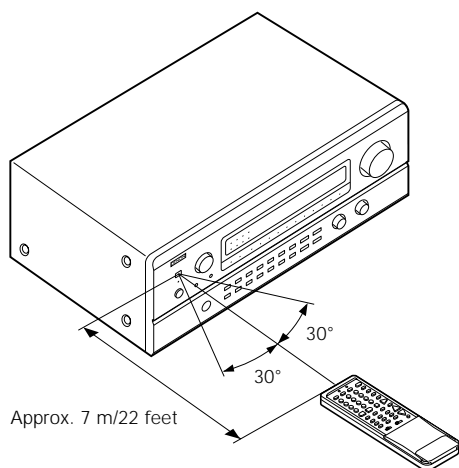

- Point the remote control unit at the remote sensor on the main unit as shown on the diagram.
- The remote control unit can be used from a straight distance of approximately 7 meters/22 feet from the main unit, but this distance will be shorter if there are obstacles in the way or if the remote control unit is not pointed directly at the remote sensor.
- The remote control unit can be operated at a horizontal angle of up to 30 degrees with respect to the remote sensor.

NOTES:

- It may be difficult to operate the remote control unit if the remote sensor is exposed to direct sunlight or strong artificial light.
- Do not press buttons on the main unit and remote control unit simultaneously. Doing so may result in malfunction.
- Neon signs or other devices emitting pulse-type noise nearby may result in malfunction, so keep the set as far away from such devices as possible.

Operating DENON audio components

- Turn on the power of the different components before operating them.

1 Set mode switch 1 to "AUDIO (AVR/AVC)".

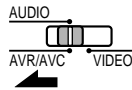

2 Set mode switch 2 to the position for the component to be operated.

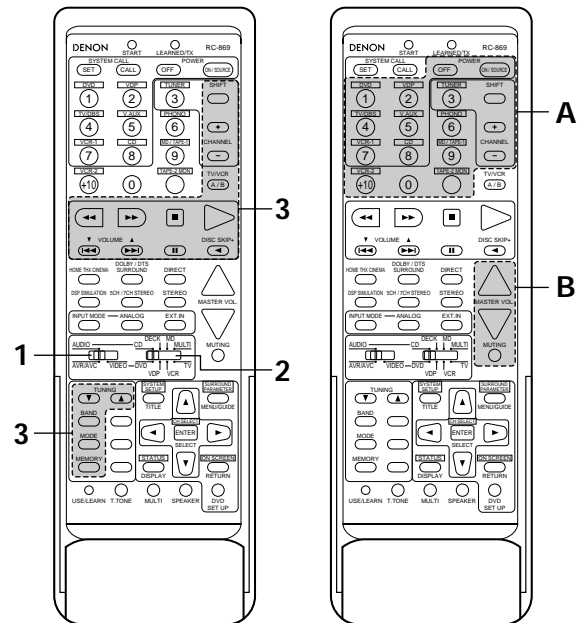
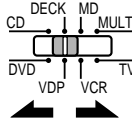

3 Operate the audio component.
 • For details, refer to the component's operating instructions.
 ※ While this remote control is compatible with a wide range of infrared controlled components, some models of components may not be operated with this remote control.

1. CD player (CD) and MD recorder (MD) system buttons

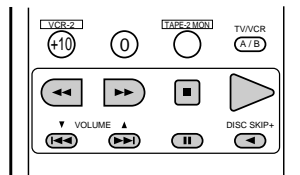

- ◀▶▶▶ : Manual search (forward and reverse)
- : Stop
- ▶ : Play
- ◀◀◀▶ : Auto search (cue)
- ⏸ : Pause
- DISC : Switch discs
- SKIP+ : (for CD changers only)

2. Tape deck (DECK) system buttons

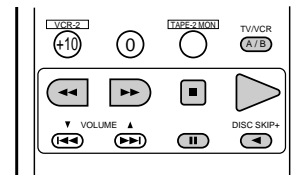

- ◀◀ : Rewind
- ▶▶ : Fast-forward
- : Stop
- ▶ : Forward play
- ⏸ : Pause
- ◀ : Reverse play
- A/B : Switch between decks A and B

3. Tuner system buttons

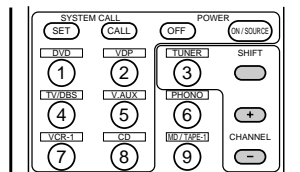

- SHIFT : Switch preset channel range
- CHANNEL : Preset channel
- +, - : up/down

※ For the tuner only, the following buttons can also be operated:

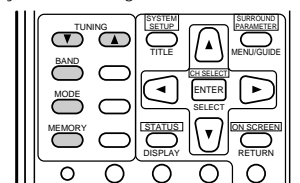

- TUNING : Frequency up/down
- ▲, ▼ : up/down
- BAND : Switch between the AM and FM bands
- MODE : Switch between auto and mono
- MEMORY : Preset memory

Preset memory

- Denon and other makes of components can be operated by setting the preset memory for your make of video component. **Operation is not possible for some models, however. In this case use the learning function (see page 36) to store the remote control signals.**
- For instructions on clearing the presettings stored in the preset memory, see page 39.

- 1** Set the slide switch to "VIDEO".

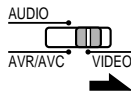

- 2** Set the slide switch to the component to be registered (DVD, VDP, VCR or TV).

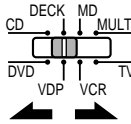

(Keep the POWER button pressed in when performing steps 3 and 4)

- 3** Holding in the POWER button, press the button for the corresponding manufacturer in block A. (Refer to Table 1.)

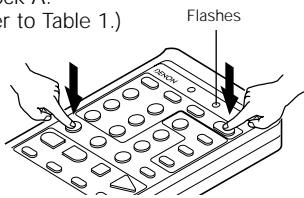

The LEARNED/TX LED flashes.

- 4** Next, while holding the POWER button, press the button for the code in block B. (Refer to Table 1.) The operation is completed when the button is released and the LEARNED/TX LED lights.

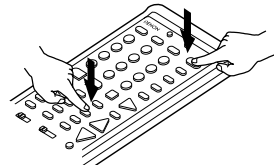

- 5** To continue registering other components, repeat steps 2 to 4.

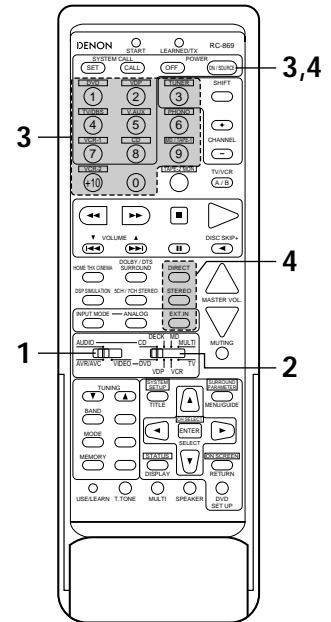

- This remote control unit can be used to operate components of other manufacturers without using the learning function by registering the manufacturer of the component as shown on Table 1.

Table 1: Combinations of Personal System Codes for Different Manufacturers

"DVD"







A \ B	DIRECT (DIRECT)	STEREO (STEREO)	EXT.IN (EXT. IN)
① (DVD)	DENON A	DENON B	—
② (VDP)	—	—	—
③ (TUNER)	—	—	—
④ (TV/DBS)	PANASONIC	—	—
⑤ (V. AUX)	—	—	—
⑥ (PHONO)	SONY	—	—
⑦ (VCR-1)	PIONEER	—	—
⑧ (CD)	TOSHIBA	—	—
⑨ (MD/TAPE-1)	—	—	—
⑩ (VCR-2)	—	—	—
⑩ (VCR-2)	—	—	—
⑩ (VCR-2)	—	—	—
⑩ (VCR-2)	—	—	—
⑩ (VCR-2)	—	—	—
SHIFT (SHIFT)	—	—	—
CHANNEL + (CHANNEL +)	—	—	—
CHANNEL - (CHANNEL -)	—	—	—
A/B (A/B)	—	—	—

"VDP"







A \ B	DIRECT (DIRECT)	STEREO (STEREO)	EXT.IN (EXT. IN)
① (DVD)	DENON A	DENON B	DENON C
② (VDP)	—	—	—
③ (TUNER)	MITSUBISHI	—	—
④ (TV/DBS)	PANASONIC	—	—
⑤ (V. AUX)	—	—	—
⑥ (PHONO)	SONY A	SONY B	SONY C
⑦ (VCR-1)	PIONEER	—	—
⑧ (CD)	—	—	—
⑨ (MD/TAPE-1)	—	—	—
⑩ (VCR-2)	—	—	—
⑩ (VCR-2)	—	—	—
⑩ (VCR-2)	—	—	—
⑩ (VCR-2)	—	—	—
⑩ (VCR-2)	—	—	—
SHIFT (SHIFT)	PHILIPS	—	—
CHANNEL + (CHANNEL +)	RCA	—	—
CHANNEL - (CHANNEL -)	—	—	—
A/B (A/B)	MAGNAVOX	—	—

※ Preset codes set upon shipment from the factory

"VCR"

A \ B	 (DIRECT)	 (STEREO)	 (EXT. IN)
① (DVD)	—	—	—
② (VDP)	HITACHI A	HITACHI B	—
③ (TUNER)	mitsubishi A	mitsubishi B	mitsubishi C
④ (TV/DBS)	PANASONIC A	PANASONIC B	PANASONIC C
⑤ (V. AUX)	JVC (VICTOR) A	JVC (VICTOR) B	JVC (VICTOR) C
⑥ (PHONO)	SONY A	SONY B	SONY C
⑦ (VCR-1)	PIONEER	—	—
⑧ (CD)	TOSHIBA A	TOSHIBA B	—
⑨ (MD/TAPE-1)	SANYO A	SANYO B	—
⑩ (VCR-2)	SHARP A	SHARP B	—
⑪	NEC A	NEC B	NEC C
 (SHIFT)	PHILIPS A	PHILIPS B	PHILIPS C
 (CHANNEL +)	RCA A	RCA B	—
 (CHANNEL -)	GENERAL ELECTRIC A	GENERAL ELECTRIC B	—
 (A/B)	—	—	—

"TV"

A \ B	 (DIRECT)	 (STEREO)	 (EXT. IN)
① (DVD)	—	—	—
② (VDP)	DENON/HITACHI	—	—
③ (TUNER)	mitsubishi A	mitsubishi B	—
④ (TV/DBS)	PANASONIC A	PANASONIC B	—
⑤ (V. AUX)	JVC (VICTOR)	—	—
⑥ (PHONO)	SONY	—	—
⑦ (VCR-1)	PIONEER	—	—
⑧ (CD)	TOSHIBA	—	—
⑨ (MD/TAPE-1)	SANYO	—	—
⑩ (VCR-2)	SHARP	—	—
⑪	NEC	—	—
 (SHIFT)	PHILIPS	—	—
 (CHANNEL +)	RCA	—	—
 (CHANNEL -)	GENERAL ELECTRIC A	GENERAL ELECTRIC B	—
 (A/B)	MAGNAVOX	—	—

※  Preset codes set upon shipment from the factory

NOTES:

- The signals for the pressed buttons are emitted while setting the preset memory. To avoid accidental operation, cover the remote control unit's transmitting window while setting the preset memory.
- Some models and years of manufacture of components of the manufacturers listed on Table 1 cannot be used.
- The signals stored at "learned" buttons have priority over the preset codes. If you wish to clear the "learned" signals, do so as described on page 39.
- Some manufacturers use different types of remote control codes for their products. If the component does not operate when set to remote codeset A, try setting to the B or C codesets.

Operating a video component stored in the preset memory

- 1** Set the slide switch to "VIDEO".

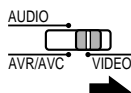

- 2** Set the slide switch to the component to be registered (DVD, VDP, VCR or TV).

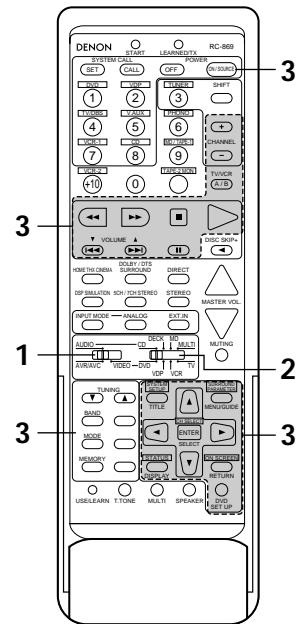
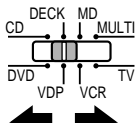

- 3** Operate the video component.
 • For details, refer to the component's operating instructions.
 ※ Some models cannot be operated with this remote control unit.

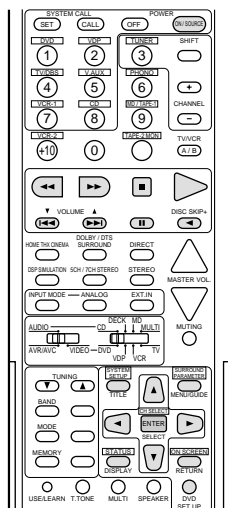

1. Digital video disc player (DVD) system buttons

- | | | | |
|-------------|---------------------------------------|------------|---------------------|
| POWER | : Turns power on and off | MENU | : Call out menu |
| ◀▶▶▶ | : Manual search (forward and reverse) | DISPLAY | : Switch display |
| ■ | : Stop | DVD SET UP | : DVD setup |
| ▶ | : Play | RETURN | : Menu return |
| ◀▶▶▶ | : Auto search (cue) | ▲, ▼ | : Cursor up/down |
| ⏸ | : Pause | ◀, ▶ | : Cursor left/right |
| TITLE | : Call out title | SELECT | : Enter setting |
| DISC SKIP + | : Disk skip (DVD changer only) | | |

NOTE:
 Some manufacturers use different names for the DVD remote control buttons, so also refer to the instructions on remote control for that component.

2. Video disc player (VDP) system buttons

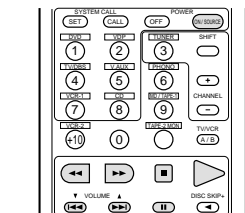

- POWER : Power on/off
 ◀▶▶▶ : Manual search (forward and reverse)
 ■ : Stop
 ▶ : Play
 ◀▶▶▶ : Auto search (cue)
 ⏸ : Pause

3. Video deck (VCR) system buttons

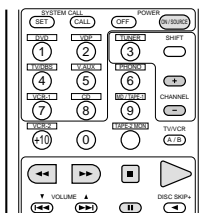

- POWER : Power on/off
 ◀▶▶▶ : Manual search (forward and reverse)
 ■ : Stop
 ▶ : Play
 ⏸ : Pause
 CHANNEL : Switch channel
 +, -

4. Monitor TV system buttons

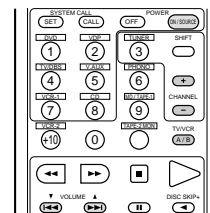

- POWER : Power on/off
 VOLUME : Volume
 ▲, ▼ : up/down
 TV/VCR : Switch between TV and VCR
 CHANNEL : Switch channel
 +, -

Learning function

- If your AV component is not a DENON product or it cannot be operated with the preset memory codesets, you can "teach" the AVR-4800's remote control to "learn" the codes from the component's original remote control.
- The buttons that can be "learned" are the CD, DECK and MD system buttons (see page 32) and the DVD, VDP, VCR and TV/DBS system buttons (see page 35). (For the CD, MD, DVD, VDP and TV/DBS, the A block buttons can also be "learned", and for the DVD and TV/DBS, the B block buttons can also be "learned".)

- 1** Press the USE/LEARN selector button with the tip of a pen etc., to set the learn mode. Both the START and LEARNED/TX indicators flash.

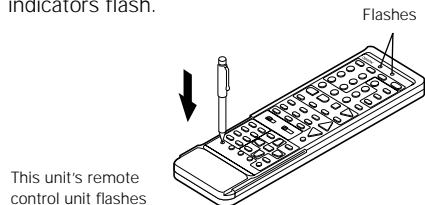

- 2** Set the program switch to the side to be "learned". Set to the AUDIO side for the CD, tape deck or DAT position, to the VIDEO side for the VDP, VCR or TV position.

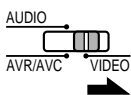

- 3** Set the program switch to the position to be "learned".

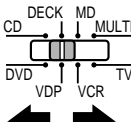

- 4** Set the remote control units so they are facing each other, then press the button to be "learned" on this unit's remote control unit.

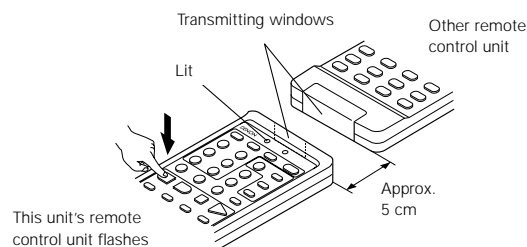

The indicator stops flashing and the START LED lights. The learnable buttons are the buttons which can be operated with the DENON system codes for the CD player, DAT and tape deck, the buttons which can be operated with the preset memory for the VCR, VDP and TV. For the TV only, however, the buttons in the section indicated "A" on the diagram above can also be "learned". Use these to "learn" TV channels.

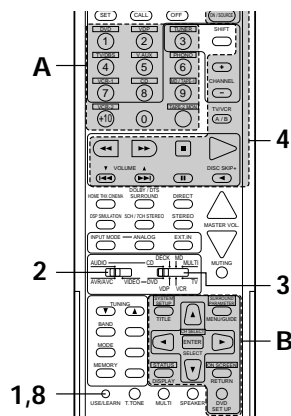

- 5** Check that the START LED is lit, then press the button to be "learned" on the other remote control unit.

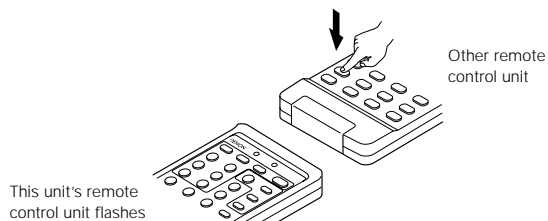

- 6** Once the START LED turns off and the LEARNED/TX LED lights, release the button on the other remote control unit.

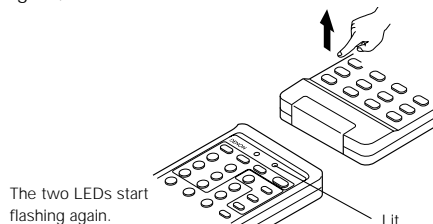

- 7** To "learn" other buttons, repeat steps 2 to 6.

- 8** Once the learning operation is completed, press the USE/LEARN selector button again. The two LEDs stop flashing and the learning mode is cancelled.

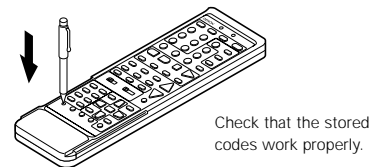

NOTES:

- Up to 26 codes can be "learned", but this number may be lower if the codes are long.
- If a non-learnable button is pressed or two or more buttons are pressed at once, the two LEDs will once again light when the button(s) is released.
- If the codes could not be stored, the LEARNED/TX LED does not light after the START LED turns off. For limited number of models, codes cannot be stored in RC-869.
- If the two LEDs start flashing rapidly after the START LED lights, this means that the memory is already full, and the code you have just attempted to store was not stored. To "learn" that code, first perform the resetting operation. (See page 39.)

System call function

- The included remote control unit is equipped with a system call function for transmitting multiple remote control signals when a single button is pressed (this is often referred to as a "macro" function). This function can be used to turn on the amplifier's power, select the input source, turn on the monitor TV's power, turn on a source component's power and start playback, etc., all at the touch of a button.

(1) System call buttons

The buttons that can be used for the system call function are shown on the table below.

A series of up to 10 operations can be performed with the POWER ON and OFF buttons, and a series of up to 5 operations can be performed with other buttons.

System call signals are already preset at the buttons indicated in the shaded section. System call signals can also be stored at any button on the remote control unit, including the buttons in this section. (See page 38.)

Button	No. transmissions	Stored operation 1	Stored operation 2	Stored operation 3	Stored operation 4	Stored operation 5	Stored operation 6	Stored operation 7	Stored operation 8	Stored operation 9	Stored operation 10
POWER OFF (key 3)	10										
POWER ON (key 4)	10										
DVD (key 5)	5	Receiver power on	DVD player (DVD) power on	Receiver input source switched to DVD	TV power on	DVD player (DVD) playback					
VDP (key 6)	5	Receiver power on	LD player (VDP) power on	Receiver input source switched to VDP	TV power on	LD player (VDP) playback					
TV/DBS (key 9)	5	Receiver power on	TV power on	Receiver input source switched to TV/DBS							
V.AUX (key 10)	5	Receiver power on	TV power on	Receiver input source switched to V.AUX							
VCR-1 (key 13)	5	Receiver power on	Video (VCR) power on	Receiver input source switched to VCR-1	TV power on	Video (VCR) playback					
CD (key 14)	5	Receiver power on	Receiver input source switched to CD								

The system call signals for the POWER OFF and POWER ON buttons are transmitted from the remote control unit approximately once every second. The signals for the other buttons (DVD, VDP, TV/DBS, V.AUX, VCR-1 and CD) are transmitted approximately once every 1.5 seconds.

(2) Using the system call function

- Press the system call button.
 - The LEARNED/TX LED flashes for 5 seconds.



- Press the button at which the desired system call signals are stored while the LEARNED/TX LED is flashing.
 - The preset signals or the signals you have stored at that button are transmitted in succession.

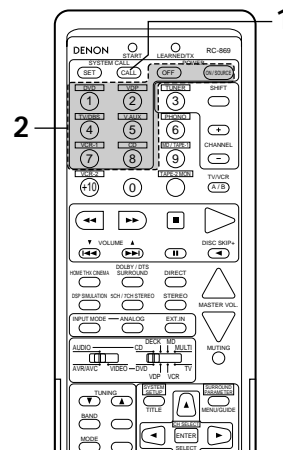

(3) Storing signals

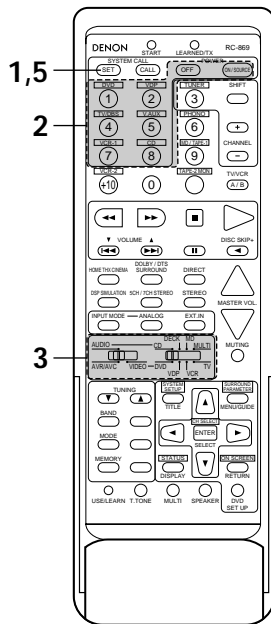

- 1 Press the SET button.
 - The START LED and LEARNED/TX LED both flash.

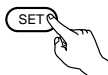

- 2 Press the button at which you want to store the system call signals.
 - The START LED flashes.

- 3 Set the mode switch to the position for the component whose remote control signals you want to store.



- 4 Press the buttons whose remote control signals you want to store one by one.

- 5 Press the SET button.



(4) Clearing system call settings

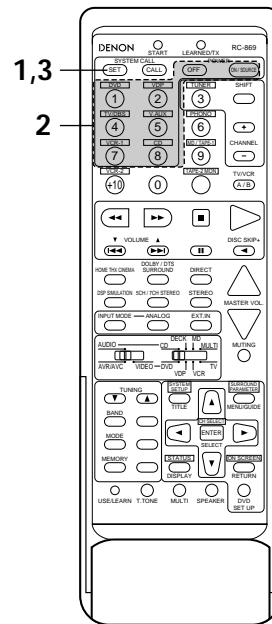

- 1 Press the SET button.

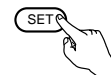

- 2 Press the button whose settings you want to clear.

- 3 Press the SET button.
 - The button is reset to the settings shown on the table on page 37.

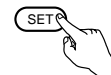

NOTES:

- The remote control signals for the buttons pressed while storing the system call signals are transmitted when the buttons are pressed, so cover the remote sensor or take other measures so that the components do not operate while the signals are being stored.
- The LEARNED/TX LED does not light if system call signals cannot be stored at the button that you have pressed or if you have already stored the maximum number of signals.

Clearing "learned" remote control signals

- 1 Press the USE/LEARN selector button with the tip of a pen, etc., to set the learn mode.

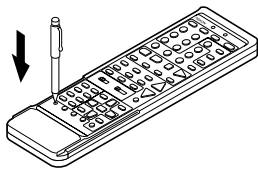

- 2 To clear "learned" remote control signals, set the slide switch to the position at which the signals were "learned".

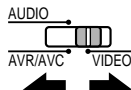

- 3 Set the slide switch to the position at which the signals were "learned".

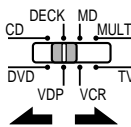

9 OPERATION

Before operating

- 1 Refer to "CONNECTIONS" (pages 6 to 15) and check that all connections are correct.

- 2 Set the remote control unit's slide switch to the AUDIO position. (only when operating with the remote control unit)

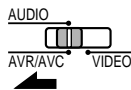

- 3 Turn on the power. Press the POWER operation switch (button).

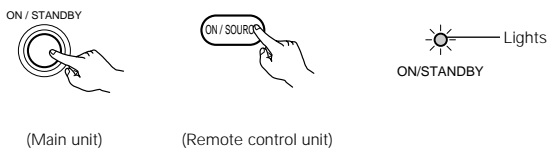

- When pressed, the power turns on and the display lights. The sound is muted for several seconds, after which the unit operates normally.
- When pressed again, the power turns off, the standby mode is set and the display turns off.
- Whenever the ON/STANDBY button is in the STANDBY state, the apparatus is still connected to the AC line voltage. Please be sure to unplug the cord when you leave home for, say, a vacation.

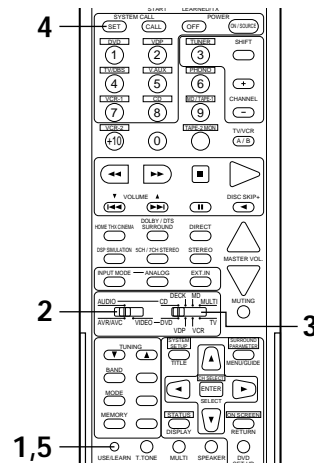

- 4 Press the SYSTEM CALL SET button, and hold it in for at least four seconds.

- When both the START and LEARNED/TX LEDs light simultaneously, all the stored codes are cleared.

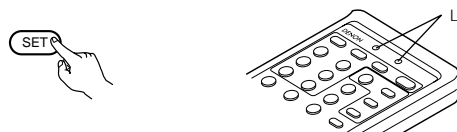

- 5 Press the USE/LEARN selector button.

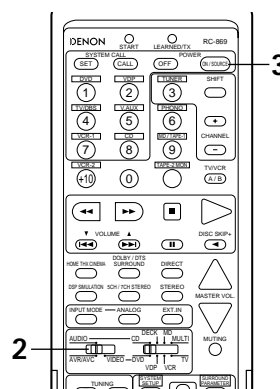
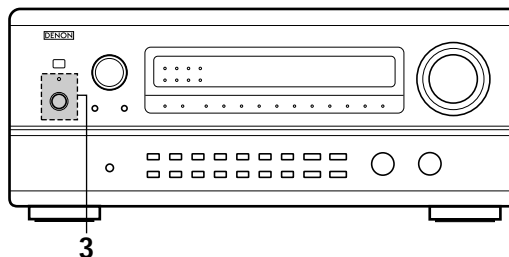

Playing the input source

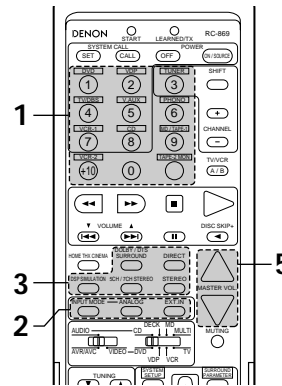
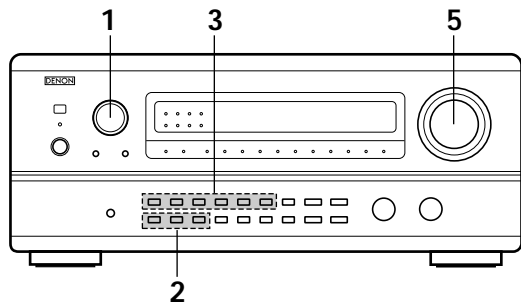

- 1** Select the input source to be played.
Example: CD

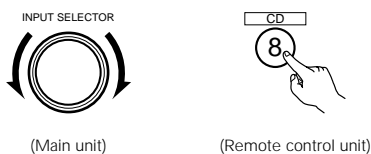

※ When the tape 2 input (TAPE-2 MON) is selected, the input indicator lights.

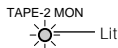

- 2** Select the input mode.
 • Selecting the analog mode
 Press the ANALOG button to switch to the analog input.

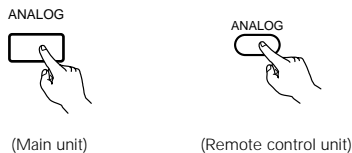

- Selecting the external input (6CH/8CH EXT. IN) mode
 Press the 6CH/8CH EXT. IN (on the EXT. IN button) on the remote control unit) to switch the external input.

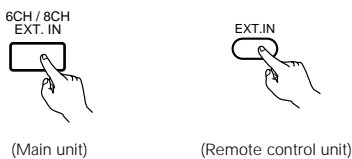

- Selecting the AUTO, PCM and DTS modes
 The mode switches as shown below each time the INPUT MODE button is pressed.

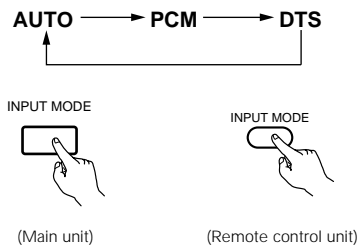

Input mode selection function

Different input modes can be selected for the different input sources. The selected input modes for the separate input sources are stored in the memory.

- ① AUTO (All auto mode)

In this mode, the types of signals being input to the digital and analog input jacks for the selected input source are detected and the program in the AVR-4800's surround decoder is selected automatically upon playback. This mode can be selected for all input sources other than PHONO, TAPE-2 and TUNER.

The presence or absence of digital signals is detected, the signals input to the digital input jacks are identified and decoding and playback are performed automatically in DTS, Dolby Digital or PCM (2 channel stereo) format. If no digital signal is being input, the analog input jacks are selected.

Use this mode to play Dolby Digital signals.

- ② PCM (exclusive PCM signal playback mode)

Decoding and playback are only performed when PCM signals are being input.

Note that noise may be generated when using this mode to play signals other than PCM signals.

- ③ DTS (exclusive DTS signal playback mode)

Decoding and playback are only performed when DTS signals are being input.

- ④ ANALOG (exclusive analog audio signal playback mode)

The signals input to the analog input jacks are decoded and played.

- ⑤ 6CH/8CH EXT. IN (external decoder input jack selection mode)

The signals being input to the external decoder input jacks are played without passing through the surround circuitry.

NOTE:

- Note that noise will be output when CDs or LDs recorded in DTS format are played in the "PCM" or "ANALOG" mode. Select the "DTS" mode when playing signals recorded in DTS from a laser disc player or CD player.

Note on playing a source encoded with DTS

- Noise may be generated at the beginning of playback and while searching during DTS playback in the AUTO mode. If so, play in the DTS mode.

3 Select the play mode.

Example: Stereo



4 Start playback on the selected component.
 • For operating instructions, refer to the component's manual.

5 Adjust the volume.

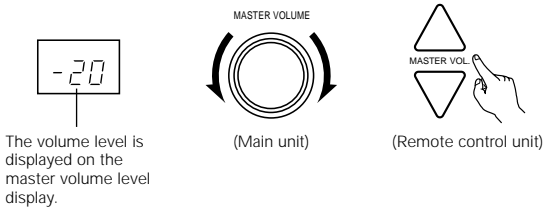

※ The volume can be adjusted within the range of -60 to 0 to 18 dB, in steps of 1 dB. However, when the channel level is set as described on page 25 or pages 46 and 47, if the volume for any channel is set at +1 dB or greater, the volume cannot be adjusted up to 18 dB. (In this case the maximum volume adjustment range is "18 dB — (Maximum value of channel level)".)

Input mode when playing DTS sources

• Noise will be output if DTS-compatible CDs or LDs are played in the "ANALOG" or "PCM" mode.
 When playing DTS-compatible sources, be sure to connect the source component to the digital input jacks (OPTICAL/COAXIAL) and set the input mode to "AUTO" or "DTS".

NOTE:

• The digital input indicator will light (green) when playing CD-ROMs containing data other than audio signals, but no sound will be heard.

Input mode display

• In the AUTO mode



• In the PCM mode

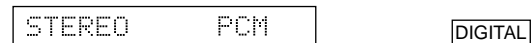

• In the DTS mode

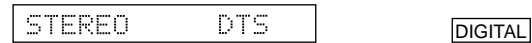

• In the ANALOG mode



One of these lights, depending on the input signal.

Input signal display

• DOLBY DIGITAL

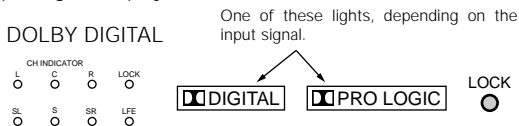

• DTS



• PCM

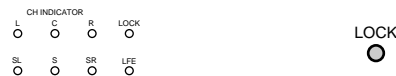

※ The LOCK LED lights when digital signals are being input properly. If the LED does not light, check whether the digital input component setup (page 28) and connections are correct and whether the component's power is turned on.

After starting playback

[1] Adjusting the sound quality (tone)

The tone control function will not work in the Direct or Home THX Cinema mode.

1 Adjust the bass sound to the desired level using the BASS adjustment control, the treble sound using the TREBLE adjustment control.

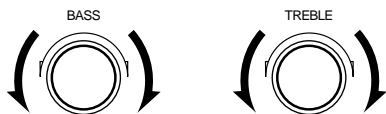

- To increase the bass or treble: Turn the control clockwise. (The bass or treble sound can be increased to up to +12 dB in steps of 2 dB.)
- To decrease the bass or treble: Turn the control counter clockwise. (The bass or treble sound can be decreased to up to -12 dB in steps of 2 dB.)

2 If you do not want the bass and treble to be adjusted, turn on the tone defeat mode.

※ The signals do not pass through the bass and treble adjustment circuits, providing higher quality sound.



[2] Listening over headphones

Plug the headphones' plug into the jack.
 ※ Connect the headphones to the PHONES jack.
 The pre-out output (including the speaker output) is automatically turned off when headphones are connected.

NOTE:

To prevent hearing loss, do not raise the volume level excessively when using headphones.

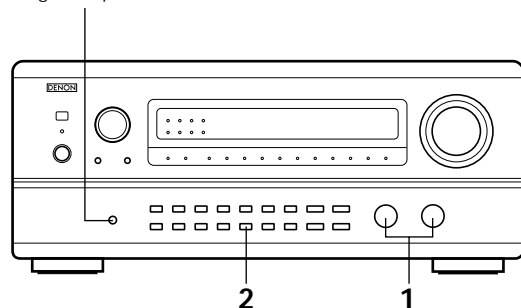

[3] Turning the sound off temporarily (muting)

- 1 Use this to turn off the audio output temporarily. Press the MUTING button.
 ※ Cancelling MUTING mode. Press the MUTING button again.

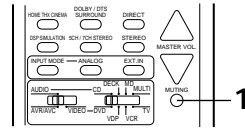

[4] Combining the currently playing sound with the desired image

- 1 Simulcast playback
 Use this switch to monitor a video source other than the audio source. Press the VIDEO SELECT button repeatedly until the desired source appears on the display.
 ※ Cancelling simulcast playback.
 - Select "SOURCE" using the video select button.
 - Switch the program source to the component connected to the video input.

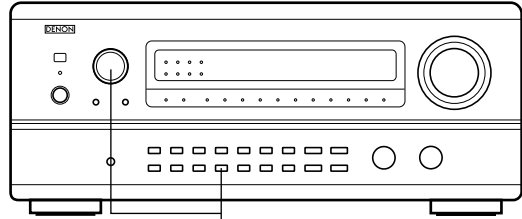

[5] Checking the currently playing program source, etc.

- 1 On screen display
 - Each time an operation is performed, a description of that operation appears on the display connected to the unit's VIDEO MONITOR OUT jack. Also, the unit's operating status can be checked during playback by pressing the remote control unit's ON SCREEN button. Such information as the position of the input selector and the surround parameter settings is output in sequence.

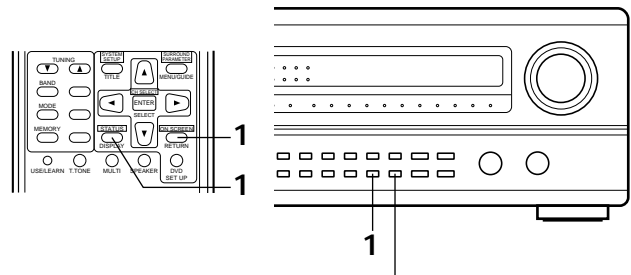
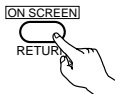

Front panel display

- Descriptions of the unit's operations are also displayed on the front panel display. In addition, the display can be switched to check the unit's operating status while playing a source by pressing the STATUS button.

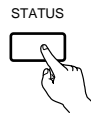

(Main unit)

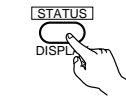

(Remote control unit)

Using the dimmer function

- Use this to change the brightness of the display. The display brightness changes in four steps (bright, medium, dim and off) by pressing the remote control unit's DIMMER button repeatedly.
 ※ The brightness changes in 3 steps each time the button is pressed, and finally the display turns off.

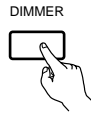

[6] Switching the surround speakers

- 1 The surround speakers switch as shown below each time the SPEAKER button is pressed.

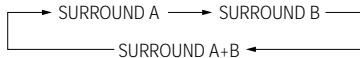

- ※ This operation is possible when the setting for using both surround speakers A and B is made at "Speaker Configuration" in the System Setup Menu.

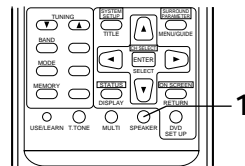

Multi-source recording/playback

[1] Playing one source while recording another (REC OUT mode)

1 Press the REC/MULTI MODE button until "REC OUT SOURCE" appears on the set's display.

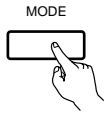

2 Press the REC/MULTI SOURCE button until the source you want to record appears on the set's display.
 • The indicator for the selected program source lights.

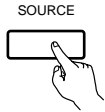

3 Set the recording mode.
 • For operating instructions, refer to the manual of the component on which you want to record.

4 To cancel, press the REC/MULTI MODE button or press the REC/MULTI SOURCE button until "SOURCE" appears on the display.

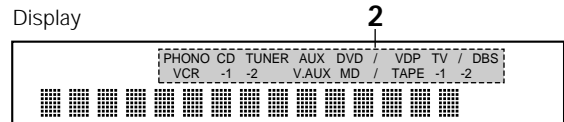
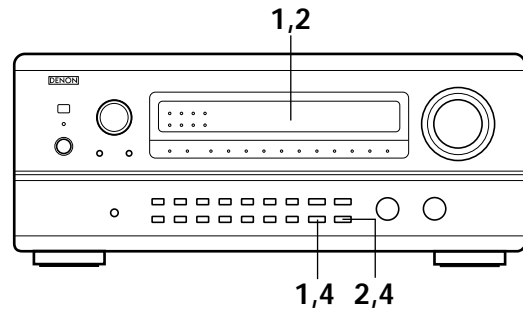
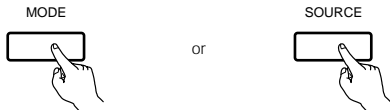

NOTES:

- Recording sources other than digital inputs selected in the REC OUT mode are also output to the multi source audio/video output jacks.
- Digital signals are not output from the MULTI SOURCE or audio/video output jacks.
- Only the currently playing source can be recorded to TAPE-2.

[2] Outputting a program source to an amplifier, etc., in a different room (MULTI mode)

1 Press the REC/MULTI MODE button until "M-SOURCE SOURCE" appears on the set's display.

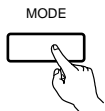

2 Press the REC/MULTI SOURCE button until the source you want to output appears on the set's display.
 • The "MULTI" indicator lights.
 • The indicator for the selected program source lights.
 • When the AVR-4800 is in the REC OUT mode, the source cannot be output using the MULTI button on the remote control unit.

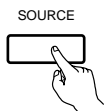

(Main unit)



(Remote control unit)

3 Start playing the source to be output.
 • For operating instructions, refer to the manuals of the respective components.

4 To cancel, either press the REC/MULTI MODE button or press the REC/MULTI SOURCE button until "SOURCE" appears on the display.

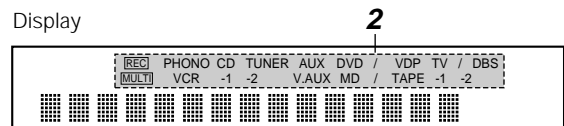
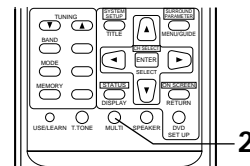
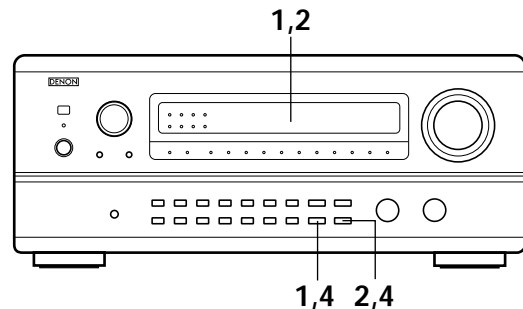
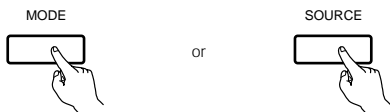

NOTES:

- The signals of the source selected in the MULTI mode are also output from the MD/TAPE-1 and VCR recording output terminals.
- Digital signals are not output from the multi source audio output jacks.

[3] Remote control unit operations during multi-source playback (selecting the source)

1 Set the slide switch to "AUDIO" and "MULTI".



(Remote control unit)

2 Press the input source button. **Example: CD**
The multi source switches directly.

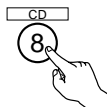

(Remote control unit)

The remote control unit's MULTI button can be operated at positions other than "MULTI".
The multi source switches in order each time the multi button is pressed.



(Remote control unit)

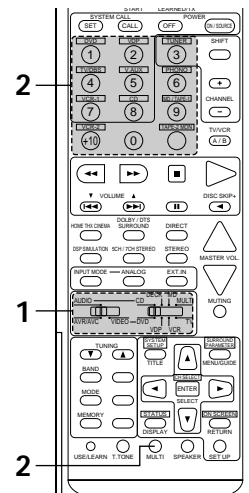

Playback using the external input (EXT. IN) jacks

1 Set the external input (6CH/8CH EXT. IN) mode. Press the 6CH/8CH EXT. IN (on the EXT. IN button on the remote control unit) to switch the external input.

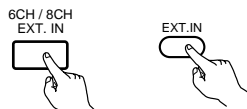

(Main unit) (Remote control unit)

Once this is selected, the input signals connected to the FL (front left), FR (front right), C (center), SL (surround left) and SR (surround right) channels of the EXT. IN jacks are output directly to the front (left and right), center and surround (left and right) speaker systems as well as the pre-out jacks without passing through the surround circuitry. In addition, the signal input to the SW (subwoofer) jack is output to the PRE OUT SUBWOOFER jack.

When 6CH/8CH EXT. IN is selected, the input signals connected to the EL (effect left) and ER (effect right) jacks are output to the PRE OUT EFFECT/SB (left and right) jacks.

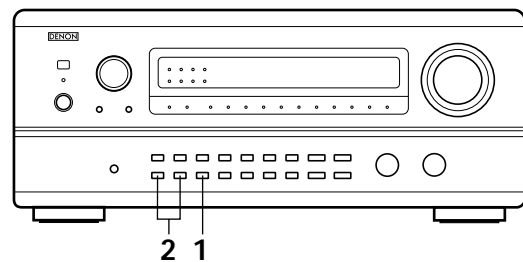

2 Canceling the external input mode
To cancel the external input (6CH/8CH EXT. IN) setting, press the INPUT MODE or ANALOG button to switch to the desired input mode. (See page 40.)

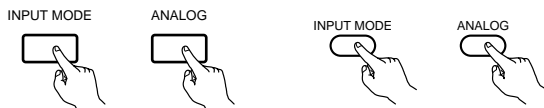

(Main unit) (Remote control unit)

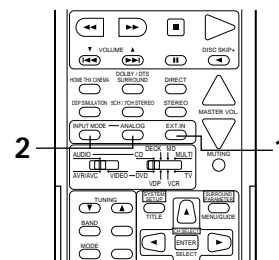

- When the input mode is set to the external input (6CH/8CH EXT. IN), the play mode (DIRECT, STEREO, DOLBY/DTS SURROUND, HOME THX CINEMA, WIDE SCREEN, 5CH/7CH STEREO or DSP SIMULATION) cannot be set.

NOTES:

- In play modes other than the external input mode, the signals connected to these jacks cannot be played. In addition, signals cannot be output from channels not connected to the input jacks.
- The external input mode can be set for any input source. To watch video while listening to sound, select the input source to which the video signal is connected, then set this mode.

Multi-source and multi-zone playback

MULTI ROOM MUSIC ENTERTAINMENT SYSTEM

- When the outputs of the MULTI SOURCE AUDIO OUT terminals are wired and connected to integrated amplifiers installed in other rooms, different sources can be played in rooms other than the main room in which this unit and the playback devices are installed. (Refer to ANOTHER ROOM on the diagram below.)
- When a sold separately room-to-room remote control unit (DENON RC-616, 617 or 618) is wired and connected between the main room and another room, the remote-controllable devices in the main room can be controlled from another room using the remote control unit.
- ※ To control playback devices other than the ones above, either use that device's remote control unit or preset a separately sold programmable remote control unit.

NOTES:

- For the AUDIO output, use high quality pin-plug cords and wire in such a way that there is no humming or noise.
- For instructions on installation and operation of separately sold devices, refer to the devices' operating instructions.

MULTI ROOM MUSIC ENTERTAINMENT SYSTEM

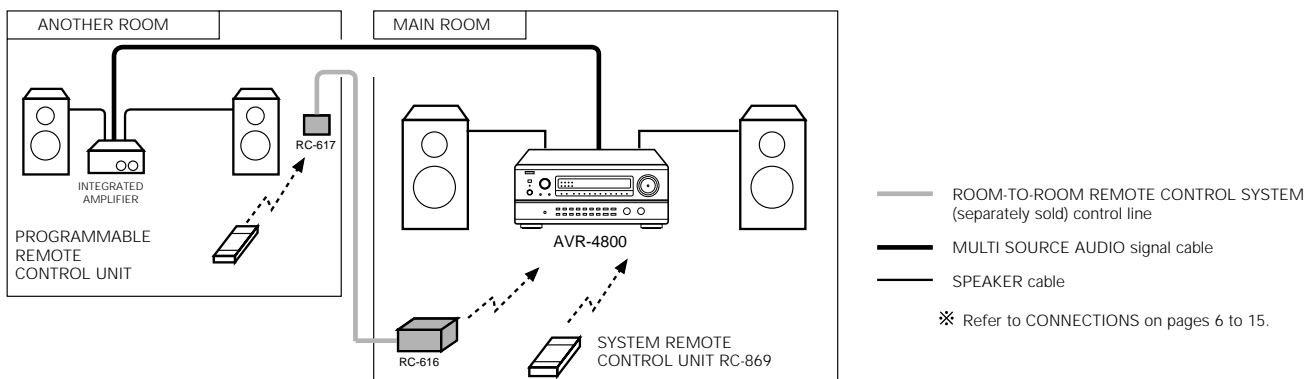

Room to Room Remote Control jacks

- When the OUT jack is connected, the signals input to the IN jack are output from the OUT jack directly. (Example: RC616 signals are output.)
- Do not connect only the OUT jack.
(The signals from the AVR-4800's remote sensor are not output to this jack.)

10 SURROUND

Before playing with the surround function

- Before playing with the surround function, be sure to use the test tones to adjust the playback level from the different speakers. This adjustment can be performed with the system setup (see page 25) or from the remote control unit, as described below.
- Adjusting with the remote control unit using the test tones is only possible in the "Auto" mode and only effective in the DOLBY SURROUND and HOME THX CINEMA modes. The adjusted levels for the different modes are automatically stored in the memory.

1 Press the T. tone button.

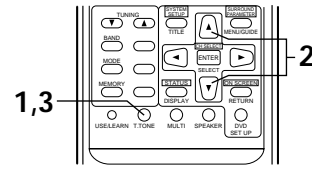

2 Test tones are output from the different speakers. Use the channel volume adjust buttons to adjust so that the volume of the test tones is the same for all the speakers.

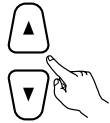

3 After completing the adjustment, press the T. tone button again.



- After adjusting using the test tones, adjust the channel levels either according to the playback sources or to suit your tastes, as described below.

1 Select the speaker whose level you want to adjust.



The channel switches as shown below each time the button is pressed.

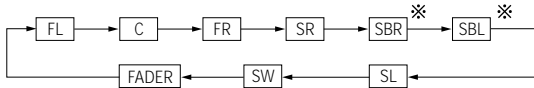

2 Adjust the level of the selected speaker.

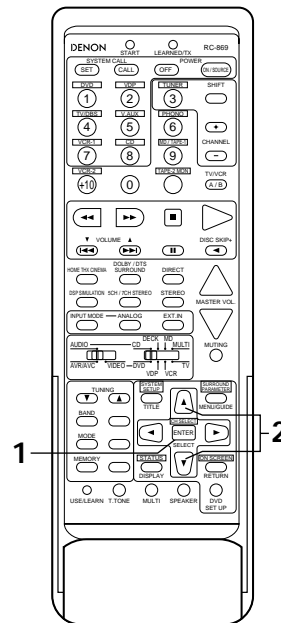
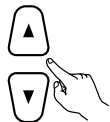

* Select SBR or SBL when "Large" or "Small" is set for "Speaker Configuration".
 When the surround back speaker setting is set to "1spkr" for "Speaker Configuration", this is set to "SB".
 In the 8ch EXT IN mode, "SBR" is set to "ER", "SBL" to "EL".

Fader function



- This function makes it possible to lower the volume of the front channels (FL, C and FR) or the rear channels (SL, SR, SBL and SBR) together. Use it for example to adjust the balance of the sound from the different positions when playing multi-channel music sources.

1 Select "FADER".

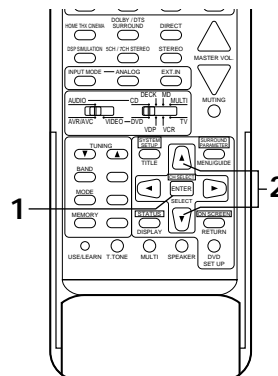
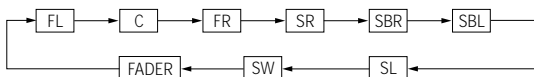

The channel switches in the order shown below each time this button is pressed.



2 Press the  button to reduce the volume of the surround channels, the  button to reduce the volume of the front channels.

- ※ The fader function does not affect the SW, EL and ER channels.

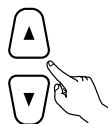

- ※ The channel whose channel level is adjusted lowest can be faded to -12 dB using the fader function.
- ※ If the channel levels are adjusted separately after adjusting the fader, the fader adjustment values are cleared, so adjust the fader again.

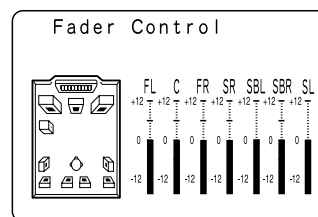

This is only displayed when setting the fader control.

Playing modes for different sources

The AVR-4800 is equipped with many surround modes. We recommend using the surround modes as described below in order to achieve the maximum effect for the specific signal source.

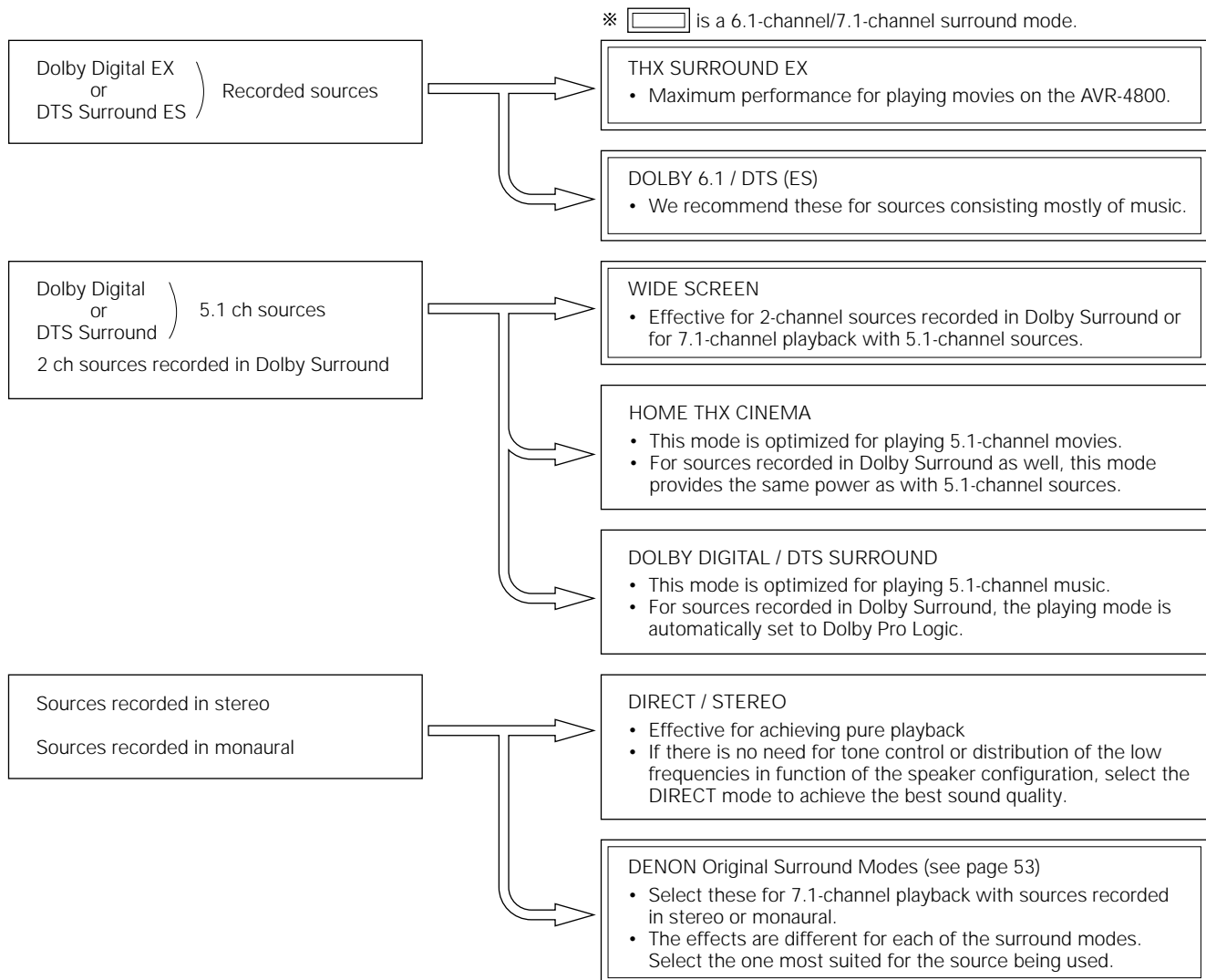

- Though we recommend selecting the surround mode as described above, other surround modes can also be selected.

THX Surround EX / Home THX Cinema mode

When the HOME THX CINEMA button is pressed, the surround back speaker setting on the "Speaker Configuration" screen switches as follows:

To use the surround back speakers

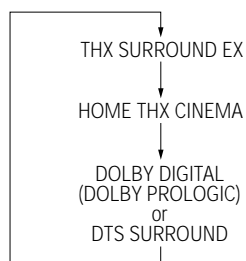

To not use the surround back speakers

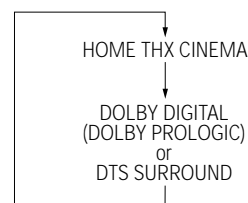

[1] Playing sources recorded in Dolby Pro Logic in the Home THX Cinema surround mode

- 1 Select the Home THX Cinema mode.

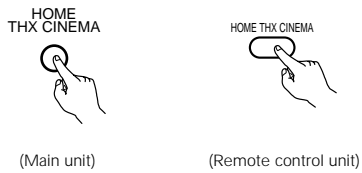

- 2 Play a program source with the **DOLBY SURROUND** mark.
- For operating instructions, refer to the manuals of the respective components.

NOTE:

For Dolby Pro Logic sources, no sound is produced from the surround back speakers even if the THX Surround EX mode is selected. The Surround Back LED lights red.

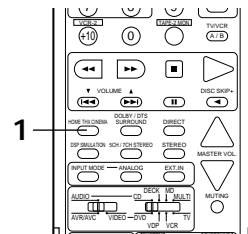
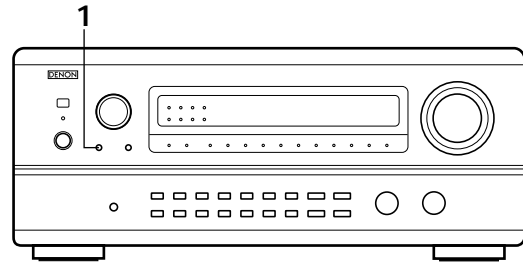

[2] To play in the THX Surround EX/Home THX Cinema Surround mode for sources recorded in Dolby Digital or DTS

- 1 Select the program source.
- Selecting a digital input source
- Perform step 1 under "Dolby Digital mode and DTS Surround" (page 50).

- 2 Select the Home THX Cinema mode.

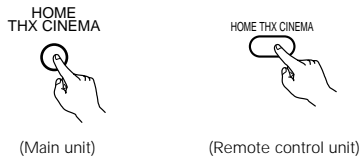

- 3 Play a program source with the **DOLBY DIGITAL** or **dts** mark.
- For operating instructions, refer to the manuals of the respective components.
- When the source is played, the input channel indicators indicating the signals included in the source light as shown on the diagram below. (The number of channels that lights depends on the input source.)

CH INDICATOR			
L	C	R	L: Front left channel
○	○	○	C: Center channel
			R: Front right channel
SL	S	SR	SL: Surround left channel
○	○	○	S: Mono surround channel
			SR: Surround right channel



The SURROUND BACK indicator lights (green) when playing THX surround mode.

- Also, the following indicator lights if the software contains Low Frequency Effect sounds:



The DTS indicator lights when playing DTS sources.

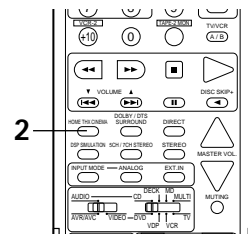
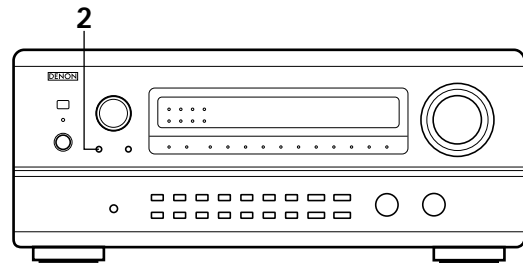

Surround parameters ①

THX Surround EX:

Switch the surround back speakers on and off.

Dolby Digital mode (only with digital input) and DTS Surround (only with digital input)

1 Select the input source.

Playback with digital input

① Select an input source set to digital (COAXIAL/OPTICAL) (see page 28).

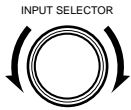

(Main unit)



(Remote control unit)

② Set the input mode to "AUTO".

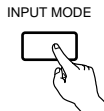

(Main unit)

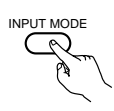

(Remote control unit)

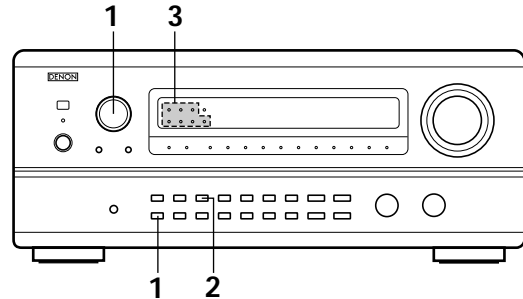

2 Select the Dolby Surround mode.



(Main unit)



(Remote control unit)

3 Play a program source with the , mark.

- The Dolby Digital indicator lights when playing Dolby Digital sources.
- For operating instructions, refer to the manuals of the respective components.
- When the source is played, the input channel indicators indicating the signals included in the source light as shown on the diagram below. (The number of channels that lights depends on the input source.)

CH INDICATOR			
L	C	R	L: Front left channel
○	○	○	C: Center channel
			R: Front right channel
SL	S	SR	SL: Surround left channel
○	○	○	S: Mono surround channel
			SR: Surround right channel

- Also, the following indicator lights if the software contains Low Frequency Effect sounds:



Lit



The DTS indicator lights when playing DTS sources.

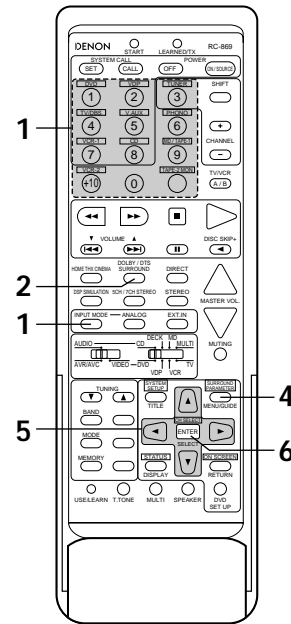

4

Display the surround parameter menu.

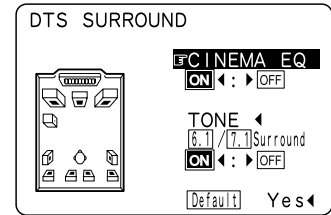
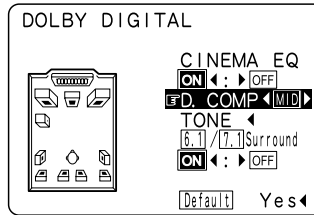
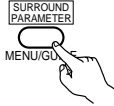

5

Select the various parameters.



6

Enter the setting.



NOTE:

- When "Default" is selected and the cursor button is pressed, "CINEMA EQ." and "D.COMP." are automatically turned off, "6.1/7.1 Surround" is reset, "CHANNEL LEVEL" and the tone is set to the default value.

Surround parameters ②

CINEMA EQ. (Cinema Equalizer):

The Cinema EQ function gently decreases the level of the extreme high frequencies, compensating for overly-bright sounding motion picture soundtracks. Select this function if the sound from the front speakers is too bright. This function only works in the Dolby Pro Logic, Dolby Digital, DTS Surround and Wide Screen modes.

D.COMP. (Dynamic Range Compression):

Motion picture soundtracks have tremendous dynamic range (the contrast between very soft and very loud sounds). For listening late at night, or whenever the maximum sound level is lower than usual, the Dynamic Range Compression allows you to hear all of the sounds in the soundtrack (but with reduced dynamic range). (This only works when playing program sources recorded in Dolby Digital or DTS.) Select one of the four parameters ("OFF", "LOW", "MID" (middle) or "HI" (high)). Set to OFF for normal listening. This parameter is displayed only when playing compatible sources in DTS mode.

6.1 / 7.1 Surround:

When set to "ON", the same digital matrix processing as with THX Surround EX is performed, and surround back signals are created from the two channels of surround signals (SL and SR) upon playback.

The surround mode switches to DOLBY 6.1 when playing Dolby Digital signals, to DTS (ES) when playing DTS signals.

NOTE: In the Pro Logic and THX modes, no sound is output from the surround back speakers, even if this is set to "ON". This operation can be performed directly using the buttons on the main unit's panel.

TONE:

This adjusts the tone control. (See "Surround parameters ③" on page 56.)

■ **Dialogue Normalization**

The dialogue normalization function is activated automatically when playing Dolby Digital program sources. Dialogue normalization is a basic function of Dolby Digital which automatically normalizes the dialog level (standard level) of the signals which are recorded at different levels for different program sources, such as DVD, DTV and other future formats that will use Dolby Digital. When this function is activated, the following message appears on the main unit's display:

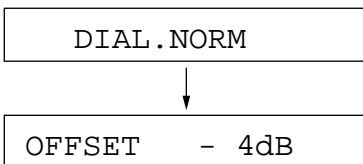

The number indicates the normalization level when the currently playing program is normalized to the standard level.

Dolby Surround Pro Logic mode

- 1** Select the Dolby Surround Pro Logic mode.
- The Dolby Pro Logic indicator lights.

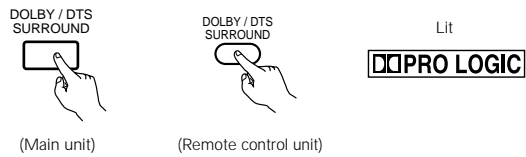

- 2** Play a program source with the  mark.
- For operating instructions, refer to the manuals of the respective components.

NOTE:

- There are four Dolby Surround Pro Logic modes (NORMAL, PHANTOM, WIDE and 3CH. LOGIC). The AVR-4800 sets the mode automatically according to the types of speakers set during the system setup process (page 20).

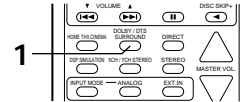
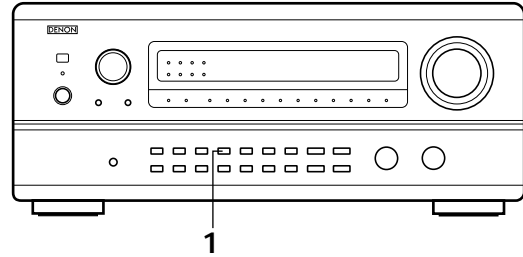

11 DENON ORIGINAL SURROUND MODES

- The AVR-4800 is equipped with a built-in high performance DSP (digital signal processor) that uses digital processing to recreate sound fields artificially. Select one of the eight provided surround modes according to the program source you want to play and adjust the parameters to achieve a more real, powerful sound field.

Surround modes and their features

1	WIDE SCREEN	Select this to achieve an atmosphere like that of a movie theater with a large screen. In this mode, all signal sources are played in the 7.1-channel mode, including Dolby Pro Logic and Dolby Digital 5.1-channel sources. Effects simulating the multi surround speakers of movie theaters are added to the surround channels.
2	SUPER STADIUM	Select this when watching baseball or soccer programs to achieve a sound as if you were actually at the stadium. This mode provides the longest reverberation signals.
3	ROCK ARENA	Use this mode to achieve the feeling of a live concert in an arena with reflected sounds coming from all directions.
4	JAZZ CLUB	This mode creates the sound field of a live house with a low ceiling and hard walls. This mode gives jazz a very vivid realism.
5	CLASSIC CONCERT	Select this for the sound of a concert hall rich in reverberations.
6	MONO MOVIE (NOTE 1)	Select this when watching monaural movies for a greater sense of expansion.
7	MATRIX	Select this to emphasize the sense of expansion for music sources recorded in stereo. Signals consisting of the difference component of the input signals (the component that provides the sense of expansion) processed for delay are output from the surround channel.
8	5CH/7CH STEREO	The front left channel signals are output to the surround and surround back signal left channels, the front right channel signals are output to the surround and surround back signal right channels, and the in-phase component of the left and right channels is output to the center channel. Use this mode to enjoy stereo sound.

- ※ Depending on the program source being played, the effect may not be very noticeable.
In this case, try other surround modes, without worrying about their names, to create a sound field suited to your tastes.

NOTE 1: When playing sources recorded in monaural, the sound will be one-sided if signals are only input to one channel (left or right), so input signals to both channels. If you have a source component with only one audio output (monophonic camcorder, etc.) obtain a "Y" adaptor cable to split the mono output to two outputs, and connect to the L and R inputs.

NOTE:

Only the DIRECT and 5CH/7CH STEREO modes can be used when playing PCM signals with a sampling frequency of 96 kHz (such as from DVD-Video discs that contain 24 bit, 96 kHz audio). If such signals are input during playback in one of the other surround modes, the mode automatically switches to DIRECT.

Personal Memory Plus

The AVR-4800 is equipped with a function called Personal Memory Plus which automatically stores the surround mode and level settings selected for the different input programs in the memory. The mode stored in the memory the last time the input program source was used is called out automatically when that program source is selected.

- ※ Items automatically stored for the different input program sources with the Personal Memory Plus function

- ① Surround mode
- ② Surround parameter
- ③ Playback level balance for the different output channels
- ④ Type and settings of surround channel speakers
- ⑤ Tone control
- ⑥ Input mode selection function

DSP surround simulation

1 Select the surround mode for the input channel.

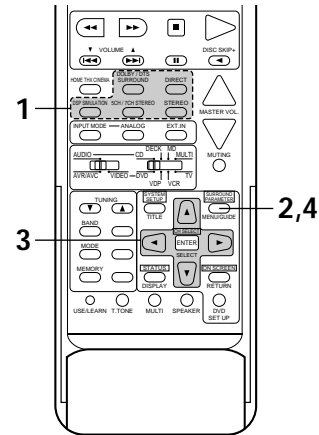
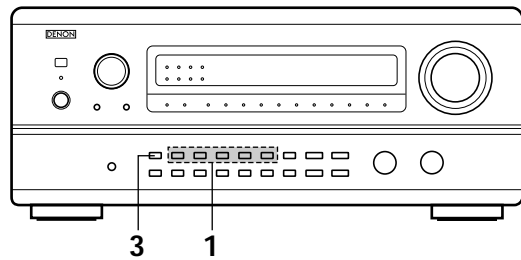
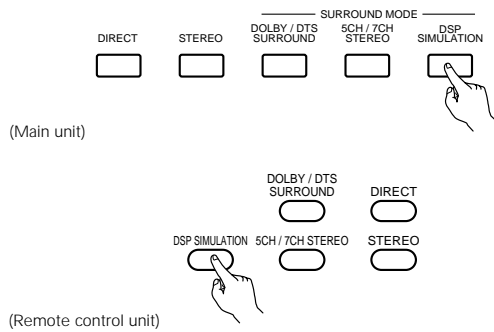

The surround mode switches in the following order each time the DSP SIMULATION button is pressed:

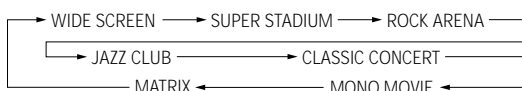

2 Display the surround parameter screen on the monitor.
 * The screen for the selected surround mode appears.

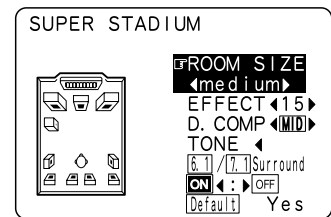
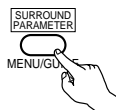

3 Set the parameters.
 * The 6.1 and 7.1 Surround parameter can be operated directly using the buttons on the main unit's panel.

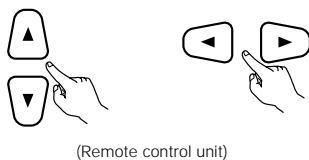

4 To end the setting mode, press the surround parameter button again.

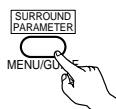

NOTES:

- When "Default" is selected and the cursor button is pressed, "CINEMA EQ." and "D.COMP." are automatically turned off, "ROOM SIZE" is set to "medium", "EFFECT LEVEL" to "10" and "DELAY TIME" to "30ms".
- The "ROOM SIZE" expresses the expansion effect for the different surround modes in terms of the size of the sound field, not the actual size of the listening room.

Tone control setting

- Use the tone control setting to adjust the bass and treble as desired.

1

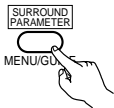

Display the surround parameter screen on the monitor.
 ※ The screen for the selected surround mode appears.
 "TONE" cannot be selected in the Direct or Home THX Cinema mode.

SUPER STADIUM

ROOM SIZE
 ◀medium▶

EFFECT ◀15▶

D. COMP ◀IMD▶

TONE ◀

6.1 / 7.1 Surround

ON ◀: ▶ OFF

Default Yes

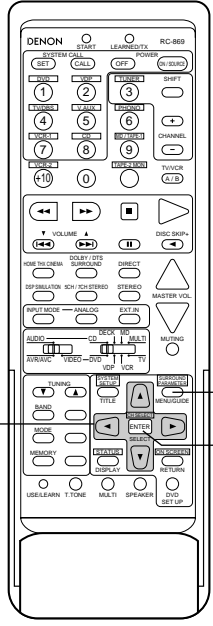

2

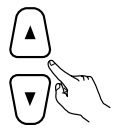

Select "TONE".

SUPER STADIUM

ROOM SIZE
 ◀medium▶

EFFECT ◀15▶

D. COMP ◀IMD▶

TONE ◀

6.1 / 7.1 Surround

ON ◀: ▶ OFF

Default Yes

1,6

2,4

3,5

3



Switch to the Tone Control screen.

Tone Control

Tone Defeat ON ◀: ▶ OFF

Bass ◀ -6dB ▶

Treble ◀ +10dB ▶

1,6

2,4

3,5

4

© To select Bass or Treble. © To set the level.

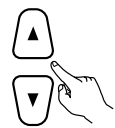
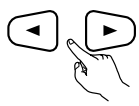
※ If you do not want the tone to be adjusted, set "Tone Defeat" to "ON".
 (See page 41.)



1,6

2,4

3,5

5



Enter the setting.
 The surround menu screen re-appears.

1,6

2,4

3,5

6

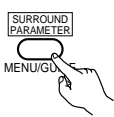

To end the setting mode, press the surround parameter button again.

1,6

2,4

3,5

55

Download from Wwww.Somanuals.com. All Manuals Search And Download.

Surround parameters ③

EFFECT:

This parameter turns the effect signals with multi surround mode speaker effects on and off in the WIDE SCREEN mode. When this parameter is turned off, the SBL and SBR channel signals are equivalent to the SL and SR channels, respectively.

LEVEL:

This parameter sets the strength of the effect signals in the WIDE SCREEN mode. It can be set in 15 steps, from "1" to "15". Set this to a low level if the positioning or phase of the surround signals sounds unnatural.

6.1 / 7.1 SURROUND:

Set this to "ON" when using surround back speakers.

Set this to "OFF" when not using surround back speakers.

This operation can be performed directly using the buttons on the main unit's panel.

ROOM SIZE:

This sets the size of the sound field.

There are five settings: "small", "med.s" (medium-small), "medium", "med.l" (medium-large) and "large". "small" recreates a small sound field, "large" a large sound field.

EFFECT LEVEL:

This sets the strength of the surround effect.

The level can be set in 15 steps from 1 to 15. Lower the level if the sound seems distorted.

DELAY TIME:

In the matrix mode only, the delay time can be set within the range of 0 to 30 ms.

tone CONTROL:

This can be set individually for the separate surround modes other than Direct and Home THX Cinema.

■ Surround modes and parameters

Mode	Signals and adjustability in the different modes														When playing Dolby Digital and DTS signals		
	Channel output						Parameter (default values are shown in parentheses)										
	FRONT L/R	CENTER	SURROUND L/R	SURROUND BACK	SUB-WOOFER	EFFECT L/R	TONE CONTROL	CINEMA EQ.	EFFECT	LEVEL	ROOM SIZE	EFFECT LEVEL	DELAY TIME	D.COMP.	6.1/7.1 SURROUND	SURROUND EX	
DIRECT	○	×	×	×	⊙	×	×	×	×	×	×	×	×	○ (OFF)	×	×	
STEREO	○	×	×	×	⊙	×	○ (0dB)	×	×	×	×	×	×	○ (OFF)	×	×	
6CH/8CH EXTERNAL INPUT	○	⊙	⊙	⊙	⊙	○	○ (0dB)	×	×	×	×	×	×	×	×	×	
WIDE SCREEN	○	⊙	⊙	⊙	⊙	×	○ (0dB)	○ (OFF)	○ (ON)	○ (10)	×	×	×	○ (OFF)	○	×	
DOLBY PRO LOGIC (THX CINEMA ON)	○	⊙	⊙	⊙	⊙	×	×	×	×	×	×	×	×	○ (OFF)	×	○	
(THX CINEMA OFF)	○	⊙	⊙	⊙	⊙	×	○ (0dB)	○ (OFF)	×	×	×	×	×	○ (OFF)	○	×	
DOLBY DIGITAL AC-3 (THX CINEMA ON)	○	⊙	⊙	⊙	⊙	×	×	×	×	×	×	×	×	○ (OFF)	×	○	
(THX CINEMA OFF)	○	⊙	⊙	⊙	⊙	×	○ (0dB)	○ (OFF)	×	×	×	×	×	○ (OFF)	○	×	
DTS SURROUND (THX CINEMA ON)	○	⊙	⊙	⊙	⊙	×	×	×	×	×	×	×	×	○ (OFF)	×	○	
(THX CINEMA OFF)	○	⊙	⊙	⊙	⊙	×	○ (0dB)	○ (OFF)	×	×	×	×	×	○ (OFF)	○	×	
5CH/7CH STEREO	○	⊙	⊙	⊙	⊙	×	○ (0dB)	×	×	×	×	×	×	○ (OFF)	○	×	
SUPER STADIUM	○	⊙	⊙	⊙	⊙	×	○ (note 1)	×	×	×	○ (Medium)	○ (10)	×	○ (OFF)	○	×	
ROCK ARENA	○	⊙	⊙	⊙	⊙	×	○ (note 2)	×	×	×	○ (Medium)	○ (10)	×	○ (OFF)	○	×	
JAZZ CLUB	○	⊙	⊙	⊙	⊙	×	○ (0dB)	×	×	×	○ (Medium)	○ (10)	×	○ (OFF)	○	×	
CLASSIC CONCERT	○	⊙	⊙	⊙	⊙	×	○ (0dB)	×	×	×	○ (Medium)	○ (10)	×	○ (OFF)	○	×	
MONO MOVIE	○	⊙	⊙	⊙	⊙	×	○ (0dB)	×	×	×	○ (Medium)	○ (10)	×	○ (OFF)	○	×	
MATRIX	○	⊙	⊙	⊙	⊙	×	○ (0dB)	×	×	×	×	×	○ (30msec)	○ (OFF)	○	×	

○ : Signal/adjustable

(Note 1) BASS: +6dB, TREBLE: 0dB

(Note 2) BASS: +8dB, TREBLE: +4dB

⊙ : Turned on or off by speaker configuration setting

× : No signal/not adjustable

12 LISTENING TO THE RADIO

Auto tuning

- 1** Set the input function to "TUNER".

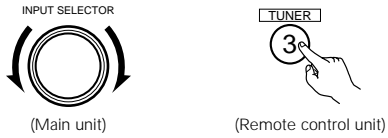

- 2** Watching the display, press the BAND button to select the desired band (AM or FM).



- 3** Press the MODE button to set the auto tuning mode.

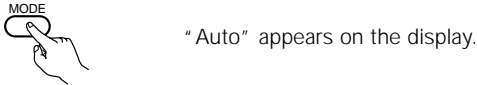

- 4** Press the TUNING UP or DOWN button.

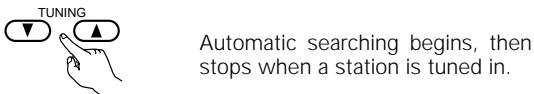

If tuning does not stop at the desired station, use the "Manual tuning" operation.

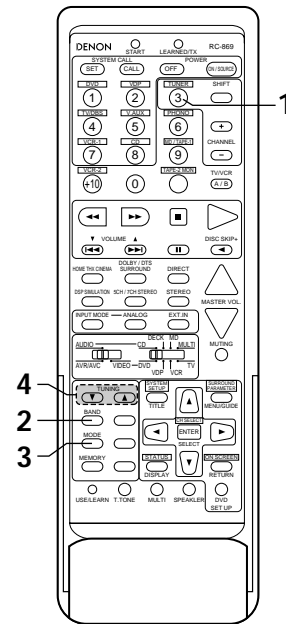
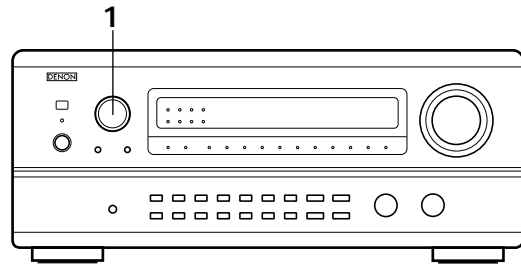

Manual tuning

- 1** Set the input function to "TUNER".

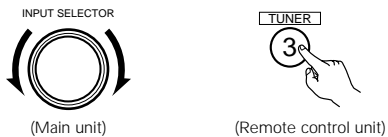

- 2** Watching the display, press the BAND button to select the desired band (AM or FM).



- 3** Press the MODE button to set the manual tuning mode. Check that the display's "AUTO" indicator turns.



- 4** Press the TUNING UP or DOWN button to tune in the desired station. The frequency changes continuously when the button is held in.

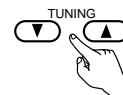

NOTES:

- When in the auto tuning mode on the FM band, the "STEREO" indicator lights on the display when a stereo broadcast is tuned in. At open frequencies, the noise is muted and the "TUNED" and "STEREO" indicators turn off.
- When the manual tuning mode is set, FM stereo broadcasts are received in monaural and the "STEREO" indicator turns off.

Preset memory

1 Use the "Auto tuning" or "Manual tuning" operation to tune in the station to be preset in the memory.

2 Press the MEMORY button.



3 Press the SHIFT button and select the desired memory block (A to E).

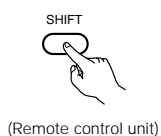
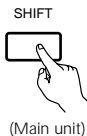

4 Press the PRESET UP or DOWN button to select the desired preset channel (1 to 8).

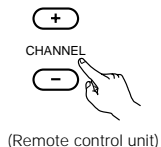
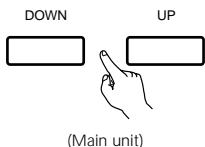

5 Press the MEMORY button again to store the station in the preset memory.



To preset other channels, repeat steps 2 to 5.
A total of 40 broadcast stations can be preset — 8 stations (channels 1 to 8) in each of blocks A to E.

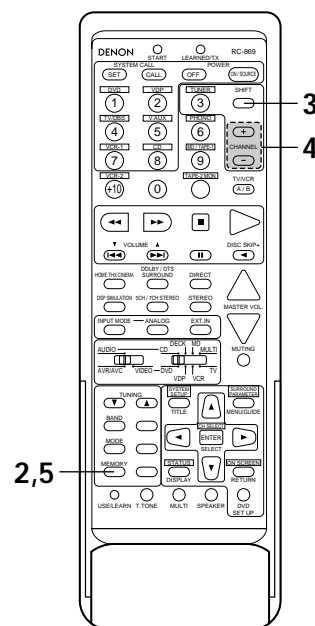
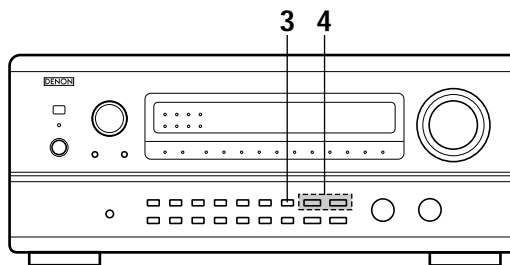

Checking the preset stations

The preset broadcast stations can be checked on the on screen display.

1 Press the ON SCREEN button repeatedly until the "Tuner Preset Stations" screen appears on the on screen display.

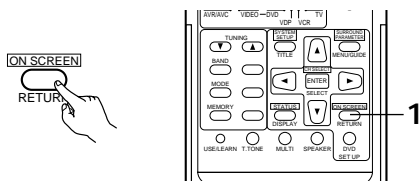

Tuner Preset Stations	
A1FM	87.50MHz
A2FM	89.10MHz
A3FM	98.10MHz
A4FM	107.90MHz
A5FM	90.10MHz
A6FM	90.10MHz
A7FM	90.10MHz
A8FM	90.10MHz

OSD-7

Recalling preset stations

- 1** Watching the display, press the SHIFT button to select the preset memory block.



- 2** Watching the display, press the PRESET UP or DOWN button to select the desired preset channel.

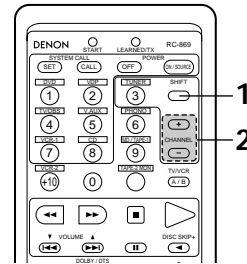
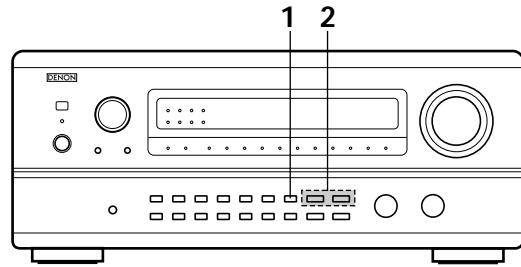
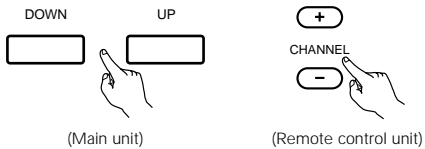

13 LAST FUNCTION MEMORY

- This unit is equipped with a last function memory which stores the input and output setting conditions as they were immediately before the power is switched off. This function eliminates the need to perform complicated resettings when the power is switched on.
- The unit is also equipped with a back-up memory. This function provides approximately one week of memory storage when the main unit's power switch is off and with the power cord disconnected.

14 INITIALIZATION OF THE MICROPROCESSOR

When the indication of the display is not normal or when the operation of the unit does not shows the reasonable result, the initialization of the microprocessor is required by the following procedure.

- 1** Switch off the unit and remove the AC cord from the AVR-4800 rear panel. Wait for 15 seconds.
- 2** Press and hold the 6.1/7.1 SURROUND buttons and DIRECT buttons, and at the same time, plug in the AC cord.
- 3** Check that the entire display is flashing with an interval of about 1 second, and release your fingers from the 2 buttons and the microprocessor will be initialized.

NOTES:

- If step 3 does not work, start over from step 1.
- If the microprocessor has been reset, all the button settings are reset to the default values (the values set upon shipment from the factory).

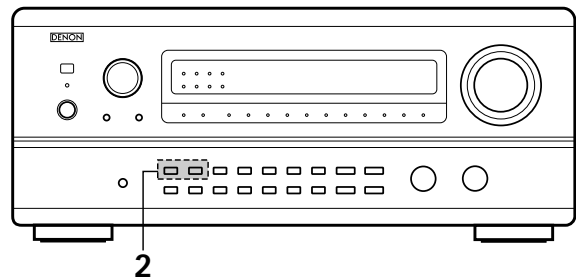

15 TROUBLESHOOTING

If a problem should arise, first check the following.

1. Are the connections correct ?
2. Have you operated the receiver according to the Operating Instructions ?
3. Are the speakers, turntable and other components operating properly ?

If this unit is not operating properly, check the items listed in the table below. Should the problem persist, there may be a malfunction. Disconnect the power immediately and contact your store of purchase.

	Symptom	Cause	Measures	Page
Common problems arising when listening to the CD, records, tapes, and FM broadcasts, etc.	DISPLAY not lit and sound not produced when power switch set to on.	<ul style="list-style-type: none"> Power cord not plugged in securely. 	<ul style="list-style-type: none"> Check the insertion of the power cord plug. Turn the power on with the remote control unit after turning the POWER switch on. 	6 39
	DISPLAY lit but sound not produced.	<ul style="list-style-type: none"> Speaker cords not securely connected. Improper position of the audio function button. Volume control set to minimum. MUTING is on. Digital signals not input Digital input selected. 	<ul style="list-style-type: none"> Connect securely. Set to a suitable position. Turn volume up to suitable level. Switch off MUTING. Input digital signals or select input jacks to which digital signals are being input. 	12 ~ 14 40 41 42 40
	DISPLAY not lit and power indicator is flashing rapidly.	<ul style="list-style-type: none"> Speaker terminals are short-circuited. Blocked ventilation holes resulting in too high operating temperature. The unit is operating at continuous high power conditions and/or inadequate ventilation. 	<ul style="list-style-type: none"> Switch power off, connect speakers properly, then switch power back on. Turn off the set's power, then ventilate it well to cool it down. Once the set is cooled down, turn the power back on. Turn off the set's power, then ventilate it well to cool it down. Once the set is cooled down, turn the power back on. 	12 ~ 14 4, 5 4, 5
	Sound produced only from one channel.	<ul style="list-style-type: none"> Incomplete connection of speaker cords. Incomplete connection of input/output cords. 	<ul style="list-style-type: none"> Connect securely. Connect securely. 	12 ~ 14 6 ~ 15
	Positions of instruments reversed during stereo playback.	<ul style="list-style-type: none"> Reverse connections of left and right speakers or left and right input/output cords. 	<ul style="list-style-type: none"> Check left and right connections. 	12 ~ 14
	The on screen display is not displayed.	<ul style="list-style-type: none"> "On screen display" is set to off on the system setup menu screen. 	<ul style="list-style-type: none"> Set "on screen display" on the system setup menu screen to on. 	29, 30
When playing records	Humming noise produced when record is playing.	<ul style="list-style-type: none"> Ground wire of turntable not connected properly. Incomplete PHONO jack connection. TV or radio transmission antenna nearby. 	<ul style="list-style-type: none"> Connect securely. Connect securely. Contact your store of purchase. 	6 6 —
	Howling noise produced when volume is high.	<ul style="list-style-type: none"> Turntable and speaker systems too close together. Floor is unstable and vibrates easily. 	<ul style="list-style-type: none"> Separate as much as possible. Use cushions to absorb speaker vibrations transmitted by floor. If turntable is not equipped with insulators, use audio insulators (commonly available). 	— —
	Sound is distorted.	<ul style="list-style-type: none"> Stylus pressure too weak. Dust or dirt on stylus. Cartridge defective. 	<ul style="list-style-type: none"> Apply proper stylus pressure. Check stylus. Replace cartridge. 	— — —
	Volume is weak.	<ul style="list-style-type: none"> MC cartridge being used. 	<ul style="list-style-type: none"> Replace with MM cartridge or use a head amplifier or step-up transformer. 	6
Remote control unit:	This unit does not operate properly when remote control unit is used.	<ul style="list-style-type: none"> Batteries dead. Remote control unit too far from this unit. Obstacle between this unit and remote control unit. Different button is being pressed. ⊕ and ⊖ ends of battery inserted in reverse. 	<ul style="list-style-type: none"> Replace with new batteries. Move closer. Remove obstacle. Press the proper button. Insert batteries properly. 	31 31 31 — 31

16 ADDITIONAL INFORMATION

Optimum surround sound for different sources

There are currently various types of multi-channel signals (signals or formats with more than two channels).

■ Types of multi-channel signals

Dolby Digital (EX), Dolby Pro Logic, DTS (ES), high definition 3-1 signals (Japan MUSE Hi-Vision audio), DVD-Audio, SACD (Super Audio CD), MPEG multi-channel audio, etc.

“Source” here does not refer to the type of signal (format) but the recorded content. Sources can be divided into two major categories.

2 Types of sources

• Movie audio

Signals created to be played in movie theaters. In general sound is recorded to be played in movie theaters equipped with multiple surround speakers, regardless of the format (Dolby Digital, DTS, etc.).

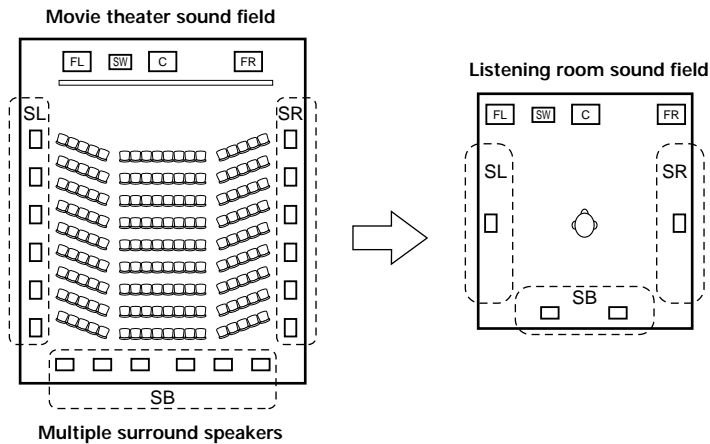

In this case it is important to achieve the same sense of expansion as in a movie theater with the surround channels. To do so, in some cases the number of surround speakers is increased (to four or eight) or speakers with bipolar or dipolar properties are used.

(SL: Surround L channel
SR: Surround R channel
SB: Surround B (back) channel

- **Other types of audio** These signals are designed to recreate a 360° sound field using three to five speakers.

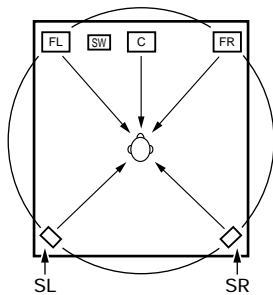

In this case the speakers should surround the listener from all sides to create a uniform sound field from 360°. Ideally the surround speakers should function as “point” sound sources in the same way as the front speakers.

These two types of sources thus have different properties, and different speaker settings, particularly for the surround speakers, are required in order to achieve the ideal sound.

The AVR-4800's surround speaker selection function makes it possible to change the settings according to the combination of surround speakers being used and the surrounding environment in order to achieve the ideal surround sound for all sources. This means that you can connect a pair of bipolar or dipolar surround speakers (mounted on either side of the prime listening position), as well as a separate pair of direct radiating (monopolar) speakers placed at the rear corners of the listening room.

Surround back speakers

The THX Surround EX format adds new "Surround Back" (SB) channels to the conventional 5.1-channel system. This makes it easy to achieve sound positioned directly behind the listener, something that was previously difficult with sources designed for conventional multi surround speakers. In addition, the acoustic image extending between the sides and the rear is narrowed, thus greatly improving the expression of the surround signals for sounds moving from the sides to the back and from the front to the point directly behind the listening position.

Change of positioning and acoustic image with 5.1-channel systems

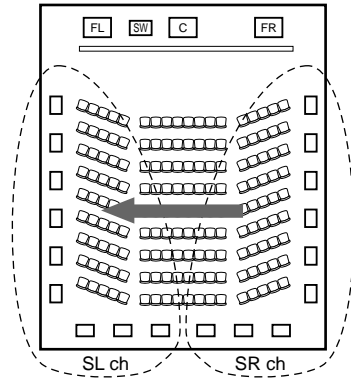

Movement of acoustic image from SR to SL

Change of positioning and acoustic image with THX Surround EX system

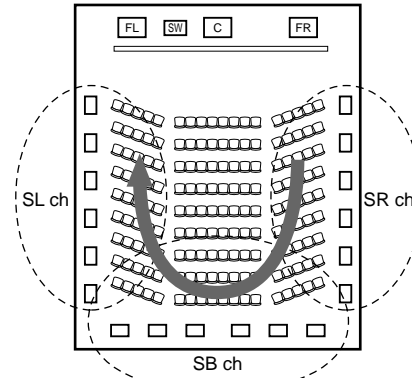

Movement of acoustic image from SR to SB to SL

Amplifier(s) and speaker(s) for one or two channels are required in order to achieve a THX Surround EX system with the AVR-4800. Adding these, however, allows you to achieve stronger surround effects not only with sources recorded in THX Surround EX, but also with conventional 2- to 5.1-channel sources. The WIDE SCREEN mode is a mode for achieving surround sound with up to 7.1 channels using surround back speakers, for sources recorded in conventional Dolby Surround as well as Dolby Digital 5.1-channel and DTS Surround 5.1-channel sources. Furthermore, all the Denon original surround modes (see page 53) are compatible with 7.1-channel playback, so you can enjoy 7.1-channel sound with any signal source.

■ Number of surround back speakers

With THX Surround EX, the surround back channel consists of one channel of playback signals, but we recommend using two speakers. When using dipolar speakers in particular, it is essential to use two speakers.

Using two speakers results in a smoother blend with the sound of the surround channels and better sound positioning of the surround back channel when listening from a position other than the center.

■ Placement of the surround left and right channels when using surround back speakers

Using surround back speakers greatly improves the positioning of the sound at the rear. Because of this, the surround left and right channels play an important role in achieving a smooth transition of the acoustic image from the front to the back. As shown on the diagram above, in a movie theater the surround signals are also produced from diagonally in front of the listeners, creating an acoustic image as if the sound were floating in space.

To achieve these effects, we recommend placing the speakers for the surround left and right channels slightly more towards the front than with conventional surround systems. Doing so sometimes increases the surround effect when playing conventional 5.1-channel sources in the THX Surround EX mode. Check the surround effects of the various modes before selecting the surround mode.

Speaker setting examples

Here we describe a number of speaker settings for different purposes. Use these examples as guides to set up your system according to the type of speakers used and the main usage purpose.

1. For THX Surround EX systems (using surround back speakers)

(1) Basic setting for primarily watching movies

This is recommended when mainly playing movies and using regular single way or 2-way speakers for the surround speakers.

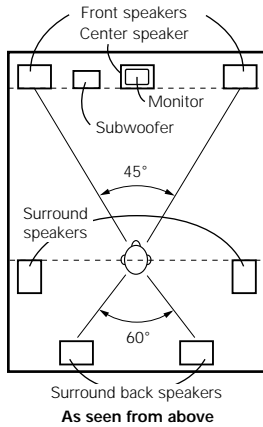

- Set the front speakers with their front surfaces as flush with the TV or monitor screen as possible. Set the center speaker between the front left and right speakers and no further from the listening position than the front speakers.
- Consult the owner's manual for your subwoofer for advice on placing the subwoofer within the listening room.
- If the surround speakers are direct-radiating (monopolar) then place them slightly behind and at an angle to the listening position and parallel to the walls at a position 60 to 90 centimeters (2 to 3 feet) above ear level at the prime listening position.
- When using two surround back speakers, place them at the back facing the front at a narrower distance than the front left and right speakers. When using one surround back speaker, place it at the rear center facing the front at a slightly higher position (0 to 20 cm) than the surround speakers.
- We recommend installing the surround back speaker(s) at a slightly downward facing angle. This effectively prevents the surround back channel signals from reflecting off the monitor or screen at the front center, resulting in interference and making the sense of movement from the front to the back less sharp.
- Connect the surround speakers to the surround speaker A jacks on the AVR-4800 and set all settings on the setup menu to "A". (This is the factory default setting. For details, see page 18.)

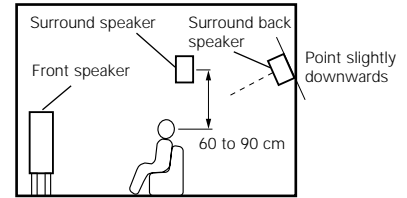

As seen from the side

(2) Setting for primarily watching movies using diffusion type speakers for the surround speakers

For the greatest sense of surround sound envelopment, diffuse radiation speakers such as bipolar types, or dipolar (THX) types, provide a wider dispersion than is possible to obtain from a direct radiating speaker (monopolar). Place these speakers at either side of the prime listening position, mounted above ear level.

Path of the surround sound from the speakers to the listening position

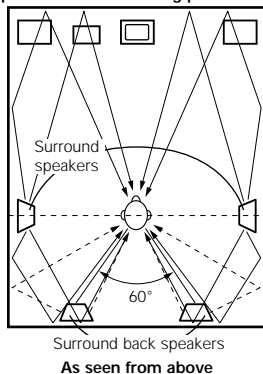

- Set the front speakers, center speaker and subwoofer in the same positions as in example (1).
- It is best to place the surround speakers directly at the side or slightly to the front of the viewing position, and 60 to 90 cm above the ears.
- Same as surround back speaker installation method (1). Using dipolar speakers for the surround back speakers as well is more effective.
- Connect the surround speakers to the surround speaker A jacks on the AVR-4800 and set all settings on the setup menu to "A". (This is the factory default setting. For details, see page 18.)
- The signals from the surround channels reflect off the walls as shown on the diagram at the left, creating an enveloping and realistic surround sound presentation. For multi-channel music sources however, the use of bipolar or dipolar speakers mounted at the sides of the listening position may not be satisfactory in order to create a coherent 360 degree surround sound field. Connect another pair of direct radiating speakers as described in example (3) and place them at the rear corners of the room facing towards the prime listening position.

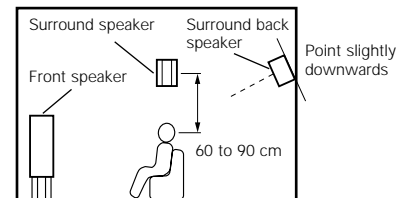

As seen from the side

(3) When using different surround speakers for movies and music

To achieve more effective surround sound for both movies and music, use different sets of surround speakers and different surround modes for the two types of sources.

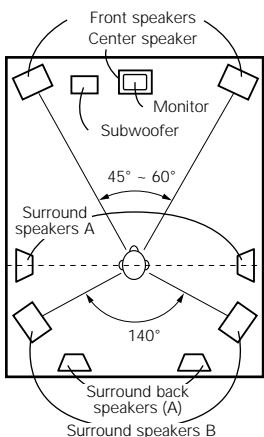

As seen from above

- Set the front speakers slightly wider apart than the setup for watching movies only and point them toward the listening position in order assure clear positioning of the sound.
- Set the center speaker in the same positions as in example (1).
- Set surround speakers A for watching movies in the positions described in example (1) or (2), depending on the types of speakers used.
- Set surround speakers B for playing multi-channel music at the same height as the front speakers and slightly at an angle to the rear of the listening position, and point them toward the listening position.
- Connect the surround speakers for watching movies to the surround speaker A jacks on the AVR-4800, the surround speakers for playing multi-channel music to the surround speaker B jacks. Set the surround speaker selection on the setup menu. (For instructions, see page 20.)
- To activate the appropriate speakers for movies and music, we suggest that during setup, choose Dolby Digital/DTS with THX and Surround Speakers A (the bipolar or dipolar speakers mounted at the sides of the listening position). Choose Dolby Digital/DTS without THX and Surround Speakers B (the direct radiating speakers mounted at the rear corners of the listening room). Then, by simply activating the THX function (used during movie playback, the Surround A speakers are automatically activated. For multi-channel music listening (Dolby Digital or DTS music programs), turn off the THX enhancements by touching the THX button on the remote control, and the Surround B speakers will be automatically activated.

Example: Movie sources (Dolby, DTS surround, etc.)
 "THX" or "THX 5.1" mode: Speakers A
 Music sources (DVD video, DTS CD, etc.)
 "Dolby/DTS surround": Speakers B

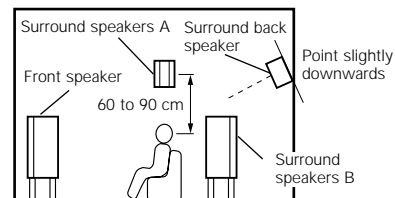

As seen from the side

※ The speakers can be switched at the touch of a button by turning HOME THX CINEMA on when playing movies and off when playing multi-channel music.

2. When not using surround back speakers

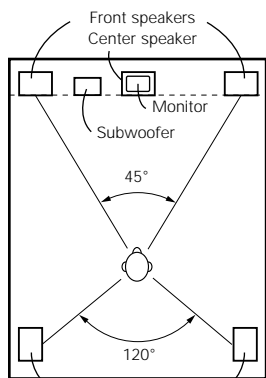

As seen from above

- Set the front speakers with their front surfaces as flush with the TV or monitor screen as possible. Set the center speaker between the front left and right speakers and no further from the listening position than the front speakers.
- Consult the owner's manual for your subwoofer for advice on placing the subwoofer within the listening room.
- If the surround speakers are direct-radiating (monopolar) then place them slightly behind and at an angle to the listening position and parallel to the walls at a position 60 to 90 centimeters (2 to 3 feet) above ear level at the prime listening position.
- Connect the surround speakers to the surround speaker A jacks on the AVR-4800 and set all settings on the setup menu to "A". (This is the factory default setting. For details, see page 18.)

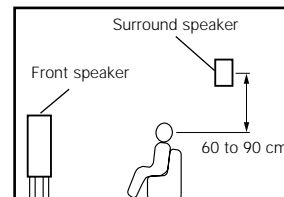

As seen from the side

The surround speakers can be switched freely during playback with the surround parameter adjustment. (For instructions, see page 51.)

Surround

The AVR-4800 is equipped with a digital signal processing circuit that lets you play program sources in the surround mode to achieve the same sense of presence as in a movie theater.

Dolby Surround

(1) Dolby Digital (Dolby Surround AC-3)

Dolby Digital is the multi-channel digital signal format developed by Dolby Laboratories.



Dolby Digital consists of up to "5.1" channels - front left, front right, center, surround left, surround right, and an additional channel exclusively reserved for additional deep bass sound effects (the Low Frequency Effects – LFE – channel, also called the ".1" channel, containing bass frequencies of up to 120 Hz).

Unlike the analog Dolby Pro Logic format, Dolby Digital's main channels can all contain full range sound information, from the lowest bass, up to the highest frequencies – 20 kHz. The signals within each channel are distinct from the others, allowing pinpoint sound imaging, and Dolby Digital offers tremendous dynamic range from the most powerful sound effects to the quietest, softest sounds, free from noise and distortion.

■ Dolby Digital and Dolby Pro Logic

Comparison of home surround systems	Dolby Digital	Dolby Pro Logic
No. recorded channels (elements)	5.1 ch	2 ch
No. playback channels	5.1 ch	4 ch
Playback channels (max.)	L, R, C, SL, SR, SW	L, R, C, S (SW - recommended)
Audio processing	Digital discrete processing Dolby Digital (AC-3) encoding/decoding	Analog matrix processing Dolby Surround
High frequency playback limit of surround channel	20 kHz	7 kHz

■ Dolby Digital compatible media and playback methods

Marks indicating Dolby Digital compatibility:  and .

The following are general examples. Also refer to the player's operating instructions.

Media	Dolby Digital output jacks	Playback method (reference page)
LD (VDP) ※ 1 ※ 2	Coaxial Dolby Digital RF output jack ※ 1 ※ 2	Connect to an outboard AC-3 RF demodulator, and connect to a digital input, coax or optical
DVD ※ 2	Optical or coaxial digital output (same as for PCM) ※ 3	Set the input mode to "AUTO" (Page 40)
Others (satellite broadcasts, DTV, etc.)	Optical or coaxial digital output (same as for PCM)	Set the input mode to "AUTO". (Page 40)

- ※ 1 Please use a commercially available adapter when connecting the Dolby Digital RF (AC-3RF) output jack of the LD player to the digital input jack. The AVR-4800 does not include a Dolby Digital AC-3 RF demodulator function. Please refer to the instruction manual of the AC-3 RF demodulator/adaptor when making connections.
- ※ 2 When the LD/DVD compatible player is equipped with Dolby Digital RF outputs, the LD's Dolby Digital output is output from the RF jacks and the DVD's Dolby Digital output is output from the optical or coaxial digital jacks. Select the input mode according to the type of media being played (LD or DVD). You may wish to connect the outboard RF demodulator's digital output to the AVR-4800's VDP input.
- ※ 3 Some DVD digital outputs have the function of switching the Dolby Digital signal output method between "bit stream" and "(convert to) PCM". When playing in Dolby Digital surround on the AVR-4800, switch the DVD player's output mode to "bit stream". In some cases players are equipped with both "bit stream + PCM" and "PCM only" digital outputs. In this case connect the "bit stream + PCM" jacks to the AVR-4800.

(2) Dolby Pro Logic

Dolby Pro Logic is a multi-channel signal playback system developed by Dolby Laboratories which decodes sources recorded in Dolby Surround into four channels: front left, center, front right and surround (the surround channel is monaural, but is played through two surround speakers). Here, "sources recorded in Dolby Surround" are sources on which surround signals (three channels or more) are recorded onto two channels using Dolby Surround encoding technology. Dolby Surround recording is possible for all two-channel signal sources, including soundtracks on DVDs (*), LDs or hi-fi VCRs (for which stereo signal recording is possible), stereo FM, TV and satellite broadcasts, stereo CD, MD and analog cassette tape recordings. Sources recorded in Dolby Surround are compatible with stereo playback, so they can be played in stereo on regular stereo equipment and in surround with Dolby Pro Logic processing. (DTS and Dolby Digital require special decoders to be played.)

With Dolby Pro Logic, the signal levels of the different channels of the source recorded in Dolby Surround are monitored, channels with higher signal levels are emphasized and the level of the other channels is decreased in order to reinforce the directivity and achieve an effective surround sound.

* DVDs recorded in Dolby Surround include sources recorded in PCM and sources recorded in 2-channel Dolby Digital. For 2-channel Dolby Digital DVD sources, the DVD player's audio mode is 2-channel Dolby Digital, and the AVR-4800's surround mode is Dolby Pro Logic. Use the display pattern of the channel indicators (see page 50) to check whether the Dolby Digital signals are recorded in 2-channel stereo or Dolby Surround.

■ Dolby Pro Logic compatible media and playback methods

Mark indicating Dolby Pro Logic compatibility: 

When playing in Dolby Pro Logic, select the input signal according to how the player is connected to the AVR-4800, in the same way as selecting the stereo signal (see page 28). Set the surround mode to "DOLBY SURROUND" (see page 52) to play in Dolby Pro Logic.

Manufactured under license from Dolby Laboratories.
"Dolby", "Pro Logic" and the double-D symbol are trademarks of Dolby Laboratories.
Confidential Unpublished Works. ©1992-1997 Dolby Laboratories, Inc. All rights reserved.

DTS Digital Surround

DTS Digital Surround (also called simply DTS) is a multi-channel digital signal format developed by Digital Theater Systems.



DTS offers the same "5.1" playback channels as Dolby Digital (front left, front right and center, surround left and surround right) as well as the stereo 2-channel mode. The signals for the different channels are fully independent, eliminating the risk of deterioration of sound quality due to interference between signals, crosstalk, etc.

DTS features a relatively higher bit rate as compared to Dolby Digital (1234 kbps for CDs and LDs, 1536 kbps for DVDs) so it operates with a relatively low compression rate. Because of this the amount of data is great, and when DTS playback is used in movie theaters, a separate CD-ROM synchronized with the film is played.

With LDs and DVDs, there is of course no need for an extra disc; the pictures and sound can be recorded simultaneously on the same disc, so the discs can be handled in the same way as discs with other formats.

There are also music CDs recorded in DTS. These CDs include 5.1-channel surround signals (compared to two channels on current CDs). They do not include picture data, but they offer surround playback on CD players that are equipped with digital outputs (PCM type digital output required). DTS surround track playback offers the same intricate, grand sound as in a movie theater, right in your own listening room.

■ DTS compatible media and playback methods

Marks indicating DTS compatibility:  and .

The following are general examples. Also refer to the player's operating instructions.

Media	Dolby Digital output jacks	Playback method (reference page)
CD	Optical or coaxial digital output (same as for PCM) * 2	Set the input mode to "AUTO" or "DTS" (page 40). Never set the mode to "ANALOG" or "PCM". * 1
LD (VDP)	Optical or coaxial digital output (same as for PCM) * 2	Set the input mode to "AUTO" or "DTS" (page 40). Never set the mode to "ANALOG" or "PCM". * 1
DVD	Optical or coaxial digital output (same as for PCM) * 3	Set the input mode to "AUTO" or "DTS" (page 40).

* 1 DTS signals are recorded in the same way on CDs and LDs as PCM signals. Because of this, the un-decoded DTS signals are output as random "hissy" noise from the CD or LD player's analog outputs. If this noise is played with the amplifier set at a very high volume, it may possibly cause damage to the speakers. To avoid this, be sure to switch the input mode to "AUTO" or "DTS" before playing CDs or LDs recorded in DTS. Also, never switch the input mode to "ANALOG" or "PCM" during playback. The same holds true when playing CDs or LDs on a DVD player or LD/DVD compatible player. For DVDs, the DTS signals are recorded in a special way so this problem does not occur.

* 2 The signals provided at the digital outputs of a CD or LD player may undergo some sort of internal signal processing (output level adjustment, sampling frequency conversion, etc.). In this case the DTS-encoded signals may be processed erroneously, in which case they cannot be decoded by the AVR-4800, or may only produce noise. Before playing DTS signals for the first time, turn down the master volume to a low level, start playing the DTS disc, then check whether the DTS indicator on the AVR-4800 (see page 50) lights before turning up the master volume.

* 3 A DVD player with DTS-compatible digital output is required to play DTS DVDs. A DTS Digital Output logo is featured on the front panel of compatible DVD players. Recent DENON DVD player models feature DTS-compatible digital output – consult the player's owner's manual for information on configuring the digital output for DTS playback of DTS-encoded DVDs.

Manufactured under license from Digital Theater Systems, Inc. US Pat. No. 5,451,942, 5,956,674 and other world-wide patents issued and pending. "DTS", "ES" and "DTS DIGITAL SURROUND" are trademarks of Digital Theater Systems, Inc. Copyright 1996 Digital Theater Systems, Inc. All rights reserved.

Home THX Cinema surround mode

THX is an exclusive set of standards and technologies established by the world-renowned film production company, Lucasfilm Ltd. THX grew from George Lucas' personal desire to make your experience of the film soundtrack, in both movie theaters and in your home theater, as faithful as possible to what the director intended.

Movie soundtracks are mixed in special movie theaters called dubbing stages and are designed to be played back in movie theaters with similar equipment and conditions. The soundtrack created for movie theaters is then transferred directly onto Laser disc, VHS tape, DVD, etc., and is not changed for playback in a small home theater environment.

THX engineers developed patented technologies to accurately translate the sound from the movie theater environment into the home, correcting the tonal and spatial errors that occur. On the AVR-4800, when the Home THX Cinema mode is on, THX processing is automatically added after the Dolby Pro Logic, Dolby Digital or DTS decoder:

Re-Equalization™

The tonal balance of a film soundtrack will be excessively bright and harsh when played back over audio equipment in the home because film soundtracks are designed to be played back in large movie theaters using very different professional equipment. Re-Equalization restores the correct tonal balance for watching a movie soundtrack in a small home environment.

Timbre Matching™

The human ear changes our perception of a sound depending on the direction from which the sound is coming. In a movie theater, there is an array of surround speakers so that the surround information is all around you. In a home theater, only two speakers located to the side of your head are used. The Timbre Matching feature filters the information going to the surround speakers so that they more closely match the tonal characteristics of the sound coming from the front speakers. This ensures seamless panning between the front and surround speakers.

Adaptive Decorrelation™

In a movie theater, a large number of surround speakers help create an enveloping surround sound experience, while in a home theater there are usually only two speakers. This can make the surround speakers sound like headphones that lack spaciousness and envelopment. The surround sounds will also collapse into the closest speaker as you move away from the middle seating position. Adaptive Decorrelation slightly changes one surround channel's time and phase relationship with respect to the other surround channel. This expands the listening position and creates—with only two speakers—the same spacious surround experience as in a movie theater.

THX Ultra™

Before any home theater component can be THX Ultra certified, it must incorporate all the features above and also pass a rigorous series of quality and performance tests. Only then can a product feature the THX Ultra logo, which is your guarantee that the Home Theater products you purchase will give you superb performance for many years to come. THX Ultra requirements cover every aspect of the product including power amplifier performance, pre-amplifier performance and operation, as well as hundreds of other parameters in both the digital and analog domain.

Lucasfilm, THX, Home THX, Re-Equalization, Timbre Matching, Adaptive Decorrelation and THX Ultra are trademarks of Lucasfilm Ltd.

THX Surround EX

In 1999, a new surround system was launched simultaneously with the release of the movie "Star Wars Episode I". "Dolby Digital Surround EX" is a new movie sound track that greatly enhances the sense of spatial expression and the positioning of the surround channel sound. The result is 360 degrees of movement and moving sound effects that seem to pass right over the listener's head.

This system was developed jointly by Lucasfilm THX and Dolby Laboratories, fusing Lucasfilm's idea of improving spatial expression and achieving a uniform 360 degree sound positioning with Dolby Laboratories' matrix encoding technology. Emphasis was placed on compatibility with the existing system Dolby Digital 5.1-channel, and the new "surround back (SB) channel" was added to achieve improvements over the conventional 5.1-channel system in terms of the positioning of the sound at the rear, the acoustic image of sound moving from the two sides to the back as well as sound moving from the front to the center rear with the multi surround speaker systems used in movie theaters, thereby enabling various types of surround sound.

The surround back channel signal is a matrix-encoded signal inserted into both the Dolby Digital SL (surround left) and SR (surround right) channels. Upon playback, the signals are decoded by a high precision digital matrix decoder within the Dolby Digital decoder into the SL, SR and SB channels and output as 6.1 channels of signals. With the AVR-4800, the signals further undergo Home THX Cinema processing to achieve a THX Surround EX system.

Even without the proper environment for playing the SB channel, Dolby Digital Surround EX signals are 100% compatible with existing 5.1-channel playback systems, so they can be played as such. In this case, the SB channel signal is produced as a monaural signal from both the SL and SR channels, so none of the signal components are missing. The effects specific to THX Surround EX (the sense of spatial expression and the positioning of the sound), however, are the same as with conventional 5.1-channel surround systems.

©Lucasfilm Ltd. & TM. All Rights Reserved. Surround EX is a jointly developed technology of THX and Dolby Labs, Inc., and is a trademark of Dolby. Used under authorization.

System setup items and default values (set upon shipment from the factory)

System setup				Default settings									
①	Speaker Configuration	Input the combination of speakers in your system and their corresponding sizes (SMALL for regular speakers, LARGE for full-size, full-range) to automatically set the composition of the signals output from the speakers and the frequency response.		Front Sp.		Center Sp.		Surround Sp.		Surround Back Sp.		Sub Woofer	
	(Surround Speaker Setting)	Use this function when using multiple surround speaker combinations for more ideal surround sound. Once the combinations of surround speakers to be used for the different surround modes are preset, the surround speakers are selected automatically according to the surround mode.		Small		Small		Small		Small / 2spkr		Yes	
①	Subwoofer mode	This selects the subwoofer speaker for playing deep bass signals.		LFE —THX—									
		Surround mode	Surround speaker	DOLBY/DTS SURROUND	THX SURROUND	WIDE SCREEN	5CH/7CH STEREO	DSP SIMULATION	EXT. IN	—	—		
②	THX Surround EX	Select the operation when the "THX Surround EX" surround parameter is set to "ON".		THX Surround EX = ON									
③	Delay Time	This parameter is for optimizing the timing with which the audio signals are produced from the speakers and subwoofer according to the listening position.		Front L & R		Center		Surround L & R		SBL & SBR		Sub Woofer	
				12 ft (3.6 m)		12 ft (3.6 m)		10 ft (3.0 m)		10 ft (3.0 m)		12 ft (3.6 m)	
④	Power Amp Assignment	Set this when the power amplifier for the front channels is switched for use with the surround back channel.		Front / Center / Surround									
⑤	Channel Level	This adjusts the volume of the signals output from the speakers and subwoofer for the different channels in order to obtain optimum effects.		Front L	Front R	Center	Surround L	Surround R	Surround Back L	Surround Back R	Subwoofer		
				0 dB	0 dB	0 dB	0 dB	0 dB	0 dB	0 dB	0 dB	0 dB	
⑥	Subwoofer Peak Limit Lev	This parameter is for detecting the maximum level of the low bass signals output from the subwoofer channel in order to protect the subwoofer from damage and prevent unpleasant distorted sounds from being produced.		Peak Limiter = OFF									
⑦	Digital In Assignment	This assigns the digital input jacks for the different input sources.		Input source	CD	DVD	VDP	TV/DBS	VCR-1	VCR-2	V. AUX	TAPE-1	
				Digital Inputs	COAXIAL 1	COAXIAL 2	COAXIAL 3	OPTICAL 1	OPTICAL 2	OPTICAL 3	OPTICAL 4	OPTICAL 5	
⑧	On Screen Display	This sets whether or not to display the on-screen display that appears on the monitor screen when the controls on the remote control unit or main unit are operated (from MONITOR 1 outputs only).		On Screen Display = ON									
⑨	Auto Tuner Presets	FM stations are received automatically and stored in the memory.		A1 ~ A8	87.5/89.1/98.1/107.9/90.1/90.1/90.1 MHz								
				B1 ~ B8	520/600/1000/1400/1500/1710 kHz/90.1/90.1 MHz								
				C1 ~ C8	90.1 MHz								
				D1 ~ D8	90.1 MHz								
				E1 ~ E8	90.1 MHz								

Surround modes and parameters

Mode	Signals and adjustability in the different modes															
	Channel output						Parameter (default values are shown in parentheses)									
	FRONT L/R	CENTER	SURROUND L/R	SURROUND BACK	SUB-WOOFER	EFFECT L/R	TONE CONTROL	CINEMA EQ.	EFFECT	LEVEL	ROOM SIZE	EFFECT LEVEL	DELAY TIME	When playing Dolby Digital and DTS signals		
														D.COMP.	6.1/7.1 SURROUND	SURROUND EX
DIRECT	○	×	×	×	⊙	×	×	×	×	×	×	×	×	○ (OFF)	×	×
STEREO	○	×	×	×	⊙	×	○ (0dB)	×	×	×	×	×	×	○ (OFF)	×	×
6CH/8CH EXTERNAL INPUT	○	⊙	⊙	⊙	⊙	○	○ (0dB)	×	×	×	×	×	×	×	×	×
WIDE SCREEN	○	⊙	⊙	⊙	⊙	×	○ (0dB)	○ (OFF)	○ (ON)	○ (10)	×	×	×	○ (OFF)	○	×
DOLBY PRO LOGIC (THX CINEMA ON)	○	⊙	⊙	⊙	⊙	×	×	×	×	×	×	×	×	○ (OFF)	×	○
(THX CINEMA OFF)	○	⊙	⊙	⊙	⊙	×	○ (0dB)	○ (OFF)	×	×	×	×	×	○ (OFF)	○	×
DOLBY DIGITAL AC-3 (THX CINEMA ON)	○	⊙	⊙	⊙	⊙	×	×	×	×	×	×	×	×	○ (OFF)	×	○
(THX CINEMA OFF)	○	⊙	⊙	⊙	⊙	×	○ (0dB)	○ (OFF)	×	×	×	×	×	○ (OFF)	○	×
DTS SURROUND (THX CINEMA ON)	○	⊙	⊙	⊙	⊙	×	×	×	×	×	×	×	×	○ (OFF)	×	○
(THX CINEMA OFF)	○	⊙	⊙	⊙	⊙	×	○ (0dB)	○ (OFF)	×	×	×	×	×	○ (OFF)	○	×
5CH/7CH STEREO	○	⊙	⊙	⊙	⊙	×	○ (0dB)	×	×	×	×	×	×	○ (OFF)	○	×
SUPER STADIUM	○	⊙	⊙	⊙	⊙	×	○ (note 1)	×	×	×	○ (Medium)	○ (10)	×	○ (OFF)	○	×
ROCK ARENA	○	⊙	⊙	⊙	⊙	×	○ (note 2)	×	×	×	○ (Medium)	○ (10)	×	○ (OFF)	○	×
JAZZ CLUB	○	⊙	⊙	⊙	⊙	×	○ (0dB)	×	×	×	○ (Medium)	○ (10)	×	○ (OFF)	○	×
CLASSIC CONCERT	○	⊙	⊙	⊙	⊙	×	○ (0dB)	×	×	×	○ (Medium)	○ (10)	×	○ (OFF)	○	×
MONO MOVIE	○	⊙	⊙	⊙	⊙	×	○ (0dB)	×	×	×	○ (Medium)	○ (10)	×	○ (OFF)	○	×
MATRIX	○	⊙	⊙	⊙	⊙	×	○ (0dB)	×	×	×	×	×	○ (30msec)	○ (OFF)	○	×

○ : Signal/adjustable

(Note 1) BASS: +6dB, TREBLE: 0dB

(Note 2) BASS: +8dB, TREBLE: +4dB

⊙ : Turned on or off by speaker configuration setting

× : No signal/not adjustable

17 SPECIFICATIONS

■ Audio section

• Power amplifier

Rated output:

(All properties shown are only for the power amplifier stage.)

Stereo (2ch driven)
 125 W + 125 W (8 Ω/ohms, 20 Hz ~ 20 kHz with 0.05% T.H.D.)
 130 W + 130 W (8 Ω/ohms, 1 kHz with 0.7% T.H.D.)
 Surround
 125 W x 5 ch (8 Ω/ohms, 1 kHz with 0.7% T.H.D.)

Dynamic power:

170 W x 2 ch (8 Ω/ohms)
 270 W x 2 ch (4 Ω/ohms)
 350 W x 2 ch (2 Ω/ohms)

Output terminals:

Front/Center: 6 ~ 16 Ω/ohms
 Surround: A or B 6 ~ 16 Ω/ohms
 A + B 8 ~ 16 Ω/ohms

• Analog

Input sensitivity / input impedance:

200 mV / 47 kΩ/kohms

Frequency response:

10 Hz ~ 100 kHz: +0, -3 dB (DIRECT mode)

S/N:

105 dB (DIRECT mode)

Distortion:

0.005% (20 Hz ~ 20 kHz) (DIRECT mode)

Rated output/maximum output:

1.2 V / 8 V

• Digital

D/A output:

Rated output — 2 V (at 0 dB playback)
 Total harmonic distortion — 0.005% (1 kHz, at 0 dB)
 S/N ratio — 105 dB
 Dynamic range — 96 dB
 Format — Digital audio interface

Digital input:

• Phono equalizer (PHONO input — REC OUT)

Input sensitivity:

2.5 mV

RIAA deviation:

±1 dB (20 Hz to 20 kHz)

Signal-to-noise ratio:

74 dB (A weighting, with 5 mV input)

Rated output / Maximum output:

150 mV / 8 V

Distortion factor:

0.03% (1 kHz, 3 V)

■ Video section

• Standard video jacks

Input / output level and impedance:

1 Vp-p, 75 Ω/ohms

Frequency response:

5 Hz ~ 10 MHz — +0, -3 dB

• S-video jacks

Input / output level and impedance:

Y (brightness) signal — 1 Vp-p, 75 Ω/ohms

C (color) signal — 0.286 Vp-p, 75 Ω/ohms

Frequency response:

5 Hz ~ 10 MHz — +0, -3 dB

• Color component video terminal

Input / output level and impedance:

Y (brightness) signal — 1 Vp-p, 75 Ω/ohms

Cb (blue) signal — 0.7 Vp-p, 75 Ω/ohms

Cr (red) signal — 0.7Vp-p, 75 Ω/ohms

Frequency response:

5 Hz ~ 20 MHz — +0, -3 dB

■ Tuner section

Receiving Range:

[FM] (note: μV at 75 Ω/ohms, 0 dBf = 1 x 10⁻¹⁵ W)
 87.5 MHz ~ 107.9 MHz

[AM]

520 kHz ~ 1710 kHz

Usable Sensitivity:

1.0 μV (11.2 dBf)

18 μV

50 dB Quieting Sensitivity:

MONO 1.6 μV (15.3 dBf)

STEREO 23 μV (38.5 dBf)

Signal to Noise Ratio (IHF-A):

MONO 80 dB

50 dB

STEREO 75 dB

Total Harmonic Distortion (at 1 kHz):

MONO 0.15%

STEREO 0.3%

■ General

Power supply:

AC 120 V, 60 Hz

Power consumption:

10.9 A

Maximum external dimensions:

434 (W) x 181 (H) x 494 (D) mm (17-3/32" x 7-1/8" x 19-29/64")

Weight:

21.5 kg (47 lbs 6 oz)

■ Remote control unit (RC-869)

Batteries:

R6P/AA Type (two batteries)

External dimensions:

70 (W) x 215 (H) x 24 (D) mm (2-3/4" x 8-15/32" x 15/16")

Weight:

200 g (Approx. 7 oz) (including batteries)

* For purposes of improvement, specifications and design are subject to change without notice.

Free Manuals Download Website

<http://myh66.com>

<http://usermanuals.us>

<http://www.somanuals.com>

<http://www.4manuals.cc>

<http://www.manual-lib.com>

<http://www.404manual.com>

<http://www.luxmanual.com>

<http://aubethermostatmanual.com>

Golf course search by state

<http://golfingnear.com>

Email search by domain

<http://emailbydomain.com>

Auto manuals search

<http://auto.somanuals.com>

TV manuals search

<http://tv.somanuals.com>