

# OPERATION **MANUAL**

**CLASSIC PLUS 14 and CLASSIC PLUS 26**

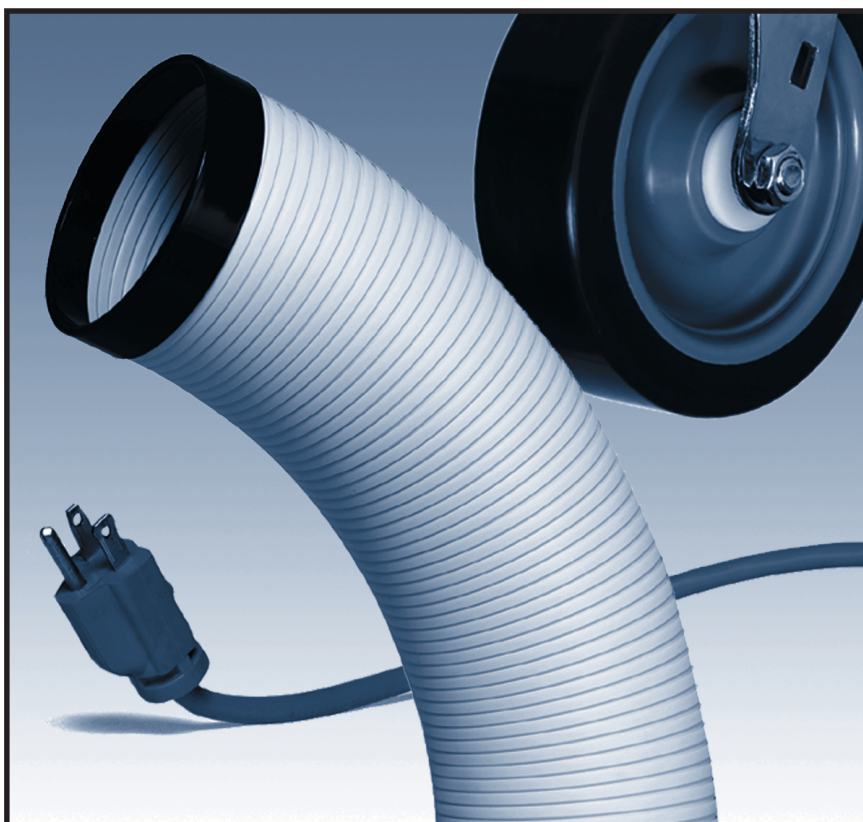

READ THIS MANUAL CAREFULLY FOR INSTRUCTIONS ON CORRECT  
INSTALLATION AND USAGE, AND READ ALL SAFEGUARDS.

**SECCIÓN EN ESPAÑOL**  
**SECTION EN FRANÇAIS**



**MOVINCOOL®**  
Pioneering New Solutions With Portable Air-Conditioning

**© 2003 DENSO SALES CALIFORNIA, INC.**

All rights reserved. This book may not be reproduced or copied, in whole or in part, without the written permission of the publisher. DENSO SALES CALIFORNIA, INC. reserves the right to make changes without prior notice. MovinCool is a registered trademark of DENSO Corporation.

# OPERATION **MANUAL**

**CLASSIC PLUS 14 and CLASSIC PLUS 26**

**MOVINCOOL®**  
THE PORTABLE SPOT COOLING SOLUTION



# TABLE OF CONTENTS

<b>FOREWORD</b> .....	1
Definition of Terms .....	1
<b>GENERAL WARNINGS &amp; CAUTIONS</b> .....	2
<b>INVENTORY &amp; ASSEMBLY</b> .....	3
Inventory .....	3
Assembly .....	4
<b>INSTALLATION</b> .....	5
Choosing and Installation Site .....	5
Moving the Unit .....	6
Plugging in the Unit .....	7
<b>FEATURES</b> .....	8
<b>OPERATION</b> .....	9
Control Panel .....	9
Operating in COOL Mode .....	10
Operating in Fan Only Mode .....	10
Changing from Fan Only Mode to COOL Mode .....	10
Operating Modes .....	11
Emptying the Drain Tank .....	12
DRAIN PUMP KIT (Optional) (Classic Plus 14 model ONLY) .....	13
DRAIN PUMP KIT (Optional) (Classic Plus 26 model ONLY) .....	14
<b>DAILY INSPECTION &amp; MAINTENANCE</b> .....	15
Emptying the Drain Tank .....	15
Cleaning the Air Filters .....	15
Filter Removal Method (both models) .....	15
Filter Element Cleaning Method (both models) .....	15
<b>IN-SEASON/OFF-SEASON INSPECTION &amp; MAINTENANCE</b> .....	16
In-Season .....	16
Off Season .....	16
<b>TROUBLESHOOTING</b> .....	17
Self-Diagnostic Codes .....	17
<b>TECHNICAL SPECIFICATIONS</b> .....	18
SECCIÓN EN ESPAÑOL .....	19
SECTION EN FRANÇAIS .....	41



# FOREWORD

Congratulations on purchasing the MovinCool portable air conditioner.

This manual explains how to assemble, install, operate, and maintain the MovinCool Classic Plus 14 and Classic Plus 26 portable air conditioning units. Please read this operation manual thoroughly to familiarize yourself with the features of the unit and to ensure years of reliable operation. You may also find it useful to keep this operation manual on hand for reference.

Components and/or procedures are subject to change without prior notice.

## Definition of Terms

**⚠WARNING:** Describes precautions that should be observed in order to prevent injury to the user during installation or unit operation.

**⚠CAUTION:** Describes precautions that should be observed in order to prevent damage to the unit or its components, which may occur during installation or unit operation if sufficient care is not taken.

**NOTE:** Provides additional information that facilitates installation or unit operation.

## **GENERAL WARNINGS & CAUTIONS**

- All electrical work, if necessary, should only be performed by qualified electrical personnel. Repair to electrical components by non-certified technicians may result in personal injury and/or damage to the unit. All electrical components replaced must be genuine MovinCool parts, purchased from an authorized reseller.
- The proper electrical outlet for MovinCool units must be equipped with a UL approved ground-fault breaker to prevent electrical shock from the unit.
- Because of potential safety hazards under a certain condition, we strongly recommend against the use of an extension cord. However, if you still elect to use an extension cord, it is absolutely necessary that it will be a UL listed, 3-wire grounding type appliance extension cord, having a 3-blade grounding plug and a 3-slot receptacle that will plug into the appliance. The marked rating of the extension cord should be 115 V, 15 A or equivalent.
- The Classic Plus 14 model is equipped with a ten (10) foot (3 meter) power cord. The Classic Plus 26 model is equipped with a six (6) foot (1.8 meter) power cord. If replacement, fixed location (hard wired) or power cord lengthening (extension cord) cords are required, contact your reseller or a qualified electrician for approved replacement methods.
- Never fold, or place heavy objects on the power cord. This could result in damage to the power cord causing electrical shock or fire.
- Do not place water or any other liquid on the unit. This can cause damage to the unit and increase the risk of electrical shock.
- Do not sit or stand on the unit.



# INVENTORY & ASSEMBLY

## Inventory

After unpacking your MovinCool unit, please check to make sure you have the following items:

- Classic Plus 14 or Classic Plus 26 MovinCool Unit (1)
- Cool Air Outlet Ducts (2)
- Screws (8)
- Operation Manual/Warranty Card (1)

**NOTE: If any of these items were not included in the box or appear damaged, please contact your MovinCool reseller for replacement.**

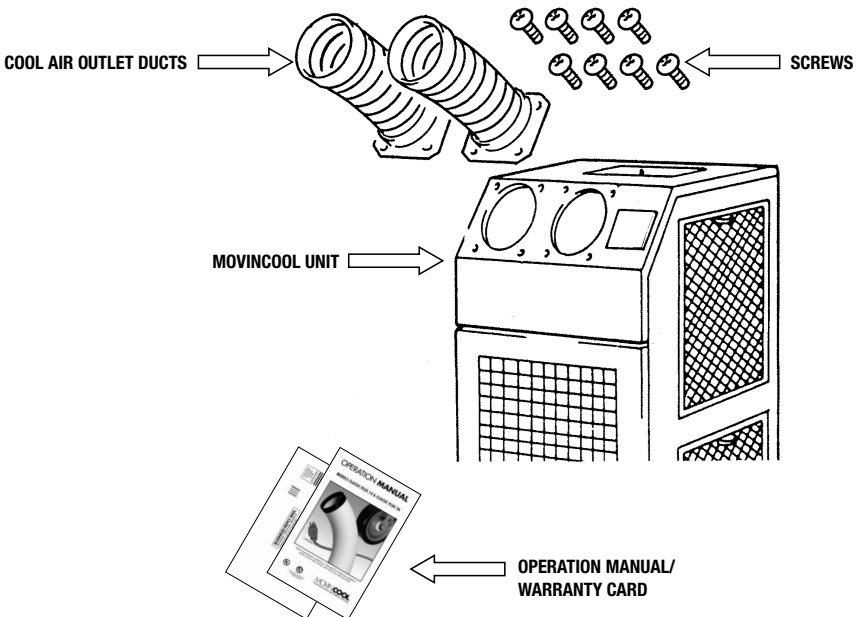

# INVENTORY & ASSEMBLY

## Assembly

**⚠CAUTION:** Before assembling make sure the unit is on a flat, level surface and the casters are in the **LOCKED** position. (Both the **Classic Plus 14** and **Classic Plus 26 MovinCool** units have locking swivel casters in the front only.)

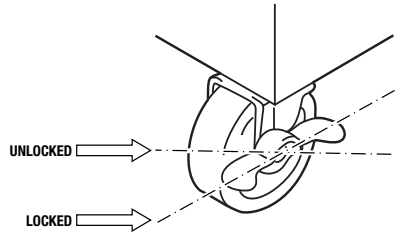

Install each cool air outlet duct using 4 screws each as shown.

**NOTE:** Do not overtighten the screws when installing the cool air outlet ducts. This could damage the base on the cool air outlet duct assembly.

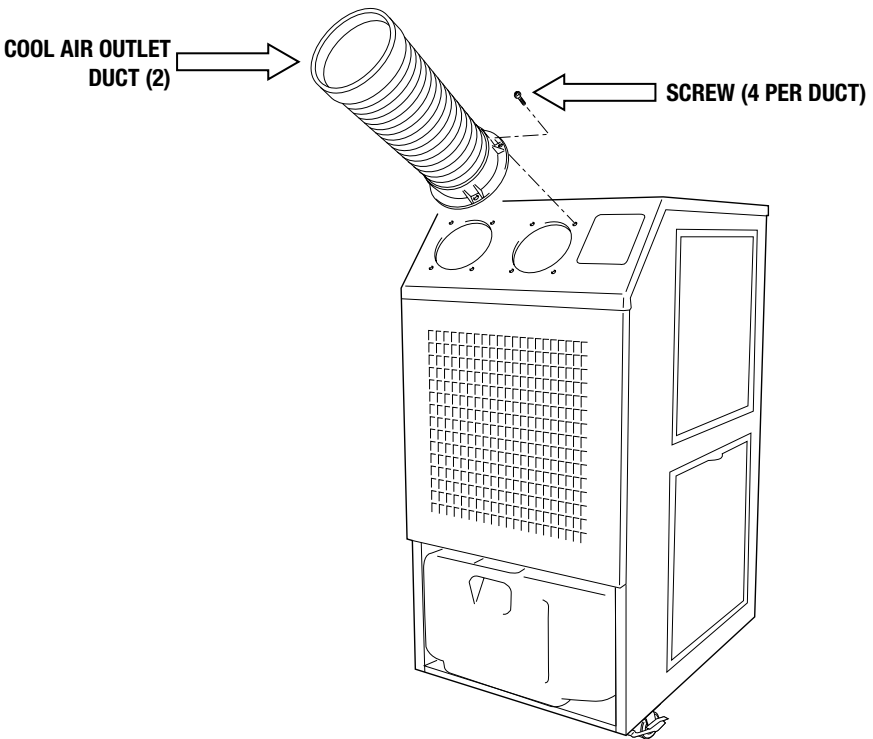

# INSTALLATION

## Choosing and Installation Site

**⚠CAUTION: Following are some precautions to consider before choosing your installation site. Please review carefully as improper installation may result in personal injury or damage to the unit.**

- Do not use the unit in areas where leakage of flammable gas may occur.
- Do not use the unit in areas where it will be exposed to rain or water.
- Do not use the unit in an atmosphere of excessively corrosive gas or vapor.
- Do not use in areas where the temperature is outside the allowable operating range.
- Do not install the unit in sloping areas. The unit may move or topple over even if the caster levers are set to LOCKED.
- Install the unit in areas that can withstand the weight of the unit. The Classic Plus 14 unit weighs approximately 200 lbs (91 kg) and the Classic Plus 26 unit weighs about 280 lbs (127 kg) (when the drain tank is full of water).
- Allow 18 inches of unobstructed airflow for both air inlets and outlets.
- Do not use the unit above 113°F 50% RH.

# INSTALLATION (cont.)

## Moving the Unit

Unlock the casters and push the MovinCool unit from the front panel edge to a flat, level surface and set the casters back to the LOCKED position.

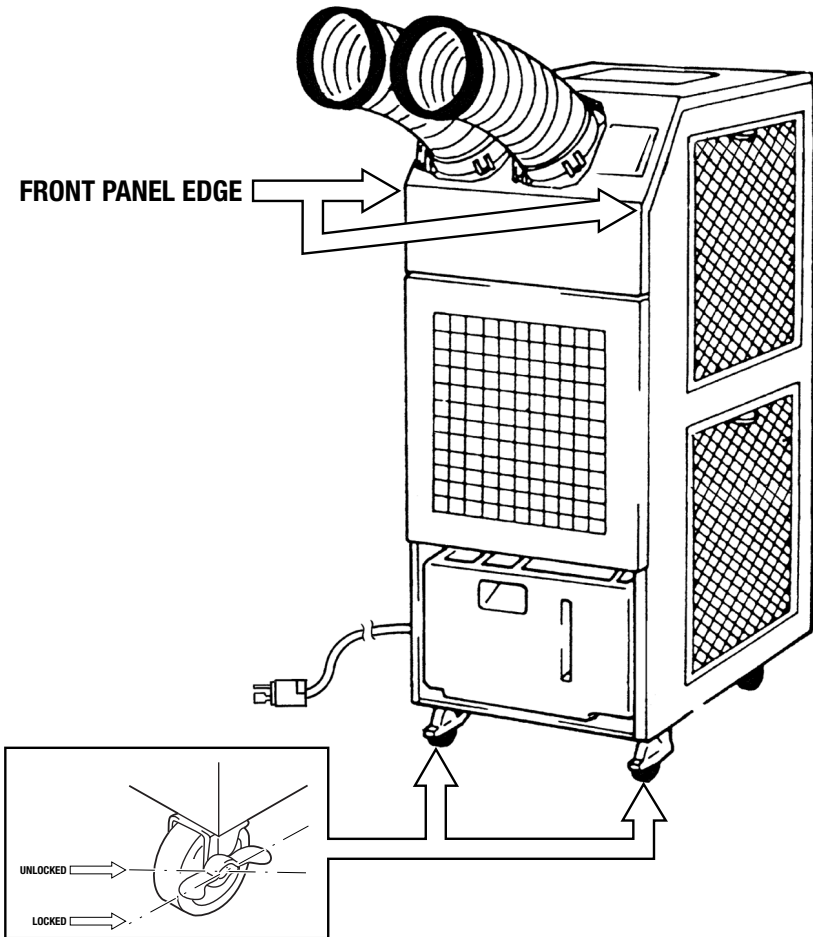

# INSTALLATION (cont.)

## Plugging in the Unit

- Check the prongs and surface of the power cord plug for dust/dirt. If dust and/or dirt are present, wipe off with a clean, dry cloth.
- Check the power cord, plug and prongs for damage or excess play. If any damage or excess play is found, contact your MovinCool reseller for repair.
- For the Classic Plus 26 model, fully insert plug into the A/C outlet and rotate clockwise until it locks in place.

### **⚠WARNING:**

- **If the power cord or plug is damaged, repair should only be performed by qualified electrical personnel.**
- **Do not connect/disconnect the power cord or attempt to operate buttons with wet hands. This could result in electrical shock.**

### **⚠CAUTION:**

- **Classic Plus 14 model ONLY: The AC outlet (115 VAC Single Phase, 60Hz) needs to be rated at 15A or higher. Do not share the outlet with any other instrument or equipment.**
- **Classic Plus 26 model ONLY: The AC outlet (208/230 VAC Single Phase, 60Hz) needs to be rated at 20A or higher. Do not share outlet with any other instrument or equipment.**

### **NOTE:**

- ***Make sure the AC outlet is free of dirt, dust, oil, water, or any other foreign matter.***
- ***The Classic Plus 14 model is equipped with an approved NEMA plug configuration (L5-15). the appropriate outlet must be used for this plug type.***
- ***The Classic Plus 26 model is equipped with an approved NEMA plug configuration (L6-20). The appropriate outlet must be used for this plug type.***

# FEATURES

## Both models feature:

- An electronic control panel which allows the user to control the unit's operation easily.
- Dual fan speeds (either High or Low) in both **COOL** and **Fan Only** modes.
- A digital display that indicates the temperature SET POINT (either Fahrenheit or Celsius) in which the COOL Mode will operate. This is also the local temperature the unit will try to maintain. The Temperature Set Point can be adjusted by the SET TEMP buttons (▼/▲).
- A condensate drain TANK FULL indicator display (LED).
- An automatic restart feature when the power is lost and regained. The unit will return to the operating mode and temperature SET POINT it was in prior to the loss of power.

# OPERATION

## Control Panel

Before operating the unit, it is important to familiarize yourself with the basic controls located on the control panel.

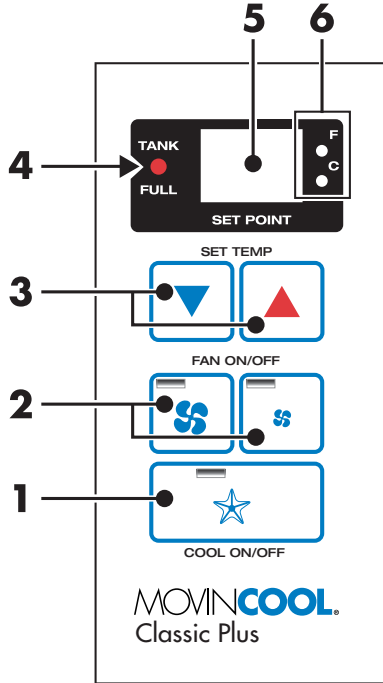

- |   |                        |  |
|---|------------------------|--|
| ① | COOL ON/OFF Button     | Activates/deactivates the <b>COOL</b> mode/ turns the unit off.                        |
| ② | FAN ON/OFF Buttons     | Activates/deactivates the <b>HIGH</b> or <b>LOW</b> fan mode.                          |
| ③ | SET TEMP Buttons (▼/▲) | Increases/decreases the temperature set point.   |
| ④ | <b>TANK FULL</b> LED   | Flashes when the drain tank is full.   |
| ⑤ | SET POINT Display      | Indicates the current temperature set point.   |
| ⑥ | Temperature Scale LED  | Illuminates to indicate the current temperature being displayed is either in °C or °F. |

## **OPERATION (cont.)**

### **Operating in COOL Mode**

The unit can be operated in COOL mode by pressing the COOL ON/OFF button (LED illuminates).

**NOTE: In COOL mode the unit can only be turned off by pressing the COOL ON/OFF button again, not by pressing the fan buttons.**

- ① Change the fan speed by pressing the HIGH or LOW fan buttons.
- ② Change the temperature set point by pressing the SET TEMP buttons (▼/▲).

**NOTE: When turning the unit on, the temperature set point and fan speed are determined by the last operating mode.**

### **Operating in Fan Only Mode**

- ① The unit can also be operated in Fan Only mode by pressing either the HIGH or LOW fan buttons (LED illuminates).
- ② The unit can then be turned off by pressing the fan speed button that is illuminated.

### **Changing from Fan Only Mode to COOL Mode**

The COOL mode can be activated while the unit is operating in Fan Only mode. To do this, simply press the COOL ON/OFF button (LED illuminates).

**NOTE: The Fan Only mode will not operate after the COOL mode has been activated. After the COOL mode has been activated, the unit cannot be turned off by pressing the fan buttons. The COOL ON/OFF button must be pressed.**



# OPERATION (cont.)

## Operating Modes

Both Classic Plus models operate in 2 modes, **FAN Only** and **COOL**. When in **FAN Only** mode the unit circulates the surrounding air. When in **COOL** mode, the compressor is engaged and cool air is circulated.

### ■ **COOL Mode**

Both models will operate in FAN Only mode for approximately 120 seconds before the compressor engages (*compressor time delay program is  $120 \pm 10$  seconds*).

### ■ **Temperature Control**

The room temperature thermistor allows the unit to switch automatically between COOL and FAN Only modes. This is dependent upon inlet air temperature versus SET POINT temperature.

### ■ **Fan Mode Control DIP Switch**

The Fan Mode Control DIP Switch determines whether the FAN will continue to operate or stop when the compressor cycles off. (SET POINT temperature equals inlet air or room temperature.) The unit has been preset at the factory for continuous fan operation.

### ■ **Temperature Scale Display DIP Switch**

The Temperature Scale Display DIP Switch changes the SET POINT temperature that is displayed to either °C or °F. The unit has been preset from the factory to display the SET POINT temperature in °F.

**NOTE: If you wish to change the fan mode operation (COOL ⇌ OPERATE to COOL ⇌ STOP), and/or the Temperature Scale Display (°F to °C), contact your MovinCool reseller.**

## OPERATION (cont.)

### Emptying the Drain Tank

During **COOL** mode, condensate will accumulate in the drain tank. When the drain tank becomes full, the **FULL TANK** LED will flash and the unit will shut off automatically.

**NOTE: If you want to empty the drain tank, while the unit is in operation, press the COOL ON/OFF button to turn the unit off.**

① Pull the drain tank from the unit.

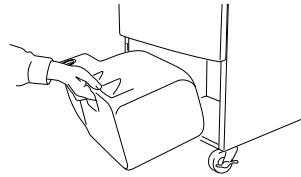

② Remove the cap and empty the drain tank.

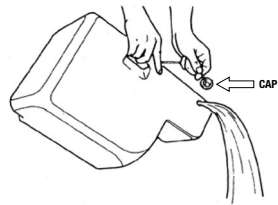

③ Replace the cap and return the drain tank to the unit.

④ Press the COOL ON/OFF or FAN ON/OFF button to restart the unit.

# OPERATION (cont.)

## DRAIN PUMP KIT (Optional) (Classic Plus 14 model ONLY)

A drain pump kit (CPK-3) is available to allow continuous operation and to eliminate the need for a drain tank.

- When the water collects to level (A) in the pump reservoir, the drain pump begins to operate and discharge the water.

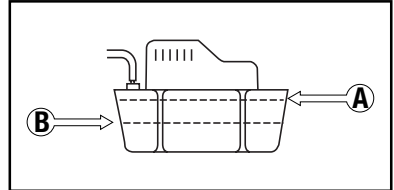

**NOTE: The compressor will not operate while the drain pump is discharging water.**

- When the water level drops below level (B), the drain pump stops, and the compressor will restart.

**NOTE: If for any reason the water level exceeds that of level (A) in the pump reservoir, an overflow Drain Switch will stop the compressor operation.**

**NOTE: If the Fan Mode Control DIP Switch (see pg. 11) is set to the STOP position, the entire unit (including fan operation) will turn off whether due to the overflow Drain Switch or while the drain pump is discharging water.**

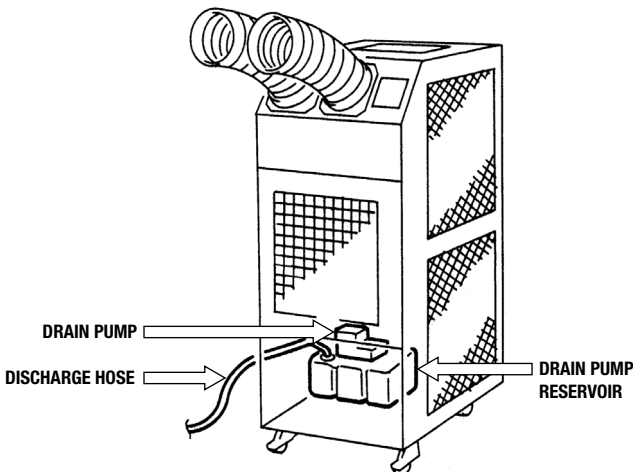

# OPERATION (cont.)

## DRAIN PUMP KIT (Optional) (Classic Plus 26 model ONLY)

A drain pump kit (CPK-4) is available to allow continuous operation and to eliminate the need for a drain tank.

- When the water collects to level (A) in the pump reservoir, the drain pump begins to operate and discharge the water.

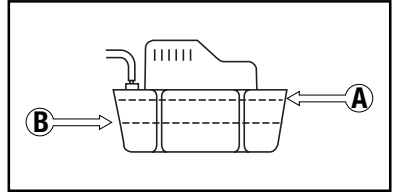

- When the water level drops below level (B), the drain pump stops, and the compressor will restart.

**NOTE:** If for any reason the water level exceeds that of level (A) in the pump reservoir, an overflow Drain Switch will stop the compressor operation.

**NOTE:** If the Fan Mode Control DIP Switch (see pg. 11) is set to the STOP position, the entire unit (including fan operation) will turn off due to the overflow Drain Switch.

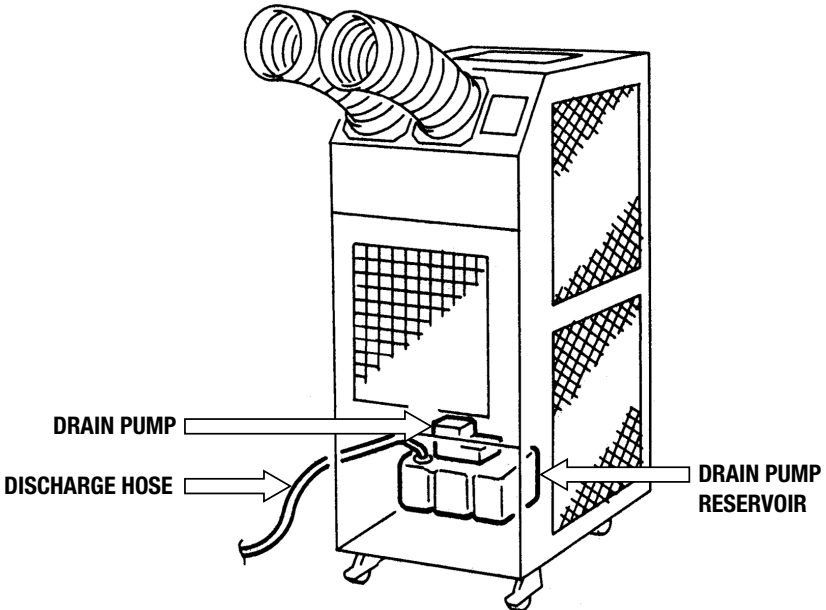

# DAILY INSPECTION & MAINTENANCE

## Emptying the Drain Tank

To empty the drain tank, refer to instructions on page 12.

## Cleaning the Air Filters

Clean the air filters once a week. If the unit is used in a dusty environment, more frequent cleaning may be required.

A dirty air filter reduces air output resulting in a decrease in cooling capacity.

### Filter Removal Method (both models)

- ① Turn the unit off, by pressing the COOL ON/OFF button.
- ② Remove the 3 air filters.

**NOTE:** To remove the side air filters, lift upward, then pull outward from the bottom. To remove the front panel air filter, pull out top corners, then lift upward.

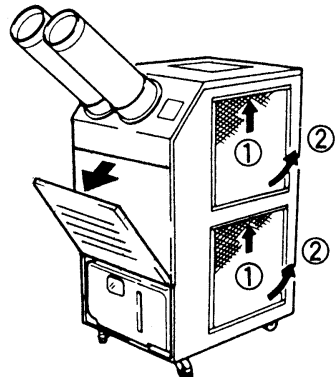

- ③ Remove the element from each filter.

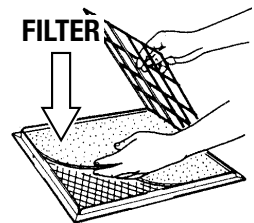

### Filter Element Cleaning Method (both models)

- ① Remove dust from the element with a vacuum cleaner, or rinse in cold or luke-warm water. If the element is extremely dirty, wash with a neutral detergent.
- ② After the element has been cleaned, rinse with clean running water, allow to dry, then reinstall.

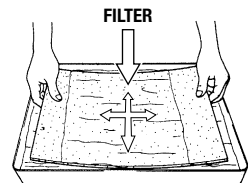

# DAILY INSPECTION & MAINTENANCE (cont.)

## In-Season/Off-Season Inspection & Maintenance

### ■ *In-Season*

- ① Check the prongs and surface of the power cord plug for dust and/or dirt. If dust and/or dirt are present, wipe off with a clean, dry cloth.
- ② Check the power cord, plug and prongs for damage or excess play. If any damage or excess play is found, contact your MovinCool reseller for repair.
- ③ Check the air filters and drain tank.
- ④ Clean the outside of the unit(s) with a damp cloth or mild nonabrasive cleaner.

### ■ *Off-Season*

- ① Operate the unit in Fan Only mode for 8 hours.

### ***NOTE: Operation is necessary to dry out the inside of the unit.***

- ② Disconnect the power cord from the AC outlet.
- ③ Check the prongs and surface of the power cord plug for dust and/or dirt. If dust and/or dirt are present, wipe off with a clean, dry cloth.
- ④ Check the power cord, plug and prongs for damage or excess play. If any damage or excess play is found, contact your MovinCool reseller for repair.
- ⑤ Clean the air filters.
- ⑥ Empty all water from the drain tank.

# TROUBLESHOOTING

## Self-Diagnostic Codes

Self-Diagnostic Codes will be displayed on the Control Board under the following conditions:

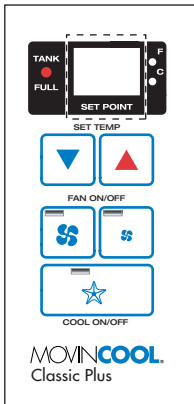

### Code   Condition

- dF    When the evaporator thermistor disengages the compressor.
- FL    When the drain tank switch shuts off the unit (**FULL TANK LED** flashes).
- AS    When unit disengages the compressor while the condensate pump is discharging water.
- HP    When the high pressure switch disengages the compressor.

Check the following points before calling a qualified technician.

SYMPTOM	POSSIBLE CAUSE	REMEDY
<i>Unit does not operate</i>	<ol style="list-style-type: none"> <li>① Ground fault breaker blown</li> <li>② Drain tank is full (<b>FULL TANK LED</b> will be flashing)</li> </ol>	<ul style="list-style-type: none"> <li>Reset breaker</li> <li>Empty the drain tank</li> </ul>
<i>Insufficient cooling</i>	<ol style="list-style-type: none"> <li>① Dirty/blocked air filters</li> <li>② Air inlet/outlet blocked</li> <li>③ Improper temperature setting</li> </ol>	<ul style="list-style-type: none"> <li>Clean air filters</li> <li>Clear air inlet/outlet</li> <li>Set to desired position</li> </ul>

If symptoms persist after the above actions have been taken, turn the unit off, disconnect the power cord plug and contact your MovinCool reseller.

# TECHNICAL SPECIFICATIONS

ITEM/FEATURES	MODEL	
	Classic Plus 14	Classic Plus 26
<b>Rating Conditions</b> <i>dry bulb</i> <i>wet bulb</i> <i>humidity</i>	95°F (35 °C) 83°F (28.3 °C) (60%)	95°F (35 °C) 83°F (28.3 °C) (60%)
<b>Specifications</b> <i>power frequency</i> <i>line voltage, single phase</i> <i>power consumption</i> <i>current consumption</i> <i>power factor</i> <i>starting current</i> <i>power cord</i>	60Hz 115 V 1.41 Kw 12.3 Amps 95% 32A 14 (3-core) AWG	60Hz 208/230V 3.37/3.24 Kw 16.8/14.6 Amps 97% 62A 12 (3-core) AWG
<b>Cooling Unit</b> <i>cooling capability</i>  <i>cooling system</i>	3,300 Kcal/hr 13,200 BTU/hr <i>direct expansion</i>	6,500 Kcal/hr 26,000 Btu/hr <i>direct expansion</i>
<b>Blower</b> <i>type of fan</i> <i>air volume: Evaporator (high speed)</i> <i>Condenser (high speed)</i> <i>motor output: (high speed)</i> <i>(low speed)</i>	<i>centrifugal fan</i> 470 ft <sup>3</sup> /min; 798 m <sup>3</sup> /h 882 ft <sup>3</sup> /min; 1498 m <sup>3</sup> /h 0.24 Kw 0.19 Kw	<i>centrifugal fan</i> 708 ft <sup>3</sup> /min; 1202 m <sup>3</sup> /h 1680 ft <sup>3</sup> /min; 2853 m <sup>3</sup> /h .59/.63 Kw .54/.56 Kw
<b>Compressor</b> <i>type</i> <i>output</i> <i>refrigerant type</i> <i>refrigerant capacity</i>	<i>rotary</i> 0.8 Kw R-22 1.50 lbs (0.68 kg)	<i>hermetic scroll</i> 1.6kw R-22 1.87 lbs. (0.85 kg)
<b>Safety Devices</b> <i>compressor overload protector</i> <i>fan motor protector</i> <i>anti-freezing thermistor</i> <i>full drain tank switch</i> <i>automatic restart (power interruption)</i> <i>compressor time delay program</i>	<i>included</i> <i>included</i> <i>included</i> <i>included</i> <i>included</i> <i>included</i>	<i>included</i> <i>included</i> <i>included</i> <i>included</i> <i>included</i> <i>included</i>
<b>Dimensions &amp; Weight</b> <i>W x D x H (in.)</i> <i>W x D x H (mm)</i> <i>weight (lbs/kg)</i>	19.4 x 26.5 x 41.5 492 x 673 x 1054 165/75	19.4 x 28.7 x 47.2 492 x 730 x 1200 235/107
<b>Operating Conditions</b> <i>inlet air (relative humidity)</i>	113°F (45 °C), ≤ 50% 70°F (21.1 °C), ≥ 50%	113°F (45 °C), ≤ 50% 70°F (21.1 °C), ≥ 50%
<b>Control Device</b> <i>temperature control</i> <i>two speed fan</i>	<i>included</i> <i>included</i>	<i>included</i> <i>included</i>



# LIMITED WARRANTY

DENSO SALES CALIFORNIA, INC. ("DENSO") warrants its MOVINCOOL Products only to the extent stated in its official written warranties. Unless otherwise specifically provided in writing by DENSO, DENSO warrants to end-user that the Products shall be free of defects in materials or workmanship and will function in accordance with DENSO's published specifications under ordinary intended use and service for a period of twelve (12) months after delivery to the end-user; provided, however, in the case of the compressor element of the Products such warranty shall be for a period of thirty six (36) months after delivery to the end-user. DENSO shall, at its sole option, repair or replace any defective Product covered by this warranty. Such remedy shall be end-user's sole remedy with respect to any particular defect in the Products.

This warranty does not cover defects or malfunctions which result from causes beyond DENSO's control, including, without limitation, (i) unusual physical or electrical stress; (ii) accident, neglect, abuse, misuse or other abnormal use; (iii) failure to perform routine maintenance in accordance with DENSO'S recommended procedures; (iv) normal wear and tear; (v) repairs or attempted repairs by an unauthorized person; (vi) modifications or alterations to the Products; (vii) use with supplies or devices not supplied or approved by DENSO; or (viii) improper servicing. This warranty shall extend only to the original end-user and shall be void if any labels or other identifying marks permanently affixed to Products when shipped by DENSO are removed, altered, defaced or obliterated.

The aforesaid warranty is the only warranty made by DENSO with respect to the Products and is in lieu of all obligations or liabilities on the part of DENSO for damages arising out of or in connection with the sale, use or performance of the Products, including, without limitation, any lost profits or any other consequential, incidental, special or exemplary damages of any kind. DENSO DISCLAIMS ALL OTHER WARRANTIES WITH REGARD TO THE PRODUCTS, INCLUDING ALL IMPLIED WARRANTIES OF MERCHANTABILITY AND FITNESS FOR USE. THERE ARE NO WARRANTIES WHICH EXTEND BEYOND THE DESCRIPTION CONTAINED HEREIN.

**PURCHASE DATE:** \_\_\_\_\_

**SERIAL NUMBER:** \_\_\_\_\_

⇓ DETACH HERE ⇓

## MOVINCOOL. REGISTRATION CARD

### OWNER INFORMATION

Company \_\_\_\_\_  
 Contact \_\_\_\_\_  
 Title \_\_\_\_\_  
 Address \_\_\_\_\_  
 City/State/Zip \_\_\_\_\_  
 Phone \_\_\_\_\_ FAX \_\_\_\_\_  
 E-Mail \_\_\_\_\_

Date of Purchase \_\_\_\_\_

Model No. (check one)

- Classic 10
- Classic 18
- Classic 40
- Classic 60
- Classic Plus 14
- Classic Plus 26
- Office Pro 10
- Office Pro 12
- Office Pro 18
- Office Pro 24
- Office Pro 60

Serial No. (on side panel) \_\_\_\_\_

**DEALER NAME** \_\_\_\_\_

**DEALER LOCATION** \_\_\_\_\_

### What is your type of business?

- Banking/Finance
- Education
- Government/Military
- Hospital/Healthcare
- Restaurant/Foodservice
- Sales/Marketing
- Manufacturing-plastics
- Manufacturing-metals
- Manufacturing-paper/wood products
- Manufacturing-electronics/electrical components
- Manufacturing-other
- Utility

### How did you first hear about MovinCool?

- Magazine Ad
- Magazine Article
- Direct Mail
- Postcard Deck
- Trade Show
- Referral
- Other \_\_\_\_\_

### What factors most influenced your decision to purchase a MovinCool?

- Product Quality
- Price
- Portability
- Ease of Installation
- Energy Savings
- Versatility

### Have you previously purchased a MovinCool?

- Yes
- No

If yes, how many units do you own? \_\_\_\_\_

### What is the primary use for this unit?

- Cooling people
- Cooling equipment
- Cooling a process
- Other \_\_\_\_\_

### Where is the unit used?

- Office
- Manufacturing or Warehouse
- Hospital/Laboratory
- Computer/Equipment Room
- Kitchen/Laundry
- Special Events/Outdoors
- Other \_\_\_\_\_

**Comments** \_\_\_\_\_

# **DENSO**

**DENSO SALES CALIFORNIA, INC.**

3900 Via Oro Avenue  
Long Beach CA 90810-1868  
800-264-9573 / 310-834-6352  
[www.movincool.com](http://www.movincool.com)

Technical Services Department  
DSCA P/N: LA990009-1217  
GAC P/N: LA484007-1431

Fourth Issue: April 2003  
Printed in the U.S.A.

## **BUSINESS REPLY MAIL**

FIRST-CLASS MAIL PERMIT NO. 8390 LONG BEACH, CA

POSTAGE WILL BE PAID BY ADDRESSEE

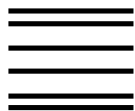

NO POSTAGE  
NECESSARY  
IF MAILED  
IN THE  
UNITED STATES

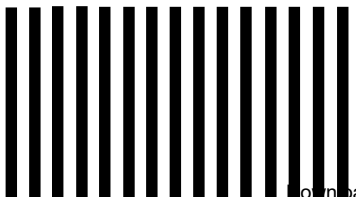

**MOVINCOOL**<sup>®</sup>

Pioneering New Solutions With Portable Air-Conditioning

DENSO SALES CALIFORNIA, INC.  
3900 VIA ORO AVENUE  
LONG BEACH CA 90810-9969

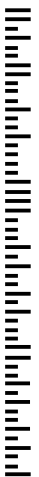

## Free Manuals Download Website

<http://myh66.com>

<http://usermanuals.us>

<http://www.somanuals.com>

<http://www.4manuals.cc>

<http://www.manual-lib.com>

<http://www.404manual.com>

<http://www.luxmanual.com>

<http://aubethermostatmanual.com>

Golf course search by state

<http://golfingnear.com>

Email search by domain

<http://emailbydomain.com>

Auto manuals search

<http://auto.somanuals.com>

TV manuals search

<http://tv.somanuals.com>