

Platinum Spot 5R

Elation Professional
6122 S Eastern Ave
Los Angeles, Ca 90040
www.elationlighting.com

CONTENTS

1. General Information.....	4
a. Introduction.....	4
b. Unpacking.....	4
c. Customer Support.....	4
d. Warranty Registration.....	5
e. Discharge Lamp Warning.....	5
2. Safety Instructions.....	7
3. Features.....	9
4. General Guidelines.....	10
5. Fixture Overview.....	11
6. Lamp Installation.....	14
a. Lamp Protection Circuitry.....	14
b. Lamp installation.....	15
c. Lamp optimization.....	16
7. Mounting and Installation.....	17
a. Mounting Positions.....	17
b. Mounting Points.....	18
c. Securing.....	19
8. Understanding DMX.....	20
a. DMX Cable Requirements.....	20
b. DMX Terminator.....	21
c. 3-Pin to 5-Pin Conversion.....	21
d. DMX Addressing.....	22
9. Fixture Menu.....	24
10. DMX Addressing.....	36
11. Operation.....	38
12. Working with Built-In Programs.....	40
13. DMX Channel Traits.....	43
a. DMX Channel Values.....	43
14. Error Codes.....	48
15. Cleaning and Maintenance.....	51
16. Photometric Data.....	52
17. Gobo Patterns.....	53
18. Dimensional Drawings.....	54
19. Circuit Schematic.....	55
20. Technical Specifications.....	56
21. Warranty.....	58

1. GENERAL INFORMATION

INTRODUCTION: Congratulations, you have just purchased one of the most innovative and reliable lighting fixtures on the market today! The Platinum Spot 5R™ has been designed to perform reliably for years when the guidelines in this booklet are followed. Please read and understand the instructions in this manual carefully and thoroughly before attempting to operate this unit, this fixtures uses a unique lamp that has very specific guidelines that must be strictly followed. These instructions contain important information regarding safety during use and maintenance.

UNPACKING: Thank you for purchasing the Platinum Spot 5R™ by Elation Professional®. Every Platinum Spot 5R™ has been thoroughly tested and has been shipped in perfect operating condition. Carefully check the shipping carton for damage that may have occurred during shipping. If the carton appears to be damaged, carefully inspect your unit for damage and be sure all accessories necessary to operate the unit have arrived intact. In the event damage has been found or parts are missing, please contact our customer support team for further instructions. Please do not return this unit to your dealer without first contacting customer support at the number listed below.

CUSTOMER SUPPORT: Elation Professional® provides a customer support line, to provide set up help and to answer any question should you encounter problems during your set up or initial operation. You may also visit us on the web at www.elationlighting.com for any comments or suggestions. For service related issue please contact Elation Professional®. Service Hours are Monday through Friday 8:00 a.m. to 5:00 p.m. Pacific Standard Time.

Voice: (323) 582-3322

Fax: (323) 832-9142

E-mail: support@elationlighting.com

Forum: www.ElationLighting.com/forum

Warning! To prevent or reduce the risk of electrical shock or fire, do not expose this unit to rain or moisture.

Caution! There are no user serviceable parts inside this unit. Do not attempt any repairs yourself, doing so will void your manufactures warranty.

Please do not discard the shipping carton in the trash. Please recycle whenever possible.

WARRANTY REGISTRATION: The Platinum Spot 5R™ carries a two-year (730 days) limited warranty. Please fill out the enclosed warranty card to validate your purchase. All returned service items whether under warranty or not, must be freight pre-paid and accompany a return authorization (R.A.) number. The R.A. number must be clearly written on the outside of the return package. A brief description of the problem as well as the R.A. number must also be written down on a piece of paper and included in the shipping container. If the unit is under warranty, you must provide a copy of your proof of purchase invoice. Items returned without a R.A. number clearly marked on the outside of the package will be refused and returned at customer's expense. You may obtain a R.A. number by contacting customer support at (323) 582-3322.



Important: Damages caused by the disregard of the instructions in this user manual are not subject to warranty.

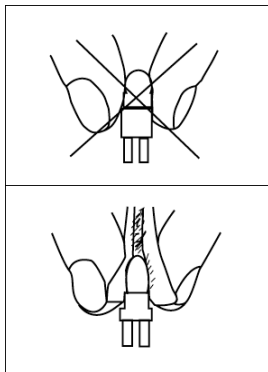

DISCHARGE LAMP WARNING: This fixture is fitted with a discharge lamp, which is highly susceptible to damage if improperly handled. Never touch the lamp with your bare hands, as the oil from your hands will shorten lamp life. Also, never move the fixture until the lamps have had ample time to cool. Remember, lamps are not covered under warranty conditions.

Lamp Replacement: *Please note that due to the nature of the Platinum 5RLamp and the optical path of the Platinum Spot 5R it is imperative to replace the lamp at the rated 2000 hour lamp life!*

UV RADIATION: This fixture emits intense UV radiation, which is harmful to the eyes and skin. The intense luminance of the lamp can cause severe damage to the retina. Never operate this fixture with the protective covers removed, these covers have been specially designed to shield against UV radiation.

Epileptic Warning: *Those suffering from epilepsy should avoid looking directly into the lamp at all times.*

Avoid switching the fixture on and off repeatedly in short intervals, as this will reduce lamp life and intensity.

To achieve the intensity associated with discharge lamps, these lamps use a gas sealed in a high-pressure environment to emit a brilliant output. Due to the high pressure involved with the construction of the lamp, the lamp may explode during prolonged extensive use. This risk is increased with age; added care is encouraged when dealing with older lamps. Thus, lamp should always be replaced at the end of their recommended duty cycle. Extreme caution should be used when operated this or any fixture fitted with a gas discharge lamp.

Never open this fixture while in use!

During the initial operation of this fixture, a light smoke or smell may emit from the interior of the fixture. This is a normal process and is caused by excess paint in the interior of the casing burning off from the heat associated with the lamp and will decrease gradually over time.

This device falls under protection-class 1. Therefore it is essential that the device be grounded properly.

All electrical connections should be performed by a qualified electrician.

Be sure the available voltage matches the voltage requirements of the unit.

Be sure the power cord is never crimped or damaged. If the power cord is damaged, replace it immediately with a new one of similar power rating.

Always disconnect from main power before performing any type of service or any cleaning procedure.

Only handle the power cord by the plug. Never pull out the plug by tugging the wire portion of the cord.

This fixture is designed for use indoors. Use of this fixture outdoors will void the manufactures warranty.

Please be aware that damages caused by manual modifications to the device are not subject to warranty.

2. SAFETY INSTRUCTIONS



The Platinum Spot 5R™ is an extremely sophisticated piece of electronic equipment. To guarantee a smooth operation, it is important to follow the guidelines in this manual. Elation will not accept responsibility for damages resulting from the misuse of this fixture due to the disregard of the information printed in this manual.

1. Always be sure that the fan and the air inlets remain clean and are never blocked. Allow about 6" (15cm) between this fixture and other devices or a wall to allow for proper cooling.
2. Never touch the fixture during normal operation. This can cause severe personnel injuries and/or damage to the fixture.
3. Be sure to unplug the Platinum Spot 5R™ from the power outlet before performing any service related issues.
4. Lamp Replacement; Allow at least 15 minutes after disconnecting main power before you open the Platinum Spot 5R™. To prevent personal injury, never touch the lamp if you are not absolutely sure it has cooled.
5. Never look directly into the lamp beam. You risk injury to your retina, which may induce blindness.
6. Be sure to track and record the lamp running time. The lamp should be changed at the end of the specified lamp life, regardless of lamp output. You may also have to change the lamp if it shows any deformations or damage. The same is with all glass components, color filters, lenses and mirrors.
7. For safe operation, follow the Installation guide described in chapter two of this manual. Operating the Platinum Spot 5R™ without suited safety aids such as safety cables or clamps can increase the risk of damage and/or personal injury.
8. Only qualified and certified personnel should perform installation.
9. When mounting this fixture, use only the original rigging parts included with this fixture. Any structural modification will void the original manufactures warranty and

may increase the risk of damage and/or personal injury.

10. To reduce the risk of fire or shock, do not expose this fixture to rain or moisture.
11. Do not attempt to operate this fixture if the power cord has become damaged or frayed.

Important Notice: Damages resulting from the disregard of safety and general user instructions found in this user manual are not subject to any warranty claims.



CAUTION!

Never touch the device during operation!
The housing may heat up



CAUTION!

Never look directly into the light source,
as sensitive persons may suffer an epileptic shock.

3. FEATURES

- Pan 540° or 630° (User selectable) / Tilt 270°
- 3 operation mode: DMX controlled, stand alone, or sound activated
- 8 user colors plus white (including UV filter)
- User selectable color change modes (mode 1: full colors, mode 2: split-colors)
- Two Gobos Wheels:
 - Wheel 1: Rotating gobo wheel with 8 gobos plus open, all gobos can be easily replaceable and gobo indexing
 - Wheel 2: Static/Fixed gobo wheel with 14 gobos plus open
- Strobe effect: 0~13 flashes per second or random strobe
- Prism and prism rotation, with 16 prism macros
- Frost Filter for Soft and Hard Edge Spot
- Bright Phillips Platinum 5R Lamp (160w / 8000K / 2000Hrs / 7950Lm)
- Dimmer intensity from 0%~100%
- Electronic Power Supply (120v/60Hz)
- Control board with full color LCD graphic display and foil touch keyboard
- RDMX (Remote DMX addressing from any DMX console)
- Auto test for all functions
- Automatic Pan/Tilt Correction
- Built-in Iris (5% ~ 100%), with Iris Pulse Effect
- Glass Dichroic Reflector for Even Lamp Output
- Anti-Reflective Coated Lenses
- USITT DMX-512 Complaint (3-pin and 5-pin DMX Connections)
- Electronic Focus via DMX
- Upgradable Firmware via Elation “E-Loader”
- 7 User Assignable Program Presets - Internal Program: Edit and save programs to the incorporated EEPROM. Maximum of 64 scenes.

4. GENERAL GUIDELINES

This fixture is a professional lighting effect designed for use on stage, in nightclubs, in theatres, etc. Do not attempt operation or installation without a proper knowledge on how to do so.

This fixture was designed for indoor use only.

Consistent operational breaks may ensure that the fixture will function properly for many years to come.

Do not shake the fixture around. Avoid brute force when installing or operating the device.

While choosing an installation location, please be sure that the fixture will not be exposed to extreme heat, moisture or dust. The minimum distance between the fixture and a wall or flat surface should be at least 0.5 meter (about 1.5ft).

Always install the fixture with an appropriate safety cable. When installing the fixture in a suspended environment always be sure to use mounting hardware no less than M10 x 25 mm, also be sure the hardware is insert in the pre-arranged screw holes in the base of the fixture.

When using the quick release “Omega” cam-lock system, be sure the four quick lock fasteners are locked in the quick lock holes correctly.

Do not attempt to operate this fixture until you have familiarized yourself with its functions.

Do not permit operation by persons not qualified for operating this type of theatrical fixture; most damages are the result of operations by nonprofessionals.

Please use the original packaging to transport the fixture in for service.

5. FIXTURE OVERVIEW

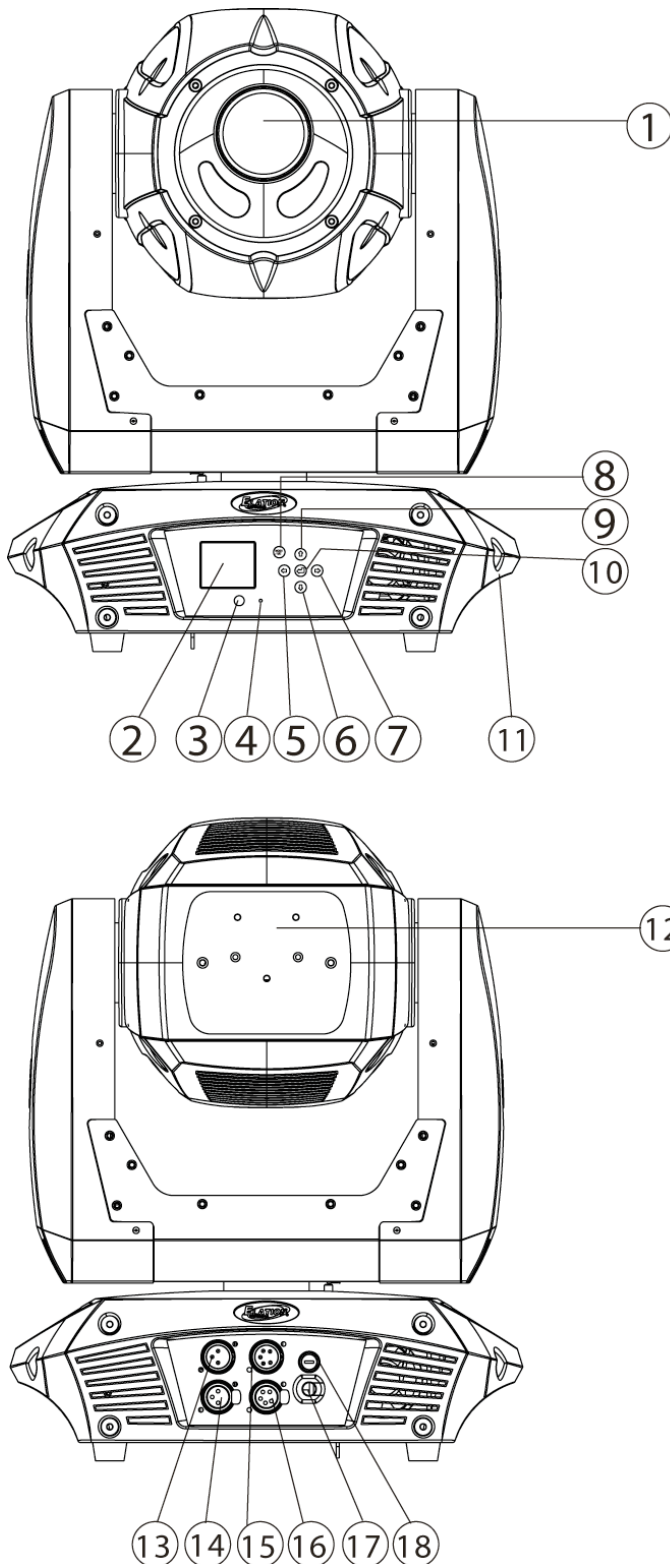

- 1: Lens
- 2: Display
- 3: DC Switch
- 4: Microphone
- 5: Left Button
- 6: Down Button
- 7: Right Button
- 8: Mode/Esc Button
- 9: Up Button
- 10: Enter Button
- 11: Handle
- 12: Lamp Access Panel
- 13: 3-Pin DMX in
- 14: 3-Pin DMX out
- 15: 5-Pin DMX in
- 16: 5-Pin DMX out
- 17: Power Cord
- 18: Fuse

1. **Lens** – Main output lens.
2. **LED Menu Display** – Full color animated menu display.
3. **DC Switch** - Controls menu and display power when the unit is disconnected from main power.
4. **Microphone** – This microphone receives external low frequencies to trigger the unit in Sound-Active mode. This microphone is designed to receive low frequency sounds only, tapping on the microphone and high pitch sounds may not trigger the unit.
5. **Left Button** – This button is used to toggle through the menu display.
6. **Down Button** – The down button is used to toggle down or back through the menu functions and settings.
7. **Right Button** - This button is used to toggle through the menu display.
8. **Mode/Esc Button** - This button is used to access the menu functions.
9. **Up Button** – The up button is used to toggle forward through the menu functions and settings.
10. **Enter Button** – The enter button is used to enter in to a certain menu function or to lock a function into memory.
11. **Carrying Handle** – Please use this intergraded handled to move the fixture form location to location. Never carry the fixture by the head.
12. **Lamp Access Panel** – This panel provides access to the lamp and lamp socket assembly. Always allow ample time for the lamp to cool before attempting access to the lamp and lamp socket.

-
- 13. 3-PIN DMX Input Jack** – This jack accepts an incoming DMX signal via a male, 3-pin XLR jack.
 - 14. 3-Pin DMX Output Jack** – This jack is used to send an incoming DMX signal to the next fixture in the DMX chain via a female, 3-pin XLR jack.
 - 15. 5-PIN DMX Input Jack** – This jack accepts an incoming DMX signal via a male, 5-pin XLR jack.
 - 16. 5-Pin DMX Output Jack** – This jack is used to send an incoming DMX signal to the next fixture in the DMX chain via a female, 3-pin XLR jack.
 - 17. Power Cord** – Plug into an appropriate power outlet to provide main power to the fixture.
 - 18. Fuse Holder Assembly** – This assembly houses the 4amp GMA safety fuse. Always replace the fuse with an exact match unless otherwise specified by an authorized Elation Service Technician. Using a fuse other than that specified could seriously damage the unit and will void your manufactures warranty.

6. LAMP INSTALLATION INSTRUCTIONS

Installing or replacing the lamp

For a proper and safe lamp change, please read this chapter carefully and follow all instructions.

Lamp Protection Circuitry

Because of the nature of the extremely short gap of the Platinum 5R Lamp and the tight nature of the internal optical system it is imperative that the lamp be replaced every 2000 hours. This is done to protect the internal optical system as well as prevent accidental lamp explosion, which could lead to hot glass particles falling from the fixture. Failure to change the lamp within 300 hours of operation will result in automatic shut down of the fixtures electronics.

At 2000 hours the display will begin to flash “Replace The Lamp.” At this point the lamp has reached its’ maximum rated life and should be replaced immediately. The fixture will continue to operate for an additional 300 hours, however the “Replace the Lamp” warning will continue to flash. After 2300 hours the fixture will shut down after two minutes of operation. The fixture will continue to shut down every two minutes after main powered is applied until the lamp is replaced. To replace the lamp follow the safety guidelines and procedures below;

Safety Regulations

- ***Always replace lamp every 2000 hours.***
- Disconnect the unit’s main power supply.
- If you unit has been running, please allow the unit to cool for at least 10 minutes before attempting any type of service.
- Before the Platinum Spot 5R™ is put into operation be sure all covers have been replaced, otherwise you risk damage to the retina and expose to UV radiation!
- When replacing an old lamp, always be sure to replace with an approved replacement. In this case a Philips MSD Platinum 5R lamp is required. Be sure

the replacement lamp meets or exceeds the original lamp specifications, failure to do so may damage the fixture and void the manufactures warranty.

- Be sure to follow all the lamp handling procedures included with the new lamp. Never handle the new lamp with your bare hands as the oils from your skin may damage the lamp and cause premature lamp failure.

Installation Procedure:

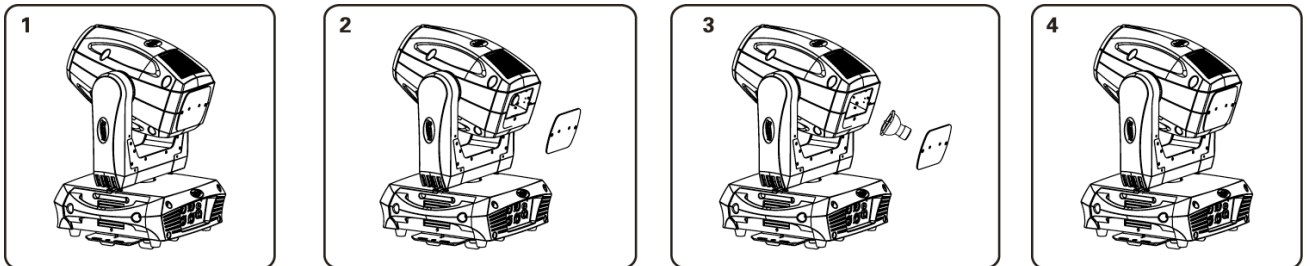

1. Set the fixture on a flat surface and remove the two screws marked “A” and “B”.
2. Remove the cover plate to access the lamp.
3. Gently remove the old lamp by grasping the ceramic socket base and twisting it slightly in counter-clockwise direction until it becomes free.
4. Once the lamp becomes free, grasp the ceramic socket and gently pull away from the lamp.
5. Insert the new lamp securely. The lamp will only seat one way, please be sure to insert the lamp in the same position as the old one. Before reassembling the unit, be sure the new lamp is securely seated in the lamp socket. Always be sure to only use specified lamp types! (Philips MSD Platinum 5R).
6. Once the lamp has been inserted and secured into the socket, follow the lamp optimization instructions outlined below, then lock the lamp cover back in to place by securing screws “A” and “B”.
7. Reset the lamp run time in the system menu. If the system run time is not reset the “Replace the Lamp” warning will continue to flash in the display and fixture will eventually shut down. To reset the lamp running time follow the procedures below;
 - A. Activate the menu by pressing the “Mode/Esc” button and toggle to “Information”

- B. Once at “Information” tap the “Enter” button and use the “Up” or “Down” buttons to toggle to “Time Information”
- C. Once at “Time Information” use either the “Up” or “Down” buttons to toggle to “L-Timer Password” and tap the “Enter” button. Then use the “Up” or “Down” buttons to enter the reset pass code, “038” and tap the “Enter” button once again. The display will automatically revert to “L-Timer Password,” next toggle down to “Clear Lamp Time”
- D. Once at “Clear Lamp Time” tap the enter button and select “ON.” The lamp timer has now been reset, use the “MODE/ESC” button to exit the menu and return to the home screen.

Lamp Optimization

Unlike traditional discharge lamps the Platinum 5R lamp does not require optimization. The lamp orientation and optimization procedure has been preset during the manufacturing process of the lamp.

Please remember that a MSD Platinum 5R lamp is not a hot-restrike lamp therefore, you must wait approximately 15 minutes before you can attempt to strike the lamp once it has been turned off.

7. MOUNTING AND INSTALLATION

Cautions:

For added protection mount the fixtures in areas outside walking paths, seating areas, or in areas where the fixture might be reached by unauthorized personnel.

Before mounting the fixture to any surface, make sure that the installation area can hold a minimum point load of 10 times the device's weight.

Fixture installation must always be secured with a secondary safety attachment, such as an appropriate safety cable.

Never stand directly below the device when mounting, removing, or servicing the fixture.



Caution!

When install the fixture be sure there is no highly inflammable material within a distance of 1.5 feet

Mounting

The Platinum Spot 5R™ is fully operational in two different mounting positions, hanging upside-down from a ceiling, or set on a flat level surface (see illustration on next page). Be sure this fixture is kept at least 0.5m away from any flammable materials (decoration etc.). Always use and install the supplied safety cable as a safety measure to prevent accidental damage and/or injury in the event the clamp fails.



Refer to regulations BGV C1 (formerly VBG 70) and DIN VDE0711-217 for proper installation in Europe To ensure proper installation, only qualified staff should attempt installation.

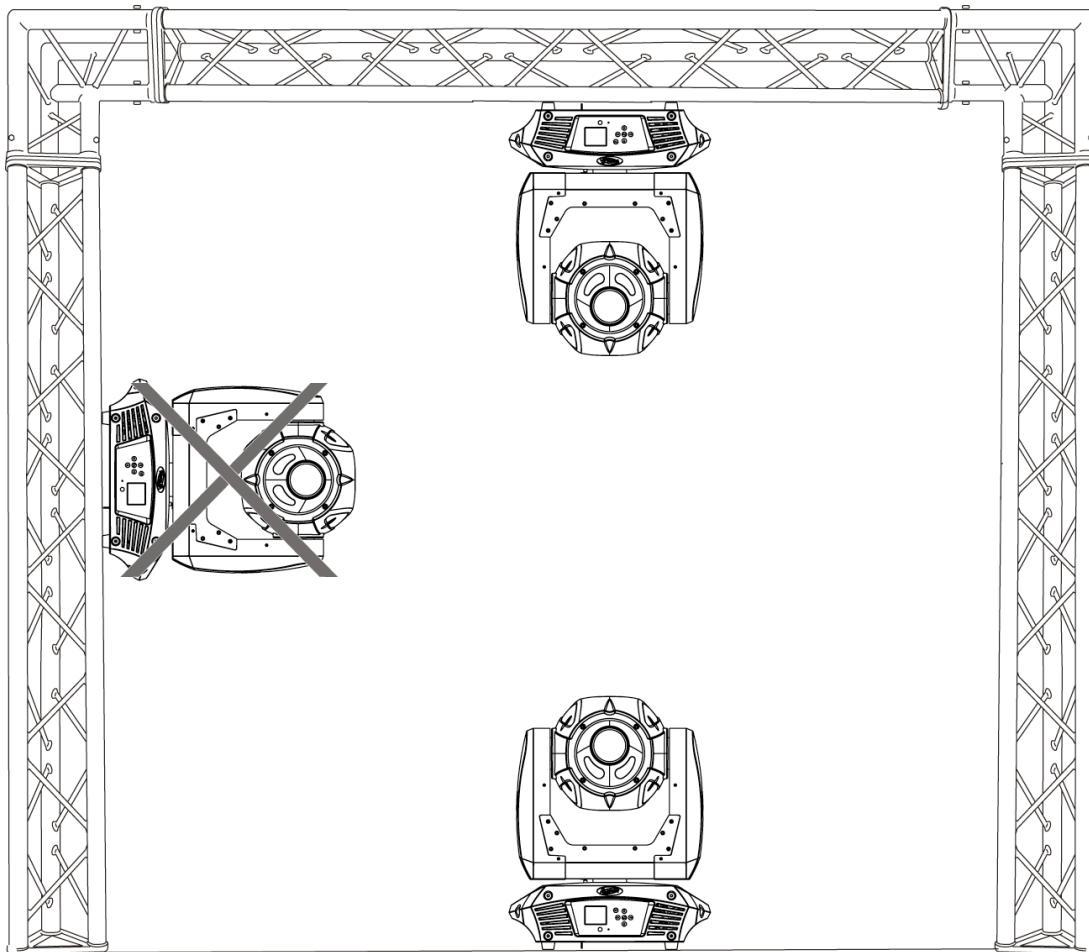

Mounting points

Overhead mounting requires extensive experience, including amongst others calculating working load limits, a fine knowledge of the installation material being used, and periodic safety inspection of all installation material and the fixture. If you lack these qualifications, do not attempt the installation yourself. Improper installation can result in bodily injury.



CAUTION!
Be sure a qualified electrician performs all electrical connections.

Be sure to complete all rigging and installation procedures before connecting the main power cord to the appropriate wall outlet.

Clamp Mounting

The Platinum Spot 5R™ provides a unique mounting bracket assembly that integrates the bottom of the base, the included “Omega Bracket,” and the safety cable rigging point in one unit (see the illustration below). When mounting this fixture to truss be sure to secure an appropriately rated clamp to the included omega bracket using a M10 screw fitted through the center hole of the “omega bracket”. As an added safety measure be sure to attached at least one properly rated safety cable to the fixture using on of the safety cable rigging point integrated in the base assembly

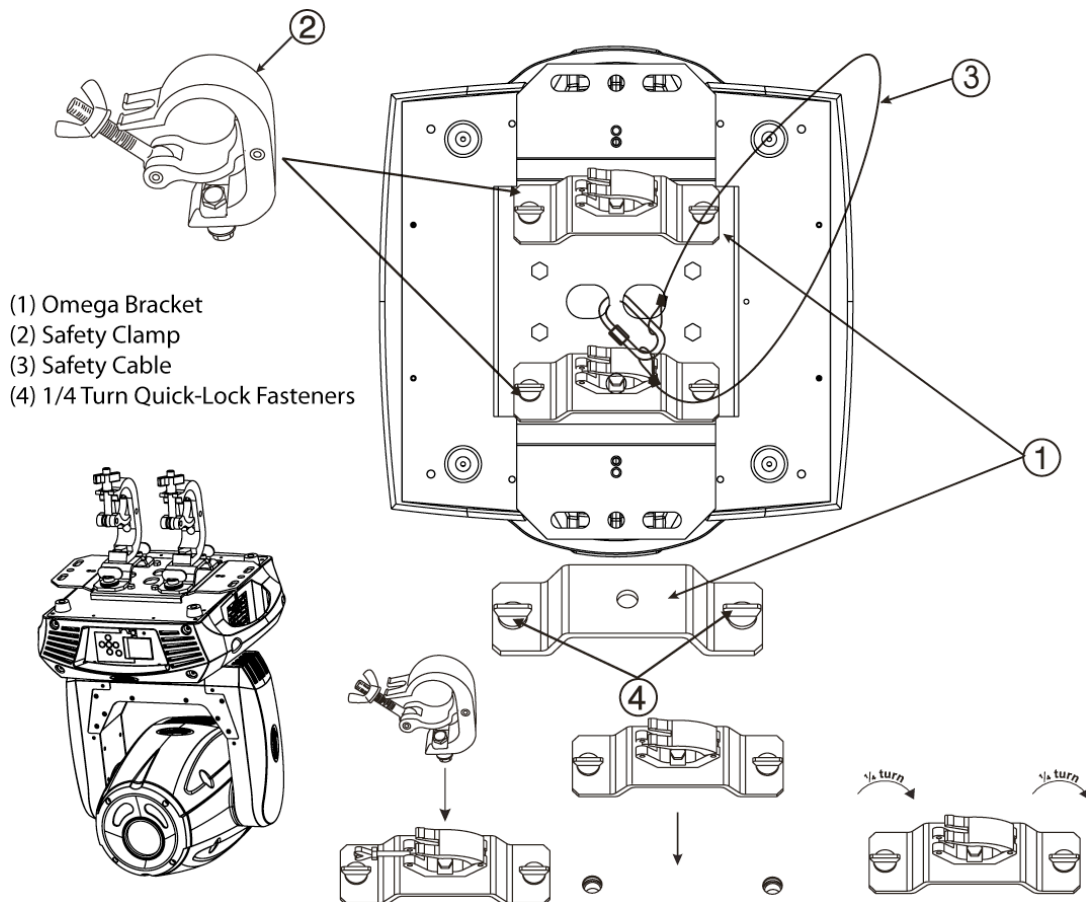

Securing the Platinum Spot 5R™

Regardless of the rigging option you choose for your Platinum Spot 5R™ always be sure to secure your fixture with a safety cable. The fixture provides a built-in rigging point for a safety cable on the hanging bracket as illustrated above. Be sure to only use the designated rigging point for the safety cable and never secure a safety cable to a carrying handle.

8. UNDERSTANDING DMX

DMX-512: DMX is short for Digital Multiplex. This is a universal protocol used by most lighting and controller manufactures as a form of communication between intelligent fixtures and controllers. DMX allows all makes and models of different manufactures to be linked together and operate from a single controller. This is possible as long as all the fixtures and the controller are DMX compliant. A DMX controller sends the DMX data instructions to the fixture allowing the user to control the different aspects of an intelligent light. DMX data is sent out as serial data that travels from fixture to fixture via data “IN” and data “OUT” XLR terminals located on the fixtures (most controllers will only have output jacks).

DMX Linking: To ensure proper DMX data transmission, always use proper DMX cables and a terminator. When using several DMX fixtures try to use the shortest cable path possible. Never split a DMX line with a “Y” style connector. The order in which the fixtures are connected in a DMX line does not influence the DMX addressing. For example; a fixture assigned a DMX address of 1 may be placed anywhere in the DMX chain, at the beginning, at the end, or anywhere in the middle. The DMX controller knows to send data assigned to address 1 to that fixture no matter where it is located in the DMX chain. The Platinum Spot 5R™ can be controlled via DMX-512 protocol. The Platinum Spot 5R™ is a 17 channel DMX fixture (17 default, can also be 15 or 24). The DMX address is set electronically using the controls on the LCD menu.

Data Cable (DMX Cable) Requirements (For DMX and Master/Slave Operation): Your fixture and your DMX controller require a standard 3-pin or 5-pin XLR connector for data input and data output (the figure on the next page is of a 3-Pin XLR connector). If you are making your own cables, be sure to use two conductor shielded digital DMX cable rated at 120 ohms; this cable is designed for DMX transmission and may be purchased from your Elation dealer or at most professional lighting retailers. Your cables should be made with a male and female XLR connector on either end of the cable. Also, remember that a DMX line must be daisy chained and cannot be split, unless using an approved DMX splitter such as the Elation Opto Branch 4™ or DMX Branch/4™.

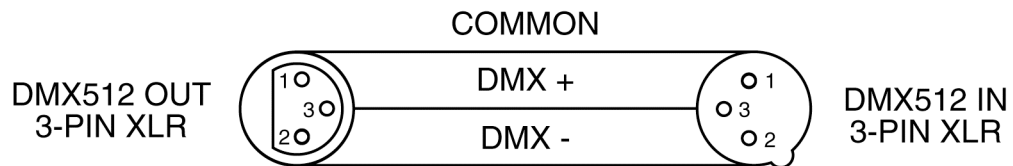

Be sure to follow the above figure when making your own cables. Do not use the ground lug on the XLR connector. Do not connect the cable's shield conductor to the ground lug or allow the shield conductor to come in contact with the XLR's outer casing. Grounding the shield could cause a short circuit and erratic behavior.

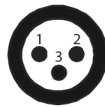
DMX Output
3-Pin XLR SocketDMX Input
3-Pin XLR Socket

1: Ground
2: Data (-)
3: Data (+)

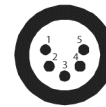
DMX Output
5-Pin XLR SocketDMX Input
5-Pin XLR Socket

1: Ground
2: Data (-)
3: Data (+)
4: Open
5: Open

DMX-512 control connection

Connect the provided XLR cable to the female 3-pin XLR output of your controller and the other side to the male 3-pin XLR input of the moving head (Please refer to the diagram below.). You can chain multiple moving heads together through serial linking. The cable that should be used is two conductor, shielded DMX cable with XLR input and output connectors. Always be sure daisy chain your in and out data connections, never split or "Y" your DMX connections unless you are using an approved DMX splitter such as the Elation Opto Branch 4™ or DMX Branch/4™.

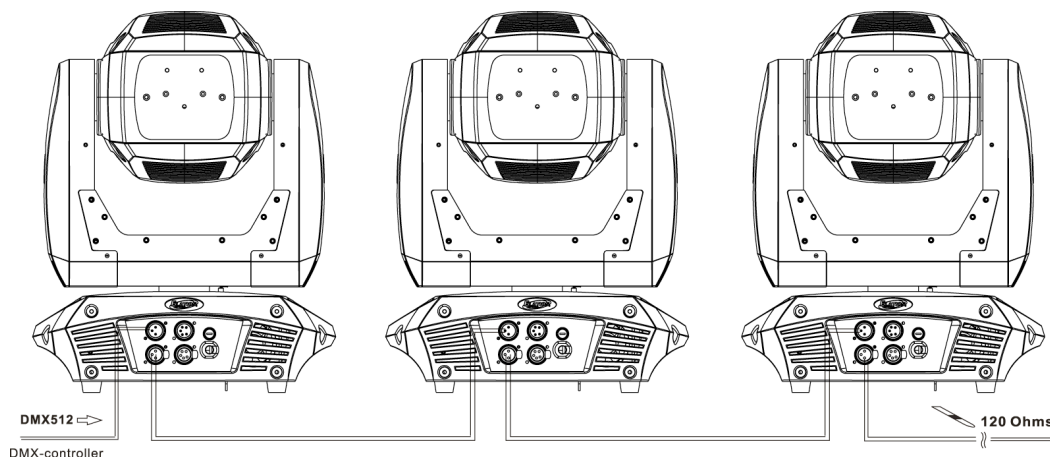

DMX-512 connection with DMX terminator

A DMX terminator should be used in all DMX lines especially in longer runs. The use of a terminator may avoid erratic behavior in your DMX line. A terminator is a 120 ohm 1/4 watt resistor that is connected between pins 2 and 3 of a male XLR connector (DATA + and DATA -). This fixture is inserted in the female XLR connector of the last fixture in your daisy chain to terminate the line. Using a *line terminator (Elation part: DMX T PACK)* will decrease the possibilities of erratic behavior.

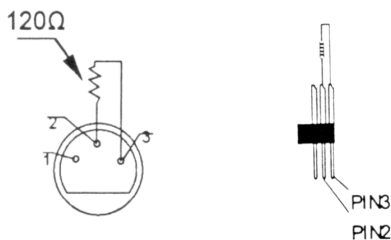

Termination reduces signal errors and avoids signal transmission problems and interference. It is always advisable to connect a DMX terminal, (Resistance 120 Ohm 1/4 W) between PIN 2 (DMX-) and PIN 3 (DMX +) of the last fixture.

5-Pin XLR DMX Connectors. Some manufactures use 5-pin XLR connectors for DATA transmission in place of 3-pin. 5-pin XLR fixtures may be implemented in a 3-pin XLR DMX line. When inserting standard 5-pin XLR connectors in to a 3-pin line a cable adaptor must be used, these adaptors are readily available at most electric stores. The following chart details a proper cable conversion.

3-Pin XLR to 5-Pin XLR Conversion		
Conductor	3-Pin XLR Female (Out)	5-Pin XLR Male (In)
Ground/Shield	Pin 1	Pin 1
Data Compliment (- signal)	Pin 2	Pin 2
Data True (+ signal)	Pin 3	Pin 3
Not Used		Pin 4 - Do Not Use
Not Used		Pin 5 - Do Not Use

Fixture DMX addressing;

All fixtures should be given a DMX starting address when using a DMX controller, so the correct fixture responds to the correct control signal. This digital starting address is the

channel number from which the fixture starts to “listen” to the digital control information sent out from the DMX controller. The allocation of this starting DMX address is achieved by setting the correct DMX address on the digital display located on the base of the fixture.

You can set the same starting address for all fixtures or a group of fixtures, or set different address for each individual fixture. Be advised that setting all your fixtures to the same DMX address will subsequently control all fixtures in the same fashion, in other words, changing the settings of one channel will affect all the fixtures simultaneously.

If you set each fixture to a different DMX address, each unit will start to “listen” to the channel number you have set, based on the quantity of control channels (DMX channels) of each fixture. That means changing the settings of one channel will only affect the selected fixture.

In the case of the Platinum Spot 5R™, which is a 17 channel fixture (default), you should set the starting DMX address of the first unit to 1, the second unit to 18 (17 + 1), the third unit to 35 (17 + 18), and so on.

Note: During start-up the Platinum Spot 5R™ will automatically detect whether a DMX data signal is being received or not. If DMX data signal is being received, the display will show "**Address XXX**" (XXX representing the actual DMX address). If the fixture is not receiving a DMX signal the display will flash. If your fixture is connected to a DMX controller and the display is flashing (not receiving a DMX signal), please check the following:

- The 3-PIN or 5-PIN XLR input plug (cable with DMX signal from controller) is not connected or is not inserted completely into the DMX input jack of the fixture.
- The DMX controller is switched off or defective.
- The DMX cable or connector is defective.
- A DMX terminator has been inserted into the last fixture in your DMX chain.

9. FIXTURE MENU

On-Board System Menu: The Platinum Spot 5R™ comes with an easy to navigate, full color system menu. This next section will detail the functions of each command in the system menu.

LED Control Panel: The control panel located on the base of the fixture allows you to access the main menu and make all necessary adjustments to the **Platinum Spot 5R™**. During normal operation, tapping the “**MODE/ESC**” key once will access the fixture’s main menu. Once in the main menu you can navigate through the different functions and access the sub-menus with the **Up** and **Down** buttons. Once you reach a field that requires adjusting, tap the **ENTER** button to activate that field and use the **UP** and **Down** button to adjust the field. Tapping the **Enter** button once more will confirm your setting. Once a setting is saved the display will briefly readout **OK** to confirm a new setting has been made and locked into memory. You may exit the main menu at any time without making any adjustments by tapping the **MODE/ESC** button.

MODE/ESC Button - To access the main menu locate the **MODE/ESC** button on the front of the unit. Press this button to activate the system menu. Tap the **UP** button until you reach the function you wish to change. When you reach the function you wish to change tap the **ENTER** button once to select that menu function. When a function is selected, use the **UP** or **DOWN** button to change the function. Once your changes are made tap the **ENTER** button yet again to lock the change in the system menu. To exit without making any changes tap the **MODE/ESC** button.

The fixture contains a rechargeable battery back-up system that stores all setting and also allows the menu to be accessed when the fixture is not connected to power. To access the menu via battery power, press and hold the DC switch button for two seconds, this will activate the menu. The display will automatically turn off approximately one minute after all menu commands are completed.

Default settings shaded.

Function Mode	Set Dmx Address Value Display Set To Slave Auto Program Music Control	A001~AXXX PAN..... Slave1,Slave2,Slave3 Master / Alone Master / Alone	DMX address setting DMX value display Slave setting Auto program Music control
Information	Time Information	Current Time Total Life Hours Last Run Hours Lamp Hours Lamp Off Time Timer Password Clear Last Run L-Timer Password Clear Lamp Time	XXXX(Hours) XXXX(Hours) XXXX(Hours) XXXX(Hours) XXXX(Minute) Password=XXX ON/OFF Password=XXX ON/OFF
	Temperature Info	Head Temperature	XXX °C/°F Temperature in the head
	Software Version	Ver1.2.....	Software version of each IC
Lamp Control	Lamp On or Off Automatic La-On Lamp On Via DMX Lamp Off Via DMX Lamp On at Temp. Lamp Off at Temp.	ON/OFF ON/OFF ON/OFF ON/OFF 20~79 °C, 45°C /68~174°F 113°F 80~139°C, 130°C /176~282°F\ 266°F	Lamp on/off Lamp on/off when Power on Lamp on via DMX Lamp off via DMX Lamp restart at temp. Lamp off at temp.
Personality	Status Settings	Address via DMX No DMX Status Pan Reverse Tilt Reverse Pan Degree Feedback Movement Speed Mic Sensitivity Hibernation V1.0 Mode	ON/OFF Close/Hold/Auto/Music ON/OFF ON/OFF 630/540 ON/OFF Speed 1~ 4 0~99% OFF, 01M~99M, 15m ON/OFF
	Fans Control	Auto Fans Speed High Fans Speed	Fans Speed Mode Select
			Remote DMX Addressing Auto run if no DMX Pan Reverse movement Tilt Reverse movement Pan Degree Select Movement Feedback switch Movement Mode Select Sensitivity of Mic. Activates Hibernation Mode Compatibility mode for first generation Platinum Spots

		Low Fans Speed		
	Display Setting	Shutoff Time	02~60m 05m	Display shutoff time Display Reverse 180 degree Menu Key Lock Activation
		Display Reverse	ON/OFF	
		Key Lock	ON/OFF	
	Temperature C/F	Celsius/ Fahrenheit		Temperature switch between C°/F°
Initial Effect	PAN =XXX		Initial effect position	
	Reset Default	ON/OFF		Restore factory set.
Reset Function	Reset All			Reset all motors Reset Pan/Tilt Reset color wheel Reset gobos Reset shutter and/or dimmer Reset other motors
	Reset Pan&Tilt			
	Reset Colors			
	Reset Gobos			
	Reset Shutter			
	Reset Others			
Effect Adjust	Test Channel	PAN		Test function
	Manual Control	PAN =XXX :		Fine adjustment of the lamp
	Calibrate Values	Calibrate Password Color wheel=XXX :		Password "050" Allows all wheel to be calibrated to their proper position
Users Mode Set	User Mode	Standard Mode Basic Mode Extended Mode User Mode A User Mode B User Mode C		DMX Channel change. 16bit/16bit extended/8bit and user defined channel assignment
	Edit User Mode	Max Channel = XX PAN = CH01 :		Edits user defined channel assignments
Edit Program	Select Programs	Auto Pro Part 1 = Program 1 ~ 10 Program 1 Auto Pro Part 2 = Program 1 ~ 10 Program 2 Auto Pro Part 3 = Program 1 ~ 10 Program 3		Select programs to be run
	Edit Program	Program 1 : Program 10	Program Test Step 01=SCxxx Step 64=SCxxx	Testing program Program in loop Save and exit
	Edit Scenes	Edit Scene 001 ~ Edit Scene 250	Pan,Tilt,..... --Fade Time-- --Secne Time-- Input By Outside	Save and automatically return Manual scenes edit Stores scenes via external DMX console

	Rec. Controller	XX~XX	Scenes recorded from external source
--	-----------------	-------	--------------------------------------

9.1 Function Mode:

9.1.1 “Set DMX Address” - DMX address setting – This function is used to set or adjust the fixture’s starting DMX address. Every device controlled by DMX has to have a unique starting address. The addressing feature is what allows DMX to function properly. The DMX address of a fixture is what allows it to communicate with a controller properly. The DMX addressing also allows the fixture to ignore any DMX information coming from the controller that is not meant specifically for the fixture. Because each fixture is connected in a daisy-chain fashion it is imperative to assign a proper and unique starting DMX address to each and every fixture. The DMX address is non-destructive and will remain in the fixture’s memory even when the power to the unit is switched off. Memory is backed-up and retain by an internal power source that should last about five years. For proper DMX addressing see Section 10/Page 35 of this user manual.

9.1.2 “Value Display” - Display the DMX 512 value of each channel

With this function you can display the DMX 512 value of each channel. The display will automatically detail the changing DMX values as they are received from the controller.

9.1.3 “Set to Slave” - Slave setting for Master/Slave Operation

With this function, you can define the device as slave for operation in Master/Slave mode. Each slave setting will have a different function for a dynamic lightshow without a controller.

9.1.4 Auto Program

This function allows the internal programs to run in either stand-alone or master/salve mode. In “Master” mode the fixture will send DMX data to other fixtures connect via the DMX chain. In “Alone” mode the fixture will operate as a single fixture. The program for this mode is selected in the “**Select program**” section of the control menu. You can set the number of steps under “**Edit program**”. You can edit the individual scenes under “**Edit scenes**”. With this function, you can run the individual scenes either automatically, i.e. with the adjusted Step-Time.

9.1.5 Music control

This function is similar to the “Auto Program” described in the previous section with the exception that this function will advance the built-in program via sound.

9.2 Information:

9.2.1 Time information

These functions will detail different time functions associated with the fixture.

Current Time

This function displays the running time of the fixture from the last power on. The display shows “XXXX”, where “XXXX” represents the number of hours the fixture has been running. This counter is automatically reset after every power-on.

Total Run Time

This function tracks the total running time of the fixture from the very first start-up. Where “XXXX” represents the total number of running hours. This time is non-destructive and will remain in the fixtures memory indefinitely.

Last Run Hours

This function tracks a cycle run time. Use this function to keep track of rental period, or to note the time from the last service. This setting can be reset at any time, see

“L-Timer Password.”

Lamp Hours. This function tracks the total number of lamp running hours. Where “XXXX” represents the number of hours the lamp has been running. This counter should be reset after every lamp change.

Lamp Off Time

This function displays the running time of the lamp from the last power on. The display shows “XXXX”, where “XXXX” represents the number of hours the lamp has been running since it was last struck. This counter is automatically reset after every power-on.

Timer Password

Use this function to enter the “Clear Last Run” password. Password is “038”

Clear Last Run

This function will allow the “Last Run Hours” function be cleared and reset.

L-Timer Password

Use this function to enter the “Clear Lamp Time” password. Password is “038”

Clear Lamp Time

This function resets the lamp “ON” time to zero. Please reset the lamp “ON” time at every lamp replacement. This procedure tracks the lamp running time so the lamp can be replaced at the end of it’s recommended duty cycle.

- Select “Clear lamp time” in the system menu.
- The LCD will display “ON” or “OFF.” Were “ON” will reset the lamp time.
- Press enter to confirm.
- Press the Mode/Esc-button to return to the main menu.

9.2.2. Temperature Info.

This function will detail the internal head temperature in either Celsius or Fahrenheit.

9.2.3. Software version

This function will display the current operating software version of the fixture.

- The LCD will read “V-X.X”, “X.X” represents the version number, e.g. “V-1.0”, “V-2.6”.
- Use the UP and DOWN buttons to toggle through the software version of different IC’s.

9.3 Lamp Control:

9.3.1 Lamp On or Off

This function allows manual control of the lamp power via the on-board system menu.

- Select “**ON**” if you wish to strike the lamp or “**OFF**” to switch it off.
- Press “ENTER” to confirm.
- Press the Mode/Esc-button to return to the main menu.

9.3.2 Automatic La-On

When in the “ON” position, this function will automatically turn the lamp on when power is applied to the fixture

9.3.3 Lamp On Via DMX

When engaged, this function will allow the lamp to be switched “on” via a DMX controller. Select “**ON**” to enable this function or “**OFF**” to disable it.

9.3.4 Lamp Off Via DMX

When engaged, this function will allow the lamp to be switched “off” via a DMX controller. Select “**ON**” to enable this function or “**OFF**” to disable it.

9.3.5 Lamp On at Temp.

The fixture is designed to shut the lamp off when an excessive temperature is sensed inside the head by the on-board CPU. The lamp is shut down to prevent damage to the lamp and avoids possible internal damage to the head. This function sets the minimum temperature for lamp restrike after the lamp has been automatically shut off.

9.3.6 Lamp Off at Temp.

The fixture is designed to shut the lamp off when an excessive temperature is sensed inside the head by the on-board CPU. The lamp is shut down to prevent damage to the lamp and avoids possible internal damage to the head. This function sets the maximum internal operating temperature of the head before the lamp will automatically be shut down. This function can be set to activate at an internal temperature between 80° C and 139° C. Inside temperatures below 90° C are not critical. Temperatures above 90° C should lead to the lamp being switched off. Please note that the outside temperature should not exceed 45° C.

9.4 Personality:

9.4.1 Status setting

Address via DMX - This function allows the DMX address to remotely be adjusted from a DMX console. This setting requires special settings for both the controller and the fixture. RDMX is on by default. For operational instructions please see Section 10/Page 35 of this manual “Remote DMX addressing.”

No DMX Status – This function dictates how the fixture will function if it loses DMX signal during normal operation. The default function is set to hold, in which the fixture will lock into the last DMX signal it received and remain in that position until it

is turned off or begins receiving a new DMX signal. If the fixture is turned on without any DMX signal, the fixture will automatically go in to sound-active mode. Available settings are: “Close” – Shutter flags will close. “Hold” – Fixture will remain at it’s last settings. “Auto” – Fixture will go into stand-alone mode, running the built-in program. “Music” – The fixture will go into sound-active mode.

Pan Reverse - This function allows you to invert all pan movements. Use the Up and Down buttons to turn this function On or Off. Press the Enter button to accept the change or the Mode button to cancel and return to the main menu. This function is “OFF” by default.

Tilt Reverse - This function allows you to invert all tilt movements. Use the Up and Down buttons to turn this function On or Off. Press the Enter button to accept the change or the Mode button to cancel and return to the main menu. This function is “OFF” by default.

Pan Degree – This function changes the maximum Pan resolution from either 540° or 630°. The default function is 540°. 630° operation allows for greater coverage, but slower pan movement.

Feedback – This function turns the feedback correction on or off. This function is set to “ON” as default. This function allows for automatic pan and tilt correction in the event either one disrupted during normal operation.

Movement Speed – This function changes the speed function of the Pan and Tilt motors. Use this function intergrading Platinum Spot 5R into lighting rigs that includes original Design Spot 250s. There are 3 different mode variations;

Speed 1 (Default): Slower than the original Design Spot 250 for smoother, more precise movements.

Speed 2: Pan and Tilt speeds are identical to the first generation Design Spot 250.

Speed 3: includes a faster Pan speed. Pan speed is 0.5 seconds faster than original DS-250. Tilt speed will be the same as speed 2.

Mic Sensitivity – This function makes the internal microphone more or less sensitive to sound. This function only works in conjunction with the sound active modes. The default setting is 70% and setting range from 0% to 99%.

Hibernation – When activated, this function will automatically put the fixture in power stand-by mode after a defined period of time of no DMX activity. This prevents the fixture from expending power for extended periods in the event the fixture has been left on accidentally. In stand-by mode the lamp and all motors will power down if no DMX signal is sent to the fixture for a period of 15 minutes (default, can be user defined). The fixture will automatically reset and return to normal operation once a DMX signal is sensed.

V1.0 Mode – This function should only be activated when intergrading first generation Platinum Spots (Ver 1.0) with second generation or higher Platinum Spots (Ver 1.1 or higher). This function will match the gobo rotation speed to that of the first generation fixtures. When this function is not activated the gobo change will not match between the different generation fixtures.

9.4.2 Fans Control - This function is used to change the functionality of the internal cooling fans. The available selections are: 1) “AUTO” – The fans will automatically switch between low and high speeds depending on the internal operating temperature. 2) “HIGH” – The fans will run in high-speed mode regardless of operating temperature. 3) “LOW” – The fans will remain in low speeds regardless of internal operating temperature.

9.4.3 Display Settings

Shutoff Time - The display is designed to turn off during normal operation to avoid excessive light in situations that require an extremely dark environment. This function will adjust the amount of time the display will remain on until it is automatic turned off. This function is disabled as default.

Display Reverse – This function will allow the entire display to be flipped by 180° to allow for better view when the fixture is hung from truss or a ceiling. This function is disabled as default.

LOCK – This function allows you to lock the keys on the display to prevent menu tampering. With this function you can activate the automatic keylock function. If this function is activated, the keys will be automatically locked in 15 seconds from the last command. In order to deactivate or temporarily deactivate the keylock function, press the Mode/Esc Button for 3 seconds to regain access to the menu commands.

9.4.4 Temperature C/F – This function changes the temperature the unit will display from either Celsius or Fahrenheit. Fahrenheit is set as the default measurement.

9.4.5 Initial effect – This function allows a user to create and assign a custom “Home Position” into the fixture. Adjusting the Pan and Tilt values then locking those values into the fixture’s internal memory creates the new “Home” position.

9.4.6 Restore Default – This function is used to restore the factory settings of the device. All settings will be set back to the default values (shaded). Any edited scenes will be lost.

9.5 Reset Functions: The reset function returns a motor to the “Home” position. There are several reset functions available on this fixture. The list below details the functionality of each available selection.

- **Reset All:** This function will reset all internal motors to the home position.
- **Reset Pan and Tilt:** This function will only reset the pan and tilt motors to the home position.
- **Reset Colors:** This function will only reset the color wheel to the home position.
- **Reset Gobos:** This function will only reset the gobo wheels to the home position.
- **Reset Shutter:** This function will only reset the blackout shutter to the home position.
- **Reset Others:** This function will reset all other motors not associated with any in the previously listed reset commands to the home position.

9.6 Effect Adjust:

9.6.1 Test Channel – This menu function allows the user to select each individual fixture channel and test it's function independently from the control board.

9.6.1 Lamp adjustment (manual control) – This function readies the fixture for lamp optimization in a simple single step procedure. This function will center the pan and tilt motors and at the same time open the shutter and bring the dimmer to 100%. The pan and tilt function will still operate if the fixture needs to be positioned to a flat clear surface. For more information on lamp optimization please see Section 6/Page 14.

9.6.2 Calibrate values – This function should only be performed by a qualified technician. This function allows a user to make small adjustments to the effect wheels (color, gobo, shutter, etc) to compensate for ware or in the event a sensor has been knocked slightly out of place. Because improper use of this function can result in undesired operation this function has been password protected. The password is 050 and must be entered each time the calibration menu function is entered. Because calibration is an extremely delicate procedure instruction on performing this action are left out of this manual. For a first time calibrator, please contact our customer support team for step-by-step instructions.

9.7 User Mode Set:

9.7.1 User mode – This function allows the user to create user defined channel orders allowing the fixture to match the channel order of other fixtures on the market for easier operation. A total of three user modes may be configured: User Mode A, User Mode B, and User Mode C.

9.7.2 Edit User mode – This function allows the user to make the actual changes in the user-defined modes that are created in the previous function.

9.8 EDIT PROGRAM: - The fixture comes equipped with a built-in DMX recorder that allows custom programs to be installed and recalled directly from the fixture's control board.

Programs can be created and stored using the fixture's control board or by using an external DMX controller. For detailed instructions on how to complete this task please see Section 12/ Page 39.

- 9.8.1 Select program** – This function allows the user to select one of ten of the user defined built-in programs. This program is then accessed in “Function Mode” under “Program Run.”
- 9.8.2 Edit program** – This function allows the user to edit the built-in programs.
- 9.8.3 Edit Scenes** – This function allows the user to edit or define the actual scenes that are stored in the user defined built-in programs that are accessed in the previous step.
- 9.8.4 Rec Controller** - The Platinum Spot 5R features an integrated DMX recorder. Pre-programmed scenes can be transmitted to the fixture via any DMX compliant controller. This function allows those scenes to be stored in to the fixture's built-in memory and then subsequently used to create the user-defined programs.

10. DMX ADDRESSING

Setting the DMX address - After the fixture is turned “ON” it will immediately complete a reset process that test all the fixture’s functions. When the reset process concludes the LCD will display the fixture’s current DMX. If the fixture is not receiving a DMX signal, the display will flash continuously. To set or adjust a DMX address, please follow the procedure below:

1. Toggle through the menu by pressing the Up and Down buttons until the display reads “Address=XXX.” Tap the enter button to make changes to the address.
2. While the display is flashing use the “UP” and “DOWN” buttons to select a new address. Once the new address has been selected, lock the new address into the fixture’s memory by pressing the “ENTER” button.

The DMX address is non-volatile and will remain in the fixture’s memory even when the power to the unit is switched off. Memory is backed-up and retain by an internal power source that should last about five years

Remote DMX addressing (RDMX) / Address Via DMX- This function allows the DMX address to be changed remotely from a DMX console. This setting requires special settings for both the controller and the fixture. RDMX is on by default. This function may be turned on and off, and is “ON” be default. Follow the procedure listed below to access the RDMX functions: **Fixture Settings:**

1. Access the main menu and use the UP or DOWN to get to the “Personality” menu, then press ENTER
2. Once in the “Personalities” menu, tap the UP or Down to get to the “Status Settings “ menu, press ENTER.
3. Once in the “Status Settings” tap the UP or Down to get to the “Address via DMX” function and press ENTER.
4. “Address via DMX” is the menu function that activates the RDMX function.
5. Press the UP button to display “ON” to activate this function, or “OFF” to deactivate this function.
6. Press ENTER to confirm.
7. Press MODE/ESC to return to the main menu.

Controller Settings:

1. Set the DMX value of channel 1 to a value of 7.
2. Set the DMX value of channel 2 to a value of 7 or 8. When channel 2 is set to "7" you can adjust the starting address between 1 and 255. When set to "8" you can adjust the starting address between 256 and 511.
3. Use channel 3 to set your desired DMX starting address. **For example:** If you want to set the starting address to 57, set channel 1 to a value of "7," set channel 2 to a value of "7" and use channel 3 to set your address to 57 by selecting a channel value of 57. Example 2: If you want to set the starting address to 420, set channel 1 to a value of "7," channel 2 to "8" and channel 3 to "164" ($256+164=420$).
4. ***Wait for approximately 20 seconds for the unit to complete the address reset function.***

11. OPERATION

Operating Modes: *The Platinum Spot 5R™ can operate in six different modes. This next section will detail the differences in the operating modes.*

- **Auto Program Mode (Master)** - The fixture will chase through the built-in programs, sending a DMX control signal to all other fixtures connect via DMX cables instruction for a synchronized light show.
- **Auto Program Mode (Stand-alone)** - The fixture will chase through the built-in program. This feature is great for store front with custom logos, where as the logos need to be displayed but the use of a controller is unwanted.
- **Music Control Mode (Stand-alone)** - The fixture will react to sound, chasing through the built-in programs. Great for small clubs or DJ that do not want to bother with programming.
- **Music Control Mode (Master/Slave)** - You can daisy chain up to 16 fixtures together to get a synchronized light show without the need of an external controller. The fixtures will react to sound, chasing to a synchronized light show.
- **Set To Slave** – This function will set the fixture to slave mode for use in either the auto program or music control program modes
- **DMX control mode** - This function will allow you to control each individual fixtures traits with a standard DMX-512 controller such as the Elation® Show Designer 2.

- 11.1 Stand-Alone Operation (Auto Program or Music Control):** This mode allows a single fixture to run to the built-in programs with or without sound. Only use this mode when running a single fixture, or when running several fixtures as individuals.
- Mount your fixture in a secure and stable manner.
 - **For functionality without sound control:** Access the “Function” menu and select the “Auto Program” function, this will give you access to the “Auto Program” submenu. See page 24 for the menu breakdown. Once in the “Auto Program” submenu select “Alone”
 - **For functionality that chases to sound:** Access the “Function” menu and select the “Music Control” function, this will give you access to the “Music

Control” submenu. See page 24 for the menu breakdown. Once in the “Music Control” submenu select “Alone”

11.2 Master/Slave Operation (Auto Program or Music Control): This function allows up to 16 fixtures to be linked together to provide a synchronized light show without the use of a controller. Only use this when linking several Platinum Spot 5Rs together for use without a controller. Any fixture can act as a “Master or a “Slave.”

- Using XLR DMX cables, daisy chain your fixtures together via the XLR connectors. Remember the Male XLR connector is the input and the Female XLR connector is the output. The first fixture in the chain (master) will use the female XLR connector only - The last fixture in the chain will use the male XLR connector only. For longer cable runs we suggest a terminator at the last fixture.
- For the unit functioning as the “Master” unit follow the same procedures listed in the previous Stand-Alone section.
- For the “Slave” units, access the “Set To Slave” settings in the “Function Mode” menu and assign each slave fixture a designation (Slave 1, Slave 2, Slave 3...etc).

11.3 Universal DMX Control: This function allows you to use a universal DMX-512 controller such as the Elation® Show Designer 2™ or Elation® Show Designer 3™ to control head movement, the color wheel, the shutter (strobe), and all other DMX traits. A DMX controller allows you to create unique programs tailored to your individual needs. The Platinum Spot 5R™ uses 17 (default up to 24) DMX channels. See page 42 for detailed description of the DMX traits. To control your fixture in DMX mode, follow the set-up procedures on pages 19-22 as well as the set-up specifications that are included with your DMX controller. Use the controller’s faders to control the various DMX fixture traits. This will allow you to create your own programs.

- Follow the instruction on page 35 to set the DMX address.
- Be sure to use a terminator on the last fixture, especially for longer cable runs (more than a 100 feet).
- For help operating in DMX mode consult the manual that was included with your DMX controller.

12. WORKING WITH BUILT-IN PROGRAMS

The fixture comes equipped with a built-in DMX recorder that allows custom programs to be installed and recalled directly from the fixture's control board. Programs can be created and stored using the fixture's control board or by using an external DMX controller. The following instructions will detail the procedures for using the on-board system menu as well as using a DMX compliant controller.

Memory Statistics:

Quick Access Programs (Program Part): 3

Total Number of Programs: 10

Maximum Number of Steps (Scenes) per a Program: 64

Total Number of Scenes (Steps): 250

Step 1 – Building Scenes.

The control will store a maximum of 250 scenes. These scenes are then used to create the programs. A program can store one or a maximum of 64 scenes. Keep in mind that a scene can only be access when it is stored in a "Program." If you wish to build a static scene (a scene consisting of no movement) for a logo or gobo projection, the scene must be stored inside a program. To build a scene follow the instructions below:

- Access the main menu and toggle to "Edit Programs" which is menu function 8.
- Then tap the "ENTER" button and toggle to "Edit Scenes," menu function 8-3.
- When you get to the "Edit Scenes" function tap the "ENTER" button. The screen will then change to Edit Scene 001, this will be menu function 8-3-1. You can then press the "ENTER" button to begin to edit scene 1 or use the "UP" and "DOWN" buttons to toggle to access scenes 2-250.
- Once in the scene edit screen you have access to the functions listed below.
Tapping the "ENTER" button will instantly allow you to change the values of the selected function in real time. The values can be adjusted from 0~250. Once you achieved your desired value tap the "ENTER" button once again to automatically lock the value into the scenes memory. You can repeat the procedure for all functions listed below:
 - "Auto Program" – Allows access to all 17 of the fixture's DMX traits.
 - "PAN" – pan movement.

- “PAN-Fine” – precision pan movement.
- “TILT” – tilt movement.
- “TILT-Fine” – precision tilt movement
- “Move Speed” – adjust pan and tilt motor speed
- “Gobo Wheel 1” – select gobos from gobo wheel 1
- “Gobo Rot. 1” – adjust gobo 1 indexing or rotation
- “Gobo Wheel 2” – select a gobo from gobo wheel 20
- “Prism” – select a prism, prism macro, or frost
- “Prism Rot.” – adjust the prism indexing or rotation
- “Color Speed” – adjust the CMY mixing speed
- “Color Macro” – select a built-in color mixing macro
- “Color Wheel” – select a color from the color wheel
- “Iris” – adjust the iris value
- “Focus” – adjust the focus value
- “Strobe” – adjust the strobe
- “Dimmer” – adjust the dimmer intensity
- “Scene Time” – set the hold time for the scene
- “Input By Out” – this function will store a scene from an external DMX console. See the next section for scene editing via an external DMX controller.

Step 1B – Building Scenes from an External DMX Controller

The fixture includes a simple built-in DMX recorder. This recorded allow you to build a scene using your own DMX console and then send that scene to the fixture to be stored inside one of the fixture scene storage banks. Many people may find this procedure easier and quicker than using the on board menu functions as in “Step 1.” To store a scene from an external DMX controller follow the procedures below:

- Using your DMX control build and store scenes as you normally would.
- Once you have built all your required scenes, enter the fixtures main menu and toggle to

Step 2 – Editing Programs.

The control will store a maximum of 10 programs. A program can store one or a maximum of 64 scenes. Keep in mind that a scene can only be access when it is stored inside one of the 10 available programs. Follow the procedure below to build an internal program:

- Access the main menu and toggle to “Edit Programs” which is menu function 8.
- Then tap the “ENTER” button and toggle to “Program 1” menu function 8-2-1.
- When you get to the “Program 1” function tap the “ENTER” button. The screen will then change to Edit Steps 01, this will be menu function 8-2-1-1. Use the “UP” and “DOWN” buttons to toggle through the scenes created in “Step 1.” Press the “ENTER” button to add a scene to the program. Tapping the “Enter” button will automatically lock the selected scene into the programs’ memory. Repeat the process until all the desired scenes have been added to the program. Each program can store a maximum of 64 scenes.
- To test the program access “Program Test” in the “Program Edit” menu function.

Step 3 – Playing a Program

To initiate a program follow the procedure below:

- Access the main menu and use the “Up” and “Down” to toggle to “Function Mode” and tap the “Enter” button.
- In the next screen select “Auto Program” and tap the “Enter” button.
- There are now two selections, “Master” and “Alone.” Select “Master” when running multiple fixtures in a master/slave configuration. See section 11.2 “Master/ Slave Operation” on page 37 for proper set-up instructions. Select “Alone” when running a single fixture or when multiple fixtures in stand-alone mode. See section 11.1 “Stand-Alone Operation” on page 37 for proper set-up instructions.

13. DMX CHANNEL TRAITS:

The chart below details the channel layout for 17 DMX channels (default).

In 8bit mode the “Pan Fine” and “Tilt Fine” channels are not used, thus converting the fixture into a 15-channel DMX fixture. In extended mode the fixture will use 24 DMX channels (second chart).

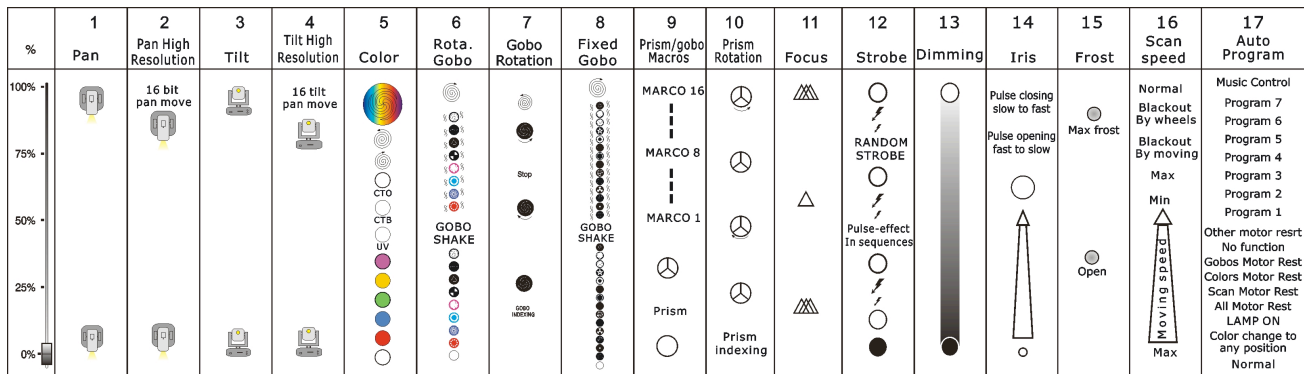

DMX channel function and values:

DMX channel functions and their values (up to 24 DMX channels):				
Mode/Channel			Value	Function
St	Ba	Ex		
1	1	1		<u>PAN Movement 8bit:</u>
			0-255	Pan Movement By 540/630
2		2		<u>Pan Fine 16bit:</u>
			0-255	Fine control of Pan movement
3	2	3		<u>TILT Movement 8bit:</u>
			0-255	Tilt Movement By 270
4		4		<u>Tilt Fine 16bit:</u>
			0-255	Fine control of Tilt movement
5	3	5		<u>Color Wheel:</u>
			0-13	Open / white
			14-27	Color 1
			28-41	Color 2
			42-55	Color 3
		56-69	Color 4	

			70-83	Color 5
			84-97	Color 6
			98-111	Color 7
			112-127	Color 8
			128-189	Forwards rainbow effect from fast to slow
			190-193	No rotation
			194-255	Backwards rainbow effect from slow to fast
		6		<u>Color Wheel Fine:</u>
			0-255	Color Wheel color change to any position (Fine)
				<u>Rotating gobos, cont. rotation:</u>
			0-9	Open
			10-19	Rot. gobo 1
			20-29	Rot. gobo 2
			30-39	Rot. gobo 3
			40-49	Rot. gobo 4
			50-59	Rot. gobo 5
			60-69	Rot. gobo 6
			70-79	Rot. gobo 7
			80-89	Rot. gobo 8
			90-104	Rot. gobo 1 shake
			105-119	Rot. gobo 2 shake
			120-134	Rot. gobo 3 shake
			135-149	Rot. gobo 4 shake
			150-164	Rot. gobo 5 shake
			165-179	Rot. gobo 6 shake
			180-194	Rot. gobo 7 shake
			195-209	Rot. gobo 8 shake
			210-255	Rot. gobo wheel cont. rotation slow to fast
				<u>Rotating gobo index, rotating gobo rotation:</u>
			0-127	Gobo indexing
			128-189	Forwards gobo rotation from fast to slow
			190-193	No rotation
			194-255	Backwards gobo rotation from slow to fast
		9		<u>Rotating gobo indexing Fine</u>
			0-255	Fine indexing
		10		<u>Fixed Gobos:</u>
			0-7	Open/hole
			8-15	Gobo 1
			16-23	Gobo 2
			24-31	Gobo 3
6	4	7		
7	5	8		
8	6	10		

			32-39	Gobo 4
			40-47	Gobo 5
			48-55	Gobo 6
			56-63	Gobo 7
			64-71	Gobo 8
			72-79	Gobo 9
			80-87	Gobo 10
			88-95	Gobo 11
			96-103	Gobo 12
			104-111	Gobo 13
			112-119	Gobo 14
			120-126	Gobo 1 shake slow to fast
			127-133	Gobo 2 shake slow to fast
			134-140	Gobo 3 shake slow to fast
			141-147	Gobo 4 shake slow to fast
			148-154	Gobo 5 shake slow to fast
			155-161	Gobo 6 shake slow to fast
			162-168	Gobo 7 shake slow to fast
			169-175	Gobo 8 shake slow to fast
			176-182	Gobo 9 shake slow to fast
			183-189	Gobo 10 shake slow to fast
			190-196	Gobo 11 shake slow to fast
			197-203	Gobo 12 shake slow to fast
			204-210	Gobo 13 shake slow to fast
			211-217	Gobo 14 shake slow to fast
			218-255	Gobo wheel rotation from slow to fast
		11		<u>Fixed gobo indexing Fine</u>
			0-255	Fixed gobo Fine indexing
9	7	12		<u>3 facet rotating prism, Prism / Gobo macros:</u>
			0-31	Open
			32-127	Rot. Prism
			128-135	Macro 1
			136-143	Macro 2
			144-151	Macro 3
			152-159	Macro 4
			160-167	Macro 5
			168-175	Macro 6
			176-183	Macro 7
			184-191	Macro 8
			192-199	Macro 9

			200-207	Macro 10
			208-215	Macro 11
			216-223	Macro 12
			224-231	Macro 13
			232-239	Macro 14
			240-247	Macro 15
			248-255	Macro 16
10	8	13		<u>Rotating prism, Prism / Gobo macros:</u>
			0-127	Prism indexing
			128-189	Forwards prism rotation from fast to slow
			190-193	No rotation
			194-255	Backwards prism rotation from slow to fast
		14		<u>Rotating Prism indexing Fine</u>
			0-255	Fine indexing
11	9	15		<u>Focus:</u>
			0-255	Continuous adjustment from near to far
		16		<u>Focus Fine:</u>
			0-255	Continuous adjustment Fine
12	10	17		<u>Shutter, strobe:</u>
			0-31	Shutter closed
			32-63	No function (shutter open)
			64-95	Strobe effect slow to fast
			96-127	No function (shutter open)
			128-159	Pulse-effect in sequences
			160-191	No function (shutter open)
			192-223	Random strobe effect slow to fast
			224-255	No function (shutter open)
13	11	18		<u>Dimmer intensity:</u>
			0-255	Intensity 0 to 100%
		19		<u>Fine Dimmer intensity:</u>
			0-255	Dimmer intensity fine
14	12	20		<u>Iris:</u>
			0-191	Maximum diameter to minimum diameter
			192-223	Pulse closing fast to slow
			224-255	Pulse opening slow to fast
		21		<u>Iris Fine:</u>
			0-255	Iris Fine
15	13	22		<u>Frost:</u>
			0-191	Frost 0~100%
			192-223	Pulse opening fast to slow

			224-254	Pulse closing slow to fast
			255	Max. Frost
16	14	23		<u>Speed Pan/Tilt movement:</u>
			0-225	Max to min speed
			226-235	Blackout by movement
			236-245	Blackout by all wheel changing
			246-255	No function
17	15	24		<u>Lamp on/off, reset, internal programs:</u>
			0-19	Color change normal
			20-29	Color change to any position
			30-39	Color & gobo change to any position
			40-59	Lamp on
			60-79	Lamp switch off
			80-84	All motor reset
			85-87	Scan motor reset
			88-90	Colors motor reset
			91-93	Gobo motor reset
			94-96	Shutter & Dimmer motor reset
			97-99	Other motor reset
			100-119	Internal program 1
			120-139	Internal program 2
			140-159	Internal program 3
			160-179	Internal program 4
			180-199	Internal program 5
200-219	Internal program 6			
220-239	Internal program 7			
240-255	Auto program by music			

14. ERROR CODES:

When power is applied, the unit will automatically enter a “reset/test” mode. This mode brings all the internal motors to a home position. If there is an internal problem with one or more of the motors an error code will flash in the display in the form of “XXer” where as XX will represent a motor function. For example, when the display shows “Pan-ER,” it means there is some type of error with the pan motor. If there are multiple errors during the start-up process they will all flash in the display. For example: if the fixtures has errors on channel 1, channel 3, and channel 5 all at the same time, you will see the error message “Pan-Er,” “Tilt-Er,” and “Color-Er” flash repeated 5 times.

If an error does occur during the initial start-up procedure the fixture will self-generate a second reset signal and try to realign all the motors and correct the error, if the error persists after a second attempt a third attempt will be made.

If after a third attempt all the errors have not been corrected the fixture will make the following determinations: 1) 3 or more errors - The fixture cannot function properly with three or more errors therefore the fixture will place itself in a stand-by mode until subsequent repairs can be made. 2) Less than 3 errors - The fixture has less than 3 errors, therefore most other functions will work properly. The fixture will attempt to operate normally until the errors can be corrected by a technician. The errors in question will remain flashing in the display as a reminder of internal errors.

Pan Movement error:

The yoke is not located in the default position after start-up or after a reset command. This message will appear after a fixture reset if the pan-yoke’s magnetic-indexing circuit malfunctions (sensor failed or magnet is missing) or there is a stepper motor failure (defective motor or a defective motor IC drive on the main PCB).

Tilt Movement error:

The head is not located in the default tilt position after start-up or after a reset command. This message will appear after a fixture reset if the tilt magnetic-indexing circuit malfunctions (sensor failed or magnet is missing) or there is a stepper motor failure (defective motor or a

defective motor IC drive on the main PCB).

Color-wheel error:

The color wheel is not located in the default position after start-up or after a reset command. This message will appear after a fixture reset if the color wheel's magnetic-indexing circuit malfunctions (sensor failed or magnet is missing) or there is a stepper motor failure (defective motor or a defective motor IC drive on the main PCB).

Rotating gobo-wheel error:

The gobo-wheel is not located in the default position after start-up or after a reset command. This message will appear after a fixture reset if the gobo wheel's magnetic-indexing circuit malfunctions (sensor failed or magnet is missing) or there is a stepper motor failure (defective motor or a defective motor IC drive on the main PCB).

Rotating gobo indexing error:

The gobo is not located in the default position after start-up or after a reset command. This message will appear after a fixture reset if the gobo positioning magnetic-indexing circuit malfunctions (sensor failed or magnet is missing) or there is a stepper motor failure (defective motor or a defective motor IC drive on the main PCB).

Fix Gobo-wheel error:

This message will appear after the reset of the fixture if the magnetic-indexing circuit malfunctions (sensor failed or magnet missing) or the stepping-motor is defective (or its drive circuit on the main PCB). The fix gobo wheel is not located in the default position after the reset.

Prism Rotation error:

This message will appear after the reset of the fixture and if the magnetic-indexing circuit malfunctions (sensor failed or magnet missing) or the stepping-motor is defective (or its driver circuit on the main PCB). The Prism wheel is not located in the default position after the reset.

Iris error:

This message will appear after the reset of the fixture and if the magnetic-indexing circuit

malfunctions (sensor failed or magnet missing) or the stepping-motor is defective (or its driver circuit on the main PCB). The Iris wheel is not located in the default position after the reset.

Focus-error:

This message will appear after the reset of the fixture and if the magnetic indexing circuit malfunctions (sensor failed or magnet missing) or the stepping-motor is defective (or its driver circuit on the main PCB). The focus motor is not located in the default position after the reset.

15. CLEANING AND MAINTENANCE

The following points have to be considered during the inspection:

1. Be sure all screws and fasteners are securely tightened at all times. Loose screws may fall out during normal operation resulting in damage or injury as larger parts could fall.
2. There must not be any deformations on the housing, color lenses, rigging hardware and rigging points (ceiling, suspension, trussing). Deformations in the housing could allow for UV radiation leakage. Damaged rigging points or unsecured rigging could cause the unit to fall and seriously injure a person.
3. All mechanical parts and motors should not show any traces of serious wear and should rotate freely.
4. Electric power supply cables must not show any damage, material fatigue or sediments. Never remove the ground prong from the power cable.

Further instructions depending on installation and usage have to be adhered by a skilled installer and any safety problems should be addressed before attempting operation.

We recommend frequent cleaning of the fixture, this will ensure operational longevity and crisp light output. When cleaning, please use a moist, lint-free cloth. Never use alcohol or solvents.

There are no user serviceable parts inside this fixture with the exception of the lamp. Please refer all other service related issues to an authorized Elation service technician.

Should you decide to service the fixture yourself please order genuine Elation parts directly from Elation.

16. PHOTOMETRIC DATA:

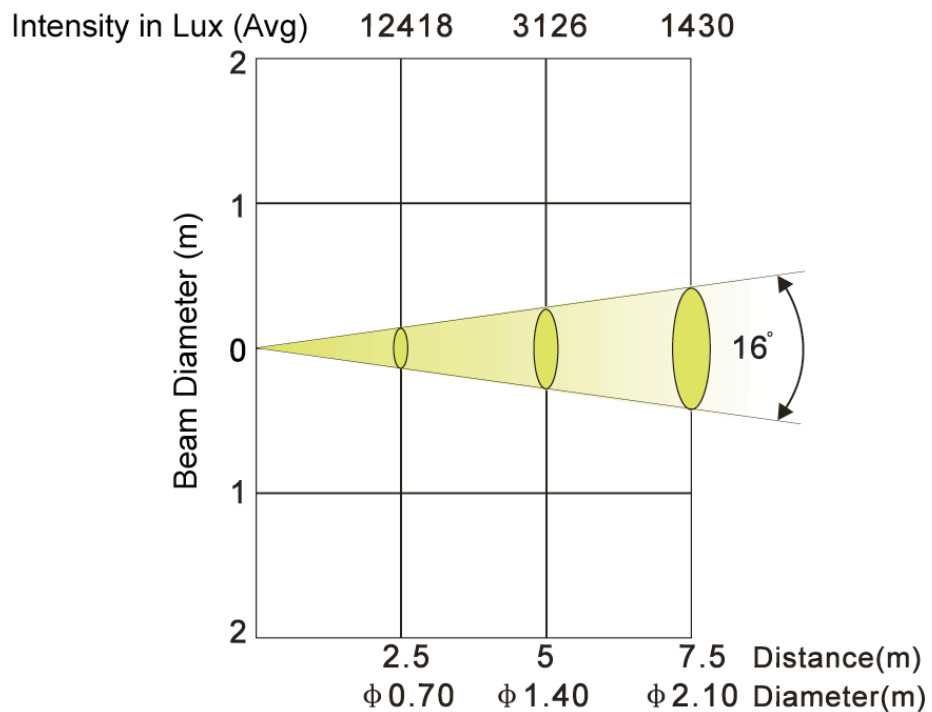
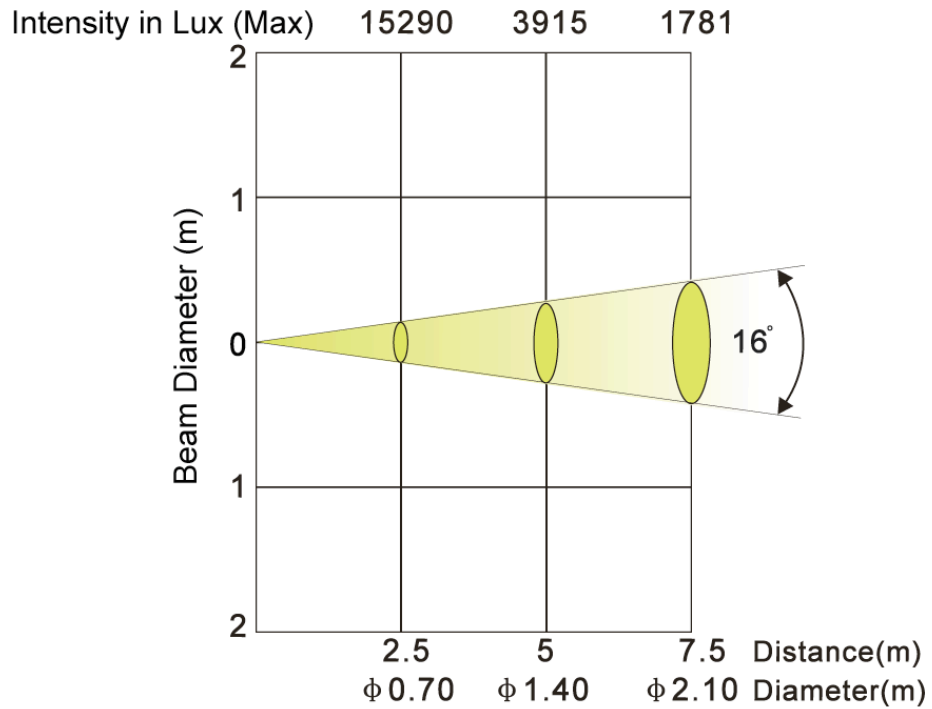

17. GOBOS:

Rotating Gobos



1->



5->

Static Gobos



1->



8->

18. DIMENSIONAL DRAWINGS:

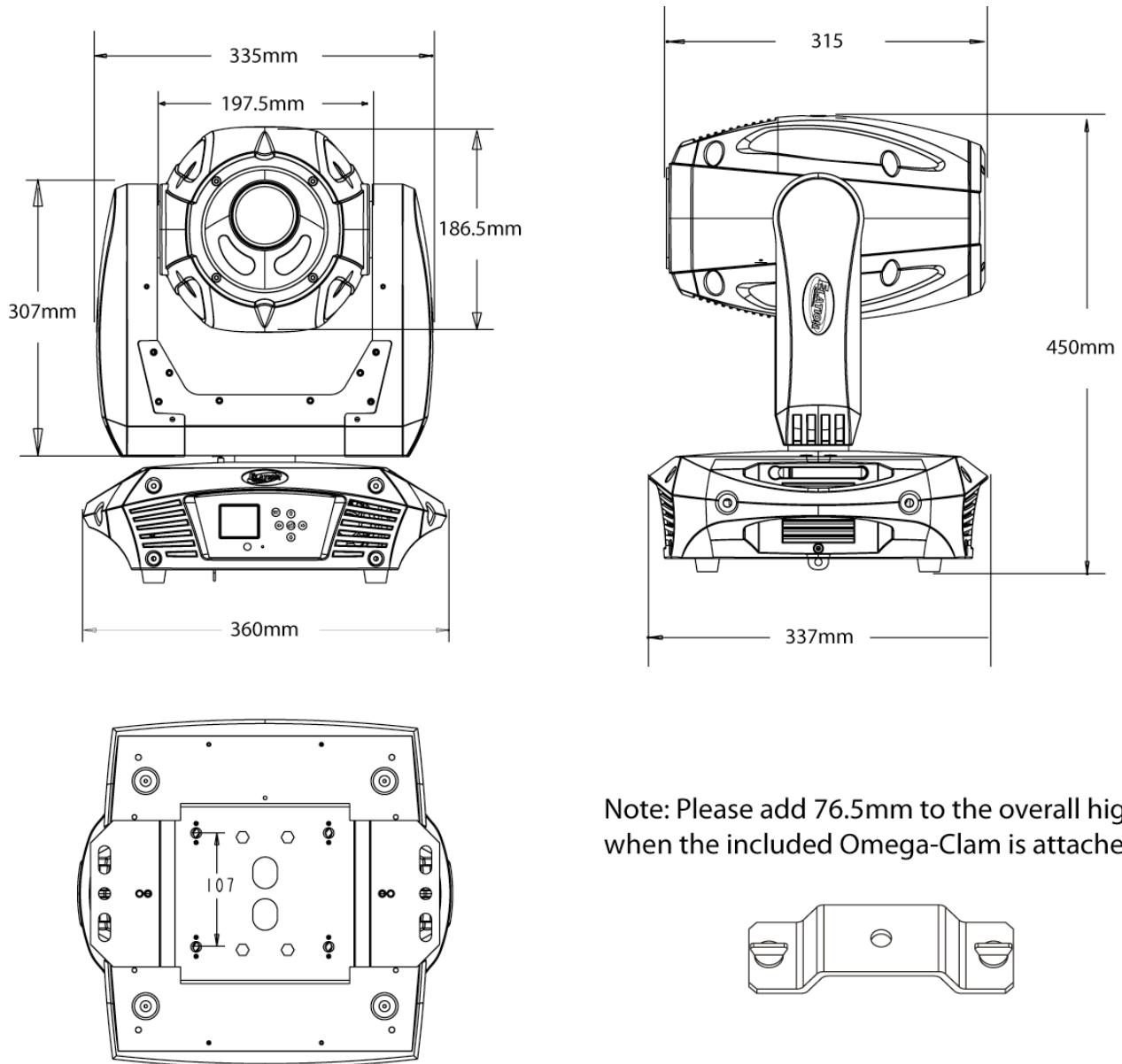

Note: Please add 76.5mm to the overall height when the included Omega-Clam is attached.

20. 2-YEAR LIMITED WARRANTY

A. Elation Professional® hereby warrants, to the original purchaser, Elation Professional® products to be free of manufacturing defects in material and workmanship for a period of two years, (730 days) from the date of purchase. This warranty shall be valid only if the product is purchased within the United States of America, including possessions and territories. It is the owner's responsibility to establish the date and place of purchase by acceptable evidence, at the time service is sought.

B. For warranty service, send the product only to the Elation Professional® factory. All shipping charges must be pre-paid. If the requested repairs or service (including parts replacement) are within the terms of this warranty, Elation Professional® will pay return shipping charges only to a designated point within the United States. If the entire instrument is sent, it must be shipped in its original package. No accessories should be shipped with the product. If any accessories are shipped with the product, Elation Professional® shall have no liability what so ever for loss of or damage to any such accessories, nor for the safe return thereof.

C. This warranty is void if the serial number has been altered or removed; if the product is modified in any manner which Elation Professional® concludes, after inspection, affects the reliability of the product; if the product has been repaired or serviced by anyone other than the Elation Professional® factory unless prior written authorization was issued to purchaser by Elation Professional®; if the product is damaged because not properly maintained as set forth in the instruction manual.

D. This is not a service contract, and this warranty does not include maintenance, cleaning or periodic check-up. During the period specified above, Elation Professional® will replace defective parts at its expense, and will absorb all expenses for warranty service and repair labor by reason of defects in material or workmanship. The sole responsibility of Elation Professional® under this warranty shall be limited to the repair of the product, or replacement thereof, including parts, at the sole discretion of Elation Professional®. All products covered by this warranty were manufactured after January 1, 1990, and bare identifying marks to that

effect.

E. Elation Professional® reserves the right to make changes in design and/or improvements upon its products without any obligation to include these changes in any products theretofore manufactured.

F. No warranty, whether expressed or implied, is given or made with respect to any accessory supplied with products described above. Except to the extent prohibited by applicable law, all implied warranties made by Elation Professional® in connection with this product, including warranties of merchantability or fitness, are limited in duration to the warranty period set forth above. And no warranties, whether expressed or implied, including warranties of merchantability or fitness, shall apply to this product after said period has expired. The consumer's and or Dealer's sole remedy shall be such repair or replacement as is expressly provided above; and under no circumstances shall Elation Professional® be liable for any loss or damage, direct or consequential, arising out of the use of, or inability to use, this product.

G. This warranty is the only written warranty applicable to Elation Professional® Products and supersedes all prior warranties and written descriptions of warranty terms and conditions heretofore published.

21. TECHNICAL SPECIFICATIONS

Power supply	
Power Requirements	120v/60Hz
Fuse Protection	120V = 5A/250V, GMA (5x20mm fine-wire fuse) 220V = 3.15A/250V, GMA (5x20mm fine-wire fuse)
Power Consumption	350 Watts
Lamp	
Type	MSD Platinum 5R (Phillips)
Lamp Wattage	150-189
Life time	2000 Hrs
Color temperature	8000° K
Luminous flux	7950Lm
CRI	75
Optical system	
Parabolic dichroic glass reflector	
Beam angle 16°	
Lenses hardened and tempered, anti-reflex coated	
Colors	
8 dichroic filter plus white, half-color compatible	
Gobos	
Gobo-wheel 1: 8 interchangeable rotating gobos plus "open", 4 glass Gobos	
Gobo-wheel 2: 14 fixed gobos plus "open"	
Gobo outside diameter 14 mm, image size 7 mm	
Gobo thickness (max): <i>glass</i> = 1 mm, <i>steel</i> = 0.15 mm	
Prism	
Rotating 3-face prism, rotating and variable in speed	
Shutter / Strobe / Dimmer	
Strobe effect with variable speed 1 - 10 flashes per second	
Continuously mechanical dimmer 0 - 100%	
Iris	
Motor driven iris from open to close, variable speed, pulse effect	
Focus	
Motor driven focus from near to far away	
DMX Channels	
17 (16bit – default) or 15 (8bit – user selectable) or 24 (16bit – user selectable)	
Drive	
Standard DMX-512, 3 pole XLR; [+] = Pin 3 [-] = Pin 2 [Ground] = Pin 1 or 5 pole XLR; n/a = Pin 5, n/a = Pin 4, [+] = Pin 3, [-] = Pin 2, [Ground] = Pin 1 Starting DMX [001].	
Pan / Tilt	
Pan - movement	630° in max. 2.0 seconds, 16 bit resolution

Tilt - movement	270° in max. 1.5 seconds, 16 bit resolution
Weights and Measures	
Width of the base	18" / 46cm (Including Handles)
Length of the base	13.75" / 35cm (Without Handles)
Width of Head	18.5" / 47cm
Height (head vertical)	25" / 63.5cm
Weight (net)	14.8 Kgs / 33 Lbs
Operating Noise Levels (Base level 46.8dB)	
Mode: Auto	1m = 55.9 dB
Mode: High	1m = 56.2 dB
Mode: Auto	1m = 51.6 db (Lamp off)
Ambient Operating Temperature	
-25°C ~ 45° C	

Specifications subject to change without notice.



Elation Professional
6122 S. Eastern Ave.
Los Angeles, CA. 90040
323-582-3322 / 323-832-9142 fax
www.ElationLighting.com /
Info@ElationLighting.com

Free Manuals Download Website

<http://myh66.com>

<http://usermanuals.us>

<http://www.somanuals.com>

<http://www.4manuals.cc>

<http://www.manual-lib.com>

<http://www.404manual.com>

<http://www.luxmanual.com>

<http://aubethermostatmanual.com>

Golf course search by state

<http://golfingnear.com>

Email search by domain

<http://emailbydomain.com>

Auto manuals search

<http://auto.somanuals.com>

TV manuals search

<http://tv.somanuals.com>