

FRIGIDAIRE

All about the

Use & Care

of your Electric Range with
Induction Cooktop

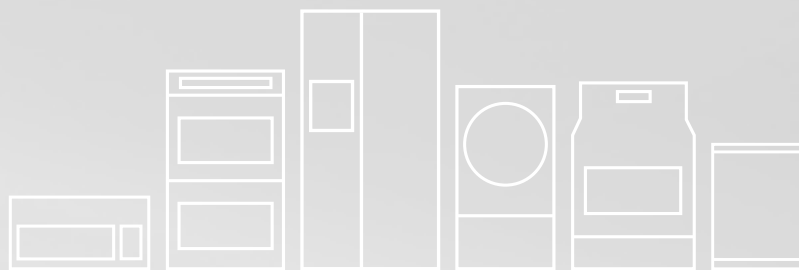

TABLE OF CONTENTS

Important Safety Instructions	3-6	Setting Oven Controls	19-33
Before Setting Surface Controls	7-9	Self-Cleaning	34-35
Induction Cooking Zones	10-12	Care & Cleaning	36-39
Setting Surface Controls	13-15	Before You Call	40-42
Before Setting Oven Controls	16-17	Notes	43
Oven Control Functions (540)	18	Major Appliance Warranty	back cover

PRODUCT RECORD AND REGISTRATION

Contents

Product Registration	2
Important Safety Instructions	3-6
Before Setting Surface Controls	7-9
Benefits of induction surface cooking	7
Induction cookware	7
When using the cooking zones	8
Home Canning	9
Induction Cooking Zones	10-12
Pan Sensing	10-11
Cooktop display windows	12
Setting Surface Controls	13-15
Operating induction cooking zones	13-14
Cooktop operational noises	14
Warmer Zone	15
Before Setting Oven Controls	16-17
Removing, replacing & arranging the oven racks	16
Effortless™ Oven Rack system and assembly	17
Oven Controls Functions	18
Setting Oven Controls	19-33
Setting the clock	19
Changing between continuous bake or 6-Hour Energy Saving features	19
Setting 12 or 24 hour display mode	19
Changing oven temperature display (°F or °C)	19
Setting a silent control panel	20
Setting lockout	20
Setting minute timer	20
Setting bake	21
Setting bake time	21
Setting delayed timed bake	22
Convection cooking	23
Convect bake	23
Convect roast	23
Convect broil	24
Setting convect convert	24
Probe	25-28
Setting broil	29
Setting keep warm	30
Operating the oven light	30
Adjusting oven temperature	31
Restoring factory default settings	31
Setting the Sabbath mode feature	32-33
Self-cleaning	34-35
Care & Cleaning	36-39
Cleaning recommendation table	36
Cooktop maintenance and cleaning	37-38
Replacing the oven light	38
Removing and replacing oven door	39
Before You Call - Solutions to common problems ...	40-42
Notes	43
Appliance Warranty	back cover

Thank you for choosing **Frigidaire**.

This Use & Care Guide is part of our commitment to customer satisfaction and product quality throughout the service life of your new appliance. We view your purchase as the beginning of a relationship. To ensure our ability to continue serving you, please use this page to record important product information.

Need help??

Visit the **Frigidaire** web site at www.frigidaire.com
Before you call for service, there are a few things you can do to help us serve you better.

Read this Use & Care manual.

It contains instructions to help you use and maintain your range properly.

If you received a damaged range ...

Immediately contact the dealer or builder that sold you the range.

Save time and money.

Check the section titled "Before you call." This section helps step you through some common problems that might occur. If you do need service, help is only a phone call away. Call Frigidaire Customer Services at **1-800-944-9044**.

Product Registration

Registering your product with Frigidaire enhances our ability to serve you. You can register online at www.frigidaire.com or by dropping your Product Registration Card in the mail.

Serial plate location

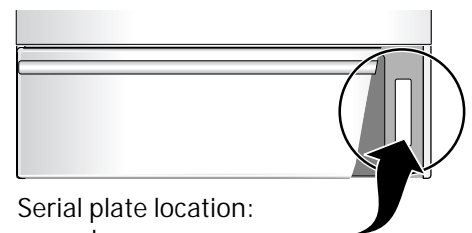

Serial plate location:
open drawer.

Record model & serial numbers here

Purchase date

Model number

Serial number

IMPORTANT SAFETY INSTRUCTIONS

Read all instructions before using this appliance.

Important Safety Instructions

Do not attempt to install or operate your appliance until you have read the safety precautions in this manual. Safety items throughout this manual are labeled with a WARNING or CAUTION statement based on the risk type.

Definitions

! This is the safety alert symbol. It is used to alert you to potential personal injury hazards. Obey all safety messages that follow this symbol to avoid possible injury or death.

! WARNING

WARNING indicates a potentially hazardous situation which, if not avoided, may result in death or serious injury.

! CAUTION

CAUTION indicates a potentially hazardous situation which, if not avoided, may result in minor or moderate injury.

➔ IMPORTANT

IMPORTANT indicates installation, operation, maintenance or valuable information that is not hazard related.

- **Remove all tape and packaging before using the range.** Destroy the carton and plastic bags after unpacking the range. Never allow children to play with packaging material.
- **Proper installation—Be sure your appliance is properly installed and grounded by a qualified technician in accordance with the National Electrical Code ANSI/NFPA No. 70 latest edition and local electrical code requirements.** Install only per installation instructions provided in the literature package for this range.

! CAUTION

Persons with a pacemaker or similar medical device should exercise caution using or standing near an induction unit while it is in operation, as the electromagnetic field may affect the working of the pacemaker or similar medical device. It would be advisable to consult your Doctor or the pacemaker or similar medical device manufacturer about your particular situation.

This appliance has been tested and found to comply with the limits for a class B digital device, pursuant to Part 18 of the FCC rules. These limits are designed to provide reasonable protection against harmful interference in a residential installation. This unit generates, uses and can radiate radio frequency energy and, if not installed and used in accordance with the instructions, may cause harmful interference to radio communications. However there is no guarantee that interference will not occur in a particular installation. If this unit does cause harmful interference to radio or television reception, which can be determined by turning the unit off and on, the user is encouraged to try to correct the interference by one or more of the following measures:

- Reorient or relocate the receiving antennae.
- Increase the distance between the unit and receiver.
- Connect the unit into an outlet or a circuit different from that to which the receiver is connected.

! WARNING

Tip-over Hazard

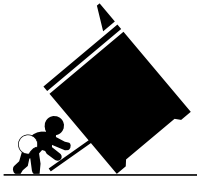

- A child or adult can tip the range and be killed.
- Verify the anti-tip device has been installed to floor or wall.
- Ensure the anti-tip device is re-engaged when the range is moved to floor or wall.
- Do not operate the range without the anti-tip device in place and engaged.
- Failure to follow these instructions can result in death or serious burns to children and adults.

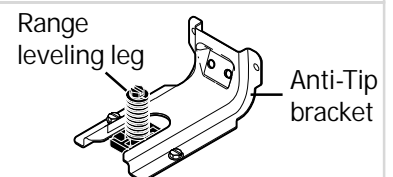

To check if the anti-tip bracket is installed properly, use both arms and grasp the rear edge of range back. Carefully attempt to tilt range forward. When properly installed, the range should not tilt forward.

Refer to the anti-tip bracket **installation instructions** supplied with your range for proper installation.

Save these instructions for future reference.

IMPORTANT SAFETY INSTRUCTIONS

- Never modify or alter the construction of a range by removing the leveling legs, panels, wire covers, anti-tip brackets/screws, or any other part of the range.
- Remove the oven door from any unused range if it is to be stored or discarded.
- User servicing—Do not repair or replace any part of the appliance unless specifically recommended in the manuals. All other servicing should be done only by a qualified technician. This may reduce the risk of personal injury and damage to the range.
- Ask your dealer to recommend a qualified technician and an authorized repair service. Know how to disconnect the power to the range at the circuit breaker or fuse box in case of an emergency.
- Do not cook food on the oven bottom. Always cook in proper cookware and always use the oven racks.
- When you are flaming foods under a ventilating hood, turn the fan on.
- Clean ventilating hoods frequently - grease should not be allowed to accumulate on the hood or the filter.

WARNING

- **DO NOT LEAVE CHILDREN ALONE**—children should not be left alone or unattended in the area where appliance is in use. They should never be allowed to sit or stand on any part of the appliance, including the storage drawer, lower broiler drawer, warmer drawer or lower double oven.
- **Stepping, leaning or sitting on the door or drawers of a range can result in serious injuries and also cause damage to the appliance.** DO NOT allow children to climb or play around the range. The weight of a child on an open oven door may cause the range to tip, resulting in serious burns or other injury.
- **Storage in or on appliance—flammable materials should not be stored in an oven, warmer drawer, near surface units or in the storage drawer.** This includes paper, plastic and cloth items, such as cookbooks, plasticware and towels, as well as flammable liquids. Do not store explosives, such as aerosol cans, on or near the range.
- **Never use your appliance for warming or heating the room. Doing so may result in carbon monoxide poisoning.**

CAUTION

- **Do not store items of interest to children in the cabinets above a range or on the backguard of the range.** Children climbing on the range to reach items could be seriously injured.
- **Do not touch surface heating units or surface cooking elements, areas near these units or elements, or interior surface of the oven.** Both surface heating and oven heating elements may be hot even though they are dark in color. Areas near surface cooking units may become hot enough to cause burns. During and after use, do not touch, or let clothing or other flammable materials touch these areas until they have had sufficient time to cool. Among these areas are the cook top, surfaces facing the cook top, the oven vent openings and surfaces near these openings, oven door and oven door window.
- **Wear proper apparel—loose-fitting or hanging garments should never be worn while using the appliance.** Do not let clothing or other flammable materials contact hot surfaces.
- **Do not heat unopened food containers - buildup of pressure may cause container to burst and result in injury.**
- **Do not use water or flour on grease fires—smother the fire with a pan lid, or use baking soda, a dry chemical or foam-type extinguisher.**
- **When heating fat or grease, watch it closely.** Fat or grease may catch fire if allowed to become too hot.
- **Use dry potholders - moist or damp potholders on hot surfaces may result in burns from steam.** Do not let potholders touch hot heating elements. Do not use a towel or other bulky cloth instead of a potholder.

IMPORTANT

Do not attempt to operate the range during a power failure. If the power fails, always turn off the range. If the range is not turned off and the power resumes, the range will begin to operate again. Once the power resumes, reset the clock and oven function.

IMPORTANT SAFETY INSTRUCTIONS

IMPORTANT INSTRUCTIONS FOR USING YOUR OVEN

- **Use care when opening oven door , lower oven door or warmer drawer** (if equipped)—Stand to the side of the range when opening the door of a hot oven. Let hot air or steam escape before you remove or replace food in the oven.
- **Keep oven vent ducts unobstructed.** The oven vent is located under the left rear surface element if your model is equipped with coil elements. The oven vent is located below the backguard for models equipped with ceramic-glass cook tops. Touching the surfaces in this area when the oven is operating may cause severe burns. Also, do not place plastic or heat-sensitive items on or near the oven vent. These items could melt or ignite.
- **Placement of interior oven racks.** Always place oven racks in desired location while oven is cool. If rack must be moved while oven is hot use extreme caution. Use potholders and grasp the rack with both hands to reposition. Do not let potholders contact the hot heating elements in the oven. Remove all utensils from the rack before moving.
- **Do not use the broiler pan without its insert.** The broiler pan and its insert allow dripping fat to drain and be kept away from the high heat of the broiler. **Do not cover the broiler insert with aluminum foil. Exposed fat and grease could ignite.**
- **Protective liners**—Do not use aluminum foil to line the oven bottom. Only use aluminum foil as recommended in this manual. Improper installation of these liners may result in risk of electric shock, or fire.

FOR CERAMIC-GLASS COOK TOP MODELS

- **Do not cook on broken cook top**—If cook top should break, cleaning solutions and spillovers may penetrate the broken cook top and create a risk of electric shock. Contact a qualified technician immediately.
- **Clean cook top with caution**—If a wet sponge or cloth is used to wipe spills on a hot cooking area, be careful to avoid a steam burn. Some cleaners can produce noxious fumes if applied to a hot surface.

IMPORTANT INSTRUCTIONS FOR CLEANING YOUR RANGE

CAUTION

Before manually cleaning any part of the range, be sure all controls are turned OFF and the range is COOL. The range may be hot and can cause burns.

- **Clean the range regularly to keep all parts free of grease that could catch fire.** Pay particular attention to the area around each surface element. Do not allow grease to accumulate.
- **Kitchen cleaners and aerosols**—Always follow the manufacturer's recommended directions for use. Be aware that excess residue from cleaners and aerosols may ignite causing damage and injury.
- **Clean ventilating hoods frequently**—Grease should not be allowed to accumulate on the hood or filter. Follow the manufacturer's instructions for cleaning hoods.

SELF-CLEANING OVENS

- **Clean in the self-cleaning cycle only the parts listed in this Use & Care Manual.** Before self-cleaning the oven, remove the broiler pan and any utensils or foods from the oven.
- **Do Not Use Oven Cleaners**—No commercial oven cleaner or oven liner protective coating of any kind should be used in or around any part of the oven.
- **Do Not Clean Door Gasket**—The door gasket is essential for a good seal. Care should be taken not to rub, damage or move the gasket.
- The health of some birds is extremely sensitive to the fumes given off during the self-cleaning cycle of any range. Move birds to another well-ventilated room.

IMPORTANT SAFETY NOTICE

The California Safe Drinking Water and Toxic Enforcement Act requires the Governor of California to publish a list of substances known to the state to cause cancer, birth defects or other reproductive harm, and requires businesses to warn customers of potential exposure to such substances.

IMPORTANT SAFETY INSTRUCTIONS

IMPORTANT INSTRUCTIONS FOR USING YOUR COOKTOP

- Know which keypad controls each surface cooking zone. Place a pan with food on the cooking zone before turning it on, and turn the cooking zone off before removing the pan.
- Use proper pan size —This appliance is equipped with induction cooking zones of different sizes. Select utensils specifically manufactured and approved for induction cooking that have flat bottoms that match the induction cooking zone size. Proper relationship of utensil to cooking zone will also improve efficiency.
- Utensil handles should be turned inward and not extend over adjacent cooking zones—To reduce the risk of burns, ignition of flammable materials, and spillage due to unintentional contact with the utensil, the handle of the utensil should be positioned so that it is turned inward, and does not extend over adjacent cooking zones.
- Never leave surface cooking zones unattended — Boilovers cause smoking and greasy spillovers that may ignite, or a pan that has boiled dry could be damaged.

GROUNDING INSTRUCTIONS

For models factory-equipped with a power cord:

For personal safety, this appliance must be properly grounded. For maximum safety, the power cord must be plugged into an electrical outlet that is correctly polarized and properly grounded. If a 2-prong wall receptacle is the only available outlet, it is the personal responsibility of the consumer to have it replaced with a properly grounded 3-prong wall receptacle installed by a qualified electrician.

Grounding type wall receptacle

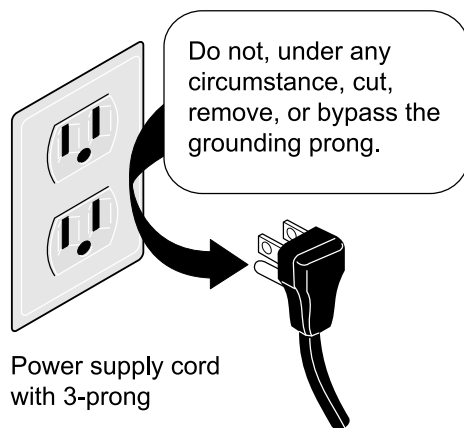

WARNING

- Avoid fire hazard or electrical shock. Do not use an adapter plug, an extension cord, or remove grounding prong from electrical power cord. Failure to follow this warning can cause serious injury, fire or death.
- This appliance may be equipped with a 3-prong grounding plug. For your protection against shock hazard, it should be plugged directly into a properly grounded receptacle. Do not cut or remove the grounding prong from this plug

See the **INSTALLATION INSTRUCTIONS** packaged with this appliance for complete installation and grounding instructions.

BEFORE SETTING SURFACE CONTROLS

Benefits of induction surface cooking

Fast and efficient - The induction cooking zones heat faster while using less energy. Induction power levels are quick to boil and efficient when simmering.

A cooler cooktop - A unique feature of the induction cooking zones is whether turned on or off, the cooking zones remain cooler than radiant type elements. Virtually no wasted heat is produced since the heat begins with the presence of cookware.

Easy cleanups - The cooler cooking zones make cleanup easier. Spills resist sticking or burning so they wipe up easily.

Magnetic detector - The cooking zone has a sensor that automatically detects whether cookware is magnetic. This will reduce accidental "turn-ons."

Pan size detection - The pan size recognition sensor automatically detects and adapts the induction cooking zones to the pan sizes in use for consistent, more even cooking.

More responsive - The induction cooking zones are more responsive than their electric or gas counterparts because only the pan heats. This type of cooking heats easier and will be just as responsive when reducing to a simmer.

About the induction cooktop

Your cooktop is equipped with four differently-sized induction cooking zones and a radiant heat warmer zone.

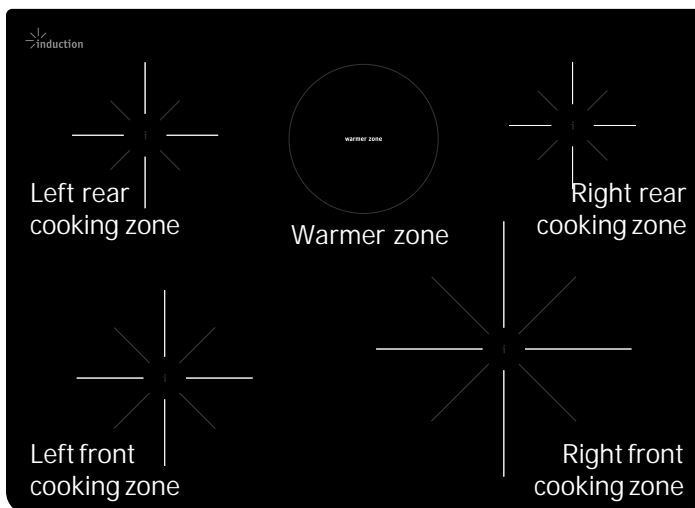

Induction cooking directly heats the pan; heating will only begin when cookware is properly placed on the cooking zones.

Induction cookware

➔ IMPORTANT

Before using the induction cooking zones, be sure to carefully read and follow these cookware recommendations and the instructions in the **pan sensing** section.

When purchasing pans for use on the induction cooktop, look for cookware specifically identified by the manufacturer as **induction ready**, **induction capable**, or a similar statement by the manufacturer that the cookware is specifically designed for induction cooking.

The cooking zones will not activate if the cookware is not constructed with a base magnetic material. To check if the cookware base material is suitable, use a magnet to test (See Fig. 1). If a magnet sticks to the bottom of the cookware, the material type is correct.

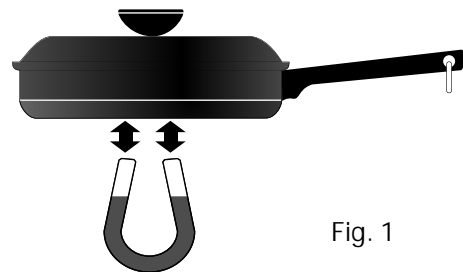

Fig. 1

For the best possible surface cooking results, it is recommended to only use high quality heavy gauge cookware on the induction cooking zones.

Be sure to follow all the manufacturer's recommendations when using cookware made for induction cooking.

Induction cookware types

The most common induction cookware types available are:

Stainless steel - Generally, excellent for induction cooking. Is durable, easy to clean and resists staining.

Cast iron - Good for induction cooking. Cooks evenly. Do not slide cast iron cookware on cooktop. Cast iron cookware with a rough surface will scratch ceramic cooktop.

Porcelain-enamel on ferrous metal - Heating characteristics will vary depending on quality of base material. Porcelain-enamel coating must be smooth to avoid scratching ceramic cooktop.

➔ IMPORTANT

Not all stainless steel cookware is magnetic; stainless steel is not always suitable for induction cooking.

BEFORE SETTING SURFACE CONTROLS

When using the cooking zones

- Be sure to use cooktop cookware made with a magnetic base material.
- Use quality cooktop cookware with heavier bottoms for better heat distribution, allowing for more even cooking results.
- Check that cookware bottom rests level on cooktop surface. Cookware should have flat bottoms that make good contact with the entire induction cooking zone area. Check for flatness by rotating a ruler across the bottom of the cookware (See Fig. 1).
- Be sure cookware is properly balanced and does not tilt from a heavy handle.
- Be sure that the pan size matches the amount of food to be prepared. The size and type of cookware used will influence the setting needed for best cooking results.
- Never let cookware boil dry. This may cause permanent damage such as breakage, fusion, or marring that can affect the cooktop.
- Use cookware that meets the minimum and maximum cookware size requirements for each cooking zone.

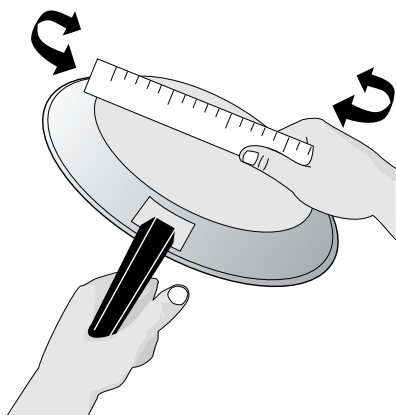

Fig. 1

Moving cookware on smoothtop

It is recommended to always use heavier gauge high quality cookware on the cooking zones. Even high quality cookware can still scratch the cooktop surface. Do not slide cookware on the ceramic cooktop.

➔ IMPORTANT

- Always lift cookware before moving on the ceramic glass smoothtop.
- Any cookware that has rough or dirty bottoms can **mark and scratch** the ceramic glass surface. Always start with clean cookware.

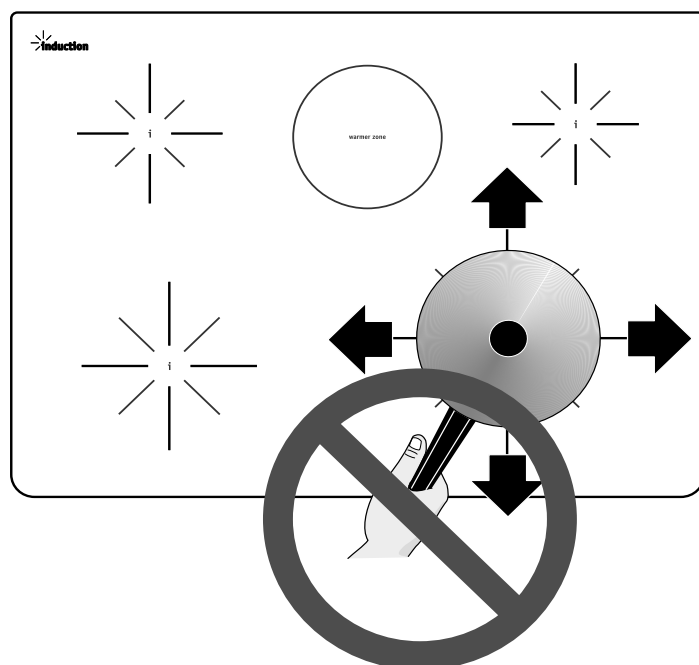

Fig. 2

Sliding any type of cookware over the surface will scratch the cooktop over time. Scratches will make cleaning the ceramic cooktop difficult and degrade the appearance of the cooktop.

For more detailed information about the cooktop see "Cooktop maintenance" and "Cooktop cleaning" in the **Care & Cleaning** section.

BEFORE SETTING SURFACE CONTROLS

Hot cookware and residual heat

CAUTION

- Unlike radiant surface elements, the **cooking zones** will not glow red when they are **hot**. **The glass surface may be hot** from residual heat transferred from the cookware and burns may occur.
- **Do not touch hot cookware or pans directly with hands.** Always use oven mitts or pot holders to protect hands from burns.

The type and size of cookware, cooking duration, the number of cooking zones in use and their power level settings are all factors that will affect the amount of heat that will spread beyond the cooking zones.

The induction cooking zones and areas surrounding the cooking zones may become **hot enough to cause burns**. **Be sure to read all cautions.**

Home Canning

Be sure to read and observe all the following points when home canning with your appliance. Check with the USDA (United States Department of Agriculture) website and be sure to read all the information they have available as well as follow their recommendations for home canning procedures.

- Use only quality flat bottom canners when home canning. Use a straight-edge to check canner bottom (see **Cookware Recommendations** section).
- Use only a **completely flat bottom canner** with no ridges that radiate from the bottom center when home canning using a range with a ceramic glass cooktop.
- **Make sure the diameter of the canner does not exceed 1 inch beyond the cooking zone markings.** It is recommended to use smaller diameter canners on ranges with ceramic glass or open coil electric cooktops.
- Start with hot tap water to bring water to boil more quickly.
- Use the highest heat setting when first bringing the water to a boil. Once boiling is achieved, reduce heat to lowest possible setting to maintain that boil.

IMPORTANT

NEVER place or straddle a cooking utensil over 2 different surface cooking zones heating at the same time. This will cause uneven heating results and could cause the ceramic cooktop to fracture.

INDUCTION COOKING ZONES

Pan sensing

The cooking zone sensors located below the cooktop surface require that certain cookware conditions are met before the induction cooking zones can operate.

The cooking zone display windows may display a pan sensing error message. If a cooking zone is activated and no cookware is detected, the affected induction cooking zone display window will flash with the last power level request setting (See Fig. 1). If the cookware does not meet the correct conditions, the cooking zones may not heat.



Fig. 1

The conditions that may generate a flashing error message are illustrated in Figure 2. Use Figure 2 as a guide to help to correct the problem or problems before attempting to reactivate any of the cooking zones.

If the problem or problems are not corrected, the affected cooking zone will automatically deactivate after 3 minutes.

NOTE

It is recommended that you lower the requested power level setting before correcting the pan sensing message.

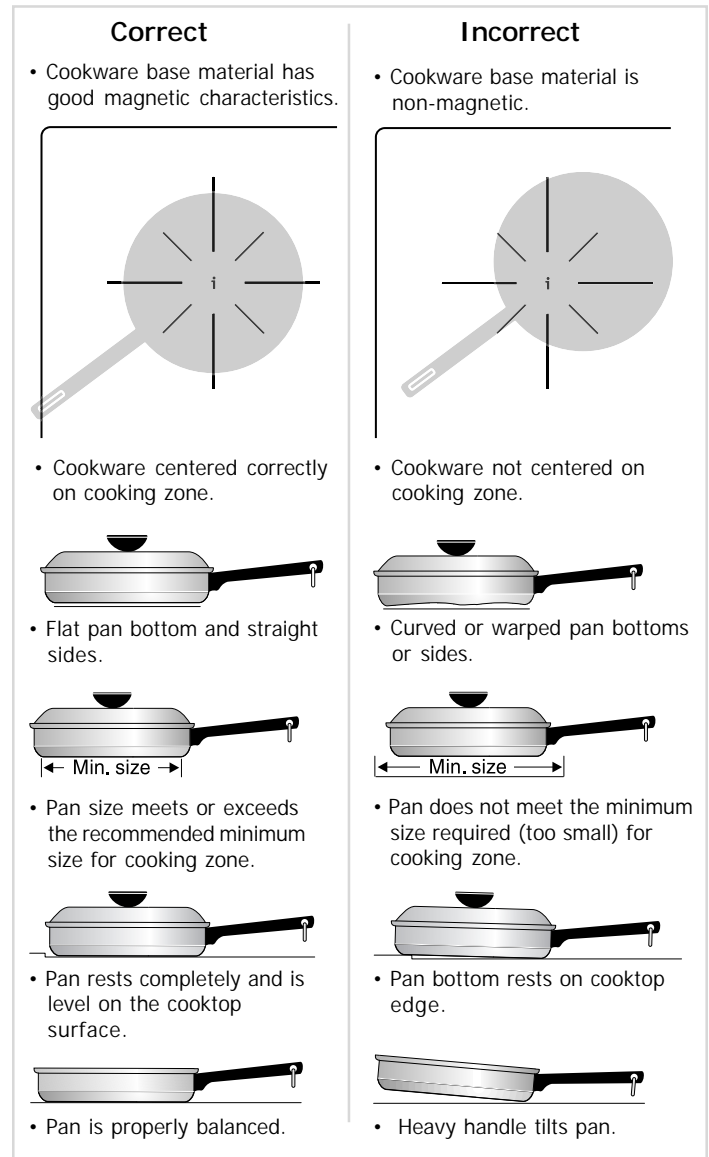

Fig. 2

Pan sensing-induction cooking zones (cont'd)

Minimum pan size

Induction cooking zones require a minimum pan size in order to activate. The graphics on each cooking zone location are your guide to the correct minimum pan size for that zone. The shorter lines guide the minimum pan size (see Figure 1). The cookware bottom must meet the minimum area for the heating process to begin.

If a pan that is induction-capable is centered properly but is **too small**, the affected cooking zone display will flash the last power level setting and the pan will not heat. Select a larger pan that meets the minimum size requirement to activate the cooking zone.

See Figure 1 for the minimum pan size requirements for each cooking zone location.

Maximum recommended pan size

The graphics on each cooking zone location are your guide to the correct maximum pan size for that zone. The longer lines guide the maximum pan size (see Figure 1).

It is recommended to not use pans with bottoms that extend more than 1/2" (13mm) beyond any of the longer line marks provided on the cooktop.

The cookware must make full contact with the ceramic glass surface. Cookware should not rest on or touch the metal edges of the cooktop.

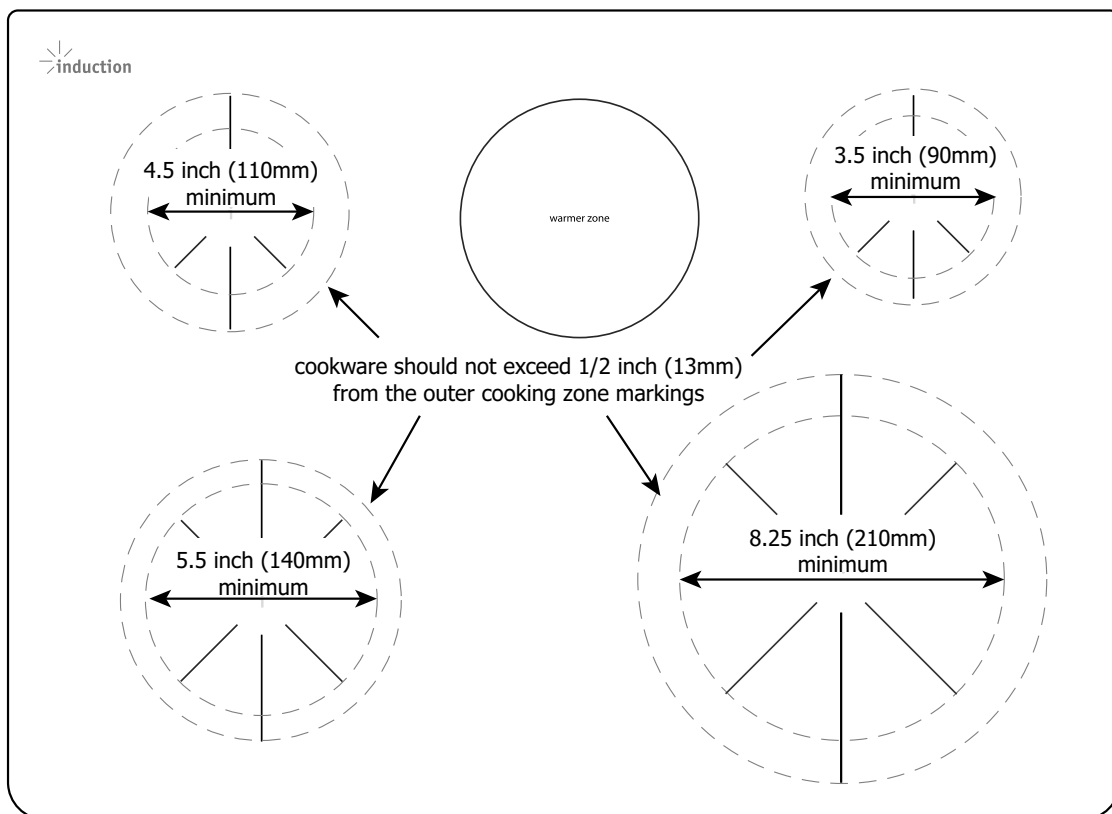

Fig. 1 - Induction cooking zones minimum pan size requirements

INDUCTION COOKING ZONES

Cooktop display windows

The range backguard provides a digital window for each of the cooking zones located on the cooktop. Power levels and messages are easily monitored and controlled using the window displays in combination with the corresponding control knobs.

Available power level settings

The cooktop control (Fig. 1) will display power levels ranging from **Pb** (power boost, Fig. 2), **Hi** (Fig. 3) to **Lo** (Fig. 4).

The settings between 9.5 (Fig. 5) and 1.5 (Fig. 7) decrease and increase in 0.5 increments.

Use the "Suggested cooking zone power level settings table" provided in **Setting Surface Controls** section to determine the correct power level setting for the type of food you are preparing.

Pb (Power Boost) power level

When setting an induction cooking zone for **Hi**, the display will initially show **Pb** (Power Boost) power level for up to 10 minutes (See Fig. 1). After 10 minutes the cooking zone will automatically return to the **Hi** (Fig. 3) setting. The **Pb** setting is only available immediately after activating a cooking zone by turning the knob to **Hi**.

(HE) Hot surface window message

After using an induction cooking zone, the cooktop may become very hot. After turning any cooking zone OFF, the cooktop may remain HOT for some time. The corresponding **HE** (hot element - Fig. 8) message will remain ON until the cooktop has cooled.

ESEC Error Indicator Message (Er)

An error message will be displayed (flashing "Er") (Fig. 6) at power up (or after a power failure) if ANY of the surface control knobs were left in the ON positions. If a power failure should occur, be sure to set all of the 4 surface control knobs to the OFF position (See Fig. 1). This will reset the surface controls.

Be sure to reset the clock (See page 19). Once the surface controls have been set to the OFF positions and the clock has been set with the correct time of day, the surface controls should return to normal operation. If the surface controls do not function and the "Er" message remains in any display after following these procedures, contact an authorized servicer for assistance.

(- -) Lockout window message

The (- -) message will appear whenever the Lockout, Self-clean or Sabbath feature is active (See Fig. 9). Refer to the **Lockout** instructions for more details.

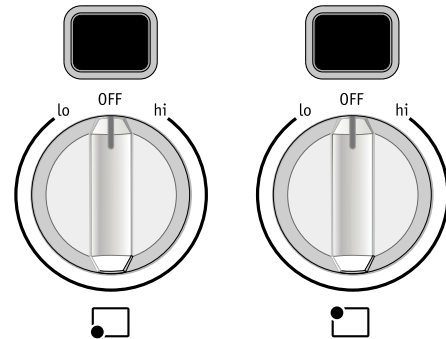

Fig. 1



Fig. 2

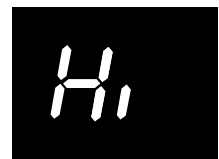

Fig. 3



Fig. 4



Fig. 5



Fig. 6

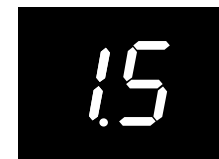

Fig. 7



Fig. 8



Fig. 9

➔ IMPORTANT

The induction cooking zones will not operate when the oven is set for Sabbath mode. For more details on the Sabbath feature, see **Setting Oven Controls** section.

SETTING SURFACE CONTROLS

Operating induction cooking zones

Start most surface cooking on a higher setting and then adjust to a lower setting to finish cooking.

The suggested settings (provided in Fig. 1) may vary slightly depending on the cookware design, quality and amount of food being prepared.

Be sure to use quality cookware that is constructed with magnetic base material and meets the minimum and maximum pan size requirements.

Suggested cooking zone power level settings

Settings	Type of cooking
Power boost (Pb)	Use to start heating pans that contain large amounts of food or to bring large pans of water to boil
High (8.0-Hi)	Start most foods, bring water to a boil, pan broiling
Medium high (5.0 - 8.0)	Continue a rapid boil, fry, deep fat fry
Medium (4.0 - 5.0)	Maintain a slow boil, thicken sauces and gravies or steam vegetables
Medium low (2.0 - 4.0)	Keep foods cooking, poach, stew (3.0 or lower is a simmer setting)
Low (Lo - 2.0)	Keep warm, melt, simmer

Fig. 1

NOTES

- The suggested power level settings shown in Fig. 1 are based on cooking with medium sized pans with lids. Be sure to make any further setting adjustments needed for best surface cooking results.
- The size and type of utensil used, and the amount and type of food being cooked will influence the setting needed for best cooking results.

Pan preheat recommendations

Be aware that induction cooking may decrease the amount of time required to preheat a cooking utensil compared to cooking on a radiant element cooktop or gas surface burner.

Whenever using the cooktop or oven always pay close attention to all food items cooking and remain very attentive until all the cooking processes are complete.

IMPORTANT

Remember that induction surface cooking will initially heat the cooking utensil very quickly.

To operate induction cooking zones:

Step

1. Place induction cookware on the desired cooking zone.
2. To activate the cooking zone, push in and turn the control knob in either direction to the desired setting.
3. Adjust the power level by turning the knob. This will decrease or increase the power level. Power levels **9.5** through **1.5** decrease and increase by 0.5 increments. **Lo** is the lowest power level available.
4. Once cooking is complete, turn the control knob to **OFF** and remove cookware.

SETTING SURFACE CONTROLS

CAUTION

- Unlike radiant surface elements, the **induction cooking zones** will not glow red when they are **hot**. The glass surface **may be hot** from residual heat transferred from the cookware and burns may occur.
- **Do not touch hot cookware or pans directly with hands.** Always use oven mitts or pot holders to protect hands from burns.
- The cooking zones may appear to have cooled after they have been turned OFF. **The glass surface may still be hot** from residual heat and burns may occur if the cooktop is touched before it has cooled sufficiently.
- **Do not place flammable items** such as plastic salt and pepper shakers, spoon holders or plastic wrappings on the cooktop when it is in use. These items could melt or ignite if placed too close to hot cookware.

IMPORTANT

- The **HE** (hot element) message will appear in the display windows once a heating element or cooking zone is turned OFF and will remain ON until the heating surface area or areas have cooled sufficiently.
- **Do not allow aluminum foil, or ANY material that can melt to make contact with the ceramic glass cooktop.** If these items melt on the cooktop they may damage the ceramic cooktop.
- If the cookware is moved from the center of any active induction cooking zone, the pan sensor will detect the situation and the cookware will no longer heat. The affected cooking zone display window will flash until the cookware is moved back to center of cooking zone. If the cookware is placed back properly centered on the cooking zone, the zone will resume heating. The cooking zone will remember the power level setting for up to 3 minutes before the cooking zone will automatically shut OFF.

Cooktop operational noises

The electronic processes involved with induction cooking may create some background noises. You may hear a slight “buzzing” sound when cooking on the cooktop.

These noises are part of the induction cooking process are considered normal.

Some cookware will “buzz” depending on the construction or base material. The “buzz” may be more noticeable if the contents of the pan are cold. As the pan heats up, the noise will decrease. The noise will also decrease if the power level setting is reduced.

NOTE

When using the induction cooktop, operational noises are more noticeable while cooking at the “Pb” level. Very loud noises are not part of normal induction cooking.

Oven vent location

The oven vent is located **under the left side of the control panel** (See Fig. 1). When the oven is on, warm air passes through this vent. This venting is necessary for proper air circulation in the oven and good baking results. **Do not block the oven vent.**

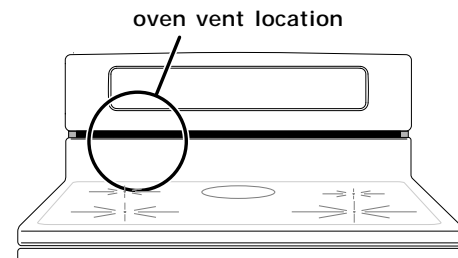
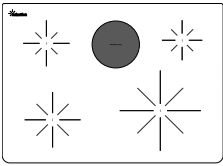

Fig. 1

SETTING SURFACE CONTROLS

Warmer zone



The purpose of the warmer zone is to keep foods at serving temperature, such as: vegetables, gravies, casseroles, soups, stews, breads, pastries and oven-safe dinner plates.

Always start with hot food. Do not heat cold food on the warmer zone. All food placed on the warmer zone should be covered with a lid to maintain quality.

For best results, when warming pastries or breads, the cover should have an opening to allow moisture to escape. Do not use plastic wrap to cover food. Plastic may melt onto the surface and be very difficult to remove. Use only dishware, utensils and cookware recommended for oven and cooktop use.

Warmer zone temperature selection

If a particular food is not listed (See Fig 2), start with the medium heat level and adjust as needed. Most foods can be kept at serving temperatures by using the medium heat level.

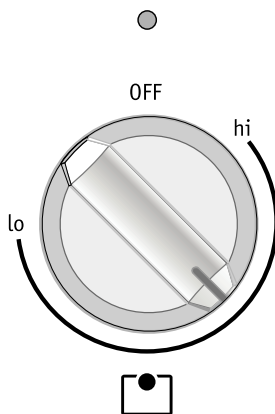

Fig. 1

Warmer zone recommended food settings table

Food Item	Heating Level
Breads/Pastries	lo (Low)
Casseroles	lo (Low)
Dinner plates with food	lo (Low)
Eggs	lo (Low)
Gravies	lo (Low)
Meats	med (Medium)
Sauces	med (Medium)
Soups (cream)	med (Medium)
Stews	med (Medium)
Vegetables	med (Medium)
Fried foods	hi (High)
Hot beverages	hi (High)
Soups (liquid)	hi (High)

Fig. 2

To operate warmer zone:

Step

1. Place cookware on the **warmer zone**.
2. Push in and turn the warmer zone's control knob to the desired setting, indicated by the semi-circle line around the knob. You may turn the knob either way (left or right) to activate the burner. (The warmer zone indicator light will turn on).
3. When finished, turn the control knob to the **OFF** position.

CAUTION

- Radiant surface elements may appear to have cooled after they have been turned off. **The glass surface may still be hot** and burns may occur if the glass surface is touched before it has cooled.
- **Do not place flammable items** such as plastic salt and pepper shakers, spoon holders or plastic wrappings on top of the range when it is in use. These items could melt or ignite. Potholders, towels or wooden spoons could catch fire if placed too close to the surface elements.
- The warmer zone is radiant heat, but it will not glow red when it is hot. To avoid possible burns always use potholders or oven mitts when moving food to and from the **warmer zone** as cookware and plates **will be hot**.

BEFORE SETTING OVEN CONTROLS

Types of oven racks

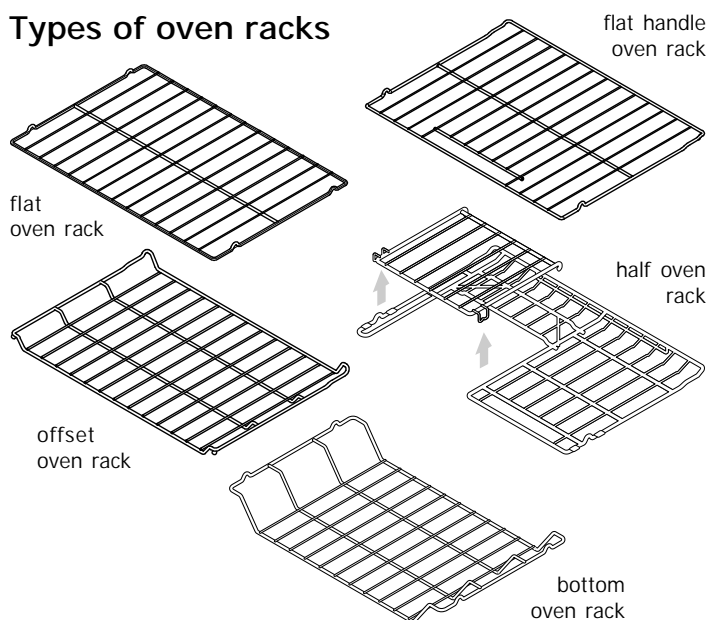

The **flat oven rack** or **flat handle oven rack** (some models) may be used for most cooking needs.

The **half rack** (some models) design comes with a removable section that allows for taller cooking utensils.

The **offset oven rack** (some models) is designed to place the base of the rack about 1/2 of a rack position lower than normal. This rack design provides several additional possible positions between the standard positions.

To maximize oven cooking space place the **bottom oven rack** (some models) in the lowest rack position for baking or roasting large cuts of meat.

The **Effortless™ Oven Rack** (some models) is described in the "Effortless™ Oven Rack system" section.

Removing, replacing & arranging racks

To remove - pull the rack forward until it stops. Lift up front of rack and slide out.

To replace - fit the rack onto the guides on the oven walls. Tilt the front of the rack upward and slide the rack back into place.

Arranging - always arrange the oven racks when the oven is cool (prior to operating the oven).

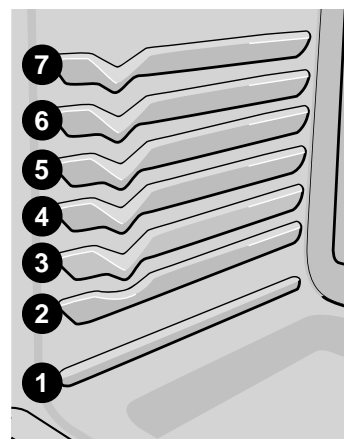

Air circulation in the oven

For best baking results allow at least 2 inches (5 cm) around the cookware for proper air circulation and be sure pans and cookware do not touch each other, the oven door, sides or back of the oven cavity. Hot air must be able to circulate around the pans and cookware in the oven for even heat to reach around the food.

CAUTION

Always use oven mitts when using the oven. When using the appliance, oven racks and cooktop will become very hot which can cause burns.

IMPORTANT

Only the Effortless™ Oven Rack should be used in oven rack position 2. Placing any other rack in rack position 2 will prevent the oven door from fully closing.

BEFORE SETTING OVEN CONTROLS

Effortless™ Oven Rack system

Some models are equipped with a special oven rack system that automatically extends the oven rack to assist in access to your food items. This rack extends when the oven door is opened or closed.

To assemble the Effortless™ Oven Rack system:

1. Locate all required parts. You will need the supplied oven rack (Effortless™ Oven Rack is a flat rack with a special **dark coating** on the **left and right rack sides**) and the 2 supplied chrome connector arms.
2. Open the oven door. Be sure the oven is completely cool before proceeding.
3. Place the oven rack in positions **2, 3 or 4 only** (see previous page to verify positions). Be sure the rack connector brackets are at the rear of the range and pointing towards oven bottom (See Fig. 2).
4. Assemble one connector arm at a time. With the oven door open and the oven rack in place, install one end of the connector arm to the hole in the **door connector bracket** (Fig. 1) and the other end in the hole in the **rack connector bracket** (Fig. 2 and as in Fig. 3). The oven rack may need to be adjusted in or out in the rack position to match the length of the connector arm.
5. While holding the connector arm in place, twist the connector arm so the ends of the connector arm point **upwards** (See Figs. 4 & 5). The connector arm should now be locked into position.
6. Repeat steps 4 and 5 for the other connector arm.
7. Once both connector arms are properly in place, be sure to test the oven rack operation by gently closing the oven door. The oven rack should move in and out of the oven freely when the door is opened or closed.

CAUTION

- **REMOVE ALL OVEN RACKS and accessories before starting a self-clean cycle.** If the oven racks are left in the oven during the self-clean cycle, the gliding ability of the Effortless™ Oven Rack system will be damaged and oven racks will lose their shiny finish and may turn blue. Remove **ALL** oven racks and clean according to instructions provided in the Care & Cleaning section of this manual.
- Make sure the oven and oven racks are **COMPLETELY** cool before attempting to assemble or disassemble the Effortless™ Oven Rack system. **Never pick up hot oven racks or parts.**

IMPORTANT

- **Only the Effortless™ Oven Rack system should be used in oven rack position 2.** Placing ANY other rack in oven rack position 2 will prevent the oven door from fully closing and may damage the oven door, oven cavity or the door connector brackets.
- If the rack system is not assembled with the connector arms the Effortless™ Oven rack may be used in oven rack positions 2 thru 6. Do not attempt to use the Effortless™ Oven rack in rack position 1.

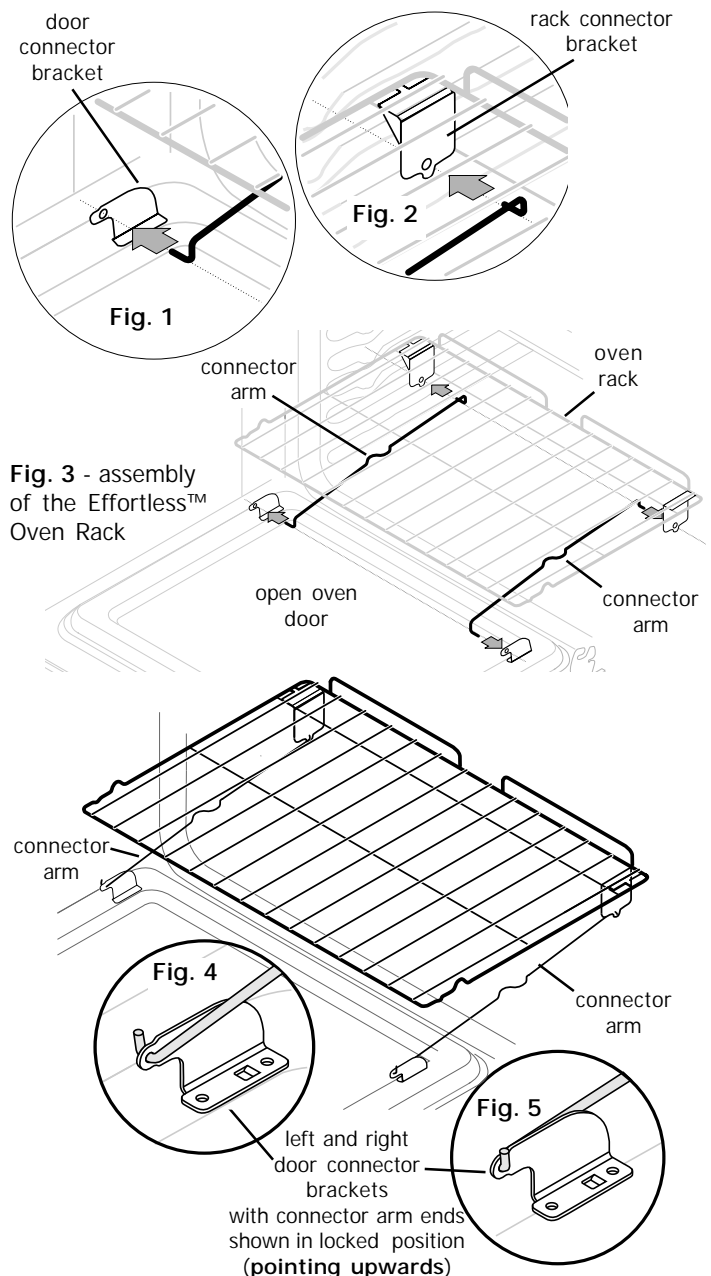
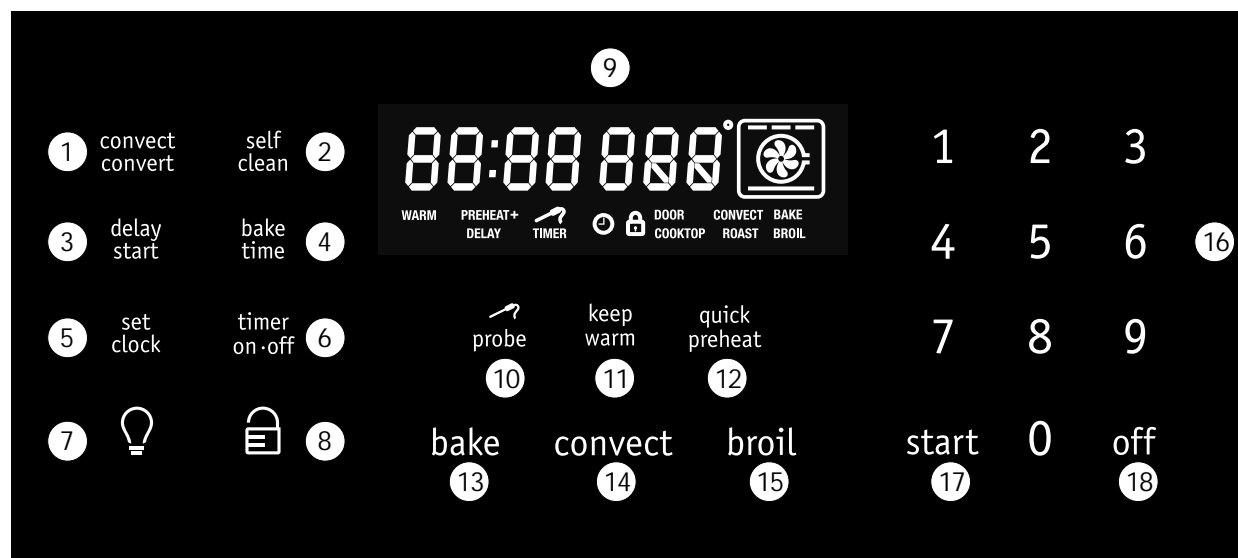

Fig. 6 - Effortless™ Oven Rack after assembly

OVEN CONTROL FUNCTIONS

READ THE INSTRUCTIONS CAREFULLY BEFORE USING THE OVEN.



- convect convert** — Use to convert a standard bake recipe to a convection bake recipe.
- self-clean** — Use to set a 2, 3 or 4 hour self-clean cycle.
- delay start** — Use with **bake**, **convect**, **convect convert** and **self-clean** features to program a delayed time bake or delayed self-cleaning cycle.
- bake time** — Use to enter the length of baking time needed.
- set clock**— Use to set the time of day.
- timer on/off** — Use to set or cancel the minute timer.
- oven light** —Use to turn the oven light ON and OFF.
- oven lockout** — Use to activate oven lockout setting.
- oven control display** — Use to view active features, temperatures, and cooking times.
- probe** — Use to set and monitor the meat probe.
- keep warm** — Use to set the keep warm features.
- quick preheat** — Use to quickly preheat the oven.
- bake** —Use to set the normal Bake feature.
- convect** — Use to set and toggle between the convection bake, roast, and broil features.
- broil** — Use to set broil feature.
- numeric keypad** — Use to enter temperature and times.
- start** — Use to start all oven features (not used with oven light).
- off** — Use to cancel any oven mode previously entered except the oven lockout, time of day & minute timer. Press **off** to stop cooking.

Minimum & maximum control settings

All of the features listed have minimum and maximum time or temperature settings that may be entered into the control. An acceptance beep will sound each time a control pad is touched (the Oven Lockout pad is delayed by 3 seconds).

An ERROR tone (3 short beeps) will sound if the temperature or time entered is below the minimum or above the maximum settings for the feature.

Feature	Min. temp. /time	Max. temp. /time
quick preheat temperature	170°F / 77°C	500°F / 260°C
bake temperature	170°F / 77°C	500°F / 260°C
broil temperature	400°F / 205°C	550°F / 288°C
timer	1 Min.	11 Hrs. 59 Mins.
self-clean time	2 hours	4 hours
convect bake	170°F / 77°C	500°F / 260°C
convect roast	170°F / 77°C	500°F / 260°C
convect broil (some models)	400°F / 205°C	550°F / 288°C

SETTING OVEN CONTROLS

Setting the clock

When the range is first powered up, "12:00" will flash in the display (See Fig. 1).

To set the clock to 1:30:

Step	Press
1. Press set clock .	set clock
2. Enter 1:30 .	1 3 0
3. Press start .	start

NOTE

It is recommended to always set the clock for the correct time of day before using the appliance. The clock cannot be changed if any timed or delayed time feature is active.



Fig. 1

Changing between continuous bake setting or 6-Hour Energy Saving feature

The oven control has a factory preset built-in 6 Hour Energy Saving feature that will turn off the oven if it is left on for more than 6 hours. The control can be programmed to override this feature to continuously bake.

To turn off 6-Hour Energy saving mode:

Step	Press
1. Press and hold timer on•off for 6 seconds.	timer on•off
2. Press self-clean to toggle between "6 Hr OFF" (Fig. 2) or "StAY On" (Fig. 3). Select "StAY On" to turn off 6-Hour Energy Saving mode.	self clean
3. Press start to accept.	start



Fig. 2

Fig. 3

Setting 12 or 24 hour display mode

The clock display mode allows you to choose between 12 or 24 hr mode. The factory pre-set clock display mode is 12 hr. See the example below to change the default mode to 24 hr display.

To set 12 or 24 hour mode:

Step	Press
1. Press and hold set clock for 6 seconds.	set clock
2. Press self-clean to toggle between "12 Hr dAY" or "24 Hr dAY" display modes (See Figs. 4 & 5).	self clean
3. Press start to accept.	start



Fig. 4

Fig. 5

Changing oven temperature display

The oven control is preset to display °F (Fahrenheit) when shipped from the factory.

To change the temperature to display °C (Celsius) (oven should not have bake or self-clean active when setting this feature):

Step	Press
1. Press and hold broil for 6 seconds.	broil
2. Press self-clean to toggle between "FAhrn ht" or "CELSIUS" temperature display modes (Figs. 6 & 7). If Celsius display is needed, select "CELSIUS".	self clean
3. Press start to accept.	start



Fig. 6

Fig. 7

SETTING OVEN CONTROLS

Setting a silent control panel

Silent mode allows the oven control to operate without sounds. The control may be programmed for silent operation and later returned to operating with all the normal sounds.

To set silent mode:

- | Step | Press |
|------------------------------------------------------------------------------------------------------------------------|--------------------|
| 1. Press and hold delay start for 6 seconds. | delay start |
| 2. Press self-clean to toggle between "bEEP On" or "bEEP OFF". Select "bEEP OFF" for silent mode. (Figs. 1 & 2) | self clean |
| 3. Press start to accept | start |

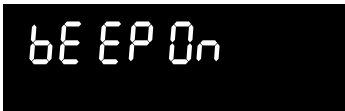

Fig. 1

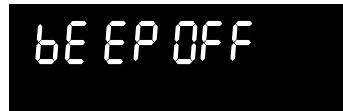



Fig. 2

Setting lockout

The control may be programmed to lock the oven door, lock the cooktop and lock the oven control keypad.

To set the lockout feature:

- | Step | Press |
|-------------------------------------------------------------------------------------------------------------------------------|-------------------------------------------------------------------------------------|
| Press and hold lock pad for 3 seconds. "door Loc" will appear in the display until the oven door is completely locked. |  |

To unlock the lockout feature:

- | Step | Press |
|-------------------------------------------------------------------------------------------------------------------------------------------|-------------------------------------------------------------------------------------|
| Press and hold lock pad for 3 seconds. Once the oven door has unlocked the "door Loc" message will no longer display (See Fig. 3). |  |



Fig. 3

NOTES

DO NOT attempt to open the oven door while the "door Loc" (door lock) message is visible. Allow 15 seconds for the oven door to completely lock. Once the oven door has locked, the current time of day will reappear in the display. If a control pad is pressed when the oven lockout feature is active, the error tone indicates the control pad is not available when the oven lockout is active.

Setting the minute timer

The timer allows you to track your cooking times without interfering with the cooking process. The timer may be set from 1 minute up to 11 hours and 59 minutes.

To set the timer for 5 minutes:

- | Step | Press |
|--------------------------------|---------------------|
| 1. Press timer on•off . | timer on•off |
| 2. Enter 5 minutes. | 5 |
| 3. Press start . | start |
- Press **timer on•off** to turn the minute timer off.

NOTES

The minute timer will display hours and minutes until 1 hour remains on the timer. Once less than 1 hour remains, the display will count down in minutes and seconds. Once the timer has less than 1 minute remaining only seconds will display.

The minute timer does not start or stop the cooking process. It serves as an extra timer in the kitchen that will beep when the set time has run out. The minute timer can be used alone or while using other oven features. The minute timer cannot be used with self-clean feature or when the oven door is locked.

When the minute timer is in use during a cooking process, the minute timer will be shown in the display. To view the status of other features, press the pad once for the other feature to view the status of that feature.

SETTING OVEN CONTROLS

Setting bake

Use the bake feature to cook most food items that require normal cooking temperatures. A reminder tone will sound once the oven reaches the set temperature. Bake can be set at any temperature from 170°F to 500°F.

To set bake using a default temperature of 350°F:

Step	Press
1. Press bake .	bake
2. Press start	start

To set bake for oven temperature of 425°F:

Step	Press
1. Press bake .	bake
2. Enter 425 .	4 2 5
3. Press start	start

Baking layer cakes with 1 or 2 oven racks

When using a single oven rack, position rack so cookware is in the middle of the oven. For best results when baking cakes and cookies, use convection bake. When using radiant bake using two flat oven racks, place cookware on rack positions 2 and 5 (see Figure 1). Place pans as shown in Figure 2.

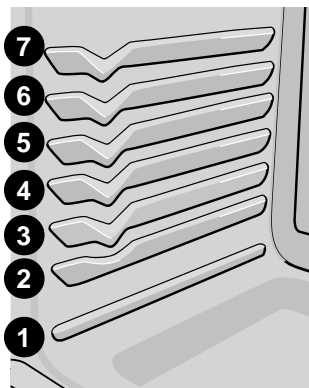

Fig. 1

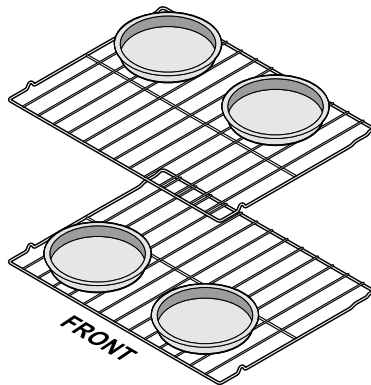

Fig. 2

NOTES

The oven will bake no longer than 6 hours from the last time the oven door was opened.

If you wish to bake longer than 6 hours, see "Changing between continuous bake setting or 6-Hour Energy Saving feature" for further instructions.

Setting bake time

Use the timed bake feature to automatically turn the oven off after a desired length of time.

! WARNING

FOOD POISONING HAZARD. Do not let food sit for more than one hour before or after cooking. Doing so can result in food poisoning or sickness.

To set bake with the default temperature (350°F) and end after 30 minutes:

Step	Press
1. Press bake time .	bake time
2. Enter 30 minutes.	3 0
3. Press start .	start
4. Press bake .	bake
5. Press start .	start

When the set bake time runs out:

- "END" will appear in the display window and the oven will shut-off automatically.
- The control will beep 3 times every 30 seconds as a reminder until the **cancel** key pad is pressed.

! NOTES

The default maximum **bake time** setting is 6 hours.

After the **bake time** feature has been activated, press the **bake time** pad to display the bake time remaining.

The **bake time** feature may be set with the **convect bake** and **convect roast** features. Bake time will not operate with the broil feature.

The convection fan will begin rotating once the bake or bake time features are started. The convection fan will turn off once the set oven temperature is reached.

SETTING OVEN CONTROLS

Setting delayed bake time and timed bake

The delay start feature allows you to set a starting and ending time to the baking process. Prior to setting a delay start, be sure the time of day is set correctly. If the delay start needs to be set more than 12 hours in advance (12-24 hours), the control must first be programmed for 24 hour display mode. See "Setting 12 or 24 hour display modes" section.

WARNING

FOODPOISONING HAZARD. Do not let food sit for more than one hour before or after cooking. Doing so can result in food poisoning or sickness.

To program the oven for a delay start and to shut-off automatically (example for baking at 375°F for 50 minutes and starting at 5:30):

Step	Press
1. Press bake time .	bake time
2. Enter 50 minutes.	5 0
3. Press start .	start
4. Press delay start (See Fig. 1).	delay start
5. Enter 530.	5 3 0
6. Press start .	start
7. Press bake .	bake
8. Enter 375.	3 7 5
9. Press start .	start

When the set bake time runs out:

1. "**END**" will appear in the display window and the oven will shut-off automatically (See Fig. 2).
2. The control will beep 3 times every 30 seconds as a reminder until the **cancel** key pad is pressed.



Fig. 1



Fig. 2

NOTES

After the **delay start** feature has activated and started the cooking process, press the **bake time** pad to display the bake time remaining.

The **delay start** feature may be used with the **convect** or **convect convert** cooking features. Bake time will not operate when using the **broil** or **convect broil** features.

Setting quick preheat

Use the quick preheat feature for single rack baking to quickly heat the oven. Use this feature only for standard baking. A reminder tone will sound indicating when to place the food in the oven.

When the oven is finished preheating, quick preheat will change to the bake feature and continue to bake until cancelled.

To set quick preheat with a default set temperature of 350°F:

Step	Press
1. Press quick preheat .	quick preheat
2. Press start (See Fig. 3).	start



Fig. 3

IMPORTANT

For batter and dough-based baked good such as cakes, pastries and breads, use the standard bake function for best results

SETTING OVEN CONTROLS

Convection Cooking

Convect uses a fan to circulate heat inside the oven. Improved heat distribution allows for fast, even cooking and browning. It gives better baking results when using two racks at the same time.

Benefits of the convect feature

- Foods may cook up to 25 to 30% faster, saving time and energy.
- No special pans or bakeware needed.
- Recommended cooking method for baked goods such as cakes, biscuits, pastries, and bread.

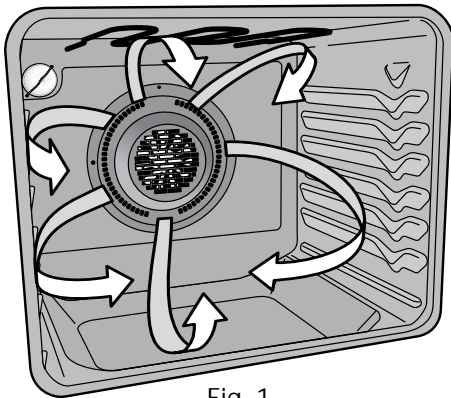

Fig. 1

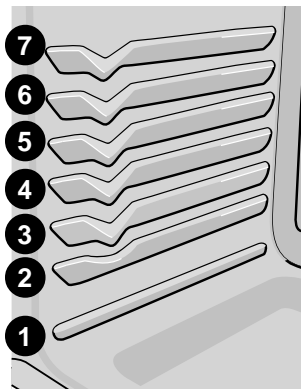

Fig. 2

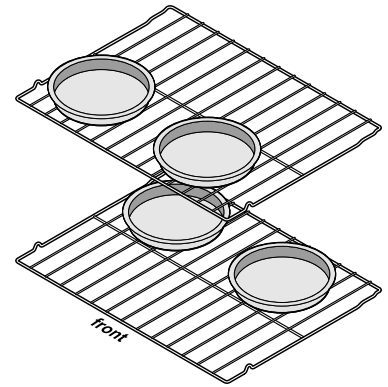

Fig. 3

To set convect (convection bake) with a default oven set temperature of 350°F:

- | Step | Press |
|-------------------------------------|----------------|
| 1. Press convect . | convect |
| 2. Press start (See Fig. 4). | start |

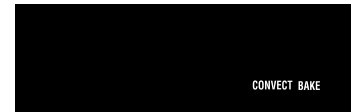

Fig. 4

NOTES

- When choosing between the **convect** features, use the convect key to **choose convect bake, convect roast or convect broil** functions.
- When using convection, cook time reductions may vary depending on the amount and type of food being cooked.
- **The convection fan will begin rotating** once convection bake or convection roast has been activated.

Convect bake

Suggestions for convect baking

1. Preheat the oven when baking foods such as cookies, biscuits and breads.
2. Reduce oven temperature 25°F/14°C from recipe's listed oven temperature. Follow the minimum recommended cook time.
3. When using a single oven rack, position rack so cookware is in the middle of the oven.
4. When using two oven racks at the same time, place in positions 2 and 5 for best results (see Fig. 2). Place pans as shown in Figure 3.

Convect roast

Suggestion for convect roast

1. Preheating is not necessary when roasting foods using **convect roast**.
2. Since **convect roast** cooks food faster, reduce the cook time by 25% from the recommended cook time of your recipe (check the food at this time). If necessary, increase cook time until the desired doneness is obtained.
3. Do not cover foods when dry roasting - this will prevent the meat from browning properly.

To set convect roast (convection roast) with a default oven set temperature of 350°F:

- | Step | Press |
|-------------------------------------|----------------|
| 1. Press convect . | convect |
| 2. Press convect again. | convect |
| 3. Press start (See Fig. 5). | start |



Fig. 5

SETTING OVEN CONTROLS

Convect broil

Use the convect broil feature to cook thicker cuts of meats that require direct exposure to radiant heat and the convection fan for optimum broiling results.

Suggestions for convect broil:

1. When using a broil pan, carefully follow all recommended instructions for placing the oven racks as provided in the "Broil" section in this Use & Care Guide.
2. Since **convect broil** cooks food faster, reduce the cook time by 25% from the recommended cook time of your recipe (check the food at this time). If necessary, increase cook time until the desired doneness is obtained.
3. **Close the oven door** when using convect broil.

To set convect broil with a default oven set temperature of 550°F:

- | Step | Press |
|--------------------------------------|----------------|
| 1. Press convect key 3 times. | convect |
| 2. Press start (See Fig. 1). | start |

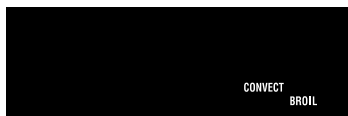

Fig. 1

NOTE

The convection fan will begin rotating once convection broil has been activated.

Setting convect convert

The convect convert feature allows you to convert any baking recipe using the convect (convection) feature. The control uses the normal recipe settings and adjusts to a lower temperature for convection baking. Convect convert can only be set with the **convect bake** feature.

To set convect using default oven set temperature of 350°F and adding the convect convert:

- | Step | Press |
|-----------------------------------|------------------------|
| 1. Press convect . | convect |
| 2. Press convect convert . | convect convert |

NOTES

- When convect convert is used with bake time, the convect convert feature will display a "CF" for **check food** when the bake time is 75% complete (See Fig. 2). At this time the oven control will sound one long beep at regular intervals until the set cook time has finished.

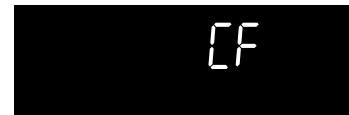

Fig. 2

- **The convection fan will begin rotating** once convection bake or convection roast has been activated.
- When using convect convert, cook time reductions may vary depending on the oven set temperature.
- The minimum amount of cook time allowed using the convect convert feature with a **bake time** or a **delay time bake** setting is 20 minutes.
- Layer cakes will have better results using the normal **bake** feature.

SETTING OVEN CONTROLS

Probe

Use the **probe** for best results when cooking foods such as roasts, hams or poultry. The probe also works well with foods such as meat loaf and casseroles.

For some food types, especially poultry and roasts, using a probe to check the internal temperature is the safest possible method to ensure properly cooked food.

The **probe** feature, when set correctly, will alert when the internal food temperature reaches the desired "target" temperature.

When active, the probe will display the internal food temperature, eliminating the need for any guesswork.

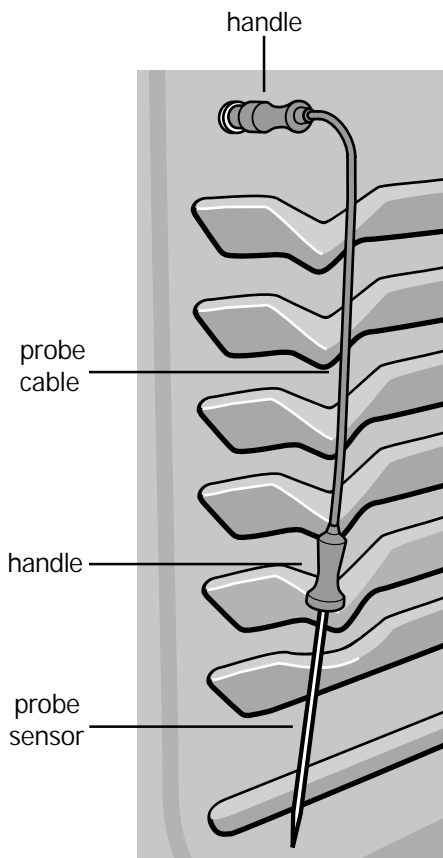

Fig. 1

CAUTION

To avoid the possibility of burns after cooking with the probe, use care when disconnecting the probe from the receptacle or food. **The probe may be hot.** Be sure to always use a pot holder to protect your hands.

Proper probe placement in food:

- Insert the probe so that the tip is centered in the thickest part of the food (see Fig. 2). For best results, do not allow the probe temperature sensor to contact bone, fat, gristle, or cookware.
- For bone-in ham or lamb, insert the probe into the center of lowest large muscle or joint. For dishes such as meat loaf or casseroles, insert the probe into center of food. When cooking fish, insert meat probe just above the gill.
- For whole poultry or turkey, insert the probe sensor into the thickest part of inner thigh, just below the leg (See Fig. 3).

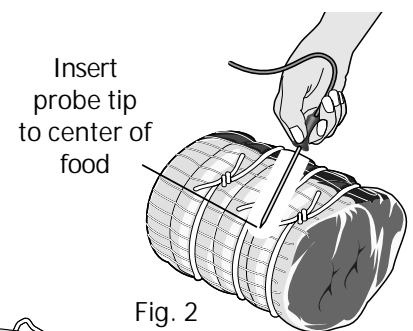

Fig. 2

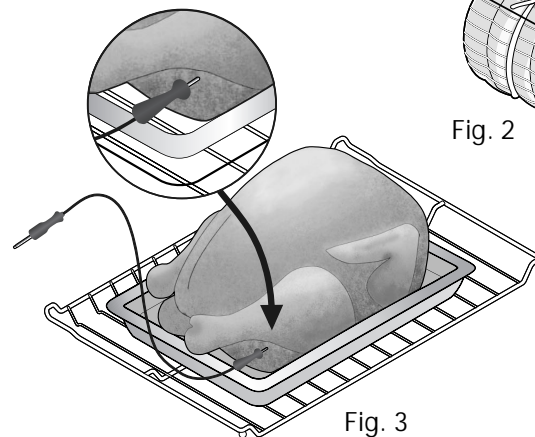

Fig. 3

IMPORTANT

- To avoid damaging the probe, **do not** use kitchen utensils such as tongs to pull on the probe cable or handles. Always insert and remove the probe using the provided handles (See Fig. 1) and always use a pot holder to protect hands from possible burns.
- **Do not** store the probe inside the oven. Always remove the probe from the oven when finished.
- **Use only the original probe** provided with this appliance. Connecting any other probe or device into the probe receptacle could result in damage to the oven control, electronics and the receptacle.
- Before starting **self-clean**, check that the probe is removed from the oven interior. The high temperatures during self-clean may damage or destroy the probe.
- To avoid damaging the probe, defrost frozen foods completely before inserting.

SETTING OVEN CONTROLS

Probe (cont'd)

To set probe:

1. Insert the probe into the food.
2. Place prepared food on the desired oven rack position and slide into the oven.
3. Plug the connector end of the probe all the way into the receptacle while the oven is still cool. The **receptacle** is located on the upper left front oven cavity wall (Fig. 1).

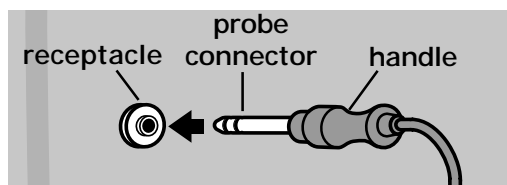

Fig. 1

4. When the probe is detected, a tone will sound, the icon will illuminate and the current probe temperature will appear in the display (Fig. 2). Close the oven door.

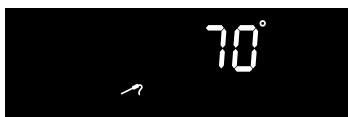

Fig. 2

5. Press **probe** keypad once.
6. Enter the desired temperature for food type (Refer to USDA Chart) using the numeric keypad. The minimum target setting is 140°F/60°C; the maximum target setting is 210°F/99°C. The default target is 170°F/77°C.
7. Press **start** to accept the target temperature.
8. Set for **quick preheat, bake, convection bake, convection roast** or **convection convert** and if necessary adjust the oven temperature accordingly.
9. The control will sound 3 beeps when the internal target temperature is reached. By default the oven will change to **keep warm** ("HLd" and the actual probe temperature will alternate in the display). **keep warm** will maintain the oven temperature at 170° F (77°C) for 3 hours unless otherwise cancelled.

To stop cooking at any time press **cancel**.

USDA recommended minimum internal cooking temperatures:

Food type	Internal temp.
Ground meat & meat mixtures	
Beef, Pork, Veal, Lamb	160°F (71°C)
Turkey, Chicken	165°F (74°C)
Fresh beef, veal, lamb	
Medium rare†	145°F (63°C)
Medium	160°F (71°C)
Well done	170°F (77°C)
Poultry	
Chicken & Turkey, whole	165°F (74°C)
Poultry Breasts, Roasts	165°F (74°C)
Poultry Thighs, Wings	165°F (74°C)
Duck & Goose	165°F (74°C)
Stuffing (cooked alone or in bird)	165°F (74°C)
Fresh pork	160°F (71°C)
Ham	
Fresh (raw)	160°F (71°C)
Pre-cooked (to reheat)	140°F (60°C)
Eggs & egg dishes	
Eggs	Cook until yolk & white are firm.
Egg dishes	160°F (71°C)
Leftovers & Casseroles	165°F (74°C)

Information courtesy the U.S. Department of Agriculture Food Safety and Inspection Service.

† The U.S. Department of Agriculture states, "**Rare fresh beef is popular, but you should know that cooking it to only 140°F/60°C means some food poisoning organisms may survive.**" (Source: Safe Food Book, Your Kitchen Guide, USDA Rev. June 1985.)

Visit the U.S. Department of Agriculture Food Safety and Inspection Service website at www.fsis.usda.gov

Probe (cont'd)

Choosing a setting for how the oven will operate once the probe reaches the target temperature

Your oven is factory preset to automatically stop cooking and start the keep warm feature once the probe sensor reaches the set target temperature. This setting may be changed to **continue cooking** if desired.

IMPORTANT

Setting the option for how the oven will heat once the probe reaches the target temperature must be done when the oven is **inactive**. The probe is not required to be connected to the probe receptacle when setting this option.

To set the oven to continue cooking after reaching the target temperature:



1. Press  keypad and hold for 6 seconds.
2. Press  keypad and toggle until the "Continu" message appears (Fig. 1) then press **start** to accept.



Fig. 1

To set the oven to automatically stop cooking and start keep warm once reaching target temperature:





1. Press  keypad and hold for 6 seconds.
2. Press  keypad and toggle until "CAnCEL" message appears (Fig. 2) then press **start** to accept.



Fig. 2

NOTES

- During the cooking process, the internal food temperature will display by default. To review the target temperature, press the  key once. After 6 seconds the display will return to the internal food temperature.
- To assure temperature accuracy, do not remove the probe from the food or receptacle until the desired internal temperature is met.
- If the probe feature is active but the probe is removed from the receptacle, the probe feature will cancel but the oven will continue to cook.
- If the probe is active and the probe is removed from the food, the probe feature will remain active. The displayed internal food temperature may no longer be reliable. This may eventually cause a "**Probe Too Hot**" message.
- The oven will automatically turn OFF if the probe sensor reaches 300°F (149°C) or more.
- The probe feature cannot be set with **broil**, **convection broil**, or **self-clean**.
- To change the target temperature while cooking, press the  keypad once. Use the numeric keypad to change the target temperature. Press the **start** key to accept any change.

SETTING OVEN CONTROLS

Probe (cont'd)

Probe error message:

If the error message "**Prob ERR**" displays, check to be sure the probe connector is fully inserted into the receptacle. If the probe is fully inserted in the receptacle and the error message continues, the probe may need to be replaced.

If "**Prob ERR**" displays, the oven control will deactivate all other features until corrected or the probe is removed. If the error message continues, remove the probe from the receptacle and oven.

"Probe Too Hot" message:

If the message "**Prob**" ... "**Too**"... "**Hot**" ... flashes in the display, the probe sensor temperature has exceeded 250°F (121°C). If the probe is not removed, this message may continue until the sensor reaches 300°F (149°C) or higher, at which time the oven will turn OFF and display "**Prob ERR**" message.

This message may occur if the probe sensor is exposed to direct oven heat or the food internal temperature is over 250°F (121°C). Be sure the probe sensor is fully inserted into food. If the food is done, press **cancel** and remove food and probe from the oven.

SETTING OVEN CONTROLS

Setting keep warm

The keep warm feature will keep foods warm for serving up to 3 hours. The keep warm feature may be used alone or after cooking has finished using **bake time** and or **delay start**.

To set the oven to **keep warm**:

- | Step | Press |
|-----------------------------|------------------|
| 1. Press keep warm . | keep warm |
| 2. Press start . | start |

The keep warm temperature and the warm icon will appear in the display (Fig. 1).



Fig. 1

To set the oven to **keep warm automatically** after bake time has ended:

- | Step | Press |
|--------------------------------------------------------------|------------------|
| 1. Program the desired cook time or delay start. | |
| 2. Program the desired baking function | |
| 3. When cooking program is started, press keep warm . | keep warm |
| 4. Press start . | start |

The **keep warm** feature will come on when the cooking is finished. The keep warm temperature and the warm icon will appear in the display (Fig. 1).

Operating the oven light

The interior oven light will automatically turn ON when the oven door is opened.

Press  to turn the interior oven light ON and OFF whenever the oven door is closed.

The interior oven light is located at the upper left rear wall of the oven interior and is covered with a glass shield. The glass shield must be in place whenever the oven is in use. The shield will protect the halogen bulb from food splatters.

To change the interior oven light, see "Changing the oven light" in the **Care & Cleaning** section.



WARNING

FOOD POISONING HAZARD. Do not let food sit for more than one hour before or after cooking. Doing so can result in food poisoning or sickness.



NOTE

The keep warm feature will automatically turn the oven off after 3 hours.

SETTING OVEN CONTROLS

Adjusting the oven temperature

Your appliance has been factory calibrated and tested to ensure an accurate baking temperature. For the first few uses, follow your recipe times and temperature recommendations carefully. If you think the oven is cooking too hot or too cool for your recipe times, you can adjust the control so the oven cooks hotter or cooler than the temperature displayed.

The oven temperature may be increased +35°F (+19°C) or decreased -35°F (-19°C) from the factory settings.

Example: increase the oven temperature by 30°F:

Step	Press
1. Press and hold bake for 6 seconds.	bake
2. Enter 30.	3 0
3. Press start .	start

Example: decrease the oven temperature by 30°F:

Step	Press
1. Press and hold bake for 6 seconds.	bake
2. Enter 30.	3 0
3. Press self-clean .	self clean
4. Press start .	start

Restoring factory default settings

When new, your appliance left the factory with predetermined oven control default settings. Over time, the user may make changes to these settings. The following options have user preferences that could be modified and may have been changed since the appliance was new:

- **12 or 24 hour display mode**
- **Continuous bake or 6-Hour Energy Savings mode**
- **Silent control panel**
- **Oven temperature display (Fahrenheit or Celsius)**
- **Adjusting the oven temperature**

Please remember that if you choose to restore, **ALL** of the above preferences will be restored to factory default settings, the oven temperature offset will reset and any stored information will be cleared.

To restore all user settings to factory default:

Step	Press
1. Press and hold 7 key pad until first beep sounds (about 6 seconds).	7
2. Press start .	start

NOTES

Oven temperature adjustments made will not affect the broil or self-cleaning feature temperatures.

If the temperature shows an adjustment of -30°F, and a +30°F adjustment is needed, you can toggle between the (-) or (+) in the display by pressing **self clean**.

DO NOT USE oven thermometers such as those found in grocery stores to check the temperature settings inside your oven. These oven thermometers may vary as much as 20 to 40 degrees from actual temperatures.

SETTING OVEN CONTROLS

Setting the Sabbath Mode Feature (for use on the Jewish Sabbath & Holidays)



For further assistance, guidelines for proper usage and a complete list of models with the Sabbath feature, please visit the web at <http://www.star-k.org>.

WARNING

FOOD POISONING HAZARD. Do not let food sit for more than one hour before or after cooking. Doing so can result in food poisoning or sickness.

The **bake time** and **delay start** pads are used to set the Sabbath feature. The Sabbath feature may only be used with the **bake** feature. The oven temperature may be set higher or lower after setting the Sabbath feature (the oven temperature adjustment feature should be used only during Jewish Holidays), however the display will not be visible and no audible tones will be provided when a change occurs.

Once Sabbath mode is active, the oven will remain ON until cancelled. The Sabbath mode will override the factory preset 6-Hour Energy Saving feature.

If the oven light(s) are needed during the Sabbath, press the **oven light** key **before** activating the Sabbath feature. Once the oven light is turned on and the Sabbath feature is active, the oven light will remain on until the Sabbath feature is turned OFF. If the oven light needs to be off, be sure to turn the oven light off before activating the Sabbath feature.

It is recommended that any oven temperature change made during active Sabbath feature active be followed with 2 presses of the **start** pad. This will insure the oven remains ON even if the attempt to set the oven temperature was lower or higher than the oven control can accept. If the oven temperature is set incorrectly, the oven temperature will default to 170°F or 500°F. Try to set the desired oven temperature again.

To program the oven to bake at 350°F and then activate the Sabbath Day feature:

- | Step | Press |
|------------------------------------------------------------------------------------------------------------------------------------------------------------------------------------------------------------------------------------------------------------------------------------------------------------------------------------------------------------------------------------------------------------------------------------------------------|---------------------------------------|
| 1. Be sure that the clock is set with the correct time of day. | |
| 2. Arrange the oven racks and place the food in the oven and close door. | |
| 3. Press bake . | bake |
| 4. Press start . | start |
| 5. If a timed bake or delayed timed bake is needed then enter the time in this step. If not, skip this step and continue to step 6. Refer to the bake time or delay start instructions. Remember the oven will shut-off after completing a timed bake or delay start and therefore may only be used once during the Sabbath/Jewish Holidays. The maximum delay start time is 11 hours & 59 minutes. | |
| 6. Press and hold both the | bake time + delay start |
| bake time and delay start pads for at least 3 seconds simultaneously. | |

The control will beep and **SAb** will appear in the display (See Fig. 1). The oven is properly set for the Sabbath once **SAb** appears in the display.

The induction cooktop will not operate when the oven is set for Sabbath Day feature. The cooktop displays will show the cooktop lockout " - - " messages whenever the Sabbath Day feature is active (Fig. 2).

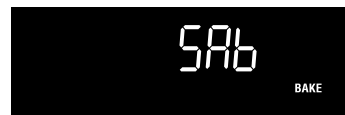

Fig. 1

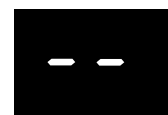

Fig. 2

To Set the Sabbath Feature (cont'd)

To turn off the oven but keep the Sabbath feature active:

Press **cancel**.

cancel

To turn off the Sabbath feature:

Press and hold both the **bake time** + **delay start** pads for at least 3 seconds. The control will beep and **SAb** will disappear from the display. The oven is no longer programmed for the Sabbath feature.

What to do during a power failure or power interruption after the Sabbath feature was activated:

Should you experience a power failure or interruption, the oven will shut off. When power is restored the oven will not turn back on automatically. The control will remember that it is set for the Sabbath and the oven display will show the message "SF" for Sabbath failure (Fig. 1).

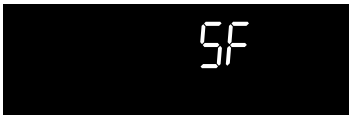

Fig. 1

After the Sabbath observance, turn OFF the Sabbath feature. At the same time **press and hold both the**

bake time + **delay start** pads for at least 3 seconds.

SF will disappear from the display and the oven may be used with all normal functions.

NOTES

- If a delay start time longer than 12 hours (maximum of 24 hours) in advance is desired, set the display mode for the 24 hour setting. For detailed instructions see the section "Setting 12 or 24 hour display modes".
- It is not advised to attempt to activate any other program feature except **BAKE** while the Sabbath feature is active. **ONLY** the following key pads will function correctly with the Sabbath feature: **0-9 number pads**, **bake**, **start** & **cancel**. **NO OTHER KEYS** can be used once the Sabbath feature is activated. The cooktop will also be inactive.
- You may change the oven temperature once baking has started. Press **bake**, enter the oven temperature change (170 to 500F°) and press **start**. Remember that **the oven control will no longer beep or display any changes** once the oven is set for the Sabbath feature.
- If the **keep warm** feature was activated and the Sabbath feature was set, the keep warm feature will automatically shut-off the oven after 3 hours.

SELF-CLEANING

Self-cleaning

A self-cleaning oven cleans itself with high temperatures (well above normal cooking temperatures) which eliminate soils completely or reduces them to a fine powdered ash you can wipe away with a damp cloth.

Your oven allows you to set 3 different self-cleaning cycle durations. A 3-hour cleaning time is best used for normal cleaning; 2-hour time for light soils and a 4-hour time option for heavier burnt-on soils.

➔ IMPORTANT

Adhere to the following self-clean precautions:

- **DO NOT** use oven cleaners or oven protective coatings in or around any part of the oven interior.
- **DO NOT** clean the oven door gasket. The woven material of the oven door gasket is essential for a good seal. Care should be taken not to rub, damage or remove the gasket.
- **DO NOT** use any cleaning materials on the oven door gasket. Doing so could cause damage (See Fig. 1).
- **Remove the broiler pan and insert, all utensils and ANY ALUMINUM FOIL.** These items cannot withstand high cleaning temperatures and will melt.
- **Completely remove ALL OVEN RACKS and ANY ACCESSORIES.** If the oven racks are not removed they will lose their special coating properties and no longer slide in and out of the oven cavity easily.
- **Remove any excessive spillovers.** Any spills on the oven bottom should be wiped-up and removed **before starting** the self-cleaning cycle. To clean, use hot, soapy water and a cloth. Large spillovers can cause heavy smoke or fire when subjected to high temperatures. **DO NOT** allow food spills with a high sugar or acid content (such as milk, tomatoes, sauerkraut, fruit juices or pie filling) to remain on the surface as they may leave a dull spot even after cleaning.
- Clean any soil from the oven frame, the door liner outside the oven door gasket and the small area at the front center of the oven bottom. These areas heat sufficiently to burn soil on. Clean with soap and water. These areas are shown in white (See Fig. 1).

⚠ CAUTION

During the self-cleaning cycle, the outside of the range can become very hot to the touch. **DO NOT** leave small children unattended near the appliance.

The health of some birds is extremely sensitive to the fumes given off during the self-cleaning cycle of any range. Move birds to another well-ventilated room.

DO NOT force the oven door open. This can damage the automatic door locking system. Use caution when opening the door after the self-cleaning cycle is completed. The oven may still be **VERY HOT**.

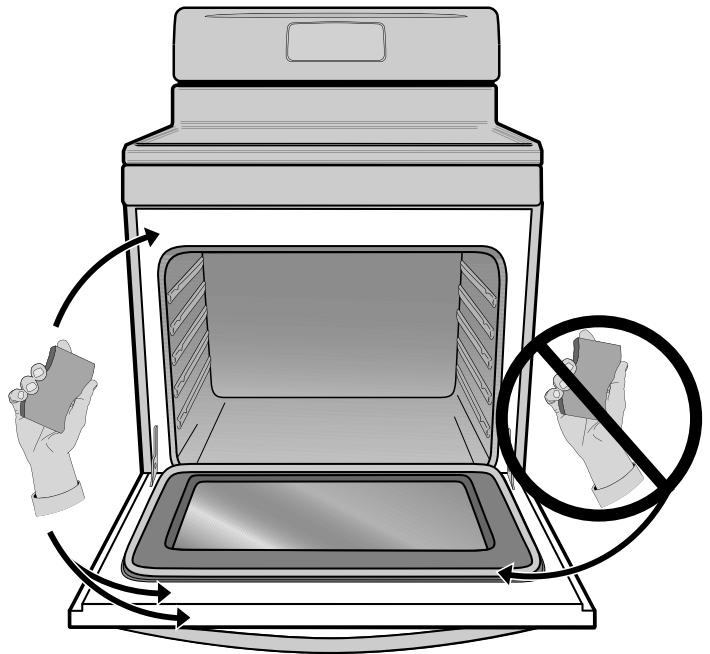

Fig. 1

⚠ CAUTION

Before manually cleaning any part of the range, be sure all controls are turned OFF and the range is COOL. The range may be hot and can cause burns.

Setting a self-clean cycle or a delayed start self-clean cycle

Examples: To start an immediate self-cleaning cycle and/or how to add a delay start time of 9:00 o'clock and shut-off self-clean automatically:

- | Step | Press |
|--------------------------------------------------------------------------------------------------------------------------------------------------------|--------------------|
| 1. Be sure the clock is set with the correct time of day, ALL the oven racks are removed and the oven door is closed. | |
| Go to step 5 if you wish to start self-clean immediately. | |
| Finish steps 2 thru 6 if setting a delayed start self-clean cycle. | |
| 2. Press delay start . | delay start |
| 3. Enter 9 0 0 . | 9 0 0 |
| 4. Press start . | start |
| 5. Press self clean once for a 3-hour clean time, press self clean twice for 4-hour clean and press 3 times for a 2-hour self-clean cycle time. | self clean |
| 6. Press start . | start |

IMPORTANT

As soon as the controls are set, the motor driven door lock will begin to close automatically. "door Loc" will appear in the display (See Fig. 1). **DO NOT** open the oven door while "door Loc" is on (allow 15 seconds for the oven door to completely lock).

Once the door has locked "CLn" will appear in the display indicating the oven will begin the self-clean process (Fig. 2).

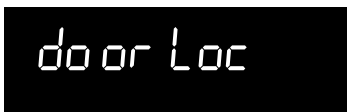

Fig. 1



Fig. 2

When the self-clean cycle has completed:

- The time of day and "Hot" will appear in the display window (See Fig.3).
- Once the oven has cooled down for about 1 hour and "Hot" is no longer displayed the "door OPn" message should appear (Fig. 4). When this message turns off the oven door may be opened. Use **caution** and avoid possible burns when opening the door after the self-cleaning cycle has completed. The oven may still be **VERY HOT**.

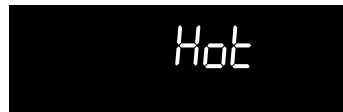

Fig. 3

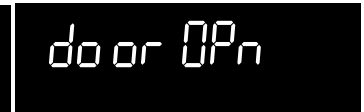

Fig. 4

If it becomes necessary to stop a self-clean cycle once it has been activated:

- Press **cancel**.
- Allow enough time for the oven to cool and for the "door OPn" message to appear (Fig. 4). When this message turns off the oven door may be opened. If a self-clean cycle was active, then stopped or interrupted by power failure, it may be necessary to run a self-clean cycle again to thoroughly clean the oven. Please be aware that you may need to allow up to four hours before self-clean can be started again.

CAUTION

To avoid possible burns use care when opening the oven door after the self-cleaning cycle. **Stand to the side of the oven** when opening the door to allow hot air or steam to escape.

DO NOT force the oven door open. This can damage the automatic door locking system. Use caution and avoid possible burns when opening the door after the self-cleaning cycle has completed. The oven may still be **VERY HOT**.

NOTES

When the self-clean feature is active you may check the amount of time remaining in the self-clean cycle by pressing the **self clean** pad once. The oven door will be locked until the range has cooled sufficiently. You will need to allow about **1 additional hour** to the time displayed before you can open the oven door. When the oven is cool, wipe away any residue or powdered ash with a damp cloth or paper towel.

CARE & CLEANING

Cleaning recommendation table

Surface type	Recommendation
<ul style="list-style-type: none">• Painted body parts• Painted decorative trim• Control knobs (some models)• Aluminum, plastic or vinyl trim pieces	<p><i>For general cleaning</i>, use hot, soapy water and a cloth. <i>For more difficult soils and built-up grease</i>, apply a liquid detergent directly onto the soil. Leave on soil for 30 to 60 minutes. Rinse with a damp cloth and dry. Do not use abrasive cleaners on any of these materials; they can scratch. To remove control knobs (some models), turn to the OFF position; grasp firmly and pull straight off the shaft. To replace knobs after cleaning, line up the flat sides of both the knob and the shaft; then push the knob into place.</p>
<ul style="list-style-type: none">• Control panel• Control keypad membrane• Decorative trim (some models)	<p><i>Before cleaning the control panel</i>, turn all controls OFF, activate Lockout (on some models) and remove control knobs (on some models). Do not use abrasive cleaners on any of these materials; they can scratch. Clean using hot, soapy water and a dishcloth. Be sure to squeeze excess water from dishcloth before wiping control panel, especially when wiping around the controls area. Excess water in or around the controls may cause damage to the appliance. When rinsing, use clean water and a dishcloth and be sure to squeeze excess water from dishcloth before wiping the control panel.</p>
<ul style="list-style-type: none">• Easy Care™ Stainless Steel (some models)	<p>If your range finish is Easy Care™ Stainless Steel (some models), clean the stainless with warm soapy water using a clean sponge or cloth. Rinse with clean water and dry with a soft clean cloth. DO NOT use ANY store bought cleaners like Stainless Steel cleaners or any other types of cleaners containing any abrasive, chlorides, chlorines or ammonia. It is recommended to use mild dish soap and water or a 50/50 solution of water and vinegar.</p>
<ul style="list-style-type: none">• Porcelain door liner & body parts• Storage drawer interior (some models)• Porcelain enamel broiler pan and broiler pan insert (some models)	<p>Gentle scouring with a soapy non-abrasive scouring pad will remove most spots. Rinse with a 1:1 solution of clear water and ammonia. <i>If necessary</i>, cover difficult spots with an ammonia-soaked paper towel for 30 to 40 minutes. Rinse with clean water and a damp cloth, and then scrub with a soap-filled non-abrasive scouring pad. Rinse and wipe dry with a clean cloth. Remove all cleaners or the porcelain may become damaged during future heating.</p>
<ul style="list-style-type: none">• Interior oven racks	<p>Oven racks must be removed from the oven before starting self-clean. Clean by using a mild, abrasive cleaner following manufacturer's instructions. Rinse with clean water and dry.</p>
<ul style="list-style-type: none">• Oven door	<p>Use soap & water to thoroughly clean the top, sides and front of the oven door. Rinse well. You may use a glass cleaner on the outside glass of the oven door. Do not immerse the door in water. Do not spray or allow water or the glass cleaner to enter the door vents. Do not use oven cleaners, cleaning powders or any harsh abrasive cleaning materials on the outside of the oven door. Do not clean the oven door gasket. On self-cleaning models the oven door gasket is made of a woven material which is essential for a good seal. Care should be taken not to rub, damage or remove this gasket.</p>
<ul style="list-style-type: none">• Ceramic cooktop	<p>See "Cooktop Cleaning and Maintenance" in the Care & Cleaning section.</p>

Cooktop maintenance

➔ IMPORTANT

Consistent and proper cleaning is essential to maintaining your ceramic glass cooktop.

Prior to using your cooktop for the first time, apply some of the glass-ceramic cooktop cleaner supplied with your new appliance. Buff with a **non-abrasive** cloth or no-scratch cleaning pad. This will make cleaning easier when soiled from cooking. The special cooktop cleaning cream leaves a protective finish on the glass to help prevent scratches and abrasions.

Sliding metal pans on the cooktop can cause metal markings on the cooktop surface. These marks should be removed **immediately** after the cooktop has cooled using the cooktop cleaning cream. Metal marks can become permanent if not removed prior to future use.

Cookware (cast iron, metal, ceramic or ceramic-coated) with rough or dirty bottoms can **mark or scratch** the cooktop surface.

Do not:

- Slide anything across the cooktop.
- Use cookware with dirt or dirt build-up on bottom; replace with clean cookware before using.
- Use your cooktop as a cutting board or work surface in the kitchen.
- Drop heavy or hard objects on the ceramic glass cooktop, they may cause it to crack.

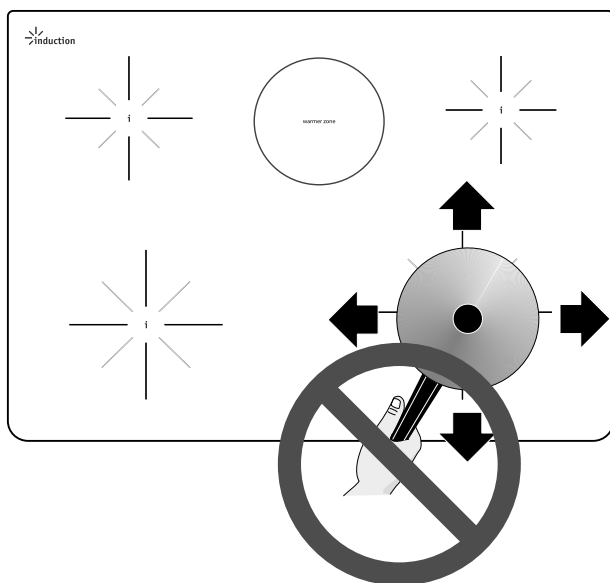

Cooktop cleaning

⚠ CAUTION

Before cleaning the cooktop, be sure the controls are turned to OFF and the cooktop is COOL.

For light to moderate soil:

Apply a few drops of glass-ceramic cooktop cleaner directly to the cooktop. Use a paper towel or use a non-abrasive plastic type no-scratch cleaning pad to clean the entire cooktop surface. Make sure the cooktop is cleaned thoroughly, leaving no residue.

For heavy, burned on soil:

Apply a few drops of glass-ceramic cooktop cleaner directly to the soiled area. Rub the soiled area using a non-abrasive plastic type no-scratch cleaning pad, applying pressure as needed. Do not use the pad you use to clean the cooktop for any other purpose.

If soils remain, carefully scrape soils with a metal razor blade scraper, holding scraper at a 30 degree angle to the surface. Remove loosened soils with cooktop cleaning cream and buff surface clean.

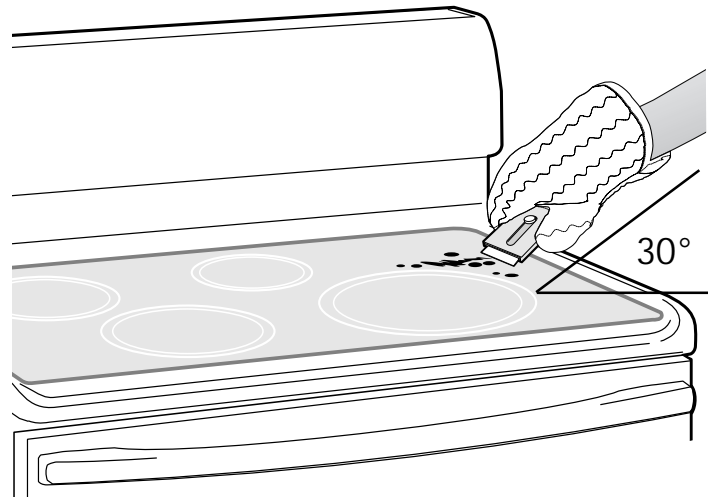

Plastic or foods with a high sugar content:

These types of soils need be removed immediately if spilled or melted onto the cooktop surface. Permanent damage (such as pitting of the cooktop surface) may occur if not removed **immediately**.

After turning the surface elements OFF, use a razor blade scraper or a metal spatula with a mitt and scrape the soil from the hot surface (as illustrated). Allow cooktop to cool, and use the same method for heavy or burned on soils.

CARE & CLEANING

Cooktop cleaning (cont'd)

WARNING

DO NOT use a cooktop cleaner on a hot cooktop. The fumes can be hazardous to your health and can chemically damage the ceramic glass surface.

Do not use the following on the cooktop:

- Do not use abrasive cleaners and scouring pads, such as metal and some nylon pads. They may scratch the cooktop, making it more difficult to clean.
- Do not use harsh cleaners, such as chlorine bleach, ammonia or oven cleaners, as they may etch or discolor the cooktop.
- Do not use dirty sponges, cloths or paper towels, as they can leave soil or lint on the cooktop which can burn and cause discoloration.



IMPORTANT

Damage to the ceramic glass cooktop may occur if you use an abrasive type cleaning pad. Only use cleaning products that have been specifically designed for ceramic glass cooktops.

Caution for aluminum use on the cooktop

- **Aluminum Foil** - Use of aluminum foil on a hot cooktop may damage the ceramic cooktop. Do not use thin aluminum cooking utensils or allow aluminum foil to touch the ceramic cooktop under ANY circumstances.

Replacing the oven interior light

CAUTION

Be sure the range is unplugged and all parts are **COOL** before replacing oven light. Wear a leather-faced glove for protection against possible broken glass.

The interior oven light bulb is located at the rear oven cavity and is covered with a glass shield. The glass shield must be in place whenever the oven is in use (See Fig. 1).

Replacing the oven interior light bulb:

1. Turn electrical power off at the main source or unplug the appliance.
2. Remove interior oven light shield (See Fig. 1).
3. Replace bulb with a new **T-4 type 40 Watt Halogen** appliance bulb. Please note: do not allow your fingers to touch the new bulb when replacing. This will shorten the life of the new bulb. Use a paper towel to cover the new bulb when installing.
4. Replace glass interior oven light shield.
5. Turn power back on again at the main source (or plug the appliance back in).
6. Be sure to reset the time of day on the clock.

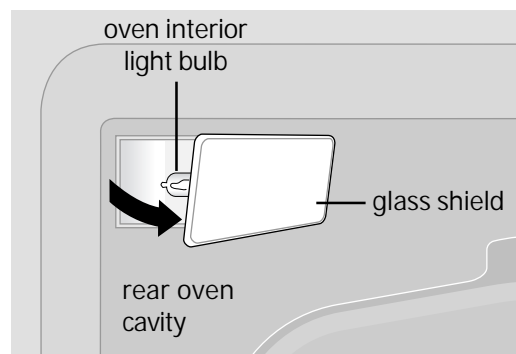

Fig. 1

Removing and replacing the oven door

CAUTION

The door is heavy. For safe, temporary storage, lay the door flat with the inside of the door facing down.

To remove oven door:

1. Open oven door completely (horizontal with floor - See Fig. 1).
2. Pull the door hinge locks on both left and right door hinges down from the oven frame completely towards the oven door (See Fig. 2). A tool such as a small flat-blade screwdriver may be required.
3. Firmly grasp both sides of oven door along the door sides (Do not use the oven door handle - See Fig. 3).
4. Close the door to the broil stop position (the oven door will stop into this position just before fully closing).
5. With the oven door in the broil stop position, lift the oven door hinge arms over the roller pins located on each side of the oven frame (See Fig. 4).

To replace oven door:

1. Firmly grasp both sides of oven door along the door sides (Do not use the oven door handle - See Fig. 3).
2. Holding the oven door at the same angle as the removal position, seat the hook of the hinge arm over the roller pins located on each side of the oven door frame (See Fig. 4). The hook of the hinge arms must be fully seated onto the roller pins.
3. Fully open the oven door (horizontal with floor - See Fig. 1).
4. Push the door hinge locks up towards and into the oven frame on both left and right oven door hinges (See Fig. 2) to the locked position.
5. Close the oven door.

Special door care instructions - Most oven doors contain glass that can break.

Read the following recommendations:

1. Do not close the oven door until all the oven racks are fully in place.
2. Do not hit the glass with pots, pans, or any other object.
3. Scratching, hitting, jarring or stressing the glass may weaken its structure causing an increased risk of breakage at a later time.

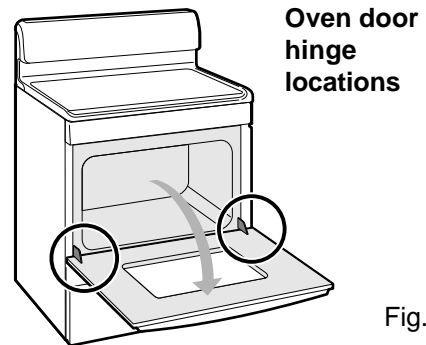

Fig. 1

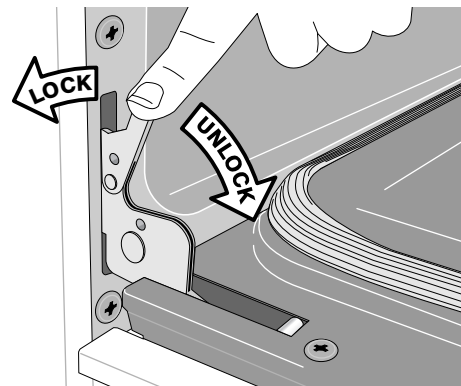

Fig. 2

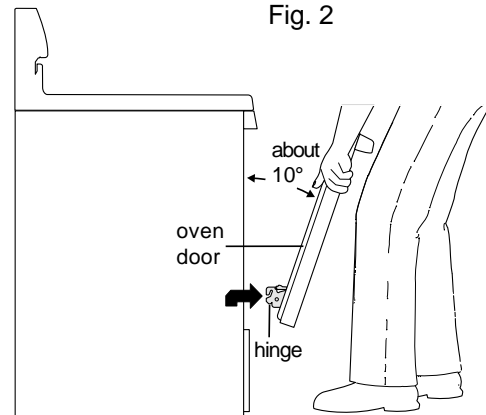

Fig. 3

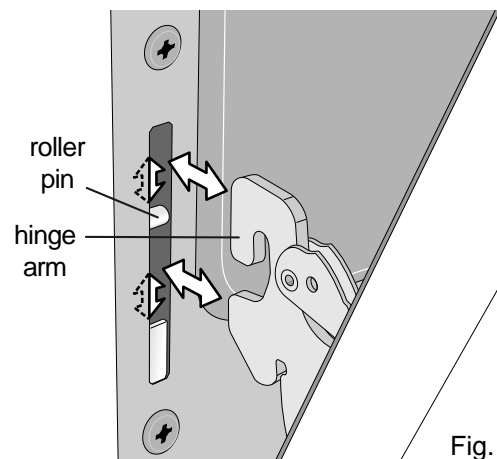

Fig. 4

BEFORE YOU CALL • Solutions to common problems

Problem	Solution
Poor baking results.	<ul style="list-style-type: none">• Many factors affect baking results. Make sure the proper oven rack position is used. Center food in the oven and space pans to allow air to circulate. Allow the oven to preheat to the set temperature before placing food in the oven. Try adjusting the recipe's recommended temperature or baking time. If you feel the oven is too hot or cool, see "Adjusting Oven Temperature" section in this Use & Care Guide.
Appliance is not level.	<ul style="list-style-type: none">• Be sure floor is level, strong & stable enough to adequately support range.• If floor is sagging or sloping, contact a carpenter to correct the situation.• Poor installation. Place oven rack in center of oven. Place a level on the oven rack. Adjust leveling legs at base of appliance until the rack is level.• Kitchen cabinet alignment may make range appear not level. Be sure cabinets are square & have sufficient room for appliance clearance.
Cannot move appliance easily. Appliance must be accessible for service.	<ul style="list-style-type: none">• Cabinets not square or are built in too tightly. Contact builder or installer to make appliance accessible.• Carpet interferes with appliance. Provide sufficient space so appliance can be lifted over carpet.
Surface cookware seems too hot or not hot enough.	<ul style="list-style-type: none">• Incorrect induction cooktop power level setting. Adjust power level setting higher or lower as needed.
Induction cooking zone does not heat cookware or does not heat evenly.	<ul style="list-style-type: none">• Be sure the correct surface control is activated for the cooking zone.• Be sure to use the correct cookware material type for induction cooking. Use cookware specifically identified by the manufacturer to use for induction cooking. If you're not sure, use a magnet to test whether the cookware type will work. If a magnet sticks to the bottom of the cookware, the material type is correct for induction cooking.• Be sure to read about pan-sensing in the Induction Cooking section and correct any pan-sensing issues in the checklist provided.• Use quality heavier gauge cookware.
Cooking zones do not glow when heating.	<ul style="list-style-type: none">• The induction cooking zones do not glow even when they are hot. Induction cooking uses electromagnetic energy to induce heat directly to the cookware.
Entire appliance does not operate.	<ul style="list-style-type: none">• The time of day is not set. The time of day must first be set in order to operate the oven. See "Setting the clock" in the Setting Oven Controls section.• Make sure cord/plug is plugged correctly into outlet.• Electrical power outage. Check house lights to be sure. Call your local electric company for service.• Service wiring is not complete. Contact your dealer, installing agent or authorized service agent.
Oven portion of appliance does not operate.	<ul style="list-style-type: none">• Be sure the oven controls are set properly for the desired cooking feature. See Setting Oven Controls in this manual or read the instructions "Entire appliance does not operate" in this checklist.

Problem	Solution
Oven light does not work.	<ul style="list-style-type: none"> • Be sure the light is secure in the socket. Also see "Changing & replacing the oven light" in the Care & Cleaning section.
Oven smokes excessively during broiling.	<ul style="list-style-type: none"> • Incorrect setting. Follow broiling instructions in Setting Oven Controls. • Make sure oven door is opened to broil stop position. • Meat too close to the broil element. Reposition the broil rack to provide proper clearance between the meat & the element. Preheat the broil element for searing. • Meat not properly prepared. Remove excess fat from meat. Cut remaining fatty edges to prevent curling, but do not cut into lean. • Broiler pan (on some models) insert wrong side up and grease not draining. Always place insert on the broiler pan with ribs up & slots down to allow grease to drip into pan. • Grease has built up on oven surfaces. Regular cleaning is necessary when broiling frequently. Old grease or food spatters cause excessive smoking.
Flames inside oven or smoking from oven vent.	<ul style="list-style-type: none"> • Excessive spillovers in oven. For example this will happen for pie spillovers or large amounts of grease left on the oven bottom. Wipe up excessive spillovers before starting oven. If flames or excessive smoke are present see "Broiling" in the Setting Oven Controls section.
Oven control beeps & displays any F or E error code message.	<ul style="list-style-type: none"> • Electronic control has detected a fault or error condition. Press CANCEL to clear the display and stop beeping. Try the selected feature again. If the E or F error code repeats, remove power from appliance, wait 5 minutes and then return power to appliance. Try the selected feature again. If the fault continues, record the fault or error code and call for service.
Self-cleaning cycle does not work.	<ul style="list-style-type: none"> • Oven control not set properly. Follow instructions under Self-cleaning.
Soil not completely removed after running self-cleaning cycle.	<ul style="list-style-type: none"> • Self-cleaning cycle was interrupted. Follow steps under "Stopping or interrupting a self-cleaning cycle" under Self-cleaning. • Excessive spillovers on oven bottom. Remove before starting self-clean. • Failure to clean bottom, front top of oven, frame of oven or door area outside oven seal. These areas are not in the self-cleaning area, but get hot enough to burn on residue. Clean these areas before the self-cleaning cycle is started. Burned-on residue can be cleaned with a stiff nylon brush and water or a nylon scrubber. Be careful not to damage the oven gasket.
Convection fan does not rotate.	<ul style="list-style-type: none"> • Oven door is open. Convection fan will turn off if oven door is opened when Convection is active. Close oven door.

BEFORE YOU CALL • Solutions to common problems

Problem	Solution
Scratches or abrasions on cooktop surface.	<ul style="list-style-type: none">• Coarse particles such as salt or sand between cooktop and utensils can cause scratches. Be sure cooktop surface and bottoms of utensils are clean before usage. Small scratches do not affect cooking and will become less visible with time.• Cleaning materials not recommended for ceramic-glass cooktop have been used. See "Cooktop cleaning and maintenance" in the Care and Cleaning section of this Use & Care Guide.• Cookware with rough bottom has been used. Use smooth, flat-bottomed cookware.
Metal marks on the cooktop.	<ul style="list-style-type: none">• Sliding or scraping of metal utensils on cooktop surface. Do not slide metal utensils on cooktop surface. Use a ceramic-glass cooktop cleaning creme to remove the marks. See "Cooktop Cleaning and Maintenance" in the Care and Cleaning section.
Brown streaks or specks on cooktop surface.	<ul style="list-style-type: none">• Boilovers are cooked onto surface. Use razor blade scraper to remove soil. See "Cooktop cleaning and maintenance" in the Care & Cleaning section.
Areas of discoloration with metallic sheen on cooktop surface.	<ul style="list-style-type: none">• Mineral deposits from water and food. Remove using a ceramic-glass cooktop cleaning creme. Use cookware with clean, dry bottoms.

MAJOR APPLIANCE WARRANTY

Your appliance is covered by a one year limited warranty. For one year from your original date of purchase, Electrolux will pay all costs for repairing or replacing any parts of this appliance that prove to be defective in materials or workmanship when such appliance is installed, used and maintained in accordance with the provided instructions.

Exclusions

This warranty does not cover the following:

1. Products with original serial numbers that have been removed, altered or cannot be readily determined.
2. Product that has been transferred from its original owner to another party or removed outside the USA or Canada.
3. Rust on the interior or exterior of the unit.
4. Products purchased "as-is" are not covered by this warranty.
5. Food loss due to any refrigerator or freezer failures.
6. Products used in a commercial setting.
7. Service calls which do not involve malfunction or defects in materials or workmanship, or for appliances not in ordinary household use or used other than in accordance with the provided instructions.
8. Service calls to correct the installation of your appliance or to instruct you how to use your appliance.
9. Expenses for making the appliance accessible for servicing, such as removal of trim, cupboards, shelves, etc., which are not a part of the appliance when it is shipped from the factory.
10. Service calls to repair or replace appliance light bulbs, air filters, water filters, other consumables, or knobs, handles, or other cosmetic parts.
11. Surcharges including, but not limited to, any after hour, weekend, or holiday service calls, tolls, ferry trip charges, or mileage expense for service calls to remote areas, including the state of Alaska.
12. Damages to the finish of appliance or home incurred during installation, including but not limited to floors, cabinets, walls, etc.
13. Damages caused by: services performed by unauthorized service companies; use of parts other than genuine Electrolux parts or parts obtained from persons other than authorized service companies; or external causes such as abuse, misuse, inadequate power supply, accidents, fires, or acts of God.

DISCLAIMER OF IMPLIED WARRANTIES; LIMITATION OF REMEDIES

CUSTOMER'S SOLE AND EXCLUSIVE REMEDY UNDER THIS LIMITED WARRANTY SHALL BE PRODUCT REPAIR OR REPLACEMENT AS PROVIDED HEREIN. CLAIMS BASED ON IMPLIED WARRANTIES, INCLUDING WARRANTIES OF MERCHANTABILITY OR FITNESS FOR A PARTICULAR PURPOSE, ARE LIMITED TO ONE YEAR OR THE SHORTEST PERIOD ALLOWED BY LAW, BUT NOT LESS THAN ONE YEAR. ELECTROLUX SHALL NOT BE LIABLE FOR CONSEQUENTIAL OR INCIDENTAL DAMAGES SUCH AS PROPERTY DAMAGE AND INCIDENTAL EXPENSES RESULTING FROM ANY BREACH OF THIS WRITTEN LIMITED WARRANTY OR ANY IMPLIED WARRANTY. SOME STATES AND PROVINCES DO NOT ALLOW THE EXCLUSION OR LIMITATION OF INCIDENTAL OR CONSEQUENTIAL DAMAGES, OR LIMITATIONS ON THE DURATION OF IMPLIED WARRANTIES, SO THESE LIMITATIONS OR EXCLUSIONS MAY NOT APPLY TO YOU. THIS WRITTEN WARRANTY GIVES YOU SPECIFIC LEGAL RIGHTS. YOU MAY ALSO HAVE OTHER RIGHTS THAT VARY FROM STATE TO STATE.

If You Need Service

Keep your receipt, delivery slip, or some other appropriate payment record to establish the warranty period should service be required. If service is performed, it is in your best interest to obtain and keep all receipts. Service under this warranty must be obtained by contacting Electrolux at the addresses or phone numbers below.

This warranty only applies in the USA and Canada. In the USA, your appliance is warranted by Electrolux Major Appliances North America, a division of Electrolux Home Products, Inc. In Canada, your appliance is warranted by Electrolux Canada Corp. Electrolux authorizes no person to change or add to any obligations under this warranty. Obligations for service and parts under this warranty must be performed by Electrolux or an authorized service company. Product features or specifications as described or illustrated are subject to change without notice.

USA
1.800.944.9044
Electrolux Home Products, Inc.
10200 David Taylor Drive
Charlotte, NC 28262



Canada
1.800.265.8352
Electrolux Canada Corp.
5855 Terry Fox Way
Mississauga, Ontario, Canada
L5V 3E4

Free Manuals Download Website

<http://myh66.com>

<http://usermanuals.us>

<http://www.somanuals.com>

<http://www.4manuals.cc>

<http://www.manual-lib.com>

<http://www.404manual.com>

<http://www.luxmanual.com>

<http://aubethermostatmanual.com>

Golf course search by state

<http://golfingnear.com>

Email search by domain

<http://emailbydomain.com>

Auto manuals search

<http://auto.somanuals.com>

TV manuals search

<http://tv.somanuals.com>